

THE MECHANICAL DESIGN OF A GAS SUPPLY AND MIXING SYSTEM FOR THE AMS-02 PARTICLE DETECTOR ONBOARD THE INTERNATIONAL SPACE STATION

C.Gargiulo⁽¹⁾, R.Becker⁽²⁾, A.Agneni⁽³⁾,M.Borghini⁽³⁾
on behalf of AMS-02 TRD group

⁽¹⁾ INFN Sezione di Roma 1, Dipartimento di Fisica Università di Roma “La Sapienza”
P.le Aldo Moro, 2 – 00185 Rome (Italy)
Corrado.Gargiulo@roma1.infn.it

⁽²⁾ MIT /CERN Geneva, Switzerland
CERN, CH-1211 Geneva 23 (Switzerland)
Robert.Becker@cern.ch

⁽³⁾ Aerospace and Astronautic Department, Università di Roma “La Sapienza”
Via Eudossiana 16, 00184 Rome Italy
Alessandro.Agneni@uniroma1.it

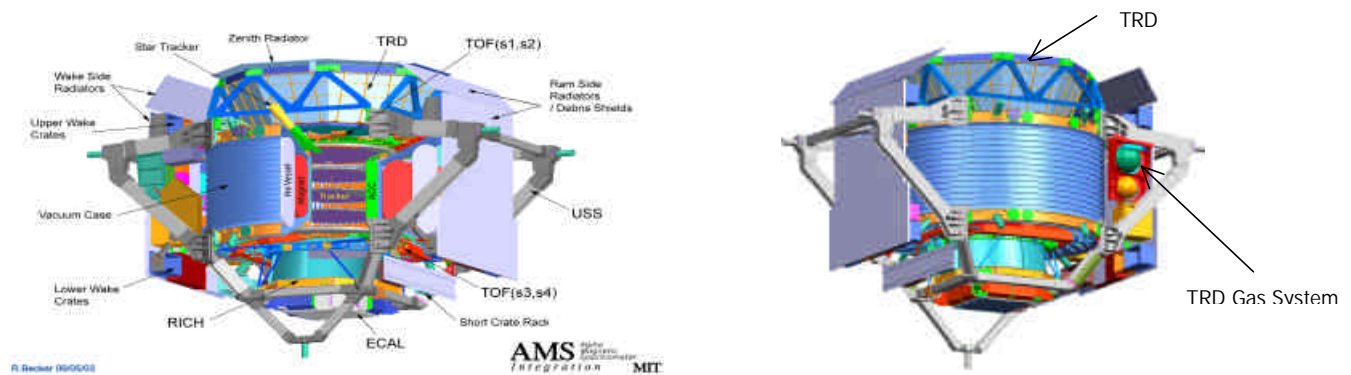

Fig. 1 Alpha Magnetic Spectrometer 02

ABSTRACT

The Alpha Magnetic Spectrometer 02 (AMS_02) (fig.1) is a particle physics experiment that will search for antimatter, dark matter, and measure cosmic rays in space aboard the International space station for 3 years. It is comprised of an array of sub-detectors: Transition Radiation Detector (TRD); Time of Flight detector (TOF); Anti-Coincidence Counter (ACC); Silicon Tracker (TR); Ring Imaging Cherenkov counter (RICH); Electromagnetic Calorimeter (E-Cal) and requires the operation of a cryogenic super conducting magnet at it's core. It is built by an international collaboration of more than 100 scientists spread all over Europe, USA and far East. The TRD that is located above the Cryomagnet and Upper Time of

Flight, consists of several layers of straw modules interleaved with a fiber fleece material and arranged in a conical octagon structure built out of a carbon fiber/aluminum honeycomb sandwich. A charged particle traversing this detector produces characteristic electromagnetic radiation in each layer that is measured in the gas filled array of straw tubes. From this the mass and momentum of the particle can be measured provided the tubes are filled with the proper gas mixture. The TRD gas supply stores 50 kg of gas corresponding to 8100 liters Xe and 2000 liters CO₂ at 1 atm, filters ,mixes, recirculates, and purges a daily supply of Xe/CO₂ (80%/20%) gaseous mixture, thus supplying the TRD with clean, mixed gas for the 3 year ISS mission. Designing and building this

reliable, weight optimised system to withstand launch loads and the harsh space environment presented a formidable engineering challenge. Adding to the complexity of the system was that a flexible valve/pump arrangement was needed to control mixture ratio, circulation flow and pressure, and purging. These studies are presented in the paper.

INTRODUCTION

The TRD Gas system performs the following functions: stores sufficient gas for the 3-5 year AMS-02 mission with a safety margin of four; transfers new gas to the TRD each day; circulates the gas and monitors the gas content continuously (fig.2) [1]. Two storage vessels store the xenon and carbon-dioxide separately in Box S. Two mixing circuits convey the gases to the mixing vessel where the 4:1 (Xe:CO₂) mixture is made. A system of valves then allows the transfer of the gas from the mixing vessel to Box C. At all points, the valves have a two fold redundancy. Leak-

before-burst vessels ensure safety in the event of high temperatures causing over pressure in the vessels during a time when gas cannot be vented, such as when the system has no electrical power. In Box C two pumps circulate the gas through the TRD volume in order to keep the gas mixed and allow the CO₂ sensor and gain monitor tubes to assess the properties of the gas. The pumps and CO₂ sensor are mounted inside a gas tight vessel; in the event of a pump or valve failure, pressure integrity of the system will not be lost. Each manifold segment in the TRD has two valves and one pressure sensor at each end. The valves allow the isolation of TRD segment in case a leak occurs and the pressure sensors allow detection of leaks. All valves are computer controlled. If there is a large pressure drop in Box C, all valves are closed by the gas system electronics, even if the computer is not running. The gas systems is controlled via the TRD gas system electronics crate. [2].

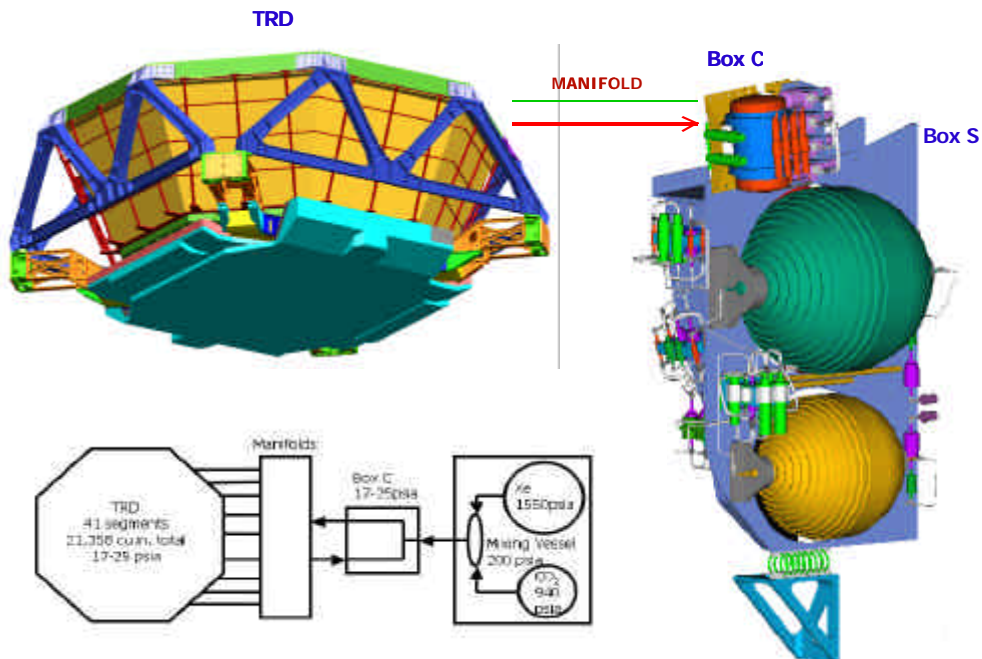

Fig. 2 Transition Radiation Detector Gas Supply and mixing System lay out

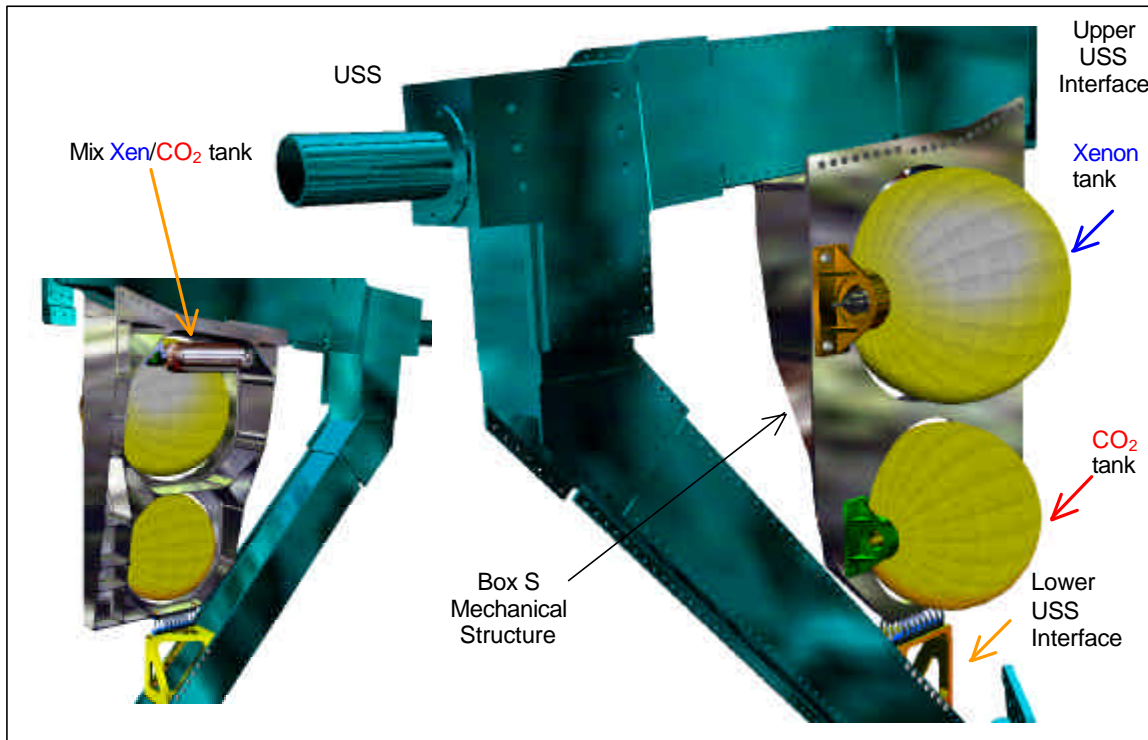

Fig.3 TRD Gas Supply System Mechanical Structure attached to the AMS02 Unique Support Structure (USS)

MECHANICAL STRUCTURE →

Box S mechanical structure's purpose is to position and support the main components of the TRD Gas Supply System in AMS_02 [3] that consists of two large spherical Xenon and CO₂ tanks, a small cylindrical Mixing tank and valves, filters, temperature and pressure sensor, which constitute the gas circuit. The structure is supported by the AMS_02 Unique Support Structure (USS) (fig.3).

Tanks

Xenon and CO₂ tanks are spherical composite wound metal shells, roughly 15 and 12 inches in diameter weighing about sixteen and nine pounds. The tanks, designed and built by Arde Inc, are sized to hold 109 pounds of Xenon and 18 pounds of CO₂ respectively. The tanks are fixed to Box_S via a polar mounting; they are supported by bosses cradled in brackets on both ends. One of the bosses is completely restrained and the other

is allowed freedom to slide axially, allowing the tank to expand thermally and avoiding introduction of radial loads (fig.4).

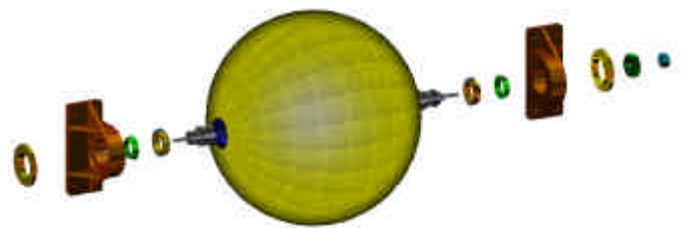

Fig.4 Gas Tank and support brackets

Support Plate

The box's main support structure is a light and stiff plate manufactured by milling from a single wrought Al alloy block. The selected material is the wrought aluminum-based zinc-copper-magnesium-content alloy with ANSI designation 7050 T7451 (fig.5).

The Plate's tank mounting side is planar and has two large holes cut into it that house the Xe and CO₂ tanks.

The ribs behind the front planar face stiffen the structure; they start from 149mm depth at the top and taper down to 45mm at the bottom. The rib-reinforcement, designed as a symmetrical frame about the centreline from Xe to CO₂ tanks axis, produce at one side an additional ribbed region needed to support local loads for the main (hard mounted) tanks brackets. Front plate thickness is 6mm while rib thickness varies from 3 to 5mm.

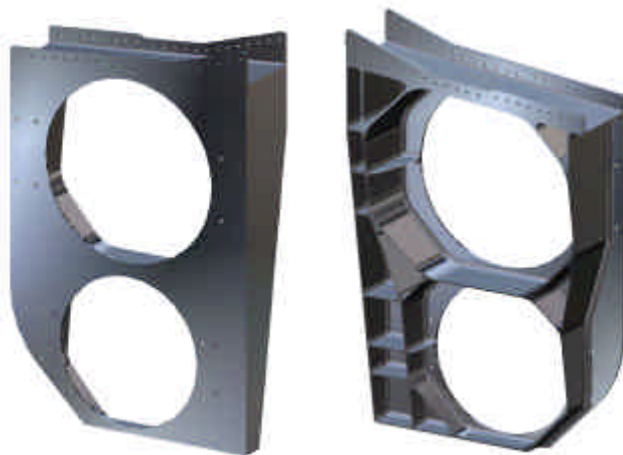

Fig. 5 Box S support plate

Structure attachment points

The TRD gas system is supported by the AMS Unique Support Structure (USS) [4]. During launch large relative displacements between upper and lower USS attachment points for the gas system are predicted to occur due to inertial load. These displacement does not allow a rigid connection at both interfaces without causing a load transfer from the USS to the Box structure. Therefore the design provides a rigid bolted connection at the top and a flexible mount at the bottom. The bottom support has to allow for the large displacements but still contributes stiffening and damping the system.

The structure supported only by the upper beam, must satisfy the structural requirements; the additional support at the bottom has to be seen as an additional fail-safe structure.

The Upper Interface (fig.6) with the USS is the U-shape found at the top of the Box that fits outside the USS upper trunnion bridge and

bolts to the USS's standard hole pattern on the lower side of the trunnion bridge.

The U-channel width and shape are machined to fit the USS while also allowing installation and USS machining tolerances. Peel-shims are foreseen to fill the over tolerances.

The hole pattern in the USS is copied both at the front and at the back of the Box resulting in a 21, ¼ inch, screws per side that produce the mechanical connection.

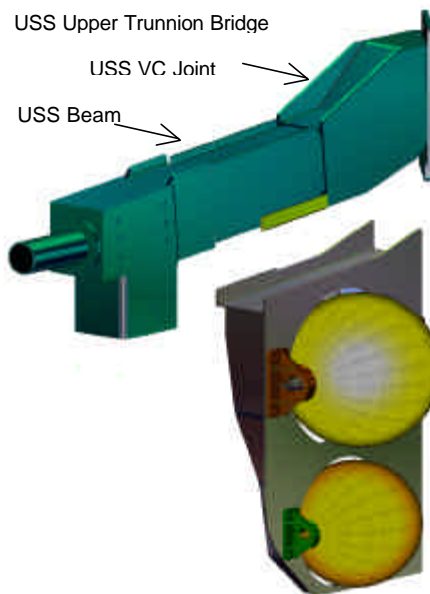

Fig.6 Box S upper attachment to USS

The Lower Interface with USS (fig.7) consists in a flexible mount. An helicoidal stainless steel spring is attached from one side to the box's main plate and from the other side to a USS hard-mounted triangular aluminum bracket.

The spring allows for large deformation relative to its size, and introduces viscous damping by the wires strands.

The spring consists in a wire cable wounded and fixed in two opposite bars. Cable and bars are stainless steel 304.

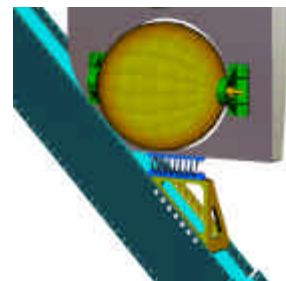

Fig. 7 Box S lower attachment to USS

STRUCTURAL ANALYSIS

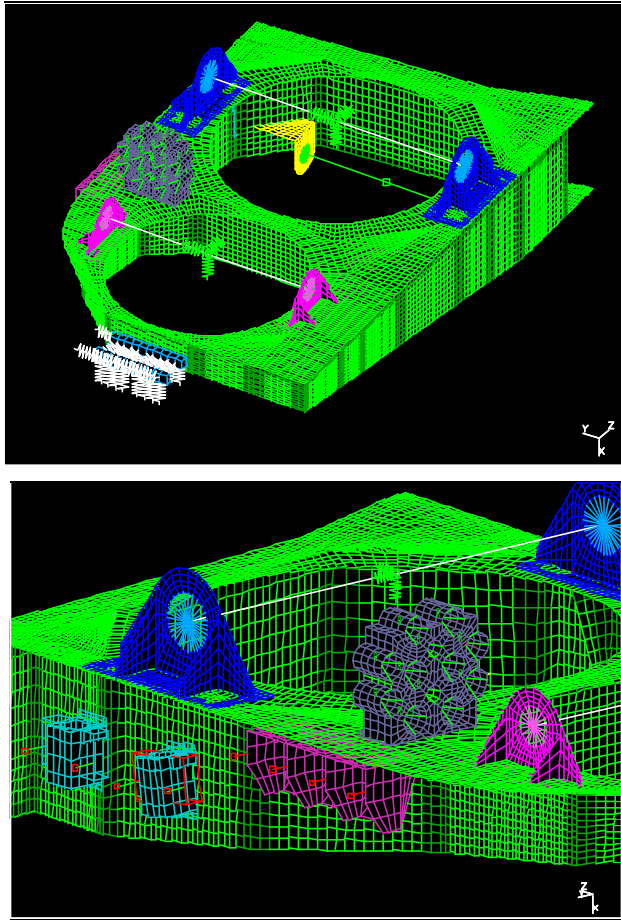

Fig. 8 Box_S: Finite Element mesh

A Finite Element Analysis was performed to predict Box_S static behavior in term of displacement, stresses and reactions at structures interfaces under critical load conditions that primarily occur during launch and landing. Margin of Safety have been evaluated for all the structures.

A fail-safe analysis at the upper and lower USS-02 interface with the highest loaded fasteners removed has been performed and all Margin of Safety recalculated.

A modal analysis was carried out to verify that the first significant structure natural frequency is above 50 Hertz [3].

Finite element model

Box_S is completely mapped meshed (fig.8). Plate is modeled with shell elements Mindlin theory based.

The helicodal spring at the lower attachment points is modeled by two linear beams simulating the two bars and by eight rigid bars with extreme nodes coupled to beams nodes by rotational and translational spring simulating the spring coils.

Tanks are modeled as lumped mass in their center of mass and are connected to the brackets by rigid bars whose extreme nodes are properly coupled with bracket bearing node. Model assumptions are based on hypothesis that, during critical load phases, Xenon is single phase and incompressible. The fluid is assumed single phase (above 47F) at launch and therefore doesn't slosh [5]. Launch significant loads where assumed to occur at Space Shuttle Cargo bay (temperature control around 70F to 85F) with Xenon occupying the entire tank volume.

Single phase Xenon supports acoustic modes. From previous analysis [5] it is known that only first diametral mode is expected to interact significantly with the structure. Predicted natural frequency of Xe at 70F is 424Hz.

But tank+brackets natural frequencies are significantly lower [6] and mounting the bracket on Box_S reduces this frequency even more due to flexibility of the Box. So Xenon appear fair stiff relative to the tank. Based on that, the incompressible Xenon assumption is quite accurate.

The same simple assumptions where made in analysis of the CO₂ tank, in this case two phase conditions only occurs during discharge of CO₂ that doesn't occur during launch [7].

Type of element used

I-deas: 94 thin shell, 161 lumped mass, 121 rigid bar, 23 rigid element, 2 linear beam

Applied units

Length [mm], Mass [g], Force [N].

Type of material used

Plate, Lower bracket, Mixing tank brackets

Al Alloy 7050 T7451

$\rho=0.0028 \text{ g/mm}^3$, $E = 71000 \text{ N/mm}^2$, $\nu= 0.33$

$F_{ty}= 386.1 \text{ N/mm}^2$, $F_{tu}=455 \text{ N/mm}^2$, $S_u= 303.4 \text{ N/mm}^2$

Xen and CO2 brackets

Al Alloy 6061 T6

$\rho=0.0027 \text{ g/mm}^3$, $E = 73000 \text{ N/mm}^2$, $\nu= 0.33$
 $F_{ty}=240 \text{ N/mm}^2$, $F_{tu}= 290 \text{ N/mm}^2$, $S_u= 186 \text{ N/mm}^2$

Helicoidal spring

Stainless steel 316

$\rho=0.0081 \text{ g/mm}^3$, $E = 193000 \text{ N/mm}^2$, $\nu= 0.29$
 $F_{ty}=240 \text{ N/mm}^2$, $F_{tu}= 550 \text{ N/mm}^2$, $S_u= 340 \text{ N/mm}^2$

Constraints:

Screws connecting Box and USS are modeled constraining translations and rotations at corresponding nodes.

Screws connecting the tanks brackets to the plate are modeled by coupling the node Degree Of Freedom (DOF) of the different parts at screws location.

At the tank main supporting bracket all translations and the rotation relative to the tanks polar axis are coupled with the bracket central node that simulate the bearing (X, Y, Z translational and Y rotational DOF coupled, X and Z rotational DOF free).

At the other boss of the tanks, only translations normal to the polar axis are coupled to bracket bearing node (X, Z translational DOF coupled, all the other DOF are free).

Loads:

The load cases considered are the Box_S mass subjected to an acceleration vector and combined with imposed relative deflection between attachment points.

Acceleration imposed:

$\pm 13g$ in one direction with $\pm 3,25g$ simultaneously applied in the other two[8]; different load cases were considered by sweeping the direction of the acceleration vector.

Displacement imposed:

(9.301; 2.350; 2.746) mm imposed at lower attachment points with USS[8].

STRUCTURE PREDICTED NUMERICAL BEHAVIOUR

Box_S predicted static behavior satisfies NASA safety requirements[8]: all margin of safety are positive.

The calculated stress levels and displacement under different load cases are summarized in tab.1. Yield and Ultimate Margins of Safety (MS) are listed in the same table.

$$MS_{yield} = \frac{Yield\ Stress}{FS_y \times Limit\ Stress(Von\ Mises)} - 1$$

$$MS_{ult} = \frac{Ultimate\ Stress}{FS_{ult} \times Limit\ Stress(Max\ Principal)} - 1$$

with $FS = Factor\ of\ Safety$

$$FS_y = 1.25 \quad FS_{ult} = 2 \text{ for static}$$

$$FS_y = 1 \quad FS_{ult} = 1 \text{ for fail safe}$$

The reaction forces at the location of the bolts fixing tank brackets to Box and Box to USS have been computed by modeling each bolts with one node at its location.

Static and Fail Safe Analysis:

Maximum stresses, largest displacements and highest reactions values occur at different locations under different load cases (fig 9-11). Plate and Xenon tank main brackets are the structures most stressed and in which largest displacements occur.

Load cases (± 13 , ± 3.25 , ± 3.25)g + imposed displacement (9.301, 2.350, 2.746)mm

When the main acceleration component (13g) is normal to the plate in the x positive or negative direction, Xe and CO₂ tank mass inertial action produces a plate bending with maximum sag at the bottom. The sag, according to the direction of the acceleration, reaches its maximum value for x negative acceleration (-13g) when displacement at the bottom rises to 1.45mm (fig.9).

Stress concentration (157 N/mm^2) is localized at one side of the back reinforcement close to the back plate that connects the box to the USS upper trunnion bridge (fig.10, tab.1).

Largest reactions occur at the side bolts in the upper interface at the back of the U-channel. The further analysis performed by removing these fasteners and recalculating reactions distribution at bolts confirm the fail safe design.

A positive effect of the spring at the bottom is observed when acceleration is in the positive direction (same direction of imposed displacement) when a portion of the bending moment is opposed by the spring; this results in a reduction of reactions intensity at upper bolts location.

Load cases (± 3.25 , ± 13 , ± 3.25) g + imposed displacement (9.301, 2.350, 2.746)mm

When acceleration is mainly in the tanks polar axis direction, y positive or negative, the Xe tank main bracket is the most loaded. It is there that maximum displacements are predicted (0.774mm for +13g, 0.930mm for -13g) while maximum stress value occurs at the plate in the underlying area (Von Mises=149N/mm² for +13g; MaxPrincipal=216N/mm², for -13g) (fig.11, tab1).

Largest reactions occurs both at bolts fixing the main support for the Xe-tank to the Plate and at the upper Interface of the plate to USS (+3.25,+13,+3.25). Fail Safe analysis developed at both locations, USS upper interface and Xe tank bracket give positive margin of safety.

Load cases (± 3.25 , ± 3.25 , ± 13) g + imposed displacement (9.301, 2.350, 2.746)mm

Acceleration main component in z direction has the minor impact on the structure in term of stress and displacement (tab.1).

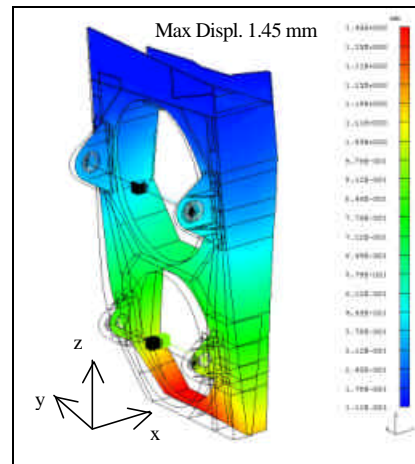

Fig. 9 Box_S: Displacement Load Case (-13, -3.25, -3.25)g

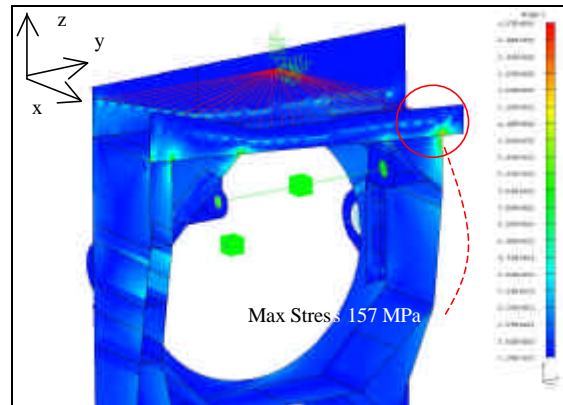

Fig. 10 Box_S: Stress Load Case (-13, -3.25, -3.25)g

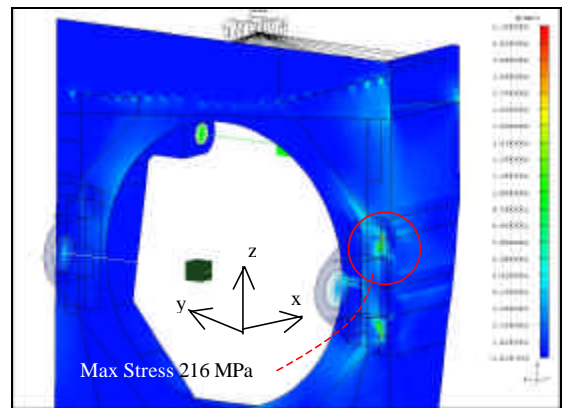

Fig. 11 Box_S: Stress Load Case (-3.25, -13, -3.25)g

LOADS:			BOX S PLATE				
Acceleration (g)			Limit Stress [N/mm ²]		Max Displacement [mm]	Margin of Safety	
x	y	z	Von Mises	Max Principal		Yield	Ultimate
13	3,25	3,25	132	142	0.755	1.34	0.60
3,25	13	3,25	149	122	0.618	1.07	0.86
3,25	3,25	13	91	98	0.360	2.39	1.31
-13	-3,25	-3,25	157	140	1.450	0.97	0.63
-3,25	-13	-3,25	189	216	1.100	0.63	0.05
-3,25	-3,25	-13	87	101	0.574	2.55	1.25

Tab. 1 Box_S: Stressess, Displacements and Margins of Safety

Modal Analysis:

For the Modal Analysis a normal mode dynamics Lanczos Method was applied. Plate design was optimized to rise first frequency over the limit of 50 Hz.

The first mode of the final design plate is predicted to occur at 70.8 Hz with a bending modal shape in the x direction, normal to the plane of the plate and associated to the boundary conditions that foresee the bolted hard mounting at the top and the spring flexible fixation at the bottom (fig.12).

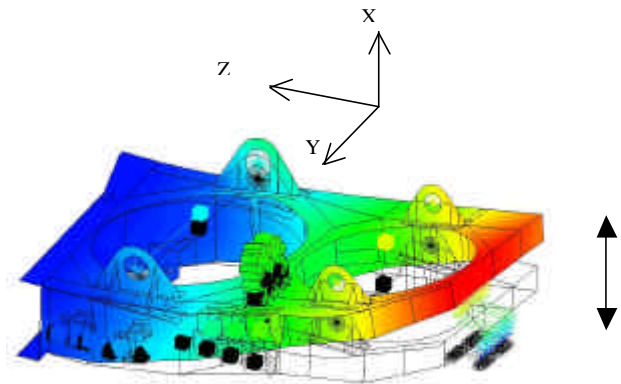

Fig. 12 1st Numerical Mode 70.8 Hz

Second modal shape is an in plane bending, y direction, associated to Xe tank mass participation (fig.13)

For each mode normalized masses (participating mass/total mass) are listed in tab.2.

First mode predicted natural frequency satisfies structural safety requirements [8]:
(1st mode > 50Hz)

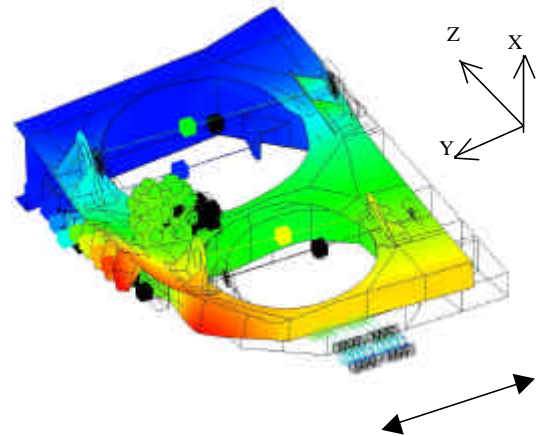

Fig. 13 2nd Numerical Mode 81.4Hz

Mode	Frequency (Hz)	Normalized effective mass		
		x	y	z
1	70.8	0.33178	0.15044	0.02436
2	81.4	0.06829	0.67623	0.006241

Tab.2 Numerical first two natural frequencies

**STRUCTURE EXPERIMENTAL
DYNAMIC BEHAVIOUR**

A vibrational test was performed on the protoflight hardware of Box_S (fig.14).

The aim of the test is to verify its ability to survive the lift off and landing and to provide a final workmanship vibration test [9].

Test procedure

A random test at workmanship level (tab.3) was performed on each of the three orthogonal directions.

All Axes	20 Hz	0.01g ² /Hz
	20-80Hz	+3dB/Octave
	80-500Hz	0.04g ² /Hz
	500-2000Hz	-3dB/Octave
	2000Hz	0.01g ² /Hz
	Overall=	6.8Gms

Tab.3 (MWL Test Duration: 60 seconds per axis)

Before and after each random a sine sweep (0.25 G from 10-300 Hz, scan rate= 2 oct/min) was applied to verify system natural frequencies and system structural consistence. Sine sweep test.

Test was performed on the shaker Unholtz Dickie T4000 at ENEA Casaccia –Roma in the period 10-20 March 2003.

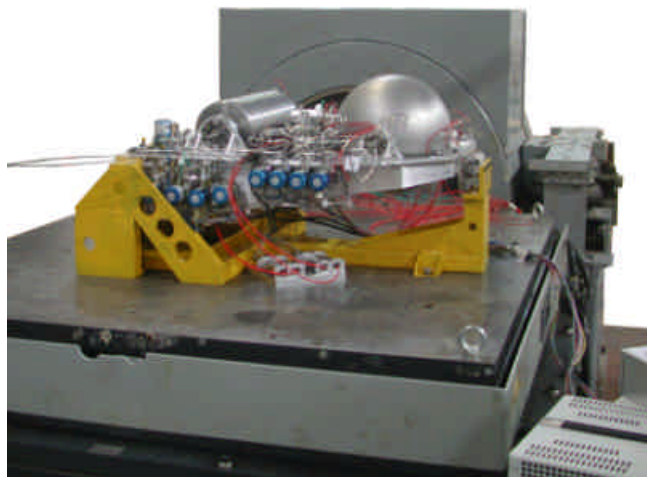

Fig. 14 Box_S proto-flight hardware: Dynamic Test

The test validated the design of the support mechanical hardware and the functionality of the gas circuit and valves. The actual dynamical environment for the tanks was evaluated. The FE model and calculation were validated by experimental results.

Test procedure

The test article is the prototype of Box_S of the TRD Gas Supply System. It consists of a gas circuit composed by two large spherical Xenon and CO₂ tanks, a small cylindrical Mixing tank and valves, filters, temperature and pressure sensors assembled on the aluminium support plate.

Total mass: 90kg

Overall dimension: 560x863x450mm³

Boundary conditions: test fixture that simulates the actual mounting to AMS Unique Support Structure (weight 95kg).

CO2 tank

tank weight 1,85 kg
filled with 4.5kg Isopropyl alcohol

Xe mass simulator
weight 57,4 kg

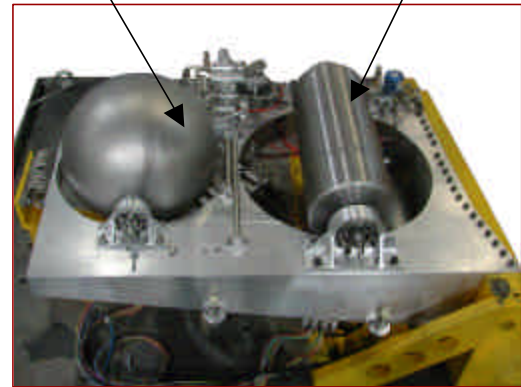

Fig. 15 Box_S Proto-flight mass simulators

A devoted test fixture that reproduce Box_S versus USS interface was developed to fix the test article to the shaker. The same fixture was used for both shaker armature (test in x axis) and slip table (y and z axis) configurations. A survey of the test fixture/exciter combination was performed to evaluate the fixture dynamics and the choice of the control strategy and control accelerometers location.

Test Fixture:

A complete numerical and experimental characterization of the fixture was developed.

At the fixture main beam where is Box_S/ USS primary attachment interface the fundamental frequency of the fixture experimentally appreciated is 520Hz in the slip table configuration.

When fixed to the shaker armature, due to the different boundary conditions, fixture main

beam has a first flexion-torsional mode with a low amplification at 236Hz followed by a relevant amplification at 571 Hz.

Accelerometers:

A total number of 30 channels were used to monitor the test. The test control method applied was “1-point control” according to test fixture dynamic characterization; the control point equipped with a triaxial accelerometer is located in the back-center of the fixture main beam. Meaningful points were monitored by triaxial accelerometers on the plate (B, C and D). and on the main brackets of the two tanks (E and F) (fig.16).

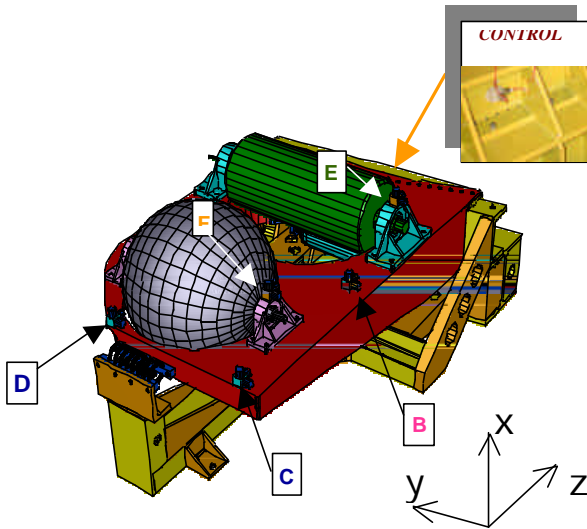

Fig. 16 Accelerometers locations

Sine sweep

Sine sweep response in X direction has a peak at 70 Hz that reveals the structure first natural frequency associated with a bending mode shape normal to the plane of the plate (fig.17). The second peak higher than 80Hz is clearly associated to the second mode, in plane bending. The evidence of the second mode is given by the sine sweep in y direction where the first peak recorded is at 85.45 Hz (fig.18). Structural experimental response is in good agreement with FE simulation :

- 1st frequency: 70.8Hz numerical/70 Hz experimental
 - 2nd frequency: 81.4Hz numerical/85.4Hz experimental
- Test results confirm that Box_S first frequency is above 50 Hz.

Sine sweep after random shows no change when compared to the first sine sweep, this confirms structure consistence (fig.19).

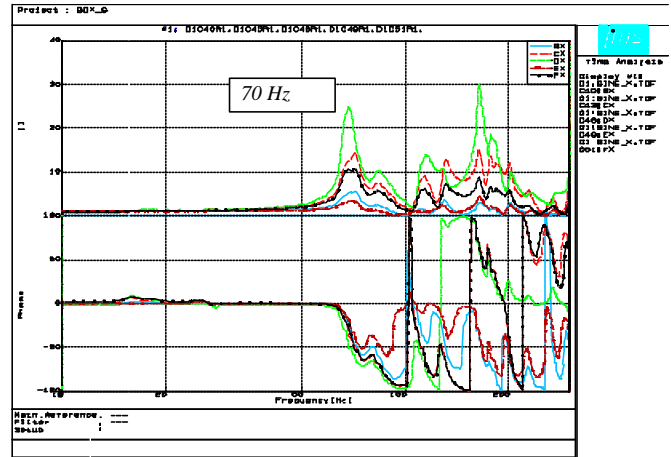

Fig.17 Sine sweep X direction inline response at B,C,D,E,F: First peak 70 Hz

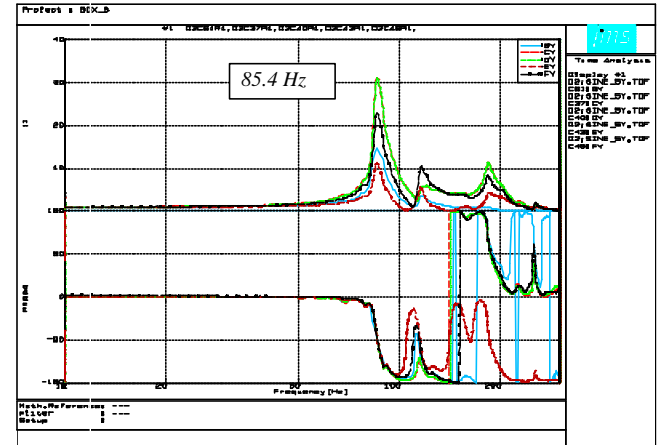

Fig. 18 Sine sweep Y direction inline response at B,C,D,E,F: First peak 85.45 Hz

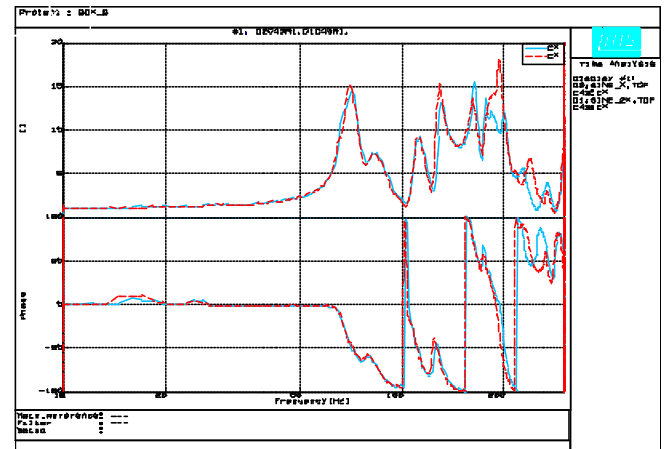

Fig.19 Sine sweep before and after random (Channel Cx for x excitation)

Random

All components of the TRD Gas System endure the dynamical environment (fig.20).

No evidence of structural compliance or damage was revealed.

Dynamical environment at tank brackets is acceptable.

The level at Xenon tank main bracket is within the qualification spectrum applied to the base of the brackets used to qualify the AMS Xenon tank [6].

For the the CO₂ tank the plate resonance amplification is in a frequency domain where the response of the tank is near rigid body; this mean that the amplified input of the platform will not feed the resonance of the tank [7].

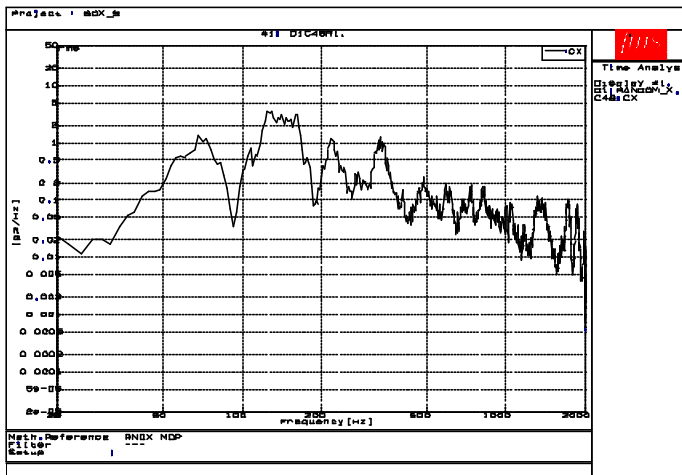

Fig. 20 Random X excitation (Channel Cx)

Functionality test

A functional test on the gas circuit before and after every random was performed by pressurizing the system and by operating valves. Test showed that system functionality is not affected by the dynamic environment.

REFERENCES

1. U.Becker, J Burger , P.Fisher, “TRD Gas System Summary and Specifications”, *AMS NASA Critical Design Review Document* April 2003.

2. A.Bartoloni, B.Borgia, S.Gentile, “Transition Radiation Detector Gas Slow Control System, AMS_02, trd note v123, December 2002.

3. C. Gargiulo, R. Becker, “Box_S Mechanical Structure, AMS_02”, *AMS NASA Critical Design Review Document*, Nov. 2002

4. Martin T.D., “Alpha Magnetic Spectrometer_02 Experiment/Payload Integration Hardware (PIH) Interfaces”, NASA Space and Life Sciences Directorate Flight Project Division, December 2001-RevB

5. R.Szabo, “ISS PCU Xenon Tank Damping and Fluid-Structure interaction. Boeing Document EID-02322-1

6. A.Escalona, K.Sneddon, “Qualification by similarity report of Sphere, Xenon Storage filament wound PN-D4815 to PN-D4636 for TRD Gas Supply System.

7. A.Escalona, K.Sneddon, “Qualification by similarity report of Sphere, CO2 Storage filament wound PN-D4816 to PN-D4683 for TRD Gas Supply System.

8. Martin T.D., “Alpha Magnetic Spectrometer_02 Structural Verification Plan for the Space Transportation System and International Space Station”, JSC-28792 Rev.B, NASA Space and Life Sciences Directorate Flight Project Division, December 2001-RevB

9. C. Gargiulo, “Box S Dynamic Test, AMS_02”, *AMS NASA Critical Design Review Document*, May 2003.