



Performance of the CHORUS lead-scintillating fiber calorimeter

S. Buontempo^a, A. Capone^b, A. G. Cocco^a, D. Depedis^b, E. Di Capua^c, U. Dore^b, A. Ereditato^a, M. Ferroni^c, G. Fiorillo^a, F. Garufi^a, P. F. Loverre^b, C. Luppi^c, D. Macina^{b,*}, F. Marchetti-Stasi^{a,†}, M. A. Mazzoni^b, M. Messina^a, P. Migliozi^a, V. Palladino^a, G. Piredda^b, S. Ricciardi^c, P. Righini^{b,‡}, B. Saitta^{c,‡}, R. Santacesaria^b, P. Strolin^a and P. Zucchelli^{c,*}

^aUniversità "Federico II" and INFN Sezione di Napoli, Italy

^bUniversità "La Sapienza" and INFN Sezione di Roma, Italy

^cUniversità di Ferrara and INFN Sezione di Ferrara, Italy

We report on the design and performance of the lead-scintillating fiber calorimeter of the CHORUS experiment, which searches for ν_μ - ν_τ oscillations in the CERN Wide Band Neutrino beam. Two of the three sectors in which the calorimeter is divided are made of lead and plastic scintillating fibers, and they represent the first large scale application of this technique for combined electromagnetic and hadronic calorimetry. The third sector is built using the sandwich technique with lead plates and scintillator strips and acts as a tail catcher for the hadronic energy flow. From tests performed at the CERN SPS and PS an energy resolution of $\sigma(E)/E = (32.3 \pm 2.4)\%/\sqrt{E(\text{GeV})} + (1.4 \pm 0.7)\%$ was measured for pions, and $\sigma(E)/E = (13.8 \pm 0.9)\%/\sqrt{E(\text{GeV})} + (-0.2 \pm 0.4)\%$ for electrons.

1. Introduction

The CHORUS experiment [1] searches for ν_μ - ν_τ oscillations in the CERN SPS Wide Band Neutrino Beam. The appearance of a ν_τ in the ν_μ beam is observed through its charged current interaction. Due to the short lifetime of the τ lepton produced in this process, it is necessary to use nuclear emulsions for the detection of its decay. The events to be scanned in the emulsions are selected from a large background of ordinary ν_μ interactions by means of kinematical cuts. The energy and the direction of the hadronic shower are measured using a high resolution calorimeter to get an optimal cut efficiency. It is also necessary to track the muons produced in ν_μ interactions or in τ decays through the calorimeter to match the measurement performed in the downstream spectrometer with one of the tracks observed in the emulsions.

A more detailed description of the design and

construction of the calorimeter for the CHORUS experiment can be found in Ref. [2]. In this paper, we simply outline the main design feature, and present experimental results obtained exposing the calorimeter to electron and pion beams of the CERN SPS and PS.

2. Calorimeter design

The calorimeter is arranged in planes of modules orthogonal to the direction of the neutrino beam (Fig. 1), so that the tracking of muons is possible. This is the main difference with respect to the original SPACAL geometry [3], where the modules have fibers parallel to the beam direction, and the signals are collected at the back of the calorimeter.

The calorimeter consists of three sectors with decreasing granularity (EM, HAD1 and HAD2). The electromagnetic component of the shower is almost fully absorbed in the first sector, while the other two complete the measurement of the hadron showers. The average interaction length of the calorimeter is 21 cm, its radiation length 0.72 cm. The total calorimeter thickness is 5.2

*Now at CERN, Geneva, Switzerland.

†Corresponding author.

‡Now at Università di Cagliari and INFN Sezione di Cagliari, Italy.

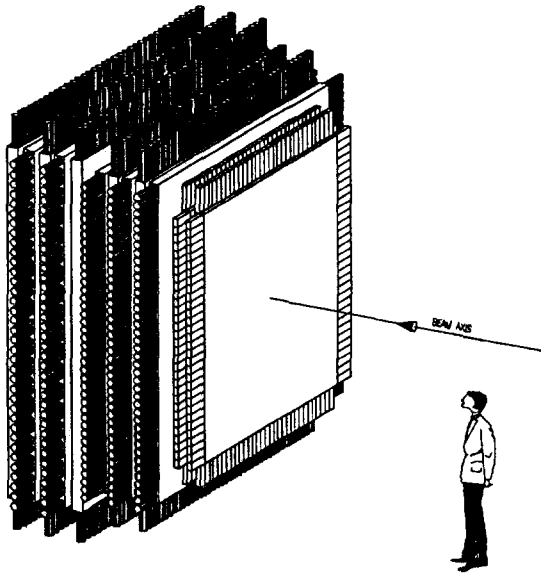

Figure 1. View of the calorimeter.

interaction lengths, which is enough to contain showers produced in the neutrino interactions, characterized by low energy (~ 5 GeV) hadrons. The EM and the HAD1 sectors (2.8 interaction lengths altogether) are made of scintillating fibers and lead, while HAD2 is a sandwich of lead and scintillating strips. The scintillation light is collected through photomultipliers (PMs) on both sides of the module, thus reducing the effects of light attenuation in the scintillator [2]. Planes of limited streamer tube are inserted between the calorimeter planes for tracking purposes; they are arranged in pairs with horizontal and vertical wires.

EM modules are built by piling-up extruded layers of grooved lead and plastic scintillating fibers positioned in the grooves. The groove diameter is 1.1 mm and the layer thickness 1.9 mm; the material, the same as for the HAD1 and HAD2 modules, is 99% lead and 1% antimony. A module consists of a pile of 21 layers, 2620 mm long and 82.4 mm wide, and 740 fibers of 1 mm

diameter and 3050 mm long. On each side of the module, fibers are assembled in two hexagonal bundles, defining two different read-out cells with about 40×40 mm² cross-section. Each of the fiber bundles is coupled to a 1" PM via a plexiglas light guide.

HAD1 modules are made of 43 extruded layers of lead the same width and groove size as those used for the EM sector, but with a length of 3350 mm. The scintillating fibers have 1 mm diameter and 3810 mm length, for a total of 1554 fibers per module. Fibers are collected at both ends in a hexagonal bundle coupled via a light guide to a 2" PM.

HAD2 modules are constructed by superposing five alternate layers of one lead bar ($3690 \times 200 \times 16$ mm³) and two adjacent scintillator strips ($3714 \times 100 \times 4$ mm³ each). Each of the two groups of five scintillators is coupled to 2" PMs at both ends via plexiglas light guides; therefore, a single module is seen by a total of four PM tubes, and contains two cells.

3. Test beam data and calibration

The main measurements with electron and pion beams were performed on the X9 test beam at the CERN SPS. The beam line is almost parallel to the neutrino beam axis. The calorimeter, mounted on rails, can be shifted about four meters sideways from its nominal position inside the CHORUS apparatus to cross the test beam line. Electron data were taken with pure beams from 2.5 to 10 GeV/c, while pions came from mixed electron-pion beams from 3 to 20 GeV/c.

Three steps are needed for the determination of the calorimeter response: first, within each sector, the *equalization* of the signals from each individual PM, then the *intercalibration* among different sectors, and, finally, the overall energy calibration. The equalization of signals from modules of the same type is performed using penetrating cosmic rays. An *equalization constant* is computed for each PM by selecting cosmic muons crossing the central region of the modules (± 10 cm), and correcting for the effective track length.

To combine the signals of the three different sectors, two *intercalibration constants* are needed,

namely those of HAD1 and HAD2 relative to EM. These constants are determined experimentally using pions interacting at different calorimeter depths. The details of the equalization and intercalibration procedures are given in [4].

In Fig. 2 we show the calorimeter signal distribution produced by 10 GeV/c negative pions. The shape is gaussian, indicating that both the equalization and intercalibration procedure do not introduce any appreciable bias in the determination of the overall calorimeter response.

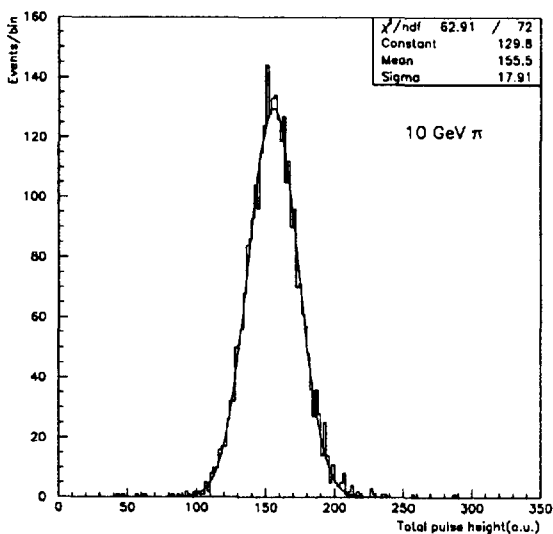

Figure 2. Calorimeter response to 10 GeV/c negative pions.

4. Response to electrons

The calorimeter response to the incoming particle is determined by adding up the energy deposited in all the modules after the equalization and intercalibration procedures. As noted before, each read-out cell is equipped with a PM at each fiber (strip) end, in order to reduce the

influence of the light attenuation in the scintillator. To combine the signals from the two sides (L and R) of a module, we use the geometric mean, $S_g = \sqrt{S_L \times S_R}$. Under the assumption of single hit per module and exponential light attenuation in the fibers (strips), the geometric mean yields a value for the module response which is independent of the hit position x along the module with length L .

The response to electrons was studied in the range from 2.5 to 10 GeV/c, relevant for the CHORUS experiment. For each momentum, a gaussian fit is performed to the distribution of the calorimeter signal.

The measured points lie on a straight line up to 10 GeV/c, where electronics saturation tends to reduce the calorimeter signal. This effect is due to the small space dimensions of the electromagnetic showers, such that a large fraction of the energy can be released in a single EM module. This does not happen for hadron or neutrino induced events, where many modules share the incident energy. The result of a linear fit performed in the interval from 2.5 to 5 GeV/c indicates that extrapolation to zero pulse height leads to a negative value of the momentum:

$$S = (17.2 \pm 0.3) \times P(\text{GeV}/c) + (6.4 \pm 0.9)$$

The above result is in agreement with our previous analysis on the electromagnetic response of single calorimeter modules, tested on the same beam line [2]. It is consistent with the actual value of the beam momentum being 370 ± 50 MeV/c higher than the nominal value. Monte Carlo predictions give a linear response of the detector to electrons, as well as to photons, and no offset is expected.

In order to clarify this problem, independent measurements were done at the CERN PS. The results indicate that the extrapolation to zero calorimeter pulse height leads, indeed, to a momentum compatible with zero (intercept equal to $+40 \pm 20$ MeV/c), supporting the conclusion of a calibration shift of the SPS X9 beam momentum. These results are shown in Fig. 3, together with the SPS points corrected for the 370 MeV/c offset; the agreement between the two sets of data is excellent. The following (corrected) relation is

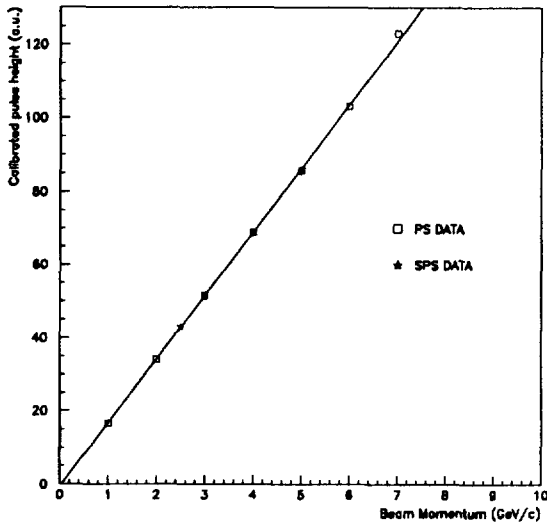

Figure 3. Electron response for the PS set-up. The SPS points are also shown, corrected for the 370 MeV/c momentum shift.

then obtained for the energy dependence of the electromagnetic response:

$$S = (17.2 \pm 0.3) \times P(\text{GeV}/c) - (0.14 \pm 0.96)$$

The energy resolution $\sigma(E)/E$, is plotted in Fig. 4 as a function of the electron energy. The energy dependence of the resolution is well fitted by the formula:

$$\frac{\sigma(E)}{E} = \frac{(13.8 \pm 0.9)\%}{\sqrt{E(\text{GeV})}} + (-0.2 \pm 0.4)\%$$

This result fulfills the design requirements and agrees with the Montecarlo predictions. By studying electron showers developing in different calorimeter zones we estimated the disuniformity in the electromagnetic response to be of the order of $\pm 5\%$, in agreement with the design requirements.

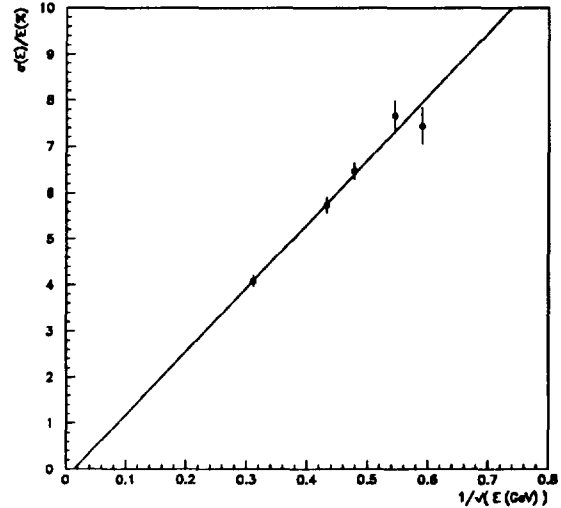

Figure 4. Energy resolution for electrons as a function of the energy.

5. Response to pions

The pion response was studied for different beam momenta, from 3 to 20 GeV/c. The mean value S of the signal distribution, which is gaussian as in the electron case, is plotted in Fig. 5 as a function of the nominal momentum P , corrected for the shift of 370 MeV/c, found with the electron data.

The measured pion momentum dependence may be parametrized as:

$$S = (15.3 \pm 0.2) \times P(\text{GeV}/c) - (5.8 \pm 1.0)$$

which corresponds to a *positive* intercept of 380 ± 65 MeV/c. A different value of this quantity for electrons (compatible with zero) and pions is expected and can be understood on the basis of the following considerations:

- a comparison of the response to electrons and pions of the same energy shows deviations from exact compensation ($S_{\text{electron}} >$

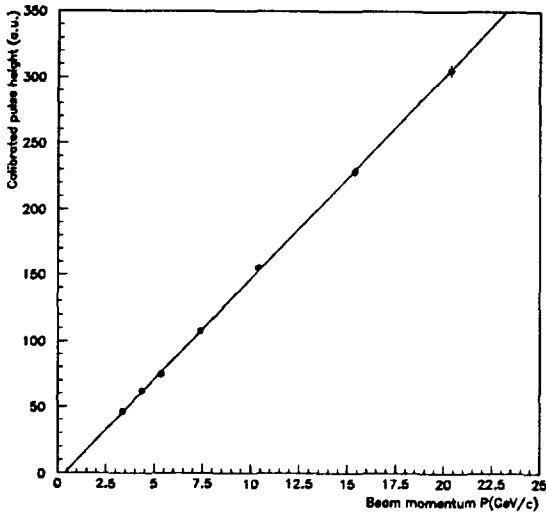

Figure 5. Calorimeter response as a function of the pion momentum.

S_{pion}). Therefore, at high momenta, the increase of the electromagnetic energy content in the hadron showers ($E_{\text{EM}}/E_{\text{TOT}} \propto \ln(E_{\text{TOT}})$) induces an energy dependent enhancement of the signal.

- At low momenta (~ 1 GeV/c), the contribution from neutral pions becomes negligible and small multiplicity processes dominate. In this case, the effect of the particle masses not converted into visible energy in the read-out gate becomes visible.

Both the above effects indicate that a straight line fit to the data taken in the mentioned momentum range should have an intercept at a positive value of the abscissa. This is confirmed by the Montecarlo simulation, which predicts an intercept of 340 ± 50 MeV/c. The calorimeter turns to be linear within 2%.

From the gaussian fit to the response distributions one determines the energy resolution $\sigma(E)/E$, which is plotted in Fig. 6 as a function

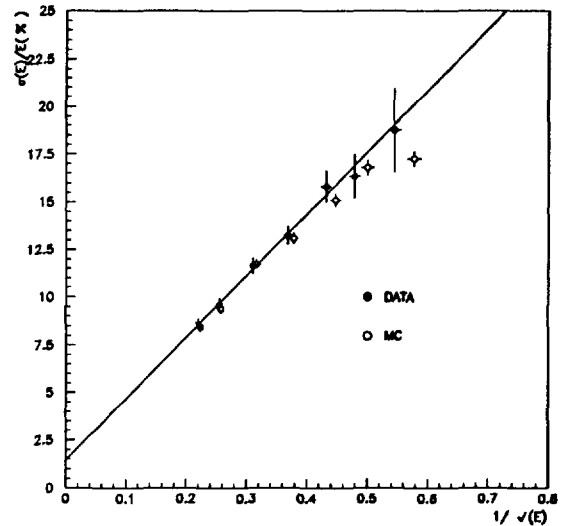

Figure 6. Pion energy resolution as a function of the energy. The open circles show the Montecarlo predictions.

of the pion energy. The Monte Carlo predictions are also shown. The errors assigned to each point include a systematic uncertainty of about 2% determined applying different event selection criteria to the data, and studying pions hitting different calorimeter positions. The above uncertainty is lower than the one for the electron case ($\pm 5\%$). The main reason for this is that more calorimeter modules are involved in a hadron shower. The energy dependence of the resolution is parametrized as:

$$\frac{\sigma(E)}{E} = \frac{(32.3 \pm 2.4)\%}{\sqrt{E(\text{GeV})}} + (1.4 \pm 0.7)\%$$

From the electron and pion response of the calorimeter we can determine the experimental e/π ratio. In Fig. 7 we plot the ratio of the average electron and pion calorimeter signal as a function of the momentum. The systematic error, due to the response disuniformity, has been

added to the statistical. In the same figure, we also plot the ratio of the functions describing the signal momentum dependence for electrons and pions.

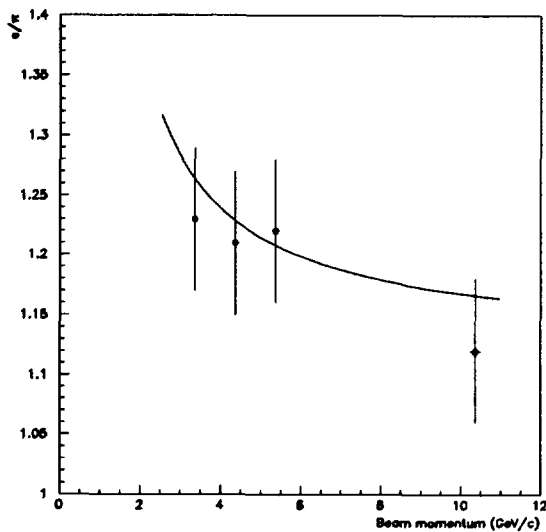

Figure 7. e/π ratio as a function of the beam momentum. The continuous line represents the ratio of the electron and pion momentum-dependence functions.

6. Conclusions

The calorimeter designed, built and operated for the CHORUS experiment at CERN for the search of $\nu_\mu - \nu_\tau$ oscillations is the first large scale application of the scintillating fiber-lead technique for integrated electromagnetic-hadronic calorimetry. It was exposed to electron and pion beams in the momentum range from 2.5 to 20 GeV/c at the CERN SPS to perform the absolute energy calibration.

The calorimeter response to electrons was found to be linear with the momentum, after applying a correction to its nominal value, as indi-

cated by measurements performed at the CERN PS. The energy dependence of the resolution was parametrized as

$$\sigma(E)/E = (13.8 \pm 0.9)\%/\sqrt{E(\text{GeV})} + (-0.2 \pm 0.4)\%$$

The calorimeter response to pions is also linear in the momentum range explored by the measurements, and we achieved an energy resolution of

$$\sigma(E)/E = (32.3 \pm 2.4)\%/\sqrt{E(\text{GeV})} + (1.4 \pm 0.7)\%$$

This result, showing an excellent energy resolution for hadrons, is in agreement with the design features and the Montecarlo predictions. The calorimeter has been successfully operational during the 1994, 1995 and 1996 data taking periods of the CHORUS experiment in the CERN Wide Band Neutrino beam.

7. Acknowledgements

This work was carried out with the financial support of the Italian Istituto Nazionale di Fisica Nucleare. We gratefully acknowledge the skill of our technical collaborators and engineers. The kind help of many CHORUS colleagues during the calorimeter construction and test is also warmly acknowledged.

REFERENCES

1. M. de Jong et al., CERN-PPE/93-131.
2. S. Buontempo et al., NIM **A349**, 70 (1994).
3. D. Acosta et al., NIM **A308**, 481 (1991).
4. E. Di Capua et al., CERN-PPE/95-188.