

5th generation district heating and cooling systems: A review of existing cases in Europe



Simone Buffa^{a,b,*}, Marco Cozzini^a, Matteo D'Antoni^a, Marco Baratieri^b, Roberto Fedrizzi^a

^aEURAC Research, Institute for Renewable Energy, Viale Druso 1, 39100 Bolzano, Italy

^bFaculty of Science and Technology, Free University of Bolzano, Piazza Università 5, Bolzano 39100, Italy

ARTICLE INFO

Keywords:

District heating and cooling
Cold district heating
Heat pump
Smart energy systems

ABSTRACT

This article investigates 40 thermal networks in operation in Europe that are able to cover both the heating and cooling demands of buildings by means of distributed heat pumps installed at the customer substations. The technology of thermal networks that work at a temperature close to the ground, can strongly contribute to the decarbonisation of the heating and cooling sector and furthermore exploit a multitude of low temperature heat sources. Nevertheless, the nomenclature used in literature shows that misinterpretations could easily result when comparing the different concepts of thermal networks that operate at a temperature level lower than traditional district heating. The scope of this work is to revise the definitions encountered and to introduce an unambiguous definition of Fifth-Generation District Heating and Cooling networks. A drawback-benefit analysis is presented to identify the pros and cons of such technology. The survey on the current networks shows that on average three Fifth-Generation District Heating and Cooling systems per year have entered the heating and cooling market in the last decade. Pioneer countries in such technology are Germany and Switzerland. For some networks, the assessed Linear Heating Power Demand Density results are lower than the feasibility threshold adopted in traditional district heating. High performances and low non-renewable primary energy factors are achieved in systems that exploit a very high share of renewable or urban excess heat sources. With respect to traditional district heating, the surveyed pumping energy consumptions result one order of magnitude higher, whereas the implemented control strategies can be completely different, leading the network temperature to float freely.

1. Introduction

Climate change is a fact and several experts claim the need for serious measures to be taken worldwide in order to mitigate its effects [1]. The European Union has shown the intention to reduce fossil fuel imports and consumptions to protect its energy supply from geopolitical conflicts [2]. Both of these subjects are causing radical changes in the energy sector as well as in people perceptions of energy use and savings. According to the projections of the United Nations, a worldwide “urban transition” process has been initiated which will distinguish the century between 1950 and 2050 [3]. A similar movement of people from rural to urban areas has occurred in Europe during the 19th century due to the industrial revolution. Thus, it is important for existing and future

urban centers to address both their environmental and energy supply challenges. Efficient energy use and the exploitation of indigenous energy sources are the key strategies to solve these problems together with energy saving policies. Nevertheless, they entail developing complex energy systems with the integration of non-programmable renewable sources as well as the implementation of circular economy models in the energy sector [4].

In Europe, the heating and cooling demand in the residential sector is responsible for a share of about 40% of the overall final energy usage [5]. However, new scenarios could evolve as a result of the regulations on the energy performance of new buildings [6] and on the refurbishment of the existing building stock [7] introduced by the European Commission. In fact, the RHC Technology Platform estimates different

Abbreviation: 3GDH, 3rd Generation District Heating; 4GDH, 4th Generation District Heating; 5GDHC, 5th Generation District Heating and Cooling; ATEs, Aquifer Thermal Energy Storage; BTES, Borehole Thermal Energy Storage; CH, Chiller; CHF, Swiss franc; DC, District Cooling; DH, District Heating; DHW, Domestic hot water; ESCO, Energy Service Company; GSHP, Ground Source Heat Pump; HP, Heat Pump; HD, Heat Demand; LHPDD, Linear Heating Power Demand Density; LTDH, Low-Temperature District Heating; LTDHC, Low-Temperature District Heating and Cooling; LTN, Low-Temperature Networks; PVT, Photovoltaic thermal hybrid solar collector; RES, Renewable Energy Sources; SC, Space cooling; SH, Space Heating; SWOT, Strengths, Weaknesses, Opportunities, Threats; TES, Thermal Energy Storage; ULTDH, Ultra-Low-Temperature District Heating; WSHP, Water Source Heat Pump

* Corresponding author at: EURAC Research, Institute for Renewable Energy, Viale Druso 1, 39100 Bolzano, Italy.

E-mail address: simone.buffa@eurac.edu (S. Buffa).

<https://doi.org/10.1016/j.rser.2018.12.059>

Received 7 June 2018; Received in revised form 8 October 2018; Accepted 31 December 2018

Available online 08 February 2019

1364-0321/ © 2019 The Authors. Published by Elsevier Ltd. This is an open access article under the CC BY-NC-ND license

(<http://creativecommons.org/licenses/by-nc-nd/4.0/>).

Nomenclature

COP	Electrical coefficient of performance
EER	Energy efficiency ratio
SCOP	Seasonal COP
SEER	Seasonal EER

trends in thermal energy consumptions in Europe by 2050, with a reduction in the heating demand between 20% and 30% and a rise of about three times of the cooling demand compared to 2006 values [5]. Furthermore, this tendency is confirmed by the 600% increase of the cooled floor area assessed in the EU between 1990 and 2010 [8]. Moreover, the number of space cooling (SC) units installed in the same period, dominated by room air-conditioners, expanded by 24 times with a growth rate of 3% per year [8].

District heating and cooling network (DHC) technology has been acknowledged as a promising solution for the reduction of both primary energy consumptions and local emissions to cover the heating and cooling demand of buildings [9,10]. Its classification and technology development is widely described in [11]. The last statistical survey on the DHC sector by Euroheat&Power [12] reports that about 6000 district heating (DH) networks were in operation in Europe supplying about 11–12% of the total heat demand in 2017. For district cooling (DC) only 115 systems have been identified. As stated by the DHC+Technology Platform [13], the latter covers a share of about 2% of the overall cooling demand. Paradoxically, DC systems are more widespread in the northern than in the southern European countries, as it has been observed within the project RESCUE [14].

Traditional DH systems consist of centralised power stations that feed hot water or steam into pipes to distribute heat in urban areas. High-temperature DH systems still suffer from significant heat losses and high installation costs. Especially in summer, when generally many DH systems operate only to meet the DHW demand, the network thermal losses can reach a value of about 30% of the supplied energy because of the high retention time of water in the network. Prando et al. (2015) argue that the economic profitability of traditional high-temperature DH infrastructures can be compromised by these issues together with the reduction in heating demand due to the renovation rate of the existing building stock [15]. For these reasons, current research focuses on the 4th and 5th Generation DHC networks, which can reach high efficiencies by operating at low temperatures. Lund et al. argue that 4GDH technology paves the way for excess heat recovery and integration of renewables into the network [11]. Nevertheless, in 4GDH systems, the same pipes are not able to provide simultaneously both heating and cooling services to different buildings. This is the challenge of the 5GDHC technology whose state-of-the-art review is presented in this study. Despite 5GDHC networks are at the early stage of development, several systems are in operation in Europe mainly started as pilot projects. Many of these systems operate differently from traditional DHC technology. For instance, they supply water to decentralised Water-Source Heat Pumps (WSHP) at a temperature in the range between 0 °C and 30 °C. This has several advantages with respect to traditional DH systems, as presented in the next section. Moreover, 5GDHC permits a free-floating temperature of the network and the exploitation of quasi-infinite indigenous heat sources. Distribution temperature close to the ground one (“neutral” from thermal losses point of view), the capability to work in heating or cooling mode independently of network temperature, bi-directional and decentralised energy flows are some of the keys added values of 5GDHC with respect to 4GDH.

5GDHC technology belongs intrinsically to the smart thermal grids concept [16]. The reason is that such technology exploits hybrid substations and enhances sector coupling between electrical and thermal grids in a smart energy system [17]. In parallel with electric vehicles

becoming more dominant in the transport sector, the 5GDHC technology could represent the sustainable and rational electrification of the thermal sector in urban areas. The same advantages of GSHP with respect to ASHP [18–20] can be found in 5GDHC systems: the higher temperature of the source in heating mode and the lower temperature of the sink in cooling mode with respect to the air temperature allow achieving higher seasonal performance of the system. The additional advantage of 5GDHC systems is that centralised solutions can be found to install seasonal heat storage in urban areas where the space availability could compromise the installation of ground heat exchangers for individual GSHPs. Moreover, the combination and simultaneity of different building loads enhances the possibility to reuse the excess thermal energy from chillers for heating purpose.

With 5GDHC still being a recent and unexplored field, the know-how about this technology is in the hands of few companies. Moreover, the exploitation of local thermal energy sources and the adoption of decentralised “active” substations pave the way for both breaking the monopolistic concept of DHC system and developing new business models for multi-utility companies. No technical standards or guidelines are available for designers and there is a lack of knowledge for 5GDHC operational optimization and control [21].

The authors have encountered several ambiguous definitions of 5GDHC technology that can lead to misunderstanding and confusion. The present paper aims at describing the classification encountered and at organizing the additional information here gathered to widespread the dissemination and the development of this technology. A review about Cold District Heating (CDH) concept can be found in Pellegrini and Bianchini [22]. Nevertheless, an extended review about existing case studies has not been found in the literature. Moreover, this technology is not cited in the first international review on DHC published in a scientific journal by Werner [23]. Few conference papers describe the results from monitoring and simulation works dedicated to single case studies [24–29]. Only two journal articles analyse the topics of 5GDHC networks control and optimization [21,30].

The study aims at presenting the result of a statistical survey performed on 40 5GDHC systems that are in operation in Europe. A non-exhaustive list of such systems is reported in Table 2 of the appendix. The goal of the work is to cover the scientific gap about the major technological challenges addressing 5GDHC networks. The current review makes a step forward in the current literature by describing and comparing the implementation and operational aspects for a wide range of real systems. The methodology adopted includes, firstly, a description of strengths and weaknesses of 5GDHC in Section 2 by means of a SWOT analysis. Secondly, a statistical survey on the mentioned case studies. The results of this survey are summarised in Section 3. Finally, in Section 4, inspired by the available information of the surveyed systems, the authors widely discuss the challenges that different stakeholders have to address when dealing with the design and operation of 5GDHC systems.

2. Why fifth-generation district heating and cooling networks?

2.1. Motivation

While traditional DHC systems are based on a production-centric perspective where the grid manager has the responsibility to provide an adequate differential pressure and supply temperature to each substation [31], future DHC systems that could exploit distributed and “active” substations, could move to a consumer/prosumer-centric perspective. Even today, in current advanced thermal grids, temperature levels and storage capacity of the network are managed to minimize the operational costs of the system, considering the interaction with the electrical market and the prediction of thermal loads. The step forward in DHC research and development could lead to futuristic thermal networks where decentralised substations interact and exchange the energy quantities for a price. This kind of business process is called

“Transactive Energy” [32] and it is a hot topic in current power grids research. Among electrical microgrids, one that is founded on energy transactions through a blockchain-based energy market has been implemented in Brooklyn [33].

The concept of 5GDHC technology derives from Ground Source Heat Pump (GSHP) systems as well as Water Loop Heat Pump systems. The first is commonly used only for single buildings. The second is mainly widespread in commercial buildings when heating and cooling loads simultaneously occur [34]. Similarly, 5GDHC technology is expected to be suitable for a building portfolio where the heating and cooling loads could themselves balance the system on short and large time scales. This can be achieved by means of the exploitation of energy synergy between buildings with different designated use.

Table 1 summarises the application of the SWOT analysis to the 5GDHC technology. Here, the normal and italics comments represent a comparison of 5GDHC technology with traditional high-temperature DH and conventional heating systems, respectively. In this study, individual gas boilers and possible room air-conditioners are considered as conventional heating systems.

The strengths of a low supply temperature in the network show several advantages. Firstly, it permits recovering all possible kind of excess heat available in a complete Circular Economy strategy [4] exploiting energy synergies among heat sources and sinks available at a district level. Urban low-grade excess heat can be recovered directly in 5GDHC without the need of HPs, contrary to what occurs in traditional high-temperature DH systems. Moreover, the fact that the excess heat sources are close to the heat demand avoids the construction of transmission pipelines in outer-city areas. 5GDHC networks are bi-directional so that different substations can extract or supply heat simultaneously from the network, providing both heating and cooling services independently from the network temperature. This fact gives to the owner a freedom in operation of the substation equivalent to having an individual heating system.

5GDHC systems can be integrated with pre-existing high-temperature DHC networks, for instance by decreasing the temperature of the return pipeline. This concept could lead to a Multi-Level District Heating (MLDH) [35] where thermal energy is supplied with pipes working at different temperatures. For instance, this solution, has been proposed in the urban renovation project for the district Hertogensite in Leuven (Belgium) where it is foreseen to supply the existing buildings

($HD < 70 \text{ kWh}/(\text{m}^2 \text{ y})$) with a 3GDH grid and the new buildings ($HD < 25 \text{ kWh}/(\text{m}^2 \text{ y})$) with a 5GDHC grid [36]. Moreover, 5GDHC systems are resilient to changes in boundary conditions like variations in building efficiency levels and user needs. Since the user substation includes a HP, thermal energy can be supplied both at a low or high temperature satisfying the requirement of the building heat emission system. This fact provides a big flexibility in the provision of the service as it occurs in the 5GDHC system of Bulle as well as at the “Familienheim-Genossenschaft” 5GDHC system in Zürich [37]. In the latter system, two stage HPs are used to supply the existing buildings at a temperature of 67 °C whereas single stage HPs are employed to supply new buildings at a temperature of 38 °C. It results in a SCOP for these machines of 3.9 and 5.2, respectively. Moreover, neighbourhood-based energy planning is fundamental to develop 5GDHC systems according to a “self-balanced” cluster approach. Small budgets and low risk in the investment are achievable by exploiting indigenous sources without the need to reach of a huge “critical” mass of customers. In this way, the construction of big centralised energy production facilities is avoided. 5GHC networks can evolve with modularity and in line with development of the urban area, connecting independent clusters supplied by their own micro-grid. A high rate of flexibility can be also achieved in 5GDHC systems. The shift in time between thermal energy production and use is not problematic thanks to the exploitation of either centralised thermal energy storage (TES) capacities at the network level or decentralised TES capacities at the user substation level [38].

Due to the low-temperature of the network, pipelines do not suffer from high thermal losses and thermo-mechanical stress. This permits the adoption of uninsulated high-density polyethylene (HDPE) pipes and the use of components from the water supply industry. Installation time and costs are reduced with respect to traditional DH systems because flexible pipes can be rolled-out during installation and adapted to different geometries while pipe joints can be performed with fittings. Thus, TIG welding processes, X-ray or Ultrasound inspection techniques and local insulation of joints, that required skilled manual work in traditional DH systems, can be avoided in 5GDHC systems. Moreover, the very low temperature of the network permits also to maximise the energy efficiency of solar thermal collectors, CHP plants, and heat rejection units if they are connected to a 5GDHC system. This factor really matches 5GDHC networks with Solar District Heating technology [39]. A related point to consider is the combination of 5GDHC systems with

Table 1

SWOT analysis applied to 5GDHC technology.

Strengths	Weaknesses
Allow recovering low-temperature excess heat and include low enthalpy RES. Bi-directionality: it provides simultaneously both heating and cooling services throughout the year. Modularity, flexibility and resiliency to a change of boundary conditions (building level efficiency, loads). Negligible thermal losses because of the low-temperature difference between the pipes and the ground. Pipelines can be uninsulated. Pipelines can be made of polymeric materials. The ground and the network can be used as thermal storage.	Substations are more expensive than those in previous DH generations (CAPEX). The installation of an individual DHW tank is needed. Low ΔT between supply and return pipes leads to larger pipeline diameter and storage thermal capacity. High pumping costs per unit of energy due to small operative ΔT and higher fluid viscosity. Electricity costs (and related primary energy consumptions) for HPs.
Opportunities	Threats
New business model for the energy market. Conversion of an existing high-temperature network in 5GDHC is possible in theory and need important verifications. Synergy with seasonal storage (lower losses, though also lower ΔT). <i>Decarbonisation target can be achieved by utilities or municipalities by developing this kind of infrastructure.</i> <i>New energy concept at a district level permit to achieve high primary energy savings target by means of a light renovation of buildings.</i> <i>Higher interaction with the electric sector (possible usage of HPs for Demand Side Management)</i>	The approach in design and sizing adopted in traditional DH systems needs to be reviewed. The COP of the HP can be too low, depending on the type of the building heating system and on network supply temperature. Higher costs and lower performance for future HPs due to F-gas phasing out. In case of dependence on seasonal storage, lack of space. <i>Installation is invasive both for the pipelines and user substations.</i> <i>Decisions for connection are made by a single user or group of users.</i>

seasonal TES. In fact, Borehole and Aquifer TES are well suited to 5GDHC technology. By storing heat at a low temperature in the ground and in aquifers, the performance of such TES is maximised.

The advantages listed above, however, are paid with more complicated and expensive substations with respect to traditional DH. This because a 5GDHC substation includes a Water-Source Heat Pump (WSHP) and a Domestic Hot Water (DHW) tank. The HP boosts the supply temperature on the building side according to the user needs and its operation can be inverted in order to cover both heating and cooling demands. Concerning the investment costs, the additional capital costs per dwelling, for the installation of a 5GDHC system with respect to a conventional heating system, has been assessed to 5500 euros in Duindorp (Netherlands) [40]. Moreover, the small temperature difference between warm and cold pipes in 5GDHC networks, together with the adoption of brine as carrier medium, results in higher volumetric flow rate needed to supply the same thermal power with respect to a traditional DH network. To limit pressure losses, the installation of pipes with large diameters is unavoidable.

Nevertheless, the interconnection with the electrical grid due to the HPs and the exploitation of local excess heat sources makes 5GDHC suitable for new business models for both multi-utilities companies and excess heat providers. The latter could generate profits thanks to regulated third party access (TPA) to the network. Besides this, 5GDHC technology permits also a transition towards a decarbonised heat sector and a notable reduction of total CO₂ emissions. Moreover, direct emissions of CO₂ and pollutants are completely avoided. Verhoeven et al. argue that the 5GDHC network in Heerlen allowed a new college constructed in 2013, to save the 45% of CO₂ emissions with respect to a conventional system based on gas boilers and electrical chillers [41]. Thus, the development of a 5GDHC really matches with the construction of new districts with low-temperature emission systems and with the refurbishment of the existing building stock. A holistic design approach allows the exploitation of energy synergies among 5GDHC, indigenous heat sources, and local networks (main, dual distribution networks, wastewater network, fire protection network, etc.) that can be arranged so that the cluster of buildings can reach a net zero energy balance at different time scales.

Even though the conversion of a traditional DH network to a 5GDHC system is theoretically feasible, it requires a new assessment of the supply capacities of the pipelines. Moreover, the design approach adopted in traditional DH needs to be revised for 5GDHC systems in order to consider the operation of HPs, thermal capacity effects and dynamic interaction with seasonal TES. Design guidelines for 5GDHC have not been found in literature and only a few companies gained knowledge on such technology starting from pilot projects.

As stated in the SWOT analysis described above, one threat comes from the fact that the HP industry is facing with the phase-out regulations for fluorinated greenhouse gases (HFCs) in several countries so that performances and costs of the equipment could change in the next years. The European Union is leading this process by approving this international agreement [42] and developing already the first version of its own “F-Gas” regulation in 2006 [43] and a new one in 2014 [44]. Despite this fact, as claimed by the EHPA projections in Europe [45], which consider the current HPs market growth with sales that double every 8–10 years, the forecasted HP manufacturing costs will dwindle of about 22% by 2024 and 39% by 2030. This should increment the competitiveness of 5GDHC networks with respect to both individual fossil based heating systems and former DH technologies.

Finally, it is worth mentioning that the transition from an energy concept which consists of individual heating systems towards a “shared” one at the district level is not an easy task. Several challenges need to be addressed concerning the invasive installation of pipes and substations together with the perception of the DHC technology from the customers. Customer participation and engagement in projects is essential to start a DHC business as it has been shown by a survey performed in the United Kingdom [46]. The results demonstrate that

customers would like to have a say, firstly, on how profits can be re-invested in the community and in the energy supply systems. Secondly, on how heat is produced. Participation in decision making-processes is much more important than co-ownership. On the contrary, having no choice in the supplier and no influence in establishing the heat price makes citizen perceptions of DHC more negative. From the survey presented herein, it has emerged that in some cases (like Wüstenrot and Nümbrecht in Germany) the proposal to start a 5GDHC system came firstly from communities and municipalities that would like to be energy independent from fossils. 5GDHC technology has been chosen because of the high rate of eco-friendliness and freedom in adopting local renewable energy supply sources. Nevertheless, in some cases, it could be possible that a municipal regulation obligates citizen to connect their own building to the local DHC network. For instance, this is being occurred in the town of Bulle in Switzerland for new buildings [37].

2.2. Need of clarification and harmonization

The implementation of 5GDHC technology is growing fast although, a uniform nomenclature and established design guidelines do not exist [47]. The authors have found several different definitions of the same concept in literature as reported following:

- Low temperature District Heating and Cooling (LTDHC) in [25,27];
- (Bidirectional) Low temperature networks (LTNs) in [21,24], [28,30];
- Cold District Heating (CHD) [22,29,48–50] (“Kalte Fernwärme” or “Kalte Nahwärme” in German and “Teleriscaldamento Freddo” in Italian);
- Anergy networks or Anergy grid (“Anergienetz” in German) in [51,52].

Some of these definitions are in conflict with the ones linked to 4GDH systems as reported following. In particular, Østergaard and Svendsen (2016) [53] call:

- Low temperature District Heating (LTDH) a 4GDH system with only heat exchangers in the substations and a supply temperature higher than 50 °C;
- Ultra-low temperature District Heating (ULTDH) a 4GDH system with a supply temperature of about 35 °C used in floor heating systems and DHW pre-heating. An electric heater or a booster HP is used to raise the temperature for DHW preparation.

Another ambiguity is linked to the definition of Low-Ex systems like in [54] and [55]. It can be applied both on 4GDH and 5GDHC solutions when connected to buildings where, differently from traditional radiators, the temperature difference between the heating emission system and the indoor air is small (like in underfloor heating systems and radiant ceiling panels).

The above definitions lead to the lack of uniqueness and are linked to concepts that are not easy to understand by non-experts. In particular, some definitions highlight the temperature level of the distribution medium leading to confusion between different technologies. Another expression uses an oxymoron contrasting the noun “heating” with the adjective “cold”. The last one, widespread in Switzerland, takes into consideration the temperature level of the network introducing the concept of “anergy”: the component of a form of energy that cannot be converted into exergy. To find a single terminology that contains all these aspects is a delicate task. Moreover, different expressions of the same concept can lead to misunderstandings and hinder the diffusion of information about this technology versus final users and potential investors. To remedy to this fact the unambiguous definition of “Fifth-Generation District Heating and Cooling” is strongly suggested by this study. This definition is in line with the classification performed

Box 1

A 5GDHC network is a thermal energy supply grid that uses water or brine as a carrier medium and hybrid substations with Water Source Heat Pumps (WSHP). It operates at temperatures so close to the ground that it is not suitable for direct heating purpose. The low temperature of the carrier medium gives the opportunity to exploit directly industrial and urban excess heat and the use of renewable heat sources at low thermal exergy content. The possibility to reverse the operation of the customer substations permits to cover simultaneously and with the same pipelines both the heating and cooling demands of different buildings. Through hybrid substations, 5GDHC technology enhances sector coupling of thermal, electrical and gas grids in a decentralised smart energy system.

by Lund et al. [11] that relates the evolution of the different generations of the DHC technology to the decreasing temperature of the distribution medium and it is affirmed in literature. The term “Fifth-generation” has been firstly proposed in the full name of the H2020 Project known with the acronym FLEXYNETS (2015) [56]. Moreover, Schmidt [57], Pattijn and Baumans [36], and Bünning et al. [58] have also adopted this nomenclature.

5GDHC will play a more and more significant role in the future energy systems. It can be considered a DHC technology with a high potential because of the features mentioned above: resilience, bi-directionality of the energy flows, exploitation of indigenous low-grade heat source and decentralised interconnection with the electrical grid make 5GDHC different from the former generations of the DHC technology. A compact summary of the most important features of 5GDHC systems is reported in Box 1.

2.3. Classification of systems and networks

5GDHC networks can be considered the extension of Ground-Source Heat Pumps (GSHP) systems at a district scale. Thus, depending on the method for the heat extraction/rejection from/towards the thermal source they can be classified [59,60] in:

- *Open-loop systems* where the medium of the thermal source is extracted by means of hydraulic pumps and then discharged, after the exploitation of the energy content. They can supply the HP pool directly (*direct open-loop systems*) or indirectly with the installation of a HE in between to isolate the HPs loop (*indirect open-loop systems*). In *Standing column systems* water is extracted and injected to the same well;
- *Closed-loop systems* where the carrier medium exchanges thermal energy with the source in a closed circuit. The same circuit generally supplies also the HP pool. Usually, it is applied in ground-coupled systems with vertical or horizontal geothermal heat exchangers.

A classification of thermal networks has been performed by Sulzer and Hangartner [61,62] according to:

a) the number of the pipelines at different temperature levels in:

1. *One-pipe systems* (direct open loop typical of systems that exploit surface or ground water where after supplying thermal energy to HPs and CHs the medium is released to the ambient);
2. *Two-pipe systems* (water loop to which HPs and CHs are connected where the temperature of the supply pipe is higher than the return one if the heating demand dominates the system, vice versa if the cooling demand dominates the system);
3. *Three-pipe systems* (an additional supply pipe is installed that works at a temperature suitable for direct heating or direct cooling by means of HEs; the return flow rate is realised in the high or low temperature pipelines of the HPs and CHs loop);
4. *Four-pipe systems* (two separate supply pipes are installed to work at a temperature suitable for direct heating and direct cooling respectively and allowing energy cascading);

a) the combination of the energy flow direction and medium flow direction in:

1. *Unidirectional energy flow – directional medium flow* typical of traditional DH/DC system with one supply station where all the user can operate in heating or cooling mode;
2. *Unidirectional energy flow – non-directional medium flow* typical of traditional DH/DC system with multiple supply stations where the direction of the flow can change in some branches of the network;
3. *Bidirectional energy flow – directional medium flow* typical for 5GDHC networks with centralised pumping station where some user can be in heating and others in cooling mode;
4. *Bidirectional energy flow – non-directional medium flow* typical for 5GDHC networks with decentralised pumping stations (one for substation) where simultaneously some user can be in heating and others in cooling mode. Multiple types of hydraulic configurations can be considered for this case.

As reported by the survey presented in the next section the 5GDHC systems of Naters, Visp and Sale Marasino belong to the *Bidirectional energy flow – directional medium flow* concept whereas the 5GDHC systems of ETH Zürich, Richti Wallisellen, “Surstoffi”, “Familienheim-Genossenschaft” and Herleen belong to the *Bidirectional energy flow – non-directional medium flow* concept.

3. Statistical analysis of 5GDHC networks

3.1. Survey methodology

The described case studies have been surveyed between September 2017 and January 2018 by the authors. Information has been taken from online and printed sources like conference proceedings, technical journals, presentations, and web pages of companies involved in design and installation of such systems. Only in few cases, information about existing 5GDHC systems has been encountered in scientific articles published on international journals [30]. No statistical analysis applied to existing 5GDHC systems has been found in conference proceedings or journal articles.

The sample size corresponds to 40 cases found in Europe. The full list of cases is reported in Table 2 of the appendix, specifying the key indicators used for the different classifications. The surveyed 5GDHC networks have been classified according to the country to understand the connection with social and political drivers as well as the availability of indigenous heat sources. The year of entering in operation has been identified to understand the age of the current systems and their installation rate. Moreover, they have been classified in agreement with the concept adopted for the thermal sources exploitation and their depletion mitigation as well as the kind of heat sources adopted. Borehole TES have been investigated to understand typical sizes. Finally, the temperature variation of the network and the SCOP of the surveyed systems have been analysed to evaluate the connection between system operation and performance.

The investigation area was limited to Europe where the 5GDHC technology is growing considerably. All the analysed systems include at

least two substations connected by a network. Furthermore, all the systems encountered consist of substations with electrically driven compression HPs. Despite the potential application, the installation of WSHPs driven by natural gas has not been encountered in the surveyed networks. A large number of existing cases can be considered pilot projects. Their extension is foreseen in the coming years by connecting additional buildings. Some aspects are hardly comparable and are unique for each single case study. For instance, some systems include decentralised gas boilers or electrical backup units. In some cases, the old gas boilers and electrical backup units are still in place after refurbishment. Others have installed centralised backup units whose aim is to provide a minimum supply temperature to the HP pool during critical conditions. They usually are gas boilers, water-source or air-source HPs. The detail and performance of the operation in cooling mode, via free cooling or active solutions, are provided as additional information in very few cases. Furthermore, design conditions are generally available for the seasonal performance of the systems while for few cases monitored data are available.

3.2. Results

The results of the survey are analysed in agreement with the methodology described above. The complete list of the surveyed systems is reported in Table 2 of the appendix. Many of the surveyed 5GDHC systems are located in areas with highly productive aquifers. Thus, they exploit groundwater as a thermal source by means of extraction and injection wells. A complete overview of porous and fissured aquifers areas in the European continent is shown in the International Hydrogeological Map of Europe [59]. Some systems exploit the sea or a lake as “quasi-infinite” sources of thermal energy. It occurs in the coastal area with the Mediterranean Sea as well as with the North Sea. Other systems, which cannot exploit a hydrothermal source, are conceived differently. In general, they include a closed-loop network connected to a boreholes field so that the ground can be exploited as a

source/sink of thermal energy. Two-pipe systems are usually implemented whereas a three-pipe system has been implemented at the Höggerberg ETH campus in Zurich. A ring configuration in *bidirectional energy flow – non-directional medium flow* systems is preferred where a continuous expansion of the network is expected. This because it allows flexibility in changes and makes easy the connection of further clusters.

3.2.1. Survey results by country

As it is shown in the pie chart of Fig. 1 most of the surveyed 5GDHC networks are located in Germany and Switzerland (75%). Both countries can be considered pioneers in this technology. Here, the main drivers are the will of local authorities, building investors or local communities to opt for sustainable heating and cooling solutions. In particular, in the northeastern and southwestern parts of Switzerland 5GDHC networks are growing rapidly [47]. The main driver of this phenomenon is the “2000-Watt Society” energy policy concept developed at the ETH Zürich and supported by the 75% of Zürich population in a referendum held in 2008. It demonstrates that it is possible to limit the amount of per-capita primary energy consumption equivalent to an average power of 2 kW per hour (i.e. 48 kWh per day, or 17520 kWh per year), without sacrificing comfort. To reach this goal the Swiss society should cut the current consumption by three times to reach the same energy consumption rate of the '50s [48]. Moreover, the 58% of the Swiss population voted in favour on the “Federal Law on Energy” during the last referendum held in May 2017. This historical event has sanctioned the step-by-step phase-out of nuclear energy in the country in favour of the increment of energy savings, renewable energy production and energy efficiency. The Richti Wallisellen district and the ETH Höggerberg campus in Switzerland are the first sites where the “2000-Watt Society” energy policy has been implemented via 5GDHC networks. Both exploits seasonal borehole TES and excess heat to help its regeneration [37,49]. Moreover, active cooling exploiting chillers in residential buildings is not allowed by law in Switzerland [25], for this

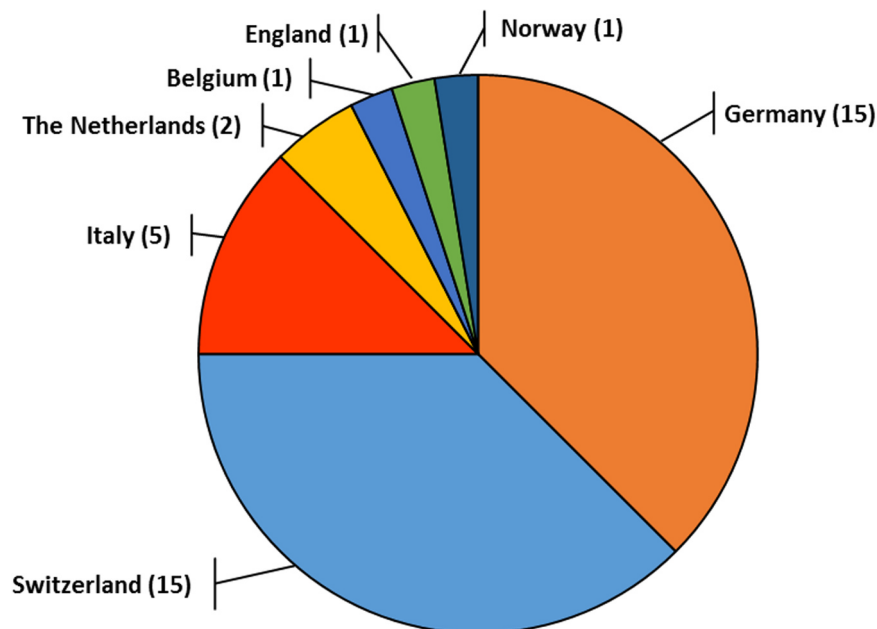

Fig. 1. Surveyed 5GDHC systems by country.

reason, 5GDHC technology has big potential here supplying free-cooling to such buildings. A few 5GDHC cases have been encountered in Italy, The Netherlands, Belgium, England, and Norway. Most of them can be considered pilot projects that have been useful to understand in depth both economic and technical aspects of 5GDHC networks under real circumstances.

3.2.2. Survey results by the year of entering in operation

Fig. 2 shows the year where the surveyed networks have started their operation. Among the surveyed systems, the first network of this kind was located in Dorsten-Wulfen (Germany) and started its operation in 1979. It exploited ground water as a source and supplied 71 buildings [63]. The pioneer 5GDHC system that exploited excess heat as a source is located in the "Stiegelpotte" area in Spenge (Germany) and started its operation in 1994. Here excess heat from a weaving mill

supplied 125 residential buildings with a total thermal capacity of about 700 kW [64]. After the stop in production of the weaving mill in 2003, the system has been supplied by natural gas and geothermal energy [65]. Another pioneer project started in 1994 in Oberwald/Obergoms (Switzerland) by the exploitation of a geostructure (mountain tunnel) as a source for the HP pool. In 1995 in Norway, the heating and cooling plant at the campus of the University of Bergen has been upgraded with a 5GDHC to exploit the water of a fiord as a sustainable alternative to conventional systems based on fossil fuels. As it can be seen in Fig. 2 several 5GDHC networks have entered the heating and cooling market in the last ten years with an average installation rate of about 3 systems per year. This has occurred mainly in Switzerland where several 5GDHC systems are planned for the next years [66]. The interest in such technology is growing in international multi-utility companies. One of them had developed its own trademark for such technology [67] and is going to install the first system of this kind at the Medicin Village in Sweden.

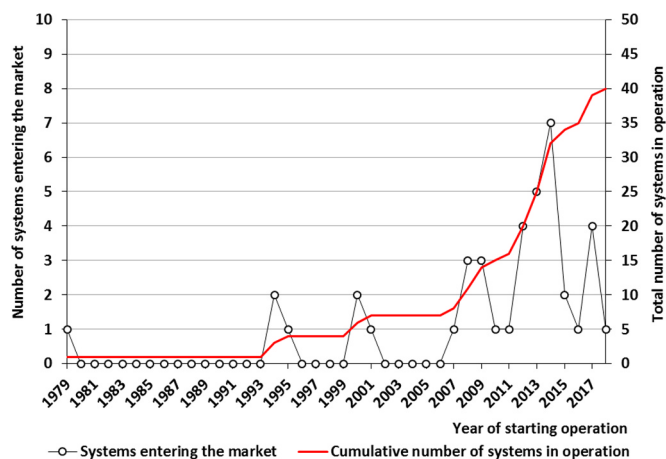

Fig. 2. 5GDHC networks entering the heating and cooling market.

3.2.3. Survey results by concept

Fig. 3 identifies three different concepts for the surveyed 5GDHC networks:

- The non-regenerative concept (28%) includes all the systems in which the thermal energy is supplied from different sources to the HP pool without regeneration of the source;
- The regenerative concept of kind A (33%) includes all the systems where the depletion of the thermal source is mitigated by means of mass transfer of the carrier medium as it occurs when aquifers thermal energy storage (ATES) are exploited via an open loop system;
- The regenerative concept of kind B (40%) represents all the systems where the regeneration of the thermal source occurs by heat transfer to the TES medium. It is applied to restore the thermophysical properties of the borehole and ice TES.

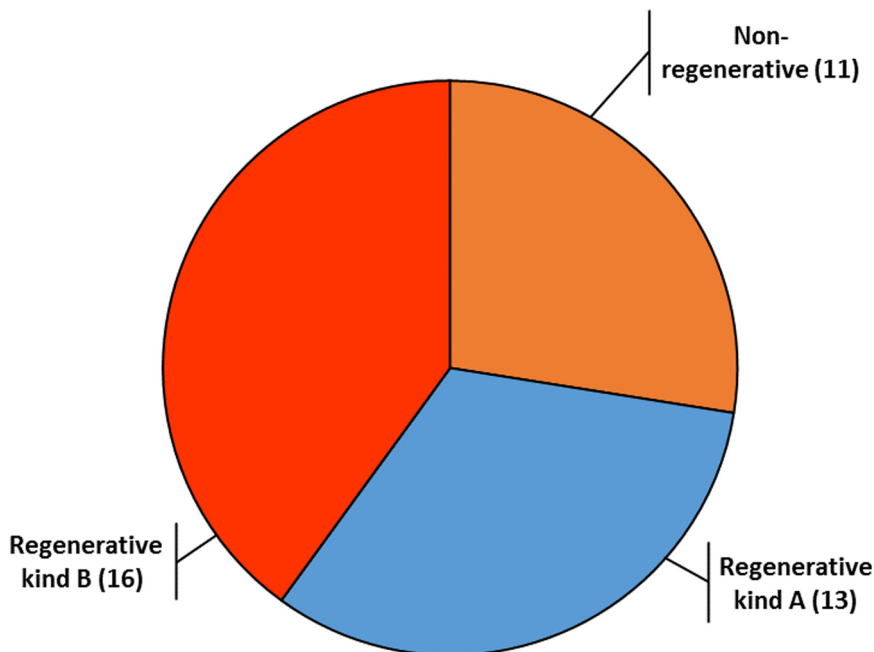

Fig. 3. Surveyed 5GDHC systems by concept.

3.2.4. Survey results by source

As mentioned above, each system can be considered unique in terms of loads and solution adopted. The pie chart of Fig. 4 shows a vast number of sources combination that sometimes is due to ongoing arrangements as a result of design mistakes or changes in the load profiles. The 62.5% of the case studies can be considered supplied only by a single source. In particular, almost half of these include a quasi-infinite thermal energy source (like seawater, groundwater, and river). The rest includes sources where a sufficient (but limited) amount of thermal energy is available throughout the year (excess heat, geostructure) or where the energy flows between sources and sinks are such that the storage medium regeneration is achieved by means of vertical or horizontal ground heat exchangers.

When the sea is used as a source/sink a titanium HE is adopted to separate the seawater loop from the water loop at which the decentralised HPs are connected. Moreover, decanting tanks, filtering and anti-corrosion systems are needed. If the temperature source is too low for some periods of the year, some centralised backup units are installed for maintaining at a minimum temperature the main loop to guarantee good performance of the HP pool. This is the case of the system installed at the University of Bergen (Norway) that includes a centralised ammonia water-to-water HP that also exploits the sea as a thermal source, whereas the 5GDHC network in the “Arsenale Nord” area in Venice includes a gas boiler.

It has been found that deep lake water is used as heat source and for free cooling at the Geneva lake by two 5GDHC systems: “Genève-Lac-Nations” and “La Tour-de-Peilz” [37]. Moreover, two 5GDHC systems exploit the thermal energy from rivers. The first is located in Ohrberg (Germany) where the water from the river Weser supplies the local WSHPs of 82 residential building units [68]. The second is the latest 5GDHC project “Janseniushof” in Leuven (Belgium) where the thermal energy from the river Dijle can be used to supply the HP pool or to regenerate the ATEs [36].

Three of the surveyed 5GDHC networks use directly low-grade excess heat as a source. Two systems located in Aurich and Herford (Germany), exploit process excess heat at a temperature between 25 and 35 °C from local dairies. Moreover, excess heat from a chemical process is used to supply the “Visp-West” district in Switzerland with a temperature range between 8 and 18 °C. Other local excess heat sources are used to balance the network and to regenerate the available BTES or

ATES. In particular, data centers and chillers supply the 5GDHC system of the “Familienheimgenossenschaft” in Zürich and the one in Richti Wallisellen (Switzerland) in keeping with this concept. In a similar way in Herleen (The Netherlands) two abandoned coal mines have been exploited as a low-temperature resource since 2008 [41]. Here, the reservoirs depletion is contrasted with the integration of excess heat sources like data centers and cooling towers. The latter case study can be considered one of the most advanced 5GDHC network thanks to the technical solutions adopted and to the development in monitoring and control within the H2020 project STORM. The 5GDHC network in Obergoms (Switzerland) is the only system in operation encountered that exploits a geostructure (the “Furkatunnel”) as a thermal source at 16 °C to supply 209 apartments, 1 hotel, and other public buildings.

The 37.5% of the cases include at least two thermal energy sources. Here, in general one or more centralised or decentralised solutions are adopted to preserve the regeneration of the soil (borehole TES or agrothermal collector) or ice TES. Solar energy is adopted as an integrative source in 4 case studies. Two of these (Saas Fee and REKA village systems) includes hybrid PVT panels whereas the other two have installed traditional solar thermal flat plate collectors (FPC).

Ambient energy from the external air is adopted as an integrative thermal energy source/sink in 4 case studies. Here dry coolers are installed in general to transfer heat to an intermediary circuit to directly supply/reject heat to/from the thermal grid and eventually regenerate the centralised TES, to supply a centralised water-to-water HP or both. This kind of solution is adopted in the networks of Sedrun, Obstanger and Saas Fee (Switzerland) coupled with a borehole TES whereas the 5GDHC network that supplies the “Karl-May-Weg” district in Fischerbach (Germany) includes an ICE storage [69].

The “multisource” cases combine the solutions presented above. In particular, the 5GDHC system that supplies the “Surstoffi” area in Risch Rotkreuz (Switzerland) integrates the excess heat provided from free-cooling and the heat supplied by the decentralised PVT fields with a big borehole TES (215 boreholes, 150 m depth). The same occurs in the small network that supplies the REKA village in Blatten-Belalp where additional excess heat is recovered from the sewer. In Chur, the 5GDHC network that is in operation since 2013 supplying the district “Rheinfels/Kleinbruggen” exploits, in parallel with groundwater, the thermal energy from the existing biomass boiler and CHP plant [70]. In the framework of the LIFE4HeatRecovery project started in 2018, it is

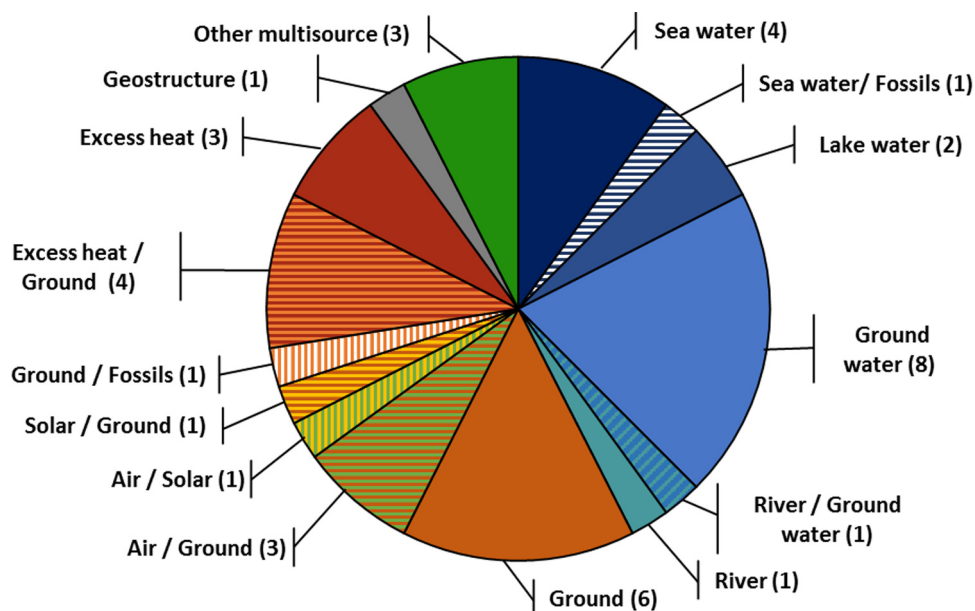

Fig. 4. Surveyed 5GDHC case studies by source.

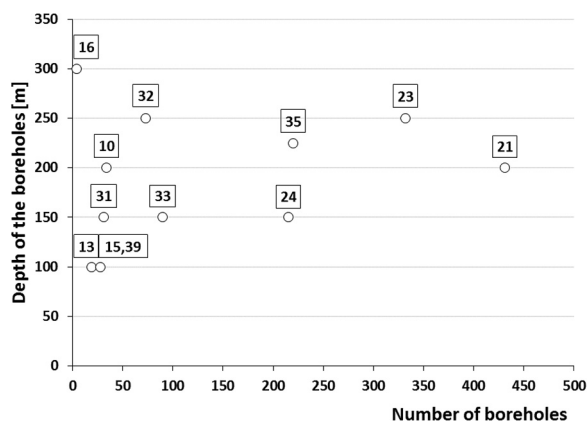

Fig. 5. Features of the BTES of the surveyed 5GDHC networks classified via ID number.

foreseen to integrate low-temperature excess heat sources in the 5GDHC systems of Ospitaletto (Italy), Wüstenrot (Germany) and Herleen (The Netherlands).

3.2.5. Survey results for systems including borehole TES

Twelve of the surveyed systems include a borehole field with vertical HE that in general is exploited as a long-term source/sink (seasonal TES). The depth and number of boreholes of these case studies, identified via its own ID number, is plotted in Fig. 5. The depth is limited to 100–300 m whereas the number of boreholes exceeds 220 only for two very large systems in Zürich: the “Familienheim-Genossenschaft” district (332 boreholes) and the ETH Campus Höggerberg (431 boreholes). No information has been found about the seasonal TES of the systems in the “Stiegelpotte” area in Spenge and in the “Berender Redder” area in Schleswig (Germany). The optimum choice between depth and number of boreholes to minimize mainly the drilling costs depends on the thermal and geological features of the soil in each place so that a general rule is difficult to be estimated.

Only two 5GDHC systems that exploit the ground as a source/sink via a horizontal HE have been encountered in the survey. The first is located in Nümbrecht (Germany) and supplies 13 residential buildings via a horizontal HE that is buried at a depth of $1.5 \div 2$ m along 450 m of streets. The total length of the DN65 polyethylene pipes is about 1200 m. Moreover, the integration of heat from a centralised solar thermal plant (43 m^2 of evacuated tube collectors) and rainwater cisterns to avoid source depletion is included. The second system is located in Wüstenrot (Germany), where the local community is expected to become energy independent by 2020 with the exploitation of renewable sources. This system consists of a group of DN40 polyethylene pipes connected in parallel, buried at a depth of 2 m in 1.5 ha of an agricultural land (agrothermal collector). In this way, the land can be used twice: since this depth is lower than the processing depth of agricultural machinery, the soil remains unrestricted for arable farming after laying the pipelines. The closed-loop thermal grid supplies 25 low-energy residential buildings ($55 \text{ kWh/m}^2 \text{ y}$) since 2012. Moreover, in some buildings of Wüstenrot, PV fields with a size between 7 and 10 kW are installed to compensate for the electricity demand of HPs [85]. This 5GDHC system is still under development: it is foreseen to recover the excess heat from a supermarket and from the sewer via the thermal grid. Demand Response strategies will be implemented within the H2020 project Sim4Blocks [86] optimising the WSHPs and electrical storage operation. The effects of the different depth of buried distribution pipes and centralised horizontal HE on HP pool performance in 5GDHC systems can be expected very close to the one experimented by Esen et al. for a single GSHP during the heating [71] and cooling season [19]: the higher the depth of the horizontal HE the higher both the capacity and COP/EER of the GSHP.

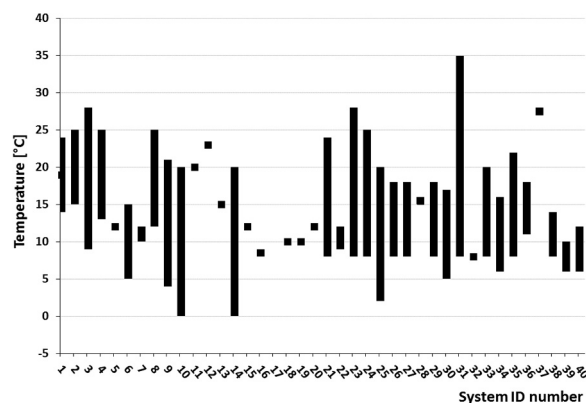

Fig. 6. Supply temperature variation of the network for the surveyed 5GDHC systems.

3.2.6. Survey results by supply temperature of the network

The supply temperature variation of the network of the surveyed 5GDHC systems is shown in Fig. 6. Actually, for some of the surveyed systems, only the average annual temperature is available. In most cases, the network temperature depends on the nature of thermal sources and on the domination between the heating and cooling loads.

It can be noticed that systems that exploit seawater (ID number 1, 2, 3, 30, 40) have a variation within 10°C . Only the 5GDHC system in “Porto piccolo Sistiana” (Italy), that exploits seawater, operates within a larger range which is between 9°C and 28°C . The reason could be due to the high cooling load of the building portfolio that includes 2 hotels, 32 commercial buildings and 456 residential units that are mainly used as a vacation home during summer.

The 5GDHC systems that exploit ground water as a thermal source (ID number 4, 5, 7, 18, 19, 22, 26 and 27) operate within a narrower temperature range than the ones that exploit the sea as a thermal source. In particular, this variation is limited from 2°C to 10°C . The higher variation is expected in aquifers with low hydraulic conductivity so that they are the most suitable to be operated as seasonal TES. Also, the surveyed 5GDHC networks supplied by thermal energy directly from a river or a geostructure (ID number 17 and 28) have a temperature variation limited to 2°C . The average temperature of the system connected to the “Furkatunnel” in Oberwald (Switzerland) is 5°C higher than the system supplied by water from the river Weser in Ohrberg (Germany).

The 5GDHC systems that exploit industrial excess heat sources without seasonal TES (ID number 8, 12 and 29) have an average supply temperature between 13 and 20°C . Maximum values can reach 25°C in Aurich whereas a minimum value of 8°C is obtained at the 5GDHC system in Visp.

All surveyed closed-loop systems that can reach very low temperature (less than 4°C) operate with a brine mixture. The 5GDHC system located in Fischerbach (ID number 14), which includes an ice storage, operates between the range of $0 \div 25^\circ\text{C}$ while the two 5GDHC systems located in Wüstenrot and Nümbrecht (ID number 6, 9), that exploit shallow geothermal source via horizontal HEs, work at a temperature limited to $5 \div 15^\circ\text{C}$ and $-5 \div 20^\circ\text{C}$, respectively.

A large temperature variation occurs also in 5GDHC closed-loop systems that are coupled with borehole TES (ID number 10, 13, 16, 20, 21, 23, 24, 31, 32, 33, 35, 39). The maximum variation of 27°C has been obtained at the system that supplies the REKA village in Blatten-Belalp that operates between $8 \div 35^\circ\text{C}$. The large cooling loads of the structure, which is a holiday village, could lead to the so high temperature of the network.

To understand in depth the behaviour of a 5GDHC network, the seasonal temperature variation profiles of the warm and cold pipelines of the Richti-Wallisellen 5GDHC system (ID number 35) are presented in Fig. 7. The system, supplied by excess heat from a datacenter and

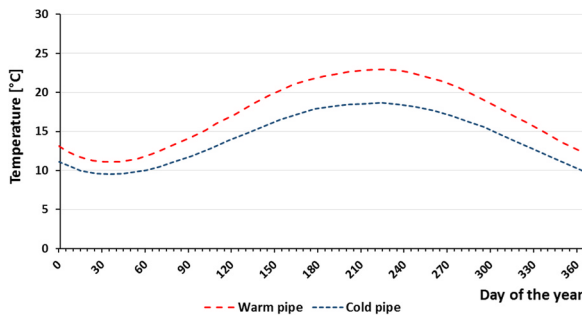

Fig. 7. Seasonal temperature variation of the warm and cold pipes in a ground coupled by-directional 5GDHC system.

Data source [72].

chillers, operates in a closed loop and exploits a borehole TES with 220 boreholes, 225 m depth. The peculiarity of this system, together with the 5GDHC networks in Heerlen, is the bi-directionality of both the network and substations. Thus, if excess heat is rejected the return flow at higher temperature goes to the warm pipe whereas if heat is extracted the return flow at a lower temperature goes to the cold pipe. In this way, the loss of exergy due to the fluid mixing at a different temperature is avoided.

The plot of measured data reported in [72] describes the typical passive operation of 5GDHC networks that operate in a closed loop. Contrarily from traditional DHC networks, where the supply temperature control is applied to maintain the supply temperature almost constant with a dependence on the external temperature, this kind of thermal networks leads the temperature of the network to fluctuate freely. Two kinds of variations can be highlighted in the monitoring data reported in [72]. The daily variation in the summer period ($\sim 10^\circ\text{C}$) is about two times the one during the winter period ($\sim 5^\circ\text{C}$). Nevertheless, the highest variation has been measured during spring where the temperature of the warm pipeline had exceeded 40°C . Moreover, in some days the minimum value reaches 0°C . The second kind of variation is the seasonal one shown in Fig. 7 that is related to the different share of the heating and cooling loads. Moreover, the difference between the temperature of the warm and cold pipeline change along the year so that in summer it results about two times the values in winter.

The absence of the supply temperature control causes to reach a minimum average temperature at the beginning of February and a maximum one at the end of July. This is a result of the domination of the heating loads on the cooling loads and vice versa. It results in opposition from the optimum operation to reach the highest seasonal performance of the HP pool. To minimize the electric consumptions of the substations, the system should be operated to maintain the highest supply temperature of the warm pipeline during winter, when the heating operation is dominant, and the lowest supply temperature from the cold pipeline when the cooling operation is dominant.

3.2.7. Survey results by seasonal performance

Similarly, in Fig. 8 the SCOP of 24 of the surveyed systems is shown. In some cases the reported SCOP results from monitoring data but in other cases, only the information in design condition has been encountered. The averaged value has been plotted when a range of the SCOP was available. It should be assessed as the ratio between the aggregated heat supplied for SH and DHW production of all the substations and the total electrical consumptions (including the pumping energy and the electrical consumptions of the HP pool). The SCOP of the surveyed systems ranges between 3 and 5. For 17 of the 24 systems considered, the SCOP reaches a value equal to or higher than 4. The maximum values are achieved at the 5GDHC in Ohrberg (ID number 17) and at the ETH campus Honggerberg in Zurich (ID number 21). Very few information has been encountered for the cooling operation.

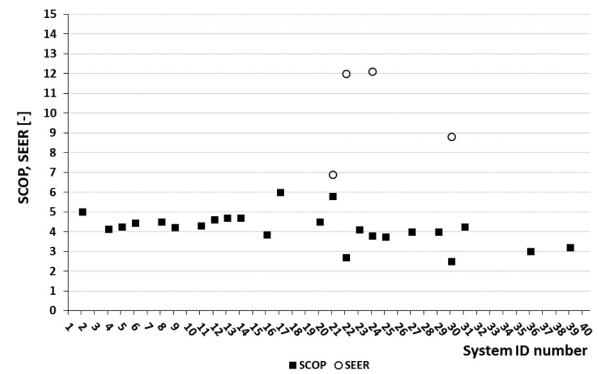

Fig. 8. SCOP and SEER for the surveyed 5GDHC systems.

Analogous to the SCOP, the SEER is defined as the ratio between the aggregated cooling load supplied (via both active cooling and free-cooling) and the total electrical consumptions. For the ETH campus Honggerberg a value of the SEER equal to 6.9 has been assessed while a value of 8.8 has been calculated from the monitoring data of 2016 for the Geneve-Lac-Nations 5GDHC system (ID number 30). In the 5GDHC systems of “Jardins de la Pala” (ID number 22) and “Surstoffi” (ID number 24), a value of about 12 has been calculated from the monitoring data of 2016 [37]. This high value can be achieved by the system due to the contribution of free-cooling operation.

3.2.8. Survey results by installed capacity and linear heating power demand density

Fig. 9 shows the installed thermal power capacity for heating of 28 of the surveyed systems. When the information was not available it has been assessed as the aggregated capacity of the HP pool. For 16 of these systems whose information about the network length was available, the Linear Heating Power Demand Density (LHPDD) has been calculated as the ratio between the installed thermal power capacity and the network length.

As it can be seen, the existing 5GDHC systems have a very small thermal capacity that is equivalent to a “district” size. In fact, 71% of these systems have an installed thermal capacity less than 3 MW. The biggest system has a size of 10 MW and supplies both residential and tertiary buildings in La Tour-de-Peilz (Switzerland) by exploiting the thermal energy from the Lake Geneva [37].

As far as the LHPDD is concerned, interesting information can be extrapolated from Fig. 10. The assessment of the LHPDD is useful in the decision-making process of building a new DH infrastructure. Pol and Schmidt report a LHPDD threshold value of 1.2 kW/m for traditional DH systems [73]. Traditional DH infrastructures with LHPDD values below this threshold are unfeasible from an economic point of view. Considering the 16 5GDHC systems analysed, the average LHPDD results in 1.5 kW/m . Nevertheless, 9 systems out of 16 have a LHPDD value lower than the threshold reported above. Detailed economic assessments are needed to assess the minimum threshold of the LHPDD that makes a 5GDHC network economically feasible.

3.2.9. Investigation of the “prosumers” substations

The thermal energy supplied by 5GDHC networks is not at a suitable temperature to be used directly in order to cover the SH and DHW demand of buildings. Thus, at the “prosumer” substations a Water Source Heat Pump (WSHP) is always needed to boost the supply temperature at a value suitable for heat distribution and use. The term “prosumer” has been adopted since, in theory, each customer can operate as a “consumer” or a “producer” of thermal energy towards the network. By inverting the thermodynamic cycle of the WSHP, the 5GDHC substation is able to cover both the heating and cooling demand of a building. In the surveyed case studies, only the installation of Electrical Driven Heat Pumps (EDHPs) has been encountered. In

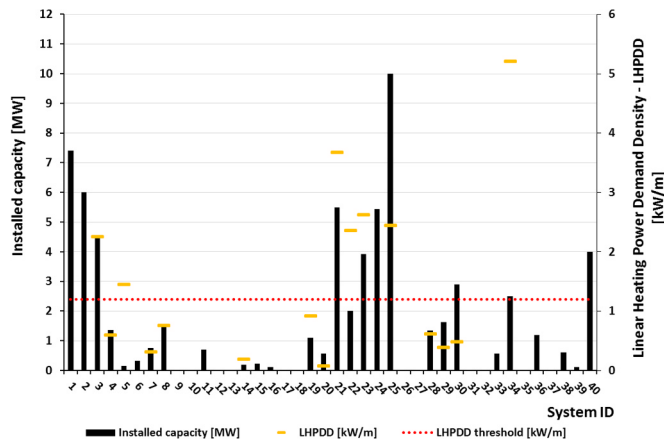

Fig. 9. Installed capacity and LHPDD for some of the surveyed 5GDHC systems.

general, the compressor in EDHPs is controlled in ON-OFF mode or with a continuous modulation by adopting an inverter to modify the rotation speed of the driving motor. Nevertheless, the adoption of HPs driven by natural gas can be interesting in cases of buildings refurbishment, where the gas network is already installed, creating a decentralised integration between the thermal, and gas grid.

A DHW TES is typically used to store the thermal energy at a suitable temperature for the user comfort allowing the shift in time between heat production periods and heat utilisation periods and to size the HP at a smaller capacity than the maximum DHW load. Nevertheless, it also causes thermal losses and high specific costs for kWh stored with respect to centralised short-term tank TES typical of traditional DHC systems. Moreover, a buffer tank is needed in ON-OFF controlled HPs to compensate the transients of space heating/cooling loads so that the stress for intermittent operation is minimised. The buffer tank can be connected to the WSHP in several ways.

Different versions of building “prosumers” substations have been encountered in the survey. The simplest configuration includes only the WSHP and can be derived from the particular configurations shown in Fig. 10. The first distinction that can be made is between substations A and B versus substation C. The first group includes a two-way valve on

the primary circuit of the WSHP (network side) to limit and control the circulation of the medium in *bidirectional energy flow – directional medium flow* 5GDHC networks whereas the second group contains a hydraulic pump for the installation in *bidirectional energy flow – non-directional medium flow* 5GDHC networks. In the following, the substations showed in Fig. 10 are described highlighting the role of auxiliary components in substation connection and operation.

Substation A is the simplest solution because contains the direct connection of the WSHP to the network for active heating/cooling. Moreover, two 3-way diverter valves allow the connection with a heat exchanger, installed in parallel with the WSHP, for free-cooling operation. As far as it concerns the refurbishment of the building portfolio with high heating demand containing an existing fuel-based heating system or in very cold climates, the WSHP can be coupled with a backup unit to operate in bivalent mode. In particular, in some cases, the backup unit operates in series to lift the supply temperature from the WSHP especially for DHW production or when a high-temperature water distribution is needed. This permits to operate the WSHP with a lower supply temperature and to increment its own COP. The substation of kind A has been installed after the refurbishment exploiting a small 5GDHC system at the University of Bergen (Norway) [74]. The 5GDHC operator of the network that supplies the “Hochvogelstraße” area in Biberach suggests a direct connection of the WSHPs to the network with a minimum return temperature of $-3\text{ }^{\circ}\text{C}$ [75].

Substation B is more complicated because in some cases the same free-cooling HE or a redundant HE is installed between the WSHP and the network to protect the WSHP from fouling risks. Nevertheless, it increments costs and thermodynamic irreversibilities. Since a temperature difference is needed to exchange heat through the HE both in heating and cooling modes, the intermediary circuit between the WSHP and the redundant HE will operate at a temperature lower and higher than the network one, respectively. This penalises the WSHP performances. The network manager of the 5GDHC system in Chur (Switzerland) indicates in the technical regulations to install the intermediate circuit as optional [76] whereas the 5GDHC operators in Sedrun, Saas Fee (Switzerland) and Troisdorf (Germany) obligate the customer to install a redundant HE. In these cases, it can separate both the WSHP and the free-cooling HE from the network [77–79].

Substation C is the most advanced solution. It includes a couple of

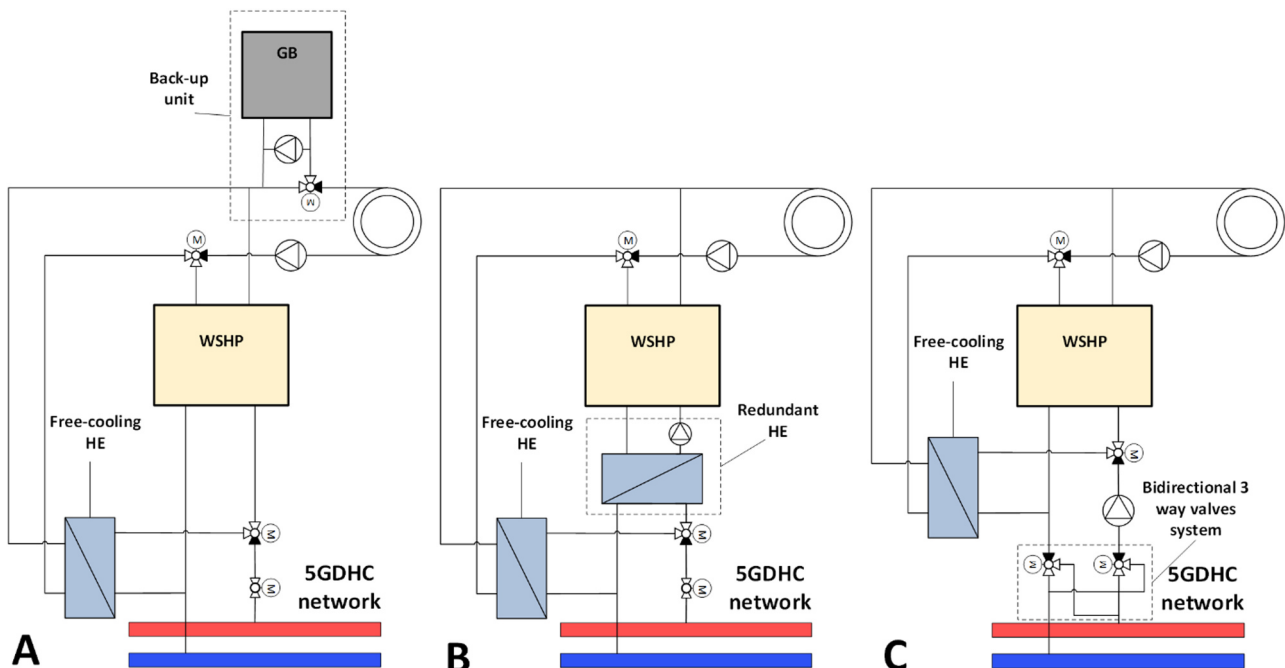

Fig. 10. Details of the “prosumer” substations adopted in some of the surveyed 5GDHC systems.

diverter valves on the primary side, installed between the hydraulic pump and the network. By means of suitable control rules, this system is able to reject separately hot water (in active or free cooling mode) in the warm pipeline and cold water (in heating mode) in the cold pipeline. This avoids thermal mixing within the network so that the exergy content of the medium is not lost. Therefore, the HP pool can operate with the most efficient boundary conditions. This kind of solution has been implemented in the 5GDHC of Herleen also to preserve the exergy content of the water reservoirs. Here, the end-users are forced by contract to realise water in the cluster grid at a return temperature on the primary side, less than 15 °C in the cold pipeline and higher than 29 °C in the warm pipeline [41]. In a similar way, a bidirectional system is installed also at the Richti Wallisellen 5GDHC system [72].

4. Discussion

In the following, the most important information extracted from the surveyed systems is elaborated and discussed presenting the perspectives and challenges for the main stakeholders involved in the planning, design, and operation of 5GDHC systems.

4.1. Pumping energy and primary energy consumptions in 5GDHC systems

In traditional high temperature DH the relative importance of pumping consumptions ($RIE_{el,pump}$) defined as the ratio between the electricity consumptions for pumping and the heat delivered to the substations is about 0.5% [31]. In general, it is one order of magnitude less than relative distribution heat losses (5–15% of the supplied heat [31]) and should not be considered a loss because the pressure energy is converted into heat by friction inside the hydraulic circuits. In 5GDHC systems higher $RIE_{el,pump}$ are expected with respect to traditional DH networks mainly because of the low temperature difference between the supply and return flows and because of the adoption of brine as carrier medium where it occurs.

Few information has been found about monitored pumping power in the surveyed 5GDHC networks. For the system that supplies the “Familienheimgenossenschaft” area in Zürich (Switzerland), a numerical model of the network has been implemented in Polisun in [80] to use dynamic simulations for the prediction of the network pumping energy consumption. The measured value of pumping energy consumption during the winter season result of about the 1.6% of the thermal energy supplied to the evaporator of the different decentralised WSHPs [24]. From the monitoring data of 2017 the pump electricity consumptions result in 125 MWh/a corresponding to a value of 2.7% of $RIE_{el,pum}$ [37].

Prasanna et al. [30] analyse the monitoring data from the 5GDHC network of the “Surstoffi” district in Risch Rotkreuz (Switzerland). They found a huge gap between monitored electricity consumptions and the design ones. The total electricity consumption of network pumps between 2013 and 2014 resulted equal to the 3.2% of the thermal energy supplied to the HP pool. The last analysis from the monitoring data of 2015–2016 published in [27] shows that for the circulating pumps of two building sites the measured values result about the 85% and 233% higher than the design ones. The main reason is that the control of the decentralised hydraulic pumps is not optimised so that they are always in operation although the WSHPs are not running. The multi-energy optimization study performed on the “Surstoffi” system [30] shows that the pumping electricity consumption has been measured equal to about 16% of the overall electricity consumptions. Looking at the overall yearly electrical energy balance, only 29% of electricity comes from the grid while the 71% is produced on-site thanks to the PV/PVT fields. Nevertheless, the results show that in the current system only 35% of the electricity production can be effectively matched with the on-site electricity consumptions of WSHPs and hydraulic pumps. This share can reach 77% by maximizing self-consumptions by means of the exploitation of batteries or local TES in buildings.

The monitored data of 2015 show that the electricity consumptions for the hydraulic pumps at the 5GDHC system of the ETH campus Höggerberg (Switzerland) result equal to the 3% of the heat demand. In particular, the SCOP and SEER considering only the HP pool and free-cooling operation results in 7.2 and 30.1, respectively. Taking into account the electricity consumptions for auxiliaries the SCOP and SEER of the system results in 5.8 and 6.9, respectively [37]. For the 5GDHC system in Bulle, the SCOP considering only the HP pool electricity consumption results in 4.1 for the monitoring data of 2016. Here the percentage in volume of glycol in the HP loop is 25%. Electricity pumping consumptions account about the 5% of the supplied thermal energy and cause a drop in the SCOP of the system up to 2.7 [37]. A SCOP equal to 4.4 has been assessed for the “Surstoffi” 5GDHC network considering only the HP pool electrical consumptions. It decreases up to 3.8 adding the electricity consumptions of the network hydraulic pumps and up to 2.7 if the electricity consumptions for auxiliaries on the building side are also considered [37].

Fischer et al. emphasise the utilisation of electric driven heat pumps (EDHP) to provide flexibility in balancing fluctuations in the power grid due to variable renewable energy generation from wind farms and photovoltaic (PV) fields [81]. This can be done also in 5GDHC systems where the own electricity consumptions from decentralised WSHPs and hydraulic pumps can be compensated with local electricity production from renewables thus additionally decreasing the non-renewable primary energy consumptions of such systems. In the survey, only the installation of solar photovoltaic energy conversion systems has been encountered for this purpose. In addition to the “Surstoffi” 5GDHC system, where both PV and PVT panels are installed, PV modules are integrated in the 5GDHC of Sale Marasino, Wüstenrot, Visp and Saas Fee, whereas PVT panels have been installed at the REKA village. Nevertheless, the management of these systems is still not optimised to maximise self-consumption of local electricity production.

For the “Surstoffi” 5GDHC system a specific primary energy consumption of 6.6 kWh/(m² a) and a specific CO₂ equivalent emission of 2 kg/(m² a) has been assessed from the monitoring data of 2016. For the “Familienheim-Genossenschaft” system the same performance indicators result equal to 192 kWh/(m² a) and 41 kg/(m² a), respectively [37]. For the 5GDHC system of Schleswiger (Germany) the certified Primary Energy Factor (PEF) assessed in agreement with the German standard AGFW FW309 has been found. It results equal to 0.46 [82]. It means that for covering 1 kWh of the heating or cooling demand the system exploits 0.46 kWh of non-renewable primary energy. For the 5GDHC system of Troisdorf (Germany) the certified Primary Energy Factor (PEF) has been assessed as equal to 0.06 [83]. Neglecting the electrical consumptions for auxiliaries and thermal losses, these values represent a reduction of 58% and 95%, respectively, of non-renewable primary energy with respect to a natural gas-fired DH network (PEF of natural gas 1.1).

Finally, as Prasanna et al. [30] have highlighted, in current energy certification protocols of buildings and districts only the yearly energy balances are taken into account, evaluating at the same level the electricity contribution from renewables if it is exchanged with the grid or if it is self-consumed. Therefore, the protocols for this kind of assessments should be revised to reward the short term matching in local thermal and electrical energy production and consumption.

4.2. Basic and advanced control strategies for 5GDHC network operators

In 5GDHC networks, basic control strategies can differ from traditional high-temperature DH. In particular, differential pressure control and supply temperature control, that in general are implemented at the heat supply units in traditional DH, can be absent in 5GDHC systems. In particular, the supply temperature is strongly dependent on the source in open-loop systems whereas in closed loop systems it is let to fluctuate freely with a dependence on the domination between the heating and cooling loads. Only in *bidirectional energy flow – directional medium flow*

5GDHC networks differential pressure control is realised with centralised pumping stations. In other cases, the amount and direction of the flow in the main branches of the network is a result of the interactions among the different decentralised pumps of the substations.

In the Minewater project, as well as in Wüstenrot and in the “Familienheimgenossenschaft” district in Zürich the flow control in the cluster grid is fulfilled by the decentralised circulation pumps at each substation without the need of a centralised pumping station. In the Minewater project, additional booster pumps are located in the connection node with a cluster grid or at the wells and are installed on the mine water backbone side [84].

If excess heat recovery services occur, some requirements must be satisfied on the customer side that could interfere with the needs of the others. Some problems of this kind occurred at the “Familienheimgenossenschaft” 5GDHC system in Zürich [24] that includes transmission pipelines of 400–500 mm of diameter and operates at temperature and pressure between 8 and 25 °C and 4–11 bar, respectively [67]. Moreover, the system includes also a seasonal BTES with 153 boreholes of 250m deep. Here an HE is installed for direct heat recovery from a data center. In this production substation, the hydraulic pumps on the primary side are controlled to assure a fixed return temperature to the cooling system of a data center (secondary side of the HE) while the temperature difference on the primary side is let to fluctuate. Differently, at the customer substations that include the HPs, the hydraulic pump is controlled to maintain a fixed differential temperature on the primary side [24]. The system is connected so that when a mismatch of the flow rates between producers and consumers occurs, the surplus flow rate goes throughout the borehole TES to charge/discharge it [26]. Monitoring data show a limitation of the system that is a result of the not bi-directional feature of the substations. In particular, the warm pipe in summer reaches about 30 °C after the heat rejection point of the data center and does not permit to use the network for free-cooling purposes at the downstream substations [25]. Since active cooling in residential buildings is forbidden in Switzerland this restraint is significant. Thus, it is very important to identify how much the optimal operation of a single unit disagrees with the optimal operation of the global system.

Seasonal TES can be crucial for 5GDHC networks because allow counterbalancing possible mismatches between the heating and cooling demands of the system that occur both on short and long terms. Moreover, it can be used as a buffer during the network development that can last several years. Nevertheless, in some cases, mainly because of the variation of climatic conditions and buildings loads, the real operation of 5GDHC systems coupled with seasonal TES can be far from the design conditions causing malfunctioning and deterioration of the performance of the entire HP pool. The introduction of reparative unforeseen measures with additional costs can lead to complaints from users and changes in their perception about DHC systems. Problems of this kind have occurred in the 5GDHC system supplying the “Surstoffi” district in Risch Rotkreuz (Switzerland). It is in operation since 2012 and has been monitored by researchers from the Lucerne University for Applied Sciences [27]. They have developed a numerical model for a two-pipe network with bi-directional mass flow direction in the simulation environment IDA-ICE [85]. In this system, the excess heat from building free-cooling and the heat produced by the PV/T panels are used to regenerate the two seasonal TES of 180 boreholes. The underestimation of the heating demand has affected the performance of the borehole TES that showed a cooling tendency. The monitoring results show that the real heat demand was about 2.5 times the design one during the winter season 2013–2014. This because a big part of the building stock was conditioned with an indoor temperature higher than 22 °C and with an air flow rate 33% higher than the design one as confirmed from both measured and simulation data. To avoid the network undercooling a pellet boiler was installed as a temporary solution until the PV/T field became operational in 2014 as a long-term measure. Moreover, additional heat extraction from the network has been

avoided by installing electric heaters to assist the DHW production [28].

As far as it concerns advanced control strategies in 5GDHC systems very few have been encountered in the literature. Some development about heat demand forecasting and optimization for the 5GDHC of Heerlen are expected within the H2020 project Storm [84] while the application of demand response techniques in the 5GDHC systems of Naters and Wüstenrot will be developed within the Sim4Blocks project [86]. Within the H2020 Flexynets project [56], Vivian et al. [87] compared an advanced control strategy based on Mixed Integer Linear Programming (MILP) optimization technique with a basic deterministic control strategy for a virtual 5GDHC case study located in Aarhus. The results showed an 11% saving in operational costs during the simulated period thanks to the advanced control. Bünning et al. [58] introduced the concept of agent-based control to coordinate several prosumers in 5GDHC systems. In particular, the simulation results show the ability of the control to maintain the average temperature of the system within 2 K around the set point by exploiting the coordinated balancing effects of several decentralised units. This solution results advantageous in comparison with the free-floating temperature approach in both unidirectional and bidirectional 5GDHC cases. Furthermore, Bünning et al. compared the agent-based controlled bidirectional 5GDHC system with a gas-fired traditional DH and individual chillers solution to supply the same heating and cooling demands in two districts located in San Francisco and Cologne. The very promising results show that the advanced controlled 5GDHC system permits, for the two considered case studies, to reach a reduction in primary energy consumptions of 58% and 84%, a reduction of CO₂ emission of 35% and 78% and a saving in the energy costs of 53% and 57%, respectively.

4.3. Tariff and price strategies for 5GDHC networks

Since 5GDHC substations include WSHPs, the energy costs for the 5GDHC final user should combine both thermal energy and electricity costs. Nevertheless, 5GDHC systems launch new business models for DHC operators since there is the possibility to supply both heating and cooling services or to take into account in a unified bill both thermal energy and electricity consumption of the substation. Extreme cases can be also conceived where an active 5GDHC prosumer takes profit by selling the excess heat to the 5GDHC manager or where a 5GDHC manager operates the substation portfolio in a Virtual Power Plant to sell ancillary services into the electrical market.

The natural monopoly of DH networks leads usually the final user to be locked to the heat supplier without the possibility to switch as it occurs in the electricity and gas liberalised markets. Moreover, the low transparency in the heat price could compromise the confidence and trust of the customers in the DHC technology. Someone complains the lack of regulation of the DHC sector [88]. Nevertheless, a regulation of the price could negatively affect consumers. For instance, in some countries where the DH price is regulated (Denmark), it results higher than in other countries where it is unregulated (Sweden, Norway, Germany) [89]. In the latter cases, the DH price is generally built conforming to the No-More-Than-Otherwise principle that is to say based on competition with alternative solutions. Usually, it is referred somehow to the average gas price assuming decentralised gas boilers as alternative solution.

As stated in this study, 5GDHC networks are distinguished by a small-scale nature, supplying fossil-independent communities. Here, the application of the No-More-Than-Otherwise principle, by linking the heat price to the average gas price could cause a lack of customer confidence. On the contrary, transparent mechanisms together with heat metering, access to information and fair prices can boost customer confidence and their awareness of energy use. Moreover, Energy Performance Contracting (EPC) could be implemented by ESCOs as well as Energy-as-a-Service (EaaS) business models. The latter could include, for instance, the supply and maintenance of the user substation and

should assure a high-performance operation of the system.

Among the surveyed 5GDHC systems, one interesting example comes from the one that supplies the “Jansenshuof” district in Leuven (Belgium). Here, the investor is an ESCO that is also responsible for the design, installation, management of the network and energy consumptions billing. The contract between the ESCO and the users limits the maximum costs to the ones equivalent to the use of individual gas boilers for heating purpose. Cooling represents a significant added value for the building owners and it is provided by the network operator for free. It is done to boost cooling use with the beneficial purpose of recharging the ATEs. The operation cost for the geothermal system is shared among the final users with a fixed contribution. Moreover, the individual costs are simply paid with the electricity invoice according to the distribution configuration. For each dwelling, the consumption of its own HP is accounted besides a share of the consumptions of the centralised HPs when installed [36].

The operator of the 5GDHC system located in Sedrun (Switzerland) leaves the investment and installation costs of the substation on the user and fixes the delivery limit on the primary side of the redundant HE. Moreover, the total costs include a one-time connection fee and a basic annual fee that are proportional to a reference volume flow rate of the substation. Moreover, a charge of CHF 0.32 per m³ of water is applied according to the actual consumptions (VAT excluded) [90]. Only the water consumptions are also metered at the 5GDHC of Chur [76] and in Troisdorf [79].

The manager of the 5GDHC system located in Biberach (Germany) supplies the heat to the substation with a charge of 0.0161 €/kWh (VAT included). The contract includes a one-time connection fee of about 4095€ and a subsidy for the 5GDHC system construction [91]. The latter is calculated in agreement with the installed capacity and can be paid through two contract models. The first model considers a 10 years contract and 70% of the construction cost subsidy charged to the client. The second model considers a 15 years contract and 100% of the construction cost subsidy charged to the client. The choice of the contract model affects the basic annual fee. For a maximum installed capacity of 10 kW, it results in 142.80 €/year for contract model 1 and in 39.27 €/year for contract model 2 (VAT included). The network manager assessed the specific cost for the useful heat (on the secondary side of the WSHP) for a typical single-family house of 130 m² and a heating load of 30 W/m², considering the connected capacity of 4.5 kW to the network and an electricity price of 0.19 €/kWh. This results in 0.1561 €/kWh for the contract model 1 and 0.0931 €/kWh for the contract model 2 [92]. At the 5GDHC system in Bulle (Switzerland) the heat consumptions are billed on the building side of the substation. Here the customer pays, beyond a fixed charge, a different tariff for the variable cost for covering the space heating and the DHW demands. It results of about 0.0585 CHF/kWh and 0.08 CHF/kWh, respectively.

Cozzini et al. [93] performed, by means of a top-down approach, a sensibility analysis for the assessment of the thermal energy prices as well as the network operator margins in a 5GDHC network. Here, the economic bound to have a total energy cost for the final user connected to a 5GDHC system equal to or less than the one of adopting a conventional heating and cooling system has been assumed in a northern Italy scenario. The results give a maximum price for the thermal energy supplied on the primary side of the 5GDHC substation equal to 0.080 €/kWh and 0.026 €/kWh for heating and cooling, respectively.

The investment cost is the main barrier for developing a sustainable 5GDHC system. Nevertheless, new business models offered by the network operator and the consumer engagement could help in overcoming it.

5. Conclusions

The present study reviewed the literature about 5GDHC systems. The knowledge about this new technology is not yet widespread,

besides a few companies, especially for applications that deviate from shallow geothermal systems. The definitions encountered in literature can lead to ambiguity compared with 4GDH systems. Thus, this work revises the nomenclature adopted in literature and suggests to adopt the unambiguous definition of Fifth-Generation District Heating and Cooling (5GDHC) for this type of technology.

The work describes drawbacks and benefits of the 5GDHC technology assessed by means of a SWOT analysis. Moreover, a statistical analysis of 40 existing 5GDHC systems in Europe has been presented. The results show the increment in installations in the last years, especially in Switzerland and Germany, and the typical district-scale of such systems. Moreover, the surveyed systems have been classified in agreement with the different thermal energy sources exploited and the concept adopted for the seasonal thermal energy storage regeneration. Exploitation of shallow geothermal fields coupled with renewable heat sources (air, solar, hydrothermal, etc.) has been encountered in several cases. Excess heat from data centers is recovered in some applications in Switzerland while some 5GDHC systems are supplied by the excess heat from dairies and weaving mills in Germany. Even though some system concepts look similar, the exploitation of local sources makes each case unique.

The temperature range of the exploited sources varies from a minimum of −5 °C to a maximum of 35 °C. Higher variations occur in closed loop systems that exploit borehole TES. Due to the seasonal variation of the loads and the absence of a supply temperature control the temperature of the network can float freely. Few is the information available about the cooling operation, while for the majority of the surveyed systems a seasonal COP higher than 4 has been encountered with maximum values up to 6.

Finally, several challenges have been addressed concerning the main stakeholders involved in 5GDHC projects, taking inspiration from the information available from the survey. There are not guidelines for 5GDHC designers and planners. Since complex neighbourhood-based energy planning with a holistic approach is needed to develop net-zero energy districts, the absence of a local heat atlas makes it difficult to estimate local heat sources and sinks. New business models and tariff mechanisms can make 5GDHC feasible, mitigating the high investment costs and increasing people confidence in the DHC technology. Nevertheless, it is worth mentioning that a change in thinking should be made by both network operators and potential excess heat providers. The first should permit third party access to the network, whereas the second should start viewing their costs for heat rejection as potential revenues. Indeed, conversely from traditional DH, in 5GDHC networks, no heat pumps are needed in low-temperature excess heat recovery plants. This simplifies the recovery substation operation and reduces the economic risk for those actors whose core business is not heat supply. Thus, supermarkets and warehouses could play a crucial role in the development of new 5GDHC projects.

Very little has been done for the optimal control of 5GDHC systems. Bi-directionality of the energy flows and decentralization make it a hard task. Digitalization of the DHC sector together with the step forward in the information and communications technology to address decentralised interactions and transactions could push this new generation of DHC technology towards very high-level technological standards.

Acknowledgements

This work is part of the research activities of the project FLEXYNETS, funded by the European Union’s Horizon 2020 research and innovation programme under grant agreement No 649820.

The authors thank the Department of Innovation, Research and University of the Autonomous Province of Bozen/Bolzano for covering the Open Access publication costs.

COGEME S.p.A., Rovato (BS), Italy, is gratefully acknowledged for having shared some technical data.

Appendix

See Table 2

Table 2
List of the surveyed 5GDHC systems.

ID Nb	Location	Country	Operation start date	Heat source	Centralised TES	T _{supply,min} [°C]	T _{supply,max} [°C]	SCOP [-]	SEER [-]	Installed capacity [MW]	Network length [km]	LHPDD [kW/m]	References
1	"Complesso della Torre" district-Savona	Italy	2007	Sea water		14	24			7.4			[94]
2	"Arsenale nord" district - Venice	Italy	2013	Sea water/ Fossils		15	25	5		6			[95,96]
3	"Porto piccolo Sistiana" - Trieste	Italy	2014	Sea water		9	28	4.14		4.5	2	2.3	[97,98]
4	Ospitaletto	Italy	2018	Ground water		13	25	4.25		1.36	2.3	0.6	[99,100]
5	Sale Marasino	Italy	2014	Ground water	Tank TES	12	12	4.45		0.14	0.1	1.4	[101,102]
6	Wüstenrot	Germany	2012	Ground	Horizontal ground HE (agrothermal collector)	5	15			0.32			
7	"Neumatten" area in March-Hugstetten	Germany	2009	Ground water		10	12			0.76	2.5	0.3	[102–104]
8	Aurich	Germany	2010	Excess heat		12	25	4.5		1.5	2	0.8	[64,105]
9	"Sohnius-Weide" district in Nümbrecht	Germany	2017	Solar/Ground	Horizontal ground HE	4	21	4.23			0.45		[106–108]
10	"Hochvogelstraße" area in Biberach	Germany	2016	Ground	Vertical ground HE (34 boreholes 200 m depth)	0	20						[109,110]
11	"Stiegelpotte" area in Spenge	Germany	1994	Ground/ Fossils		20	20	4.3		0.7			[64,65,111,112]
12	"Sattlerweg" area in Herford	Germany	2000	Excess heat		23	23	4.6			0.7		[64,111,113]
13	"Obstanger" area in Herford	Germany	2000	Air/Ground	Vertical ground HE (19 boreholes 100 m depth)	15	15	4.7					[64]
14	"Karl-May-Weg" district in Fischerbach	Germany	2013	Air/Solar	ICE storage (320 m ³)	0	20	4.7		0.185	1	0.2	[114–117]
15	"Max-Ernst-Straße" area in Schifferstadt	Germany	2017	Ground	Vertical ground HE (28 boreholes 100 m depth)	12	12			0.23			[118–120]
16	"Küferweg" district in Mainz	Germany	2011	Ground	Vertical ground HE (4 boreholes 300 m depth)	8	9	3.85		0.112			[121–123]
17	Ohrberg	Germany	2001	River	Tank TES (400 l)	10	12	6					[68,124]
18	Troisdorf	Germany	2014	Ground water		10	10			1.1	5	0.9	[83,125,126]
19	Dorsten-Wulfen	Germany	1979	Ground water		10	10	4.5		0.572	1.2	0.1	[63,127]
20	"Berender Redder" area in Schleswig	Germany	2014	Excess heat/ Ground		12	12				7.5	0.1	[82,128]
21	ETH Campus Hänggerberg in Zürich	Switzerland	2013	Ground	3 Vertical ground HES (431 boreholes 200 m depth)	8	24	5.8	6.9	5.5	1.5	3.7	[37,52,129]
22	Jardins de la Pâla, Bulle	Switzerland	2012	Ground water		12	9	2.7	12	2	0.85	2.4	[37]
23	Familienheimgenossenschaft district in Zürich (FGZ)	Switzerland	2014	Excess heat/ Ground	2 Vertical ground HES (332 boreholes 250 m depth)	8	28	4.1		3.93	1.5	2.6	[24–26,37,51]

(continued on next page)

Table 2 (continued)

ID Nb	Location	Country	Operation start date	Heat source	Centralised TES	T _{supply,min} [°C]	T _{supply,max} [°C]	SCOP [-]	SEER [-]	Installed capacity [MW]	Network length [km]	LHPDD [kW/m]	References
24	Suurstoffi district-Risch Rotkreuz	Switzerland	2012	other multisource	Vertical ground HE (215 boreholes 150 m depth and 180 boreholes 280 m depth)	8	25	3.8	12.1	5.431			[27,28,30,37]
25	La Tour-de-Peilz	Switzerland	2015	Lake water		2	20	3.75		10	4.1	2.4	[37]
26	"Krommen Kelchbach" district in Naters	Switzerland	2013	Ground water		8	18						[130–132]
27	Brig-Glis	Switzerland	2009	Ground water		8	18	4					[130–132]
28	Oberwald/Obergoms	Switzerland	1994	Geostructure		15	16			1.337	2.2	0.6	[132–135]
29	"Visp-West" district - Visp	Switzerland	2008	Excess heat		8	18	4		1.624	4.2	0.4	[37,136–138]
30	Genève-Lac-Nations	Switzerland	2008	Lake water		5	17	2.5	8.8	2.9	6	0.5	[37,139]
31	REKA village, Blatten-Belalp	Switzerland	2014	Other multisource	Vertical ground HE (31 borehole 150 m depth)	8	35	4.24					[130,140]
32	"Sedrun" district in Tujetsch	Switzerland	2017	Air/Ground	Vertical ground HE (73 Bohrehole 250 m depth)	8	8						[77,90,141]
33	Saas Fee	Switzerland	2015	Air/Ground	Vertical ground HE (90 Bohrehole 150 m depth), Tank TES	8	20			0.56			[130,132,142]
34	"Rheinfels/Kleinbruggen" district in Chur	Switzerland	2013	Other multisource		6	16			2.5	0.48	5.2	[70,76,143,144]
35	Richti Wallisellen	Switzerland	2014	Excess heat/Ground	Vertical ground HE (220 Bohrehole 225 m depth)	8	22						[72]
36	Duindorp -The Hague	The Netherlands	2009	Sea water		11	18						[40]
37	Herleen	The Netherlands	2008	Excess heat/Ground		27	28						[41]
38	Jansenushof project - Leuven	Belgium	2017	River/Ground water	Aquifer TES	8	14			0.6			[36]
39	Brooke Street - Derby	England	2012	Ground	Vertical ground HE (28 Bohrehole 100 m depth)	6	10	3.2		0.12			[40]
40	University of Bergen	Norway	1995	Sea water		6	12			4			[74]

References

- [1] Pachauri RK et al., Climate change 2014: Synthesis Report. Contribution of Working Groups I, II and III to the Fifth Assessment Report of the Intergovernmental Panel on Climate Change. Geneva; 2014.
- [2] European Commission, Communication from the Commission to the European Parliament and the Council, European Energy Security Strategy. Brussels; 2014.
- [3] United Nations, Department of economic and social affairs, Population division. World urbanization prospects: the 2014 Revision, (ST/ESA/SER.A/366). New York; 2015.
- [4] European Commission, Communication from the Commission to the European Parliament, the Council, the European Economic and Social Committee and the Committee of the Regions. Closing the loop - An EU action plan for the Circular Economy. Brussels; 2015.
- [5] European Commission. Joint Research Centre, and European Technology Platform on Renewable Heating and Cooling (RHC-Platform), 2020–2030–2050, common vision for the renewable heating and cooling sector in Europe: European technology platform on renewable heating and cooling. Luxembourg: EUR-OP; 2011.
- [6] Directive 2010/31/EU of the European Parliament and of the Council of 19 May 2010 on the energy performance of buildings (recast). Brussels: Official Journal of the European Union; 2010.
- [7] Directive 2012/27/EU of the European Parliament and of the Council of 25 October 2012 on energy efficiency Brussels: Official Journal of the European Union; 2012.
- [8] Pezzutto S, Fazeli R, De Felice M, Sparber W. Future development of the air-conditioning market in Europe: an outlook until 2020. *Wiley Interdiscip Rev Energy Environ* 2016;5(6):649–69.
- [9] Rezaie B, Rosen MA. District heating and cooling: review of technology and potential enhancements. *Appl Energy* 2012;93:2–10.
- [10] International Energy Agency. Linking heat and electricity systems: co-generation and district heating and cooling solutions for a clean energy future. Paris, France; 2014.
- [11] Werner S, Wiltshire R, Svendsen S, Thorsen JE, Hvelplund F, Mathiesen BV. 4th Generation district heating (4GDH). *Energy* 2014;68:1–11.
- [12] Euroheat & Power. Country by Country Survey. Brussels; 2017.
- [13] DHC+ Technology Platform. District heating & cooling: a vision towards 2020–2030–2050. Brussels; 2012.
- [14] RESCUE project. [Online]. Available: <<http://www.rescue-project.eu>>.
- [15] Prando D, Prada A, Ochs F, Gasparella A, Baratieri M. Analysis of the energy and economic impact of cost-optimal buildings refurbishment on district heating systems. *Sci Technol Built Environ* . 2015;21(6):876–91.
- [16] Stănișteanu C. Smart thermal grids – a review. *Sci Bull Electr Eng Fac* 2017;0(0).
- [17] Lund H, Østergaard PA, Connolly D, Mathiesen BV. Smart energy and smart energy systems. *Energy* 2017;137:556–65.
- [18] Fedrizzi R et al., FP7 INSPIRE Project D6.3c - Performance of the Studied Systemic Renovation Packages – Multifamily House; 2015.
- [19] Esen H, Inalli M, Esen M. A techno-economic comparison of ground-coupled and air-coupled heat pump system for space cooling. *Build Environ* 2007;42(5):1955–65.
- [20] Li R, Ooka R, Shukuya M. Theoretical analysis on ground source heat pump and air source heat pump systems by the concepts of cool and warm exergy. *Energy Build* 2014;75:447–55.
- [21] Bünning F, Wetter M, Fuchs M, Müller D. Bidirectional low temperature district energy systems with agent-based control: performance comparison and operation optimization. *Appl Energy* 2018;209:502–15.
- [22] Pellegrini M, Bianchini A. The innovative concept of cold district heating networks: a literature review. *Energies* 2018;11(1):236.
- [23] Werner S. International review of district heating and cooling. *Energy* 2017;137:617–31.
- [24] Ruesch F, Rommel M, Scherer J. Pumping power prediction in low temperature district heating networks. In: Proceedings of International Conference CISBAT 2015, LESO-PB, EPFL, Lausanne; 2015. p. 753–758.
- [25] Ruesch F, Haller M. Potential and limitations of using low-temperature district heating and cooling networks for direct cooling of buildings. In: Proceedings of International Conference CISBAT 2017, Energy Procedia (122) 2017 1099–1104.
- [26] Ruesch F, Rommel M, Kolb M, Gautschi T. Heat and cold supply for neighborhoods by means of seasonal storages and low temperature energetic cross linking. In: Proceedings of International Conference CISBAT 2013, LESO-PB, EPFL, Lausanne; vol. 2, 2013, p. 835–840.
- [27] Vetterli N, Sulzer N, Menti UP. Energy monitoring of a low temperature heating and cooling district network. In: Proceedings of International Conference CISBAT 2017, Energy Procedia (122) 2017 62–67.
- [28] Vetterli N, Sulzer M. Dynamic analysis of the low-temperature district network Suurstoffi through monitoring. In: Proceedings of International Conference CISBAT 2015, LESO-PB, EPFL, Lausanne; 2015, p. 517–522.
- [29] Stübler A, Bestenlehner D, Drück H. Energy saving potentials of cold district heating networks. In: Proceedings of the 17th EWA symposium during IFAT 2014, Munich; 2014.
- [30] Prasanna A, Dorer V, Vetterli N. Optimisation of a district energy system with a low temperature network. *Energy* 2017;137:632–48.
- [31] Frederiksen S, Werner S. District heating and cooling. Lund: Studentlitteratur; 2014.
- [32] Chen S, Liu C-C. From demand response to transactive energy: state of the art. *J Mod Power Syst Clean Energy* 2017;5(1):10–9.
- [33] Mengelkamp E, Gärtner J, Rock K, Kessler S, Orsini L, Weinhardt C. Designing microgrid energy markets. *Appl Energy* 2018;210:870–80.
- [34] Buonmano A, Calise F, Palombo A. Buildings dynamic simulation: water loop heat pump systems analysis for European climates. *Appl Energy* 2012;91(1):222–34.
- [35] Bachmann M, Kriegl M. Feasibility study of a multilevel district heating grid with dissolved supply and return using Modelica. In: Proceedings of the CESBP central european symposium on building physics/BauSim 2016, Dresden; 2016.
- [36] Pattijn IrP, Baumans A. Fifth-generation thermal grids and heat pumps: a pilot project in Leuven, Belgium. *Heat Pump Technol* 2017;35/2.
- [37] EnergieShweiz, Fallbeispiele „Thermische Netze, Ittigen; 2017.
- [38] Buffa S, Cozzini M, Henze GP, Djpasquale C, Baratieri M, Fedrizzi R. Potential study on demand side management in district heating and cooling networks with decentralised heat pumps. In: Proceedings of ISEC 2018 International Sustainable Energy Conference, Graz; 2018.
- [39] Solar District Heating. [Online]. Available: <<http://solar-district-heating.eu/>>. [Accessed 12 April 2017].
- [40] Foster S, Love J, Walker I, Crane M. Heat Pumps in District Heating: Case Studies. London: Department of Energy & Climate Change, UK Government; 2016.
- [41] Verhoeven R, et al. Minewater 2.0 project in Heerlen the Netherlands: transformation of a geothermal mine water pilot project into a full scale hybrid sustainable energy infrastructure for heating and cooling. *Energy Procedia* 2014;46:58–67.
- [42] International Agreements: Council Decision (EU) 2017/1541 of 17 July 2017 on the conclusion, on behalf of the European Union, of the Kigali Amendment to the Montreal Protocol on substances that deplete the ozone layer. The Council of the European Union, Brussels; 2017.
- [43] Regulation (EC) No 842/2006 of the European Parliament and of the Council of 17 May 2006 on certain fluorinated greenhouse gases, The European Parliament and of the Council of the European Union, Brussels; 2006.
- [44] The European Parliament and of the Council of the European Union, Regulation (EU) No 517/2014 of the European Parliament and of the Council of 16 April 2014 on fluorinated greenhouse gases and repealing Regulation (EC) No 842/2006, The European Parliament and of the Council of the European Union, Brussels; 2014.
- [45] Nowak T, Westring P. European Heat Pump Markets and Statistics. Report 2017. Brussels: European Heat Pump Association (EHPA); 2017.
- [46] Banek I, Froning S. Winning hearts and minds, presented at the Euroheat&power congress, Glasgow; 2017.
- [47] Ruesch F, Ewins R. District heating and cooling with low temperature networks - sketch of an optimization problem. In: Proceedings of the COLEB 2014 workshop on computational optimisation of low-energy buildings, Zürich; 2014.
- [48] Averfalk H, Ingvarsson P, Persson U, Gong M, Werner S. Large heat pumps in Swedish district heating systems. *Renew Sustain Energy Rev* 2017;79:1275–84.
- [49] Belotti G, Tarantino P. Il telericaldamento 'freddo'. COGEME SpA; 2013.
- [50] Masoero MC, Silvi C, Pellegrini G. Telericaldamento freddo con pompe di calore ad alta temperatura, presented at the Innovazione e tendenze nella tecnologia e nelle applicazioni delle pompe di calore, 30° Convegno nazionale AICARR, Padua.
- [51] Ruesch F, Scherer J, Kolb M. Erdreich als Speicher – grosse Anergienetze, in Internationale Konferenz zur Simulation gebäudetechnischer Energiesysteme, Winterthur; 2016.
- [52] Gautschi T. Energiekonzept Anergienetz Höggerberg. Zürich: ETH Zürich, Infrastrukturbereich Immobilien; 2015.
- [53] Østergaard D, Svendsen S. Space heating with ultra-low-temperature district heating – a case study of four single-family houses from 1980s. In: Proceedings of the 15th international symposium on district heating and cooling, Energy Procedia 116 (2017) 226–235.
- [54] LowExTra project. [Online]. Available: <<http://lowextra.de/>>.
- [55] Schmidt D et al. Low temperature district heating for future energy systems. In: Proceedings of the 15th international symposium on district heating and cooling, Energy Procedia 116 (2017) 26–38.
- [56] EU H2020 FLEXYNETS project. [Online]. Available: <www.flexynets.eu>.
- [57] Schmidt RR. Wärmenetze im Umbruch, presented at the Wärmenetze der Zukunft - Mit neuen Technologien zum Erfolg, Salzburg, 03.; 2016.
- [58] Bünning F, Wetter M, Fuchs M, Müller D. Bidirectional low temperature district energy systems with agent-based control: performance comparison and operation optimization. *Appl Energy* 2018;209:502–15.
- [59] Younger PL. Ground-coupled heating-cooling systems in Urban areas: how sustainable are they? *Bull Sci Technol Soc* 2008;28(2):174–82.
- [60] Rafferty K. Design aspects of commercial open-loop heat pump systems. *GeoHeat Cent Q Bull* 2001;22:16–24.
- [61] Sulzer M, Hangartner D. Kalte Fernwärme (Anergienetze) - Grundlagen-/Thesenpapier. Horw: Hochschule Luzern, Zentrum für Integrale Gebäudetechnik; 2014.
- [62] Heissler KM, Metz J, Lang W, Auer T, Nemeth I. Potenziale von Niedrigtemperaturnetzen zur Steigerung des Anteils erneuerbarer Energien in Quartieren. München: Munich School of Engineering; 2017.
- [63] Bonin J. Heat pump planning handbook. ed. New York: Routledge; 2015.
- [64] Wärmepumpen aktuell. Innovative Wärmepumpenprojekte auf der EXPO 2000. Wärmepumpe Aktuell- 2000;1.
- [65] Klima-Log. Industrieabwärme versorgte Wohngebiet in Spenge. [Online]. Available: <<http://www.klima-log.de/ergebnis.asp>>.
- [66] Gautschi T. Anergienetze in Betrieb, presented at the Städtische Wärmewende, Wien, 29.; 2016.
- [67] E.ON. ectogrid. [Online]. Available: <<http://ectogrid.com/>>. [Accessed 28 September 2018].
- [68] Vanoli K, Christoffers D, Rockendorf G, Kranz R. Solarsiedlung am Ohrberg, FVS - Forschungsvorhaben sonnenenergie, Köln, Forschungsvorhaben sonnenenergie themen 97/98; 1997.

- [69] [Online]. Available: <<https://www.buerger-energie-fischerbach.de/de/bKWN/Karl-May-Weg-II%2BIII>>. [Accessed 05 December 2017].
- [70] Swisspower. IBC Energie Wasser Chur: Anergie-Netz Rheinfels/Kleinbruggen, Zürich, Report 2014: Masterplan 2050 der Swisspower Stadtwerke; 2014.
- [71] Esen H, Inalli M, Esen M. Technoeconomic appraisal of a ground source heat pump system for a heating season in eastern Turkey. *Energy Convers Manag*. 2006;47(9–10):1281–97.
- [72] Amstein + Walthert AG, allreal Richti Wallisellen, Zürich. 2015.
- [73] Wiltshire Robin. *Advanced district heating and cooling (DHC) systems*. Saint Louis: Elsevier, WoodHead Publishing; 2016.
- [74] Stene J, Eggen G. Heat pump system with distribution at intermediate temperature at the University of Bergen. In: *Proceeding of the 19th international congress of refrigeration*, The Hague, The Netherlands; 1995.
- [75] e.wa riss GmbH & Co. Technische Anschlussbedingungen der e.wa riss GmbH & Co. KG – nachstehend e.wa riss genannt - für den Anschluss an die Kalte Nahwärmeversorgung im Baugebiet Hochvogelstraße (TAB Kalte Nahwärme), Biberach; 2016.
- [76] IBC. Technische Bestimmungen (TB) für den Anschluss an ein Anergienetz, Chur; 2014.
- [77] Energia Alpina. Anergienetz Sedrun: Anschlussschema, Sedrun; 2015.
- [78] EnAlpin, IWISA Lauber. Informationsveranstaltung Fernwärmenetz Saas-Fee, Saas-Fee; 2015.
- [79] Stadtwerke Troisdorf GmbH. Technische anschlussbedingungen geothermie, Troisdorf; geothermie, 2017.
- [80] Polisun Simulation Software. [Online]. Available: www.velasolaris.com. [Accessed 28 November 2017].
- [81] Fischer D, Lindberg KB, Mueller S, Wiemken E, Wille-Hausmann B. Potential for balancing wind and solar power using heat pump heating and cooling systems. In: *Proceedings of the 4th solar integration workshop*, Berlin, Germany.
- [82] Gottburg JH. Primärenergiefaktor Kaltes Nahwärmenetz Berender Redder - Schleswiger; 2014.
- [83] Brosziewski HU, Bescheinigung i.S. §10 Abs. 3 EEWärmeG über die energetische Bewertung der Nahwärme nach FW 309-1:2014 für das Wärmenetz Geothermie Eschmar West E65 ('kalte Nahwärme'), Hannover, 2018.
- [84] EU H2020 STORM project. [Online]. Available: <storm-dhc.eu>.
- [85] Kräuchi P, Schluck T, Sulzer M. Modelling of low temperature heating networks with IDA-ICE. In: *Proceedings of international conference CISBAT 2015 future buildings and districts sustainability from nano to urban scale*; 2015, p. 827–32.
- [86] H2020 project Sim4Blocks. [Online]. Available: <<http://www.sim4blocks.eu/>>.
- [87] Vivian J, Jobard X, Hassine IB, Pietruszka D, Hurink JL. Smart Control of a district heating network with high share of low temperature waste heat. In: *Presented at proceedings of the 12th conference on sustainable development of energy, water and environmental systems - SDEWES*, Dubrovnik; 2017.
- [88] Turning up the heat: getting a fair deal for district heating users, Which?, London; 2015.
- [89] Resvik B. Business models today and tomorrow regulatory regimes affecting the price strategies. In: *presented at the 35th euroheat & power congress*, Paris; 2011.
- [90] Energia Alpina. Anergienetz Sedrun: Preisblatt, Sedrun; 2016.
- [91] e.wa riss GmbH & Co. Preisblatt der e.wa riss GmbH & Co. KG – nachstehend e.wa riss genannt – für die Versorgung mit „Kalter Nahwärme im Baugebiet Hochvogelstraße, Biberach; 2016.
- [92] e.wa riss GmbH & Co. Kosteninformation für Ihr Einfamilienhaus im Neubaugebiet „Hochvogelstraße, Biberach; 2016.
- [93] Cozzini M, D'Antoni M, Buffa S, Fedrizzi R. Pricing strategies for neutral-temperature district heating and cooling networks based on heat pumps. In: *Proceedings of the 12th IEA heat pump conference*, Rotterdam; 2017.
- [94] CLIVET S.p.A. References. Complesso della torre - Savona, CLIVET S.p.A., Feltre; 2007.
- [95] Marella T, Zarotti G, Bosco D. Riquilificare un immobile storico con pompa di calore VRV. *AICARR J* 2014;24:48–56.
- [96] Ordigoni G. *Analisi energetica e prestazionale di un impianto idrotermico ad acqua di laguna per la climatizzazione civile ed industriale nella città di Venezia*. Padova: Università degli Studi di Padova; 2014.
- [97] CLIVET S.p.A. References, Portopiccolo Sistiana - Trieste, CLIVET S.p.A., Feltre.
- [98] AIRU, Visita di Airu al sistema ad acqua di mare di Portopiccolo - Teleriscaldamento. [Online]. Available: <<http://www.airu.it/visita-di-airu-al-sistema-di-climatizzazione-ad-acqua-di-mare-di-portopiccolo/>>. [Accessed 22 December 2017].
- [99] Legambiente, Comune di Sale Marasino - Comuni Rinnovabili. [Online]. Available: <<http://www.comunirinnovabili.it/comune-di-sale-marasino/>>. [Accessed 22 December 2017].
- [100] Cogeme S.p.A. Riconoscimento ad Ecomondo per l'impianto tlr cogeme di Sale Marasino. [Online]. Available: <<http://www.cogeme.net/index.php/255-riconoscimento-ad-ecomondo-per-1%E2%80%99impianto-tlr-cogeme-di-sale-marasino>>. [Accessed 22 December 2017].
- [101] Pietruszka D. Kalte Nahwärme: agrothermische Wärmeversorgung einer Plusenergiesiedlung. *bbr Leit Brunnenbau Geotherm* 2013;03:58–63.
- [102] Festbrennstoffe B, C.A.R.M.E.N. e.V. - Wärmenetze neu gedacht. [Online]. Available: <<https://www.carmen-ev.de/biogene-festbrennstoffe/waermenetze/1966-waermenetze-neu-gedacht/>>. [Accessed 22 December 2017].
- [103] Kalte Nahwärme für Baugebiet in March, Komm plus, *EnBW*, no. 02/09; 2009.
- [104] Köbel T. Die Versorgung eines Neubaugebietes mit „Kalter Nahwärme“. *bbr Leit Brunnenbau Geotherm* 2006;12.
- [105] [Online]. Available: <<https://www.dbu.de/phpTemplates/publikationen/pdf/0709100210358pps.pdf>>. [Accessed 22 December 2017].
- [106] Energieagentur.nrw, "Kaltes" Nahwärmenetz spart 40.000 kg CO2 im Jahr. [Online]. Available: <http://www.energieagentur.nrw/eanrw/kaltes_nahwaermenetz/>. [Accessed 21 December 2017].
- [107] Kalte Nahwärme für Nümbrecht, Installation DKZ, vol. 9; 2017, p. 26–28.
- [108] Meyer JP, SonneWind&Wärme, Kaltes Nahwärmenetz versorgt Neubaugebiet. [Online]. Available: <<http://www.sonnewindwaerme.de/solarthermie-waermepumpe/kaltes-nahwaermenetz-versorgt-neubaugebiet/>>. [Accessed 21 December 2017].
- [109] Energiezukunft, Geothermie: Kalte Nahwärme in Biberach. [Online]. Available: <<https://www.energiezukunft.eu/erneuerbare-energien/waerme/geothermie-kalte-nahwaerme-in-biberach/>>. [Accessed 22 December 2017].
- [110] e.wa riss GmbH, Baugebiet Hochvogelstraße. [Online]. Available: <https://www.ewa-riss.de/2_Privatkunden/Waerme/Baugebiet_Hochvogelstrasse.php>. [Accessed 22 December 2017].
- [111] Und es geht doch: Innovative Projekte rund um die Geothermie, Innovation & Energie, vol. 1/2001; 2001, p. 6–11.
- [112] agenda-transfer, Agentur für Nachhaltigkeit GmbH /, and Agentur Nachhaltiges NRW, Spenge: Wohngebiet und Industrie Hand in Hand, Wege in die kommunale Energieversorgung der Zukunft – NRW zeigt, wie es geht, Bonn; 2006, p. 5.
- [113] Energieservice Westfalen Weser, Wohnpark Sattlerweg. [Online]. Available: <<https://energyservice-ww.com/wohnpark-sattlerweg-privat.html>>. [Accessed 22 December 2017].
- [114] E-Werk Mittelbaden, Bidirektionales Kalt-Wärme-Netz (bKWN). [Online]. Available: <<https://www.e-werk-mittelbaden.de/projekt/bidirektionales-kalt-waerme-netz-bkwn/>>. [Accessed 22 December 2017].
- [115] innovaSCHMID, Bidirektionales Kalt-Wärme-Netz im Neubaugebiet Karl- May-Weg Fischerbach; 2017.
- [116] Bürger Energie Fischerbach, bKWN Karl-May-Weg II/III. [Online]. Available: <<https://www.buerger-energie-fischerbach.de/de/bKWN/Karl-May-Weg-II%2BIII>>. [Accessed 23 December 2017].
- [117] Uwe Manzke. Bidirektionales kaltes Nahwärmenetz; 2016.
- [118] WATERCOTTE GmbH. Moderne Energieversorgung Kalte Nahwärmenetze in Baugebieten: Vorteile und Nutzen; 2017.
- [119] Energieagentur Rheinland-Pfalz, Kalte Nahwärme'-Konzept der Energieagentur überzeugt Schifferstadt. [Online]. Available: <<https://www.energieagentur.rlp.de/service-info/die-energieagentur-informiert/aktuelle-meldungen/aktuelles-detail/kalte-nahwaerme-konzept-der-energieagentur-ueberzeugt-schifferstadt/>>. [Accessed 23 December 2017].
- [120] Stadtwerke Schifferstadt, Kalte Nahwärme. [Online]. Available: <<http://www.sw-schifferstadt.de/de/Waerme/Kalte-Nahwaerme/Kalte-Nahwaerme.html>>. [Accessed 22 December 2017].
- [121] Landeshauptstadt Mainz Umweltamt, Klimaschutzbericht Mainz 2013, Mainz; 2013.
- [122] Mainz Landeshauptstadt. Grün- und Umweltamt, zum „Masterplan 100 % Klimaschutz für die Landeshauptstadt Mainz, Leipzig; 2017.
- [123] Bauunternehmung Karl Gemünden GmbH & Co. KG, Geothermie: Nahwärmeversorgung im Einfamilienhaus. [Online]. Available: <<https://bau-gemuenden-bau.de/geothermie-nahwaermeversorgung-im-einfamilienhaus/>>. [Accessed 23 December 2017].
- [124] WPuQ, Solarsiedlung Am Ohrberg. [Online]. Available: <https://wpuq.de/solarsiedlung/>. [Accessed 22 December 2017].
- [125] Sonnet P, Nahwärme in „Grüner Kolonie und Im Moselfeld: Brunnen für Geothermie-Projekt fertiggestellt. [Online]. Available: <http://www.troisdorf.de/web/de/stadt_rathaus/aktuelles/presse/pressemitteilungen.htm?Selection=095&jahr=2014>. [Accessed 20 December 2017].
- [126] Sanner Burkhard. Geothermische Fernwärme – Ergebnisse des EU-Projekts GeoDH, und der Weg zu Geothermie in Smart Thermal Grids, presented at the 25. Fachtagung Geothermie und Wärmenetze, Bern, Switzerland; 2015.
- [127] Dorsen Stadt. Wärmekonzept Dorsten, Wulfen-Barkenber, Dorsen.
- [128] Schleswiger Stadtwerke, KalteNAHWÄRME – ökologisch, clever und hocheffizient. [Online]. Available: <<https://www.schleswiger-stadtwerke.de/content/produkte/schleswigerNAHWAERME/>>. [Accessed 19 December 2017].
- [129] Zürich ETH. Energiekonzept Anergienetz Höggerberg, Zürich.
- [130] Klucher F. Practical experience with cold water district heating and cooling networks - Naters and Brig (Switzerland). In: *Presented at proceedings of the 1st FLEXYNETS workshop: cold water district heating and cooling systems as flexible exergy exchange systems – a promising concept for the future?* Bolzano Bozen; 2017.
- [131] Wyss B. Anergienetz, Stadt Info Nr 37 - Stadtgemeinde Brig-Glis; 2013.
- [132] Unsere Wärmelösungen im Oberwallis – Heizen mit...; Visp; 2016.
- [133] energieregionGoms, Ein Projekt der Gemeinde Obergoms (Oberwald und neu evtl. Obergesteln): Wärme aus dem Furkatunnel. [Online]. Available: <<http://www.energieregiongoms.ch/index.php/projekte/item/20-warmwasser-aus-dem-furkatunnel>>. [Accessed 18 December 2017].
- [134] Willkommen zur Informationsveranstaltung der ANOG Anergienetz Obergoms AG, Oberwald; 2015.
- [135] Rybach L, Wilhelm J, Gorhan H. Geothermal use of tunnel waters—a Swiss speciality. In: *Proceedings international geothermal conference*, Reykjavik, vol. 14; 2003, p. 9.
- [136] 1815.ch, Visper Anergienetz: Frostige Stimmung bei den Anwohnern, 12-Oct-2017. [Online]; 1815. Available: <<http://www.1815.ch/rhonezeitung/zeitung/region/visper-energienetz-frostige-stimmung-bei-den-anwohnern/>>.
- [137] Gemeinde Visp. Anergienetz, eine erdölunabhängige Energieversorgung, Visp, Medienkonferenz vom 4. Oktober 2007.
- [138] Lauber IWISA AG, Anergienetz Visp-West "Eine erdölunabhängige Energieversorgung", Naters.
- [139] Viquerat PA. Utilisation des réseaux d'eau lacustre profonde pour la climatisation

- et le chauffage des bâtiments; bilan énergétique et impacts environnementaux: étude de cas: le projet GLN (Genève-Lac-Nations) à Genève. University of Geneva; 2012.
- [140] Sulzer M, Summermatter S. Solare Energieversorgung im alpinen Raum Reka-Ferlendorf Blatten-Belalp. Schweiz Eidgenoss 2016.
- [141] Energia Alpina, Anergienetz Sedrun, Sedrun.
- [142] Flaviano D. EnAlpin setzt mit dem Wärmenetz Saas-Fee auf die erneuerbare Zukunft. Presented at the Energieapéro 2016, Ein Beitrag zur Energiewende, Susten; 2016.
- [143] IBC Energie Wasser Chur. Anergienetz Chur West, Chur; 2017.
- [144] IBC Energie Wasser Chur. “Das Anergienetz – ein guter Entscheid”, Chur; 2014.