

Title	2D communication sensor networks using single frequency for concurrent power supply and data transmission
Author(s)	Oota, Toshifumi; Lim, Azman Osman; Hattori, Kiyohiko; Kado, Youiti; Zhang, Bing
Citation	IEEE SENSORS 2010 Conference: 2016-2021
Issue Date	2010-11
Type	Conference Paper
Text version	publisher
URL	http://hdl.handle.net/10119/10325
Rights	Copyright (C) 2010 IEEE. Reprinted from IEEE SENSORS 2010 Conference, 2010, 2016-2021. This material is posted here with permission of the IEEE. Such permission of the IEEE does not in any way imply IEEE endorsement of any of JAIST's products or services. Internal or personal use of this material is permitted. However, permission to reprint/republish this material for advertising or promotional purposes or for creating new collective works for resale or redistribution must be obtained from the IEEE by writing to pubs-permissions@ieee.org . By choosing to view this document, you agree to all provisions of the copyright laws protecting it.
Description	

2D Communication Sensor Networks Using Single Frequency for Concurrent Power Supply and Data Transmission

Toshifumi Oota*, Azman-Osman Lim[†], Kiyohiko Hattori[‡], Youiti Kado* and Bing Zhang*

*Medical-ICT Group, New Generation Wireless Communications Research Center, National Institute of Information Communications Technology (NICT), 2-2-2 Hikaridai, Seika-cho, Soraku-gun, Kyoto 619-0288 Japan.

Email: {oota, kado, zhang}@nict.go.jp

[†]Computer Systems and Networks, School of Information Science, Japan Advanced Institute of Science and Technology (JAIST), 1-1 Asahidai, Nomi, Ishikawa 923-1292 Japan. Email: aolim@jaist.ac.jp

[‡]University of Electro-Communications, 1-5-1, Chofugaoka Chofu-shi, Tokyo 182-8585, Japan. Email: hattori@hc.uec.ac.jp

Abstract—Two-dimensional (2D) communication is a novel physical communication form that utilizes the surface as a communication medium to provide both data and power transmission service to the sensor devices placed on the surface's top. In previous works, we developed 2D communication systems that utilize separated channels for data and power transmission. Though this assignment of different channels can achieve strong network performance, the sensor devices must be equipped with two or more interfaces to simultaneously receive the power and data signals, which significantly complicates and enlarges those devices. Moreover, when a channel is used for the power supply, it continually monopolizes the wireless frequency resource. In this paper, we develop a novel 2D communication sensor system by using a single-carrier frequency for both power and data transmission, equipped with the wireless module for the two together in a compact body. To enable a sensor node that concurrently receives energy and data communication, we propose an enhancement scheme based on the IEEE802.15.4 MAC protocol standard. Through both computer simulation and actual measurement of the output power, we evaluate the performance of power supply and data transmission over the developed system.

I. INTRODUCTION

Ubiquitous communication is an area that has been rapidly growing area in recent years and a great deal of innovative research and development in this area has brought this concept to real applications that are beneficial in our daily lives. Networks of small wireless-sensing devices present significant new opportunities for ubiquitous communication. The challenges in deployment of ubiquitous sensor networks are physical connection and power supply for a large amount of sensors, which not only prohibits manual setup of a network and necessitates autonomous operation, but also eliminates the option of battery replacement, placing critical importance on the power supply. Two-dimensional (2D) communication technology has huge potential as a ground-breaking technology for realizing ubiquitous sensor networks, because innovative 2D communication systems can simultaneously provide both data communication and power transmission to the sensor devices placed atop it. Such systems utilize a 2D sheet as a commu-

nication medium to provide room-sized communications and other services to the sensor devices on top of it. This new form of 2D communication medium is not only able to establish a communication connection between two sensor devices; it can also provide high-speed transmission, power supply, high security, highly accurate estimation of the sensor's location, efficient spatial reuse, and other services.

The concept of "Networked Surface" was first proposed by Scott et al. in October 1998 at the Laboratory for Communications Engineering at Cambridge University [1],[2]. The core idea in relation to a surface as a medium for both power and networking was inspired by Pushpin [3] and Pin&Play [4] systems. Lifton and Paradiso [3] use pushpins and layered conductive boards, where direct contact to the conductive layers in the board is used to obtain power, whereas networking is established via infrared. To envisage high-speed networking capabilities, Laerhoven et al. [4] proposed that the conductive layer can be used as a bus network for pins. Instead of using pin-shaped connectors, Sekitani et al. [5] successfully manufactured a large-area power transmission sheet by using printing technologies. The major disadvantage of this system is the issue of capacitive coupling, which requests that the device is put in an exact position on top of the transmitter.

A 2D communication system (2DCS) utilizes the surface as the communication medium to perform both data and power transmission wherever the device is placed atop the 2D sheet by confining the microwave in a thin sheet [6]-[8]. When a connector is placed atop the sheet an electromagnetic proximity connection is obtained, and a connector can thereby inject/extract the electromagnetic signal into/from the sheet. In previous work, we developed 2D communication systems by using the separated channels for data and power transmission[7],[8]. However, when the different channels are assigned to the power and data transmissions, respectively, two or more interface circuits are needed to simultaneously receive the power and data signals, which largely decreases flexibility in hardware design and implementation on sensor devices. Since each sensor device should be small-sized, lightweight,

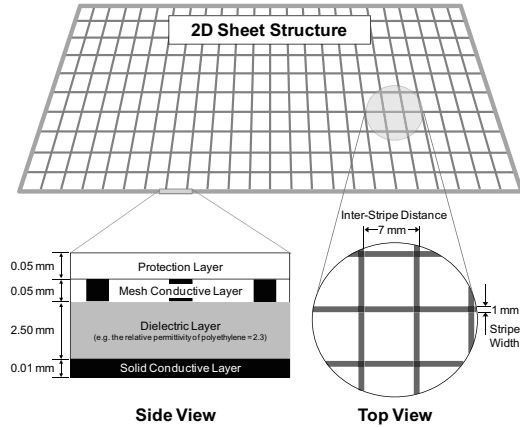

Fig. 1. Basic structure of the 2D sheet.

and cheap, equipping it with two or more interfaces greatly aggravates the problem. Moreover, when a channel is assigned to the power supply, it continually monopolizes the wireless frequency resource. Particularly, when input power is continually sent out above a certain level it is likely to cause interference with the other signal source.

In this paper, we propose and build a novel 2D communication sensor system by using a single carrier frequency for both power and data transmission. The rest of this paper is organized as follows. Section 2 briefly gives an overview of the proposed 2D communication system. Section 3 describes the power charging state transition for the power supply management. Then in Sect. 4 we propose a concurrent power supply and data transmission (PSDT) protocol. The simulation results are described in Sect. 5, and the experiment setup and results are presented in Sect. 6. The last section concludes the paper.

II. 2D COMMUNICATION SYSTEM OVERVIEW

A 2D communication system (2DCS) consists of two components: a sheet and a connector. Figure 1 illustrates the basic structure of the 2D sheet, which is composed of four layers: solid conductive (S-) layer, dielectric (D-) layer, mesh conductive (M-) layer, and protection (P-) layer. The conductive fabric is usually copper or aluminium, whereas the dielectric material is polystyrene. The purpose of the P-layer is to protect humans from directly coming in contact with the M-layer. With this layered composition, an electromagnetic (EM) wave can be confined within the 2D sheet depending on the relative permittivity of the D-layer and the mesh structure of the M-layer. However, the EM wave can still be seeped out from the surface of the 2D sheet. Meanwhile, the connector is an antenna by which an electromagnetic wave is extracted from or inserted into the 2D sheet. Since the connector is one type of antenna, the design of the connector is not described in this paper. An example of the connector was designed and proposed by Yamahira et al. [6].

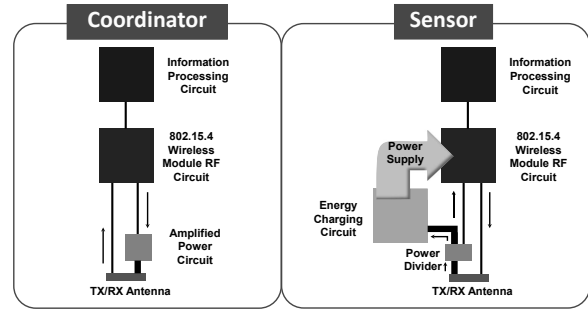

Fig. 2. Basic structure for coordinator and sensor devices

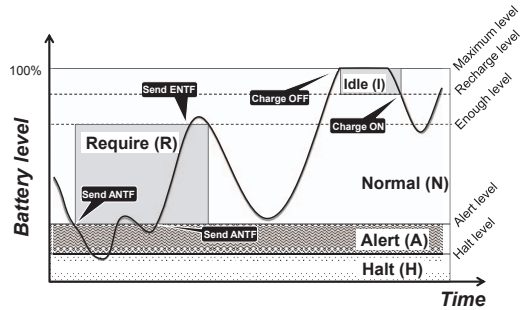

Fig. 3. Diagram of battery level variation with time

III. CHARGING STATE TRANSITION FOR POWER SUPPLY MANAGEMENT

Most of the existing MAC protocols for such networks are also designed to deal efficiently with energy limited resources in order to maximize the network lifetime. To enable the MAC protocol to control the power supply, in this section we first give the architecture of coordinator and sensor devices, and then the charging state transition diagram for the sensor device. For the power supply management, we finally propose that the coordinator device hold a power supply management table to control the power supply states in the sensor devices.

Figure 2 shows the fundamental architecture of the coordinator and sensor devices. Both have the same modules for information processing, IEEE 802.15.4, radio frequency (RF) circuit, and transmitter/receiver (TX/RX) antenna. The coordinator device provides the power supply to the sensor devices using the power carrier signals. When the communication signal is transmitted from the coordinator, it is amplified to almost the same level as the power supply signal by the amplifier power circuit module. Upon receiving the pure carrier signal, the power is charged by the energy-charging circuit in the sensor device. Meanwhile, upon receiving the amplified communication signals from the coordinator, it is largely reduced by the divider to prevent the reception circuit breaking due to an overly strong signal input to the sensor device. In this paper, we ignore the design and performance of the antenna.

The energy storage circuit part of the device has the ability to store energy automatically in its storage (hereinafter referred

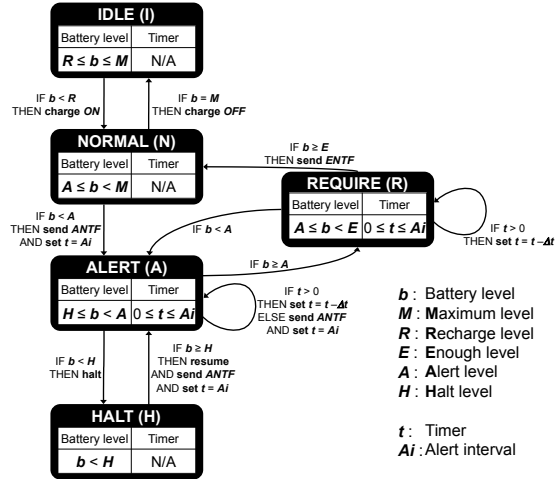

Fig. 4. Battery state transition running on device.

to as a “battery”). In order to monitor the battery level of the device, we introduce five levels: maximum, recharge, enough, alert, and halt. Figure 3 illustrates how the battery levels of devices vary over time. The battery state machine is introduced to monitor the states of the battery in corresponding to the battery levels. As shown in this figure, there are five states: idle, normal, require, alert, and halt. Conditions for state transition depend on the battery status and alert interval. Based on these states, each device can easily monitor the battery level. Figure 4 shows the battery state machine running on the device. In order to perform this state machine, each device must encompass two entries: battery level (b) and timer for Alert Interval (t).

As indicated by Fig. 3, when the battery level goes below the alert level from the normal state, the device will send an alert notification (ANTF) frame to acknowledge that the coordinator for its own battery status is in an alert state. Being in the alert state is a critical issue for the device, thus we introduce a timer, which is set to an integer value of Alert Interval. This timer counts down until it reaches zero seconds. According to the battery state transition shown in Fig. 4, at the zero of timer, when the battery level is still below the alert level, the device will send another ANTF and resets the timer. Otherwise, when the battery level goes above the alert level, the devices will do nothing. Furthermore, when the battery level goes below the halt level, the device will immediately suspend its communication function. By contrast, when the battery level goes above the enough level, the device will send an enough notification (ENTF) frame to acknowledge that the coordinator for its own battery status is normal. When the battery level goes above the maximum level, the device will stop charging its battery. When the battery level goes below the recharge level, the device will again start charging its battery.

The coordinator is assumed to have a power supply management (PSM) table. Upon receiving either the ENTF frame or ANTF frame, the coordinator updates the PSM table

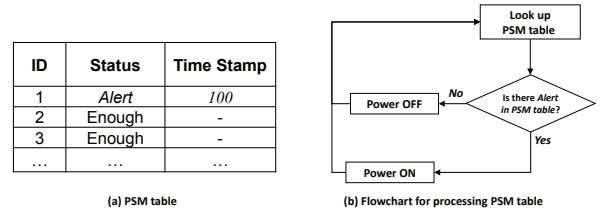

Fig. 5. Example of PSM table and flowchart for processing the PSM table.

corresponding to the address and status of the sent device and the coordinator must reply with an acknowledgment (ACK) for every received ENTF frame or ANTF frame. Figure 5(a) shows an example of the PSM table. Upon receiving the ANTF frame, the expiration time for alert entry is set to three times the Alert Interval. The purpose of the expiration time is to prevent the coordinator continuously supplying the power to a device that was removed from the 2D sheet. The power supply is ON when there is at least one alert entry in the PSM table. Otherwise it is OFF. Figure 5(b) summarizes the ON/OFF switch of the power supply into a flowchart for processing the PSM table at the coordinator.

IV. CONCURRENT POWER SUPPLY AND DATA TRANSMISSION SCHEME

A conventional MAC protocol for sensor networks is designed for data transmission and energy management, but none of the existing protocols is applicable for 2D sensor networks, which can provide both data and power transmission. To enable a sensor device that concurrently receives energy and data communication, we propose an enhancement scheme based on the IEEE802.15.4 MAC protocol standard, which is simply modified for adding the power supply feature at the first preliminary stage of protocol implementation.

The IEEE 802.15.4 MAC standard defines an optional superframe structure; which is initiated by, and its format is decided by, the coordinator. As Fig. 6 shows, the superframe is bounded by network beacons and contains both an active and inactive period. The active period consists of 16 equally sized slots, and contains the frame beacon, contention access period (CAP) slots, and contention free period (CFP) slots. The first time slot of each superframe is used to transmit the beacon. The beacon’s main purpose is to synchronize the attached devices, identify the coordinator, and describe the superframe structure. The remaining slots are used by competing devices for communications during the CAP. The devices use a slotted CSMA/CA-based protocol to gain access to compete for the time slots. All communications between devices must conclude by the end of the current CAP. To satisfy the latency and bandwidth requirements of the supported applications, the coordinator may dedicate a group of contiguous time slots of the active superframe to these applications. These are labelled as guaranteed time slots (GTSs), and their number cannot exceed seven. The inactive period defines a time period during which all network devices, including the coordinator, can enter a sleep mode in order to reduce energy consumption. In this

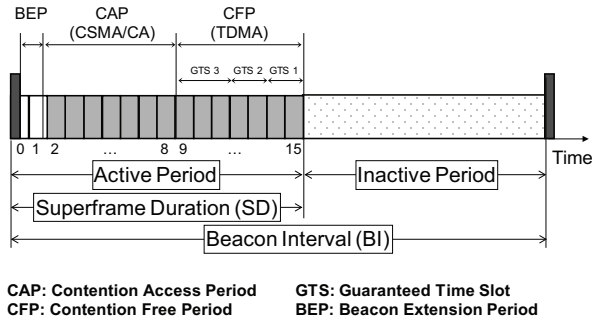

Fig. 6. Superframe structure of IEEE 802.15.4 MAC protocol specification.

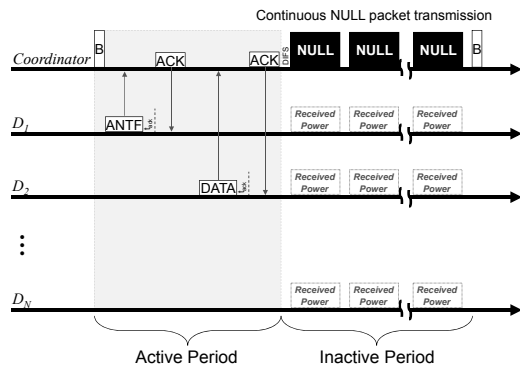

Fig. 7. Frame passing of ANTF and ENTF.

mode, the network devices switch off their power and set a timer to wake up immediately before the announcement of the next beacon frame.

To supply sufficient power to the devices, we propose that the inactive period is used by the coordinator to supply power to the devices if applicable. We called this inactive period as a “power supply phase”, which indicates that the continuous NULL packet transmissions are broadcasted by the coordinator to the devices. The main reason for this is that the coordinator can supply power to its devices without worrying about the window contention problem. In general, the durations of superframe duration (SD) and beacon interval (BI) are triggered by using the parameters of the superframe order (SO) and beacon order (BO), respectively.

IEEE 802.15.4 defines four basic frame types: beacon frame, data frame, ACK frame, and MAC command frame. We utilize the ANTF and ENTF frame as the MAC command frame.

We assume that the coordinator has the PSM table at the initial operation. The ANTF frame or ENTF frame must follow the rule of the CSMA/CA-based protocol. Upon transmitting the ANTF frame or ENTF frame, the device waits for the ACK frame from the coordinator. Figure 7 shows the how the coordinator continuously send NULL packets corresponding to the received ANTF frame. If the ANTF frame is received, the coordinator updates its PSM table with the alert entry of the sent device. Then, the coordinator supplies power continuously

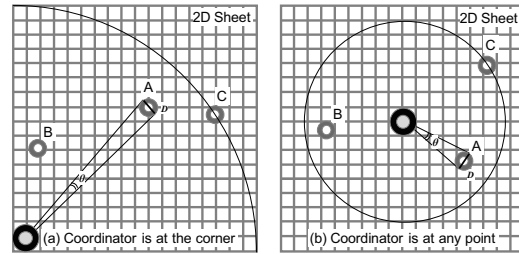

Fig. 8. Pathloss model for 2D communication.

in the power supply channel. If the coordinator’s PSM table contains none of the alert entries, it stops supplying power.

V. SIMULATION RESULTS

We examine the performance of the PSDT protocol by using the QualNet 4.5 simulator. In our simulation, all the sensors and one coordinator are placed on a 3 m×3 m surface. We focus on the influence of the power supply on the protocol performance. For that purpose, we prepare a simulation set with one coordinator whereby the number of sensors is 35. The coordinator is placed at the bottom-left corner of the simulation area whereas all the sensors are placed in the form of a grid topology.

For the traffic model, a constant bit rate (CBR) traffic is assumed. The data payload size is set to 64 bytes, in which the data packet sends at an interval of 0.246 seconds. This interval value is equivalent to the beacon period when the beacon order (BO) is 4. In order to avoid packet collision, the generation time of the first data packet of each sensor is exponentially distributed. We run the simulation for 6 hours. Other parameters are as follows: Physical characteristic is IEEE 802.15.4 (ZigBee), MAC protocol is CSMA/CA (Beacon mode), Data rate is 250 kbps and the superframe order and the beacon order are 3 and 4 respectively. The power consumption of a sensor device to transmit, receive, idle and sleep are 60, 45, 45 and 0 mW respectively. Propagation model is 2D pathloss model, Alert interval is set to 100 seconds, PSM expiration time is set to 300 seconds.

Figure 8 shows the 2D pathloss model when the coordinator is at any point or at the corner of the 2D sheet. For the case that the coordinator is at the corner, applying the Friis transmission equation to the two dimensional free space, we can obtain the received power of connector by the equation below:

$$P_r = P_S \frac{2D}{\pi d} \quad (1)$$

Where P_S is the power supply of the coordinator in Watts. D is the connector diameter in meter and d is the distance between the connector and the coordinator. In this paper, we use equation (1) as the pathloss model for our simulation. We assume that the connector diameter is 6 cm.

The unit of battery capacity is denoted as a milliampere hour (mAh). In this paper, a simple linear model is assumed for the battery model. This model is based on the coulomb

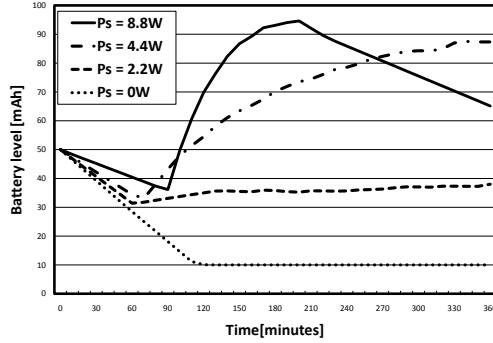

Fig. 9. Battery level varies with time for 35-sensor topology network.

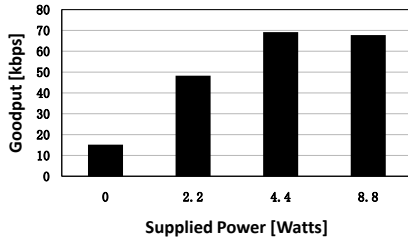

Fig. 10. Evaluation result of goodput for supplied power.

counting technique, which respectively accumulates and dissipates linearly according to time when the battery charges and discharges. For simplicity, this model does not consider over-charging loss, charge/discharge efficiency, self-discharge loss, time durability, and cycle durability. The charging capacity is given by

$$C_{char} = P_r \frac{T_{char}}{V_{nom}} \quad (2)$$

where V_{nom} is the nominal voltage for charging the battery and T_{char} is the charging time. In our simulation, the initial battery capacity of sensor is set to 50 mAh.

Figure 9 shows that the battery level varies with simulation time for the 35-sensors topology. The battery level in Fig. 9 displays the average value of all of the sensor's battery levels. When there is no power supply throughout the 2D sheet ($P_S = 0$ W), all the sensors deplete all their energy for disseminating the data packets up to about 120 minutes. After 120 minutes, all the sensors are at a halt. We also can denote this as a network lifetime. However, the sensor can continuously send out data packets when there is a power supply ($P_S = 2.2$ W, 4.4 W or 8.8 W). For $P_S = 2.2$ W, some sensors located far away from the coordinator are running out of battery whereas sensors located near the coordinator are strong enough to operate normally for sending their data packets until the end of the simulation. If we increase the power supply to double ($P_S = 4.4$ W), all of the sensors function as usual without concern about the lack of battery capacity. We can summarize that the network lifetime is prolonged when there is a supply of power inside the 2D sheet.

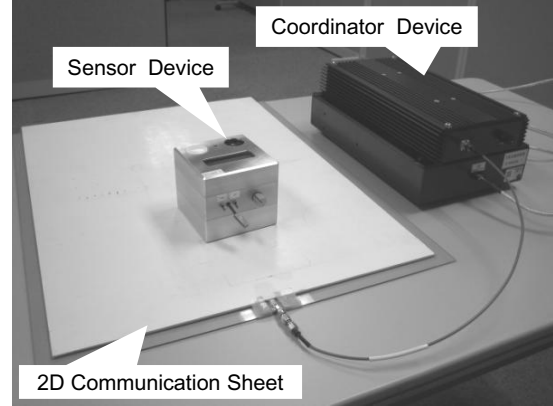

Fig. 11. Experiment setup.

Figure 10 shows that the goodput varies with the supplied power from the coordinator. Goodput is defined as the number of bits successfully received per unit time by the coordinator. As we can see from this figure, the goodput increases as the supplied power increases until the power supply is sufficient for all the sensors. When the supply power increases to $P_S = 8.8$ W, the goodput cannot be further improved. This is because the power supply of $P_S = 4.4$ W is already sufficient for all the sensors. The improvement seen from the cases of $P_S = 0$ W and $P_S = 2.2$ W, arises from the fact that some of sensor devices, especially located in a far distance from the coordinator, disrupt the data transmission to the coordinator due to the batteries running down. We can conclude that it is important to supply sufficient power using the 2D sheet for maintaining the good performance of sensors.

VI. MEASUREMENT RESULTS

In this section, we present the 2D communication sensor system actually developed by using a single carrier frequency for both power and data transmissions. Figure 11 shows the experiment setup that mainly consists of the coordinator device, 2D communication sheet, and sensor device. The coordinator device is directly connected to electricity source, and provides the power by sending the power carrier signals and amplified communication signal from it. Figure 12 shows the front and back of the sensor device, which is equipped with four kinds of sensors: infrared, illuminance, acceleration and temperature. In the front of the sensor device, the display, LED lamp, and speaker are mounted, and the display shows the voltage value of the energy-charging circuit in the sensor device, and the states of brightness, person's existence and movement. For simplicity, we use nine ceramic patch antennas, in which eight are for power supply and one is for data communication. The CC2430 chip is used as the IEEE802.15.4 / ZigBee module.

Figure 13 shows the charging voltage variation curves with time; where the distances from the input connector are 5 cm, 15 cm, 25 cm, 45 cm, and 60 cm. The beacon interval is set to 1 second, in which 900 ms is set as the sleep time. The power carrier signal is sent during the sleep time. We can see

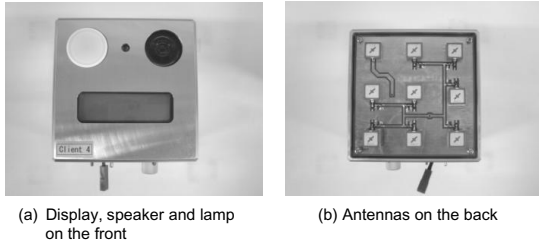

Fig. 12. Front and back of sensor device.

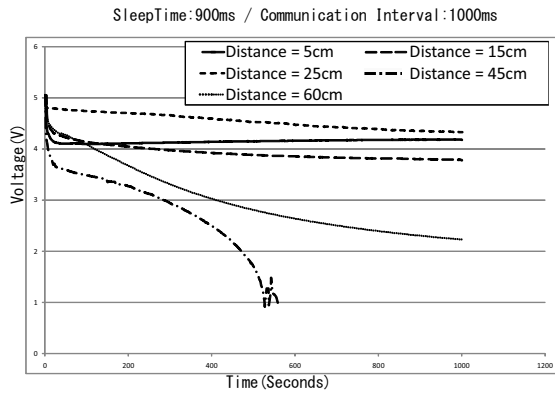

Fig. 13. Measurement result of charging voltage variation with time.

that the farther the distance from the connector, the greater the voltage decays, except for the cases of distance=25 cm, which is likely caused by the standing electromagnetic wave.

Figure 14 also shows the charging voltage variation curves with time; where the distance is very close to the input connector, and the sleep time is set to 900 ms. We perform the measurements for three cases: the first case is that the power carrier signal is sent during the sleep time depicted by the solid line; in the second case the energy charging module is not included, depicted by the short dashed line; and in the third case the power is not sent during the sleep time, depicted by the dots. From Fig. 14 it is clear that the first case is the best case in Fig. 14; in which the energy-charging function is enough to support the sensor device equipped with the four kinds of sensors and data communication.

VII. CONCLUSION

We developed a novel 2D communication sensor network performing both power and data transmission with a single-carrier frequency, and proposed a concurrent power supply and data transmission scheme by enhancing the IEEE 802.15.4, which allows the sensor device to charge the power corresponding to the charging status.

In the first step, we used the QualNet 4.5 simulator to examine the performance of the PSDT protocol. Simulation results revealed that the lifetime and goodput of a network increase when the power supply is sufficient inside the 2D communication sensor system. In the second step, we actually measured the voltage value of the energy-charging module in the sensor device. The measurement results reveal that when

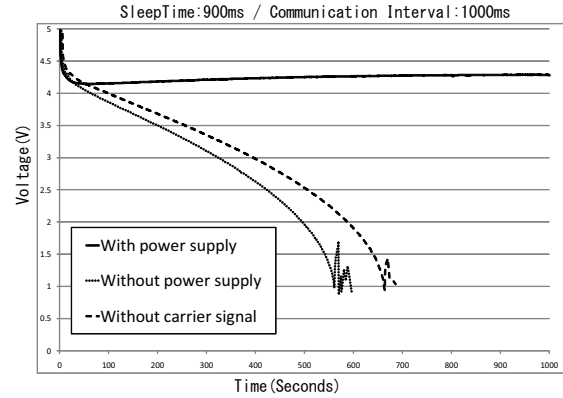

Fig. 14. Measurement result of charging voltage variation with time.

the sensor device is positioned at a very close distance to the input connector, the power supply from the coordinator is sufficient to support the sensor device. However, when the sensor device is placed away from the input connector, the charging voltage gradually falls into a low-charging level. Also, the longer the distance from the input connector, and the shorter the sleep time, the greater the voltage decays in the sensor device

As future work, instead of the patch antenna, we will develop a more efficient antenna to receive the power signal, with which the power supply is sufficient to support the sensor device wherever it is placed on the 2D sheet. We will also further evaluate the performance of the proposed concurrent protocol when we consider other factors like the real-life rechargeable battery model and different pathloss model with shadowing and reflection effects.

REFERENCES

- [1] J. Scott, F. Hoffmann, M. Addelesee, G. Mappt, and A. Hopper, "Networked surfaces: A new concept in mobile networking," in *Proc. IEEE Workshop on Mobile Computing Systems and Applications (WMCSA)*, pp.11–18, 2000.
- [2] J. Scott, F. Hoffmann, M. Addelesee, G. Mappt, and A. Hopper, "Networked surfaces: A new concept in mobile networking," *ACM Mobile Network and Applications*, vol.7, no.5, pp.353–364, 2002.
- [3] J. Lifton and J. Paradiso, "Pushpin computing system overview: A platform for distributed, embedded, ubiquitous sensor networks," in *Proc. Pervasive Comp., Lecture Notes in Computer Science (LNCS)*, vol.2414, pp.139–151, 2002.
- [4] K.V. Laerhoven, N. Villar, A. Schmidt, and H.W. Gellersen, "Pin & play: The surface as network medium," *IEEE Commun. Mag.*, vol.41, no.4, pp.90–95, 2003.
- [5] T. Sekitani, M. Takamiya, Y. Noguchi, S. Nakano, Y. Kato, K. Hizu, H. Kawaguchi, T. Sakurai, and T. Someya, "A large-area flexible wireless power transmission sheet using printed plastic MEMS switches and organic field-effect transistors," in *Proc. IEEE International Electron Devices Meeting (IEDM) Conf.*, pp. 287–290, 2006.
- [6] N. Yamahira, Y. Makino, H. Itai, and H. Shinoda, "Proximity connection in two-dimensional signal transmission," in *Proc. SICE-ICASE Int. Joint Conf.*, pp.2735–2740, 2006.
- [7] A.O. Lim, T. Oota, and B. Zhang, "Adaptive power supply scheme and performance evaluation for 2-dimensional communication system," in *IEICE Technical Report*, vol.108, no.252, pp.27–32, 2008.
- [8] B. Zhang, A.O. Lim, Y. Kado, H. Itai and H. Shinoda, "An Efficient Power Supply System Using Phase Control in 2D Communication," in *INSS'09: Proceedings of the 6th international conference on Networked sensing systems*, pp.110–113, 2009.