



Optical Network Automation and Programmability for 6G: State-of-the-Art, Vision, and Challenges

Carlos Natalino

Researcher

Optical Networks Unit

Department of Electrical Engineering

Chalmers University of Technology

<https://www.chalmers.se/en/persons/carda/>

Outline

Part 1

- Network generations
- 6G vision
- Use cases
- Representative architecture

Part 2

- Challenges
- State-of-the-art
 - Four representative works
- Concluding remarks

*The latest version of this slide set can be found here: <https://research.chalmers.se/en/publication/537646>

Network generations

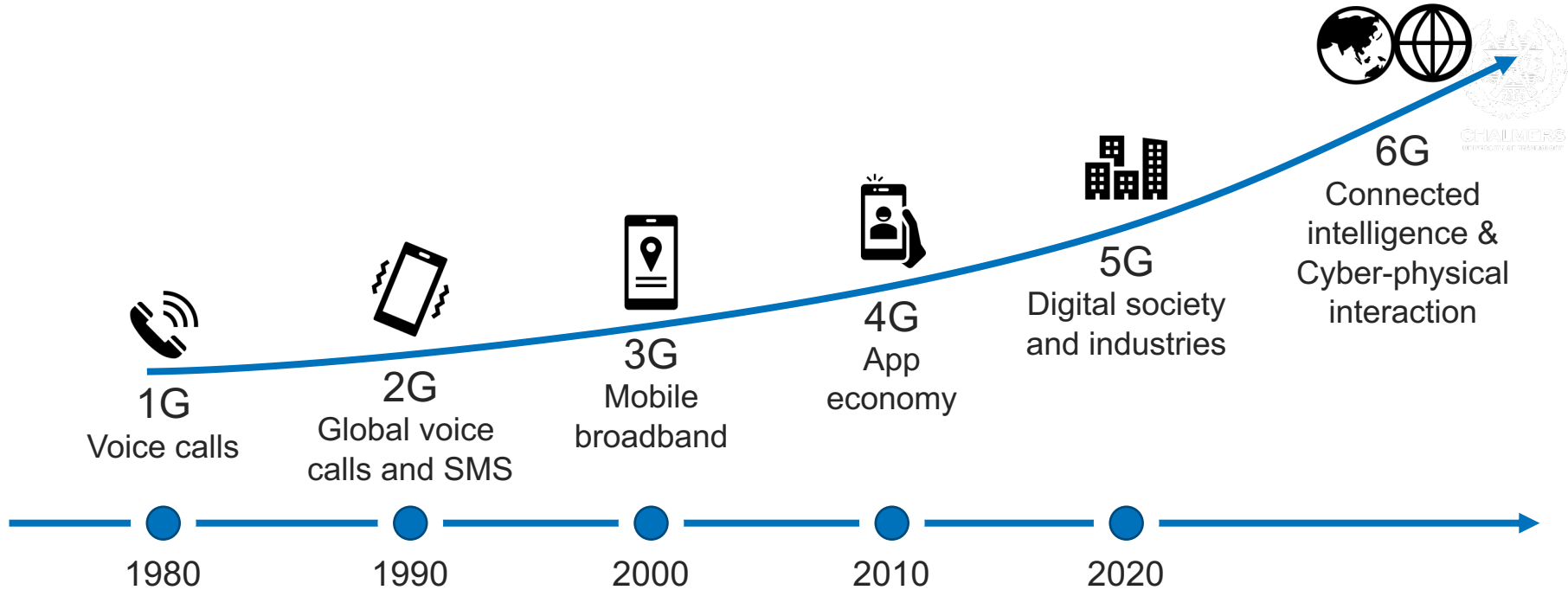

*Wolfgang John, "The journey towards 6G: Going beyond connectivity services," IEEE NetSoft, Madrid, Spain, June 2023.

From 5G to 6G

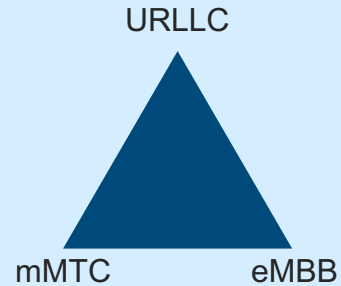

5G

*Wolfgang John, "The journey towards 6G: Going beyond connectivity services," IEEE NetSoft, Madrid, Spain, June 2023.

From 5G to 6G

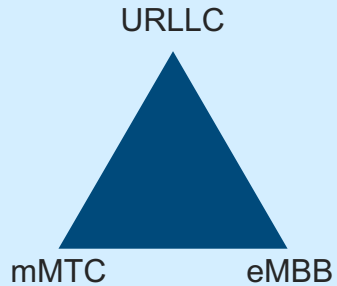

5G

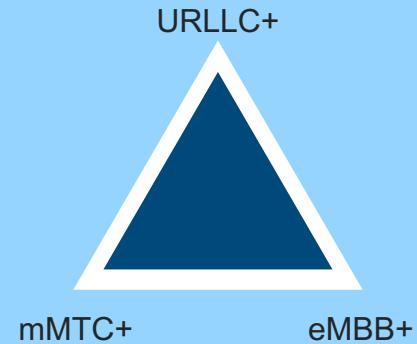

5G+

*Wolfgang John, "The journey towards 6G: Going beyond connectivity services," IEEE NetSoft, Madrid, Spain, June 2023.

From 5G to 6G

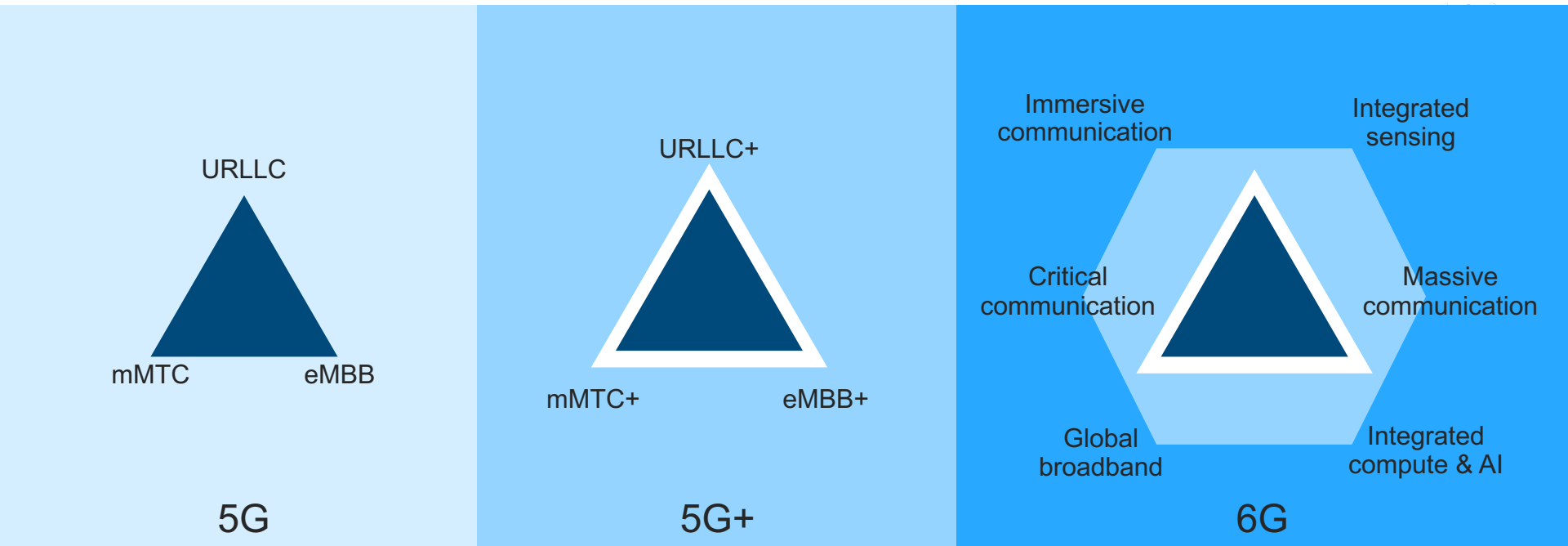

*Wolfgang John, "The journey towards 6G: Going beyond connectivity services," IEEE NetSoft, Madrid, Spain, June 2023.

6G vision

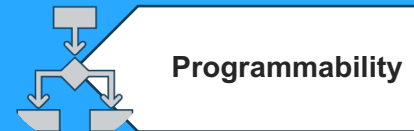
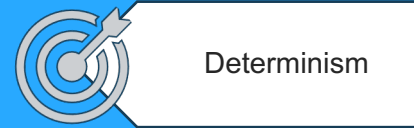
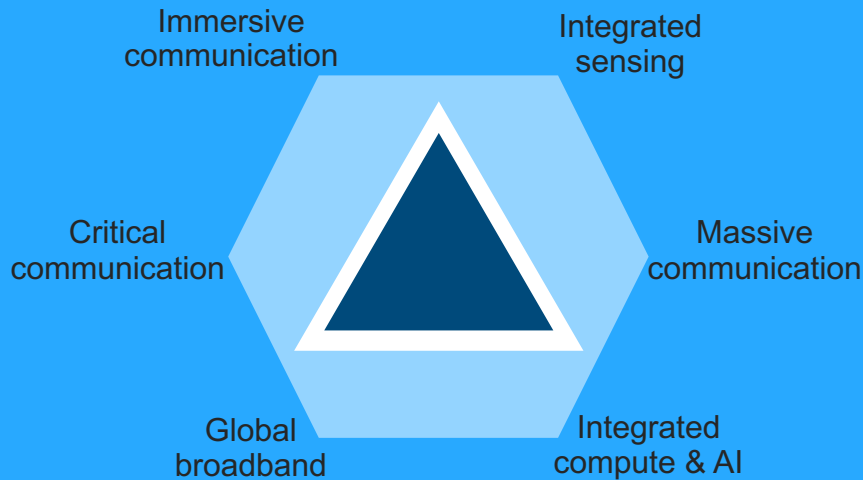

*Wolfgang John, "The journey towards 6G: Going beyond connectivity services," IEEE NetSoft, Madrid, Spain, June 2023.

** European Vision for the 6G Network Ecosystem

Use cases

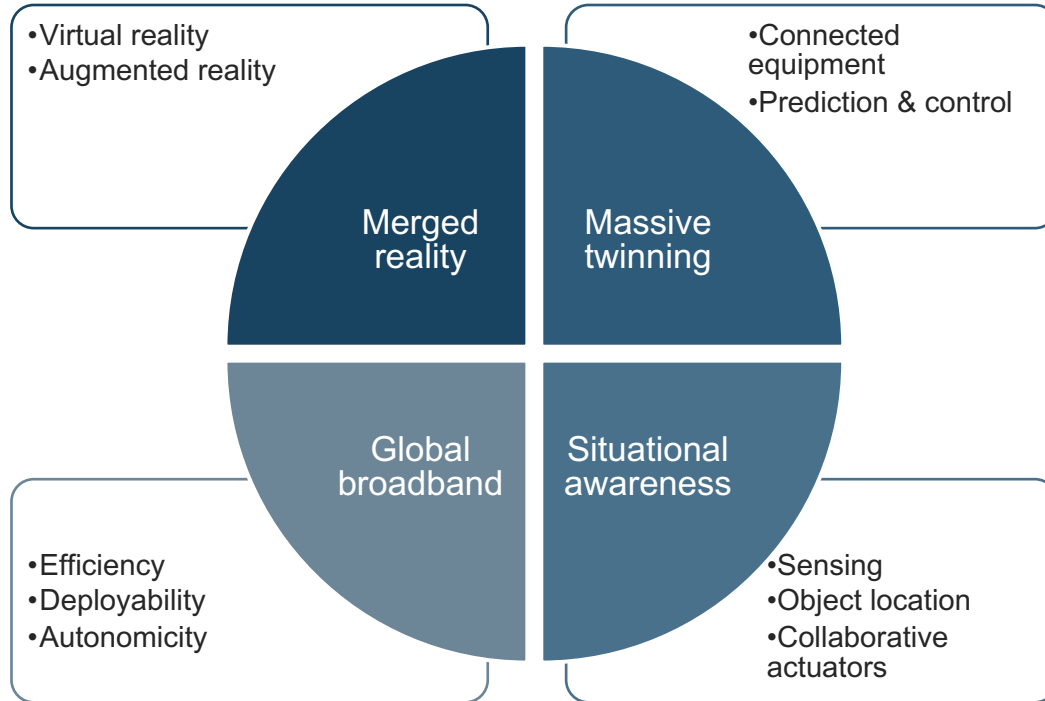

*Wolfgang John, "The journey towards 6G: Going beyond connectivity services," IEEE NetSoft, Madrid, Spain, June 2023.



Representative architecture



End-to-end apps & optimization



Multi-Domain Telemetry & Optimization



Client Apps



AI/ML Network Optimization

CHALMERS UNIVERSITY OF TECHNOLOGY

Control & orchestration

Wireless Domain Controller(s)

IP/Packet Domain Controller(s)

Optical Domain Controller(s)

Cloud Domain Controller(s)

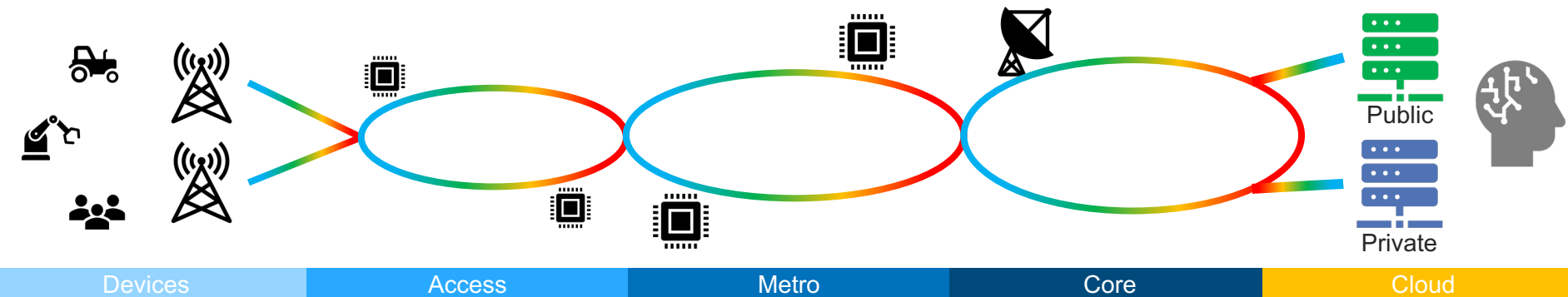

App connectivity

Traditional – Each domain switches at the packet layer to reach a centralized processing pool



Edge-based – Each domain switches at the packet layer

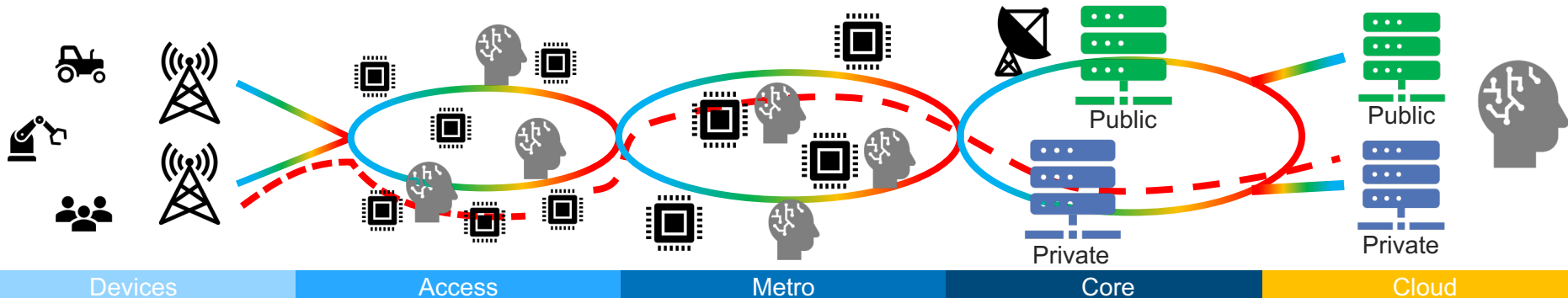
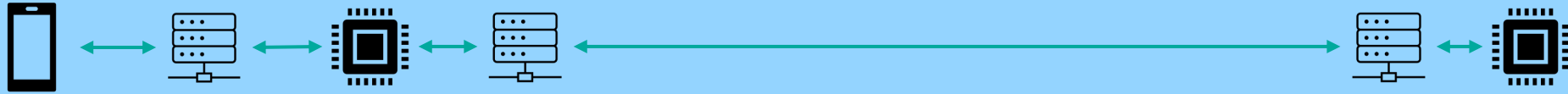

Representative architecture



2020-2021
CHALMERS
UNIVERSITY OF TECHNOLOGY

End-to-end apps & optimization

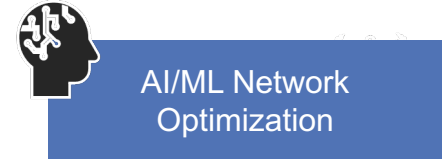
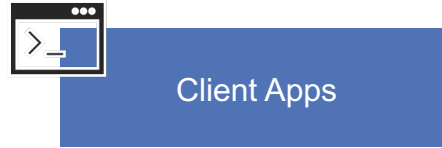
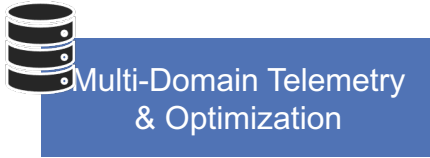

Control & orchestration

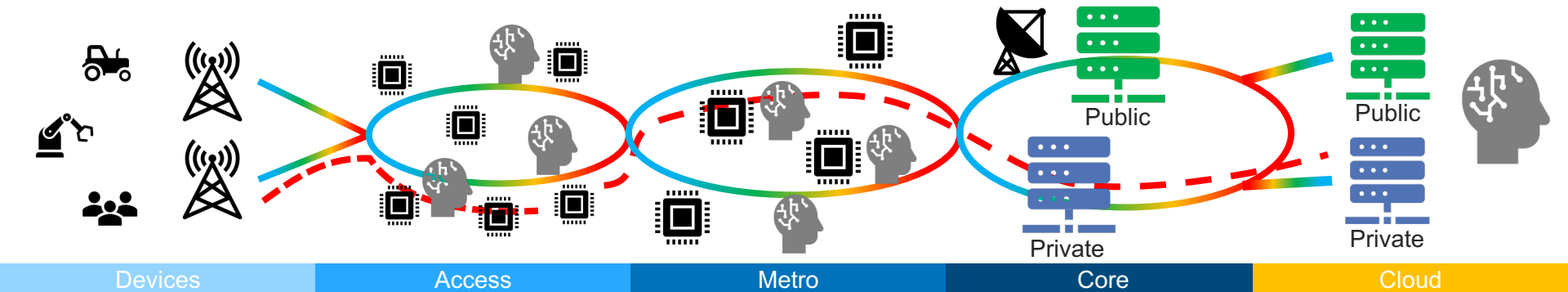
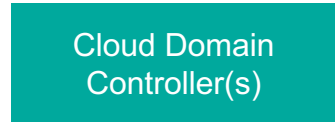
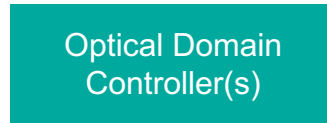
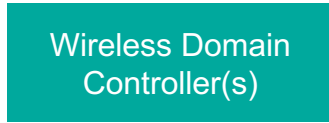

Network automation & programmability

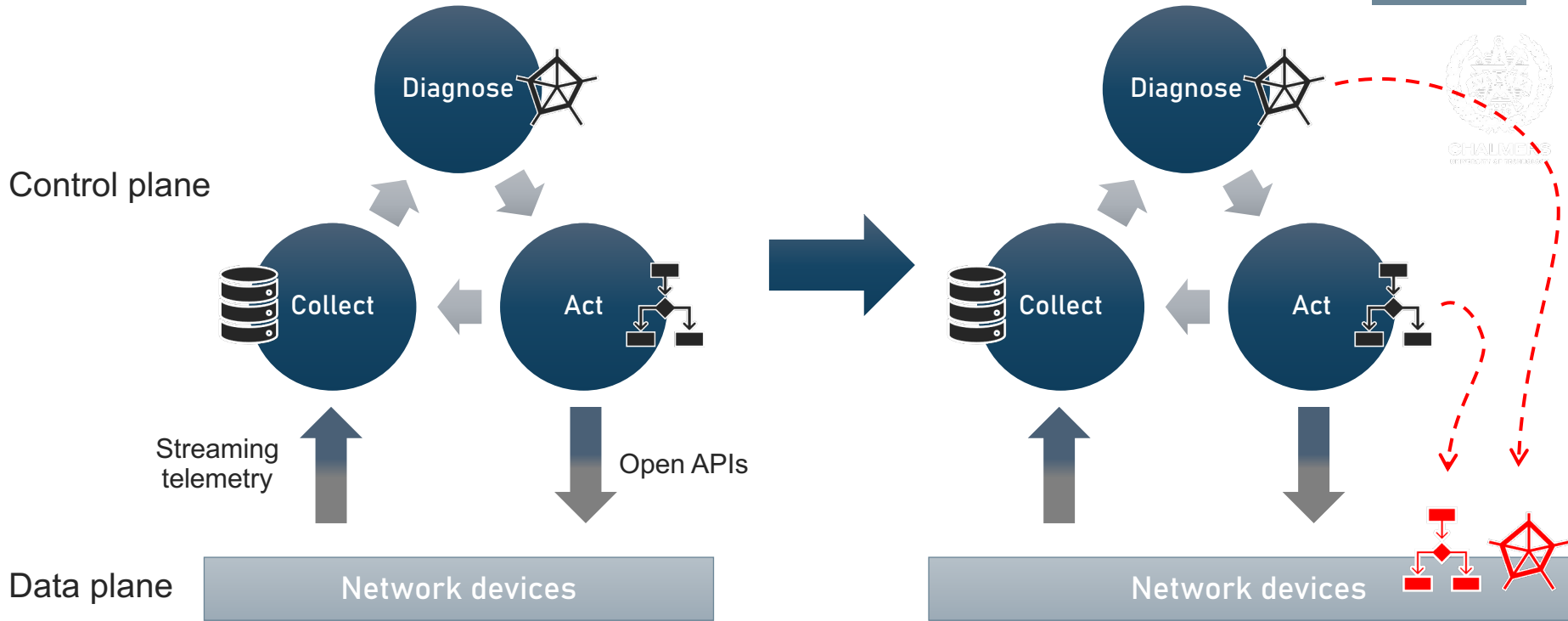

*Achim Autenrieth, "Carrier Grade AI/ML for Network Automation", invited talk, OFC 2022, 9 March 2022

Outline

Part 1

- Network generations
- 6G vision
- Use cases
- Representative architecture

Part 2

- Challenges
- State-of-the-art
 - Four representative works
- Concluding remarks

Automatic provisioning and operation

- **Key aspects:**

- Automatic provisioning
- Monitoring and response
- Distributed telemetry & control

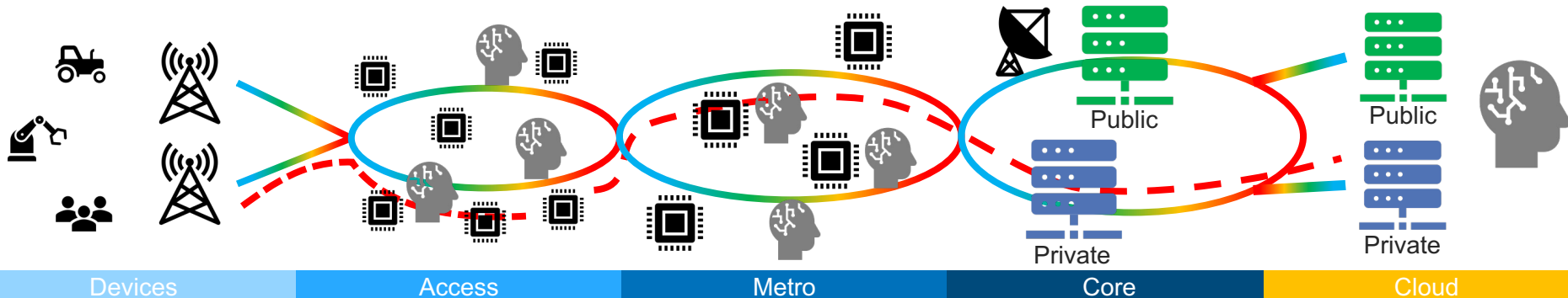

Scalable SDN Controller

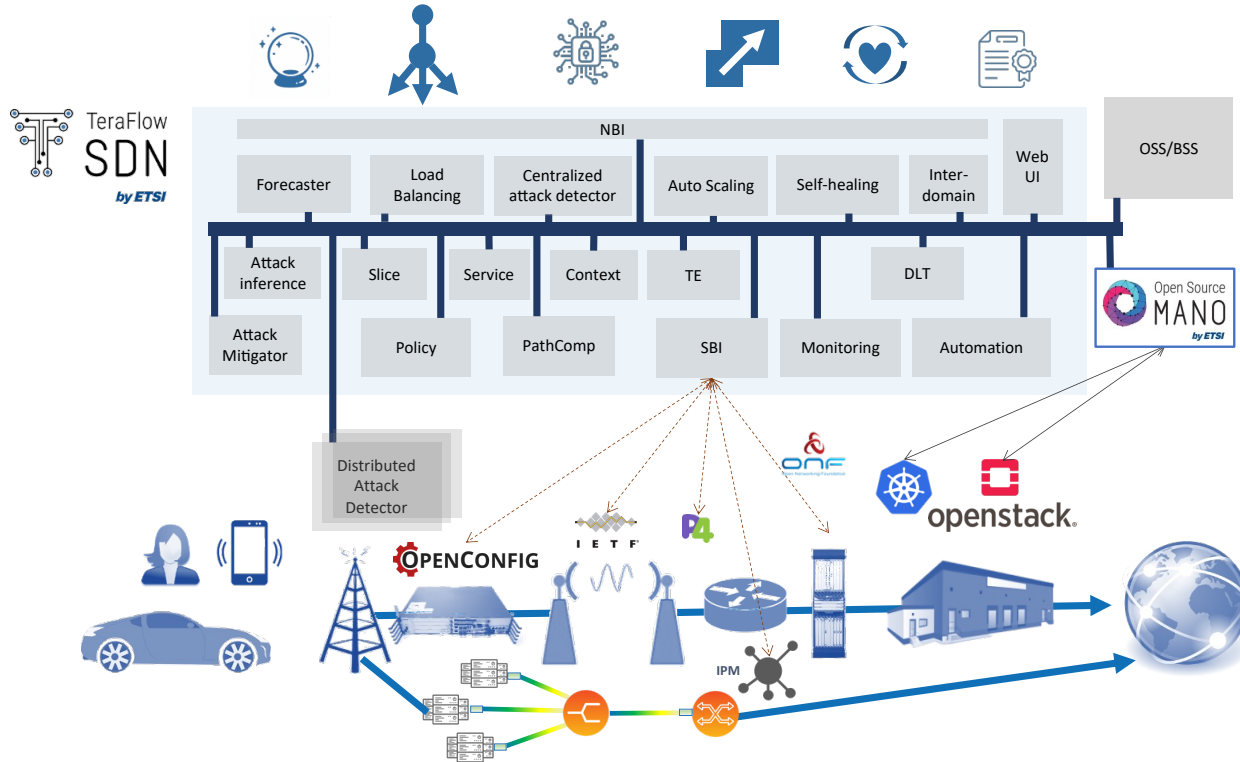

Automatic provisioning

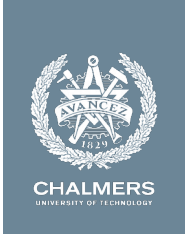
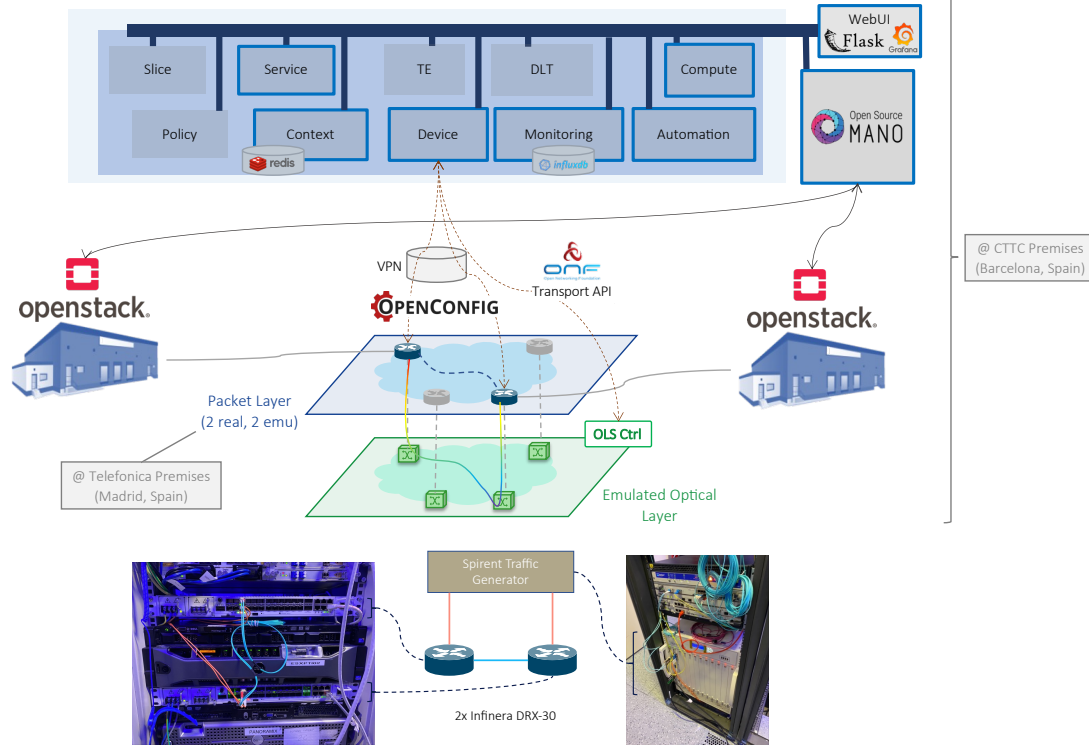
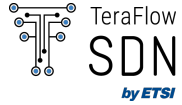

*LI. Gifre, et al., "Demonstration of Zero-touch Device and L3-VPN Service Management using the TeraFlow Cloud-native SDN Controller, OFC, 2022

Automatic provisioning

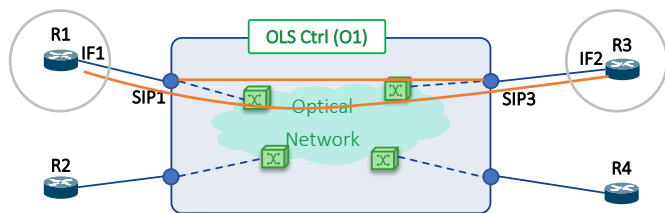

OLS Ctrl configuration set used to populate TAPI data model templates:

<u>Key</u>	<u>Value</u>
/service[svc-uuid]	input_sip: SIP1, output_sip: SIP3, layer_protocol_name: PHOTONIC_MEDIA, direction, capacity_unit, capacity_value, ...

Packet router R1 configuration set used to populate OpenConfig data model templates:

<u>Key</u>	<u>Value</u>
/interface[13/2/1]	mtu: 1512
/interface[13/2/1]/subinterface[400]	vlan_id: 400, address_ip: 3.3.2.1, address_prefix: 24
/net_inst[svc-uuid]	type: L3VRF, route_distinguisher: 65000:100
/net_inst[svc-uuid]/interface[13/2/1.400]	interface: 13/2/1, subinterface: 400
/net_inst[svc-uuid]/proto[DIRECT_CONN]	-
/net_inst[svc-uuid]/proto[STATIC]	-
/net_inst[svc-uuid]/proto[BGP]	as: 65000
/net_inst[svc-uuid]/table_conn[DIRECT_CONN][BGP][IPV4]	-
/net_inst[svc-uuid]/table_conn[STATIC][BGP][IPV4]	-
/routing_policy/bgp[rt_import]	-
/routing_policy/bgp[rt_import][route-target:65000:333]	-
/routing_policy/definition[import]/statement[3]	ext_community: rt_import, match: ANY, policy: ACCEPT_ROUTE
/net_inst[pkt-svc-uuid]/inter_instance_policies[import]	-
[last 4 repeated for export policies]	

*Ll. Gifre, et al., "Demonstration of Zero-touch Device and L3-VPN Service Management using the TeraFlow Cloud-native SDN Controller, OFC, 2022

Monitoring and response



The network must respond to failures and threats

- Physical layer attacks
- Misconfiguration
- Failures

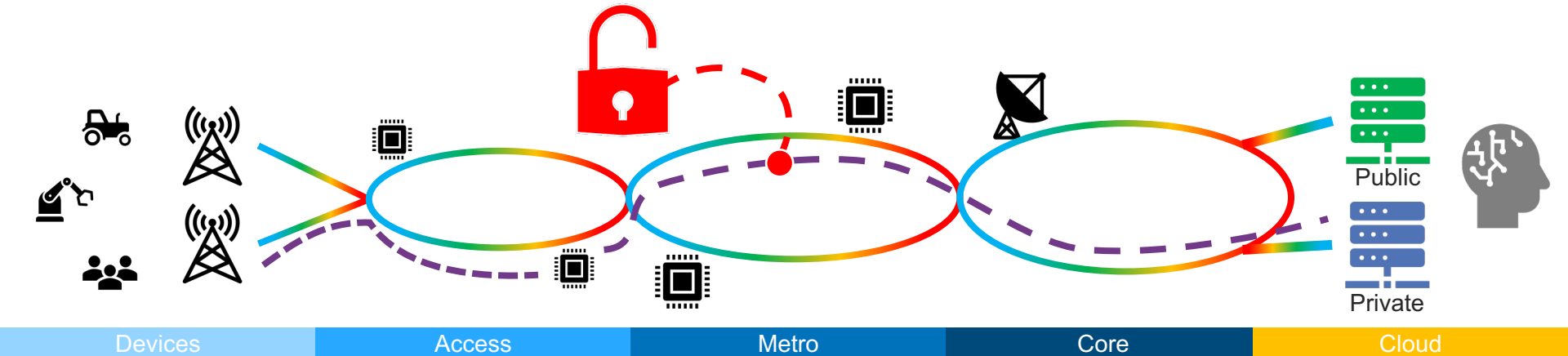

Monitoring and response

Representative results

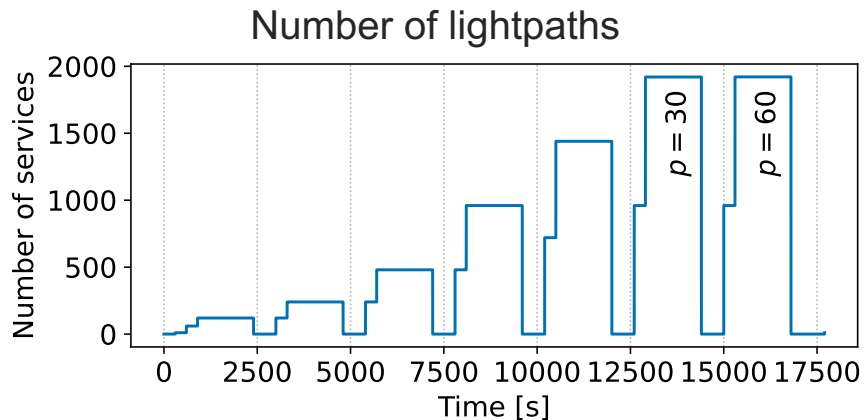

$p \rightarrow$ Target loop time

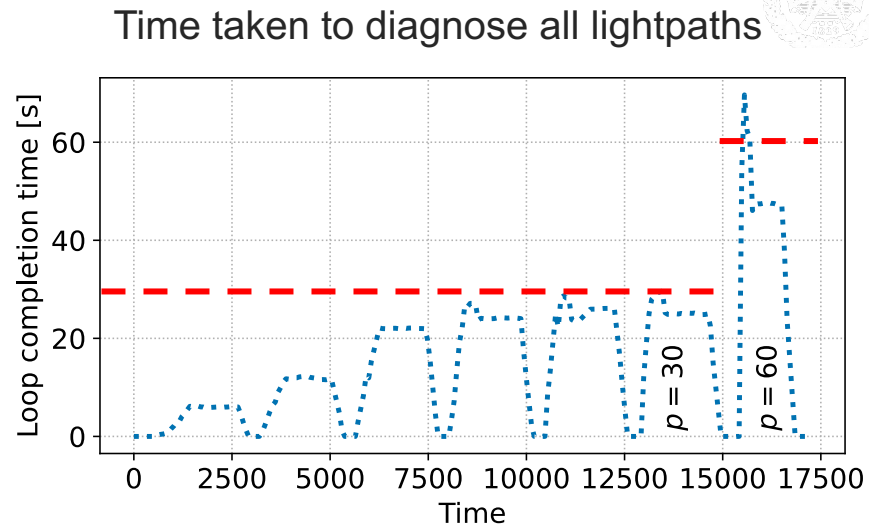

* C. Natalino et al., "Flexible and scalable ML-based diagnosis module for optical networks: a security use case [Invited]," JOCN, 2023.

Distributed telemetry & control

- **The network needs fast response to soft failures**
 - Decision can be made locally
 - Outer loop (e.g., ML-based) can decide thresholds

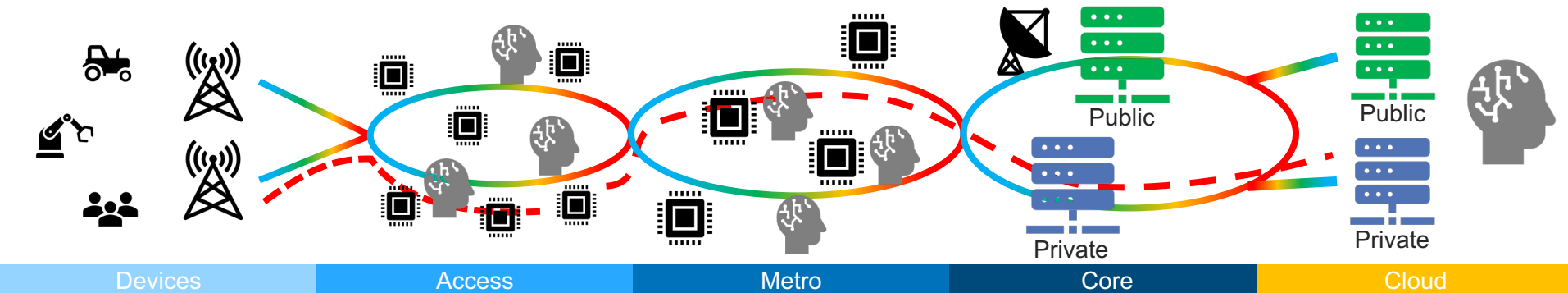

Distributed telemetry & control

Proposed solution

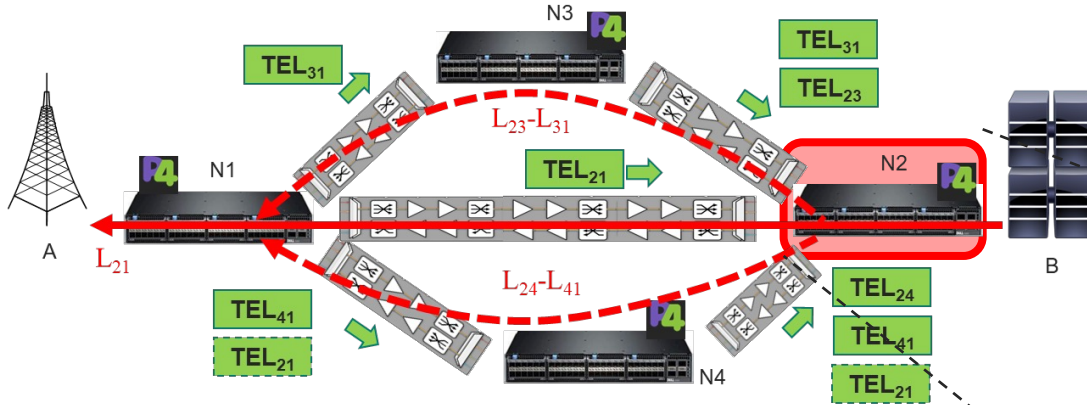

```

if  $Q_{L_{21}} \geq T_{L_{21}}$  then
  do_nothing()
else if  $Q_{L_{23}} \geq T_{L_{23}} \wedge Q_{L_{31}} \geq T_{L_{31}} \wedge \max(B_{L_{23}}, B_{L_{31}}) \geq \max(B_{L_{24}}, B_{L_{41}})$  then
  use_route( $L_{23}, L_{31}$ )
else if  $Q_{L_{24}} \geq T_{L_{24}} \wedge Q_{L_{41}} \geq T_{L_{41}} \wedge \max(B_{L_{24}}, B_{L_{41}}) > \max(B_{L_{23}}, B_{L_{31}})$  then
  use_route( $L_{24}, L_{41}$ )
end if
    
```

* F. Cugini, et al., "P4-based Telemetry Processing for Fast Soft Failure Recovery in Packet-Optical Networks," OFC, 2023, M1G.2.

Distributed telemetry & control

Performance assessment

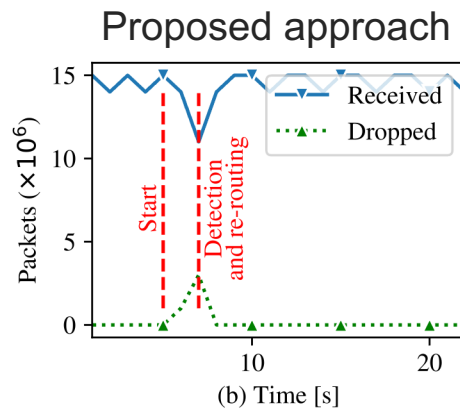
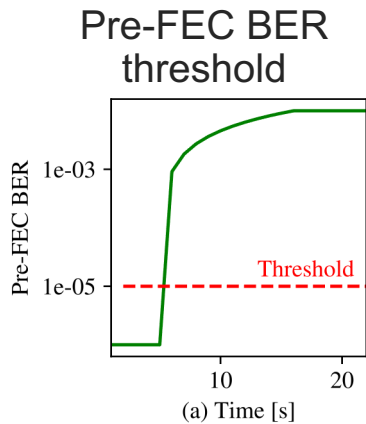

Reaction time:
2 seconds

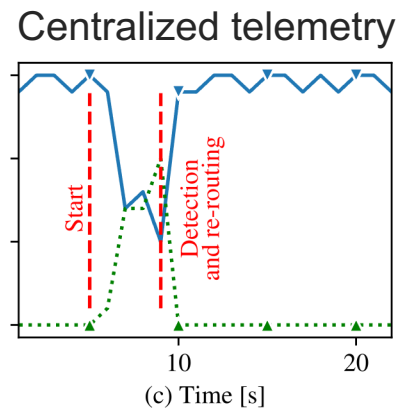

Reaction time:
5 seconds

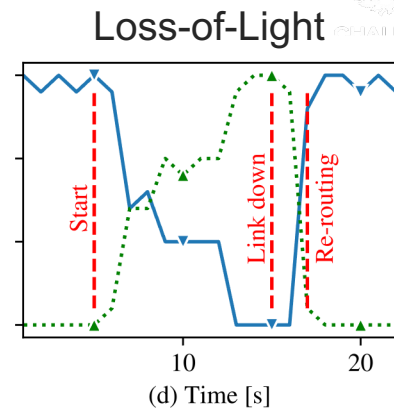

Reaction time:
10 seconds

* F. Cugini, et al., "P4-based Telemetry Processing for Fast Soft Failure Recovery in Packet-Optical Networks," OFC, 2023, M1G.2.

Ubiquitous AI/ML

- **Current way of building, deploying and maintaining AI/ML models is not scalable**
 - Numerous empirical decisions
 - Per-task model engineering
 - Model-specific workflows

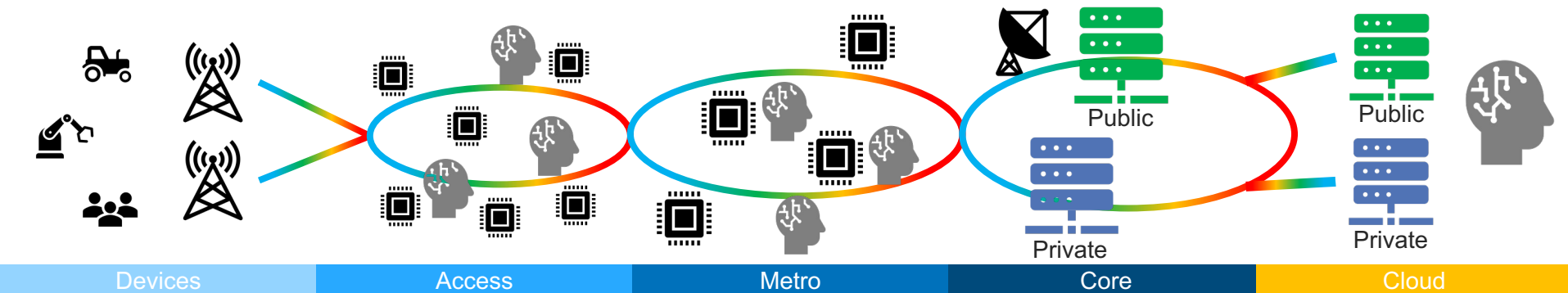

Ubiquitous AI/ML

AI/ML-as-a-Service

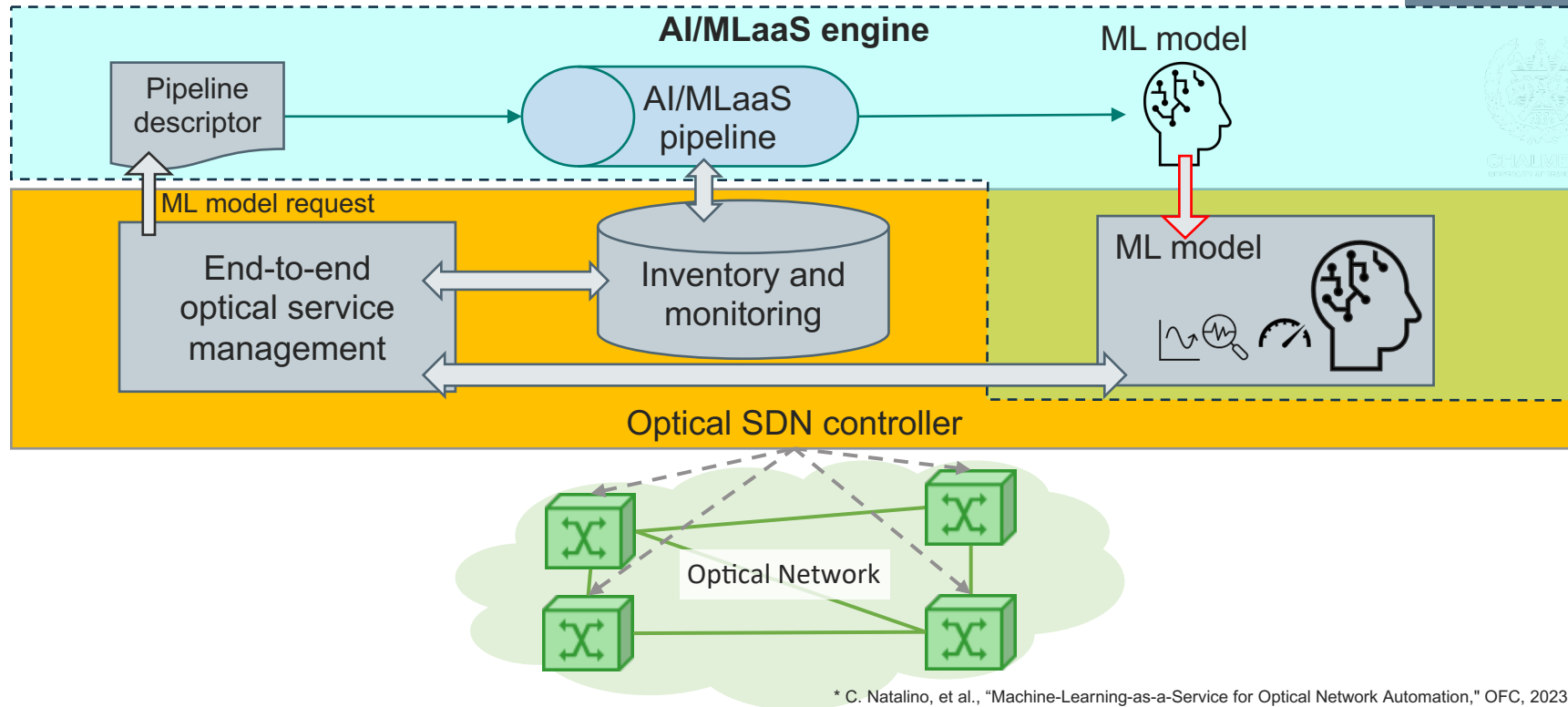

* C. Natalino, et al., "Machine-Learning-as-a-Service for Optical Network Automation," OFC, 2023, W4G.3.

Ubiquitous AI/ML

Preliminary results

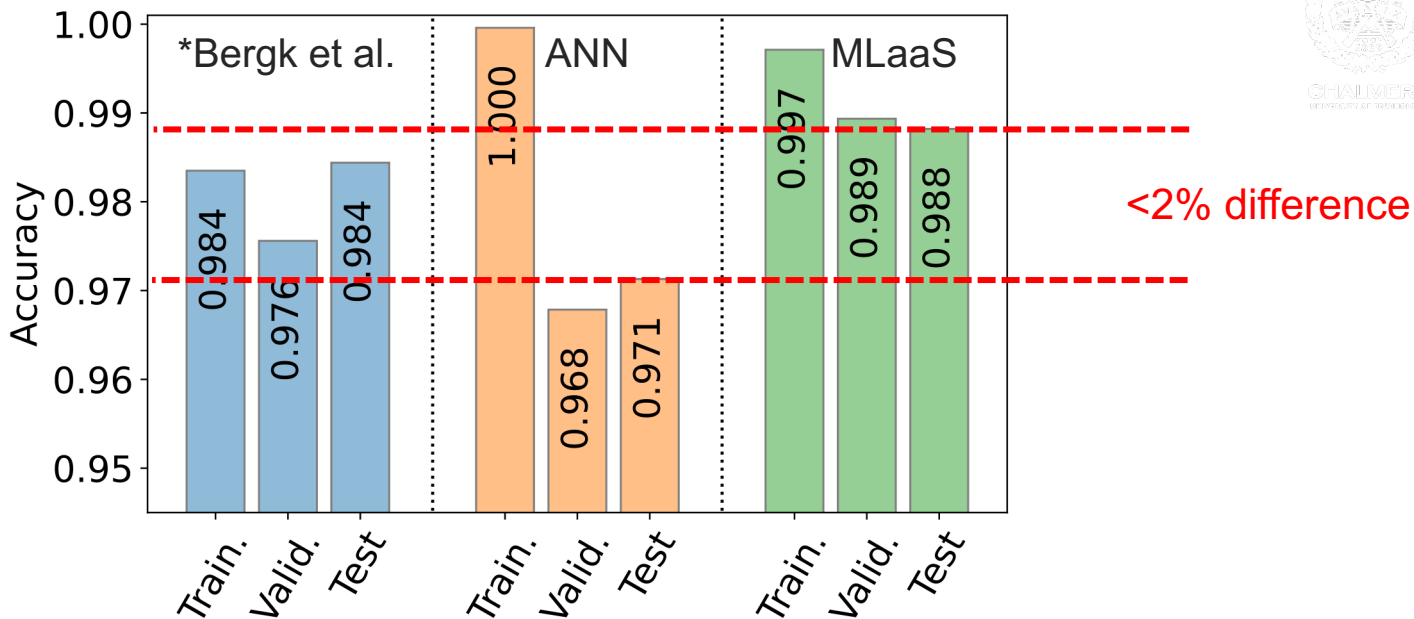

* G. Bergk et al., JOCN, 14, 43–55 (2022). DOI: 10.1364/JOCN.442733.
** C. Natalino et al., OFC, W4G.3, 2023.

Open questions



How can we make **network services more accessible** to the customers?



How can we fully realize **self-driving multi-layer multi-domain networks**?



How can we ensure the **security and privacy of the control plane** when adding automation?



Can current **open platforms and standards** handle upcoming technologies?



How can we increase the **added value** of network services?

Final remarks

- Optical networks are the ultimate technology for network slicing
 - Important milestones have been achieved over the past few years
 - Complexities and specificities of the physical layer need attention
- The role of AI/ML needs to be better understood
 - Trustworthiness, explainability, accountability, etc.
- Open APIs need continuous updates
 - Follow latest device developments
 - Enable advanced use cases



Acknowledgements



- Paolo Monti
 - Lena Wosinska
 - Marija Furdek
 - Nasser Mohammadiha
 - Ashkan Panahi
 - Ricard Vilalta
 - Lluís Gifre
 - Raul Muñoz
 - Anders Lindgren
 - Stefan Melin
 - Achim Autenrieth
 - Wolfgang John
 - Ali Balador
- Celtic-Next projects AI-NET-PROTECT and AI-NET-ANIARA
 - TeraFlow H2020
 - Chalmers' ICT Area of Advance

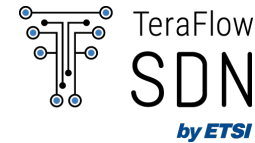
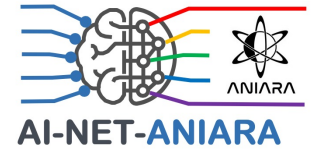
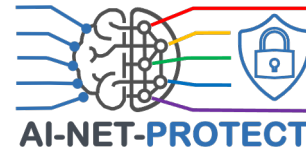

Funded by the Horizon 2020 Framework Programme of the European Union

References and further reading



- Wolfgang John, “The journey towards 6G: Going beyond connectivity services,” IEEE NetSoft, Madrid, Spain, June 2023.
- Whitepaper, “European Vision for the 6G Network Ecosystem,” 5GPPP, 2021. DOI: [10.5281/zenodo.5007671](https://doi.org/10.5281/zenodo.5007671).
- Achim Autenrieth, “Carrier Grade AI/ML for Network Automation”, invited talk, OFC 2022, 9 March 2022.
- L. Gitre et al., "Demonstration of Zero-touch Device and L3-VPN Service Management using the TeraFlow Cloud-native SDN Controller," 2022 Optical Fiber Communications Conference and Exhibition (OFC), San Diego, CA, USA, 2022.
- E. Etezadi et al., “Deep reinforcement learning for proactive spectrum defragmentation in elastic optical networks,” in Journal of Optical Communications and Networking, vol. 15, no. 10, pp. E86-E96, October 2023. DOI: [10.1364/JOCN.489577](https://doi.org/10.1364/JOCN.489577).
- C. Natalino et al., “Flexible and scalable ML-based diagnosis module for optical networks: a security use case [Invited],” in Journal of Optical Communications and Networking, vol. 15, no. 8, pp. C155-C165, August 2023. DOI: [10.1364/JOCN.482932](https://doi.org/10.1364/JOCN.482932).
- F. Cugini, et al., “P4-based Telemetry Processing for Fast Soft Failure Recovery in Packet-Optical Networks,” OFC, San Diego, CA, USA, 2023. DOI: [10.1364/OFC.2023.M1G.2](https://doi.org/10.1364/OFC.2023.M1G.2).
- C. Natalino, et al., “Machine-Learning-as-a-Service for Optical Network Automation,” OFC, San Diego, CA, USA, 2023. DOI: [10.1364/OFC.2023.W4G.3](https://doi.org/10.1364/OFC.2023.W4G.3).



*The latest version of this slide set can be found here: <https://research.chalmers.se/en/publication/537646>

Thank you! 😊



This presentation



Chalmers profile



GitHub page

Thank you! 😊

Optical Network Automation and Programmability for 6G: State-of-the-Art, Vision, and Challenges

Carlos Natalino

Researcher

Optical Networks Unit

Department of Electrical Engineering

Chalmers University of Technology

<https://www.chalmers.se/en/persons/carda/>

<https://github.com/carlosnatalino>



CHALMERS
UNIVERSITY OF TECHNOLOGY