

Developing and validating the multidimensional industry commitment scales: The perspective of vocational high school students

Tuatul Mahfud¹, Nurally Masum Aprily², Ida Nugroho Saputro³, Ibnu Siswanto⁴, Suyitno Suyitno⁵

¹Hospitality Department, Balikpapan State Polytechnic, Balikpapan, Indonesia

²Early Childhood Education Department, Faculty of Science Education, Universitas Pendidikan Indonesia, Bandung, Indonesia

³Building Engineering Education Department, Faculty of Teacher Training and Education, Sebelas Maret University, Surakarta, Indonesia

⁴Automotive Engineering Education Department, Engineering Faculty, Universitas Negeri Yogyakarta, Yogyakarta, Indonesia

⁵Automotive Engineering Education Department, Faculty of Teacher Training and Education, Universitas Muhammadiyah Purworejo, Purworejo, Indonesia

Article Info

Article history:

Received Mar 3, 2021

Revised Nov 26, 2021

Accepted Dec 23, 2021

Keywords:

Confirmatory factor analysis

Industry commitment

Questionnaire validation

Vocational education

ABSTRACT

Industry commitment plays a vital role in vocational education programs, especially in vocational high schools. The involvement of the industry is the key to the success of implementing vocational education. However, how to measure industry commitment in vocational learning is still not discussed. This study aimed to develop and test the validity of an industry commitment questionnaire. The industrial commitment questionnaire validation test gradually used three techniques, namely, content validity test, pilot test, and confirmatory factor analysis (CFA). The respondents were 390 culinary students of seven state vocational schools in Yogyakarta Special Region Province, Indonesia. This study revealed that industrial commitment can be measured by 12 items of industry commitment questionnaire consisting of four career opportunity items, two performance assessment items, four involvement/participation items, and two empowerment items. This study fills a gap in the assessment of industry commitment to engagement in vocational education programs. This study has implications for vocational education practitioners to evaluate the extent of industry commitment to vocational education programs.

This is an open access article under the [CC BY-SA](https://creativecommons.org/licenses/by-sa/4.0/) license.



Corresponding Author:

Tuatul Mahfud

Hospitality Department, Balikpapan State Polytechnic

Balikpapan, East Kalimantan 76129, Indonesia

Email: tuatul.mahfud@poltekba.ac.id

1. INTRODUCTION

The industry has a vital role in the concept of vocational education. The involvement of the graduate user community or industry in the education process in schools is an essential component for the achievement of student competencies [1]–[4]. This is because the concept of vocational education always considers market needs in the world of work. Thus, harmony between the world of work and the world of education is a top priority in the development of vocational training. Therefore, industry commitment to be involved in learning activities in vocational schools is the key to the success of vocational education management. The involvement of the industry in learning in vocational schools aims to ensure that graduate's qualifications are following the needs of the world of work.

According to Castro [5], industry commitment in the form of participation plays a significant role in shaping the competencies of prospective workers who are successful in apprenticeship programs. Meanwhile, according to Burns and Chopra [6], the involvement of industry in the learning process can provide tangible experiences that are beneficial for: i) Increasing student network connections with professionals who have the potential to provide job references and job positions in the future; ii) Allowing students to gain practical experience by observing and applying methods and theories learned in the classroom to real-world scenarios; iii) Enabling students to gain experience in their prospective career paths; and iv) Enhancing students' professional communication skills. Every industry engagement provides students with valuable learning experiences. In general, industry commitment to vocational education programs is manifested in the form of a partnership program.

The partnership between vocational education institutions and the business/industry world is the key to the success of the provision of vocational education. However, several obstacles often arise in partnership programs, including a lack of awareness, information, and support, which leads to an overly negative perception of administrative burdens [7]. Broadbent and McCann [8] stated that there are three principles of industrial involvement in academic programs, namely that the industry must develop the motivation and skills of workers to be involved in educational programs, must provide authentic materials and resources freely, and must invest for education programs. Thus, it can be understood that industry commitment is significant for the success of vocational education programs.

Although industry commitment plays an essential role in the delivery of vocational education until now, we have not found any studies that discuss how to measure industry commitment in occupational learning activities in vocational schools. Therefore, this study aimed to develop a questionnaire on industry commitment in vocational education programs at vocational high school. This study also examined the validity of the industry commitment questionnaire using the confirmatory factor analysis (CFA) technique. This questionnaire is useful for vocational schools to evaluate partnership programs with industry parties.

Vocational education must be able to be designed by considering the needs of the graduate user environment, student characteristics, and the development of science and technology. This principle is the main thing in developing vocational education curriculum designs, especially in vocational high schools. The development of curriculum design and learning in vocational education places a lot of emphasis on involving graduate users, namely industry. Previous studies on work-based learning (WBL) recommended the importance of introducing specific legislation on WBL initiatives: i) Setting specific requirements for companies wishing to participate in WBL initiatives; ii) Making a general list for companies that are entitled to hold duplicate training; implementation of the WBL program quality assurance system; iii) Introduction of formal incentives for entrepreneurs participating in WBL initiatives [9]. Thus, it can be understood that the role of industry is crucial in the implementation of vocational education programs.

Industry involvement in learning contributes to the formation of student competencies [7], [10]–[13]. Industry engagement not only enhances learning for students, but also provides a vision of their future career. Likewise, industry representatives get the opportunity to interact with students to learn about students' curricula and expertise [6]. An effective partnership between schools and industries can optimize industry engagement activities to provide the most beneficial learning experience for students [6], [10], [11] [14], [15]. According to Herrmann [10], industry involvement in the learning process can develop students' skills. Empirically, the internship program is very beneficial for employees to get the opportunity for innovations and transfer of ideas and easy to get a job [16]. Apprenticeship can enable organizations to quickly acquire essential skills by upgrading the skills of their existing employees and taking in new candidates for training [17]. In addition, apprenticeships also provide technical and non-technical skills for apprentices. The findings of previous studies indicate that the role of industry in learning practices has an impact on the development of technical and non-technical skills.

Therefore, a commitment is needed in building partnerships and engagement with industry in the form of harmonization between the world of education and the industrial world to face the dynamics of accelerated changes occurring in the business world and the industrial world. The quality of the relationship between industry and education will inevitably influence individual professional development [18]. On the other hand, symbiotic and mutually beneficial relationships will increase the chances of students' professional development [17], [19]. According to Gross *et al.* [20], the development of an authentic and trusting relationship are both interrelated to building an effective school-industry partnership. But unfortunately, this relationship is often characterized by a lack of trust, understanding, and a shared vision. It seems that the industry has an entirely different plan compared to educational institutions. Theoretically, this is logical because the industry has a profit orientation, which is contrary to the mission of most educational institutions. The role of industry in vocational learning is defined as to what extent the industry's commitment to be involved in the preparation and development of human resources to enter the world of work. Management commitment plays an important role in an organization [21], [22].

Meanwhile, engagement refers to the mental and emotional involvement of a person in a group situation, which encourages to contribute to the group's goals and share the responsibility for achievement [23]. Thus, industry commitment can be defined as the active contribution of the industry in various education and training programs in vocational education in the form of support for personnel, thoughts, and materials as well as responsibility for any decisions that have been taken to achieve mutually determined goals. Some examples of industry contributions to vocational education programs in schools include the implementation of workplace learning (work-based learning), guest teachers, curriculum preparation, or other teaching activities that are agreed upon between the two parties between the school and industry.

Based on previous studies, it can be understood that the role of industry commitment is significant for the success of vocational learning. However, how to measure industry commitment in vocational learning is still not clearly discussed. Therefore, this study aims to develop and test the validity of the industrial commitment questionnaire using the CFA. In management commitment theory, Cheung and To [24] stated that management commitment is described by three attributes, which include management service vision, involvement, and empowerment. High commitment to human resource management could be explained by indicators of compensation, career opportunities, participation, performance appraisal, training, and development [25]. Referring to this research, the study developed a questionnaire to measure industry commitment adopting the two previous studies [24], [25]. The development of this study's industrial commitment questionnaire includes indicators of compensation, career opportunities, performance appraisals, involvement/participation, and empowerment. The results of this study are essential for hotel practitioners or vocational education institutions to evaluate the extent of involvement of the industry in the success of vocational learning.

2. RESEARCH METHOD

This study involved culinary students at seven state vocational high schools in the Yogyakarta Special Region Province, Indonesia. The number of students who filled out the questionnaire was 390 students consisting of 46 male students and 344 female students as shown in Table 1. Data were collected using self-administered questionnaires, in which respondents answered the questions contained in the survey without any help from data collectors [26]. The poll was delivered to the respondents directly and taken back by the data collector.

Table 1. Background of participants (N=390)

Attribute	Categories	N	%
Gender	Male	46	11.8
	Female	344	88.2
School	Culinary School A	50	12.8
	Culinary School B	51	13.0
	Culinary School C	34	8.7
	Culinary School D	23	5.9
	Culinary School E	39	10
	Culinary School F	78	20
	Culinary School G	115	29.6

Data on industry commitment is disclosed using the Industry Commitment Questionnaire, developed and adapted from previous studies [24], [25]. Referring to the study, there are important indicators in revealing industry commitment, namely compensation, career opportunities, performance appraisal, involvement/participation, and empowerment. The total questionnaire items are 20 items consisting of five compensation items, five career opportunity items, five performance assessment items, five involvement/participation items, and five empowerment items. This questionnaire uses a 5 Likert scale which includes strongly agree=5, agree=4, somewhat agree=3, disagree=2, disagree=1.

This study uses three stages to test the validity of the industry commitment questionnaire. The first stage is the content validity test, and this stage involves expert judgment to assess the relevance of the industry commitment questionnaire items. Three expert judgments are consisting of experts on psychometric, culinary education, and vocational education. The weighted score for the relevance of items with indicators uses 5 Likert scales consisting of irrelevant=1, less relevant=2, quite relevant=3, relevant=4, highly relevant=5. Furthermore, the data were analyzed using Aiken V [27].

The second stage is the validation of the industry commitment questionnaire using a pilot test with a small sample. The samples involved were 59 respondents. Validation analysis at this stage uses Pearson correlation analysis at a significance of 5% (0.05). Furthermore, the reliability test at this stage uses the

Cronbach's Alpha value with the criteria above 0.7 [28]. Data analysis using the software program SPSS 19.0 for Windows Evaluation Version. Finally, researchers use the construct validity test to test the construct validity of each dimension of industry commitment. At this stage, we use CFA. Previous study also used the CFA to develop a vocational behavior questionnaire [18]. CFA was performed with the help of SPSS Amos 21 for Windows. This instrument development study uses an acceptable limit for the standardized loading factor value or the lambda (λ) parameter value above 0.5 [29].

3. RESULTS AND DISCUSSION

3.1. Content validity

In the first stage, the results of the content validity analysis using Aiken V showed that the content-validity coefficient (Aiken index) on 20 industry commitment questionnaires ranged from 0.92 to 1.00. The Aiken V index means that the entire industry commitment questionnaire items have high validity because they have an Aiken V index of more than 0.8 [28].

3.2. Pilot test

In the second stage, we conducted a pilot test to test the validity and reliability of the industry commitment questionnaire. This pilot test involved a small sample of 59 respondents. The results of the analysis with Pearson Correlation Analysis show that there are four invalid instruments because they have a correlation significance value above 0.05 (Table 2). These items are one item from the compensation indicator (Comp4, $r=0.152$, $p=0.250$), two items from the performance appraisal indicator (PA1, $r=0.152$, $p=0.251$; PA2, $r=-0.004$, $p=0.977$), and one item from the empowerment indicator (Empow1, $r=0.162$, $p=0.220$). Furthermore, these four items were not used in the subsequent analysis. Thus, the total number of questionnaire items used to measure industry commitment is 16 items consisting of compensation (three items), career opportunities (four items), performance appraisal (two items), involvement/participation (four items), and empowerment (three items). Table 2 shows the Pearson product moment values of the 16 items ranging from $r=0.269$ to $r=0.702$ and significant at the 0.05 significance level.

Table 2. Validation and reliability test of industry commitment scale (16 items)

Item	Pearson Correlation	Sig. (2-tailed)	Cronbach's Alpha if item deleted
Comp1-Comp3	0.409** ~ 0.629**	0.000 ~ 0.001	0.799 ~ 0.822
CO1-CO4	0.269* ~ 0.583**	0.000 ~ 0.040	0.804 ~ 0.828
PA3-PA4	0.649** ~ 0.702**	0.000	0.800 ~ 0.803
Part1-Part4	0.554** ~ 0.621**	0.000	0.801 ~ 0.805
Empow2-Empow 4	0.410** ~ 0.626**	0.000 ~ 0.001	0.804 ~ 0.816

**Correlation is significant at the 0.01 level (2-tailed).

*Correlation is significant at the 0.05 level (2-tailed).

Note: Comp=compensation indicator item; CO=career opportunity indicator items; PA=performance appraisal indicator items; Part=participation indicator items; Empow=empowerment indicator items.

The reliability analysis of the industry commitment questionnaire shows that the entire industry commitment questionnaire has a Cronbach's Alpha value of 0.818. This value is above 0.700 and means that this instrument is considered reliable to measure industry commitment. Besides, the reliability per item also shows the Cronbach's Alpha (Cronbach's Alpha if item deleted) value above 0.700, and this result means that all items are reliable to measure industry commitment (Table 2).

3.3. Content validity

The results of the CFA test on the industrial commitment questionnaire are shown in Figure 1. The estimation results of the measurement model in Figure 1 using the Maximum Likelihood estimation in Amos show good fit model results. However, there is still a standardized loading factor value or lambda parameter value (λ) below 0.5 in item Empow4 ($\lambda=0.49$). This study uses the critical loading factor limit value or parameter value λ (lambda), which is at least 0.5 [29]. Furthermore, Empow4 items are eliminated from the model, and then running on the modified model is carried out.

The estimation results of the measurement of the model in the modified model as seen in Figure 2 show a good fit model result with the loading factor value on all items above $\lambda=0.50$ (Table 3). The fit model test shows that the criteria for Cmin/df (2.001), GFI (0.948), AGFI (0.923), RMSEA (0.051), RMR (0.043), TLI (0.945), CFI (0.958), and NFI (0.921) provide a suitability index that matches the recommended limits. However, the Chi-square criteria and probability level show that the requirements are not fit because they cross the recommended limits. Overall, eight indices show the fit model results. Thus, it can be concluded that the measurement model in the industrial commitment questionnaire construct has a good fit.

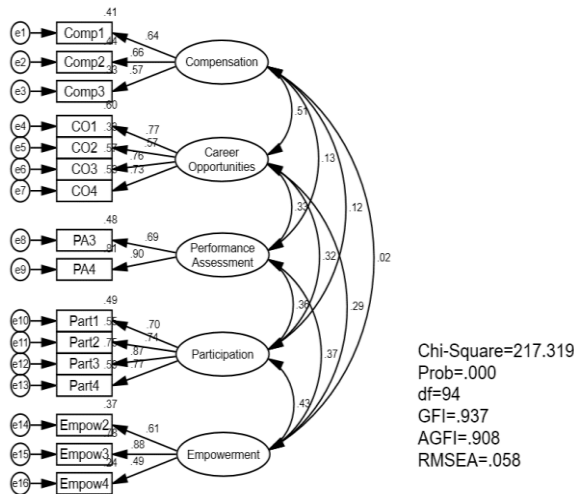

Figure 1. Measurement model of industry commitment scale

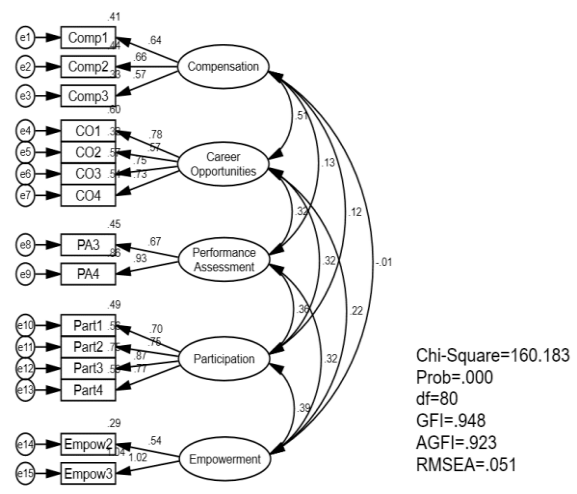

Figure 2. The modified measurement model of industry commitment scale

Meanwhile, the results of the standardized loading factor value in the modified model on each item also showed the parameter value of λ (lambda) above 0.5 (Table 3). This result means that all 15 items are declared valid to measure the perceptions of the culinary arts department vocational high school students towards industrial commitment. Besides, these results are also indicated that industry commitment can be explained significantly together by indicators of compensation, career opportunities, performance appraisals, involvement/participation, and empowerment.

Table 3. Standardized regression weights on each item of industrial commitment scale

Path	Estimate	P-value	Construct reliability	
Comp1–Comp3 <---	Compensation	0.575 ~ 0.662	***	0.500
CO1–CO4 <---	Career opportunities	0.570 ~ 0.775	***	0.760
PA3–PA4 <---	Performance assessment	0.673 ~ 0.928	***	0.880
Part1–Part4 <---	Participation	0.698 ~ 0.866	***	0.927
Empow2–Empow3 <---	Empowerment	0.536 ~ 1.020	***	0.830

***Very small p-value (less than 0.001)

The reliability test in this study used the construct reliability value reference in SEM. This test is used to determine the reliability and consistency of data from a research instrument. The criterion limit for acceptance of construct reliability value is >0.7 . The results of the construct reliability test on the industrial commitment questionnaire are shown in Table 3. These results indicate that there are indicators that have a construct reliability value below 0.7. That is, the compensation indicator (compensation) is not reliable to measure industry commitment. Furthermore, this indicator is not used to test the SEM model. Meanwhile, other indicators such as career opportunities, performance assessment, participation, and empowerment have con-struct reliability values above 0.7. Thus, industry commitment can be explained or can be measured by indicators of career opportunities, performance appraisal, participation, and empowerment.

3.4. Discussion

Industry commitment is the key to the success of implementing vocational education programs, especially in vocational high schools. Therefore, the industry's commitment to engage in vocational learning activities is an effort to ensure that the concept of education and qualifications of graduates is following the needs of the world of work. Previous studies have not discussed how to measure industry commitment to vocational education programs in vocational high schools. Therefore, this study aimed to develop and test the validity of an industry commitment questionnaire using Aiken V analysis, Pearson Product Moment analysis, and CFA.

The results of this study reveal that the Industry Commitment Questionnaire can measure students' perceptions of industrial commitment in vocational learning in vocational high schools. In the validation test process, several items were eliminated. The questionnaire validity testing procedure used three stages, namely the analysis of the content validity test, the pilot test, and the construct validity test. A total of 20

items from the Industry Commitment Questionnaire have been reduced to 12 items after the validity and reliability tests. In the first stage, the content validity test using Aiken V analysis shows that all items (20 items) are declared valid and relevant. However, four items (Comp4, PA1, PA2, Empow1) are eliminated in the pilot test sample is small because it has a p-value above 0.05.

Furthermore, 16 items of this questionnaire were tested for validation using CFA with Amos. At the CFA test stage, one item was omitted because it had a standardized loading factor value below 0.5, namely the Empow4 item ($\lambda=0.49$). Thus, obtained 15 valid questionnaire items to measure students' perceptions of industrial commitment in vocational learning in vocational high schools. The Industry Commitment Questionnaire consists of compensation (three items), career opportunities (four items), performance appraisal (two items), involvement/participation (four items), and empowerment (two items).

Meanwhile, in the reliability test of the industry commitment indicator, it was found that an unreliable indicator was the compensation indicator. This indicator has a construct reliability value of 0.5 ($CR<0.7$), so this indicator does not represent industry commitment. This finding means that compensation in the form of incentives for apprentices, fair holidays, and dining facilities for apprentices cannot be used as a reference to measure the extent of industry commitment. The provision of this compensation does not yet have legal force in the form of a government regulation that requires industry to provide compensation to apprentices, so it is only natural that not all industries offer such compensation. For the industry, the provision of payment is considered not profitable and tends to be detrimental to industrial growth. Understanding like this is often found because the industrial world has a business orientation that leads to a profit orientation (profit-oriented).

Meanwhile, other indicators, such as career opportunities, performance assessment, participation, and empowerment, have very high reliability ($0.80<\alpha\leq 1.00$) to explain industry commitment [30]. These four indicators can demonstrate industry commitment, because it has a construct reliability value above 0.7. The participation indicator has the most significant explanatory power for industry commitment compared to other indicators. This result is highly relevant to previous studies which state that industry commitment in the form of participation is significant in shaping the competencies of successful prospective workers through apprenticeship programs [5]. Optimizing the involvement of the industry in learning at vocational high schools also encourages the development of student skills [10]. Thus, it is very appropriate to link industry commitment with how much they are involved in the learning program at vocational high schools.

The second level explanatory indicator for industry commitment is performance appraisal. In addition to the critical role of involvement or participation, it is also considered very important for the industry to actively participate in conducting guidance and evaluating student learning outcomes through apprenticeship programs. Students get an evaluation of their performance appraisal during their internship program from the industry. Furthermore, the industry follows up on the results of the assessment for the continuous improvement process of vocational students' competencies. Also, the empowerment indicator ranks third in reliability to explain industry commitment. This indicator describes how much trust the industry has to empower students in operational work activities in the industry. In this aspect, it is often found that the industry does not fully trust students to do operational work in the industry. Students are only given pre-operational tasks such as preparing ingredients and cleaning cooking utensils. This condition can occur due to several things, and for example, students do not have excellent skills to do operational tasks in the industry. Furthermore, career opportunity indicators have the lowest reliability in explaining industry commitment. This indicator illustrates the extent to which the industry provides access to students for careers in the industry where they are apprenticed.

4. CONCLUSION

This study showed that culinary students' perceptions of industry commitment can be explained by indicators of career opportunities, performance appraisals, participation, and empowerment. Aiken V analysis to test the validity of the content shows that all items (20 items) of the questionnaire have high validity to measure industry commitment. Furthermore, in the pilot test, there were four invalid items, namely Comp4, PA1, PA2, and Empow1, so the industry commitment questionnaire items totaled 16 items. Finally, the CFA analysis to construct validity revealed that one item was invalid (Empow4, $\lambda=0.49$). So that at this stage, the industrial commitment questionnaire consists of 15 items. In the final stage of reliability, testing shows that the compensation indicator is eliminated because it has a value of construct reliability <0.7 . The last total items that are declared valid and reliable to measure industry commitment are 12 items consisting of career opportunities (four items), performance appraisal (two items), involvement/participation (four items), and empowerment (two items).

The results of this study provide important implications for vocational education institutions to evaluate the involvement and commitment of the industry in learning activities in vocational high schools.



Furthermore, the evaluation results of industry commitment can be used as a reference in improving the concept of vocational education, especially in developing WBL. The development of structural model research involving industry commitment factors and various important factors to cultivate the skills of vocational high school students needs to be done.

REFERENCES



- [1] S. McAlister, "Why community engagement matters in school turnaround," *Voices in Urban Education*, vol. 36, pp. 35–41, 2013.
- [2] Y. K. Penny Wan, I. A. Wong, and W. H. Kong, "Student career prospect and industry commitment: The roles of industry attitude, perceived social status, and salary expectations," *Tourism Management*, vol. 40, pp. 1–14, Feb. 2014, doi: 10.1016/j.tourman.2013.05.004.
- [3] T. O. Kowang *et al.*, "Industry 4.0 competencies among lecturers of higher learning institution in Malaysia," *International Journal of Evaluation and Research in Education (IJERE)*, vol. 9, no. 2, pp. 303–310, Jun. 2020, doi: 10.11591/ijere.v9i2.20520.
- [4] L. Indana, "Evaluation of Job Absorption of Vocational High School Graduates in the Computer and Informatics Engineering Expertise Study Program in Trenggalek Regency (in Indonesian)," Yogyakarta State University, 2018.
- [5] E. A. G. Castro, "Industry participation in developing competencies for employment success: Learnings from a 3-year ojt program of a philippine higher education institution," in *Widyatama International Seminar (WIS)*, 2014, pp. 167–177.
- [6] C. Burns and S. Chopra, "A meta-analysis of the effect of industry engagement on student learning in undergraduate programs," *The Journal of Technology, Management, and Applied Engineering*, vol. 33, no. 1, pp. 1–20, 2017.
- [7] European Commission, *An analysis of the role and impact of industry participating in the Framework Programmes*. Luxembourg: European Union, 2016.
- [8] O. Broadbent and E. McCann, *Effective industrial engagement in engineering education: A good practice guide*. London: Royal Academy of Engineering, 2016.
- [9] L. Moldovan, "Review of Legislation Framework in the Field of Work-based Learning," *Procedia Manufacturing*, vol. 32, pp. 302–308, 2019, doi: 10.1016/j.promfg.2019.02.218.
- [10] K. J. Herrmann, "The impact of cooperative learning on student engagement: Results from an intervention," *Active Learning in Higher Education*, vol. 14, no. 3, pp. 175–187, Nov. 2013, doi: 10.1177/1469787413498035.
- [11] Suyitno, D. Jatmoko, A. Susanto, A. Primartadi, and T. Mahfud, "Trainer Stand Instructional Media of Wiring System for Kijang Car to Improve Student Achievement in Vocational Higher Education," *Journal of Advanced Research in Dynamical and Control Systems*, vol. 11, no. 11, pp. 991–997, Nov. 2019, doi: 10.5373/JARDCS/V11SP11/20193126.
- [12] M. Nurtanto, P. Pardjono, Widarto, and S. D. Ramdani, "The Effect of STEM-EDP in Professional Learning on Automotive Engineering Competence in Vocational High School," *Journal for the Education of Gifted Young Scientists*, vol. 8, no. 2, pp. 633–649, Jun. 2020, doi: 10.17478/jegys.645047.
- [13] M. Rivera, V. Shapoval, and M. Medeiros, "The relationship between career adaptability, hope, resilience, and life satisfaction for hospitality students in times of Covid-19," *Journal of Hospitality, Leisure, Sport & Tourism Education*, vol. 29, p. 100344, Nov. 2021, doi: 10.1016/j.jhlste.2021.100344.
- [14] K. Komariah, A. R. B. A. Razzaq, M. Nugraheni, B. Lastariwati, and T. Mahfud, "The antecedent factor of tourists' intention to consume traditional food," *GeoJournal of Tourism and Geosites*, vol. 32, no. 4, pp. 1209–1215, Dec. 2020, doi: 10.30892/gtg.32403-559.
- [15] S. Choy and B. Delahaye, "Partnerships between universities and workplaces: some challenges for work-integrated learning," *Studies in Continuing Education*, vol. 33, no. 2, pp. 157–172, Jul. 2011, doi: 10.1080/0158037X.2010.546079.
- [16] W. Asghar, I. H. Shah, and N. Akhtar, "Cost-benefit paradigm of apprenticeship training: reviewing some existing literature," *International Journal of Training Research*, vol. 14, no. 1, pp. 76–83, Jan. 2016, doi: 10.1080/14480220.2016.1152029.
- [17] S. Thompson, "Apprenticeships as the answer to closing the cyber skills gap," *Network Security*, vol. 2019, no. 12, pp. 9–11, Dec. 2019, doi: 10.1016/S1353-4858(19)30143-6.
- [18] Sudyatno, M. Wu, A. Budiman, D. Purwatoro, T. Mahfud, and I. Siswanto, "The Effect of Instructional Quality on Vocational Students' Academic Achievement and Career Optimism," *International Journal of Innovation, Creativity and Change*, vol. 7, no. 10, pp. 244–260, 2019, [Online]. Available: https://www.ijicc.net/images/vol7iss10/71023_Sudyanto_2019_E_R.pdf.
- [19] B. Neyt, D. Verhaest, and S. Baert, "The impact of dual apprenticeship programmes on early labour market outcomes: A dynamic approach," *Economics of Education Review*, vol. 78, p. 102022, Oct. 2020, doi: 10.1016/j.econedurev.2020.102022.
- [20] J. M. S. Gross, S. J. Haines, C. Hill, L. Grace, M. Blue-banning, and A. P. Turnbull, "Strong school-community partnerships in inclusive schools are 'part of the fabric of the school... We count on them,'" *School Community Journal*, vol. 25, no. 2, pp. 9–34, 2015.
- [21] S. Ahmed, N. H. A. Manaf, and R. Islam, "Assessing top management commitment, workforce management, and quality performance of Malaysian hospitals," *International Journal of Healthcare Management*, vol. 14, no. 1, pp. 236–244, Jan. 2021, doi: 10.1080/20479700.2019.1645380.
- [22] A.-N. El-Kassar and S. K. Singh, "Green innovation and organizational performance: The influence of big data and the moderating role of management commitment and HR practices," *Technological Forecasting and Social Change*, vol. 144, pp. 483–498, Jul. 2019, doi: 10.1016/j.techfore.2017.12.016.
- [23] W. B. Schaufeli, *Employee Engagement in Theory and Practice*. United Kingdom: Routledge, 2013.
- [24] M. F. Y. Cheung and W. M. To, "Management commitment to service quality and organizational outcomes," *Managing Service Quality*, vol. 20, no. 3, pp. 259–272, 2010, doi: 10.1108/09604520710834993.
- [25] M. R. B. Rubel, N. N. Rimi, M.-Y. Yusliza, and D. M. H. Kee, "High commitment human resource management practices and employee service behaviour: Trust in management as mediator," *IIMB Management Review*, vol. 30, no. 4, pp. 316–329, Dec. 2018, doi: 10.1016/j.iimb.2018.05.006.
- [26] E. D. De Leeuw, *Choosing the method of data collection*. New York: Lawrence Erlbaum Associates, 2008.
- [27] L. R. Aiken, "Three coefficients for analyzing the reliability and validity of ratings," *Educational and Psychological Measurement*, vol. 45, no. 1, pp. 131–142, 1985, doi: 10.1177/0013164485451012.
- [28] H. Retnawati, *Quantitative analysis of research instruments*. Yogyakarta: Parama Publishing (in Indonesian), 2016.
- [29] I. Ghozali, *Structural equation models: Concepts and applications with the AMOS 24 bayesian SEM update program*, 7th ed. Semarang: Badan Penerbit Universitas Diponegoro (in Indonesian), 2017.
- [30] J. P. Guilford, *Fundamental statistics in psychology and education*. New York: Mc Graw-Hill Book Co. Inc., 1956.

BIOGRAPHIES OF AUTHORS





Tuatul Mahfud    is an Assistant Professor on vocational education and training of Balikpapan State University. He completed PhD program in Technology and Vocational Education at Yogyakarta State University. His research interest focuses on management in vocational education and training, workplace learning, vocational behavior, and career development. He has published the paper in Scopus indexed journal and Web of Science. He is also the author of books on the strategy of writing and publication of the article in reputable international journals. He can be contacted at: tuatul.mahfud@poltekba.ac.id.





Nuraly Masum Aprily    is a lecturer and researcher at the Universitas Pendidikan Indonesia, Tasikmalaya campus. Her research interests focus on learning media for early childhood and elementary schools, Social Sciences in elementary schools and Early Childhood Education (PAUD), character education, and moral education. He has published articles in several national journals in Indonesia and is a book author. He can be contacted at email: nuralymasumaprily@upi.edu.





Ida Nugroho Saputro    is an Assistant Professor at the Building Engineering Education Department at the Surakarta Sebelas Maret University and doctoral student at the Technology and Vocational Education at the Yogyakarta State University. His research interest focuses on management in vocational education and training, workplace learning, vocational behavior, and career development. He has published the paper in Scopus indexed journal. He can be contacted at email: idanugroho@staff.uns.ac.id.



Ibnu Siswanto    is an Assistant Professor at Automotive Engineering Education Department of Yogyakarta State University, Indonesia. He received his Ph.D. at Graduate school of Technological and Vocational Education, National Yunlin University of Science and Technology, Taiwan. His main area of interest is the study of vocational education curriculum, employability skills, and collaboration between university and industry. He has published papers in an SSCI, EI, and Scopus indexed journal and proceeding. He can be contacted at email: ibnisiswanto@uny.ac.id.



Suyitno    is an Assistant Professor in Automotive Engineering Education, Faculty of Teacher and Training and Education, Universitas Muhammadiyah Purworejo, Indonesia. He is currently interested in the themes of automotive engineering, education, automotive engineering, and vocational education. He currently teaches courses in technical measurement, research methodology, and training development in automotive engineering education, teacher training and education faculties. He has published Scopus indexed journal papers. He can be contacted through email: yitno@umpwr.ac.id.