

Benchmark between antenna code TOPICA, RAPLICASOL and Petra-M for the ICRH ITER antenna

Original

Benchmark between antenna code TOPICA, RAPLICASOL and Petra-M for the ICRH ITER antenna / Bertelli, N.; Shiraiwa, S.; Helou, W.; Milanesio, D.; Tierens, W.. - In: AIP CONFERENCE PROCEEDINGS. - ISSN 0094-243X. - ELETTRONICO. - 2984:(2023). (Intervento presentato al convegno 24th Topical Conference on Radio-Frequency Power in Plasmas tenutosi a Annapolis, USA nel 26–28 September 2022) [10.1063/5.0162415].

Availability:

This version is available at: 11583/2981965 since: 2023-09-22T08:30:25Z

Publisher:

AIP Publishing

Published

DOI:10.1063/5.0162415

Terms of use:

This article is made available under terms and conditions as specified in the corresponding bibliographic description in the repository

Publisher copyright

AIP postprint/Author's Accepted Manuscript e postprint versione editoriale/Version of Record

(Article begins on next page)

Benchmark Between Antenna Code TOPICA, RAPLICASOL and Petra-M for the ICRH ITER Antenna

N. Bertelli,^{1, a)} S. Shiraiwa,¹ W. Helou,² D. Milanesio,³ and W. Tierens⁴

^{1)Princeton Plasma Physics Laboratory, Princeton, NJ, USA}

^{2)ITER Organization, Route de Vinon-sur-Verdon, CS 90 046, 13067 St. Paul Lez Durance Cedex, France}

^{3)Politecnico di Torino, Corso Duca degli Abruzzi 24, I-10129 Torino, Italy}

^{4)Max-Planck-Institut für Plasmaphysik, Garching, Germany}

^{a)Corresponding author: nbertell@pppl.gov}

Abstract. ITER will be equipped with three plasma heating systems: neutral beam (NB), electron cyclotron (EC), and ion cyclotron resonance heating (ICRH). The latter consists of two identical ICRH antennas to deliver 20 MW to the plasma (baseline, upgradable to 40 MW). ICRH will play a crucial role in the ignition and sustainment of burning plasmas in ITER. A high fidelity and robust modeling effort to understand the interaction of the IC waves with the scrape-off-layer (SOL) plasma is a very important aspect. Among the main important research topics, we have the assessment of the antenna loading for different plasma scenarios, the role of the lower hybrid resonance in front of the antenna and how to include it in our models, and the RF sheath boundary conditions to evaluate the antenna impurity generation. In this work, we tackle the first of these by reporting on ICRF simulations employing the Petra-M code, which is an electromagnetic simulation tool for modeling RF wave propagation based on MFEM [<http://mfem.org>] for the ITER ICRH antenna. Moreover, a benchmark between the well tested antenna codes TOPICA, RAPLICASOL, which is based on COMSOL [www.comsol.com], and the Petra-M code is also presented. S- and Z-matrices and wave electric field are compared showing an excellent agreement among these codes.

INTRODUCTION

Ion cyclotron resonance heating (ICRH) actuators will play an important role in the ignition and sustainment of the burning plasmas in ITER. ITER will be equipped with two identical ICRH antennas to deliver 20MW to the plasma (baseline, upgradable to 40 MW). Interaction between IC waves and SOL plasma, the importance of 3D effects, the role of the RF sheath effects on antenna impurity generation, the role of lower hybrid resonance in front of the antenna, the coupling between core and edge plasma, and the assessment of the antenna loading for different plasma scenarios are among the most important research topics requiring a high-fidelity ICRH modeling. In this work, we report ICRH simulations for the ITER ICRH antenna by using the Petra-M framework, which is an integrated finite-element-method (FEM) open source multi-physics platform. In particular, a benchmark between the Petra-M code and two well tested antenna codes TOPICA [1, 2] and RAPLICASOL [3, 4] is presented and discussed here.

This paper is structured as follows: a brief description of the Petra-M framework, TOPICA and RAPLICASOL is given in Section 2. In Section 3 The ITER ICRH antenna geometry used in these numerical simulation and the plasma model adopted are presented. Numerical results of this work are discussed in Section 4 showing the wave field propagation evaluated by Petra-M, the comparison among the three codes of the S- and Z-matrices, the wave field on a surface in front of the antenna and the coupled power to the plasma for different antenna feeding schemes. Conclusions are provided in Section 5.

THE Petra-M FEM PLATFORM AND THE ANTENNA CODES RAPLICASOL AND TOPICA

Petra-M stands for Physics Equation Translator for MFEM. It is an integrated finite-element-method (FEM) open source multi-physics platform [5, 6] based on the MFEM library [7], which is an open source scalable C++ FEM library developed by Lawrence Livermore National Laboratory team. Petra-M combines the variety of open source libraries, a large fraction of which are being developed by Advance Scientific Computing Research (ASCR) [8]. More specifically, in this work, OpenCASCADE [9] and GMSH [10] modules are used for mesh/geometry generation and MUMPS [11] is the direct solver employed. For more details about Petra-M the reader is referred to [5, 6]. Petra-M is employed here to solve the 3D Maxwell's equations for a cold plasma model in the frequency domain for ITER ICRH antenna models. An application of Petra-M in high harmonic fast wave (HHFW) frequency regime was recently published showing a full 3D torus simulations for NSTX/NSTX-U [12]. Moreover, non-linear RF sheath model [13]

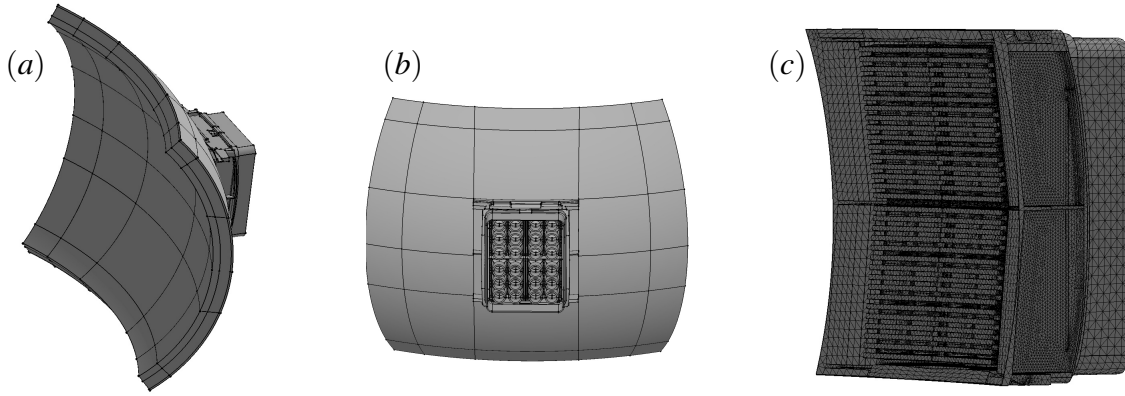

FIGURE 1. ((a) and (b)): ITER ICRH antenna geometry and the outer wall+plasma as a circular torus; (c): ITER ICRH antenna mesh used in the simulations.

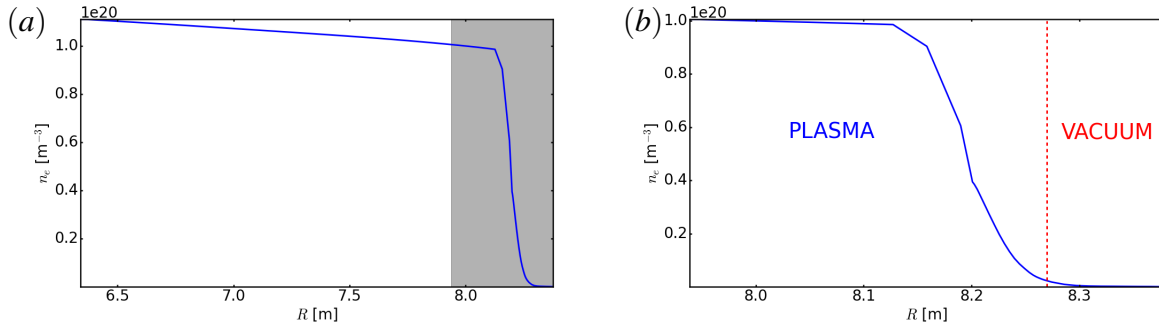

FIGURE 2. (a): Electron density as a function of the major radius R . (b): Electron density around the vacuum-plasma interface indicated by the dashed line (at about $R = 8.27$ m) and chosen to avoid the $S = 0$ resonance.

has been implemented in Petra-M and applied to WEST tokamak [14]. Here, a comparison with other two antenna codes such as RAPLICASOL [3, 4] and TOPICA [1, 2] is performed. RAPLICASOL is based on the commercial software COMSOL to solve the Maxwell's equations in frequency domain using FEM. TOPICA is an ion cyclotron (IC) antenna code and it can handle both the realistic antenna geometry and hot, 1D plasma description [1, 2]. TOPICA is largely used in our ICRF community and it has been well tested with different codes (including RAPLICASOL) and ICRF experiments, such as AUG, WEST, etc.. For more details about RAPLICASOL and TOPICA, the reader is referred to [3] and [1, 2], respectively. Reference [4] also shows a benchmark of these two codes and describes their main features/differences.

ITER ICRH ANTENNA MODEL

24 ports antenna

The ITER ICRH antenna geometry used in this work is shown in Figure 1. It consists of 24 ports. In terms of wall shape we have approximated the shape of the outer wall as a circular torus. As shown in Figures 1(a) and 1(b), the wall is also extended in both the poloidal and toroidal direction. This geometry was previously used in Tierens et al. [15, 16, 17]. Since the scope of this work is to show a benchmark among the three different codes, in the simulations presented here we use the same mesh generated and used in RAPLICASOL [15, 16, 17] in order to minimize possible differences in the 3D geometry and mesh generation.

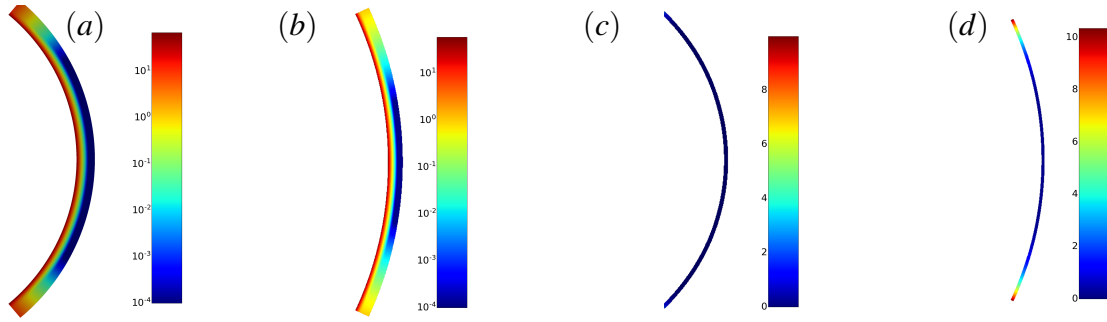

FIGURE 3. Collision profiles used in the Petra-M simulations: (a) poloidal cross-section in the plasma; (b) toroidal cross-section in the plasma; (c) poloidal cross-section in vacuum; (d) toroidal cross-section in vacuum;

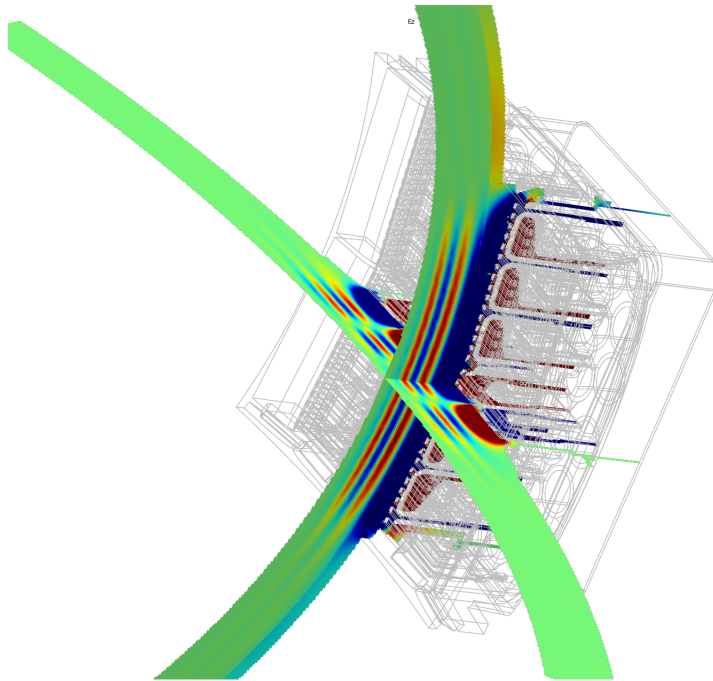

FIGURE 4. E_z component (vertical) of the wave electric field obtained by the Petra-M code for the ITER ICRH antenna shown in Figure 1.

Plasma scenario

Unlike RAPLICASOL simulations where perfectly matched layer (PML) boundaries conditions [18] were employed (in the inner and side surfaces of the numerical domain), in the Petra-M simulations a cold plasma model with additional collision damping were used assuming perfect electric conductor (PEC) boundary conditions on the wall. The use of the collisions to model the wave damping in the core requires a “tuning” of such damping to match as best as possible with the PML boundary conditions. Several attempts were performed: constant collisions for the entire plasma, collisions assuming a radial profile only and finally radial, poloidal and toroidal profiles (see Figure 3). In this work, we focus on the last case which provides the best agreement with the other two codes discussed here. In terms of plasma models we have assumed a magnetic field of 5.3 T at $R = 6.2$ m (where R is the major radius). We have also assumed a $1/R$ dependence of the magnetic field with a pitch angle of 15 degrees. The plasma composition is 50% deuterium and 50% tritium. The electron density profile used in the simulations is shown in Figure 2. In particular, Figure 2(a) shows the electron density as a function of the major radius, R , from the core to the antenna location. The gray-area in figure 2(a) indicates the actual plasma and vacuum domain used in the simulation as shown in Fig-

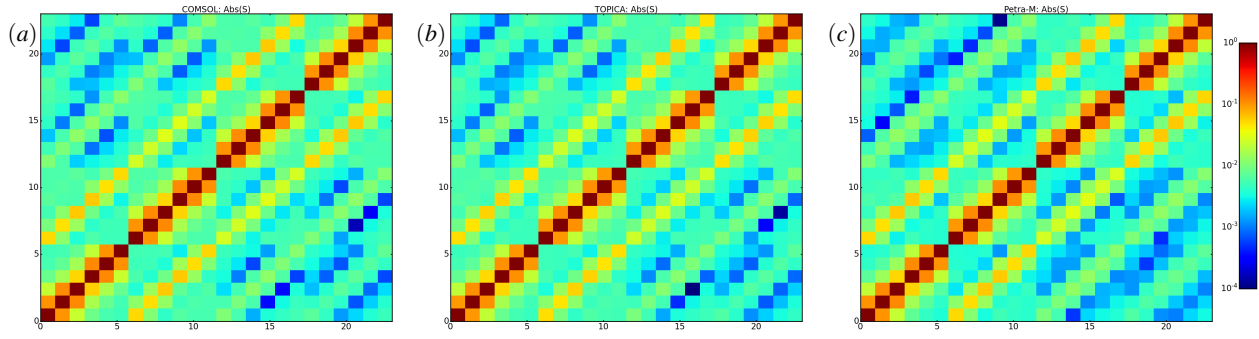

FIGURE 5. Absolute value of the S-matrix evaluated by RAPLICASOL/COMSOL (a), TOPICA (b), and Petra-M (c) codes.

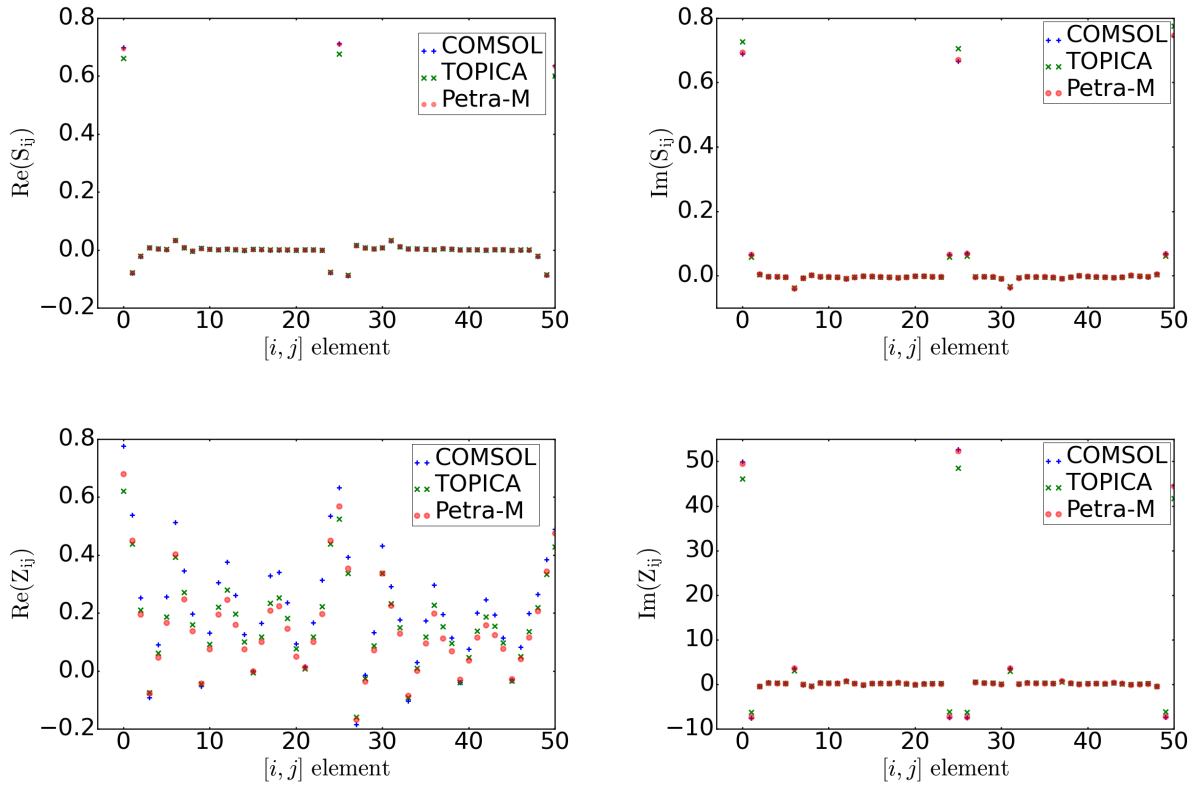

FIGURE 6. Real and imaginary part of the S- and Z-matrices evaluated by RAPLICASOL/COMSOL, TOPICA, and Petra-M for the first 50 elements.

ure 2(b), which corresponds to the plasma-vacuum domain shown also in Figure 1(a). Moreover, Figure 2(b) shows the plasma-vacuum interface location used in our simulation to avoid the presence of the lower hybrid resonance in front of the antenna (also known as $S = 0$ resonance where S is the component of the plasma dielectric tensor in Stix notation [19]). Wave frequency is 55 MHz and vacuum is assumed for $R > 8.27$ m including the antenna box.

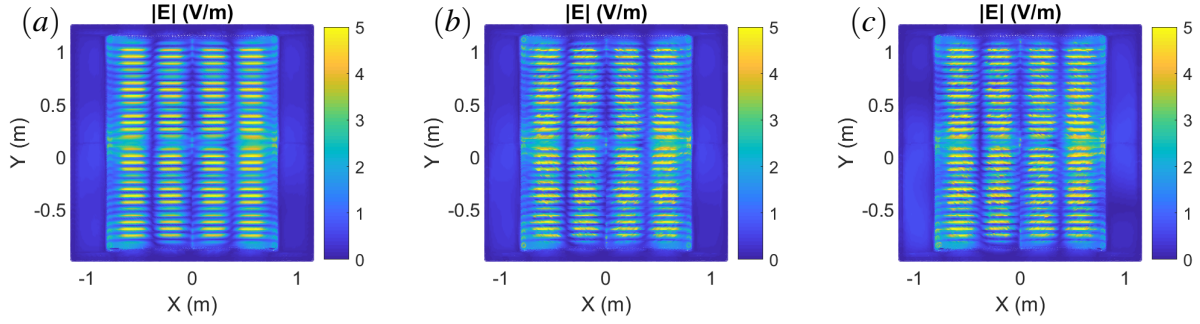

FIGURE 7. The amplitude of the wave electric field evaluated by RAPLICASOL (a), TOPICA (b), and Petra-M (c) on a surface just in front of the antenna.

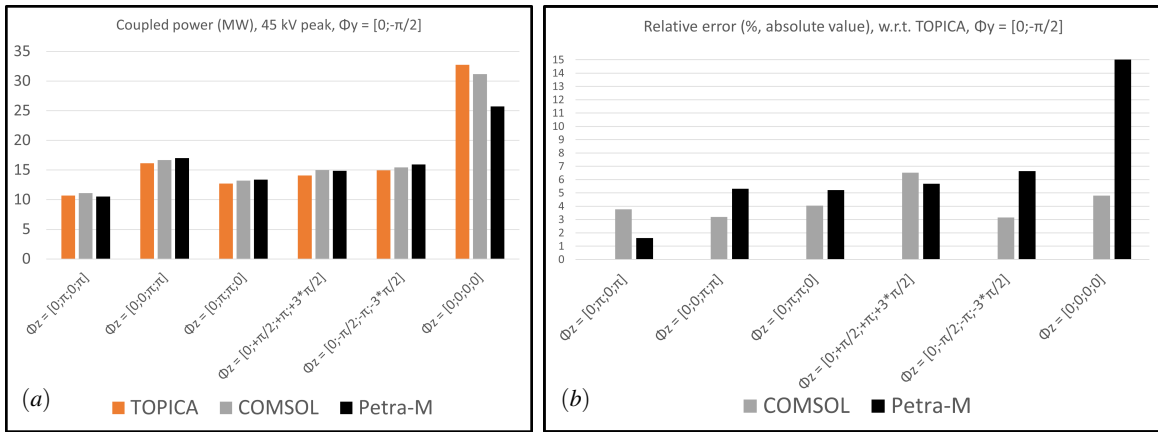

FIGURE 8. (a) Coupled power obtained from the three different codes and for different antenna feeding schemes as shown in the figure. Here a peak voltage of 45 kV is assumed; (b) Relative error for RAPLICASOL/COMSOL and Petra-M of the coupled power with respect to TOPICA calculation.

NUMERICAL RESULTS

In this section we show a benchmark between Petra-M, TOPICA, and RAPLICASOL in terms of S- and Z- matrices and the electric field on a surface in front of the antenna. An example of the wave field obtained by using the Petra-M FEM framework for the ITER ICRH antenna is shown in Figure 4. In this figure the E_z component (vertical) of the wave field is plotted. Figure 4 shows both the mid-plane and a poloidal cross sections as a reference. In this work we used 2nd order basis Nedelec elements to solve Maxwell's equations in Petra-M. As a internal check, a simulation with the 3rd order elements were also performed (not shown here) showing an excellent agreement with respect to the simulation using 2nd order elements.

Figure 5 shows the absolute value of the S-matrix elements evaluated by RAPLICASOL (a), TOPICA (b), and Petra-M (c). From this comparison a good agreement between these codes is apparent. However, in order to be able to investigate smaller discrepancies, a plot of both the real and imaginary part of the S- and Z-matrices elements are shown in Figure 6. Here we show the 48 elements of the first two rows of the S- and Z-matrices. Again, a very good agreement is obtained for both matrices in real and imaginary parts. Figure 7 shows the amplitude of the electric field on a surface in front of the antenna mouth for the three codes: RAPLICASOL (a), TOPICA (b), and Petra-M (c). A quite good agreement is also found in terms of the amplitude of the electric field. Finally, the coupled power evaluated by the three codes for different antenna feeding schemes is shown in Figure 8 assuming a peak voltage of 45 kV. In particular, Figure 8(b) shows the relative error of the couple power evaluated by RAPLICASOL/COMSOL and Petra-M with respect to the TOPICA code. The relative error is well below 10% for all antenna feeding schemes except for the monopole phasing $\phi_z = [0, 0, 0, 0]$ which is up to 15% for the Petra-M case and it generally shows a larger disagreement.

CONCLUSIONS

A benchmark between Petra-M, RAPLICASOL and TOPICA was shown. An excellent agreement in S-, Z- matrices, amplitude of the wave field in front of the antenna and coupled power for different antenna feeding schemes was found. A good agreement among these codes was also found for another plasma scenario (not shown here) with higher antenna loading (namely, higher density in front of the antenna). At the same time, a different ITER ICRH antenna model with 8 ports was also considered for the benchmark activity between TOPICA and Petra-M but an agreement among these codes has not been obtained yet and we are currently working to identify the reason. One possibility is a difference on the geometries used in each codes unlike the case shown here where the mesh generated in COMSOL was used in both RAPLICASOL and Petra-M.

ACKNOWLEDGMENTS

This work was supported by the U.S. Department of Energy under contract number DE-AC02-09CH1146 and IO contracts IO/20/CT/4300002118 and IO/20/CT/4300002150. This research also used resources of the National Energy Research Scientific Computing Center (NERSC), a U.S. Department of Energy Office of Science User Facility located at Lawrence Berkeley National Laboratory, operated under Contract No. DE-AC02-05CH11231. The views and opinions expressed herein do not necessarily reflect those of the ITER Organization.

REFERENCES

1. D. Lancellotti and et al, Nucl. Fusion **46**, S476 (2006).
2. D. Milanese and et al, Nucl. Fusion **49**, 115019 (2009).
3. J. Jacquot and et al, AIP Conference Proceedings **1689**, 050008 (2015).
4. W. Tierens and et al, Nucl. Fusion **59**, 046001 (2019).
5. S. Shiraiwa and et al, EPJ Web of Conference **157**, 03048 (2017).
6. S. Shiraiwa and et al, "Towards integrated RF actuator modeling: whole device scale RF fullwave simulation including hot core and 3D sol/antenna regions, [TH/7/2]," paper presented at the 28th IAEA Int. Conf. on Fusion Energy (Virtual Event) (2021).
7. "MFEM," <http://mfem.org>.
8. "Advanced scientific computing research (ASCR)," <https://www.energy.gov/science/ascr/advanced-scientific-computing-research>.
9. "OpenCASCADE," <https://www.opencascade.com/>.
10. "GMSH," <http://gmsh.info>.
11. "MUMPS: a parallel sparse direct solver," <http://mumps.enseeiht.fr/>.
12. N. Bertelli, S. Shiraiwa, and M. Ono, Nucl. Fusion **62**, 126046 (2022).
13. J. R. Myra, J. Plasma Phys. **87**, 905870504 (2021).
14. S. Shiraiwa and et al, Nucl. Fusion **63**, 026024 (2023).
15. W. Tierens, "Assessments of the computational capabilities of comsol modelling," Tech. Rep. ITER_D_3TKBZ8 v3.2 (IO contract #IO/20/CT/4300002150, Deliverable 8).
16. W. Tierens, "Raplitasol modelling of the iter icrf antenna," Tech. Rep. ITER_D_3TKJKF v3.0 (IO contract #IO/20/CT/4300002150, Deliverable 9).
17. W. Tierens and et al, "Icrf code benchmarks for the iter antenna; first non-axisymmetric cases," To be submitted to Nucl. Fusion.
18. L. Colas and et al, J. Comp. Phys. **389**, 94 (2019).
19. T. H. Stix, *Waves in Plasmas* (American Institute of Physics, NY, 1992).