



Title	Two element phased array dipole antenna
Author(s)	Taguchi, Mitsuo; Era, Kotaro; Tanaka, Kazumasa
Citation	Proc. of 22nd Annual Review of Progress in Applied Computational Electromagnetics, Miami, pp. 466-469; March 2006.
Issue Date	2006-03
URL	http://hdl.handle.net/10069/21533
Right	(c) 2006 ACES

This document is downloaded at: 2020-09-17T22:18:57Z

Two Element Phased Array Dipole Antenna

Mitsuo Taguchi¹, Kotaro Era², and Kazumasa Tanaka³

^{1,3} Department of Electrical & Electronic Engineering
Nagasaki University, 1-14 Bunkyo-machi, Nagasaki-shi, 852-8521 JAPAN
¹mtaguchi@net.nagasaki-u.ac.jp, ³kazumasa@net.nagasaki-u.ac.jp

² Graduate School of Science and Technology,
Nagasaki University, 1-14 Bunkyo-machi, Nagasaki-shi, 852-8521 JAPAN
d704086c@stcc.nagasaki-u.ac.jp

Abstract: Two element array dipole antenna with 90° phase difference feed is proposed for the directional antenna. In the numerical analysis, the electromagnetic simulator WIPL-D based on the Method of Moment is used. The distance between two elements is fixed to be a quarter wavelength at the design frequency 2.45 GHz. By adjusting the length of two elements, the front-to-back ratio of 13.6 dB is obtained. The relation between the front-to-back ratio of this antenna and the feed point currents of dipole elements is discussed. The measured input impedance with 90 degree hybrid agrees with the calculated result.

Keywords: phased array antenna, directional antenna, front-to-back ratio, WIPL-D

1. Introduction

For the short-range wireless communication, a small antenna with unidirectional radiation characteristics is desired. As the directional antenna composed of wire elements, the Yagi-Uda antenna and the ESPAR antenna are well known. These antennas consist of single driven element and some parasitic elements. In the Yagi-Uda antenna, the induced currents on the parasitic elements are controlled by adjusting the length of parasitic elements and the distance of elements [1]. In the ESPAR antenna, the current of parasitic elements are controlled by adjusting the loaded reactance at the feed point of them [2]. These antennas are spatially phase controlled antennas.

In this paper, the two element array dipole antenna with 90° phase difference feed is proposed for the directional antenna. The distance between two dipole elements is fixed to be a quarter wavelength at the design frequency 2.45 GHz. This antenna is numerically and experimentally analyzed. In the numerical analysis, the electromagnetic simulator WIPL-D based on the Method of Moment is used [3].

2. Analytical Model

Fig. 1 shows the structure of the two element phased array dipole antenna. Each antenna element is fed with 90° phase difference. The distance between two elements is $d = 30.6\text{mm} = 0.25 \lambda_c$, where λ_c is the wavelength at the design frequency 2.45 GHz. The length of the antenna element #1 and #2 are L_1 and L_2 , respectively. The radius of each element is $a = 1\text{mm}$. In the numerical analysis by WIPL-D, antenna elements are excited by the delta-gap generators.

Fig. 2 shows the experimental model. Two monopole elements are mounted on the ground plane of 87 cm by 87 cm. This antenna is driven through the 90° hybrid phase shifter. The reflection coefficient Γ at the input

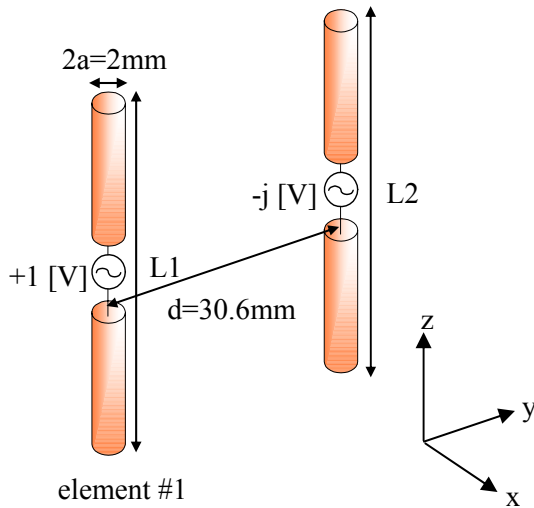

Fig. 1 Analytical model

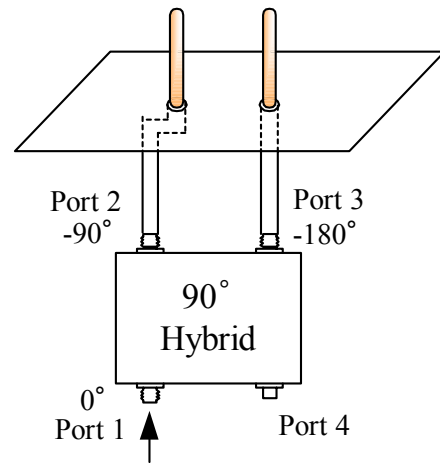

Fig. 2 Experimental model

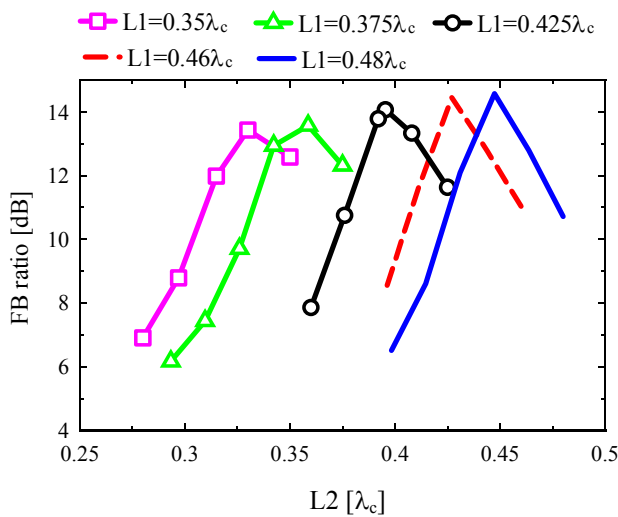

Fig. 3 Maximum front-to-back ratio

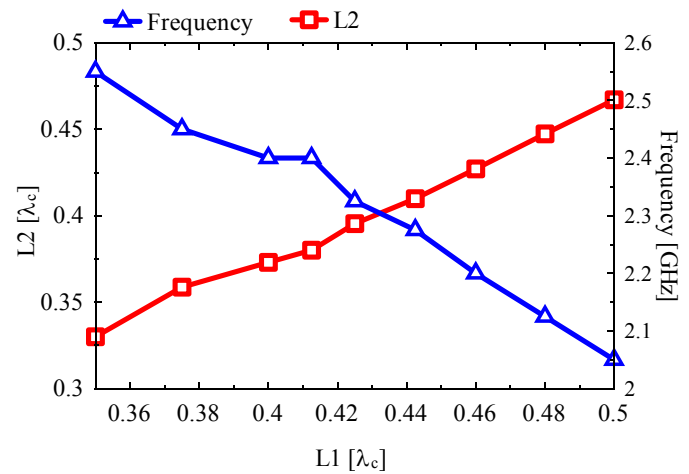

Fig. 4 L2 for maximum FB ratio and its frequency

port of hybrid is expressed in terms of the reflection coefficients Γ_2 and Γ_3 seen from the port 2 and 3 toward load [4].

$$\Gamma = \frac{1}{2}(\Gamma_3 - \Gamma_2) \tag{1}$$

3. Results and Discussion

Fig. 3 shows the maximum front-to-back ratio calculated in the frequencies from 1 GHz to 3 GHz. Fig. 4 shows L2 and the frequency where the maximum front-to-back ratio is obtained. The maximum front-to-back ratio is obtained for the ratio of L2 to L1 from 0.93 to 0.95. Fig. 5 shows the front-to-back ratio at the design frequency 2.45 GHz. The front-to-back ratio becomes highest (13.6 dB) at the design frequency in the case of $L1 = 0.375 \lambda_c$ and $L2 = 0.359 \lambda_c$. Fig. 6(a) and (b) show the calculated electric field radiation patterns in the xy

plane where the highest front-to-back ratio is obtained at the design frequency and in the frequencies from 1.0 GHz to 3.0 GHz, respectively.

Fig. 7 shows the feed point current of each element and the synthesized currents toward +y and -y direction. The distance between two elements $d = 30.6$ mm corresponds to the spatial phase delay of 90° at 2.45 GHz. In Fig. 7(a), without considering the attenuation along the propagation, the current on the element #2 added by the current #1 with 90° phase delay contributes to the radiation toward +y direction. The current on the element #1 added by the current #2 with 90° phase delay contributes to the radiation toward -y direction. The difference between two synthesized currents means higher front-to-back ratio. On the other hand, the amplitudes of two synthesized currents are almost same in Fig. 7(b). Therefore the front-to-back ratio becomes low.

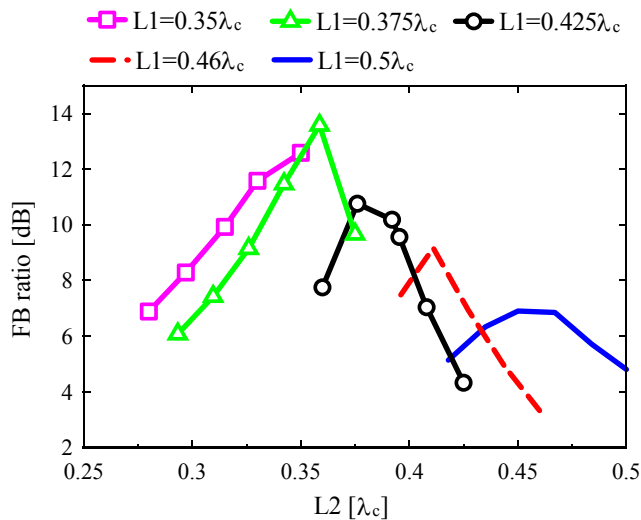

Fig. 5 Front-to-back ratio at 2.45 GHz

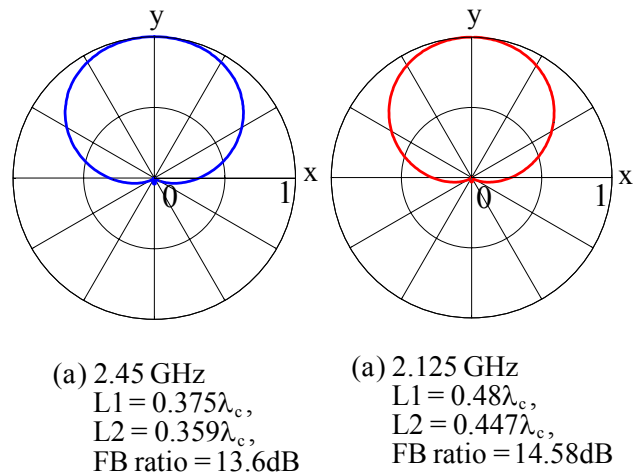
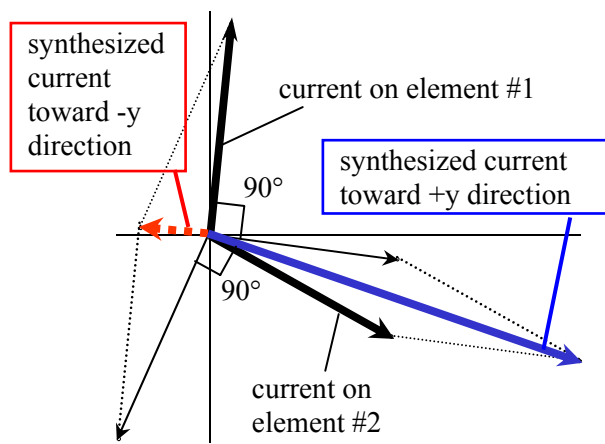
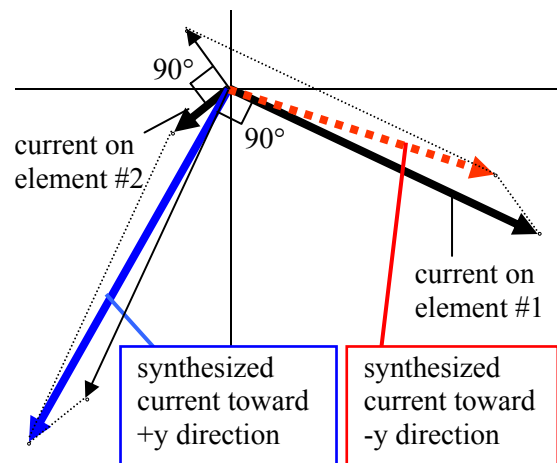

Fig. 6 Electric field radiation patterns in xy plane



(a) $L1 = 0.375\lambda_c, L2 = 0.359\lambda_c,$
FB ratio = 13.6dB



(b) $L1 = L2 = 0.5\lambda_c,$
FB ratio = 4.8dB

Fig. 7 Current on each element and synthesized currents toward +y and -y directions at 2.45GHz

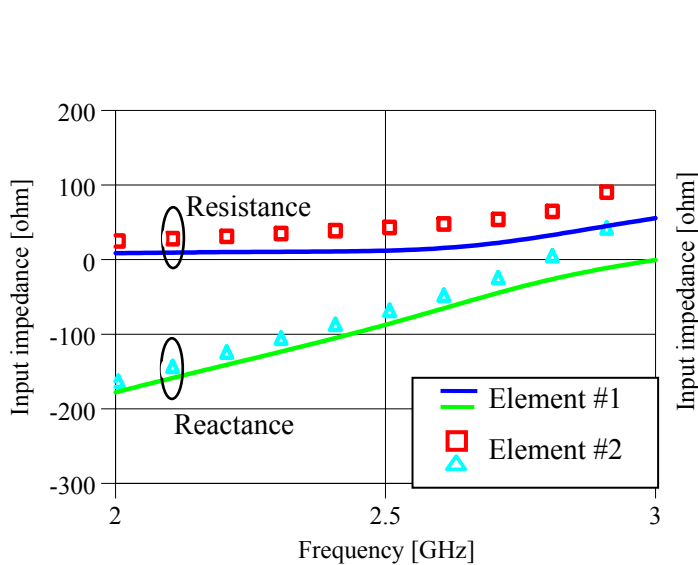

Fig. 8 Calculated input impedances at feed points of each element. $L1=0.375 \lambda_c$, $L2=0.359\lambda_c$.

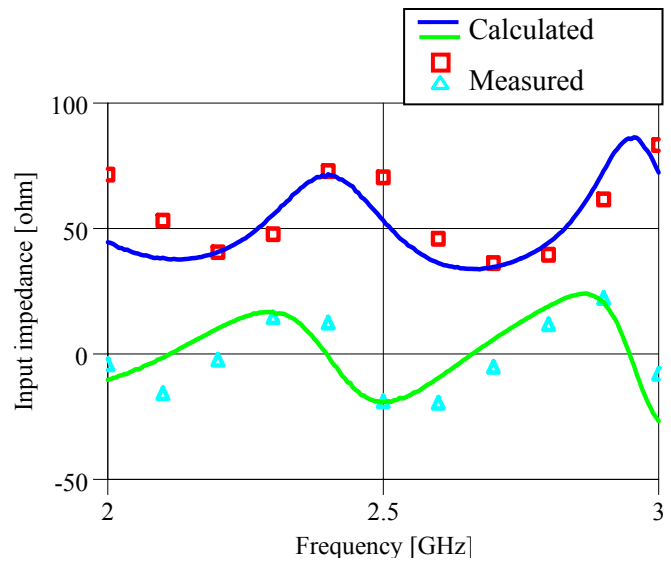

Fig. 9 Input impedance characteristics at input port of 90° hybrid phase shifter.

Fig. 8 shows the calculated input impedances at feed points of each element for $L1 = 0.375 \lambda_c$ and $L2 = 0.359 \lambda_c$. In this case, the highest front-to-back ratio is obtained at frequency of 2.45 GHz. In the case of $L1 = L2 = 0.5 \lambda_c$, the differences of the input impedance of two elements are observed at higher frequencies due to the mutual coupling between two elements [5]. However, in Fig. 8, the input impedance of element #1 is almost same as that of element #2. Fig. 9 shows the input impedance characteristics at the input port of 90° hybrid phase shifter. In the calculation, the attenuation and the phase delay in the coaxial cable between the phase shifter and the antenna element is considered. The calculated impedances agree with the measured results.

4. Conclusion

Two element array dipole antenna with 90° phase difference feed has been analyzed numerically and experimentally. Although this antenna has a simple structure, it has the unidirectional radiation characteristics. By adjusting the length of each element and the distance between two elements, higher front-to-back ratio will be obtained. This antenna will be promising as an element antenna for the base station antenna of short-range wireless communication system.

References

- [1] H. Yagi, "Beam transmission of ultra-short waves," *Proc. of IRE*, vol. 16, p. 715, 1928.
- [2] T. Ohira and K. Gyoda, "Electronically steerable passive array radiator antennas for low-cost analog adaptive beam-forming," *Proc. of IEEE International Conference on Phased Array Systems and Technology*, pp. 101-104, May 2000.
- [3] "WIPL-D Pro v5.1 User's Manual", WIPL Ltd., 2004.
- [4] R. J. Weber: "Introduction to Microwave Circuits", pp.322-324, IEEE Press, 2001.
- [5] K. Era, K. Tanaka and M. Taguchi, "2 Element phased array dipole antenna", *ITE Technical Report*, BCT2005-131, Oct. 2005 (in Japanese).