

# A Distributed Day-Ahead Dispatch for Networked Micro-Grids Considering Battery Aging

Andres Cordoba-Pacheco, Fredy Ruiz  
Dipartimento di Elettronica, Informazione e Bioingegneria,  
Politecnico di Milano, Piazza Leonardo da Vinci 32, 20133, Milano, Italy;  
(e-mail: {andresfelipe.cordoba, fredy.ruiz}@polimi.it)

**Abstract**— Within the concept of Micro-Grids, the day ahead energy management plays an important role where the principal objective is to minimize the cost of the operation. Adequate strategies are required to find an optimal solution for the scheduling of energy flows, that can be formulated as centralized or distributed optimization problems. Energy storage systems are becoming an essential component of Micro-Grids due to their contribution to reducing the peak load and mitigating the intermittency of renewable resources. However, battery aging is a latent problem that is not usually considered in energy management systems. Consequently, this paper presents a day-ahead dispatch strategy for a set of Micro-Grids, solvable by centralized and ADMM distributed approaches, and with the inclusion of battery degradation costs. A detailed simulation was executed to verify the behavior of the proposed approaches. It is shown that both, centralized and distributed solutions, converge to the same minimum with a difference of less than 1%. A Pareto analysis with the  $\epsilon$  constraint method evidences that the operative costs can increase up to a 11.7% if the aging cost of the battery is constrained below its nominal level.

## I. INTRODUCTION

In recent years, maintaining the dynamic power balance of power grids has become a challenge due to the uncertainty introduced by Distributed Energy Resources (DERs) such as photovoltaic (PV) and wind energy generators, electric vehicles, etc. These DERs create congestion and imbalance on the grid due to unmanageable production and consumption of energy, so, optimal Energy Management Systems (EMS) are required to operate the grid appropriately. These kinds of systems can reduce the overall cost of energy supply in the day-ahead economic power dispatch and in the real-time operation [1],[2].

Within the concept of Micro-Grid (MG) there are many technical and economic constraints on the system operation where Battery Energy Storage System (BESS) can play an important role, for example by reducing the peak load or mitigating the intermittency of Renewable Energy Systems (RES). The main idea is to use the stored energy strategically, for instance selling it when the price of the energy is high in order to decrease the cost. However, long-term constraints emerge, related to the aging of the Battery [3], [4].

Diverse techniques have been proposed in the literature for the optimal day-ahead energy management in MGs, where the principal objective is to minimize the cost of the operation. In addition, the scheduling of the energy can be seen as a centralized optimization problem where a unit

or entity collects all the information about the status and behavior of each element of the grid to find an optimal solution, or as a distributed optimization problem where each agent solves its own optimization problem based on specific information shared between the MGs to reach an agreed total solution. [5] provides an optimal centralized scheduling for an EMS model that involves a hydrogen production system integrated with a PV system and Battery energy storage with the purpose of controlling the electrolyzer's operating point to achieve operational and economic benefits. [6] presents an EMS taking care of the line losses in the optimization procedure, considering centralized and distributed solutions. However, it only includes PV systems and BESS. Other studies propose modifications to the models used to formulate the cost function in order to improve the final behavior. For example, [7] presents a day ahead scheduling with a forecast-based battery model in combination with a grid-connected PV source with the aim of storing energy during the hours of high production and low prices. [8] proposes an integrated electricity and natural gas system, where the EMS is based on a fast Alternating Direction Method of Multipliers (ADMM) algorithm with restart taking into account some uncertainties. Also [9] and [10] propose stochastic optimization methods for planning the daily schedule considering uncertainty.

The objective of this paper is to present a day-ahead dispatch strategy for a set of MGs, considering not only the economic cost of the operation but also the aging costs of the batteries. The strategy can be solved both in centralized and distributed frameworks. The system consists of a group of MGs, where each one is composed of PV and Wind generators, BESS, and loads. Each MG is able to buy and sell energy not only to the main grid but also to the other MGs.

This paper proposes a multi-objective optimization problem in order to manage and control the DERs that form the set of MGs, coordinating the power exchanges between all the agents, and using the BESS to minimize the operation costs considering the aging of the batteries. The main contributions are:

- A multi-objective optimization problem that includes the cost of battery aging.
- A framework to solve the proposed day-ahead dispatch in centralized and distributed approaches.
- An analysis of the cost of the storage system aging,

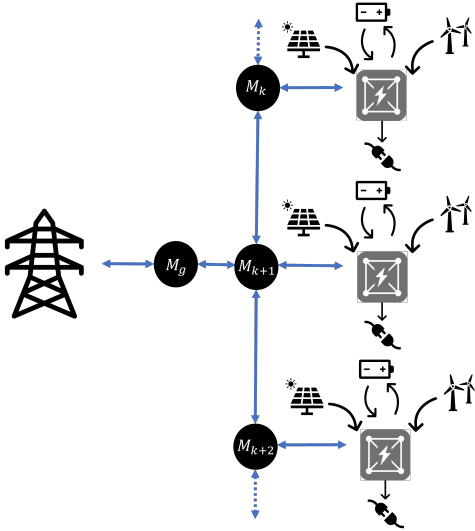

Fig. 1: Micro-Grid Scheme

based on the results given by the approaches used for solving the optimization problem.

The framework of the paper is as follows. In Section 2, the description of the system model is presented. In Section 3, the formulation of the Centralized and Distributed approaches is described. Section 4 describes the analysis of the BESS aging cost in a case study, followed by Section 5 where is presented the analysis of results and the conclusions end the paper in Section 6.

## II. SYSTEM DYNAMICS AND CONSTRAINTS

The scheme of the system is illustrated in Fig. 1. Each node is a MG and has its own bidirectional meter ( $M_k, M_{k+1}, \dots$ ) able to measure the energy received and delivered between the agents.  $M_g$  brings information about the energy exchange with the main grid. Each MG is constituted of PV and Wind systems, BESS, and loads.

Each DER and load is tied to a forecast which limits the power generation/consumption for the day-ahead scheduling, while the agents are not able to sell and buy energy at the same moment. All the models associated with the optimization problem are described below, where  $k \in \Omega = \{1, 2, \dots, N\}$  denotes the set of agents and  $t \in \tau = \{1, 2, \dots, t_{end}\}$  is the time index used to solve the problem.

### A. Grid Operation and Costs

The net cost of the power exchange of each MG  $k$  with the main grid is specified by

$$J_{PT_k} = \sum_{t=1}^{t_{end}} (PG_{buy_k}^t * \widehat{C}_{buy}^t - PG_{sell_k}^t * \widehat{C}_{sell}^t) * \Delta t \quad (1)$$

Where  $PG_{buy_k}^t$  and  $PG_{sell_k}^t$  are the power bought from and sold to the main grid by agent  $k$  at instant  $t$ , and  $\widehat{C}_{buy}^t$  and  $\widehat{C}_{sell}^t$  are their unitary prices.

The grid operation constraints are given by the following technical limits,

$$PG_{buy_k}^t + P_{ES_{Disk}}^t + P_{PV_k}^t + P_{WE_k}^t + \sum_{j=1}^N P_{buy_{k,j}}^t \quad (2)$$

$$= PG_{sell_k}^t + P_{ES_{Chk}}^t + \widehat{P}_{CL_k}^t + \sum_{j=1}^N P_{sell_{k,j}}^t$$

$$P_{sell_{k,j}}^t - P_{buy_{j,k}}^t = 0 \quad (3)$$

$$0 \leq PG_{buy_k}^t \leq PG_{buy_{max}} * B_{sb_k}^t \quad (4)$$

$$0 \leq PG_{sell_k}^t \leq PG_{sell_{max}} * (1 - B_{sb_k}^t) \quad (5)$$

$$0 \leq P_{buy_{k,j}}^t \leq P_{buy_{max}} * B_{sb_k}^t \quad (6)$$

$$0 \leq P_{sell_{k,j}}^t \leq P_{sell_{max}} * (1 - B_{sb_k}^t) \quad (7)$$

$$t \in \tau, \quad k, j \in \Omega$$

(2) represents the power balance for the agent  $k$  at the time  $t$  that includes all the power from each DER where  $\widehat{P}_{CL_k}^t$  is the forecasted load,  $P_{buy_{k,j}}^t$  is the power bought by agent  $k$  from agent  $j$ ,  $P_{sell_{k,j}}^t$  is the power sold by agent  $k$  to agent  $j$ ,  $P_{ES_{Chk}}^t$  and  $P_{ES_{Disk}}^t$  are the charge and discharge power in the BESS,  $P_{PV_k}^t$  and  $P_{WE_k}^t$  represent power of the PV and Wind power systems. (3) enforces the complementarity between the energy sold and bought from another agent. Finally, the binary decision variable  $B_{sb_k}^t$  is employed in (4) to (7) in order to avoid buying and selling energy at the same time.

### B. Battery degradation model

Energy Storage Systems have become a key element in power systems because of the benefits of storing energy, for example to compensate the variations in renewable energy sources. However, battery degradation cost must be taken into account in the operation. The accuracy of battery degradation models changes depending on the application. [11] provides a comparison of the impact of different battery aging models, where it is shown that the linear model approximation has a low computational cost. Considering that the day-ahead dispatch is related to the amount of energy used, a linear model presents some advantages over other models, which add complexity to the optimization problems. [12] presents a linear model where the battery degradation cost is associated with the cycle life of a battery which is obtained by the total amount of consumed energy (kWh).

The lifetime is given by the total amount of energy that flows throughout it. The battery lifetime throughput  $L_{lifetime}$  is determined as

$$L_n = Q_{max} * g_n * f_n \quad (8)$$

$$L_{lifetime} = 1/n * \sum_{i=1}^n L_n \quad (9)$$

where  $Q_{max}$  is the battery capacity,  $g_n$  is the depth of discharge, and  $f_n$  is the number of cycles to failure and  $n$  is the length of  $f_n$  or  $g_n$ . Usually, the information for calculating  $L_{lifetime}$  is given by the fabricant, as shown in Table I. The battery degradation cost per kWh is defined as

$$C_{db} = \frac{R_{cost}}{L_{lifetime} * \eta_{rtrip}}, \quad (10)$$

where  $R_{cost}$  is the replacement cost of each BESS and  $\eta_{rtrip}$  is the square root of the round-trip efficiency of the batteries.

The battery bank is replaced when the total throughput equals its lifetime throughput. Therefore, the cost function for aging BESS becomes

$$J_{ES_k} = \sum_{t=1}^{t_{end}} C_{db_k} * (P_{ESChk}^t + P_{ESDis_k}^t) * \Delta t \quad (11)$$

$$t \in \tau, k \in \Omega$$

Where  $P_{ESChk}^t$  and  $P_{ESDis_k}^t$  are the charge and discharge power at the instant  $t$  for agent  $k$ , respectively. In order to avoid a battery malfunctioning and guaranteeing a safe operation, the BESS is constrained as

$$0 \leq P_{ESChk}^t \leq P_{ESChmax_k} * B_{es_k}^t \quad (12)$$

$$0 \leq P_{ESDis_k}^t \leq P_{ESDismax_k} * (1 - B_{es_k}^t) \quad (13)$$

$$t \in \tau, k \in \Omega$$

Such that  $B_{es_k}^t$  is a binary decision variable which prevents charging and discharging at the same time. On the other hand,  $P_{ESChmax_k}$  and  $P_{ESDismax_k}$  are the power limits for charge and discharge.

Finally, the evolution of the State Of Charge (SOC), considering the charge and discharge efficiencies  $\eta_{ESCh_k}$  and  $\eta_{ESDis_k}$ , is

$$SOC_{ES_k}^{t+1} = SOC_{ES_k}^t + \left( \frac{P_{ESChk}^t * \eta_{ESCh_k} * \Delta t}{Q_{max_k}} \right) - \left( \frac{P_{ESDis_k}^t * \Delta t}{\eta_{ESDis_k} * Q_{max_k}} \right) \quad (14)$$

$$t \in \tau, k \in \Omega$$

and the SOC is bounded as

$$SOC_{ES_{min_k}} \leq SOC_{ES_k}^t \leq SOC_{ES_{max_k}} \quad (15)$$

$$t \in \tau, k \in \Omega.$$

### C. Photovoltaic and Wind Power Systems

The main objective in photovoltaic and wind power systems is to acquire and deliver the highest amount of energy available. This is achieved by using a Maximum Power Point Tracker (MPPT). However, in the case of exceeding the limits of power flows or if the cost of buying energy was less than the cost of producing energy, it is possible to decrease the power through curtailment, which means that PV and wind power will be a decision variable and the economic cost is represented as follows

$$J_{PV_k} = \sum_{t=1}^{t_{end}} (\widehat{P_{PV_k}^t} - P_{PV_k}^t) * \widehat{C_{sell}^t} * \Delta t \quad (16)$$

$$J_{WE_k} = \sum_{t=1}^{t_{end}} (\widehat{P_{WE_k}^t} - P_{WE_k}^t) * \widehat{C_{sell}^t} * \Delta t \quad (17)$$

$$t \in \tau, k \in \Omega$$

Where  $\widehat{P_{PV_k}^t}$  and  $\widehat{P_{WE_k}^t}$  are the predicted Maximum Power Point (MPP) for the PV and Wind power systems,  $P_{PV_k}^t$  and  $P_{WE_k}^t$  are the decision variables and  $\widehat{C_{sell}^t}$  is the forecasted energy cost at each time instance. The values of the decision variables are bounded by

$$0 \leq P_{PV_k}^t \leq \widehat{P_{PV_k}^t} \quad (18)$$

$$0 \leq P_{WE_k}^t \leq \widehat{P_{WE_k}^t} \quad (19)$$

$$t \in \tau, k \in \Omega.$$

## III. ENERGY MANAGEMENT SYSTEM

This section presents the day-ahead dispatch problem for the EMS. The aim is to minimize the total cost function of all the agents due to power transactions with the main grid, it is assumed that the EMS receives the information about prices, forecasted generation, and consumption of the MGs, in this case hourly. Also the energy exchanges between the MGs are free of charge and serve just to minimize the total cost function. Both, centralized and distributed solutions are presented. The centralized approach is able to make decisions over all agents collecting all the information about the behavior of each of them. In the distributed approach, each agent solves its own dispatch problem based on limited information obtained from neighbor agents improving the performance on large scale scenarios.

### A. Centralized Problem Formulation

The problem is solved by just one unit which collects all the information about the different agents, looking for a unique solution that fulfills every constraint of each agent for the  $t_{end}$  time intervals.

The Objective Function  $OF$  is given by

$$\begin{aligned} & \text{minimize} && \sum_{k=1}^N J_{PT_k} + J_{PV_k} + J_{WE_k} + J_{ES_k} \\ & P_{buy_k}^t, P_{sell_k}^t, && \\ & P_{sell_{k,j}}^t, P_{buy_{j,k}}^t, && \\ & P_{ESDis_k}^t, P_{ESChk}^t, && \\ & P_{PV_k}^t, P_{WE_k}^t, && \\ & B_{es_k}^t, B_{sb_k}^t && \end{aligned} \quad (20)$$

subject to (12), (13), (14), (15), (18), (19), (2),

(3), (4), (5), (6), (7)

The resulting problem is a Mixed Integer Linear Program (MILP).

### B. Distributed Problem Formulation

The structure of the previously presented centralized problem allows us to transform it into a distributed one through a decomposition-coordination procedure, where the solutions of small local sub-problems are coordinated to achieve the solution of the main problem.

Note that the problem in (20) is composed of linear constraints and binary constraints and the global cost is the summation of local agents' costs. These characteristics allow to express it using an ADMM structure taking into account that (2) and (3) are lineal global constraints, (4) to (7) are Mixed integer local constraints and the  $OF$  is not affected by the binary decision variables[13].

The objective function of each agent is obtained by the decomposition of the Lagrangian according to the ADMM method. The Lagrangian is augmented with a quadratic regularization term, leading to a set of Mixed Integer Quadratic Programs (MIQP) that are solved iteratively until the distributed solutions converge, see [6].

The resulting local regularized costs are

$$J_{LGk}^\nu = \sum_{t=1}^{t_{end}} \left\{ \sum_{j=1}^N \lambda_{t,j}^\nu * P_{buyk,j}^t - \sum_{j=1}^N \lambda_{t,k}^\nu * P_{sellk,j}^t + \right. \quad (21)$$

$$\left[ m * \rho * \left( \sum_{j=1}^N * (\hat{P}_{buyj,k}^t - P_{sellk,j}^t)^2 - \sum_{j=1}^N * (P_{buyk,j}^t - \hat{P}_{sellj,k}^t)^2 \right) \right] * \Delta_t$$

$$t \in \tau, \quad k, j \in \Omega$$

Where  $\nu$  is the iteration counter and the shared variables during the decentralized iterations are denoted by as  $\hat{P}_{buyj,k}^t$ ,  $\hat{P}_{sellj,k}^t$  and  $\lambda_{t,k}^\nu$  is the Lagrange multiplier according to the ADMM method. Finally, the objective function minimized by each agent, denoted as  $OF_k^\nu$ , is

$$\begin{aligned} & \text{minimize} && J_{PTk} + J_{PVk} + J_{WEk} + \\ & P_{G_{buyk}}^t, P_{G_{sellk}}^t, && J_{ESk} + J_{LGk} \\ & P_{sellk,j}^t, P_{buyj,k}^t, && \\ & P_{ESDis}^t, P_{ESCh}^t, && \\ & P_{PVk}^t, P_{WEk}^t, && \end{aligned} \quad (22)$$

$$\text{subject to} \quad (12),(13),(14),(15),(18),(19), \\ (2),(4),(5),(6),(7)$$

where the power exchanges must be shared with all the agents at the end of each iteration. Once all the agents have minimized their own optimization problem, the solution of the entire EMS is the summation of each agent solution, i.e.,

$$OF = \sum_{k=1}^N OF_k \quad (23)$$

The Lagrange multipliers are updated by the primal residual term at the end of each iteration  $\nu$ , taking into consideration that the values of  $P_{sellk,j}^t$ ,  $P_{buyj,k}^t$  are already known for every agent, that is,

$$r_{t,k}^\nu = \sum_{j=1}^N P_{buyj,k}^t - \sum_{j=1}^N P_{sellk,j}^t, \quad (24)$$

$$\lambda_{t,k}^{\nu+1} = \lambda_{t,k}^\nu + 2 * m * \rho * r_{t,k}^\nu. \quad (25)$$

When  $\|r_{t,k}^\nu\|_\infty < \epsilon \quad \forall (t \in \tau, k \in \Omega)$  the iterative procedure concludes and the dispatch solution is found.  $\epsilon$  is the allowed power tolerance.

#### IV. ANALYSIS AND RESULTS

In this section, a case study with three MGs, based on the scheme shown in Fig. 1, is employed to validate the approaches proposed in the previous section. Each agent is subject to different profiles of load, PV and wind generation, while the price profile for buying and selling energy to the main grid is the same for all agents, as well as the characteristics of the BESS. All the profiles are presented in Fig. 2 and the characteristics for the BESS are shown in Table I. All the data sets are based on previous studies, see [12],[14],[15]. Also, all the operational limits are consigned in Table II.

This section is divided into two parts, the first one shows the comparison between the Centralized and Distributed approaches, and the second one presents an analysis of the effect of the battery degradation costs on the dispatch.

TABLE I: BESS Parameters

Depth of discharge (%)	[ 0.1, 0.25, 0.35, 0.5, 0.6, 0.7, 0.8, 0.9 ]
Number of Cycles (n)	[ 5700, 2100, 1470, 1000, 830, 700, 600, 450 ]
Max Capacity (kWh)	500
Round-trip Efficiency (%)	0.8
Efficiency Battery Charge (%)	0.95
Efficiency Battery Discharge (%)	0.9
Cost Replace BESS (\$)	900

TABLE II: Micro grids operational limits

$P_{ESChmax}$ (kW)	100
$P_{ESDismax}$ (kW)	100
$SOC_{ESmin}$ (%)	0.5
$SOC_{ESmax}$ (%)	1
$SOC_{Initial}$ (%)	1
$P_{G_{buymax}}$ (kW)	500
$P_{G_{sellmax}}$ (kW)	500
$P_{buymax}$ (kW)	500
$P_{sellmax}$ (kW)	500
$\Delta_{PV}$ (kW)	100
$\Delta_{Wind}$ (kW)	100
$\Delta_{Battery}$ (kW)	50

#### A. Comparison of Centralized and Distributed Approaches

Both, the centralized and distributed dispatch solutions, (20) and (22), have been solved for the operational constraints and profiles described above. A MATLAB simulation was employed, Yalmip [16] was used to describe the optimization problems and CPLEX was used to solve the MILP and MIQP programs.

Fig. 3 describes the cost obtained hourly by both approaches where the two solutions are consistent. The  $OF$  with the centralized approach is  $1.0691 * 10^5$  and with the distributed one it is  $1.0791 * 10^5$ , the small difference is due to the tolerance in the iteration stop criterion. Note that the centralized approach uses all the information about the agents' behavior while the distributed one only share power exchange information. Fig. 4 shows the ADMM convergence where the Y-axis is the value  $\|r_{t,k}^\nu\|_\infty$  for each iteration until the value is less than  $\epsilon$ . In this case the problem was solved in thirty iterations, after five iterations the cost value is closed to the optimal one, increasing marginally, while the algorithm needs more iterations to achieve the tolerance margin on the power balance.

Fig. 5 shows the exchange of energy between agents considering that the results of Centralized and Distributed approaches are equivalent. Fig. 5a shows that agent 3 is the one who gets more energy from other agents. This is caused by the reduced local power generation of this agent and also its high power consumption. This energy is acquired from agents 1 and 2, as shown in Fig. 5b, reducing the amount of energy bought from the main grid.

#### B. Cost Analysis with Battery Degradation Model

Now we analyze the changes in the  $OF$  as a function of the battery degradation costs. Table III summarizes the

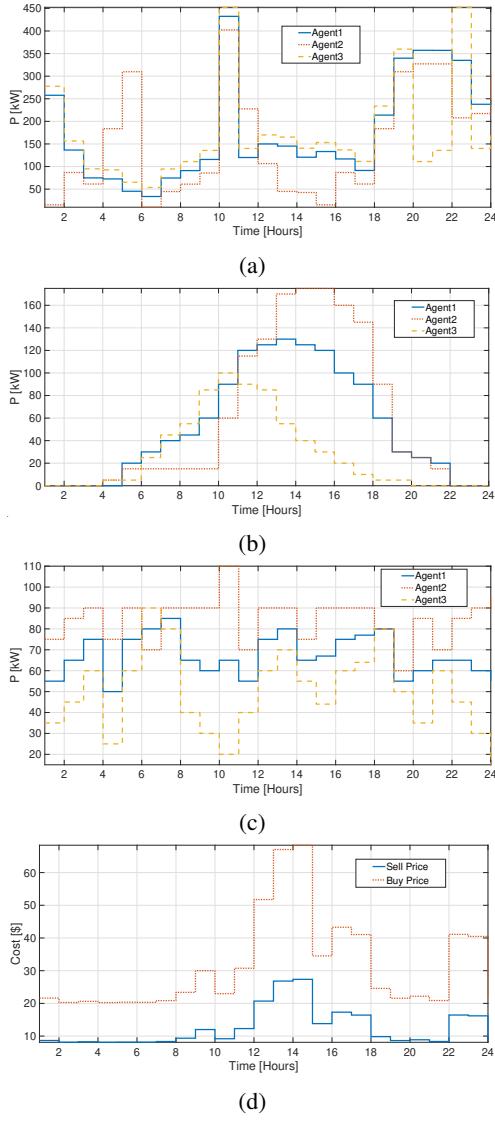

Fig. 2: Data sets used in the case study. (a) Load Power, (b) Photovoltaic Power, (c) Wind Power, (d) Grid energy Prices.

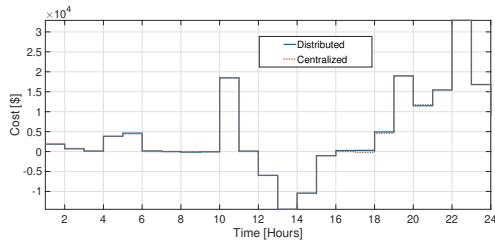

Fig. 3: Hourly dispatch cost of centralized and distributed approaches

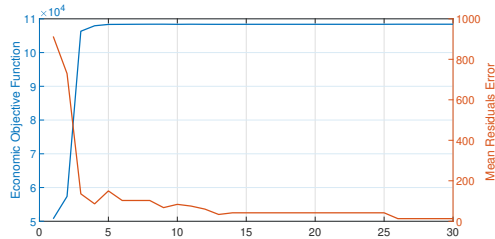

Fig. 4: ADMM convergence average value of  $\|r_{t,k}^\nu\|_\infty$  at each iteration

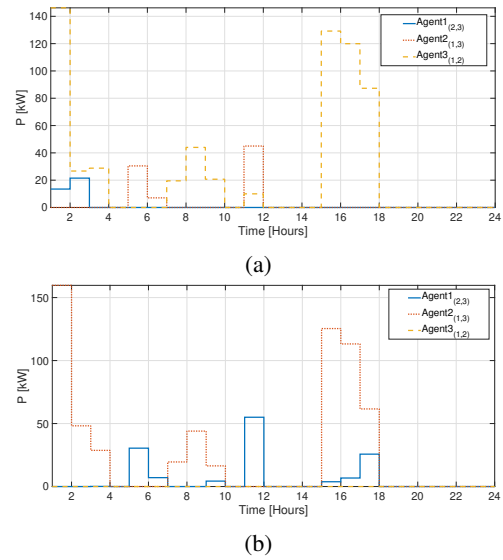

Fig. 5: Exchanges between agents, (a) Acquired power (b) Supplied power.

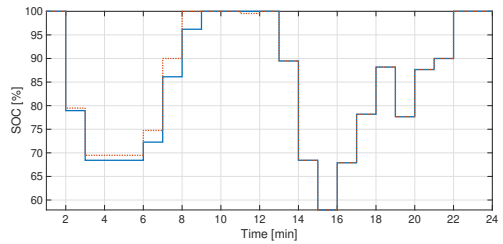

Fig. 6: Evolution of SoC for agent one. Continuous line: optimal solution considering aging costs. Dotted line: optimal solution without aging costs.

nominal values of the economic cost  $J_{ECO} = J_{PT} + J_{PV} + J_{WE}$  and the battery degradation cost  $J_{ES}$  when solving the dispatch in (20). It is noticed that  $J_{ES}$  is negligible, then the total cost  $OF$  is marginally affected by the aging term.

Considering the previous analysis, the dispatch in (20) is solved without the battery degradation cost in order to see how the behavior in the system changes. The evolution of the SOC for one agent is shown in Fig. 6. The use of the battery is reduced when the cost is included in the problem, however, the difference is minor.

Finally, a Pareto analysis is performed between the economic and battery aging costs, in particular using an  $\epsilon$  constraint method. Let  $\widehat{J}_{ES}$  be the battery aging cost as shown in Table III. A new dispatch is solved by minimizing only the economic cost imposing a limit on the battery degradation cost as

$$\begin{aligned}
 & \text{minimize} && \sum_{k=1}^N J_{PT_k} + J_{PV_k} + J_{WE_k} \\
 & PG_{buy_k}^t, PG_{sell_k}^t, && \\
 & P_{sell_{k,j}}^t, P_{buy_{j,k}}^t, && \\
 & P_{ES_{Dis_k}}^t, P_{ES_{Chk}}^t, && \\
 & P_{PV_k}^t, P_{WE_k}^t && \\
 & \text{subject to} && (12), (13), (14), (15), (18), (19), (2), \\
 & && (3), (4), (5), (6), (7), \\
 & && \sum_{k=1}^N J_{ES_k} * \Delta t \leq (1 - \alpha) * \widehat{J}_{ES}
 \end{aligned} \tag{26}$$

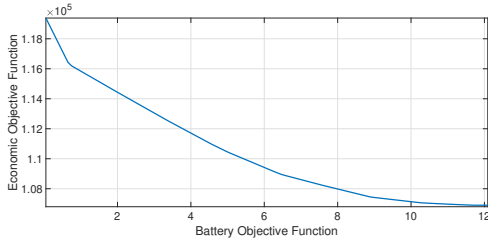

Fig. 7: Pareto front between  $J_{Eco}$  and  $J_{ES}$

The battery aging cost  $J_{ES}$  is constrained with a reduction factor  $\alpha$  w.r.t.  $\widehat{J}_{ES}$ . As  $\alpha$  goes from 0 to 1, the allowed aging costs is reduced from the nominal value  $\widehat{J}_{ES}$  to zero.

TABLE III: Cost Comparison of the Objective Function

$OF = J_{Eco} + J_{ES}$ [\$]	$J_{Eco}$ [\$]	$J_{ES}$ [\$]
106912.5	106900.4	12.1

As  $J_{ES}$  decreases, the cost of  $J_{Eco}$  rises considerably, this means that by limiting the usage of batteries the operation costs will be higher. The maximum aging cost is \$12.1, while the variation in the economic cost in the Pareto front is around  $\$1.10^4$ , i.e., an 11.67% increase. The new problem formulated in (26) is able to limit the battery aging cost through  $\alpha$  which allows finding a new operation point by the trade-off between the battery aging and the economic cost of the grid operation.

## V. CONCLUSIONS

In this work we have presented a day-ahead dispatch strategy for a set of Micro-Grids. A multi-objective optimization problem which includes the cost of battery aging is solved by both centralized and ADMM distributed approaches, and finally an analysis of the cost of the storage system aging is performed.

A set of three MGs, subject to different DER profiles, was used to validate the behavior of the proposed approaches. It was exemplified that both, centralized and distributed solutions are consistent and the difference between their solutions is less than 1% for each validated scenario. However, despite the small discrepancy, the centralized approach required the whole information of every agent to find a solution, which means that it needs to store a large amount of information. Then, as the problem grows by the number of agents, it will become computationally too complex. On the other hand, the ADMM distributed approach is an alternative to reduce the amount of information shared between agents, however, the number of iterations for finding the solution can be a limiting factor if the problem is not well constrained.

By analyzing the effect of adding the battery aging cost to the objective function, it was noticed that the degradation cost is negligible with respect to the other objectives, nevertheless, by a Pareto analysis, it was evidenced that the difference between including or not the battery in the dispatch increases the operative cost in 11.67%.

Interesting future research directions are sensitivity analysis of aging costs for different load/generation profiles, varying the number of agents, taking into account seasonality and geographical locations. On the other hand, we plan to explore how to solve both the centralized and distributed approaches considering uncertainty on resources such as renewable energies.

## REFERENCES

- [1] J. Qiu, J. Zhao, H. Yang, and Z. Y. Dong, "Optimal scheduling for prosumers in coupled transactive power and gas systems," *IEEE Transactions on Power Systems*, vol. 33, no. 2, pp. 1970–1980, 2018.
- [2] F. Garcia-Torres, D. G. Vilaplana, C. Bordons, P. Roncero-Sánchez, and M. A. Ridao, "Optimal management of microgrids with external agents including battery/fuel cell electric vehicles," *IEEE Transactions on Smart Grid*, vol. 10, no. 4, pp. 4299–4308, 2019.
- [3] C. Chen, S. Duan, T. Cai, B. Liu, and G. Hu, "Optimal allocation and economic analysis of energy storage system in microgrids," *IEEE Transactions on Power Electronics*, vol. 26, no. 10, pp. 2762–2773, 2011.
- [4] A. Y. Ali, A. Basit, T. Ahmad, A. Qamar, and J. Iqbal, "Optimizing coordinated control of distributed energy storage system in microgrid to improve battery life," *Computers Electrical Engineering*, vol. 86, p. 106741, 2020.
- [5] A. M. Abomazid, N. A. El-Taweel, and H. E. Z. Farag, "Optimal energy management of hydrogen energy facility using integrated battery energy storage and solar photovoltaic systems," *IEEE Transactions on Sustainable Energy*, vol. 13, no. 3, pp. 1457–1468, 2022.
- [6] S. Lilla, C. Orozco, A. Borghetti, F. Napolitano, and F. Tossani, "Day-ahead scheduling of a local energy community: An alternating direction method of multipliers approach," *IEEE Transactions on Power Systems*, vol. 35, no. 2, pp. 1132–1142, 2020.
- [7] A.-L. Klingler and L. Teichtmann, "Impacts of a forecast-based operation strategy for grid-connected pv storage systems on profitability and the energy system," *Solar Energy*, vol. 158, pp. 861–868, 2017.
- [8] J. Chen, W. Zhang, Y. Zhang, and G. Bao, "Day-ahead scheduling of distribution level integrated electricity and natural gas system based on fast-admm with restart algorithm," *IEEE Access*, vol. 6, pp. 17 557–17 569, 2018.
- [9] F. Conte, S. Massucco, M. Saviozzi, and F. Silvestro, "A stochastic optimization method for planning and real-time control of integrated pv-storage systems: Design and experimental validation," *IEEE Transactions on Sustainable Energy*, vol. 9, no. 3, pp. 1188–1197, 2018.
- [10] M. Alipour, B. Mohammadi-Ivatloo, and K. Zare, "Stochastic scheduling of renewable and chp-based microgrids," *IEEE Transactions on Industrial Informatics*, vol. 11, no. 5, pp. 1049–1058, 2015.
- [11] S. Wang, D. Guo, X. Han, L. Lu, K. Sun, W. Li, D. U. Sauer, and M. Ouyang, "Impact of battery degradation models on energy management of a grid-connected dc microgrid," *Energy*, vol. 207, p. 118228, 2020.
- [12] C. Bordin, H. O. Anuta, A. Crossland, I. L. Gutierrez, C. J. Dent, and D. Vigo, "A linear programming approach for battery degradation analysis and optimization in offgrid power systems with solar energy integration," *Renewable Energy*, vol. 101, pp. 417–430, 2017.
- [13] S. Boyd, N. Parikh, E. Chu, B. Peleato, and J. Eckstein, *Distributed Optimization and Statistical Learning via the Alternating Direction Method of Multipliers*, 2011.
- [14] J. Qiu, J. Zhao, H. Yang, and Z. Y. Dong, "Optimal scheduling for prosumers in coupled transactive power and gas systems," *IEEE Transactions on Power Systems*, vol. 33, no. 2, pp. 1970–1980, 2018.
- [15] T. Logenthiran, D. Srinivasan, A. M. Khambadkone, and H. N. Aung, "Multiagent system for real-time operation of a microgrid in real-time digital simulator," *IEEE Transactions on Smart Grid*, vol. 3, no. 2, pp. 925–933, 2012.
- [16] J. Lofberg, "Yalmip: a toolbox for modeling and optimization in matlab," in *2004 IEEE International Conference on Robotics and Automation (IEEE Cat. No.04CH37508)*, 2004, pp. 284–289.