



Title	Controlled charging of electric vehicles in residential distribution networks
Authors(s)	O'Connell, Alison, Flynn, Damian, Richardson, Peter, et al.
Publication date	2012-10
Publication information	O'Connell, Alison, Damian Flynn, Peter Richardson, and et al. "Controlled Charging of Electric Vehicles in Residential Distribution Networks." Institute of Electrical and Electronics Engineers, 2012.
Conference details	2012 3rd IEEE PES Innovative Smart Grid Technologies Europe (ISGT Europe), , Berlin, Germany
Publisher	Institute of Electrical and Electronics Engineers
Item record/more information	http://hdl.handle.net/10197/4756
Publisher's statement	© 2012 IEEE.
Publisher's version (DOI)	10.1109/ISGTEurope.2012.6465676

Downloaded 2023-10-05T14:16:07Z

The UCD community has made this article openly available. Please share how this access benefits you. Your story matters! (@ucd_oa)



© Some rights reserved. For more information

Controlled Charging of Electric Vehicles in Residential Distribution Networks

Alison O'Connell, *Student Member, IEEE*, Damian Flynn, *Senior Member, IEEE* Peter Richardson, *Member, IEEE*
Andrew Keane, *Member, IEEE*

Abstract—The integration of electric vehicles (EVs) poses potential issues for low voltage (LV) distribution networks, such as voltage deviations and overloading of equipment. Controlled EV charging is seen as one possibility for reducing, or even eliminating, these issues. This work presents an optimisation method which focuses on controlling the rate at which EVs charge over a 24-hour time horizon, subject to certain constraints. A sample distribution network is used and the optimisation tool is tested for multiple objective functions.

Index Terms—Electric Vehicle, Load Flow, Optimisation, Smart Grid.

I. INTRODUCTION

ELECTRIC vehicles (EVs) are a technology that has been gaining increasing interest in recent times. Many governments have set ambitious targets for penetration levels of EVs in an effort to reduce greenhouse gas emissions [1]. For example, in Ireland there is a targeted 10% EV penetration level by 2020 for passenger vehicles [2] which will be the equivalent of approximately 230,000 vehicles [3]. The charging of these vehicles will result in a significant increase in system demand at certain times which may in turn cause a major strain on power systems, in particular distribution networks. Furthermore, when a typical working day is considered it may be the case that EV charging coincides with the existing daily demand peak resulting in the need for expensive peaking plants to come online. To cope with this additional load there is a need to either invest in major network reinforcement, encourage EV users to charge at off peak times or to devise controlled charging schemes or some combination of the above.

Previous authors have proposed methods for controlling charging of EVs from both the system point of view [4], [5] and the distribution network point of view [6]–[9]. In [10] the authors used linear programming to maximise the energy delivered to EVs, subject to network constraints. Network sensitivities to the addition of EV load were obtained by running load flow calculations for increasing penetration levels

Alison O'Connell (alison.o-connell@ucdconnect.ie), Damian Flynn, Peter Richardson and Andrew Keane are with the School of Electrical, Electronic and Communications Engineering, University College Dublin, Ireland.

This work was conducted in the Electricity Research Centre, University College Dublin, Ireland, which is supported by the Commission for Energy Regulation, Bord Gáis Energy, Bord na Móna Energy, Cylon Controls, EirGrid, Electric Ireland, Energia, EPRI, ESB International, ESB Networks, Gaellectric, Intel, SSE Renewables and UTRC.

This work was funded under the Programme for Research in Third-Level Institutions (PRTL) Cycle 5 and co-funded under the European Regional Development Fund (ERDF).

of EVs, which were then used to optimise EV charging rates. The authors in [11] examined a case study for both EVs and distributed generation (DG) for the year 2030. The charging start time of EVs was controlled subject to the users' desired final battery state of charge (BSOC) and charging end time. Another method proposed by [12] used both quadratic and dynamic programming to minimise distribution network losses based on when customers need EVs to be fully charged by. Many of the above approaches require an optimisation calculation for each time step and have only one objective, in many cases minimising power losses.

In this work a 24-hour horizon is considered, meaning that only one optimisation is required per day. The optimisation objective can be varied and customised to an individual network operator's specifications. In this case three objectives and an uncontrolled case are tested and compared with respect to EV charging. All calculations are performed using time series three phase unbalanced load flow. Section II outlines the optimisation process, Section III describes the test network and simulation case, Section IV presents the results and discussion and Section V outlines the main conclusions and further work.

II. METHODOLOGY

A. Load Flow Method

The load flow method used in this work is the four conductor current injection method (FCIM) proposed by the authors in [13]. The Newton-Raphson based method performs a three-phase load flow with additional representation of the neutral conductor. It can be used for balanced or unbalanced load flow, and on both radial and meshed feeders. The known currents injected at each bus by loads, generators, etc. are used to calculate the current mismatches. The Jacobian matrix is formed using the elements of the nodal admittance matrix and combined with the current mismatches gives values for the voltage mismatches at each bus.

B. Network Sensitivities

A network sensitivity matrix is computed in a similar fashion to that of [10], performing load flow calculations to determine network sensitivities to the addition of load, however in this case the matrix relates changes in real and imaginary current at one node to changes in real and imaginary voltage at both its own node and other nodes. This provides the ability to predict the network voltages for specified changes in current.

C. Optimisation

The optimisation may be implemented by some third party aggregator as a centralised scheme to control the charge rate of EVs on an individual feeder or on a group of feeders. It is assumed that the aggregator has full knowledge of the network conditions for both current and future optimisation horizon i.e 24 hours ahead. In reality there may be some forecasting errors, however those errors have not been considered as of yet.

Three different objectives are tested in this work as described in the following subsections.

1) *Maximum Power Objective*: Maximises the power delivered to EVs for the total availability period, as shown in (1), meaning that a particular EV's charging is spread across the time period for which it is available, subject to the energy requirement constraint (6). This results in a somewhat flattened EV load profile with some variations representing EVs connecting and disconnecting.

$$\max \sum_{h \in D} \sum_{k \in K_{EV}} \sum_{d \in \sigma_d} (P_{EV_k}^d)_h \quad (1)$$

where

D	set of all hours for which tool is being run;
K_{EV}	set of buses with an EV connected;
σ_d	set of phases $\{a, b, c\}$;
$P_{EV_k}^d$	EV active power at bus k phase d .

2) *Minimum Cost Objective*: Minimises the cost of charging EVs, as seen in (2). The minimum cost objective can be viewed as a customer focused objective as it serves as an incentive for EV users to allow a third party to control the charging of their EV. It could also be seen as advantageous from a system point of view, as a low electricity price usually correlates quite well with low system demand, meaning that EV charging may be allocated to those periods of lower demand. In (2), C_h represents the cost of electricity at hour h . It is assumed that the electricity price is known a day in advance and that the addition of EV load has been considered when the price for each hour was determined. It should be noted that the energy requirement constraint, defined in equation (6), restricts the optimisation so that the minimum cost solution does not mean that all $P_{EV_k}^d = 0$.

$$\min \sum_{h \in D} \sum_{k \in K_{EV}} \sum_{d \in \sigma_d} (P_{EV_k}^d)_h \times C_h \quad (2)$$

3) *Maximum Wind Objective*: Maximises power delivered to EVs when the system wind penetration is high, as in (3). This objective takes a system viewpoint. When the ratio of forecasted wind to system demand (forecasts are used as this tool is being run for a 24-hour horizon) is high, it can be assumed that system demand is low while wind generation is high. Interconnector flows with neighbouring systems will complicate this relationship. There is then scope to increase demand, in this case by adding EV load to the system, without depending on expensive peaking plants coming online. In (3), W_h represents the ratio of forecasted wind to system demand.

$$\max \sum_{h \in D} \sum_{k \in K_{EV}} \sum_{d \in \sigma_d} (P_{EV_k}^d)_h \times W_h \quad (3)$$

4) *Constraints*: Equation (4) shows the voltage constraint created using the network sensitivity matrix mentioned in Section II-B, where the voltage is limited between V_{min}^d and V_{max}^d . V_{init}^d represents the initial voltage computed by the load flow for the base case when there are no EVs present.

$$V_{min}^d \leq \text{abs}(V_{init}^d - \alpha_k^d I_k^d - \sum_{i=1}^{nb} \sum_{t \in \sigma_d} \alpha_{ki}^{dt} I_i^t) \leq V_{max}^d \quad (4)$$

where

nb	total number of buses;
$I_k^d = I_{Re_k}^d + j I_{Im_k}^d$	phase d current injection at bus k ;
α_k^d	sensitivity of phase d bus k voltage to changes in phase d bus k current;
α_{ki}^{dt}	sensitivity of phase d bus k voltage to changes in phase t bus i current;

Other constraints are imposed on the optimisation as follows:

EV charging rates are limited between an upper and lower bound $P_{EV_{min}}^d$ and $P_{EV_{max}}^d$ respectively.

$$P_{EV_{min}}^d \leq P_{EV_k}^d \leq P_{EV_{max}}^d \quad (5)$$

Batteries have a maximum energy capacity B_{max} and aim to be fully charged by the end of the charging period $H \subseteq D$. H consists of those hours for which the EV is available. $BSOC$ refers to the initial battery state of charge.

$$\sum_{h \in H} (P_{EV_k}^d)_h = B_{max_k} - BSOC_k \quad (6)$$

The total apparent power, which consists of both the residential load and the EV load, flowing through the network transformer at each time step cannot exceed its rating of $S_{T_{rated}}$. S_k^d in equation (7) refers to the residential load, which is comprised of both real and reactive power, without the EV load $P_{EV_k}^d$, which is purely real power.

$$\text{abs}(\sum_{d \in \sigma_d} \sum_{k \in \Omega_k} (S_k^d + P_{EV_k}^d)) \leq S_{T_{rated}} \quad (7)$$

The total current flowing through each phase of the mains cable connecting the transformer to the network has a current rating of $I_{MC_{rated}}$. I_{MC}^d is the current flowing through a particular phase of the mains cable, which is calculated using the cable impedance matrix and the predicted voltages obtained from the voltage constraint.

$$\text{abs}(I_{MC}^d) \leq I_{MC_{rated}} \quad (8)$$

All service cables, the single phase cables connecting the customers' households to the three phase nodes, have a maximum import capacity as defined by the distribution system operator (DSO). Accordingly, each customer's total load must be less than this maximum capacity rating $S_{SC_{rated}}$, as shown in (9) below.

$$abs(S_k^d + P_{EV_k}^d) \leq S_{SC_{rated}} \quad (9)$$

All constraints mentioned apply to the objectives outlined above. Absolute values of voltage, current and power are used in the constraints as the rating values provided by the DSO are absolute and not complex values.

The optimisation is implemented in MATLAB [14], using the non-linear programming function `fmincon`. The sequential quadratic programming (SQP) algorithm, which is an iterative quadratic programming method, is used to solve the non-linear optimisation problem. The non-linearity of the problem is due to the use of current as the manipulated variable but power in the definition of both the constraints and the objective function, which can be observed in the description of the voltage constraint in equation 4.

The flowchart in Fig. 1 shows the high level steps of the optimisation tool process. Feeder inputs such as underlying residential load, system impedances, etc. are used to perform a three phase unbalanced load flow calculation for the 24-hour time period without any EV load. The results from this load flow and EV inputs such as EV availability, initial BSOC, etc. are input to the optimisation tool. The optimisation is performed and the EV profiles are combined with the residential load to perform a validation load flow to ensure that the profiles do not cause any network limitations to be breached.

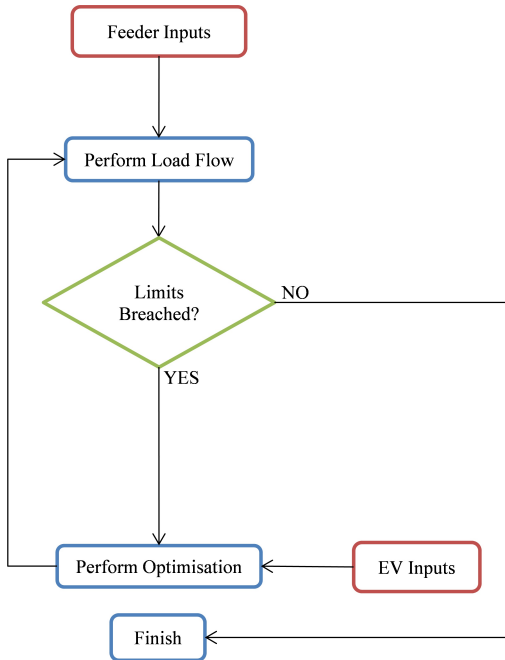

Figure 1. High level flowchart of optimisation

III. TEST CASE

A. Test Network

The test network consists of a low voltage (LV) residential feeder where a LV substation serves a total of 74 customers (85 buses). This network represents a typical suburban feeder in

Ireland. A simplified version of the network can be seen in Fig. 2. Each service cable, customer load and EV load is modelled individually on its corresponding phase, and not as a lumped load, as represented in Fig. 2. Medium voltage (MV) 38 kV:10 kV tap changing transformers are controlled to ensure that the voltage at their 10 kV side is regulated to a nominal value. A voltage drop is incurred between the 10 kV buses and the LV feeder substation bus which is accounted for by assuming that the line to line voltage at the high side of the transformer substation is at a fixed value of 9.7 kV. CPOC in Fig. 2 refers to customer point of connection.

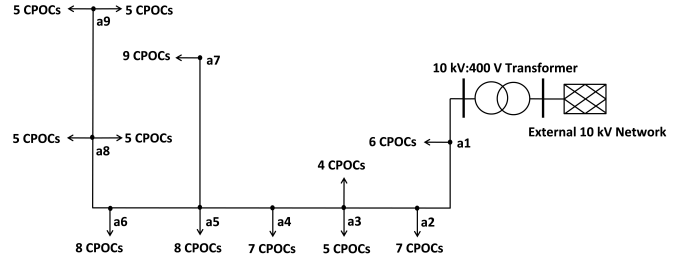

Figure 2. Simplified single line diagram of test network

The total annual energy usage for each individual customer in the above network has been obtained from the DSO. Typical yearly profiles for low, medium and high use customers have also been obtained. These are then scaled according to each individual customer's annual usage and time shifted to recognise load diversity. The coincidence factor of the customer profiles is calculated to ensure that they are realistic. This value is found to be 0.22, which is reasonable when compared to values for similar networks [15]. Customer loads are modelled as constant power, as the typical load composition for this network is unknown.

In Ireland, the voltage tolerance is $\pm 10\%$ of the nominal value of 230 V [16], which gives minimum and maximum allowable voltages of 207 V and 253 V respectively. However, to allow for the predictive nature of the voltage constraint in (4) the minimum and maximum voltages are defined in the optimisation as 210 V and 250 V respectively.

The transformer supplying the network is rated at 400 kVA and the mains cable has a maximum current limit of 424 A. The maximum import capacity for average domestic households, as specified by the DSO, is 12 kVA. The two apparent power ratings and the current rating are used as the constraining values in the optimisation, as seen in (7-9).

Domestic EV charging is assumed to be single-phase only. So, the charging rate of the EVs is limited to between 0 kW and 4 kW. Batteries are assumed to have a 20 kWh capacity and the EV load is assumed to be constant power.

B. Simulation Case

The method, as described in Section II, was tested for a 24-hour time period, in time steps of an hour, from 07:00 to 07:00 the following day so that an entire charging period could be observed. The 24-hour period that was chosen had the highest network demand time step of the year (94 kW) and thus represented a high load winter day.

Varying EV penetration levels were examined by randomly allocating EVs across the network of 74 customers. The penetration level refers to the percentage of customers on the feeder with an EV present, and it was assumed that there was only one EV present per household. Each EV has its own randomly assigned availability period and initial BSOC. A mean plug in time of 18:00 and plug out time of 07:00 was used to determine each EV's availability and a mean initial BSOC of 8 kWh was used to determine each EV's initial BSOC.

Multiple objective functions were tested, as mentioned in Section II-C, at a penetration level of 50% which amounts to 37 EVs on the network or a potential additional load of 148 kW. The EVs were evenly spread across the network and the phases, which can be seen in Table I. An uncontrolled case was also considered, which consisted of all EVs commencing charging immediately when plugged in.

Table I
EV LOCATION AND PHASE

3-Phase Node	Phase a	Phase b	Phase c
a1	1	1	1
a2	2	1	1
a3	0	3	1
a4	1	1	2
a5	1	1	2
a6	2	1	2
a7	2	1	1
a8	2	1	2
a9	1	3	0
Total	12	13	12

The cost function, used for the minimum cost scenario and for cost comparisons in Section IV, is the system marginal price (SMP) acquired from the Irish Single Electricity Market Operator (SEMO) [17]. The wind function has been obtained from the Irish transmission system operator (TSO) [18]. It should be noted that these profiles are for arbitrary days to demonstrate the optimisation and in reality would vary day to day.

IV. RESULTS AND DISCUSSION

Fig. 3 compares the minimum CPOC voltage recorded at any node and any time step over a 24 hour time period, for increasing penetration levels of EVs, for the three objective functions and the uncontrolled case. In this figure and subsequent figures depicting voltage the black dashed line represents the minimum allowable voltage, as defined in Section III by the DSO, and the grey dashed line represents the minimum allowable voltage defined in the optimisation. It can be seen that for the controlled cases the minimum voltage seen drops somewhat steadily until approximately 50% penetration. At this stage the voltage constraint limits charging so that network voltages remain above the minimum level. In contrast, for the uncontrolled case the voltage continues to drop, although the minimum voltage level has been breached at a penetration level of approximately 37%. It should be noted that the voltages displayed in the figures are the results of the 'check' load flow and not the predicted voltages of the optimisation, so although the optimisation may predict that all

voltages are above 210 V when the check is performed it may be the case that some voltages do in fact fall slightly below 210 V, but are still above the acceptable limit of 207 V.

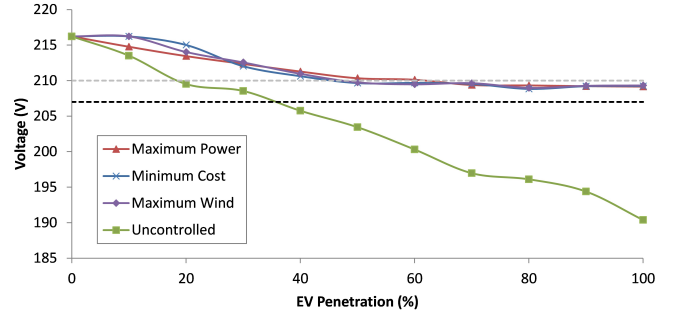

Figure 3. Minimum daily CPOC voltage for increasing EV penetration level

In Figs. 4 and 7 the shaded area represents the time period that all EVs, or a single EV, are available. It should be noted that for all three objectives all customers' energy requirements were satisfied by the end of their respective availability period.

Figs. 4-6 show the aggregated results for a 50% EV penetration level, for the three objective functions and the uncontrolled case. It can be seen in Fig. 4 (a) that because the uncontrolled case allows EVs to commence charging as soon as they connect to the network that there is a large EV load peak at 18:00: an hour at which the network already has a large underlying residential demand (90 kWh). Looking at the minimum CPOC voltages for the uncontrolled case in Fig. 5 it is clear that the excessive demand on the network at 18:00 and 19:00 causes voltages to drop below the minimum level to a value of almost 205 V.

For the minimum cost controlled scenario EV charging is confined to hours when the price is low, namely 00:00 - 05:00, which can be seen in Fig. 4 (b), and minimum voltages are kept above the acceptable level.

For the maximum power controlled case instead of there being a large block of demand at a certain time there is a slight peak at 18:00 but charging is kept at a reasonably constant rate and is spread across all available hours with a small drop off at later hours. This results in a somewhat smoother daily voltage curve in Fig. 5 with a small trough at 19:00 but voltages are kept above the minimum limit.

The maximum wind objective, like the minimum cost, controls EVs to hold off charging until the level of wind penetration on the system is high, at 20:00-22:00 and again at 00:00-01:00, which can be observed in Fig. 4 (b). Another time where the wind ratio is high is 16:00 and it can be seen that the few EVs that are available at this hour charge and then proceed to disconnect for the following 3 hours when the ratio is low. At 22:00 when the charging reaches its peak there is a drop in voltage which just falls below 210 V, pushing the voltage towards its lower boundary, however the voltage constraint ensures that it is kept above 207 V.

Fig. 6 shows the thermal loading of (a) the transformer feeding the network, (b) the mains cable connecting the substation to the feeder, and (c) the service cable that has the highest apparent power flowing through it for each hour, for the three

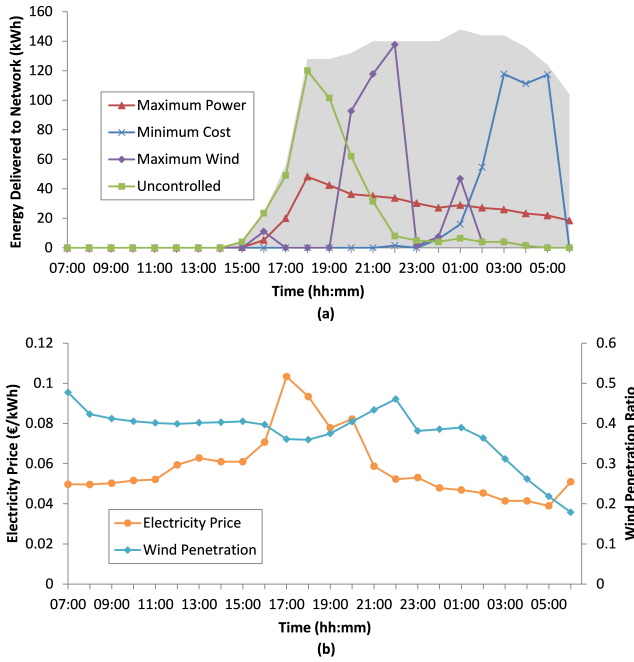

Figure 4. Aggregate EV load for 50% EV penetration level, 24-hour time period, three objectives and uncontrolled case

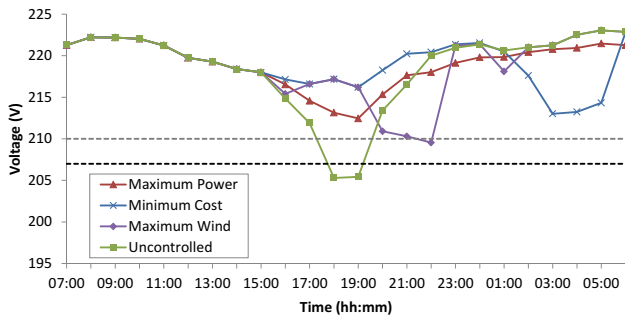

Figure 5. Minimum CPOC voltages for 50% EV penetration level, 24-hour time period, three objectives and uncontrolled case

objectives and the uncontrolled case with the charging profiles seen above in Fig. 4 (a). The black dashed line represents 100% of the rated apparent power for the transformer and service cables, and 100% of the current rating for the mains cable. It is clear that although these components are heavily loaded at the peak EV load hours, they have not reached 100% of their rated values even for the uncontrolled case. This shows that the thermal loading is not the binding constraint for this particular network and the network conditions of this simulation case, therefore the focus for the following results will be on the minimum voltage levels.

Table II shows the total network losses as a percentage of energy served for all three objective functions, the uncontrolled case and the system without EV load. It presents the minimum percentage losses for the day, the maximum percentage losses for the day and the time of day at which they occur, as well as the average daily percentage losses. The minimum losses are the same value of 0.66%, except for for the maximum power and minimum cost cases, as both of these objectives

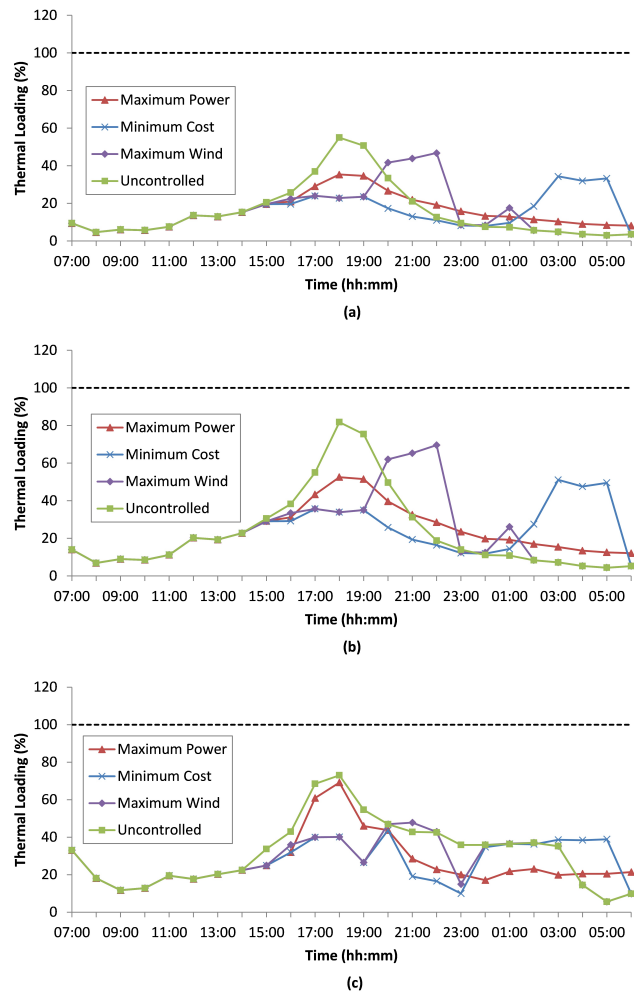

Figure 6. Thermal loading of (a) transformer, (b) mains cable and (c) maximum customer service cable for 50% EV penetration level, 24-hour time period, three objectives and uncontrolled case

allocate charging at 05:00 which is, without EV load, the most lightly loaded time of day with a demand of 12 kWh. Unsurprisingly, the highest maximum losses are a result of uncontrolled charging with a value of 15.45%, more than twice the losses of the case without any EVs. The minimum cost case has the lowest maximum losses of 8.90% as it has pushed charging to periods when the underlying demand is relatively low. The opposite can be said for the maximum wind case, which has the highest maximum losses of all three objectives (11.96%), due to charging occurring earlier in the evening. The average percentage losses for the day are quite similar with values of approximately 4%. It should be noted that the highest average daily losses occurred on phase b for all cases due to the additional EV present on that phase.

Table III compares the total cost incurred by the aggregate charging of the EVs for each objective and the uncontrolled case as well as the percentage increase each scenario costs when compared to the minimum cost case. The uncontrolled case, as well as causing unacceptably voltages, costs €34.61, which is almost double that of the minimum cost scenario, while both the maximum power and maximum wind objectives

Table II
NETWORK LOSSES

	Minimum Daily (%)	Hour (hh:mm)	Maximum Daily (%)	Hour (hh:mm)	Average (%)
No EV Load	0.66	05:00	6.53	17:00	2.88
Maximum Power 50%	1.33	08:00	9.63	18:00	4.05
Minimum Cost 50%	0.89	06:00	8.90	03:00	4.13
Maximum Wind 50%	0.66	05:00	11.96	22:00	4.14
Uncontrolled 50%	0.66	05:00	15.45	18:00	4.17

incur a cost almost 50% over the minimum cost case.

Table III
COST COMPARISON

	Total Cost (€)	% Over Minimum Cost
Maximum Power	26.39	49.53
Minimum Cost	17.65	-
Maximum Wind	25.55	44.78
Uncontrolled	34.61	96.07

Figs. 7 and 8 show results for an individual customer located at the end of the feeder, for a 50% EV penetration level, for the three objectives and the uncontrolled case. The service cable for this customer connects to node a9, as seen in Fig. 2. This customer's EV is available from 18:00-06:00 and has an initial BSOC of 11 kWh, which gives an energy requirement of 9 kWh.

Fig. 7 shows the charging profiles for this customer, while Fig. 8 shows the voltages at this customer's CPOC resulting from the respective charging observed in Fig.7. Uncontrolled charging has this customer's EV charge at maximum power of 4 kW upon connection to the network and then drop to 1 kW for the final hour to complete the charge, resulting in acceptable voltage limits being breached.

The maximisation of power case has this customer's charging kept at a reasonably constant rate of between 0.5 kW and 1 kW and is spread across all available hours with a slight drop off at later hours. The voltage at the point of connection is kept above the minimum level.

For the minimisation of cost scenario the customer's charging is contained to the cheapest hours of the day (00:00 - 05:00). However, it should be noted that at the cheapest hours, namely 03:00 - 05:00, when the EV would be expected to charge at its maximum rate the charging is curtailed, which is due to the optimisation allocating all EVs to charge at these times and resulting in an overall drop in network voltage. To avoid voltages breaching limits, the optimisation decreases charging rates for buses deemed most sensitive. This customer's bus would be considered sensitive, being at the end of the feeder, and therefore has a decreased charge rate at these times.

The curtailment of charge can also be observed in the maximum wind case, where at the time of highest wind penetration on the system (22:00) this particular customer is not charging at maximum power but is curtailed slightly to 3.3 kW as the voltage is hitting its limit. Looking at Fig. 8 it is clear that this customer's voltage has fallen slightly below 210 V but is still above the 207 V boundary.

The cost of this customer's charging for the minimum cost case is €0.37 and for the uncontrolled case is €0.76, a cost saving of more than half.

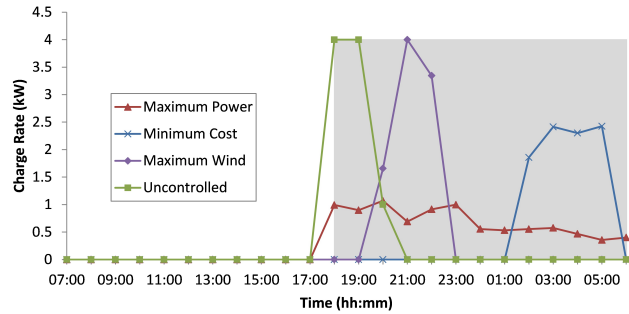

Figure 7. Customer at end of feeder, EV load for 50% EV penetration level, 24-hour time period, three objectives and uncontrolled case

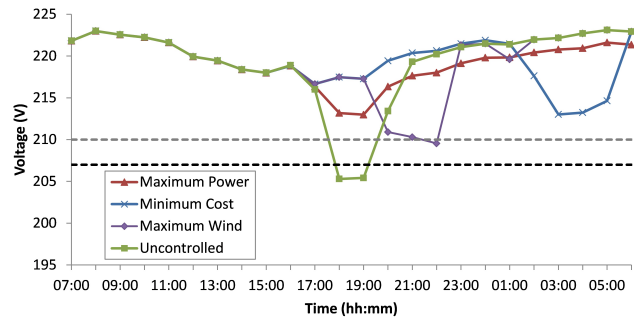

Figure 8. Customer at end of feeder, CPOC voltage for 50% EV penetration level, 24-hour time period, three objectives and uncontrolled case

V. CONCLUSIONS AND FURTHER WORK

The aim of the work was to optimise the charging of EVs for a 24-hour time horizon on a test network for multiple objective functions. The results show that controlling the charging of EVs can reduce the large voltage drops that could be incurred at certain times if charging is left uncontrolled, as well as minimising losses and reducing charging costs. They also demonstrate that the choice of objective function can be a significant factor for both EV charge rates and network voltages. Depending on the network operator's preferences any one of the three objectives presented may be preferable. For example, if the desire was to flatten out the feeder load profile or avoid large demand peaks the maximum power case would be favourable. If the wish was to encourage customers to allow their EV charging to be controlled, informing them they could have a significant cost saving if they did so would undoubtedly entice them, making the minimum cost objective more desirable. For a scenario where avoiding curtailment of wind was the intent, the addition of EV load to the system would be one solution and the maximum wind objective could help achieve this.

The uncertainties and potential variability of some of the inputs to this tool have not been taken into consideration in this work. It may be the case that the residential load, or

customer EV availability, for example, change dramatically between the time that the initial optimisation was performed and real time. These changes could mean that although initially the generated EV charge profiles were optimal and satisfied network constraints, that may no longer be the case. To account for these uncertainties future work will consist of the development of a rolling optimisation which will update its forecasts at each hour to ensure that the optimal solution is reached and that advantage is taken of new information.

REFERENCES

- [1] *Directive 2009/28/EC of the European Parliament and of the Council on the promotion of the use of energy from renewable sources*, The European Parliament and the Council of the European Union, 2009, [Online] Available: <http://eur-lex.europa.eu/LexUriServ/LexUriServ.do?uri=Oj:L:2009:140:0016:0062:en:PDF>.
- [2] *National Renewable Energy Action Plan Ireland*, Department for Communications, Energy and Natural Resources, 2009, [Online] Available: <http://www.dcenr.gov.ie/NR/rdonlyres/C71495BB-DB3C-4FE9-A725-0C094FE19BCA/0/2010NREAP.pdf>.
- [3] *Smarter Travel, a Sustainable Transport Future: A New Transport Policy for Ireland 2009-2020*, Department of Transport, 2009, [Online] Available: <http://www.transport.ieuploadgeneral112840.pdf>.
- [4] A. Shortt and M. O'Malley, "Quantifying the long-term power system benefits of electric vehicles," in *Proc. IEEE PES Innovative Smart Grid Technologies (ISGT)*, 2012.
- [5] P. Mitra and G. K. Venayagamoorthy, "Wide area control for improving stability of a power system with plug-in electric vehicles," *IET Generation, Transmission & Distribution*, vol. 4, no. 10, pp. 1151–1163, 2010.
- [6] S. Acha, T. C. Green, and N. Shah, "Effects of optimised plug-in hybrid vehicle charging strategies on electric distribution network losses," in *Proc. IEEE PES Transmission and Distribution Conf. and Exposition*, 2010.
- [7] S. Deilami, A. S. Masoum, P. S. Moses, and M. A. S. Masoum, "Real-time coordination of plug-in electric vehicle charging in smart grids to minimize power losses and improve voltage profile," *IEEE Transactions on Smart Grid*, vol. 2, no. 3, pp. 456–467, 2011.
- [8] G. B. Shrestha and B. C. Chew, "Study on the optimization of charge-discharge cycle of electric vehicle batteries in the context of Singapore," in *Proc. Australasian Universities Power Engineering Conf. (AUPEC)*, 2007.
- [9] S. Paudyal and S. Dahal, "Impact of plug-in hybrid electric vehicles and their optimal deployment in smart grids," in *Proc. Australasian Universities Power Engineering Conf. (AUPEC)*, 2011.
- [10] P. Richardson, D. Flynn, and A. Keane, "Optimal charging of electric vehicles in low-voltage distribution systems," vol. 27, no. 1, pp. 268–279, 2012.
- [11] P. Papadopoulos, S. Skarvelis-Kazakos, I. Grau, L. M. Cipcigan, and N. Jenkins, "Predicting electric vehicle impacts on residential distribution networks with distributed generation," in *Proc. IEEE Vehicle Power and Propulsion Conf. (VPPC)*, 2010.
- [12] K. Clement-Nyns, E. Haesen, and J. Driesen, "The impact of charging plug-in hybrid electric vehicles on a residential distribution grid," vol. 25, no. 1, pp. 371–380, 2010.
- [13] D. R. R. Penido, L. R. de Araujo, S. Carneiro, J. L. R. Pereira, and P. A. N. Garcia, "Three-phase power flow based on four-conductor current injection method for unbalanced distribution networks," vol. 23, no. 2, pp. 494–503, 2008.
- [14] Matlab R2010b. [Online]. Available: www.mathworks.com
- [15] H. L. Willis, *Power Distribution Planning Reference Book*, 2nd ed. CRC Press, 2004.
- [16] *Distribution Code*, 2nd ed., ESB Networks, October 2007, [Online] Available: <http://www.esb.ie/esbnetworks/en/downloads/Distribution-Code.pdf>.
- [17] Market data. Single Electricity Market Operator. [Online]. Available: <http://www.sem-o.com/marketdata/Pages/default.aspx>
- [18] System performance data. Eirgrid. [Online]. Available: <http://www.eirgrid.com/operations/systemperformancedata/windgeneration/>



Alison O'Connell (S'12) received a B.E degree in Electrical Engineering from University College Dublin in 2011. She is currently studying for her Ph.D. at University College Dublin with the Electricity Research Centre. Her research interests include distribution network modelling, unbalanced load flow, electric vehicles and distributed energy resources.



Damian Flynn (M'96–SM'11) is a senior lecturer in power engineering at University College Dublin, Dublin, Ireland. His research interests involve an investigation of the effects of embedded generation sources, especially renewables, on the operation of power systems. He is also interested in advanced modelling and control techniques applied to power plant.



Peter Richardson (S'08–M'12) completed his B.E. and Ph.D. degrees in Electrical Engineering in University College Dublin in 2007 and 2012 respectively. His research interests include electric vehicles, distributed energy resources and distribution systems.



Andrew Keane (S'04–M'07) received the B.E. and Ph.D. degrees in electrical engineering from University College Dublin, Dublin, Ireland, in 2003 and 2007, respectively. He is currently a lecturer with the School of Electrical, Electronic, and Communications Engineering, University College Dublin with research interests in power systems planning and operation, distributed energy resources, and distribution networks.