

**Expanding the Boundaries of Traditional Enamel**  
***Plique-à-Jour* through Hybrid Craft Practice**

Yinglong Li

Supervisory team:

Director of Studies: Ann Marie Carey

Specialist Supervisor (i): Sian Hindle

Specialist Supervisor (ii): Stephen Bottomley

Supervisory Mentor: Anne Boulwood

Invited Advisor Elizabeth Turrell

Birmingham City University,  
Faculty of Arts, Design and Media, School of Jewellery

2023

# Thesis abstract

This practice-based research investigates the traditional enamelling craft of plique-à-jour and approaches to innovation through hybrid craft. Today, while material science and technology provide potential opportunities for developing traditional craft, traditional making methods also promote new design thinking. Hybrid craft is a hybrid form of making, promoting the birth of new techniques through a combination of physical craft and digital technology. As a metal-based enamel, plique-à-jour consists of enamel within a metal frame. A literature review revealed that in the past, the main techniques used to make the metal frames included piercing, wire soldering, and casting, with the enamel seen as a decorative material fired onto the metal body. The application of enamels and the making processes of metal frameworks have remained fundamentally the same since the 6<sup>th</sup> century A.D. This study describes how the limits of these frames can be challenged by new design thinking, craft practice, and digital technology.

This research uses reflection on studio practice as a practice-based methodology and documentation to collect data, address issues, and achieve new findings. The studio practice is divided into four phases, starting with a new concept “Mind the Gap (MTG)” and initial material testing. The second phase of the experiments further validate the MTG notion mainly through the handmade approach. The third phase pursues precise modeling, with the production of metal scaffolding combined with digital technologies. The final phase explores the effective method of removing scaffolding, thus, rediscovering the value of traditional making knowledge.

New enamelling technique and insights and have emerged in the use of enamel

as a bonding agent in design, leading to the orderly connection of metal spheres to the enamel through constructing modular scaffolding. After removing the scaffold, new forms of enamel bridging and new visual languages were obtained, which expand the boundaries of traditional plique-à-jour. A new series of enamel objects, the Mind the Gap series, was achieved after iterative studio practices, providing a set of discoveries and potential for future practitioners and researchers in the field of craft and design.

**Keywords:** plique-à-jour, digital technology, hybrid craft practice, innovation of traditional craft, practice-based research

# Declaration

This thesis is completed independently by myself and has not used as an application for any of the degrees. All the materials in the thesis, including the reference, acknowledgment, writing, and creative practice outcome are presented entirely by my own.

Signed:  Yinglong Li

Date: 17<sup>th</sup> March 2023

# Acknowledgments

Firstly, I would like to thank the School of Jewellery, Birmingham City University for giving me the opportunity to start the PhD programme. During four years of study, the School of Jewellery has provided me with an excellent learning atmosphere and high-quality hardware that has helped me to conduct different craft practices.

Secondly, I am grateful of the teachers who supported and advised me during my studies: Jivan Astfalck, Dauvit Alexander, Jeremy Hobbins, Andrew Howard, Rebecca Skeels, Frank Cooper, and Alice May. And my thanks also give to five masters of enamelling for their technical and creative guidance in my craft practice: Fred Rich, Jane Short, Jacqueline Ryan, Fuliang Ma, and Liansheng Zhong.

Finally, I would like to express my greatest gratitude to four of my supervisors, Dr Ann Marie Carey, Dr Sian Hindle, Prof Stephen Bottomley, and Elizabeth Turrell. Without their mentoring, feedback and support throughout the whole process, I cannot complete the challenging and rewarding PhD study.

# Contents

Thesis abstract.....	ii
Declaration .....	iv
Acknowledgments.....	v
Contents.....	vi
List of figures .....	ix
List of tables.....	xiv
<b>1 Introduction.....</b>	<b>1</b>
1.1 Research context .....	1
1.2 Research questions and aims .....	3
1.3 Methodology.....	6
1.4 Thesis structure and contribution .....	7
<b>2 Literature review.....</b>	<b>9</b>
Part1: Craft practice and innovation.....	9
2.1 The marginalisation of craft.....	9
2.2 Craft and making.....	14
2.3 Hybrid craft practice .....	17
2.4 Craft innovation and sustainability .....	18
2.4.1 Design as an impetus for innovation .....	18
2.4.2 Craft as resources for innovation.....	21
<b>2 Literature review.....</b>	<b>28</b>
Part 2: Enamelling technique plique-à-jour .....	28
2.5 Enamel and its history.....	28
2.6 Four main decorative enamelling techniques.....	36
2.7 The art of plique-à-jour .....	41
2.7.1 Plique-à-jour: from history to the contemporary practice .....	41
2.7.2 Characteristics and technical analysis of plique-à-jour.....	53
<b>3 Methodology.....</b>	<b>58</b>

3.1 Creative practice as research .....	59
3.2 Reflective practice .....	62
3.3 Research methods .....	65
3.4 Four phases of research process.....	69
<b>4 Data collection and findings .....</b>	<b>75</b>
4.1 Material testing phase 1: proposing the MTG concept.....	75
4.1.1 The origin of Mind the Gap (MTG) series concept .....	76
4.1.2 The initial phase of experiment.....	78
4.2 Material testing phase 2: based on handmade method .....	83
4.2.1 The techniques of making metal spheres .....	83
4.2.1.1 Handmade method .....	83
4.2.1.2 Direct investment casting method .....	88
4.2.2 The handmade method of making scaffolding .....	91
4.2.2.1 Plaster mould as foundation .....	91
4.2.2.2 Soldering block as foundation .....	106
4.3 Material testing phase 3: embedding digital technology .....	109
4.3.1 Constructing the scaffolding: technology 1- selective laser melting.....	110
4.3.1.1 Connecting distance test.....	110
4.3.1.2 Exploration of basic form.....	118
4.3.2 Constructing the scaffolding: technology 2 - resistance welding.....	127
4.3.3 Comparison of the methods of making scaffolding .....	130
4.4 Material testing phase 4: discovering traditional making knowledge.....	135
4.4.1 Dismountable structure design for scaffolding .....	136
4.4.2 New structural designs of the enamelling work .....	139
4.4.3 Methods of removing scaffolding part.....	150
<b>5 Discussion and conclusion.....</b>	<b>157</b>
5.1 New visual language of enamelling work.....	157
5.2 Further exploration of enamelling work.....	165
5.3 Wheel of life: a circle of technique .....	172
5.4 MTG: a unity of radical and incremental innovation.....	176
5.5 Embracing failure .....	179
5.6 The model of innovating traditional craft.....	180

5.7 Summary of the research .....	187
5.8 Original Contribution .....	189
5.9 Areas for further research.....	191
5.10 Final remarks .....	193
<b>Glossary.....</b>	<b>195</b>
<b>List of references.....</b>	<b>198</b>
<b>Appendix 1: Material testing .....</b>	<b>216</b>
<b>Appendix 2: Paper published and symposium .....</b>	<b>258</b>
<b>Appendix 3: Art work award.....</b>	<b>261</b>
<b>Appendix 4: Viva exhibition .....</b>	<b>266</b>



# List of figures

<i>Figure 1. A plique-à-jour goblet (filigree soldering type), by the author, 2015.....</i>	<i>2</i>
<i>Figure 2. An expert of filigree craft who has worked in Fuliang Ma's private factory for more thirty years demonstrating the skill of shaping a filigree metal framework after soldering. ....</i>	<i>25</i>
<i>Figure 3. One of the six gold rings discovered at Koukليا, Cyprus, 1952.....</i>	<i>31</i>
<i>Figure 4. Reliquary, Limoges, France, dated about 1185 – 1195.....</i>	<i>32</i>
<i>Figure 5. An antique guilloche enamel ladies' case, the 3rd Jewellers' Artel (cooperative), St. Petersburg, between 1908 and 1917.....</i>	<i>33</i>
<i>Figure 6. Kiss of Peace, a piece of painted enamel work, Museum of Fine Arts, Limoges. ....</i>	<i>33</i>
<i>Figure 7. A silver-gilt filigree brisé fan with enamelled opera figures with locket, Guangdong Museum, 1796-1820.....</i>	<i>35</i>
<i>Figure 8. Hidden Hedgerows Beaker, by Fred Rich, 2017.....</i>	<i>37</i>
<i>Figure 9. Flared Beaker 1, by Jane Short. H: 9cm, W: 7cm.....</i>	<i>38</i>
<i>Figure 10. Crystalline (Brooch), by Barbara Seidenath, 2003.....</i>	<i>39</i>
<i>Figure 11. The Consumption Series: Ripe (wall work), by Jessica Calderwood, 2008.....</i>	<i>40</i>
<i>Figure 12. The “Mérode Cup”, Victoria and Albert Museum, D: 10cm, H: 17.5cm, circa 1400 – 1420.....</i>	<i>43</i>
<i>Figure 13. An antique plique-à-jour enamel brooch, by Charles Riffault, circa 1880.....</i>	<i>43</i>
<i>Figure 14. Dragonfly woman corsage ornament, by René Lalique, H: 23cm, W: 26.5cm, 1897-1898.....</i>	<i>44</i>
<i>Figure 15. Hair ornament, by Philippe Wolfers, H: 7.6cm, W: 7.6cm, 1905-1907.....</i>	<i>44</i>
<i>Figure 16. A set of four Russian gilded silver and plique-à-Jour enamel liqueur glasses, Ovchinnikov, Moscow, H: 7.9 cm, circa 1900.....</i>	<i>45</i>
<i>Figure 17. Antique Norwegian solid silver &amp; plique-à-jour enamel viking boat, H: 16.5cm, W: 26 x 13cm, circa 1890.....</i>	<i>46</i>
<i>Figure 18. A small plique-à-jour vase (shotai-jippo), Hattori Tadasaburo (attributed to), H: 9cm, circa 1905.....</i>	<i>47</i>
<i>Figure 19. Champagne Flute (left) and Wine Goblet (right), by Valeri Timofeev, Walters Art Museum, 1993.....</i>	<i>48</i>
<i>Figure 20. Koi Among the Lily pads (centrepiece), by Jean Wilkinson, 2020.....</i>	<i>49</i>
<i>Figure 21. Maple Aspen Oak, by Fay Rooke, 2013.....</i>	<i>50</i>
<i>Figure 22. Lace (plique-à-jour bowl), by Alexandra Raphael, 2019.....</i>	<i>51</i>
<i>Figure 23. A collection of goblets and vessels, by Amy Roper Lyons, circa 2015.....</i>	<i>52</i>
<i>Figure 24. Filigree framework before soldering (left) and after soldering (right), see the complete work at Figure 1, by the author, 2015.....</i>	<i>55</i>
<i>Figure 25. Matilija Poppy (brooch), Metal framework by piercing before applying enamels (left); a complete piece of plique-à-jour (right), by Tom Herman and Patsy Croft, 2019.....</i>	<i>55</i>
<i>Figure 26. Applying enamels in the metal framework (left); after melting the enamels</i>	

(right), by Amy Roper Lyons, 2015.....	56
Figure 27. The mica method (left) and metal sheet method (right).....	57
Figure 28. The methodology map of this study. ....	74
Figure 29. Radical innovation for traditional plique-à-jour: the process of the creative concept Mind the Gap (MTG) series.....	76
Figure 30. The “Mind the Gap” announcement is used across London’s tube network. 77	
Figure 31. Sketching and diary writing a method to record my explorations of form. ...	79
Figure 32. The making process and the results from the straight form structure made with a single row of spheres. ....	81
Figure 33. The making process and results of the circular structure.....	81
Figure 34. Metal scaffolding (left); after applying enamels for the 1st time (middle); after melting enamels for the 1st time (right). ....	82
Figure 35. Lace Sphere, by David Huycke, Dimensions: 26 cm x 26 cm, 2006.....	84
Figure 36. Using a tweezer with leather strip to hold the silver sphere for drilling hole.	87
Figure 37. The granulation process of making a piece of silver plate become a silver sphere: 1. silver sheet — 2. hemispherical sphere — 3. round shape sphere. ....	87
Figure 38. The CAD files of sphere: the first design of silver sphere (left), the second design of silver sphere (right). ....	90
Figure 39. The casting piece of the second design in brass (left); two pieces of silver spheres cut from the casting piece with attached pillars before CNC drilling (right). .....	90
Figure 40. CNC drilling process.....	90
Figure 41. Design sketch: diameter of the silver spheres and the distance between them (in mm) (left). Five hemispherical silver spheres are placed according to the design pattern (right). ....	93
Figure 42. The testing piece shows a clear crack at the joint. ....	94
Figure 43. The enamel part is sandy and has partially fallen off after the first melting. .	95
Figure 44. The gaps between the hemispherical silver spheres. ....	96
Figure 45. After first applying the enamel, the enamel slumped below the edge of the spheres. ....	96
Figure 46. The copper pillars produced copper oxide after high-temperature melting.	97
Figure 47. Plaster mould base presented a degree of cracking after the fifth melt. ....	97
Figure 48. The result of Experiment 2. ....	98
Figure 49. Construction of a square container (interior size: length: 64mm; width: 64mm; height: 19mm) by using the plastic modules for filling plaster slips. ....	101
Figure 50. Placing the metal pillars on a piece of polymer clay block.....	102
Figure 51. The bottom of the metal scaffolding in the plaster mould after removing the polymer clay block.....	102
Figure 52. The nineteen stainless steel pillars used in the experiment, made by hand- cutting and grinding methods.....	103
Figure 53. The metal scaffolding part is fixed in the plaster mould.....	103
Figure 54. Splitting and dissolution of the base plaster mould after adding water (left); fracture of the enamel part (right). ....	104
Figure 55. Plaster mould casting method-2 fabrication process: insert the metal pillar -	

<i>pour paste of plaster into the container - fill the container with paste of plaster - flip the metal scaffolding and put it into the container.</i>	105
<i>Figure 56. The production process of Experiment 12 (1. making holes in the soldering block - 2. assembling the scaffold - 3. applying and melting the enamel - 4. separating the enamel pieces from the scaffold).</i>	107
<i>Figure 57. The result of Experiment 10 (the enamel piece and stainless pillars).</i>	108
<i>Figure 58. The outcome of Experiment 12, L: 1.5cm, W: 1.5cm.</i>	108
<i>Figure 59. Top view (left), front view (right) of the test piece in Experiment 15.</i>	108
<i>Figure 60. The distance between spheres of Experiment 22.</i>	112
<i>Figure 61. CAD file for the test of the horizontal connecting distance.</i>	113
<i>Figure 62. Before cutting the support structure (left); after cutting the support structure (right).</i>	113
<i>Figure 63. First application of enamel (left); first melting of enamel (right).</i>	114
<i>Figure 64. The testing piece of the fourth melting.</i>	115
<i>Figure 65. CAD file of the scaffolding for Experiment 23.</i>	116
<i>Figure 66. The outcome of Experiment 11: one of the supporting pillars is attached to the enamel.</i>	117
<i>Figure 67. The testing piece for the Experiment 23.</i>	118
<i>Figure 68. Before applying the enamels, the spheres were placed on the metal scaffolding (left); after two firings, the silver spheres were connected (right).</i>	119
<i>Figure 69. The effect after the first application (left); the impact after the first melt (right).</i>	121
<i>Figure 70. CAD file for the rainbow bridge experiment and its parameter (left); eight silver spheres were placed on the arched bridge metal scaffolding (right).</i>	121
<i>Figure 71. The test piece after the first melt.</i>	123
<i>Figure 72. The finished enamel piece.</i>	123
<i>Figure 73. CAD file for the experiment and its parameters (left); the metal scaffolding was manufactured by SLM (right).</i>	124
<i>Figure 74. 15 silver spheres neatly arranged on the metal scaffolding.</i>	124
<i>Figure 75. The test piece after the fourth melt.</i>	125
<i>Figure 76. Two structures created by arranging silver spheres on a metal scaffold.</i>	126
<i>Figure 77. A scaffolding part created by resistance spot welding technology.</i>	129
<i>Figure 78. The copper plate formed copper oxide that contaminates the surface of the enamel part.</i>	130
<i>Figure 79. Soldering block method: Metal pillars on soldering block are movable when the test piece is a simple structure (Experiment 12).</i>	132
<i>Figure 80. Metal scaffolding applied resistance welding method (left) and metal scaffolding applied SLM technology (right).</i>	132
<i>Figure 81. The enamel piece created using three methods: soldering block method (left), resistance welding method (middle), SLM method (right).</i>	133
<i>Figure 82. Print area of the SLM printing device (left), titanium scaffold on circular stainless- steel base: the printable object size is limited to the diameter of stainless- steel base (80mm) (right).</i>	134
<i>Figure 83. A scaffolding part made by granulation and soldering technique in the 1st</i>	

<i>phase experiment (see Section 4.1.2)</i> .....	137
<i>Figure 84. Part of the old Victorian Belmont Works factory building covered by scaffolding, 2019.</i> .....	138
<i>Figure 85. The interior of the Church of Our Lady and the English Martyrs, 2019.</i> .....	139
<i>Figure 86. Design sketch of multi-row arch structure.</i> .....	140
<i>Figure 87. Silver spheres were arranged in an orderly manner in the metal scaffolding.</i> .....	141
<i>Figure 88. An intact enamel element with a four-row arch structure.</i> .....	141
<i>Figure 89. The sequence of applying the enamel: start applying and melting the enamel in the horizontal direction first, then moving to the vertical direction.</i> .....	142
<i>Figure 90. The effect after applying the enamel five times: the complex structure will increase the difficulty of applying the enamel.</i> .....	143
<i>Figure 91. The enamel element part of the multi-row arch structure in the scaffolding with a fixed structure.</i> .....	143
<i>Figure 92. Sketch of the early MTG cylinder structure.</i> .....	144
<i>Figure 93. The scaffold of the cylinder constructed with 27 columns (left) and 4 rows (right).</i> .....	145
<i>Figure 94. Cylindrical metal scaffolding (top view): the distances between the ends of each pair of pillars (the centres of each two spheres) is 4.0mm.</i> .....	145
<i>Figure 95. The first step in arranging the spheres: putting them in an orderly manner in the area with structural pillars facing upwards (Column 1 to Column 7).</i> .....	146
<i>Figure 96. Completed application of the enamels for the first time with the placed spheres.</i> .....	147
<i>Figure 97. 28 spheres in the first to seventh columns are connected by enamel after the first melting.</i> .....	147
<i>Figure 98. The effect after melting the enamel part from Column 1 to Column 13 (horizontal direction).</i> .....	148
<i>Figure 99. Place the silver spheres (left) and apply the enamel (right) on the 14-20 columns of the cylindrical scaffold (horizontal direction).</i> .....	149
<i>Figure 100. Position the cylindrical scaffold perpendicular to the worktable and then melt it in the kiln (vertical direction). Top view (before firing, left); Front view (after firing, right).</i> .....	149
<i>Figure 101. Two test pieces of plique-à-jour using the shotai jippo method, by the author, 2016.</i> .....	151
<i>Figure 102. A specific equipment designed for directing the flow of ferric chloride.</i> .....	152
<i>Figure 103. The copper part of the scaffold was etched off.</i> .....	152
<i>Figure 104. The cracking of the MTG cylinder in Experiment 56.</i> .....	153
<i>Figure 105. Copper oxide melted with enamels and attached to the surface of silver spheres.</i> .....	154
<i>Figure 106. Reactant covers the surface of the enamels and silver spheres.</i> .....	154
<i>Figure 107. The metal scaffold of Experiment 41 was constructed with fine silver (left); a new scaffolding part in Experiment 44 combines fine silver and copper (right).</i> .....	155
<i>Figure 108. The making process of Experiment 44: copper oxide formed on the copper axis without effecting the enamel part after melting (left); the outcome of Experiment</i>	

44: a completed enamel piece was removed smoothly from the scaffold after the acid etching process (right).....	155
Figure 109. The testing pieces of Experiment 12 after being inlayed (left), and being melted (right) in the first time.....	158
Figure 110. The model of hard diamond, which was photographed in the National History Museum in London, by the author, 2020. "In this model of diamond each carbon atom is strongly bonded to four others to make a compact rigid structure" (source from: The National History Museum, the UK).....	158
Figure 111. An effect of water droplets between two silver spheres.....	160
Figure 112. Local effect of Experiment 38 testing piece after the second melting (left); Experiment 38 testing piece shows the effect of an orderly arrangement of holes (right).....	161
Figure 113. The outcome of Experiment 41 presents a special effect with various colours. ....	161
Figure 114. A piece of I-PAJ series (left) and the production process (right), by the author, 2021.....	162
Figure 115. Plique-à-Jour Collar Bangle, by Hilary Finck.....	163
Figure 116. Lace Plique-à-Jour Bowl, by Alexandra Raphael, 2022.....	163
Figure 117. Detail of the testing piece in Experiment 41: Light shines from the back of the testing piece, revealing holes in various shapes and transparent enamel colours. ....	164
Figure 118. Seven-layer MTG cylinder.....	166
Figure 119. Evolution of the cylindrical scaffold: the first cylindrical scaffold (left), the scaffold from Experiment 57 (medium), and the scaffold from Experiment 58 (right). ....	166
Figure 120. Acid etching process for Experiment 58: only the copper ring at the upper and lower ends of the scaffold needs to be etched.....	167
Figure 121. The process of applying the enamel: filling the gaps between the gaps on the metal scaffold with the enamel "transparent light white".....	168
Figure 122. Lighted seven-layer MTG cylinder.....	168
Figure 123. Exploring the MTG series with scaffold.....	169
Figure 124. The angle of application of enamel should be adjusted to the scaffold structure.....	169
Figure 125. The multi-angle MTG with scaffold requires the use of a special stand to aid firing.....	170
Figure 126. MTG Crown: effect without light (left), effect with light (right).....	170
Figure 127. Filling the gaps between the metal spheres with different coloured enamels. ....	171
Figure 128. The opening of "MTG Crown" before being applied with enamels (left), after being applied with enamels (right).....	172
Figure 129. The circular development process of techniques for the MTG series.....	174
Figure 130. The process of innovating traditional plique-à-jour: radical innovation and incremental innovation.....	178
Figure 131. A model of innovating traditional craft., by the author.....	185

# List of tables

<i>Table 1. Testing of different distances between two spheres.....</i>	80
<i>Table 2. Testing of different distances between three spheres.....</i>	80
<i>Table 3. The single row structure (square and circle) of the MTG series represents a visual language of the model of hard diamond.....</i>	159

# 1 Introduction

This practice-based research focuses on an ancient and rare enamelling technique, plique-à-jour, which provides a miniature-stained glass window effect because light can pass through the transparent enamel without metal backing. This study aims to revitalise and innovate this traditional technique, which is becoming known by fewer and fewer people in the present digital age. This chapter first introduces the research context, then outlines the research field based on the theories related to craft and design. An overview of the history of enamel is provided and then an in-depth analysis of plique-à-jour is given, so as to identify the research gap. Next, the questions, research aims, and methods are further discussed. Finally, the thesis structure and contribution of this research are described.

## 1.1 Research context

This research takes forward my first study of plique-à-jour. I have been studying enamelling techniques since 2007. In the summer of 2015, I went to Hebei, China, to visit Fuliang Ma, a national intangible cultural heritage inheritor who specialises in filigree craft and Russian-style enamelling. In Ma's workshop, I first saw work made by plique-à-jour, which surprised me, because the plique-à-jour technique was like a secret and not widely known in China at the time. Many people had heard of the technique but not how to make it. Ma was one of the rare artisans then in China who knew how to make plique-à-jour pieces. After three months of studying in Ma's workshop, I basically mastered making methods of traditional plique-à-jour (Figure 1). From then on, I have been

continuing to learn about this craft, and I discovered that there is little information about the plique-à-jour in China, either in the relics of the National Museum or in modern creations. Even in my hometown Guangzhou, a region famous for producing enamelling works for export in the 18th and 19th centuries, the craft is not seen today. This led me to ask: why has this enamelling technique not spread in China? What is its history and current situation? What are some of the other methods to make plique-à-jour? How can this craft be passed on and innovated? It was with these questions in mind that I embarked on this research.



*Figure 1. A plique-à-jour goblet (filigree soldering type), by the author, 2015.*

### **Outline of the research field**

This is a study that seeks to revive and innovate the traditional enamelling craft, plique-à-jour. Before starting the practice, I undertook a lot of reading of the literature and image collection, which included the theory of the craft and design, and the history and the present day plique-à-jour. As an ancient craft, plique-à-jour is now in decline in the digital age. In order to renew and improve plique-à-jour, I have drawn inspiration from theories in the field of craft and design, which involves past understandings of craft, craft and making, craft and digital



technology, design and innovation, and traditional craft as resources for innovation. This knowledge provides a broader theoretical context for this research. Next, I learnt about the history of the art of enamelling and the four main enamelling techniques. The history and contemporary development of plique-à-jour, a process of enamelling without metal backing, was then further explored to provide a background of cultural and production knowledge on enamelling craft for this study. Finally, innovation in plique-à-jour is discussed within the theoretical context of craft and design to guide subsequent studio practice.

Through the analysis of past and current plique-à-jour works and processes, I identify that although some contemporary enamellers utilise digital technology when making plique-à-jour in an attempt to revolutionise the craft, their understanding of plique-à-jour still remains in the past. Firstly, these enamellers still regard enamel as a decorative material used to embellish metal frames. Secondly, their design and making are still limited by the “cell”. This “cell” refers to the cellular structure of plique-à-jour art, which is formed during the process of making plique-à-jour enamel work. Thirdly, due to this limitation, the action of applying enamel has always been to fill in or not to fill in the cells. Therefore, I believe that the “cell” is the crucial factor that restricts the breakthrough in traditional art plique-à-jour.

## **1.2 Research questions and aims**

Roberto Verganti, a proponent of the theory of design driven innovation, argues that true innovation is radical innovation that brings new meaning to products, rather than incremental innovation. When discussing the relationship between the inheritance of the apprenticeship system of traditional craftsmanship and

innovation, Lehmann (2012: 151) pointed out that even if some craftsmen/craftswomen know how to produce, they may not change tradition. It is only through deliberate departure that crafts can transcend the past and generate new knowledge. To implement Verganti's (2008) radical innovation in traditional plique-à-jour, deliberate departure (Lehmann, 2012) and creative destruction (Schumpeter, 1942) are required for the cells as these restrict the development of plique-à-jour. Thus, I propose the innovative idea of breaking the cell. After breaking the cell, which limits people's imagination, I further discovered that, firstly, enamel no longer plays a decorative role, but becomes a bonding agent. Secondly, when applying the enamel, enamellists fill in the gap instead of filling in the cell. The gap between two metal parts becomes the key focus for study. Inspired by the slogan of the London Underground, I named this original concept the Mind the Gap (MTG) series.

It should be noted that the use of enamel as a bonding agent is not new in enamel production. Even when making cloisonné, enamellers sometimes replace the complex process of soldering wire by melting the enamel to attach the wire to the surface of metallic substrate. However, in the numerous texts describing enamelling craft, there is no systematic study of the use of enamel as a bonding agent to metal parts for structural design. More importantly, enamellists used to fill in the cell, but the knowledge of the making behind filling in the gap and the insights it brought are not documented. Based on the findings of the literature review, image analysis and my own practical experience over the past 15 years, I identify the research gaps for focus in this study and hope to address the research gaps to achieve radical innovation in traditional craft plique-à-jour.

**Based on the issues identified above, three research questions (Q1, Q2, Q3) are put forward.**

**Q1:** How can enamel be used as a bonding agent for new structural design and exploration?

**Q2:** How can the physical properties of enamel (viscosity and contraction) and the design of scaffolding be used to create a unique visual language for the MTG series that extends the boundaries of plique-à-jour?

**Q3:** Can a systematic model of innovation in traditional craft be created based on an innovation study of the traditional enamelling technique plique-à-jour?

In this study, I address the issues raised by the research gaps from the perspective of the craft practitioner and researcher, and guide the practice of this research through the following **three research aims (A1, A2, A3)**.

**A1:** To innovate traditional plique-à-jour through its visual language and method of manufacture.

**A2:** To explore the practical significance and contemporary value of the traditional craft of plique-à-jour.

**A3:** To record and present an effective model of practice as a reference for future practitioners and researchers in the field of craft and design.

### 1.3 Methodology

As practice-based research, this study undertakes a series of studio practices to develop innovation in plique-à-jour. However, at the initial stage of the research, I was not clear how to generate new knowledge to innovate plique-à-jour. Therefore, I read relevant research methods and theories about art and design, referring to how other researchers in the field have conducted their research. From the information I obtained I could then select the most appropriate methodological theories and research methods for this study, including practice as research (Gray and Malins, 1995) and reflective practice (Schön, 1983).

Practice, which is at the core of practice-based research, can provide crucial evidence in research (Nelson, 2013). However, to continuously make new discoveries and knowledge from practice, it requires a person to become a reflective practitioner rather than an ordinary labourer. Theorist Donald Schön (1983) encouraged practitioners and researchers to constantly reflect on the results of their practice to better guide the next stage of practice. Through reflective practice, I was able to continue to find problems in a series of experiments which sought to improve the design and techniques in the creative practice of plique-à-jour. Based on the creative and reflective studio practice, this study develops the plique-à-jour innovation process through four phases: 1. Mind the Gap (MTG) series concept and initial experiments; 2. Experimental exploration based on manual production methods; 3. Pursuit of precision production combined with the application of digital technology; and 4. Exploring new shapes and rediscovering the value of traditional production knowledge. Both predetermined purposes by design and occasional results through practice form the four stages, which finally integrate all theories and practice into a systematic framework.

In this research, I learnt from Nelson's approach, an iterative process, in conjunction with my own research, to develop a methodological model for each stage: reading–designing-making-reflecting-analysing-documenting-writing. And the findings are obtained from documentation, collection, and analysis of data. This research emphasises the interweaving of practice and theory. The craft practices at each stage were not linearly developed, but were rather developed iteratively leading to a mutual relationship. The findings and reflections from each stage of studio practice are juxtaposed with relevant theories to yield valuable insights.

## **1.4 Thesis structure and contribution**

This thesis first presents a literature review, mainly covering the theory of craft and design (literature review part 1) and an overview of enamelling techniques and plique-à-jour (literature review part 2), as well as an identification of the research gap (see Chapter 2). This is followed by a chapter describing the research methodology and specific methods applied in this study (see Chapter 3). Chapter 4 demonstrates the validation of the innovative concept of the MTG series and the resulting series of experiments. These experiments consist of four practical phases throughout the research, responding to research question 1 and research aim 1. Based on the experimental data and production experiences in Chapter 4, Chapter 5 summarises the unique visual effects of the MTG series, further explores the MTG series, and constructs a model for designing and producing the MTG series, answering research questions 2 and 3 as well as research purposes 2 and 3. Finally, this research is summarised and recommendations are made for future research directions and fields.

After an examination of the literature and conducting extensive studio practice,

this study makes four important contributions to this research field. Firstly, a new visual language is explored: a porous language unique to the MTG series that extends the boundaries of the traditional plique-à-jour. Secondly, an effective and systematic method to the design and production of the MTG series is proposed, which can be used as a model to provide a reference for future designers and practitioners in the field of enamel. Third, a new perspective is put forward which makes use of the physical properties of enamel in the bond, flow, and contraction among metal pieces to create enamel art. And finally, based on this research, a framework of innovating traditional craft is proposed as a valuable approach for wider designers and craft practitioners in the future.

## **2 Literature review**

### **Part1: Craft practice and innovation**

This first part of the literature review contextually situates this research in a hybrid field of design, art, and craft practices. This review provides an overview of the fluctuating status of craft, and discusses the reasons that have led to the marginalised position of craft, promoting me to reconsider and understand the role of craft in contemporary practices. This review discusses the close relationship not only between craft and making, seeing craft works as a process of making for knowing, but also between craft and materials. With the development of the digital era, hybrid craft that combines digital technology and traditional craft becomes an important way of making works in the art and design field. Finally, this review further explores the mutual influence between craft and design to understand how design is an impetus for craft innovation and craft is a valuable resource for design, reinforcing the sustainability of craft in contemporary practices.

### **2.1 The marginalisation of craft**

#### **Difficult to define craft**

Traditional crafts have long been perceived as an opposing the flow of development in modern industry and technology. However, in recent years, the term craft has gained a higher level of attention and appreciation (Jefferies, 2011; Lambert, 2019; Zhang and Walker, 2019). Many scholars and critics in the art and design area have been trying to understand the nature of craft and

provide a satisfactory definition for this word. In his book "The Principles of Art", philosopher and historian R. G. Collingwood (1938: 15) pointed out that craft has the "power to produce a preconceived result by means of consciously controlled and directed action." Furniture designer and maker David Pye referred to craftsmanship as a kind of "better sort" of workmanship and "means simply workmanship using any kind of technique or apparatus, in which the quality of the result is not predetermined, but depends on the judgment, dexterity and care which the maker exercises as he works" (1968: 20). For Glenn Adamson (2007: 1), crafts are the "specific processes carried out in specific materials." However, providing an ideal and precise definition of craft seems difficult due to its consistently developing state (Metcalf, 2002). Greenhalgh (1997: ix) views craft as "a plurality of meanings" and a word with "the epitome of confusion". Dormer (1997: 5) expresses a similar view that the "general definition of 'craft', 'technology' or 'design' tend to be pretty hopeless, in the same way that definitions of art tend to be". In contrast to the opinion of Adamson, Shiner (2012: 233) prefers to embed the notion of process into different practices in that he believes the viewpoint of Adamson is "so generic" by defining craft "solely as a process of making." In a new era, with the development of digital technology and hybrid mode of making, I believe that the definition of this contested word will continue to develop.

### **The lower status of craft**

Although there are various perspectives that can be adopted to understand the meaning of craft, this will continue to be a controversial topic as the boundaries between craft, art, and design become less clear-cut than before. There is one thing for sure is the long-term marginal state of craft in art and design discipline (Dormer, 1997; Greenhalgh, 1997; Adamson, 2007; Shiner, 2012), as David Pye states craft encounters "all the strange shibboleths and prejudices about it which are acrimoniously maintained" (1968: 20). Adamson even uses



“systematic underestimation” to describe the current state of craft. Because of its functional characteristic and separation from art and design, craft has often been labelled the “minor arts”, “lesser arts”, “applied arts” and “decorative arts” (Metcalf, 2002; Risatti, 2007; Nimkulrat, 2012; Golsteijn, 2014; KjØrup, 2018). Dormer (1997: 19) states that the separation of ‘having ideas’ from ‘making objects’ has led to prejudices that lower the view of craft but raise that of art.

### **Craft as decorative art**

Craft has long been understood as decorative art. Indeed, in the essay “The history of craft”, art historian Greenhalgh (1997: 25) argues that decorative art, vernacular and politics of work are the three significant elements of craft and he emphasises that decorative art is “a feature of all civilisations”. Similarly, the statement that “craft, from our retrospective view, also meant the decorative arts” from jeweller and writer Bruce Metcalf (2002: 14) further affirms the long-held understanding of craft. However, because of this close relationship, craft becomes a lesser form of art. In the hierarchical system of fine art, decorative art is usually viewed as a kind of disenfranchised art. In his influential book “The Claims of Decorative Art”, Britain’s artist Walter Crane (1892: 109), expressed the same view as William Morris who claimed that we have “fine art and the arts not fine” as the division between “beauty and use”. Many art critics have contended that decorative art with use value or functional objectives should belong to “the art not fine” (Greenhalgh, 1997). In other words, this understanding that viewing craft as decorative art becomes one of the reasons that craft has negative connotations. Can we take another perspective from which to view craft and bring it back to a proper state? How can craft practice be understood and the role of material utilised in craft-based design. Examining this question becomes one of the significant aspects of this research.

### **Craft is not intellectual**

Another significant reason for the lower status of craft is that it has been understood as a process of making rather than intellectual thinking. For Arts and Crafts thinkers, cognitive and manual activities were considered to be integral as a whole. However, after 1918, a new classification system was established by using intellectual means (Greenhalgh, 1996). In his essay on the history of craft, Greenhalgh (1997: 41) reports that “aestheticians and practitioners associated with the fine arts steadily legitimised the idea that the two were two wholly separate realms”, and “the majority of recent thinkers have considered art to be a state of mind, an outlook, a way of seeing things rather than a way of doing things”. Dormer (1996: 3) expressed a similar viewpoint that within the past hierarchical classification system, people believed that “it is your ability to choose and select, not your ability to make, that marks you as an artist, as a connoisseur [...] Craft just seemed so tedious because it was almost inelegant in its demands”. Indeed, for craft, making is the core value: as Greenhalgh (1996: 43) emphasised, “craft stood exactly for the making of things”. However, the value of making has long been undermined, leading to today’s lower position of craft. This thesis, thus, explores the importance of making in the process of craft innovation in order to reveal the value of craft. Through conducting experiments to expand the boundaries of traditional plique-à-jour, this study discusses the role and contribution of making in this creative process. It is not only a way of transforming imaginary design thinking into practical work, but also an approach to achieve a new understanding of similar activities.

### **Reconsidering the value of craft**

Before we reconsider the value of craft, it is important to identify the position of craft in the contemporary art and design field. However, as already mentioned, it is impossible to arrive at a precise definition of craft (Dormer, 1997: 5). Approaches to identifying the characteristics of the word craft have become a

significant question for some in academia. Although craft plays an important role in the visual arts, in fact, most people have no idea of what craft exactly it means. For most artists and designers, craft is pastoral and amateur. For Adamson (2007), craft has the role of being supplemental to fine art. Because of the long-term downplaying by historians and art critics, especially in the twentieth century, craft has no consistent meaning or stable significance, leading it to retain negative connotations which include lack of clarity and confidence. Greenhalgh (1996: 21) believed that the fundamental reason for the unstable condition of craft comes from the fact that “it is being used to collectively describe genres and ideas that formerly were not grouped together and that grew from quite separate circumstances”. Therefore, establishing a clear identity for craft in contemporary visual art and forming a cohesive lobby are crucial for the future of this term. As Risatti (2007) illustrates “craft must articulate a role for itself in contemporary society, otherwise it will be absorbed by fine art or design, and its singular approach to understanding the world will be lost”. Indeed, the role and true value of craft have not been recognised for a long term (Woolley and Huddleston, 2016).

For Adamson (2007: 4), craft is a process of conducting activities around material experience. In the process of handling material, the practitioner achieves not only a new work but also a form of knowledge that is tacit (Nimkulrat, 2012: 3). We can see the term tacit knowledge is mentioned in many discussions and research about craft. However, the value of this kind of knowledge in craft has not been well acknowledged by artists and designers in the past. In fact, tacit knowledge that arises from the process of craft practice, is fundamental to craft-based design and innovation. Dormer (1997: 147) believed that “craft relies on tacit knowledge” which is different from that gained from technology since knowledge in craft is distributed “through people alone” rather than “among systems of people and hardware”. Shillito (2013) argues

that tacit knowledge achieved from craft practice also brings about the serendipity that inspires the researcher and practitioner in their works. Thus, this thesis seeks to identify the tacit knowledge achieved from the making process of traditional plique-à-jour, seeing it as the “singular approach” of craft itself and utilising craft as a valuable resource for pushing the boundaries of plique-à-jour and further benefiting the creation of the Mind the Gap series.

## **2.2 Craft and making**

Making is one of the earliest activities undertaken by humankind. Evidence of its appearance is found even earlier than written language (Lambert, 2019). This is supported by Friedman (2000: 5) who reports that “the practice of design-making things with a useful goal in mind-actually predates the human race. [...] Human beings were designing well before we began to walk upright or attend conferences”. Making is also a universal way of producing objects in people’s lives. Almost anyone can make and express their different opinions towards making. To some, making is the basis for the creation of an artifact. To others, making allows them to participate in the process of social development and define their personal identity (Charny, 2011). Some people may see making as an enjoyable process to memorise the past. On the other hand, some may not understand making as being fun but rather as an activity with dangers, for example, making in farming or factories may expose the maker to harm to their health and body (Miller, 2011).

### **Resurgence of making**

Although making has not been valued by governments or educational institutions due to the prevalence of mass manufacturing, in recent years, the word *making* has gained a higher degree of recognition (Charny, 2011).

Gauntlett (2011: 11) believes that there is a growing engagement with making in this new era. This idea has been supported by the increasing usage of words like *craft* and *artisan* and new emerging terms like the *maker movement* (Hatch, 2012; Anderson, 2012) and *makerspaces* (Anderson, 2011; Burke, 2014). Two recent exhibitions, the *Power of Making* were held in collaboration between the Victoria and Albert Museum and Crafts Council in 2011 and the 2014 *In the Making* exhibition at the Design Museum in London provided an overview of the current debate about making (Charny, 2011; Lambert, 2019). With the development of the “maker movement” (Jacob, 2015), making has become one of the central topics in craft and design. Educationalist and author Ian Lambert, in his Ph.D. thesis, (2019) states that although the contemporary maker movement is not the first movement against industrial mass manufacturing, a view supported by the manifesto of William Morris who rejected the division of labour in the 19<sup>th</sup> century (Pye, 1968), this contemporary movement still plays a significant role in the resurgence of “humanised making”. For Lambert, the contemporary maker movement is different from the Arts and Crafts movement, and points out that the “inaccessibly high cost” and “lengthy processes” of products in Arts and Crafts, in fact, contradicted Morris’s socialist beliefs (Gauntlett, 2011: 36; Lambert, 2019: 34-35). Anthropologist Daniel Miller (2011: 17) presents a similar view that craft should be valued in everyday life. We should “encourage more democratised participation” rather than solely “served elites and rulers”.

### **Knowing by making**

The concept that making is a method to generate new knowledge has been widely accepted (Ratto, 2016: 28). Schön (1983: 42) claims that making is a time-based process of “knowing-in-action”. However, through the fast development of industrial manufacturing, fewer people know the making method or principles behind the products they use, leading to an increasing

distance between the user and the maker as knowledge and understanding are diminished. As Charny (2011: 7) points out this is “one of the unfortunate legacies of the Industrial Revolution that has shaped the world we live in”. Yet despite all the value within the process of making, the way of achieving and illuminating knowledge through making is still marginal. While Friedman (2000) claims the importance of turning tacit knowledge into an explicit form, Lambert (2019), provides an alternative perspective that tacit knowledge can be more “effective” without an explicit mode for maker-researchers (Ingold, 2013; Polanyi, 1966) and highly values improvisation in the process of generating knowledge through making.

### **Making and thinking**

The separated relationship between conceptual theory and physical practice has been contested territory with a long history. Gauntlett (2011) argued that thinking and making are two different aspects within the same process. At the end of his essay “Making as Knowing: Epistemology and technique in craft” Lehmann (2012: 150) also claims that there are distinctions between *techne* (practice) and *episteme* (theory), however, he concludes that the conflation of theory and practice can be productive through turning “the process of making into a concept in its own right”. In the craft discipline, educationalist and craft practitioner Nithikul Nimkulrat (2012: 2) believes that “thinking and knowing are inseparable from making in any craft or designerly practices” which echoes the opinion of Adamson (2007: 7) who states that craft is “a way of thinking through practices of all kinds”. In his book “A Theory of Craft”, Risatti states that Aristotle grouped knowledge into three categories, *theoria*, *praxis*, and *poiesis*. For Risatti, craftsmanship is a kind of poiesis - “knowledge involved in the making” (2007: 163). Seeing the division between thinking (mental conception) and making (physical execution) as a manner of “Cartesian dualism”, he strongly advocates and believes that the combining of conception and execution will

advance a truly dialogical process between thinking and making which is at “the heart of [the] creative act of craftsmanship” (2007: 169). In this sense, craft or craftsmanship is an activity that combines abstract conception and physical execution. Within the process of craft practice, theory and practice mutually support each other rather than retain a separated status. Both thinking and making are fundamental for generating new knowledge (Charny, 2011).

### **2.3 Hybrid craft practice**

The word making today is widely used in general parlances, such as ‘making friends’, ‘making movies’, and so on. Traditionally, in craft and design, to many people the word “making” either has taken on a broader or less precise meaning, simply being equated with craft or craftsmanship, because of its close relation with using the hands. People, therefore, usually regard craft practice as a process of being entirely handmade. However, understanding of making has changed with the development of industrial mass manufacture. While Lambert (2019) sees craft as “a form of making”, Charny (2011) claims that 3D printing, along with other handmade activities, are also a type of making. Pye (1986: 23) also points out a similar view that the handmade should not be over romanticised since the quality of some products such as nuts and bolts which are made by machine, cannot be improved upon. With the increasing combination of craft and digital technology, a hybrid mode of practice has emerged and generated new types of makers and audiences. These “hybrid design practices” (Bernabei and Power, 2018: 121; Taylor and Townsend, 2014: 163-166; Jonsson, 2007: 240-248) and “hybrid artisans” (Zoran et al, 2014) are creating a new interactive paradigm “where human and machine work in synergy” (Zoran et al, 2014: 15). Whatever one may believe, this new mode of making is becoming the most general and influential approach in the craft and

design discipline, and promotes a truly dialogical process taking place between the human hand and robot arm through working with materials. Instead of merely emphasising one perspective, as Pye (1973: 95) notes that “there is not and never has been (in most trades) any possibility of working either ‘by hand’ or ‘by machine’”, this thesis sees the handmade and digital fabrication from a holistic perspective, regarding the hybrid mode of making as a fundamental approach to be employed in the creative process of craft-based design and practice.

## **2.4 Craft innovation and sustainability**

The emergence of hybrid craft, in fact, is the result of the fusion of craft and design, and physical making and digital manufacturing. Today, design is widely applied as a driving force for innovation in product design and business management. The innovative development of traditional crafts also requires design. Simultaneously, in the field of design, the value of traditional craft is increasingly valued as a resource for inspiring design to be reused. It is necessary for us to both pass on and innovate traditional crafts in order to achieve its own sustainable development in the future.

### **2.4.1 Design as an impetus for innovation**

Innovation is currently regarded as a significant power to facilitate the development of society. Different fields such as company management and advanced technology require innovation to remain competitive. In previous decades, there has been extensive literature and studies written that have focused on innovation. Theorist Klaus Krippendorff (1989: 9) believes that to



make something new, people call for innovation. For Roberto Verganti (2008: 441), innovation refers to “a significant reinterpretation of meanings”. In his paper, he further provides a description of the difference between “incremental innovation” and “radical innovation” (2014). Among those discussions about how to achieve innovation, design seems to be the most critical element, gaining great attention in the management and the art and design disciplines (Kristiansen and Gausdal, 2018).

However, providing a satisfactory definition for the word design seems difficult (Dormer, 1997). Many researchers and practitioners not only in design research but also the craft area have dedicated themselves to providing a proper interpretation of this term from their own perspectives. Some argue that design is the activity of making sense of things, implying that the outcome of design should be meaningful and understandable (Krippendorff, 1989: 9). Design as a process of creating meaning is a significant epistemological insight, which forms the basis of contemporary design research and has been the subject of extensive study and exploration. Furthermore, from a practical perspective, design process is also a problem-solving activity with a clear plan which incorporates preparatory study (Greenhalgh, 1997). Interestingly, in much of the literature and study of craft theory, in order to distinguish craft from design and identify the position of craft in contemporary art and design, scholars used to view the certainty and predictable property as the only characteristic of design, highlighting the risk and freedom as the core values of craft (Pye, 1968; Dormer, 1997). However, design not only serves as a method of solving problems with logical planning and thinking, but is also an imaginative activity for creation and invention (Risatti, 2007; Glynn, 1985). As design theorist Cross (2001: 3) points out, “modern, industrialised design-as distinct from pre-industrial, craft-oriented design based on scientific knowledge but utilising a mix of both intuitive and non-intuitive design methods”. This echoes the opinion of

Lawson (2005) who argues that design is an activity that involves “precise and vague ideas,” and requires “both imaginative thought and mechanical calculation” when he describes the difference between engineer design and fashion design. In this sense, design and craft share some common characteristics.

As a contested term, design has increasingly gained attention in past decades due to its creative property. During this time, new terms such as design-inspired innovation (Utterback et al., 2006) and design-driven innovation (Verganti, 2009) have emerged (Kristiansen and Gausdal, 2018). In these studies, design is usually understood as a catalyst for creating new ideas and innovation. The influential scholar in leadership and innovation area, professor Roberto Verganti proposed the design-driven innovation (DDI) theory and emphasised the importance of radical innovation in his works (2003; 2008; 2011; 2014). In the paper “Design, Meaning, and Radical Innovation: A Metamodel and a Research Agenda”, Verganti (2008: 441-442) points out that radical innovation “does not refer to fashionable or stylish products but rather to products that may contribute to the definition of new aesthetic standards” which can be considered as a kind of reconstructionist (Kim and Mauborgne, 2005). Such new standards could possibly become icons to change sociocultural models in the future.

The most essential element of radical innovation is the meaning of a product, where the meaning of a product is put forward by people. There are many reasons for people to choose a product, which are usually not only for practical utility but also psychological satisfaction (Verganti, 2011). The notion that “every product has a meaning” has been widely accepted. As already mentioned, a design product should be meaningful and understandable. Krippendorff (1989: 12) argues that meaning is “a coherent unity” constructed by the object and its context. To understand a product, people used to place an object into a certain

context or environment irrespective of whether it is authentic or imagined. Based on the definition of design as “making senses of (things)” proposed by Krippendorff (1989), Verganti further argues that the core value of DDI is radical innovation and this provides a reinterpretation of a product’s meaning (Norman and Verganti, 2014). In other words, the radical innovation of an object refers to creating a new meaning of it. In this thesis, craft innovation is at the core of the study. According to Verganti’s theory of innovation, to achieve radical innovation in traditional plique-à-jour, it is important to identify its context.

Traditional plique-à-jour was born to achieve the appreciation of nobility and dates back to the late 14<sup>th</sup> century (Beach, 1997). In his “Treatise on Goldsmithing”, Benvenuto Cellini describes a story in detail about King Francis I in Paris and a cup of plique-à-jour (Speel, 1992), demonstrating the original context of this ancient craft. How to reinterpret and radically innovate traditional plique-à-jour in the context of contemporary art and design is the key focus of this research.

## **2.4.2 Craft as resources for innovation**

### **Innovation through Tradition (ITT)**

Methods that embed past knowledge and the wisdom of traditional craft plique-à-jour have been delivered for many generations. In order to fundamentally reveal such an old and rare technique, it is vital to understand the meaning of “tradition” and realise how people view it today. Tradition refers to anything that is passed down from the past to today, including material objects, beliefs, images, practices and institutions (Shils, 1981: 12). Tradition incorporates knowledge and wisdom from our ancestors and is still a valuable resource to solve contemporary issues (Dobel, 2001). However, in recent decades, according to conventional thinking about tradition, tradition has usually been

regarded as a major factor that causes conservatism, reduces the capability of innovation, and hinders social development (Leonard-Barton, 1992; Sorensen and Stuart, 2000; Adner and Snow, 2010). Leonard-Barton (1992: 112), a scholar in the field of knowledge management and innovation believes that “institutionalised capabilities” may bring about “incumbent inertia” (Lieberman and Montgomery, 1988).

Nevertheless tradition has two seemingly contradictory aspects. It has the “irreducible tacit element” that enables continuity and a capability that allows adaptation to the changing environment (Hibbert and Huxham, 2011). Traditions may even be created over a very short time (Giddens, 2002; Thompson, 1990). In his book “The Invention of Tradition”, historian Eric Hobsbawm (1983: 1) uses the term “invented tradition” and states that “traditions which appear or claim to be old are often recent in origin”. Rather than keep “recency bias”, in recent years, many researchers and practitioners have started to reconsider the value of tradition in social development and innovation. In the innovation and management areas, tradition is not only regarded as a positive element in promoting product innovation (Wang and Wallendorf, 2006), but also as a unique resource for enhancing the competitiveness of a firm (Messeni Petruzzelli and Albino, 2012; Teece, 2006; Di Minin and Faems, 2013). Based on their prior research on innovation, De Massis et al. (2015) have proposed the concept of “innovation through tradition” (ITT) which is the strategy of utilising traditional resources for firm and business innovation. In their study, De Massis et al. (2015) further describes how six long-lasting family firms continuously innovate their products and achieve success by using and maintaining their own traditional resources. Thus, instead of seeing tradition as an obstacle to innovation, today we should embrace and explore the potential of tradition itself.

### **ITT and craft-based design**

Likewise, in the art and design area, craftsmanship as a kind of traditional form of manufacturing is increasingly recognised as an important resource for design. Catharine Rossi (2015: 71) who was the first to propose the concept of “craft-based strategy”, points out that this approach originates to a great extent from the 1970 Italian Radical Design movement, which challenged “the hegemony of an industrial design ethos”. Craft-based design as Holmquist et al. (2019) notes is a design approach inspired by craft rather than industrial mass-production. Craft-based design strategy encourages designers to gain inspiration from previous making experience and knowledge, creating new meaning for product design. From this perspective, craft-based design is related to the context of ITT (Holmquist et al., 2019). In this research, craft-based design is employed as an important strategy for studying and innovating traditional plique-à-jour. In many previous craft-based design programs, what craft designers mainly value is the features of craft such as spontaneity or improvisation for design, providing new potential for the conventional industrial design method. Yet while the valuable potential of craft for design is well known, it has not received sufficient in-depth critical attention, particularly in terms of innovation of craft itself. For this study, plique-à-jour as a traditional craft contains much precious knowledge both with respect to culture and construction, which has not been fully explored. Consequently, I not only view plique-à-jour merely as an essential innovation resource for design, but also consider the process of innovation itself, in order to achieve the sustainable development of plique-à-jour in the digital era today.

### **Apprenticeship as a way of transmitting craft knowledge**

Traditionally, the acquisition of traditional craft knowledge has been based on internal rules and guidelines. Traditional craft provides an apprenticeship in which an apprentice under the stewardship of a master learns professional

skills or a trade over a period of time (Gorse et al., 2020: 424). Traditional apprenticeship is a significant and effective mode of passing on knowledge of various crafts (Gamble, 2001; Stein, 2019). In early modern England, trainees were expected to spend seven years completing their practice, a time frame that was shorter elsewhere in Europe (Wallis, 2008: 6). An apprenticeship is also a process of initiation, as Clark and Winch (2004: 2) describe, involves “observation, imitation and gradually growing participation”. This echoes Wallis’s opinion of apprenticeship and craft practice that tacit knowledge cannot be achieved merely by “didactic instruction” and thus the apprentice should immerse themselves and spend a long time in practice (Wallis, 2008: 21). More importantly, in the traditional apprentice-master relationship, trainees need to follow the restrictive rules set by their masters, focusing on a specific kind of skill, leaving no room to make any changes (Clarke and Winch, 2004; Stein, 2019). Taking my own experience of studying traditional plique-à-jour as an example, in 2015 I studied this old enamelling craft from Master Fuliang Ma who is an inheritor of traditional filigree and the enamel technique of China. During this period of study, Ma asked me to follow instructions step by step to make a traditional plique-à-jour goblet, from making plaster mould to creating patterns with filigree wire, to soldering the metal framework and applying enamels and polishing (Figure 2). At the end of my period of learning, he said to me that in the future certain technical key points could only be learned by my own experience. After three months of studying and practicing, I understood the basic process of making traditional plique-à-jour. Strictly speaking, although this short period of learning cannot be considered a traditional apprenticeship, it allowed me to gain an appreciation of this conventional mode of instruction in the craft area. Indeed, the traditional apprenticeship enables the continuity of crafts. Nevertheless, this mode of instruction may bring about “skill boundaries” due to its restricted form (Gamble, 2001: 185). Such boundaries, to some extent, restrict the development of various skills and technologies, leading to its

inappropriateness in contemporary modes of manufacturing (Guile and Young, 1999). Therefore, approaches to break through the boundaries produced by traditional apprenticeships and develop traditional craft creatively are critical issues for this research.



*Figure 2. An expert of filigree craft who has worked in Fuliang Ma's private factory for more thirty years demonstrating the skill of shaping a filigree metal framework after soldering.*

### **Innovation of craft itself**

As previously described, knowledge of crafts is often handed down through long-established channels and craftsmen continuing to make artifacts by traditional manufacturing approaches learned from their ancestors (Lehmann, 2012). However, the fact that people possess a skill does not mean that they are able to change the original meaning and create an entirely new technique. As Lehmann states, “they might know how to produce an effective, economical, or detailed result. But this does not mean that they can change completely, reverse, or deconstruct their techne in such a way as to challenge established thinking about this craft”. He further emphasises that traditional making necessarily requires “deliberate departure” or “fundamental ontological rupture” in order to break through the inherent interpretation of a craft and promote

“structural innovation” (Lehmann, 2012: 151). In past decades, the concept of “creative destruction” proposed by the famous economist Joseph Schumpeter has been widely used in many product innovation programs (Schumpeter, 1942: 83). Leonard-Barton (1992) suggests that this “creative destruction” is available for all innovation projects. The new product development researcher Dr. Veryzer (1998: 306) in his work further describes the significance of “dramatic departures from existent products” for product design in order to create “discontinuous innovation”, echoing the opinion of Ulrich Lehmann. For hundreds of years, cultural meaning and making methods of traditional plique-à-jour have not changed and the innovation method for this old craft remains unclear. It is thus of great necessity to embed “deliberate departure” within the process of innovating plique-à-jour and working as an outsider to challenge the past meaning and function of this craft including its materials and technical applications (Lehmann, 2012).

In the context of contemporary globalisation, traditional plique-à-jour as with many other intangible cultural heritages are under threat, making the sustainable development of traditional craft a popular topic. Various approaches have been proposed for the safeguarding of cultural heritages that have focused on the product, production, the market, and education (Tung, 2021). In this research, sustainability of craft specifically refers to the preserving and development of the traditional making knowledge in the process of craft innovation. The United Nations Educational, Scientific and Cultural Organisation (UNESCO), emphasises the importance of sustainable development of cultural heritages and believes that they are constantly evolving in response to their changing environments.

Based on the guidelines of UNESCO, I argue that tradition and innovation are not opposed to each other. In this research, we are not presenting a choice



between traditional training methods and radical innovation in plique-à-jour, rather both factors are seen as essential to its sustainability. In fact, if I had not had the precious learning opportunity with master Fuliang Ma, I would be unable to realise traditional plique-à-jour, let alone establish a foundation for innovating it. If I did not have a comprehensive and deep understanding of the prior knowledge of plique-à-jour, I may not be able to identify its technical limitations which create the potential for innovation in this research. Therefore, the process of innovation in traditional craft itself should first be based on a deep understanding of the skill through traditional and restrictive training, and then applying different methods of manufacturing in order to provide new meaning to the craft. In this way, innovation of a traditional craft is a process that combines inheriting and recreating, in which traditional making knowledge is passed down and new knowledge is created. This echoes the manifesto of UNESCO (2020) with its aim of safeguarding heritage to ensure “its viability, its continuous recreation and its transmission”.

## **2 Literature review**

### **Part 2: Enamelling technique plique-à-jour**

Enamel has been used as a decorative material for over a thousand years on a variety of materials, including ceramics, glass and metal. Throughout the long history of enamel, enamellists from different countries and regions of the world have explored different enamelling techniques through their diligent hands and ingenuity to create diverse and dazzling enamel works. This study focuses on one of the old and rare metal-based enamel craft: plique-à-jour. This chapter begins with an overview of the material properties of enamel and the history of the metal enamel craft. Then, the technical characteristics of the four main metal-based enamel crafts (cloisonné, champlevé, basse-taille, painted enamel) are described and analysed. Next, the history and current development of plique-à-jour is highlighted, and a detailed analysis of the techniques and methods used in the past to produce plique-à-jour is provided. These insights will reveal the research gaps that will be the focus of this study.

### **2.5 Enamel and its history**

Before discussing traditional enamel crafts, it is important to consider what enamel is and how it has been developed. In the following section, firstly, the material properties of enamel and the process of producing enamel are described. Secondly, a historical overview of enamel and the development of the craft in different countries and regions is provided. Finally, how enamel has been understood as a material in the past will be discussed.

## **What is enamel?**

Enamel, in the craft and design area means “vitreous enamel”, also known as “porcelain enamel”. Vitreous comes from the Latin vitreum, meaning glass, while enamel is from the Old Germanic smelzan, meaning smelting (it is also said that the word enamel comes from the Frankish esmail, or from the Latin smaltum). According to The British Standards Institution publication, vitreous enamel and porcelain enamel refer to “substantially vitreous, or glassy inorganic silica coating bonded to metallic substrate by fusion at minimum temperature of 480°C” (2017: 24). Enamelling is a craft in which glass materials (borates or silicate compounds) are fused to a substrate, including metal, glass, and ceramics. Depending on the substrate in which the enamel is attached, there are different names for it. For ceramics, it is known as overglaze enamelling, for glass it is called enamelled glass, and for metal, it is metal-based enamel. After the 18th century, an industrial enamelling technique was developed in Europe based on casting iron or steel, which was widely used in cooking, dining, bathroom and other products. Thus, enamelling is in fact a laminated composite craft of vitreous enamel and another material forming the substrate. This study focuses on metal-based enamel.

Enamel is inextricably linked with ceramics and glass. It is often the case that the three terms, enamel, glaze, and glass are used interchangeably. For example, Bachrach (2006: 8) describes that, “the glass glaze material that is fused to the metal is enamel”. Gnesin (2016: 755) has argued that ceramic glazing technique and enamelling technique both belong to “inorganic vitreous coatings on ceramics and metals”. Carpenter (1982: 65) begins his article *Glass on Metal* with the statement that “Enamel is glass formulated to possess certain specific properties”. Gnesin (2016) further analysed the chemical composition of enamels on ancient European jewellery from the past, revealing that silica

SiO<sub>2</sub> is the common base for enamels on traditional European precious metal jewellery. And silicate was thought to be the main component of glass in the past. Furthermore, Carpenter (1982) notes that 99% of glass throughout history has contained silicate, while Shelby (2005: 3) expressed a similar view that the glasses used by mankind throughout most of our history have been based on silica. However, he also points out that not all glass contains silicate. In summary, this study endorses and applies the view that enamel is a kind of glass.

The production of enamelling materials is a complex process. Different minerals such as silica, borax, soda ash, calcium carbonate, etc. are weighed and proportioned according to formulas for making different enamels, and then they are mixed and poured into a preheated clay crucible. After a continuous period of high temperatures of 1000-1400°C, the minerals melt and form a viscous liquid substance. The liquid enamel in the crucible is then poured onto a thick iron plate, which forms a lump after cooling, or forms a frit by being directly channelled into a sink to explode. The enamel glass made from the above minerals is a colourless transparent enamel (Carpenter, 2006). To produce enamel of different colours, different metal oxides should be added. For example, cobalt produces blue, antimony produces yellow, copper produces turquoise blue and manganese produces purple (Cunynghame, 2012). In addition to colour, the transparency of enamel is also a significant factor in its visual effect, which is determined by the amount of opacifiers (Tin(IV) oxide, Titanium dioxide, and Sodium aluminium hexafluoride) added. These insoluble crystals reduce the transparency of enamels (Gnesin, 2016: 754; Carpenter, 2006: 18). The transparency of enamels was a key consideration in the selection of enamels for experiments in this study, since it is closely related to the enamel craft *plique-à-jour*, which is the focus of this study.

## Overview of the history of enamel craft

Enamel craft has been a traditional craft and art for thousands of years. The earliest known enamelled metal pieces date back to the 13th century B.C. (Carpenter, 1982). In 1952, British archaeologists discovered six gold rings decorated with enamel in a tomb during archaeological excavations in the small village of Kouklia in southwestern Cyprus (Figure 3). They are dated back to 13th century B.C., and are the earliest enamel works with cloisonné technique. The enamel on these rings appears to be corroded and has lost its lustrous appearance. These rings are applied with cloisonné which is one of the oldest enamelling techniques, and was used extensively and creatively on jewellery and objects by Byzantine craftsmen in the 11th century B.C. These objects were mainly used to show different figures and images, and the subjects they represented were mostly derived from biblical stories and Christian portraits.



*Figure 3. One of the six gold rings discovered at Kouklia, Cyprus, 1952.*

With the development of cloisonné, another important technique in enamel craft appeared, champlevé, which dates back as far as Hellenistic Egypt and the Middle East in the 3rd century B.C. The technique was further developed during the Byzantine period and subsequently spread to Georgia and Pre-Mongolian Rus (Gnesin, 2016). By the late 12th and early 13th centuries, champlevé had spread widely in Europe and gradually developed into the dominant technique

in the art of enamelling in Limoges, another major European enamelling town. During the 12th and 14th centuries, local workshops in Limoges used *champlevé*, partly in conjunction with the *cloisonné* technique, to produce commercial enamelled products, including incense burners, sceptres, reliquaries, jewellery boxes, and book covers (Figure 4).



*Figure 4. Reliquary, Limoges, France, dated about 1185 – 1195.*

Basse Taille is a new technique based on the technique of *champlevé*, a technique that applies transparent enamel to metallic substrate with engraved texture, which was introduced in Europe as early as the 14th century. Basse Taille was seen as a new development in the transition from *champlevé* to painted enamel (Shi, 2012: 16), and it developed rapidly in the late 19th century. As industrialisation advanced, enamellists began to use engraving machines to produce metal sheets with different patterns such as waves, *moiré* and *guilloché*, thus replacing traditional hand engraving and producing many refined and luxurious enamelled works (Figure 5).



*Figure 5. An antique guilloche enamel ladies' case, the 3rd Jewellers' Artel (cooperative), St. Petersburg, between 1908 and 1917.*

Limoges, once a crucial European centre for the art of enamelling, became famous not only for its enamelled products applied with *champlevé*, but also for another important enamelling technique, painted enamel. Limoges in the 15th century was synonymous with the art of painted enamel (Darty, 2006: 86), which still has an important influence today. Painted enamel in Limoges flourished over a hundred years from the late fifteenth century to the end of the sixteenth century, and is known for its particular style of *grisaille* (Figure 6). But it went downhill in the seventeenth century. In addition to Limoges, several other centres of painted enamel emerged in Europe in the seventeenth and eighteenth centuries, such as Blois, near Paris, Geneva, which was famous for its fine enamelled miniatures, and Augsberg in southern Germany, a vital centre of European craftsmanship.



*Figure 6. Kiss of Peace, a piece of painted enamel work, Museum of Fine Arts, Limoges.*

From the 13th century onwards, as global trade and cultural exchange developed, enamel craft was introduced to Asia, mainly to China and Japan. Asian countries developed their own enamel art with a distinctive oriental aesthetic interest according to their own cultural characteristics. However, there were differences between the enamelling styles of China and Japan during this period. Chinese enamel craft is sincere and reliable in style, applying mainly copper as the base and opaque enamels with rich colours. As enamel craft was only used for the imperial household in ancient China, enamelled works were also indicative of the emperor's style. Japanese enamelled works, on the other hand, were mostly made of silver, or silver wire on copper base, with transparent enamels, making them more refined and forming a fresh and elegant artistic style.

Much has been written about the history of enamel in ancient China, with previous studies mainly focusing on enamel from the Beijing area. However, another important production area for enamelling products, Guangzhou, has received little attention. Guangzhou, formerly known as Canton, was the only trading port in China during the early Qing Dynasty and had a unique position in the history of Chinese enamel, making a significant contribution to the development of enamel in China and the world, especially painted enamel and *basse taille*. The enamels produced in this region are known as "Guangdong Enamel". There are few scholars who have studied it in depth. Shi Jingfei's *Radiant luminance: the painted enamelware of the Qing imperial court* was the first book to provide a comprehensive introduction to Guangdong Enamels. Liu Xiaodong (2010) expounded the effect of Guangdong Enamels on the enamel craft of China and the world from the perspective of technical exchange between China and the West. In 2019, the Guangdong Museum held its first special exhibition of "Guangdong Enamels", which is the first comprehensive



exhibition to showcase enamelled works produced in the 18th and 19th centuries in Guangdong province (Figure 7). “Guangdong Enamel” is mentioned because Guangzhou the capital city of Guangdong province is my hometown, an ancient city in which I grew up. During the Qing Dynasty, there are not only exquisite enamelled products, but also many other types of precious crafts (mainly for export) produced in Guangzhou city. The craftsmanship and culture of Guangzhou subconsciously influenced my choice of specialism and even the direction of studies today.



*Figure 7. A silver-gilt filigree brisé fan with enamelled opera figures with locket, Guangdong Museum, 1796-1820.*

### **The role of enamels**

In the long history of enamel, enamellists in different countries and regions have explored different enamel techniques and the artistic styles that fit with them through a great deal of practice, but the only thing that has remained constant is the understanding of enamel. Traditionally, enamel has been viewed as a kind of decorative material and technique (Cohen, 2004). Rotherberg (1969: 1) has stated that “enamel richly adorned exquisite and finely crafted metalwork”. These statements affirm the long-lasting understanding that enamel has played a decorative role in enamel art. Up to this day, many enamel artists and craftsmen maintain a traditional understanding of enamel, applying this material,

originally intended as an alternative to colourful stones, to their designs and creations from an aesthetic point of view. The following provides further analysis of the technical characteristics of the four main decorative enamel techniques (cloisonné, champlevé, basse-taille, painted enamel) mentioned above, and their modern developments.

## **2.6 Four main decorative enamelling techniques**

The dazzling history of enamel art has seen the development of four main techniques by enamellers and artists, cloisonné, champlevé, basse taille, and painted enamel, each of which has its own distinctive characteristics. Some enamellers prefer to use only one of these techniques in the creation of specific enamel work, while most enamellers apply a combination of techniques on the same piece to better express their artistic vision and to show the feature of the material and the craft. This section focuses on these four enamelling techniques, analyses their respective technical characteristics and presents contemporary examples to show the development and contemporary uses of these four enamelling techniques.

### **Cloisonné**

Many steps are required to complete a cloisonné enamel work. First of all, a thin strip precious metal as wire is formed into a pattern according to the design, and is then welded to a metal base. Enamel paste of different colours is applied to the pattern, and the piece is fired and polished several times. One of the key techniques of cloisonné is the use of wire, just like the traditional delineation in Chinese painting, which emphasises the density and fluency of lines in the picture. These factors impact on the final effect of cloisonné works. Another technical feature of cloisonné is that the filigree effectively prevents the enamel

from breaking and peeling off, since the wire divides the enamel into many smaller areas, which increases the binding force of the metal and limits the distortion of the enamel. The cloisonné technique is used primarily in the work *Hidden hedgerows beaker* by Fred Rich, one of British leading contemporary enamellists, who reveals the technique of wire application. Different wires are interspersed to create areas that vary in size. Also, divided by gold wires, these blocks of colour are both closed and open. The contrast and transition of different colours create an abstract but integral image (Figure 8).



Figure 8. *Hidden Hedgerows Beaker*, by Fred Rich, 2017.

### **Champlevé**

To produce a fine piece of champlevé enamel also requires a master hand. Enamellists first create a depression on the flat surface of the metal through engraving or etching, and then fill these recesses with enamel, which is repeatedly inlaid and fired until the enamel surface is flush with the surface of the metal, and finally polished. Champlevé and cloisonné are similar in their process of applying the enamel, but they are different in their methods of forming the recess. Cloisonné adds metal wire to the metal base to create walls, making areas like recesses that are used to fill the enamel. If cloisonné is a form of addition, champlevé is a form of subtraction. There are various ways of

forming grooves in the surface of the metal base. Among them, engraving and acid etching are two main traditional methods. While engraving is technically demanding and requires repeated training with a graver tool to create a straight level wall of grooves, acid etching requires attention be paid to the density of ferric nitrate or ferric chloride and the length of etching time. Both methods require a great deal of training to reach proficiency. Today, with the development of modern process techniques, methods such as embossing and casting can be used to make the required grooves by *champlevé* with speed and precision. Jane Short, another famous British enamel master, likes to apply *champlevé* to create her enamel works. She creates carved recesses through engraving as well as diverse textures that create different reflective lustres in the transparent enamel (Figure 9).

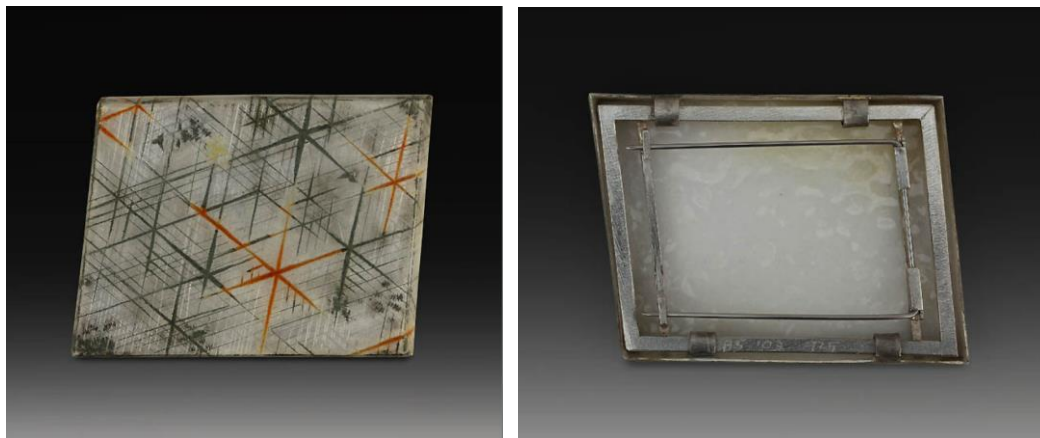


*Figure 9. Flared Beaker 1, by Jane Short. H: 9cm, W: 7cm.*

### **Basse Taille**

Basse taille is the French word for low-cut. To make basse taille enamels, the first step is to create different textures on the surface of the metal, which requires techniques including hammering, chasing, etching, engraving, and casting. Enamellists often apply transparent enamels in order to reveal the underlying metal texture. The colour appears heavier where the engraving is

deeper, and lighter where it is lower. When the light passes through transparent enamel to the reflective metal surface, a layered and attractive effect is made. Although basse taille and champlevé are similar in terms of their techniques for creating depressions in the metal surface, there are still differences between them. While the basse taille process means that the entire metal substrate is covered with thin transparent enamel, either in the low cut or high cut areas, champlevé, only the recessed areas need to be filled with enamel. The influential contemporary jewellery artist Barbara Seidenath, who was born in Germany and moved to the United States, created the Crystalline series shown in Figure 10 by applying basse taille. She first uses etching to create a sunken line texture on the surface of the silver, then dots it with opaque black enamel and rust coloured enamel. Finally, the metal body is covered with a transparent enamel to present a cold but pure winter scene through the interplay of the enamel colours and the underlying metallic texture.



*Figure 10. Crystalline (Brooch), by Barbara Seidenath, 2003.*

### **Painted enamel**

Painted enamel is the most technically sophisticated of the many enamelling techniques. "Portraits", "Painting" and "Limoges" are the terms for this technique. To create a painted enamel piece, the wet enamels are first applied evenly to the surface of the metal base by a fine sable paintbrush, which is formed into a base coat after the first melting. Enamels of different colours are

then mixed with holding agent or oil binder in accordance with the designed patterns and colours, to delineate figures or landscapes. The enamels are then fired at a high temperature to show a delicate and lustrous effect. Painted enamel differs from the above three enamelling techniques in that it uses a finer glass, usually 200 or 325mesh, whereas the previous three techniques usually apply 80, 100 and 200mesh. Contemporary American sculpture and jewellery artist Jessica Calderwood likes to use metal, enamel, and other traditional techniques to create her works. In her work *Ripe*, she depicts the psychological activity of the figure through the delicate technique of painted enamel. The use of comic and ironic tones profoundly express personal obsession, thus touching viewer's heart (Figure 11).



Figure 11. *The Consumption Series: Ripe* (wall work), by Jessica Calderwood, 2008.

## Summary

After a millennium of development, the four main enamelling techniques have survived into contemporary times. These contemporary enamel works adopt a new look and reflect the current aesthetic. In the world of digital technology, it is valuable that most enamellists and artists continue to work with these traditional enamelling techniques. An analysis of the four enamelling techniques

above reveals what they have in common which is the need for a metal base to support the enamel underneath. In the long history of enamel craft, another ancient and rare enamelling technique, plique-à-jour, has been developed. The following section will focus on this technique, which differs from the four techniques above, as plique-à-jour is an enamelling technique without metal support.

## **2.7 The art of plique-à-jour**

### **2.7.1 Plique-à-jour: from history to the contemporary practice**

Plique-à-jour is an extremely challenging enamelling technique that requires a great investment of time in craftsmanship because of its technical and procedural complexity. For most enamellists, plique-à-jour has been a mystery for a long time. The term plique-à-jour in French means letting the daylight go through. Specific to this technique, translucent enamels are applied in metal cells without backing, so that light can shine through the openings of the membrane and creates a fabulous light effect that is close to a miniature version of stained-glass window in a church. Valeri Timofeev, a famous enamellist, described plique-à-jour as “the spider web to the fly”, and mentioned that ancient people cherished artworks that use such technique (Helwig, 1992: 58). The plique-à-jour articles were so valuable that people only used them functionally with precious care. In contrast to other enameling techniques, plique-à-jour has a high failure rate in the process of making without backing. For the same reason, the finished products are so fragile that only a very limited amount of plique-à-jour works have survived over time. In addition, not many enamellists and craft makers know about this technique in depth. Therefore, I will introduce its history and developments, as well as its technical details in this section.

## **History of plique-à-jour and early examples**

As mentioned earlier, because of the complexity of the plique-à-jour technique and the fragility of its products, plique-à-jour enamel works are now very rare. The technique itself dates back to the 6<sup>th</sup> century A.D. when eastern Europe was part of the Byzantine Empire. Plique-à-jour was first used in Kievan Russia. However, due to the Mongolian invasion, this technique was lost in the 13<sup>th</sup> century in that region. Fortunately, the plique-à-jour technique was also developed in western Europe. According to the extant inventories of European princes, the technique of fusing enamels in metal framework without backing had been used in the 13<sup>th</sup> century in western Europe (Speel, 1992). But plique-à-jour artifacts that have survived the dramatic changes since the 15<sup>th</sup> century are rare.

## **An anecdote about plique-à-jour**

About plique-à-jour, there was an interesting anecdote in the 16<sup>th</sup> Century. The *Treatises of Benvenuto Cellini* in 1568 records his presentation of a plique-à-jour enamel cup to King Francis I in Paris. He especially emphasised how curious the King was about the technique and how he was able to answer the King's questions with ample details. From the description of King Francis I's curiosity about this innovative technique, we can infer that plique-à-jour was not widely known in his time. According to Ostoia, Cellini's records are valuable because there were no manuals that mention this technique before Benvenuto Cellini was able to record them (Ostoia, 1945).

## **Early example: “The Mérode Cup”**

The Mérode Cup, currently preserved in the Victoria and Albert Museum, is the most important historical relics of plique-à-jour, and dates back to the early 15<sup>th</sup> century. It is a silver-gilt covered beaker with pointille engraving and plique-à-jour. The cup consists of two parts - the Mérode Cup and its lid. The silver-gilt



cup is decorated with vine scrolls and finely engraved birds (Figure 12). It is an extremely rare piece of medieval enamel work, which was probably made for display purposes and was highly valued. However, because it is unmarked, its real function is unknown. Scholars do agree that it was created by French or Burgundian craftsmen around 1400 to 1420.



*Figure 12. The “Mérode Cup”, Victoria and Albert Museum, D: 10cm, H: 17.5cm, circa 1400 – 1420.*

### **The Art Nouveau**

After disappearing from the historical record for several hundred years, this fabulous enamelling technique was revived during the Art Nouveau period in late 19<sup>th</sup> Century to early 20<sup>th</sup> Century in Europe. During this period, silversmiths and jewellers applied the plique-à-jour technique extensively to ornaments and objects for display. Among them, the French enamelling craftsmen Charles Riffault came out with the big opening technique of plique-à-jour (Figure 13) and created a large amount of works for Frédéric Boucheron.



*Figure 13. An antique plique-à-jour enamel brooch, by Charles Riffault, circa 1880.*

Among the jewellers in Art Nouveau, René Lalique was in no doubt the most influential. He developed a new stylistic language of jewel design that highlighted the natural configuration of objects with smoothed curves. He also showed a preference for enamels, glasses and horns within his jewel works (Figure 14). During this Art Nouveau period Philippe Wolfers was another jeweller of equal importance. His compositions also showed a close relationship with nature. One of his hair ornaments “Exotic Orchids” was viewed as a symbol of the Art Nouveau movement and its practitioners (Figure 15).



*Figure 14. Dragonfly woman corsage ornament, by René Lalique, H: 23cm, W: 26.5cm, 1897-1898.*



*Figure 15. Hair ornament, by Philippe Wolfers, H: 7.6cm, W: 7.6cm, 1905-1907.*

## Russia and Norway

Enamel works were also popular in the late 19<sup>th</sup> Century to the early 20<sup>th</sup> Century. During this time most of the well-received enamel works were cloisonné products, although plique-à-jour was also found in some pieces. Pavel Ovchinniko and Ivan Khlebnikov were two of the most well-known enamel craftsmen that specialised in plique-à-jour. In terms of design, most beer beakers were pierced-out work while the majority of smaller artifacts were created within the filigree framework. In terms of pattern, plique-à-jour works in Russia were decorated with flowers instead of human figures (Figure 16).



*Figure 16. A set of four Russian gilded silver and plique-à-Jour enamel liqueur glasses, Ovchinnikov, Moscow, H: 7.9 cm, circa 1900.*

In Europe, Norway was once the centre of global industry and another significant place of study for plique-à-jour. Norwegian enamel craftsmen were initially highly influenced by the Russian style. But later, their craftsman Gaudernack introduced new designs that used Norwegian motifs of plants and Viking ships as well as very ornate vases (Figure 17). J. Tostrup also created some larger plique-à-jour works using a similar style. In terms of the jewellers of plique-à-jour, David Andersen (in Oslo) and Martin Hummer (in Bergen) were

two important names.



*Figure 17. Antique Norwegian solid silver & plique-à-jour enamel viking boat, H: 16.5cm, W: 26 x 13cm, circa 1890.*

### **Asia (Japan and China)**

In the 19<sup>th</sup> Century, plique-à-jour saw rapid development in Asia, especially in Japan. Japanese enamel craftsmen creatively combined cloisonné with plique-à-jour using the technique of acid etching. This type of plique-à-jour products were named “shotai-jippo” in Japan. The crafting process was similar to the production of traditional cloisonné except the last step. After the base cloisonné product was built, the technique of acid etching was applied to remove the copper base, leaving the enamels and metal lines only. Without copper bases, the finished products have the same translucent effect as their European plique-à-jour counterparts. In terms of artistic style, Japanese plique-à-jour works have a strong Asian hue. Most of these works have patterns of traditional Asian flowers, the colours of which are light but elegant (Figure 18). However, the technique of plique-à-jour was not as developed in China as other enamelling techniques were in the same period. At least no existing historical records from that time mention a single word about it. This is an issue that requires further study.



*Figure 18. A small plique-à-jour vase (shotai-jippo), Hattori Tadasaburo (attributed to), H: 9cm, circa 1905.*

### **The contemporary development of plique-à-jour**

Luckily, despite some discontinuity of development from the 15<sup>th</sup> century, the technique of plique-à-jour still exists today. Although not many people have solid expertise in making plique-à-jour works, few craft makers and artists are consistently producing plique-à-jour works, rather they endeavor to combine plique-à-jour with contemporary designs and techniques, in order to rejuvenate this old but priceless technique. This section introduces some of the new developments of plique-à-jour in the contemporary art world, including more up-to-date designs, the innovative combination of different enamelling techniques, and the creative use of digital technology.

### **New designs with traditional techniques**

One of the most common ways of innovation is using traditional techniques to create contemporary artistic expressions. Valeri Timofeev from Latvian is one of the most important plique-à-jour enamellists following this trajectory. His plique-à-jour works differ from the previous works that featured symmetric and repetitive patterns. In his contemporary experiment with plique-à-jour, he imposes a strong personal style and artistic philosophy in his works, which

speak directly to his unbounded imagination. From his works, we can see that Timofeev is good at using floating lines and vivid colours for some abstract expressions (Figure 19).



*Figure 19. Champagne Flute (left) and Wine Goblet (right), by Valeri Timofeev, Walters Art Museum, 1993.*

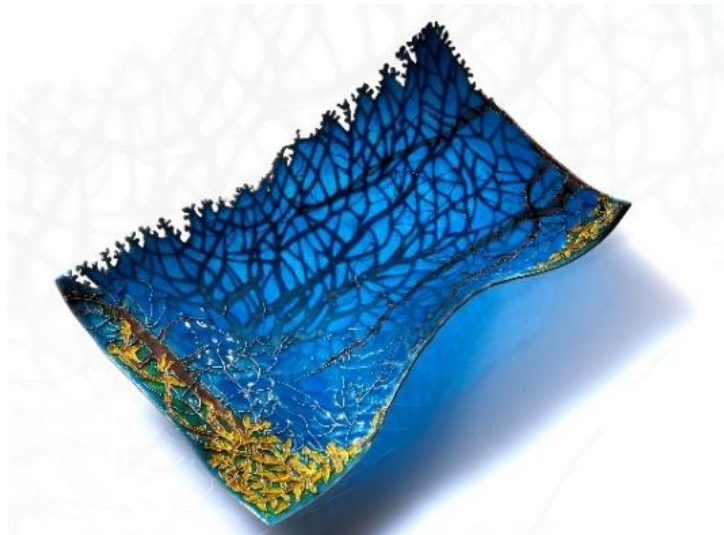
Jean Wilkinson is a new-generation silversmith and jeweller in Ireland. Mentored by Phil Barnes, the famous enamellist in Britain, she started her training with metals and jewels in the 1990s and took up enamelling techniques in 2000. In recent years, Jean has produced a large amount of pique-à-jour works that use piercing extensively. Deeply influenced by the artistic philosophy from the Art Nouveau period, her works show a strong preference for patterns like water drops, shape of leaves and elements from the natural world. One of her presentative works *Koi Among the Lily pads* (Figure 20) is a successful combination of the characteristics of pique-à-jour and her artistic expression of nature. The light effect of pique-à-jour perfectly presents the colour of lotus leaves after rain.



Figure 20. *Koi Among the Lilypads (centrepiece)*, by Jean Wilkinson, 2020.

### **Contemporary innovative combinations of different enamelling techniques**

New paths are being carved out in addition to traditional plique-à-jour. Some enamellists and designers endeavour to combine different enamelling techniques and designs in order to revitalise traditional plique-à-jour. Fay Rooke from Canada is one representative of these efforts. Most of her works are made with multiple enamelling techniques. Her work *Maple Aspen Oak* is a good example that combines techniques of cloisonné enamel, gold foil inlay and plique-à-jour (Figure 21). For plique-à-jour, she has skillfully used piercing to show the shade of the aspen. On the edges, fine silver cloisonné is used to show the branches of the oak. This work shows Fay's excellent skills in putting together different enamelling techniques in an organic way. The intertwining pattern in *Maple Aspen Oak* is indeed an artistic expression of Fay's understanding of life and art. In her own words, "as in life, their stories are transparently entwined" (Crowe et al., ca. 2013).



*Figure 21. Maple Aspen Oak, by Fay Rooke, 2013.*

Another contemporary enamellist, Alexandra Raphael from Britain, also shows passions for multiple techniques and mixed-style plique-à-jour. She is famous for her application of the Japanese shotai-jippo technique to European-style plique-à-jour. Most of her works use patterns of insects such as butterflies and bumble bees, while geometrical patterns are also occasionally found. In terms of techniques and materials, Alexandra loves to use gold wires to achieve a more flamboyant effect. As mentioned above, Japanese shotai-jippo is a plique-à-jour technique developed from traditional cloisonné. Shotai-jippo is similar to cloisonné in all steps except that acid etching technique is used to remove the metal body at the end. However, Alexandra uses this technique slightly differently - when making the cloisonné, she creatively leaves some “cell” areas empty of enamels. This step creates some beautiful openings and holes after the copper part is etched. These holes and openings are created by the gold wires that are used in the previous steps. Therefore, when light goes through the enamel work, it creates a unique shadow on the table (Figure 22), which is not seen in traditional Japanese shotai-jippo.





*Figure 22. Lace (plique-à-jour bowl), by Alexandra Raphael, 2019.*

### **Integration of digital technology**

When it comes to the digital age, enamellists and designers have begun to embrace digital technology in order to renovate traditional craftworks. Enamelling craft is also part of this trend. Amy Roper Lyons is one of the first to integrate digital technology in her plique-à-jour works (Figure 23). In practice, she first forms her works using 3D-modelling software and then produces the modelled works using 3D printing in resin. In the meantime, she uses casting to make the sterling silver components. For larger pieces, she usually assembles the silver components using soldering. Finally, she applies enamel pastes to the metal bodies before placing them in the kiln. Lyons believes that digital technology can change her work and “inform [the] design process” (Johnston, 2017: 144). Undoubtedly, her plique-à-jour works do present a pleasant sense of order and accuracy.



*Figure 23. A collection of goblets and vessels, by Amy Roper Lyons, circa 2015.*

## **Summary**

From changes in patterns and designs, the combination of multiple traditional techniques and the introduction of digital technology, traditional pique-à-jour has seen new developments in its contemporary applications. However, regardless of the difference in patterns and designs, the understanding by craft makers of pique-à-jour and their pique-à-jour techniques have not changed fundamentally, as shown in the examples of the enamelling works provided above. That is, enamel is consistently used as a decorative material to fill in “cells” of different sizes and shapes. Why do people usually repeat this method in different works? This question could be answered through a detailed introduction to the characteristics of this technique, to which I am turning in the next section.

## **2.7.2 Characteristics and technical analysis of plique-à-jour**

As a metal-based enamel technique, the composition of plique-à-jour work is based on the approaches of producing the metal part. In the long history of plique-à-jour, metalsmiths and enamellists have developed different methods for forming and removing the metal base for enamels. These techniques include wire soldering, piercing, casting and acid etching. It is the combination of these techniques that brings the unique characteristics and visual effect of plique-à-jour. In this section, I will detail the characteristics of plique-à-jour and the reasons behind its unique light effect.

### **Characteristics of plique-à-jour**

Introductions to the plique-à-jour technique are revealing. Here are two descriptions from the V&A Museum and the Goldsmiths' Company:

French for 'letting in daylight', plique-à-jour enamel is translucent, allows light to pass through and is backless, or not fused to a base. Enamelling in this manner is technically difficult to master (V&A Museum, n.d.).

Plique-à-jour is a process by which enamel is applied in 'cells', often created by a network of carefully shaped fine silver and gold wire, but without a backing so that, when completed, the light can pass through the enamel (The Goldsmiths' Company, n.d.).

We can summarise several key aspects of plique-à-jour based on the above descriptions and the case studies in the previous section: transparency, without metal backing, fragility, cellularity, one dimensional/single viewing plane and a stained-glass window effect. Among them, transparency is the most distinct feature because enamellists use translucent enamels in their plique-à-jour works. In addition, plique-à-jour differs from other enamel techniques as it does

not use metallic backing beneath the vitreous enamels, which allows light to go through the transparent enamels and generates a miniature stained-glass window effect. However, for these two reasons, plique-à-jour shows more fragility than other enamel techniques. While its transparency, independency of backing and fragility are widely known, cellular and one-dimensional features of plique-à-jour do not receive sufficient attention. These two characteristics are considered below.

### **Technical analysis of plique-à-jour**

From a technical perspective, two methods are usually used for plique-à-jour work: surface tension and temporary backing. For plique-à-jour works using surface tension, the opening areas are small and therefore usually coupled with wire soldering, piercing and casting. For plique-à-jour using temporary backing, mica, metal sheet and acid etching are common methods in use, which enable larger openings in the products. It is notable that Japanese shotai-jippo is also a subtype of acid etching, which should also be categorised as temporary backing. The “cellular” feature and the “one-dimensional” feature of plique-à-jour can be viewed as two consequences of these techniques.

### **Cellular**

I became aware of the cellular features of plique-à-jour in my own practice of making plique-à-jour works in 2019. The cellular feature is created by the techniques of wire soldering, piercing, and casting. Take my own plique-à-jour goblet work (Figure 24) as an example, this was created using wire soldering and shows a complex cellular structure in the final product. For the making process, the first step is positioning the fine silver filigree type wire on a plaster mould, with all wires fully connected or tangent so that they can be soldered together. After the soldering procedure, the finished product becomes a metal framework with a cellular structure, in which some “cells” of different sizes and

shapes are formed by the soldered silver wires.



*Figure 24. Filigree framework before soldering (left) and after soldering (right), see the complete work at Figure 1, by the author, 2015.*

Besides wire soldering, piercing can also create a similar cellular structure. For the brooch Matilija Poppy shown in Figure 25, patterns are first pierced out of metal sheets using saws, the openings of which are then filled with wet enamels. After melting and polishing, the final plique-à-jour work with different cells is completed. From the process, we can see how the piercing technique helps create the beautiful cellular structure of the whole piece of work.



*Figure 25. Matilija Poppy (brooch), Metal framework by piercing before applying enamels (left); a complete piece of plique-à-jour (right), by Tom Herman and Patsy Croft, 2019.*

Lastly, casting can also create plique-à-jour with a cellular structure. Amy Roper Lyons's collection of goblets and vessels are good examples of this type (Figure 26). Casting the components created by 3D modelling and printing on a metal framework, she creates plique-à-jour works that have strong symmetric patterns of cells. However, it is noteworthy that the cellular structure is decided during the modelling step using 3D software, while casting is only a step that transforms the virtual 3D models into real objects using physical materials.



Figure 26. Applying enamels in the metal framework (left); after melting the enamels (right), by Amy Roper Lyons, 2015.

### Single plane

For the plique-à-jour technique using temporary backing, mica and metal sheet are two backing materials that are commonly used to temporarily support enamelling. After fusing the enamel within the metal frameworks, the backing materials have to be removed by hand or etched by acid. This approach is applied because through the process of using temporarily backing the final plique-à-jour works present a “one-dimensional” effect or a single-view plane (Figure 27). Similarly for Japanese shotai-jippo, the enamel pastes have to lay on the metal base before firing. Therefore, after applying acid etching to remove the metal base, the finished plique-à-jour products, including shotai-jippo, show a “single plane” characteristic.



*Figure 27. The mica method (left) and metal sheet method (right).*

## **Summary**

From the above analysis, it can be concluded that the understanding of enamel and the application of the technology determine the formation of the visual effects of traditional plique-à-jour to some extent. At the same time, I identified two reasons for stagnation in the development of plique-à-jour. Firstly, the cellular structure is the key factor that limits the development of traditional plique-à-jour. Secondly, traditional plique-à-jour (temporary backing) is limited by the backing metal body, meaning that enamellists are unable to apply enamel to explore more structures. Based on the past craft practice and extensive literature review, I propose the idea of breaking up the cellular structure such that when the cell is broken up, the enamel becomes a bonding agent rather than having a purely decorative role. Previously no systematic study had been conducted on the application of enamel to connect metal parts at different distances, or the use of this technique to explore of different structures in space, this therefore constituted the research gap that was the focus of this study.

### 3 Methodology

This chapter discusses the methodological principles and methods used in this research, based on the research questions and aims listed in Chapter 1. As practice-based research, practice is at the core of this research (Candy, 2006), which develops theories and contributes to knowledge through new discoveries from creative practice and insights (Tin, 2012; Johansson and Porko-Hudd, 2012). Throughout the research process, I apply the methodological principles including practice as research (Gray and Malins, 2004), reflective practice (Schön, 1983), and I also draw on Nelson's model (2013: 32) - an iterative process of doing-reflecting-reading-articulating-doing. Based on the theories above, I develop a model of research methodology adapted to this research project: reading–designing-making-documenting-reflecting-analysing-writing. This model is then applied to the four phases of this research: 1. The proposal of the new concept, the Mind the Gap (MTG) series, and the initial experiments; 2. The experimental exploration of manual production methods; 3. The pursuit of precise fabrication in combination with the application of digital technology; and 4. The exploration of new shapes and the rediscovery of the value of traditional making knowledge through a series of experiments. Theoretical and practical inquiries are carried out throughout the four stages of the study, emphasising the interplay between these two inquiries (Nelson, 2013; Nimkulrat, 2007; Redstrom, 2017). Although the literature review of this thesis is placed in Chapter 2 and the studio practice and discussion is placed later in Chapters 4 and 5, the two sections are parallel rather than separate. As Lambert (2019: 75) has stated, the exploration of theory and practice supports a synergy of understanding.



### 3.1 Creative practice as research

In the past, practice was not seen as a strictly academic activity (Barrett and Bolt, 2010). Peter Jarvis (1999) stated that for a long time, traditional research was guided by academics and scientists, while the duty of the practitioner was to abide by and implement their findings. Nelson (2013) noted that practice is separated from research, which stems from the western intellectual tradition. Nelson (2013: 3) echoed Jarvis' view that "Artists engaging in inquiry through their practices may not have thought of what they did as 'research', even though they were aware of an exploratory dynamic to address issues and achieve insights".

Since the 1970's, however, as artists and designers in mounting numbers became involved in different research projects, creative practice came to be recognised as a way of learning things, as well as a research method (Manghani, 2021). Practitioner-researchers have developed the concept of practice as research and have suggested that this research has led to a change in art from where research was mainly done by critics, theoreticians or historians to a proactive research model, where more creative people are involved in the research process (Malins et al., 1995: 3). In practice based and practice led research, practice is central (Durling, 2002; Malins et al., 1995). Nelson (2013: 26) further emphasised that practice, whatever it may be, is at the heart of the methodology of the project and is presented as substantial evidence of new insights. Nimkulrat (2013: 2) expressed a similar view and more specifically stated that the role of "creative practice" in such research is as a questioning process constructed to collect data and to generate reflection about the practice.

In research, practice is increasingly valued because people can acquire existing knowledge and create new knowledge through it. There are considerable

studies on knowing by doing or knowledge in making (Schön, 1983; Frayling, 2011; Ingold, 2009). Barrett and Bolt (2010) has argued that the practice of art can be regarded as a knowledge-making activity and stated that knowledge is derived from doing and the vast majority of knowledge is acquired through the senses. Lambert (2019) also considered that much knowledge is born from craft practice and research. When discussing the relationship between practice and material, Barrett and Bolt (2010: 30) cited Heidegger's view in *In Being and Time* that "we do not come to know the world theoretically through rather, we come to know the word theoretically only after we have come to understand it through handling". The importance of handling material is further elaborated here.

However, much of the knowledge gained in practice is not fully expressed through language (Dormer, 1997; Tin, 2012), a topic that has been hotly debated in practice-based research or craft research. Nelson (2013: 9) cited philosopher David Pear's argument that one may know how to ride a bike, but not know how to describe how to balance it. He further noted that practical knowledge is unable to be articulated by way of a traditional thesis in words alone, but needs to be combined with a concrete object of art. Schön (1983: 49) has stated: "often we cannot say what it is that we know. When we try to describe it we find ourselves at a loss, [...] Our knowing is ordinarily tacit, implicit in our patterns of action". But different scholars have their own understandings about whether such tacit knowledge requires to be made explicit. Friedman (2000) and Nimkulrat (2013) both reckoned that tacit knowledge should be explicit, otherwise the practice cannot be considered as a kind of research. Lambert (2019: 21), on the other hand, argued that turning tacit knowledge into explicit does not allow for a holistic approach to knowledge, and instead puts forward a view of the hybrid tacit-explicit account of making.

In the final analysis, the above discussion is still a question about the relationship between practice and research. Frayling (1993) has argued that research has an influence on and continues to play a crucial role in practice, including the education of art, design and craft. In his article *Research in Art and Design*, Frayling quoted John Constable, who spoke at a lecture at the Royal Institution in 1836, in support of his view. Constable said: "Painting is a science, and should be pursued as an inquiry into the laws of nature. Why, then, may not landscape be considered as a branch of natural philosophy, of which pictures are but experiments?" (Frayling, 1993: 4) But I am more interested in what Frayling said of an interview with Picasso in 1923, described at the beginning of this essay. In the interview, Picasso said:

The idea of research has often made painting go astray, and made the artist lose himself in mental lucubrations. Perhaps this has been the principal fault of modern art. The spirit of research has poisoned those who have not fully understood all the positive and conclusive elements in modern art and has made them attempt to paint the invisible and, therefore, the unpaintable (Frayling, 1993: 2).

Picasso also stated in the interview that he is a maker rather than a researcher (Frayling, 1993). His statement is worthy of consideration in terms of what research means for artistic practice, whether all practices can be applied to research, and what kinds of practices have a positive impact on research. Schön gave a more specific interpretation of practice. He pointed out that there are two levels of practice: the first is "performance" in a professional context, and the second is to prepare for this "performance". Professional practice usually includes the element of repetition. However, he suggests that professional specialisation can sometimes have the negative effect that causes "a parochial narrowness of vision" (Schön, 1983: 60).

Considering my own studio practice, Schön's point reminds me of my own craft practice over the past 15 years. Since 2007, I have been studying metalwork, of which plique-à-jour is one of many techniques I have examined. Over these years, I have gained a wealth of knowledge and practical experience of what Schön called "professional specialisation", and have learned under the tutelage of teachers and master craftsmen. It was a challenge to apply and melt the enamels on a cellular structure without metal backing when first starting to learn plique-à-jour. But after years of repetition, the act of filling in the cell became fixed and natural. When making a plique-à-jour piece, I no longer require too much thinking, and the openings can be filled with the right quantity of enamel while the time and temperature required for firing can be well controlled. However, this professional experience accumulated through several years seems to limit doubts about "filling in the cell". Just like Schön (1983: 61) put it, "as practice becomes more repetitive and routine, and as knowing-in and routine, and as knowing-in-practice becomes increasingly tacit and spontaneous, the practitioner may miss important opportunities to think about what he is doing". The practice referred to in this study, therefore, should not be a repetitive one, but an innovative approach to practice that expands learning of traditional plique-à-jour and creates new findings and knowledge.

### **3.2 Reflective practice**

Risatti (2007), in distinguishing between workmanship and craftsmanship, points out that workmanship is repetitive labour, while craftsmanship is a profound act of creativity. He describes that this creative activity consists of conception and execution, thus creating a feedback system. In this feedback system, physical material meets conceptual form. He further emphasises that,

“in this encounter, thinking and making, visualising and executing, theōria and praxis go back and forth, which is a truly dialectical and dialogical process” (Risatti, 2007: 169). In practice-based and practice-led research, many practitioners and researchers describe this feedback system as reflective practice, designed to provide a framework that unites research and practice and encourages reflection in different ways (Gray and Malins, 2004: 22). The eminent philosopher and educator John Dewey (1997: iii) stated that “reflection involves not simply a sequence of ideas, but a consequence - a consecutive ordering in such a way that each determines the next as its proper outcome, while each in turn leans back on its predecessors”.

Reflective practice is an important theory developed by Donald A. Schön (1983). At the beginning of his book *Reflective Practitioner*, Schön provides a theoretical background for the theory of reflective practice. He begins by critiquing professional knowledge and the model of Technical Rationality, pointing out that Technical Rationality has its origins in the nineteenth-century belief in science and technology, a powerful philosophical doctrine, which was the heritage of Positivism. He stressed that traditional professions are based on scientific and systematic knowledge, which has four characteristics: specialised, firmly bounded, scientific, and standardised. Traditional professionals and educators find that the use of Technical Rationality, a method they had taken for granted in the past, does not resolve the phenomena of art (Schön, 1983: 19). Schön therefore challenges Technical Rationality, arguing that the model of Technical Rationality is imperfect because it fails to account for practical competence in divergent situations, so another method should be found to explain or deal with situations which are artistic, intuitive, uncertain or even have value. Therefore, he proposed the term "reflective practice". Schön (1983: 50) believes that reflective practice allows art practitioners to bring to the surface and understand the tacit knowledge hidden in their actions, and to

critique and reconstruct implicit understanding, so that it can be applied in their future actions. This, he pointed out, is the whole process of reflection-in-action, the core of artistic practice and research. He emphasises the "in" factor, noting that intellectual activity does not necessarily precede physical action, and that people do not just think about what they are going to do, or have done, but think about doing something while doing it. However, the development of technology and the internalisation of knowledge is an imperceptible process (Schön, 1983). Gray and Malins (2004: 22) expressed a similar view and provided a more nuanced description of reflection-in/on-action, stating that reflection-on-action is a critical research skill and part of the generic research processes of review, evaluation and analysis. Reflection-in-action is a particular activity of professional practitioners and involves thinking about what we are doing and reshaping action while we are doing it.

In terms of the role of reflective practice in research, Schön (1983: 56) noted that it not only corrects the rigidity of the practitioner's thinking due to excessive professionalisation, but it can also contain "experience of surprise". When a practice or behavioural action produces unexpected results, reflective practice prompts practitioners and researchers to focus on the practice itself, its results, and the tacit knowing hidden in the process, in order to discover the reasons for the surprises. However, not everyone agrees on the role of reflective practice in research. Friedman (2002: 8) raised doubts about reflective practice as a research method, arguing that reflective practice is a personal act, rather than a systematic inquiry. He emphasised that "reflection arises from and addresses the experience of the individual". Research, on the other hand, should "address the question itself, as distinct from the personal or communal" and all research should involve some form of "systematic inquiry". McKernan (1999: 46) similarly argued that systematic research is important for the profession. He stated that the capacity of "self-evaluation" and "self-

improvement” is the most important aspect of the professional and that the acquisition of this capacity requires “rigorous and systematic research and study of his or her practice”. Nelson (2013: 33) expressed a similar view, that “a rigorous process of editing, refinement and reworking is entailed in the processes of practitioner-researchers”, which contributes to “better-quality artwork results”. The next section will further explain how my own studio practice and research can be constructed into a systematic process based on the model of Nelson.

### **3.3 Research methods**

It is important to select suitable research methods for a study. Informed by Nelson’s multi-mode research model (Nelson, 2013), I chose appropriate research methods for this study, including reading, designing, making, documenting, reflecting, analysing, and writing, as well as a combination of different recording tools to collect data. At the same time, I took seven methods and formed an iterative and circular methodological model (see section 3.4). Before illustrating the model, this section firstly focuses on the role of these methods in this study.

#### **Reading**

Conducting a systematic literature review is necessary to begin a study. Reading helps researchers to understand the relevant field in which they are working, what has been done, how it has been done, and what problems exist (Hart, 1998). Reading is an important skill for a researcher that will help the researcher to place their research in a relevant theoretical context for comparison and discussion, and will provide a framework for further study (Blaxter et al., 2001). In the field of art and design, reading is not limited to text,

but also includes images and videos, and even physical objects. This is vital to this study because understanding a traditional craft requires not only reading the text but also incorporating the artwork itself. The reading of documentary and images leads to the identification of research gap. Certainly, reading should not only be done at the early stages of research, but throughout the entire research process. Nimkulrat gives specific advice on the role of reading in research. She argues that a literature review should be closely linked to specific research questions, as well as be appropriate to different research stages (Nimkulrat, 2009). This study draws on Nimkulrat's view to correlate the findings of a literature review with the research process. As the research evolves, corresponding readings are continually added to echo the practice.

### **Designing**

In this section, design refers to more specific design activities that includes two aspects. The first is experimental design, which excels in providing logical and systematic procedures according to Jones (1984). The application of design in this study lies in the formulation of experimental objectives, the selection of appropriate materials and production methods, and then the development of specific experimental procedures based on the objective and question of each experiment. The second aspect is the visual exploration of the form, including the design of structure and colour. However, design in this context remains an abstract activity (Dormer, 1997), emphasising the design of shapes and structures with sketching and 3D software as a prelude to concrete material testing, rather than the practice of working with materials.

### **Making**

As a study based on studio practice, the innovation of the plique-à-jour requires a series of material testing experiments. Making in this study refers to experimentation and artwork creation. Experimentation, a commonly used



research method, is emphasised here as a scientific experiment, involving the control of different variables and the comparison of experimental results (Blaxter et al., 2001; Kelly, 2009). The MTG series, developed from plique-à-jour, is a metal-based enamel, where the scaffolding is metallic. It is a tortuous process of exploration to arrive at effective solutions for the MTG series by using different metallic materials to make the scaffolding. Making, focusing on direct dialogue with the material, plays an indispensable part of this process. The making of the artwork is based on previous experimental data, turning sketches of the design stage into physical objects. As the complexity of the structure increases, different insights are distilled at different stages of making (Nimkulrat, 2009; Lambert, 2019).

### **Documentation**

Documentation is important as a research method in practice-based research. Scrivener (2002) emphasised the role of documentation in practice as research as assisting experimenters and researchers in capturing experiential knowledge as well as making knowledge learned from practice (Mäkelä and Nimkulrat, 2018). Nimkulrat (2009) expressed a similar view that when practitioners apply art as a vehicle of research, the process of creation needs to become a textual and visual form, to be presented and discussed. Recording is a crucial tool to realise the demonstration of the practice process. Nimkulrat used her PhD research as an example to further illustrate the significance of documentation. Records of different phrases of practice enabled her research and practice process to become more transparent and communicable. She said that she documented not only the process of art creation, but also the entire research process (ibid., p.34). In research based on studio practice and experimentation, the means of documentation mainly include sketching, photographing, video recording, diary writing, and diagram drawing (Kelly, 2009; Nimkulrat, 2009). All these methods of documentation are used in this study to

collect various data, findings, and insights, and are presented in the form of experimental template, texts, sketches, diagrams, photographs, videos (see Appendix 1).

### **Reflecting**

To some extent, the insights and inspiration gained in the making process are generated by reflection (Mann, 2016). Through “reflection and critical self-study”, practitioners and researchers are better able to test their own practice (Morris, 2012: 235). Anttila (2009) expressed a similar view and stated that reflection is a crucial research tool that facilitates researchers to conduct reviews, and to analyse and evaluate experiences. This is key to the studio practice of this study. Through reflection, I am able to improve the design schemes and making methods in practice, and ultimately produce a valid and reliable MTG model that based on understanding of how MTG disrupts traditional plique-à-jour.

### **Analysing**

The role of analysis is to deal with data, which is inseparable in the design of research (Miles et al., 2014). Blaxter et al., (2001: 206) has said that “analysis is about the search for explanation and understanding” and “data analysis is about moving from chaos to order, and from order to chaos, often simultaneously” (2001: 194). As can be seen from Anttila's description earlier, analysis and feedback are an integral process with no clear boundary between them. Researchers give feedback on the experimental process and analyse it while making observations on the results. As Mäkelä and Nimkulrat (2018: 1) have stated, reflection-on-action may include an analytical process. Based on the Bloom's Taxonomy (1969), the role of analysis in this study is mainly to examine, categorize, compare and summarise the data obtained from the experiment or the production of the artwork, as well as the findings from

reflection, thus forming different themes.

## **Writing**

Writing, as a research method, is crucially about externalising the knowledge latent within the practitioner, turning tacit knowledge or experiential knowledge into the explicit through articulation in order to make it known to a wider audience (Groth, et al., 2015: 57; Friedman, 2000: 13). Cross (1999: 30) argued that writing is an intelligence amplifier. Nelson (2013: 36) further stated that writing is not only about transforming the medium of artwork into words, but also into practice. Lambert (2019: 81) expressed the similar view that writing is part of the crafting of knowledge. For this study, it is important to turn the insights derived from production and the tacit knowledge latent in the technical practice into the explicit through writing (articulation), which helps practitioners to better share their research (Nelson, 2013). Certainly, from my personal experience, I do not think that all tacit knowledge can be expressed through writing, which is why the research needs to be concluded with an exhibition where the experiments are physically displayed so that the audience and readers can better understand the research (Nimkulrat, 2009).

The above research methods are combined and applied to this study in a mutually reinforcing relationship. The next section will specifically describe how these different research methods interact with each other and play their respective roles in the four phases of this study, culminating in this practice-based research.

## **3.4 Four phases of research process**

This research aimed to explore the models and paths of innovation in enamel

craft plique-à-jour. As previously described, the research process was partitioned into four phases, and was a process whereby theory and practice interacted to generate new problems, seek solutions, obtain new results and discoveries. Each phase began with a research problem and ended with an experimental result that serves as the basis for the research problem that is the focus of the next phase. Based on Nelson's research model (2013), a research approach was chosen that was appropriate for this study developing a mutual and cyclical model: reading–designing-making-documenting-reflecting-analysing-writing. This model described below, guided by the research questions, was circularly applied to the four stages in order to drive the development of this study.

### **Phase 1: Proposing the MTG series concept and initial experiments**

The aim of the first phase of the study was to understand the current development of traditional plique-à-jour, and thereby identify the research gap that would be the focus this study. It was found that the limits of the development of traditional plique-à-jour are the cellular structure and people's understanding of enamel in the past. Therefore, I proposed breaking the cellular structure as an important opportunity for breakthrough in the innovation of plique-à-jour. This conjecture changes the traditional understanding of enamel as a decorative material and turns it into a bonding agent. Meanwhile, I explored the potential of this idea combined with the structural design of the scaffold. In the past, there was no systematic study on **how to use enamel as a linking agent as part of the structural design**. Thus, this research question becomes the focus of the initial MTG series in the experiments. Based on this research question, early material tests were conducted, and simple metal scaffolds were designed and built as first attempts to apply and melt the enamel between separate metal spheres. With analysis of the experimental results, the feasibility of using enamel as a linking agent for structural exploration was initially verified. I

documented the experimental process, and gained initial experience in making and developing the experimental criteria. However, the results of all experiments at this stage were crude and often broken, making precise data collected hard to collect.

## **Phase 2: Material testing based on handmade methods**

Based on the practice of the first phase, **how to improve on the construction of the metal scaffolding and the effectiveness of the test pieces became the focus of the second phase of research.** This phase focused on two elements: the production of the metal spheres and the construction of the scaffolds. This phase of production was mainly hand-made and partly combined with digital techniques, with the aim of collecting further data and gaining experience in production. Firstly, the regularity of the round metal spheres affected the finish of the test piece. How to make the spheres and drill the back of the small-size spheres (3.0mm diameter) became the sub-questions during this phase. Early in the second phase, in order to understand the method of making the metal spheres, literature on the traditional granulation process and contemporary examples of artists who used this technique to produce works was examined. The idea of applying digital technology to improve the accuracy of the accessories, using CAD modelling and direct investment casting to produce batches of spheres was put forward. Manual drilling and CNC machine drilling for the spheres were both examined. It could be seen that the production of just one metal sphere of 3.0mm diameter involves a number of iterations through design adjustments and the application of different techniques. Another key point of the second phase was in searching for an effective method for producing the metal scaffolding. How to construct the scaffold and the material to use as a base for the scaffold was another research question during this phase. Plaster moulds and a soldering block were utilised as the base material for the experiments. After analysing the results of the second phase of the

experiments, the preliminary conclusion was that the plaster mould would be more suitable than the soldering block as a material for the scaffolding. In addition, adapting the diameter of the pillars of the scaffolding and the diameter of the holes in the metal spheres were also sub-questions that needed to be solved during the experiments, for which I conducted several tests. As can be seen, minor questions arose during the course of practice which not only guided the specific practice, but also the shape of the entire study.

### **Phase 3: Combining digital technology in the pursuit of precision**

As a metal enamel craft, the construction of the metal scaffolding, to some extent, determines the effectiveness of the MTG series. During the second experimental phase, the most crucial part of the MTG series, the metal scaffolding, was still being made by hand, which made it impossible to obtain precise data and made it difficult to achieve a regular result for the test pieces.

**How to produce accurate metal scaffolds was therefore a major problem in the third phase.** Digital technology seemed to be the answer to this problem.

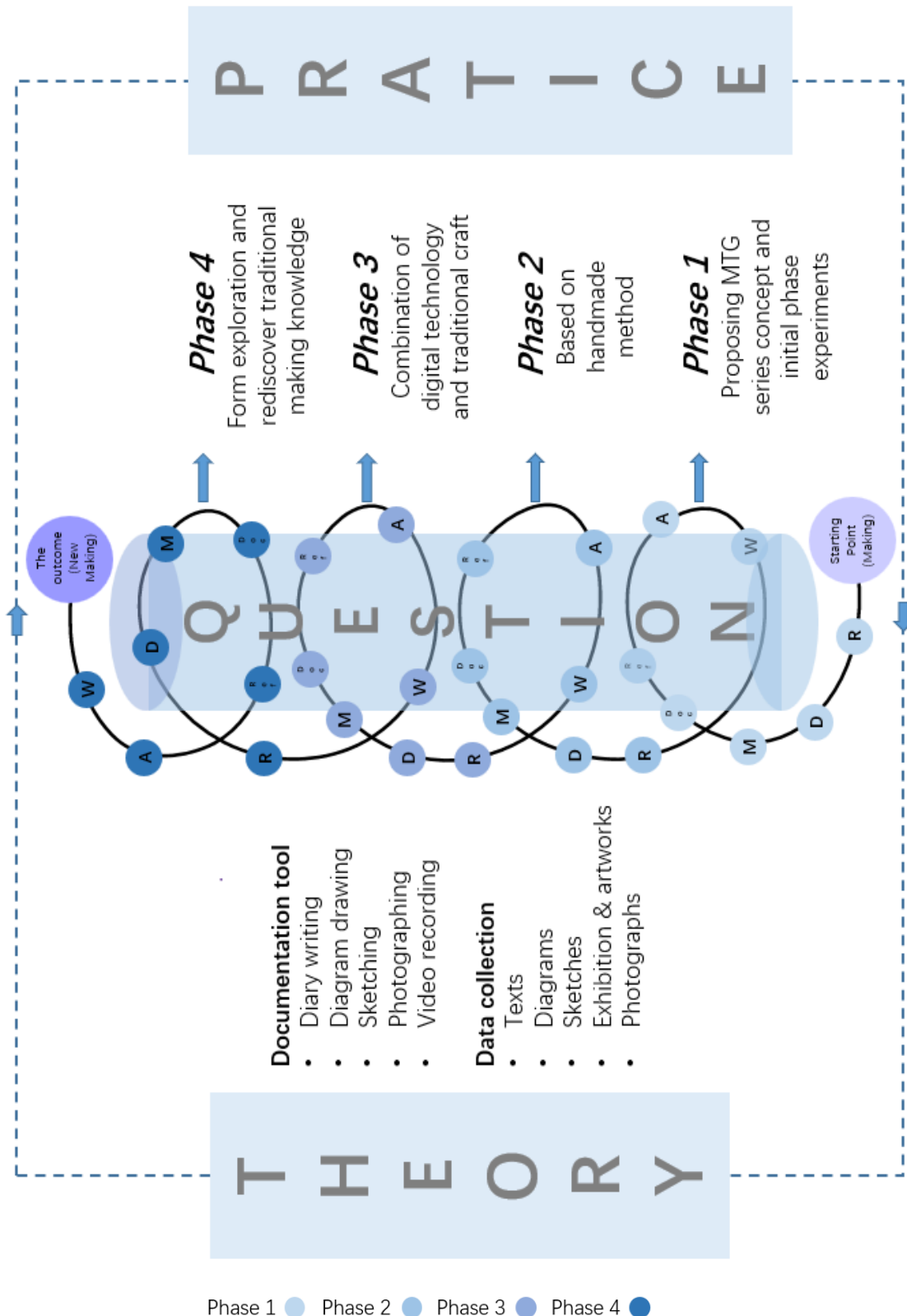
During this phase, two techniques, resistance welding and selective laser melting (SLM), were used to produce the metal scaffolds, where SLM is a direct metal printing technology that allows the production of the metal scaffolding to be fully automated without manual production. Through application of SLM, precise metal scaffolds and accurate data could be obtained by recording the experimental process. However, after receiving feedback and analysing the results of the experiments, a greater problem emerged. Although the scaffolds produced by digital technology are improved in terms of accuracy, the structure of these metal scaffolds is fixed, resulting in a tendency for them to break when the fragile enamel pieces are separated from the scaffold. Thus, although the use of digital technology enhances the accuracy of the test pieces, it generates new problems. The identification of approaches to dismantle the precise scaffold without external forces in order to obtain the complete enamel piece

became a new problem.

#### **Phase 4: New form exploration and rediscover the value of traditional craft**

Based on the problems identified above, the fourth stage of practice was initiated. In the previous experiments, the structurally fixed scaffolding was dismantled by cutting. However, due to the forces involved, this method could easily lead to fracture of the enamel pieces. **How to separate scaffolding from the enamel piece without extra force became a critical question in Phase 4.** After extensive research of traditional production methods, acid etching was identified as being able to solve this problem. Thus, I studied the method of acid etching of metals, and redesigned the structure of the scaffold and the materials to be used according to the characteristics of acid etching. The effectiveness of the acid etching method for dismantling metal scaffolding was verified through many experiments. Not only was the solution to dismantling the scaffolding identified but, again, the value of traditional making knowledge after the fourth stage of practice was demonstrated. Based on this, different shapes for the MTG range were considered in order to expand the potential of this new technique.

The above four stages were a development process to explore the MTG series guided by research questions and combining the approaches of reading, designing, making, documenting, reflecting, analysing, and writing research methods. In this specific research process, different methods do not necessarily have a linear relationship, but rather have a mutual, cross-cutting and iterative relationship. Through the interplay of these different approaches, a framework was constructed from this study, which ultimately establishes an effective design and making methodology model of the innovative concepts of the MTG series (Figure 28).



Reading-R; Designing-D; Making-M; Documenting-Doc; Reflecting-Ref; Analysing-A; Writing-W

Figure 28. The methodology map of this study.



## 4 Data collection and findings

After an in-depth analysis of plique-à-jour, explanations for the limited development in this traditional craft have been identified (see Chapter 2). This chapter discusses the four stages of the exploration of innovative plique-à-jour considered in this study. In order to establish an effective design and making method for the creative concept MTG, 62 experiments were conducted in total, and 35 of these experiments were selected as examples to demonstrate this creative and challenging process of craft innovation (see Appendix 1). Through extensive experimentation, a lot of data such as melting enamel and model design parameters were collected, and valuable making experiences were accumulated, answering research question one (Q1) and achieving research aim one (A1) set out at the beginning of the research and laying a solid foundation for further exploration of the MTG series.

### 4.1 Material testing phase 1: proposing the MTG concept

Traditional enamelling technique plique-à-jour has remained fundamentally the same for hundreds of years although some contemporary enamellists attempted to develop it. After identifying the reason for plique-à-jour's stagnation in Chapter 2, the approach of innovating this rare enamelling craft through series of material testing and studio practice becomes the core of this study in the following. This section firstly introduces the design thinking process of the creative concept MTG series and then further describes the experiments of the first stage.

### 4.1.1 The origin of Mind the Gap (MTG) series concept

The notion of the gap that becomes the key point for study in this research originates from an in-depth analysis of the traditional enamelling technique *plique-à-jour* (see Section 2.7). The cellular framework structure, and the aesthetic language of the “cells” are brought about through the traditional techniques that enamellers have employed and their past understanding of enamel. Based on the theories of “deliberate departure” (Lehmann, 2012) and “creative destruction” (Schumpeter, 1942) discussed in the Part one of Chapter Two, I propose a radical innovative concept for traditional *plique-à-jour* that is to leave and break the cellular structure. Once the cell is broken, enamel will work as a bonding agent instead of a decorative material to connect the separate metal parts. More importantly, the objective of applying enamels develops from filling in the cell to filling in the gap (Figure 29). Conducting a “deliberate departure” from the cell means the practitioner views the cell as a constraint on thought. Then using “creative destruction” as a bomb to break the cell, this leads to a new interpretation of the enamels and meaning of applying enamels, echoing the “radical innovation” concept proposed by Verganti (see Section 2.4.1).

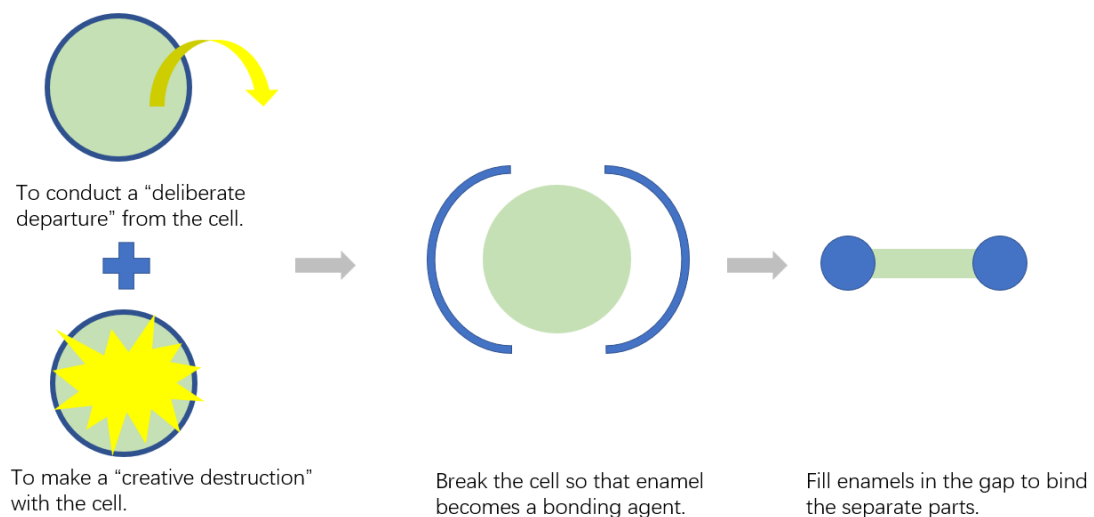


Figure 29. Radical innovation for traditional *plique-à-jour*: the process of the creative concept Mind the Gap (MTG) series.

Based on the creative idea of breaking the cell, the physical gap between the separate metal parts becomes a critical element to be considered when enamellists apply the enamels. Inspired by the iconic warning from London Underground tube system, I decided to use the phrase “Mind the Gap” as the leading title of the following studio practice. To many people who live in the UK, the phrase “Mind the Gap” has historical roots. The origin of this phrase can be traced back to 1968, and is used to remind passengers to pay attention to the gap between the underground train and the platform. Until today, if you live in London and take the underground, you will see and hear this simple phrase “Mind the Gap” many times (Figure 30). This phrase provided me with inspiration in that I am also conducting a similar activity of connecting when I apply the enamels, although the physical gaps between the metal objects are much smaller than those on the London Underground. Thus, the idea of using the phrase “Mind the Gap” for the creation of the series of works and experiments arose.



*Figure 30. The “Mind the Gap” announcement is used across London’s tube network.*

The essential insight here is that an academic study that seems rigorous and even boring, in fact, has a close relationship with our daily lives from which we can obtain innovative ideas and inspirations. More importantly, it reminds me to focus on those gaps which are identified from this research, including not only the physical gaps between the scaffolding objects, and the gap between craft and digital technology, but also the gap between theory and practice, and, of

course, the knowledge gap that we are exploring. In this research, Mind the Gap draws attention to the “Gap” and describes the central theme of this set of experiments which seek to gain a greater understanding of enamel as a bridging element of the “Gap” to extend the aesthetic possibilities of plique-à-jour. Therefore, the gap should be ‘minded’.

#### **4.1.2 The initial phase of experiment**

New questions arose after the innovative concept of the MTG series was put forward (Section 4.1.1). Questions arose as to whether the enamel could be used as a bonding agent and could really connect the separate metal pieces, whether the results would be fragile and unstable, and whether different structures and forms could be made by connecting the enamel to the metal parts. With these queries in mind, the first phase of the material testing for this study was undertaken. This section describes early thoughts, processes, and experiments.

##### **Early design thinking**

Based on the idea of breaking the cell described above, it was found that when a metal cellular structure is broken, scattered pieces of different shapes are formed. In order to establish a standard for the shape of the metal pieces in the subsequent series of experiments, different forms of metal parts (wire or plates) are summarised into a simple sphere, as well as considering different combinations of forms of the basic element of the sphere. I used a sketch book to record my initial ideas, which is important for practice-based research, since the ideas of the practitioner are often fleeting. The sketch book recorded my ideas in detail (through sketching and texts). For example, the red boxed area in Figure 31 recorded my thinking process as I explored from a line, to two dots, to three and four dots. Moreover, the sketch book also provides a crucial

reference for later in the research when reviewing previous designs and experiments.

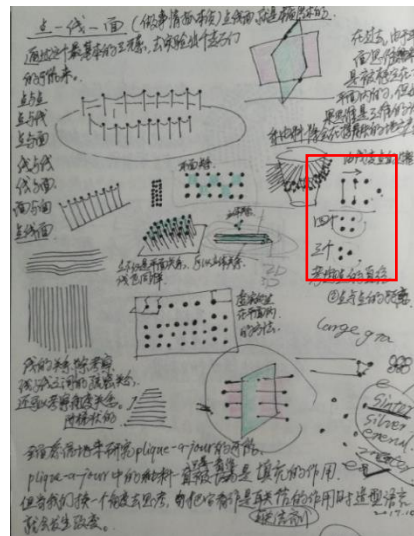


Figure 31. Sketching and diary writing a method to record my explorations of form.

## The objective and process of the experiment

Based on the above design sketch, I began the earliest experimental stages of this research (see Appendix 1: E2 - E6). Although in the past, I had gained a great deal of practical experience in the enamelling craft, applying enamel as a bonding agent to fill in the gap was a novel approach of which there was no experience. Thus, the aim of the first phase of experiments was to initially test the feasibility of the concept of the MTG series. The first questions that the experiment focused on at this stage were related to the production of the scaffold, materials and dimensions used, and the type of enamel. This phase was mainly conducted by hand, with the technique of granulation used to produce the spheres and the material of the fine silver. The spheres were approximately 2.2-2.5 mm in diameter and the pillars were 0.5 mm in diameter, while the scaffold was constructed by soldering. The enamel applied was transparent green (100mesh), produced in China.

The first experiment was a preliminary test of the distance between spheres, which were divided into two groups: two spheres (Table 1) and three spheres

(Table 2). The objective of the experiment was to test how different distances between spheres impact on the technique of applying the enamel and the effect of the enamel part after melting. As can be seen from the preliminary experimental results for both groups, the greater the distance between the spheres, the more the enamel covered the surface of the metal spheres. Therefore, the parameter of the gap between the spheres is a key factor that influences the results from the experiments.



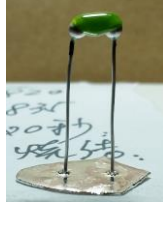
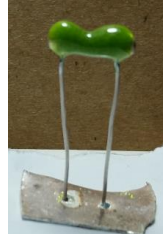
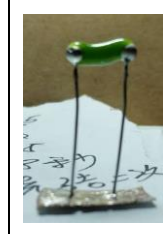
The outcome of experiment					
Distance between spheres	1.2mm	2.0mm	4.0mm	5.0mm	5.5mm

Table 1. Testing of different distances between two spheres.





The outcome of experiment				
Distance between spheres	1.2mm	1.8mm	2.5mm	4.8mm

Table 2. Testing of different distances between three spheres.

Based on the findings of these two sets of experiments, a linear form structure was made from a single row of spheres and a circular structure also made from a single row of spheres. This was the first time that these two experiments examined the idea of cutting away the supporting scaffolding, leaving only spheres and the enamel, which become part of the structure. From the results

of these experiments, the feasibility of this idea was initially demonstrated. However, it was found that the testing piece of a straight form structure made with a single row of spheres collapses during melting after the supporting scaffold are cut and then melted once (Figure 32). Furthermore, the testing piece of the circular structure also breaks after the scaffolding is dismantled (Figure 33).

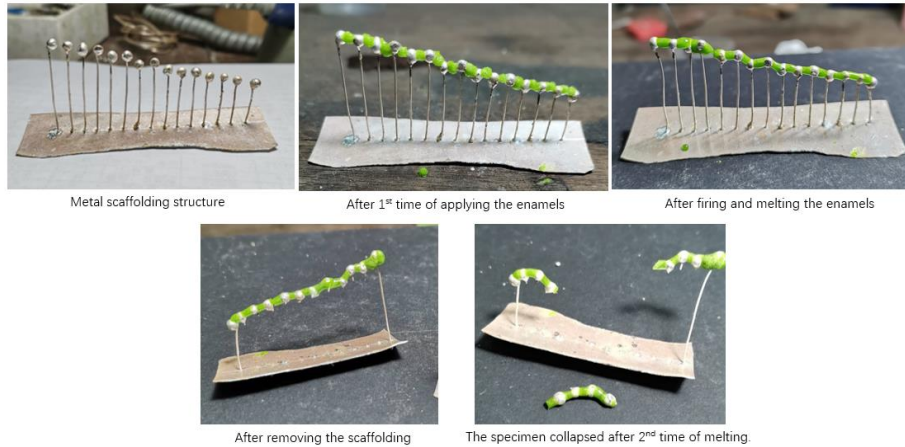


Figure 32. The making process and the results from the straight form structure made with a single row of spheres.

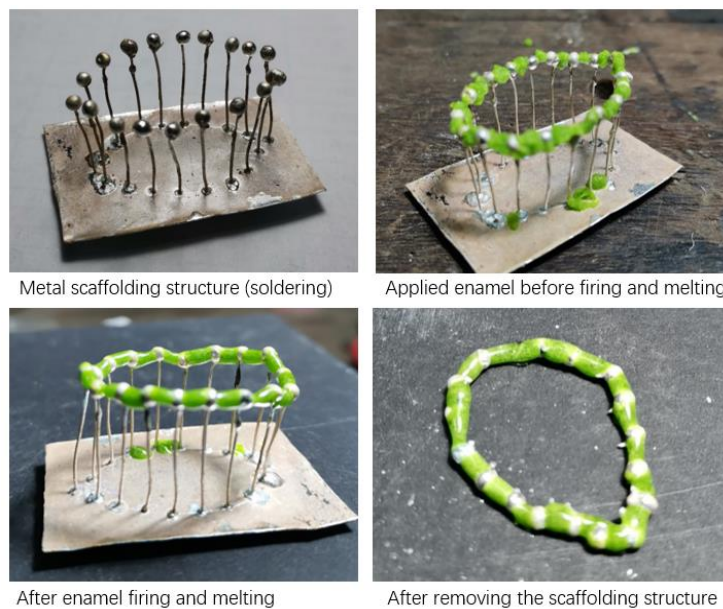
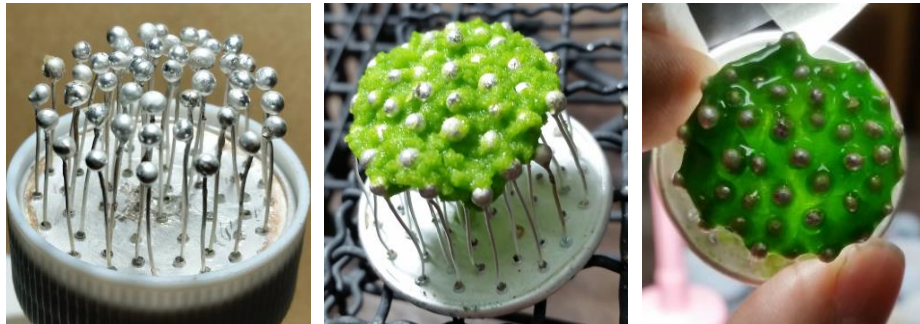


Figure 33. The making process and results of the circular structure.

In addition to the above experiments, a multi-sphere form was made, which shows how the spheres are connected by the enamel to become an enamel

piece that is almost circular in shape. Spheres are not equally spaced from each other but show the transparent effect of the enamel (Figure 34).



*Figure 34. Metal scaffolding (left); after applying enamels for the 1st time (middle); after melting enamels for the 1st time (right).*

## **Summary**

The above material tests were undertaken as part of the first experimental phase of this study. Although the feasibility of the MTG concept was preliminarily tested and initial practical experience gained, it is obvious that the results of all the experiments at this time were very crude. The following findings and insights were obtained from this phase of the experiment. Firstly, the metal scaffolding was not well fabricated. To collect accurate data, consideration of the production and parameters of the scaffolding was necessary, including the size of spheres, the distance between spheres, the height of pillars, etc. In addition, it was essential to set criteria for all the experiments to determine which results were valid and successful. When the cellular structure is broken, the enamel becomes a bonding agent as part of the structure. Therefore, the focus of this study is to understand whether enamel can connect separate spheres without the supporting scaffold and create different structures and forms without excessive cracks. This will be regarded as an acceptable criterion for a successful experiment in what follows. In the next sections, I further validate the MTG series concept based on this criterion through the second phase of experiments and describe the process of improving the metal scaffolding.



## **4.2 Material testing phase 2: based on handmade method**

This section discusses the second practical phase of this study, focusing on the exploration of the two main components (metal spheres and scaffolding) of the MTG series production. Studio practice during this phase was mainly hand-made, with the aim of further validating the feasibility of the MTG series concept and gaining more experience in design and production. The method of producing precise metal spheres was improved while two methods of constructing the scaffolding, plaster mould and solder block, were tested through the second phase of experimentation.

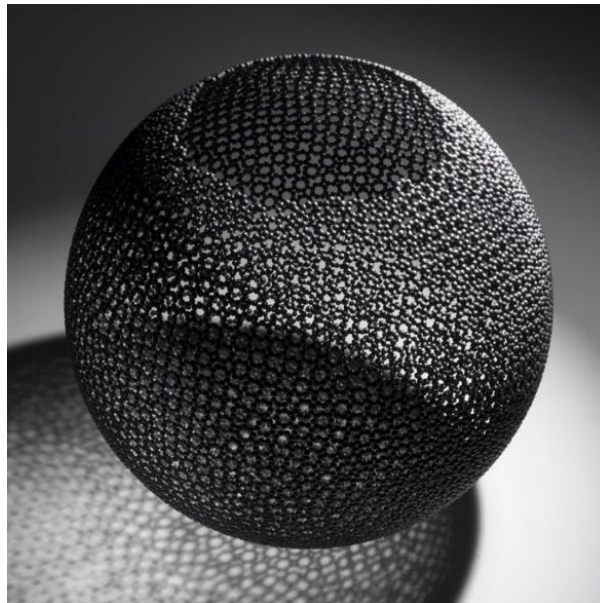
### **4.2.1 The techniques of making metal spheres**

#### **4.2.1.1 Handmade method**

As can be seen from the results of the initial experiments, silver spheres and enamel are the two most important components of the MTG series creation. As silver spheres are in direct contact with the enamel, their shapes and sizes impact on the effect of the enamel bonding. How should the silver spheres be made and what should be the diameter of the round silver spheres so they are suitable for the MTG series creation are therefore the overriding questions in early experiments. This section describes the objective of this experiment, and details the process of making the silver spheres by applying an ancient technique of granulation as well as the findings therein.

Granulation, a traditional craft that originated in Mesopotamia in 2500 B.C, is a common decorative technique seen in precious metal jewelry based on pattern design and arranged by small spheres. In the 8th century B.C., Etruscan craftsmen applied this technique and produced metal works. The granulation

technique can now be found in jewelry and gold and silverware from different regions and ethnicities around the world. This ancient metalwork has continued and developed today, with contemporary metal artist David Huycke reinterpreting the technique and applying it to create larger sculptural silverware. In contrast to traditional complex shapes, he prefers to arrange metal spheres in an orderly manner on the surface of a minimalist metal object to explore the border between "figure and abstraction", thus creating a unique personal language that is in contrast to the granulation style of traditional jewelry. Huycke later developed three-dimensional shapes made using only silver granules, which were oxidised and blackened through post-processing to convey a pure but mysterious visual effect (Figure 35).



*Figure 35. Lace Sphere, by David Huycke, Dimensions: 26 cm x 26 cm, 2006.*

### **The aim of experiment**

The aim of this experiment is firstly, to examine the ancient granulation technique for the production of round silver spheres, initially with a diameter of 3.0 mm. Secondly, to produce round silver spheres of the same shape and size through the same technique in order to provide batches of silver spheres for the MTG series of experiments.

## **Fabrication process**

Applying the granulation technique, the experiment requires materials including fine silver, charcoal block, and torch to produce the silver spheres. The equipment and tools used for drilling are a mini table drilling machine, a 0.8mm diameter drill and tweezers. The process is as follows: first prepare a silver plate and place it on the charcoal board. And then melt the silver plate with a torch until it becomes a round silver sphere. Next, in order to facilitate drilling, a sharp grain tool is used to make a small mark on the back of the silver sphere for the drill to locate and prevent skidding on the surface, acting as a pilot hole. Finally, the silver sphere is held with tweezers to drill hole half the diameter of the sphere with the table drilling machine. It should be noted that the front of the tweezers needs to be gripped to increase the pressure between the silver sphere and tweezers, so as to reduce the possibility that the silver sphere moves during the drilling process.

## **Data collection and analysis**

### **Granulation and sphere diameter**

In this experiment, the diameter of the silver sphere was initially set to 3.0 mm in order to increase the area of contact between the enamel and spheres, and thus, promote the possibility of their linkage. From this experiment, it was found that the diameter of the silver sphere to be produced is the factor of the first importance in the granulation technique. The difficulty in producing silver spheres with the granulation technique is that the larger the diameter of the sphere, the harder it is to form a regular sphere shape. Because the fine silver is subjected to gravity during the melting process, the outcome is subject to subtle and indeterminate deformations. As noted in the literature, the traditional granulation technique can turn a short length of silver wire or a thin piece of silver into a round silver sphere, but no clear answer is given as to the size of the silver sphere that can be made. Without this experience, it is difficult to see

how the use of the conventional granulation technique impacts on deformation when the size of the sphere reaches a certain range. In fact, whether smaller or larger diameter silver spheres are the most suitable for the MTG series of experiments will require more experiments to inform. This demonstrates the significance of practice.

### **Difficulty of creating half-drilled spheres**

Another difficulty associated with this experiment is the drilling in the back of the silver spheres. In this experiment, a mini table drilling machine was used to drill the holes vertically in the back of the spheres, which were fixed to the wood brick by tweezers. Three difficulties were identified with this practice: firstly, it is hard to fix the silver spheres in place while drilling holes by holding the tweezers in the hand. Although a leather strip are attached to the front of the tweezers to increase friction, silver spheres are still prone to sliding when drilled (Figure 36). Secondly, the drill tends to deflect when drilling, causing a different position each time the hole is drilled, making it difficult to align the hole with the centre of the sphere. Thirdly, it is difficult to ensure the same depth of the hole each time because the silver sphere is prone to moving around. Fourthly, the small size of the silver spheres also adds to the difficulty of this semi-manual drilling method. In this experiment, although the old granulation technique is applied again, other methods were explored in order to produce silver spheres of the same size with the same diameter and depth of half bored behind the spheres to facilitate the collection of accurate data for subsequent experiments.



Figure 36. Using a tweezer with leather strip to hold the silver sphere for drilling hole.

Apart from collecting accurate data for the experiment, there was an interesting phenomenon seen during the course of conducting this experiment. This phenomenon was the process of the change in the form of a sheet of silver to a hemispherical shape and then the final formation of a silver sphere (Figure 37). Particularly, at the moment when the melting silver becomes a spherical silver sphere rolling on the charcoal block, the description of this change of state may be difficult to explain in a few pictures or words, unless experienced through practice. This confirms Ian Lambert's (2019: 66) observation that "the only way to learn, and to truly know [...] is by doing it", which may be the unique meaning and joy of craft practice.



Figure 37. The granulation process of making a piece of silver plate become a silver sphere: 1. silver sheet — 2. hemispherical sphere — 3. round shape sphere.

#### **4.2.1.2 Direct investment casting method**

The previous stage of the experiment shows that it is impossible to produce silver spheres of the same shape and size with the traditional granulation technique. Moreover, it is difficult to make precise holes in spherical silver spheres by hand and with the use of table drilling machines. This section details the process of making silver spheres through the direct investment casting technique and a CNC drilling machine to make precise holes in the silver spheres. New findings and reflections are also described.

##### **The aim of experiment**

The aim of the experiment is to use CAD and direct investment casting technology to mass produce silver spheres of the same size and shape and to test the feasibility of drilling holes with accurate diameter and depth in the back of silver spheres with a CNC drilling machine.

##### **Fabrication process**

The experiment was divided into two main steps: precision investment casting and CNC drilling. Firstly, a CAD file was created by Rhino software for a silver bead of 3.20mm diameter (the diameter of the sphere for this experiment is larger than the previous granulation experiment of 3.0mm due to the contraction of the metal part after investment casting). A pillar of 1.0mm in diameter and 4.98mm in length was added to the base of the silver sphere (Figure 38: right). The second step consisted of precision investment casting (Figure 39). During the third step, after obtaining the casting parts in bulk, silver pieces were arranged and fixed with glue on an acrylic sheet of 5.0mm thickness that had been perforated. Then, a CNC drilling machine was used to drill in silver spheres, with a drill of 0.5mm diameter and 1.5mm depth (Figure 40). Finally, silver spheres were removed and post processed by a magnetic polisher, resulting in batches of silver spheres of the same shape and size with a smooth

surface.

### **Data collection and analysis**

This experiment demonstrates the feasibility of using precision investment casting and CNC technology to produce accurate half-drilled silver spheres, providing an effective production solution and technical support for subsequent experiments. However, behind a seemingly simple half-drilled silver sphere lies a tortuous process of design and a re-recognition of the relationship between design and production.

Initially, Rhino was applied to create a CAD file of a sphere, 3.2mm in diameter, with a hole of 1.10mm in diameter and 1.73mm in depth (Figure 38: left). A number of jewelry fabrication factories and individual studios were consulted in order to mass produce this silver bead for subsequent experiments in the MTG series, but none were willing to do so. After discussions with the factory technicians, it was found that the problem was that the first design of the model did not take into account polishing after casting. In precious metal jewelry processing, the precision casting investment method is generally used. Metallic casting pieces are cut from a casting tree, leaving a metal sprue on its surface that needs to be polished to achieve a complete metal piece. However, the size of the silver spheres to be produced is so small that it is impossible to grab them by hand for post-polishing. Therefore, on the advice of experienced technicians, the CAD file was remodified to add a 1.0mm diameter, 4.98mm long pillar to the base of the sphere (Figure 1: right). The addition of the pillar solved the problem of not being able to grasp the silver sphere in later polishing, so that practitioners are now able to hold the pillar by hand to polish the sphere section. Furthermore, this design allows the pillar to be attached to the main trunk of the wax tree instead of the sphere, avoiding the sprue appearing on the surface of the sphere after casting which would make it difficult to polish (Figure 39). This

seemingly redundant pillar is then removed during the subsequent CNC drilling process (Figure 40).

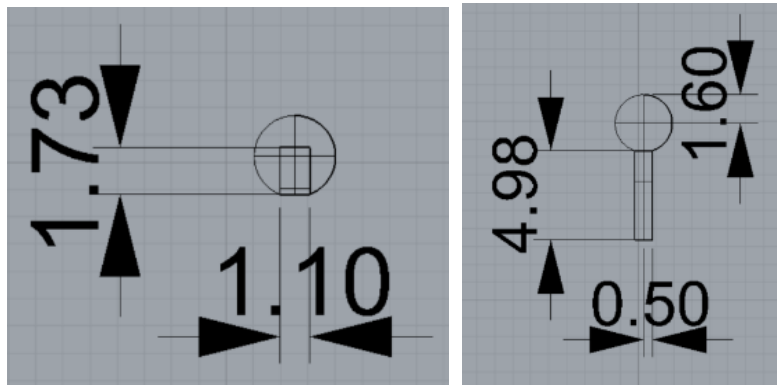


Figure 38. The CAD files of sphere: the first design of silver sphere (left), the second design of silver sphere (right).



Figure 39. The casting piece of the second design in brass (left); two pieces of silver spheres cut from the casting piece with attached pillars before CNC drilling (right).



Figure 40. CNC drilling process.



It was an experience of design change prompted by the experience of the construction, which reminded me of Terrance Conran's words: "until a designer knows how to make something, they cannot truly be said to have designed it" (Newson et al., 2017: 6). And it also led to deeper thinking about the relationship between design and making. In addition, in this exercise I saw that when making objects of a specific tiny size, humans cannot manipulate them by hand without external tools. While much of the research on hand craft emphasise the value and role of the craft, we must acknowledge its limitations in some cases. It is better to regard the relationship between handwork and machine in a more holistic way.

## **4.2.2 The handmade method of making scaffolding**

### **4.2.2.1 Plaster mould as foundation**

After completing the initial MTG experiments, I began to see a glimmer of hope for the innovative concept of the MTG series and its feasibility. By employing the traditional granulation, direct investment casting, and CNC drilling techniques, I initially gained experience in making the half-drilled silver spheres required for the MTG series, a key component in the MTG series of experiments. However, as the MTG series was further explored, new questions arose, including which materials should be used to build the scaffolding part, the type of enamel, and the shape design. Was the success of the previous experiment (Section 4.1.2) just a coincidence? Whether the studio practice can provide an effective and feasible method for the future creation of the MTG series still requires further examination.

This section focuses on the process of exploring one of the methods for

constructing scaffolding for the MTG series, the plaster mould method. This process is divided into two experimental stages: the first stage is the plaster mould drilling hole method, and the second stage is the plaster mould casting method. In the following, the aims of the experiments and making process of these two phases are described and the experimental results obtained from these two methods are analysed, problems identified, and insights obtained.

### **The first phase of the experiment: the plaster mould drilling hole method**

#### **The aim of experiment**

The first phase of the experiment aimed to test the feasibility of using plaster mould as a base material to hold and support metal scaffolding in the MTG series of experiments and to test the effect of this method on melting enamel.

#### **Fabrication process**

The materials used in this experiment include plaster powder, fine silver, copper, and enamels. The fabrication process is described as follows:

First, the shape of the test piece was designed, and the position of each silver sphere and pillar on the plane of the plaster mould was marked. The shape of this testing piece is an arc form consisting of five silver spheres, each with a diameter of 2.5-3.0mm, and the distance between the centre of each two silver spheres is 4.5mm (Figure 41). At the second step, the plaster mould is marked at the five positions for drilling and then inserting the copper pillar. Then, the semi-circular silver spheres are arranged at the top of the pillar in order. The diameter of the holes on the back of the spheres is 0.8mm. Then, paste of plaster is applied around the bottom of the pillars and then there is a wait for this to dry. The pillars are then be fixed. At the fourth step, the enamels are applied and melted. Finally, the enamel piece is separated from the plaster mould.

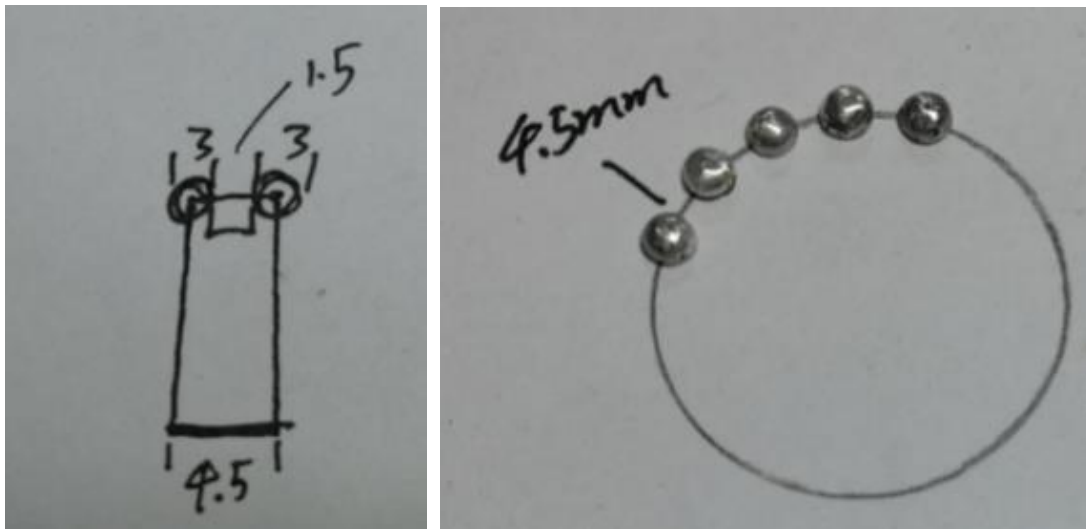
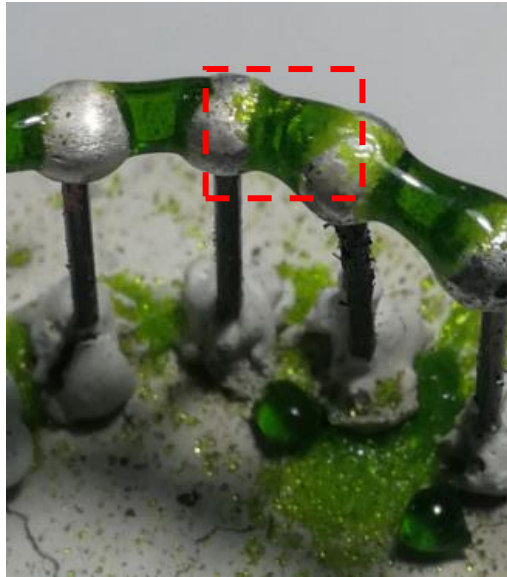


Figure 41. Design sketch: diameter of the silver spheres and the distance between them (in mm) (left). Five hemispherical silver spheres are placed according to the design pattern (right).

### Data collection and analysis

Experiment eight (E8) was the first test of the scaffolding built on a plaster mould in the MTG series (see Appendix 1: E8). This experiment melted a total of seven times. The result was that after the enamel connecting part was separated from the plaster mould, the enamels broke and failed to connect the 5 silver spheres. There are six possible reasons for the failure to connect the silver spheres.

First, the type of enamel. The enamels used in this experiment was a kind of transparent green enamel from China, which has high transparency from the surface effect and may contain a large amount of glass, which is the reason for the fragility of the enamel. Secondly, this enamel is different from the thermal expansion of the silver sphere, which causes the enamel part to crack after cooling. We can see the obvious cracks in the picture (Figure 42). Understanding the chemical composition and physical properties of this enamel is the key to understanding whether it is suitable for use as a bonding agent for creating the MTG series.



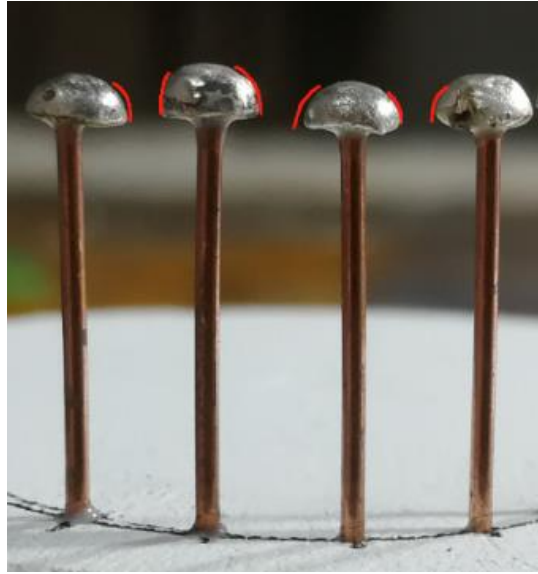
*Figure 42. The testing piece shows a clear crack at the joint.*

Third, the temperature and time of melting. This experiment melted the enamels seven times in total. The time of the first melting was short and the furnace temperature was low in order to maintain the enamels in a sandy surface state (Figure 43). According to previous experience with traditional plique-à-jour, the first few melting times are usually short and controlled within 15-20s. The furnace temperature is also low, usually at 700-715 °C. The purpose is to allow the enamels to stay in the openings and maintain a sand state. Until all the openings are filled with enamels, only for the last melting is the melting temperature increased and the time to melt all the enamels lengthened. This previous making experience was applied to this experiment, but from the experimental outcomes, this prior experience did not appear appropriate for the production of the MTG series. If the enamels are not completely melted at the first melting, this may decrease the possibility of connecting the silver spheres with enamels. Of course, this was only preliminary speculation, and further experiments are needed to test this hypothesis.

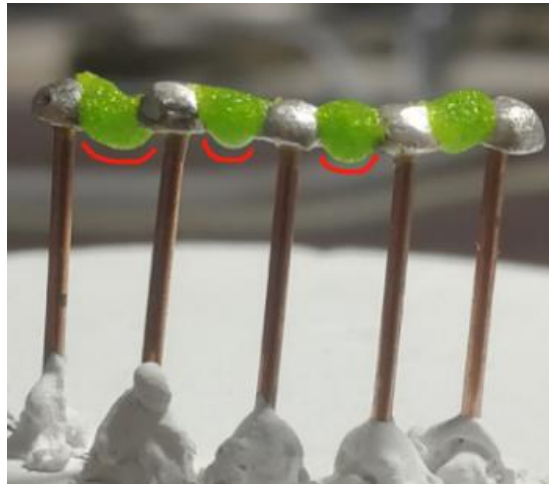


*Figure 43. The enamel part is sandy and has partially fallen off after the first melting.*

Fourthly, the silver spheres used in this experiment were hemispherical in shape. The initial idea of making the silver spheres hemispherical was that the silver spheres could be placed relatively smoothly on the top of the copper pillars, and it would be easier to drill holes in the hemispherical plane than in the round spherical ones. However, from the actual production process, the result of using hemispherical silver spheres was not satisfactory. The most important reason is that the use of hemispherical spheres greatly reduces the area of contact between the enamel and the sphere (Figure 44), thus increasing the possibility that the enamel connecting part will crack. At the same time, the hemispherical silver spheres are not conducive to carrying the enamel, as shown in Figure 45, where the enamel drops significantly after application. Such a situation tends to cause the enamel to stick to the metal pillar below after melting, resulting in the inability of the enamel part to separate from the scaffolding part.



*Figure 44. The gaps between the hemispherical silver spheres.*



*Figure 45. After first applying the enamel, the enamel slumped below the edge of the spheres.*

Fifth is the connection between the copper pillar and the silver sphere. In order to allow the silver sphere to be inserted into the top of the pillar more smoothly, the diameter of the hole drilled on the back of the silver sphere was 0.8mm the same diameter of the pin, ensuring that the silver sphere would not tilt or move during the melting of the enamel. However, implementing this size resulted in the silver spheres and the pillars to be too hard to separate. In addition, after the high-temperature melting, a layer of copper oxide formed on the surface of the copper pillars. This layer of copper oxide also made it more difficult for the enamel connecting part to remove from the metal scaffolding below. Therefore,

copper is not suitable for use in metal pillars (Figure 46).



*Figure 46. The copper pillars produced copper oxide after high-temperature melting.*

Sixth, with respect the plaster mould base, the base for inserting the metal posts was made of white refractory plaster. Although this method is convenient for practitioners to drill holes in the base for inserting metal pillars and building scaffolding, the disadvantage of using this material for the base is that the plaster mould base will be more likely to crack when increasing the number of melts, resulting in the loosening and displacement of the metal pillars above. As shown in Figure 47, when the fifth melt was undertaken, the plaster mould base already had obvious cracks, and part of the plaster had fallen off. Therefore, this method is not suitable for experiments that require multiple melts.



*Figure 47. Plaster mould base presented a degree of cracking after the fifth melt.*

After completing the first experiment of the plaster mould-drilling hole method, the second experiment built on the lessons from E8. In Experiment 9 (E9), the silver spheres were made by using the granulation technique mentioned in the previous section. The shape of the silver spheres was changed from hemispherical to spherical to increase the contact area between the enamel and the silver spheres. Again, using green transparent enamel from China, the enamel connected the five silver spheres after three melts. However, the enamel connecting part failed to separate from the metal pillars below (Figure 48).



*Figure 48. The result of Experiment 2.*

Experiments E8 and E9 were conducted at the second experimental phase. Initial data was collected with data collection sheet and making experience was accumulated during this phase. Moreover, drawbacks were identified when using the plaster mould drilling hole method during these two experiments. First, the method required the practitioner to use a drilling tool to drill holes in the plaster mould, but it was difficult to guarantee that the depth of the holes would be the same each time, and thus, even if the length of each metal pillar was the same, it would lead to the metal pillars being at different heights when they were placed in the plaster mould. Moreover, to allow the pillar to be inserted into the



plaster mould more smoothly, the diameter of the drilling hole should be slightly larger than the diameter of the metal pillar. However, this would lead to the problem of the pillar tilting during melting. The pillar movement will impact on the enamel connection and the accuracy of the collected data. Thirdly, it was also difficult to ensure that the drilling angle was perpendicular to the horizontal plane every time. Therefore, ensuring that all the metal pillars were at the same horizontal height, the pillars maintained a vertical relationship with the horizontal plane, and reducing the possibility of pillar movement were all issues that needed to be solved in the next experiment. E8 and E9 were seemingly simple experiments, but they involve a lot of technical problems and provided important knowledge on the relationship between the metal scaffolding and the base. These problems and knowledge may have otherwise been difficult to acquire if one had not been personally involved in the physical process (see Appendix 1: E8 and E9).

### **The second phase of the experiment: the plaster mould casting method**

According to the issues found in the previous section, a new solution namely the plaster mould casting method was proposed. One important feature of plaster powder is that when plaster powder is mixed with water, it becomes a kind of liquid plaster slip, and when the plaster slip is poured into the hollow model, a solid plaster mould is formed after the water evaporates. In the second phase of the experiment, the problem of different depths of the holes drilled in the plaster mould and the movement of the pillar were solved by using the material properties and fabrication method of plaster. In addition, the problem of the column not being perpendicular to the horizontal plane was further solved by employing the acrylic plate with holes to assist the positioning of the pillars in the later experiment. This section describes in detail the plaster mould casting method, the exploration process with reflective studio practices, and the insights achieved from the experiments.

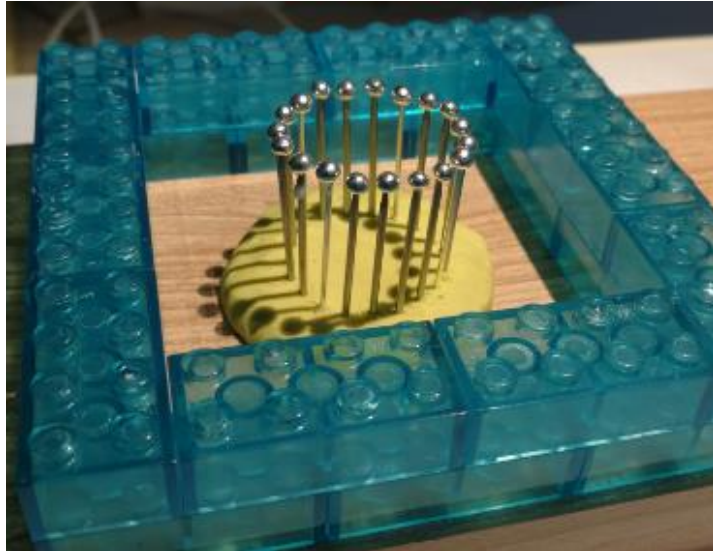
### **The aim of experiment**

The purpose of this phase of the experiment was to test the feasibility of using the plaster mould casting method to construct a scaffolding base for the MTG series and thereby provide an effective solution for constructing a stable, precising measured scaffolding base.

### **Fabrication process**

The following is an example of the production process of the plaster mould casting method, using Experiment 16 (E16) as an example. E16 is the first experiment in the MTG series using the plaster mould casting method (see Appendix 1: E16). The materials required for this experiment mainly include polymer clay, plaster powder (yellow and white), stainless steel pillar, enamels, and fine silver spheres. The experimental steps were as follows.

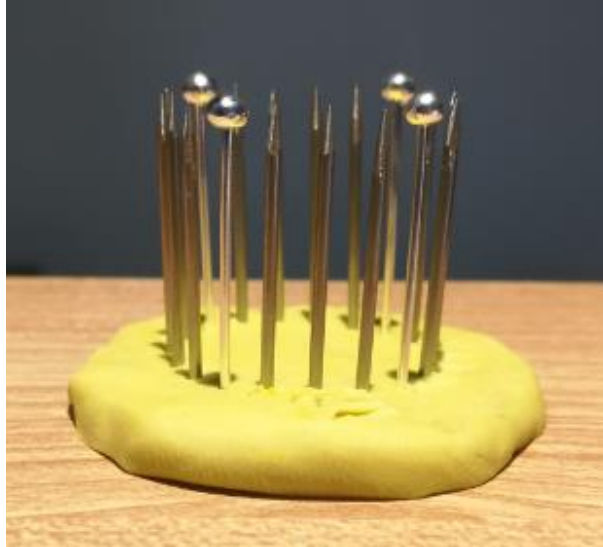
The first step was to design the test piece shape and mark the position of the metal pillars on the polymer clay block. Second, the metal pillars were placed on the polymer clay block and the silver spheres arranged on the top of the pillars in order. Third, a square container was constructed on the periphery of the model for plaster mould casting (Figure 49). Fourth, the plaster slip was constructed by adding a little water to the white plaster powder and yellow plaster powder at a ratio of 1:1. Fifth, the plaster slip was poured into the square model container and then there was a wait for the water to evaporate. Sixth, after the plaster mould was completely dry, the plastic block around the plaster mould was removed and taken off the polymer clay block at the bottom of the plaster mould. At this point, the metal scaffolding part was firmly fixed to the plaster mould. Seventh, the melting was undertaken. At the last step, the plaster mould was dissolved to reveal the enamel connecting part.



*Figure 49. Construction of a square container (interior size: length: 64mm; width: 64mm; height: 19mm) by using the plastic modules for filling plaster slips.*

### **Data collection and analysis**

Based on the previous experiments of plaster mould method, the plaster mould casting method was found to have two main advantages over the plaster mould-drilling hole method. First, the plaster mould casting method is more effective at maintaining the pillars arranged for constructing the metal scaffolding at the same height. When inserting the pillars, the polymer clay block temporarily holds the pillars in place, and the pillars pass through the block to contact the horizontal surface of the table, with the bottom of the pillars being based on the horizontal surface (Figure 50). This method enables all the aligned pillars to be on the same horizontal plane. Figure 51 shows the bottom of the metal scaffolding in the plaster mould after removing the polymer clay block.

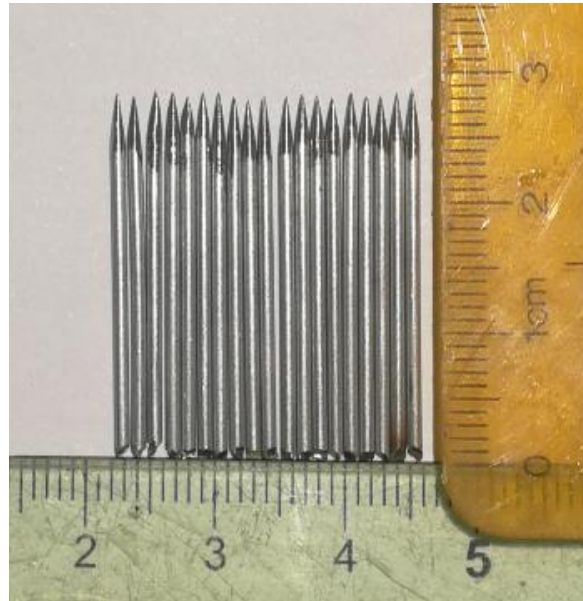


*Figure 50. Placing the metal pillars on a piece of polymer clay block.*



*Figure 51. The bottom of the metal scaffolding in the plaster mould after removing the polymer clay block.*

In this experiment, the pillars were made and cut with manual flush cutter, and the tops of the pillars were also constructed using an angle grinder to make a conical shape, which could not be easily obtained the same length (Figure 52). Therefore, the fabrication method is essential for creating pillars of the same size, which significantly influences the appearance of the scaffolding.



*Figure 52. The nineteen stainless steel pillars used in the experiment, made by hand-cutting and grinding methods.*

The second advantage of using the plaster mould casting method is that it is better for holding the metal pillars. When the plaster mould is completely dry, the metal scaffold is firmly fixed in the plaster mould. Thus, this approach is less likely to cause the scaffold to move or tilt during the process of melting. Figure 53 shows that the metal scaffolding part has been fixed in the plaster mould. After the plaster mould is fully dry, the practitioner is able to conduct the application and melting of the enamels.



*Figure 53. The metal scaffolding part is fixed in the plaster mould.*

Although using the plaster mould casting method can better solve the problem of fixing the metal pillars and keeping the pillars at the same horizontal height, unfortunately, the results of Experiment 16 was that the enamels did not join the silver spheres successfully, and the problem of the pillars being perpendicular to the horizontal plane was not effectively solved (Figure 54). For this reason, I added a piece of already perforated acrylic plate used for positioning and straightening in subsequent experiments. I used Adobe Illustrator software to create a digital file and a CNC drilling machine to accurately drill holes in the acrylic plate. The use of this acrylic plate aided the placement of the pillars to ensure that they were perpendicular to the horizontal plane and determine the position of the pillars more precisely.



*Figure 54. Splitting and dissolution of the base plaster mould after adding water (left); fracture of the enamel part (right).*

It should be noted that during the experiment of the plaster mould casting method, another method was also investigated, the plaster mould casting-2 method. Take Experiment 28 as an example. The difference between the plaster mould casting-2 method and the previous is the order in which the paste of plaster was poured to fix the metal pillar. Previously, in Experiment 16 the metal pillars were fixed on the polymer clay block first and then the paste of plaster was poured into the container to fix the metal pillars. In contrast, the

method of Experiment 28 was first to fill the container with paste of plaster, and then flip the scaffolding that had been temporarily fixed on the polymer clay block and acrylic plate, and finally insert the container which had been filled with paste of plaster that had not yet solidified. After the water of the plaster mould fully evaporated, the metal scaffolding was fixed. Finally, the polymer clay block and acrylic plate were removed from the top of the scaffolding (Figure 55). The advantage of this method is that it is more convenient for the practitioner when removing the polymer clay and acrylic plate and reduces the impact on the plaster mould and metal scaffolding during the removal of these two auxiliary fixing materials. This represents a process of continuous technical improvement by reflective practice.



*Figure 55. Plaster mould casting method-2 fabrication process: insert the metal pillar - pour paste of plaster into the container - fill the container with paste of plaster - flip the metal scaffolding and put it into the container.*

Craft practices are closely related to material studies. Adamson (2010: 3) has stated that craft is "the application of skill and material-based knowledge to relatively small-scale production". Nimkulrat (2012: 1) similarly pointed out that "craft disciplines [...] have been understood as medium-designed" practices, the value of which are correlated with material objects and their production". This series of experiments supports the views of the two scholars above. In this series of experiments, the possibility of using plaster as a primary material for constructing a base for the MTG series of experiments was explored. In craft research, practicing with the material is critical. First, through practice, the practitioner can learn more about the properties of the material. More importantly, when the practitioner is in contact with the material, the process constantly promotes reflection and generates new knowledge. In discussing the

topic of defining "craft", Adamson (2007: 7) further emphasises that "craft is not a defined practice but a way of thinking through practices of all kinds". In my practical involvement with the plaster mould making process and material exposure, I proposed two different plaster mould making methods based on the properties of plaster, the plaster mould-drilling hole and plaster mould casting methods, to solve the problems that arise at different stages of the experiments. Although both methods used the same material-the plaster powder-the methods of using this material to make the mould were different because different problems were encountered. It is a process of continuous dialogue with the material, and thinking and exploration in craft practice.

#### **4.2.2.2 Soldering block as foundation**

In experimenting with the materials that might be suitable for metal scaffold bases, in addition to plaster moulds, the soldering block was also investigated and several experiments conducted (see Appendix 1: E10, E11, E12, E15). The soldering block is an asbestos substitute material with low thermal conductivity, a fireproof material that fixes the metal post better during the firing process than the plaster mould and does not crack even after firing many times.

#### **Fabrication process**

The method of making a soldering block as a base is similar to the previous method using perforated plaster mould. The scaffolding is first applied on the soldering block. Then a micromotor hammer is used to make holes according to the pattern. Once the metal pillars and spheres have been assembled on the soldering block, enamels can be applied and melted. After all the spheres have been joined by the enamel, the complete enamelled piece can be separated from the scaffold (Figure 56).





*Figure 56. The production process of Experiment 12 (1. making holes in the soldering block - 2. assembling the scaffold - 3. applying and melting the enamel - 4. separating the enamel pieces from the scaffold).*

### **Data collection and analysis**

Experiment 10 was the first experiment in this study that successfully obtained a complete enamel piece using a soldering block (Figure 57). Experiment 12 was an attempt at a new shape and resulted in a complete enamelled piece (a single row structure of square shape) (Figure 58). After accumulating some practical experience, I began to experiment with more complex shapes for testing. The test piece for Experiment 15 was a three-layered concentric circle structure consisting of 46 spheres, with 11 kinds of enamel as the material. After several firings, each circle of spheres was linked by enamel and there were 4-5 connecting points between the circles (Figure 59). However, when attempting to separate the enamelled pieces from the scaffold, it was found to be impossible to separate them. From the experimental results, it is clear that, firstly, the more complex the structure, the more difficult it becomes to separate the enamel pieces from the scaffold. Secondly, unlike a plaster mould, the soldering block is an insoluble material and it is impossible to dismantle the scaffold by soaking it in water. Thirdly, the imprecision of the metal scaffold results in experiments that do not result in a regular concentric shape.

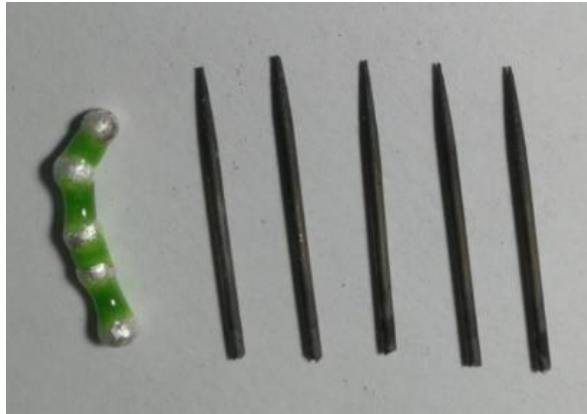


Figure 57. The result of Experiment 10 (the enamel piece and stainless pillars).



Figure 58. The outcome of Experiment 12, L: 1.5cm, W: 1.5cm.



Figure 59. Top view (left), front view (right) of the test piece in Experiment 15.

Whether using a plaster mould or soldering block, the construction of the metal scaffolding at this stage is mainly undertaken by hand, which makes it

impossible to obtain precise scaffolding or collect accurate data. Therefore, the construction of accurate scaffolding becomes an important issue to be addressed during the next phase.

### **4.3 Material testing phase 3: embedding digital technology**

With the rapid advancement of the digital age, digital technology is now widely applied in different fields and in all aspects of people's lives. In the research of traditional crafts, the combined application of digital technology and traditional craft is nothing new, and can be used to promote the development of traditional crafts. There is a general desire to revitalise traditional crafts by utilising digital technology so that these valuable traditional techniques can be adapted to new environments. One of the significant changes that digital technology has brought to traditional crafts is the ability to assist in the production of handicraft products that are more precise and which provide the opportunity to explore a new visual language. In the previous phase of this research, experiments initially tested the concept of using enamel as a bonding agent integrated with metal scaffolding designs, to create new methods for making enamel. However, the main shortcoming of these experiments was related to the construction of metal scaffolding, which was mainly made by manual fabrication. Thus, it proved difficult to create precise and regular shapes and obtain accurate data with respect to the connecting distance of the enamel.

Therefore, two new modern technologies were introduced into the current phase of experiments, selective laser melting (SLM) technology and resistance welding, in the hope that the use of advanced digital technologies would enable accurate data to be obtained and precise experimental samples to be produced. This section focuses on the application of digital technology in the study of

plique-à-jour innovations in the traditional enamel process, with is related to Research Question 1 and Research Aim 1. The section begins with an introduction to the application of SLM technology to enamel connecting distance experiments, followed by an initial exploration that applies this technology. The possibility of constructing metallic supporting parts through resistance welding and enamel bridges is tested, with comparisons made between three methods of scaffolding construction- soldering block, SLM, and resistance welding. Finally, this section discusses the contribution that basic scientific research and the application of digital technology can make to traditional process innovation while presenting new findings.

### **4.3.1 Constructing the scaffolding: technology 1- selective laser melting**

#### **4.3.1.1 Connecting distance test**

Understanding the precise parameters of the physical gap between metal spheres is significant as it is a critical factor for designing and making the MTG series. Experiments in this section aimed to test the connecting distance between two silver spheres and collect basic data. From the visual point of view, the form of the initial results was irregular, mainly because the silver scaffolding and the spheres were hand-made. Thus, approaches to produce a regular-shaped MTG sample became the priority in this phase. Previous experiments demonstrated that the shape of the enamel work relies on the design and construction of the metal scaffold underneath, the precision of which determines the visual effect of the final outcome to a large extent. To design and construct a viable metal scaffold, it was first necessary to test the physical distance between the two spheres that the enamel can bridge, based on the

physical properties of the enamel. This basic experimental data could then provide important support when exploring different forms of larger scale at a later stage.

To obtain accurate data and construct precise scaffold for the MTG series of experiments, the SLM technology was first used during this phase. In the field of metal and jewellery processing, 3D printing technology is now well established as offering more effective technical support to craft designers. SLM, a direct metal printing technology, was created in 1995 and started to be applied commercially in 2000. In recent years, there has been increasing research into SLM in the jewellery sector, which has attracted the attention of designers and practitioners. Compared to the traditional investment casting process, SLM technology is not as good as the direct casting process in terms of material costs and mass production, but can eliminate many steps of the casting process, can be shaped quickly, and ensure highly precise products. The designer simply creates the CAD file and imports it into the SLM printing machine, then obtains the printing result in a convenient way. Traditionally, the metal body production processes for metal-based enamel wares were mainly forging, piercing, and casting, while there is a gap in the application and related research of SLM technology in the field of enamel. One of the technological innovations in this research is the application of SLM technology to the traditional plique-à-jour innovation, which suggest greater geometric freedom for metal body production of metal-based enamel works, and provides support for precise construction, data collection, and exploration of metal scaffold in the MTG series of experiments.

As previously described, in the MTG series of experiments, the distance between the two spheres across which the enamel can bridge is the most important factor (Figure 60). In this section, Experiment 22 (E22) and

Experiment 23 (E23) are the two examples for describing the tests of bridging distance in different conditions. E22 is the testing of different distances between two silver spheres in the same horizontal direction, and E23 is the testing of the connecting distance between two silver spheres at the same parallel distance and different height differences. The following describes the methods and data collection process for these two basic experiments.

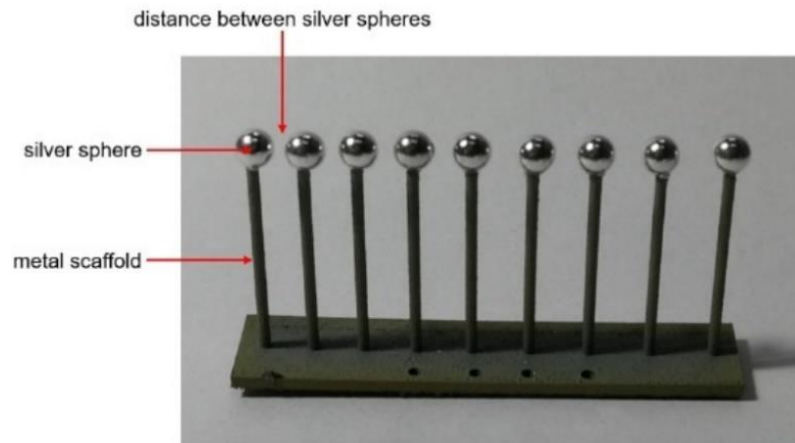


Figure 60. The distance between spheres of Experiment 22.

### **Test Group 1: test with the same horizontal orientation with different distances (E22)**

The purpose of the Experiment 22 was to test the distance between two silver spheres that could be connected by the enamel at the same horizontal direction. In this experiment, vitreous enamel S40 (transparent green) from Japan was used. Nine silver spheres with a diameter of 3.2mm were produced by direct investment casting technology and hand drilling method. The metal scaffold part was made by SLM technology.

### **CAD model**

The CAD model of E22 was created by using Rhino software, with the following parameters: the height and the diameter of the pillars were 19.80mm and 1.00mm respectively. The distance between two pillars was applied in increments of 0.20mm horizontally. There are nine pillars in total, with eight

distances, of G1: 4.00mm; G2: 4.20mm; G3: 4.40mm; G4: 4.60mm; G5: 4.80mm; G6: 5.00mm; G7: 5.20mm; and G8: 5.40mm. The top of the pillar was tapered so that the silver sphere could be removed from the scaffolding after the enamel firing (Figure 61).

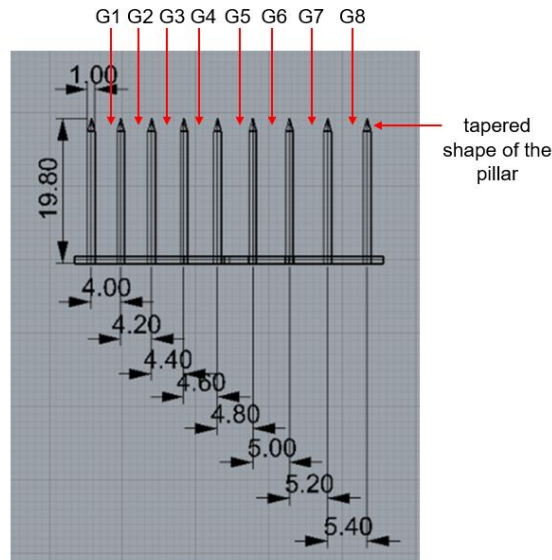


Figure 61. CAD file for the test of the horizontal connecting distance.

### Fabrication process

After being created, the CAD file was printed using the SLM printer. Once the print had been completed, the printed support structure of the scaffold was cut away by using flush cutters on a stainless-steel base and then it was polished (Figure 62). The second step was to place the silver spheres onto the top of each pillar. Thirdly, enamels was applied between the silver spheres and then melted until all 9 silver spheres were linked by the enamel. In the fourth step, the enamel piece was separated from the metal scaffold.

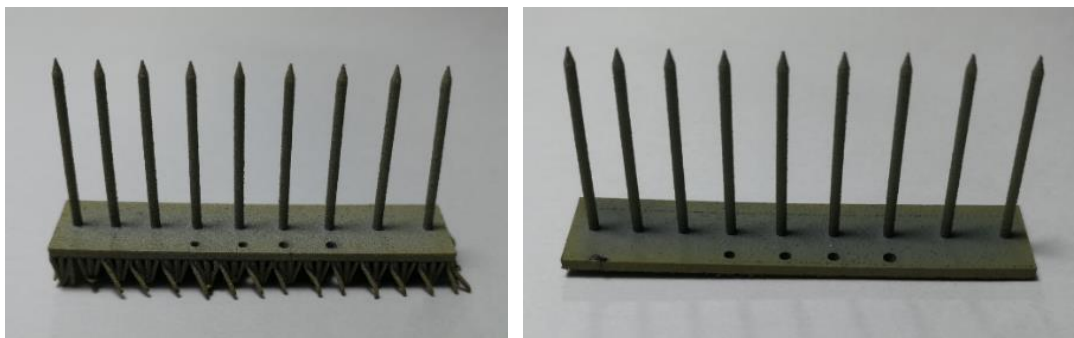
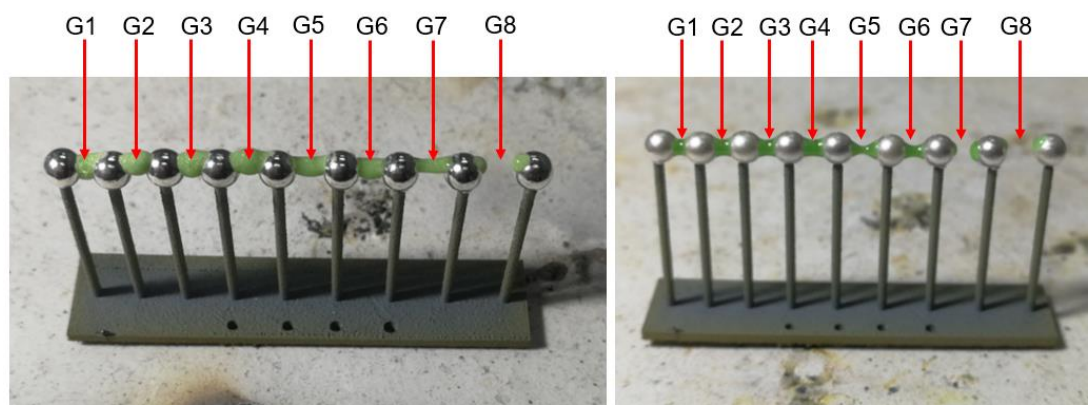


Figure 62. Before cutting the support structure (left); after cutting the support structure (right).

## Data collection and analysis

In E22, four times of melting the enamels were required to connect nine silver spheres. After removing the scaffold, a complete enamel piece was obtained successfully. This experiment demonstrated that methods to bridge the two silver spheres that were at a greater distance from each other represented the more difficulty. In the applying and melting process, G8 was too far apart to fill the enamel in one attempt during the first melting, while G7 barely bridged the enamel between the two silver spheres (Figure 63). Shrinkage after melting at high temperatures is a common physical property of enamel. The experiments revealed that after the first melting, the testing piece was filled with enamel at distances G1 to G6 and the silver spheres were connected. In contrast, for the distances G7 and G8 only part of the enamel melted on the surface of the silver spheres on either side. And then a second enamel application was implemented to fill the enamel in G7 and G8 to enhance their linkage. The results of the second melting were that all the gaps were bridged apart from G8. After two more firings, the nine silver spheres were successfully connected by the enamel (Figure 64).

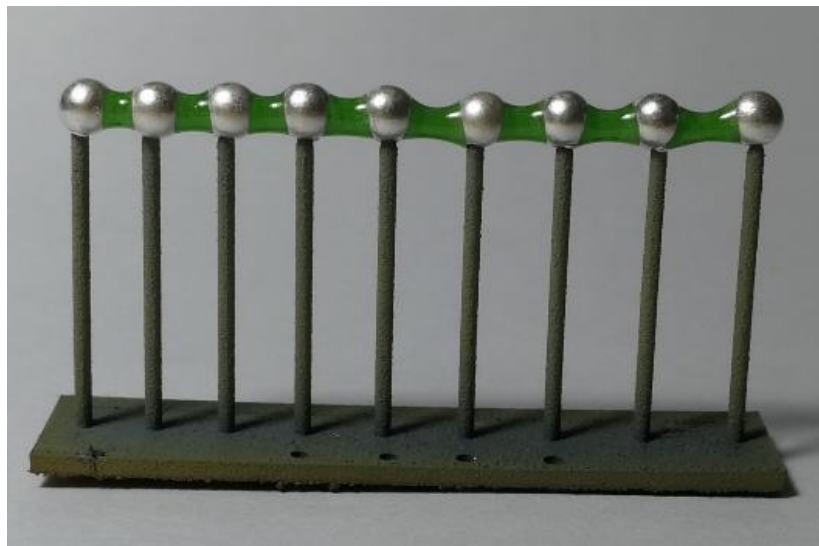


*Figure 63. First application of enamel (left); first melting of enamel (right).*

The results of this experiment revealed that the larger the distance between the gaps, the more applying and melting of the enamel was required, as the glass



shrinks to a certain extent after firing. However, there is a limit to the connectable distance of the enamel. According to the experimental results, the enamel in G8 shows a partial drop due to the larger connectable distance. Another factor to be considered is the time of firing because when the enamel is fired, it flows and shrinks. The longer the firing time, the more likely the glass will drop, which will adhere to the pillar below, making it impossible to eventually separate the enamel connecting part from the metal scaffold. In this experiment, each firing time was between 2 minutes 50 seconds and 3 minutes to control the flow of the glass, thus avoiding adhesion to the metal support below.



*Figure 64. The testing piece of the fourth melting.*

### **Test group 2: height difference test experiment (E23)**

The objective of Experiment 23 was to test the possibility of linkage between two silver spheres with a height difference. The materials used in this experiment included -Japanese enamel S40 (transparent green), and 6 silver spheres made of fine silver with a 3.2 mm diameter. Direct investment casting was the process used to make the silver spheres, and the holes on the bottom side of the spheres were drilled by CNC drilling machine. SLM was used to create the metal scaffold.

## CAD model

The design parameters of the CAD file for the metal scaffold were as follows: the same base plate was divided into three groups. Each group had the same distance between the two pillars of 4.20 mm. The height of the pillars on the left of each group was 19.80 mm, while the difference in height between the two pillars of each group was increased in 0.5 mm increments. The parameters of the pillar height for the three groups were as follows: Group 1 (P1 - 19.80mm, P2 - 20.80mm); Group 2 (P1 - 19.80mm, P2 - 21.30mm); and Group 3 (P1 - 19.80mm, P2 - 21.80mm) (Figure 65).

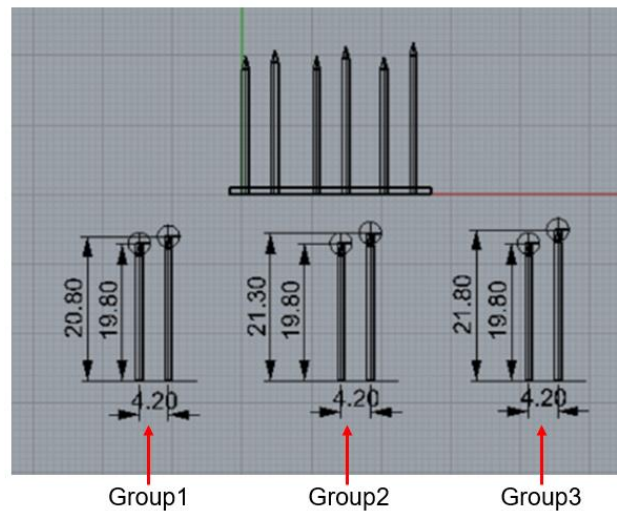


Figure 65. CAD file of the scaffolding for Experiment 23.

## Fabrication process

After obtaining the metal scaffolding, the six silver spheres were placed on the top of each pillar, and the enamels were then applied and melted for twice. Each firing lasted 3 minutes and the temperature increased from 825 to 840°C. Once the enamel connected the silver spheres, the enamel piece was separated from the metal scaffolding.

## Data collection and analysis

The results of the above three sets of experiments show that the enamel can bridge two silver spheres over a range of height differences. The data and

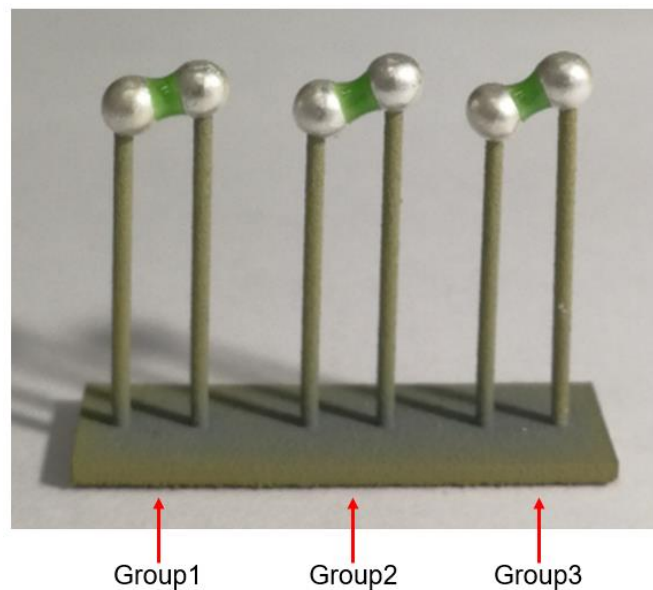
making knowledge from this basic experiment provides an important foundation for the later design and production of shapes with curved variations. The most valuable making experience accumulated from this test is the approach of connecting two metal spheres at different heights with enamels. Due to the effect of gravity, the enamel tends to flow to the bottom of the higher sphere when melted. Thus, the challenge of this experiment was that the greater the height difference between the two spheres at equal distances in the same horizontal direction, the more difficult it was to apply and melt the enamel. In addition, the enamel is fluid and when fired, the enamel tended to adhere to the pillar below, making it impossible to separate the enamel connecting part from the metal scaffold below. This is a common problem in MTG series experiments, which arose in the initial period of Experiment 11 (E11), in which one of the metal pillars below stuck due to the flow of the enamel (Figure 66). In light of the experience of E11, this problem was avoided in this experiment. The two experiments E22 and E23 discussed in this section showed that it is more difficult to connect two silver spheres with a difference in height than to link two spheres at the same horizontal height. The amount and moisture of the enamel applied, viscosity of the enamel, grit size of the enamel, the firing temperature, and time should be taken into consideration coherently.



*Figure 66. The outcome of Experiment 11: one of the supporting pillars is attached to the enamel.*

Three groups of models were tested in this experiment (E23) and the following

data were obtained: the horizontal distance between the two silver spheres of the three groups was 4.20 mm, with a height difference of 1.00 mm, 1.50 mm and 2.00 mm respectively. The results revealed that the two silver spheres could be connected by the enamel bridging technique (Figure 67). In comparison to E22, the height difference was added as a variable in this experiment. The horizontal distance between the two spheres and their height difference, as two important variables in distance testing, were initially tested in this experiment. However, due to the time frame of this research, there are still many possibilities that can be further examined, such as the greater horizontal distance and height difference, as well as the diameter of the spheres as a variable to be considered. Nevertheless, these basic experiments will build up a richer knowledge base from which to support the exploration of more diverse morphologies in the future.



*Figure 67. The testing piece for the Experiment 23.*

#### **4.3.1.2 Exploration of basic form**

Based on the data and production experience gained in E22 and E23, these data were used to explore simple forms. Three primary forms were tested during this experiment phase: the quadrilateral, the arch, and the triangular

body. All three experiments resulted in the enamel connecting part separating smoothly from the metal support underneath, and in unexpected gains and discoveries. The quadrilateral experiment resulted in a well-shaped square enamel connecting part. The arched bridge experiment created a new and challenging structural form for the enamel bridging. While the triangular body experiment revealed a new phenomenon of the flowing of the enamel.

### **The quadrilateral experiment**

With the aim of producing an accurately-shaped square enamel piece by SLM technology, the Experiment 19 (E19) applied the metallic scaffolding of sterling silver consisting of 12 pillars of 25.0mm height, each being spaced 4.0mm apart. Silver spheres were placed on top of each pillar of the printed SLM metal scaffolding, followed by applying and melting the enamels. The experiment melted twice and connected 12 silver spheres, and revealed that the advantage of SLM technology is its ability to produce a highly accurate model of the metal part. This model makes it possible to arrange the 12 silver spheres easily and precisely in a regular quadrangle, and provides the necessary foundation for producing a regular quadrangle of enamel for connecting at a later stage (Figure 68).



*Figure 68. Before applying the enamels, the spheres were placed on the metal scaffolding (left); after two firings, the silver spheres were connected (right).*

As described above, the metal scaffold determines the form and regularity of the enamel piece. When these parameters—the size of the metallic scaffolding and the diameter of the silver sphere—are precise, the experimental results seem to become predictable. However, in the constant quest for accurate results, some uncertainties were found in the test pieces, the most essential of which was the enamel part. As the process of applying enamel is by hand, different portions of enamel were applied each time by spatula, and the melting temperatures and times were different. These factors caused the enamel to form a different shape between the two silver spheres, either thicker or finer, sometimes with more enamel covering the surface of the silver sphere, sometimes with less. Figure 69 (left) shows the effect of the first application, with G1 blue enamel (S49) more than the yellow enamel (S27) of G3. As a result, the first melt demonstrates that the enamel forms a thicker shape in G1 than in G3 (Figure 69: right). It is this part of the handwork that renders each MTG experiment with its own unique effect, which confirms what David Pye in his book *The Nature of Art of Workmanship* calls "the workmanship of risk" (1968: 20). He gives an interesting example of writing with a pen as the workmanship of risk and modern printing technology as 'the workmanship of certainty'. But he also points out that there is also a hybrid production method including both certainty and risk, and calls this method "craft-based industries" (1968: 22). While there has been a general concern that the application of digital technology may take away from the diversity or spontaneity of craft creation (Nimkulrat, et al., 2016; Zoran and Buechley, 2013), I am not worried about it. As the square experiment of MTG reveals, craft retains its irreplaceable value even when digital technology is applied to the production process. Based on Pye's theory, the MTG experiment is located securely within craft-based industry, with the certainty that comes with digital SLM production and the risk that comes with firing enamel, which ensures aesthetic richness and the

demand for individuality in modern craft creation.

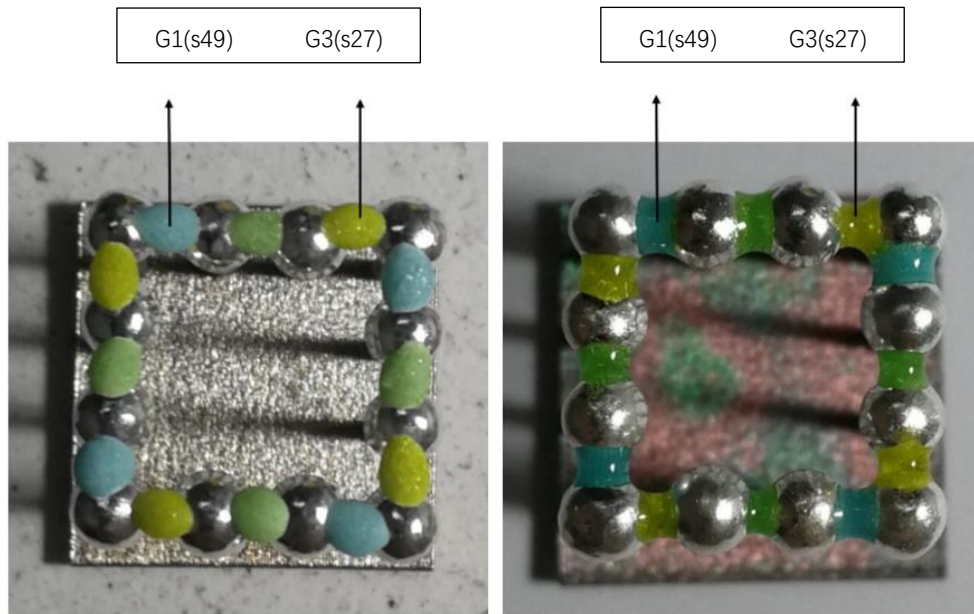


Figure 69. The effect after the first application (left); the impact after the first melt (right).

### Arched bridge experiment

Based on the data from E23, Experiment 24 (E24) was the first attempt to produce an enamel connecting part with curves. The total span of the arched bridge metal frame model is 28.0 mm long, and the difference in height between the two apexes of the highest pillar and the lowest one is 5.38 mm (Figure 70).

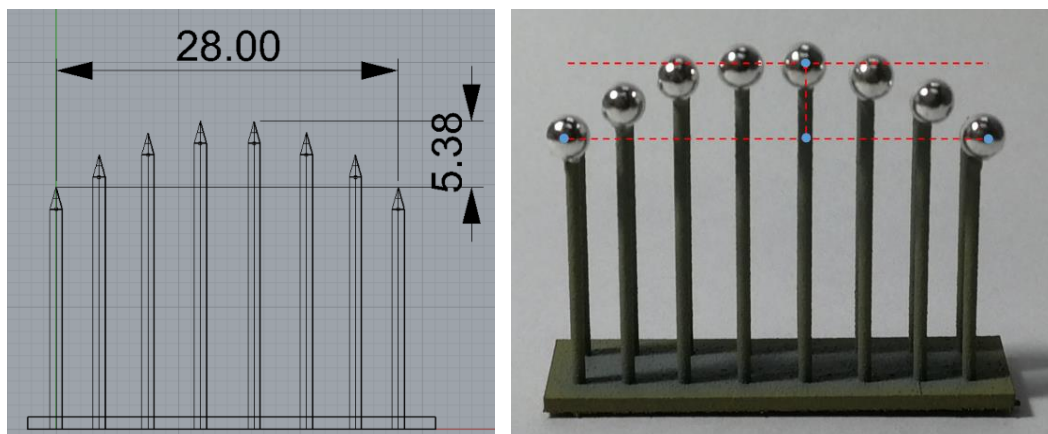
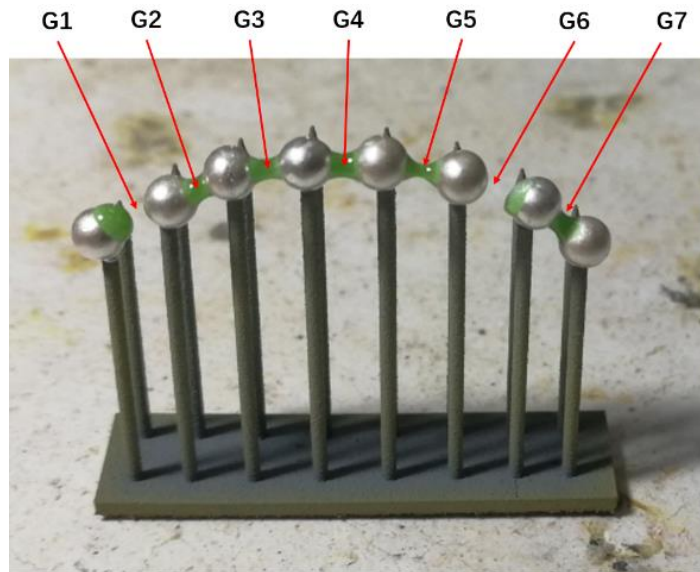


Figure 70. CAD file for the rainbow bridge experiment and its parameter (left); eight silver spheres were placed on the arched bridge metal scaffolding (right).

In E24, after the first melt, the enamel did not complete the silver spheres

connection due to the contraction of the enamel at the two bridging points, G1 and G6 (Figure 71). Eight silver spheres were connected after three melts. The rainbow bridge experiment is an exciting adventure, after which I was amazed to discover that the arched bridge structure can be created (Figure 72) by connecting the enamel with the silver spheres in an orderly manner based on the design of the base holder. The perception of enamel used to be that enameled pieces without the support of a body were fragile (Ostoya, 1945). In traditional plique-à-jour, the enamel is applied to a metal frame as a decorative material. Although it is more delicate than enameled varieties with a metal body such as cloisonné, the plique-à-jour enamel is protected and supported by a metal frame around it. In this experiment, however, the enamel connects the silver spheres and supports the entire structure. Thus, enameled pieces of such a structure are undoubtedly fragile. Indeed, it is a challenging experiment and the first time that such a structure of enameled connection and visual effect has been created. In the field of product design, Veryzer calls for "radical innovation" or "discontinuous innovation", which requires "dramatic departures from existent products or their logical extensions", an essential factor in making new products competitive (1998: 306). Consider the existing view that enameled pieces without a metallic substrate are fragile. In that case, the most critical insight from the rainbow bridge experiment is not to stop attempting new things because of this inherent perception. Indeed, perhaps I have made the seemingly impossible possible by making the fragile features of enamel work more vulnerable.





*Figure 71. The test piece after the first melt.*



*Figure 72. The finished enamel piece.*

### **The triangular prism form test**

The triangular prism form test was another significant experiment for exploring basic shapes. This experiment (E25) aimed to test the connection between separated main components with a height difference in one model. Compared to the previous two experiments: the quadrangle and the arched bridge, both of which were single structures, the triangular shape is a more complex combined structural exploration. The design parameters of the triangular body model refer to the data from the previous height difference experiments. This triangular body model consists of three rows of pillars with five pillars in each row. The

height of the pillars is 21.30mm in the middle row, 19.80mm in the left and right row, and the height difference between the left and right rows and the middle row is 1.50mm (Figure 73). The metal holder for this experiment applies SLM technology, while the silver pillars are drilled by using a manual method, with 15 silver spheres neatly arranged on the metal scaffold (Figure 74). Six firings were made to bridge 15 silver spheres in this experiment.

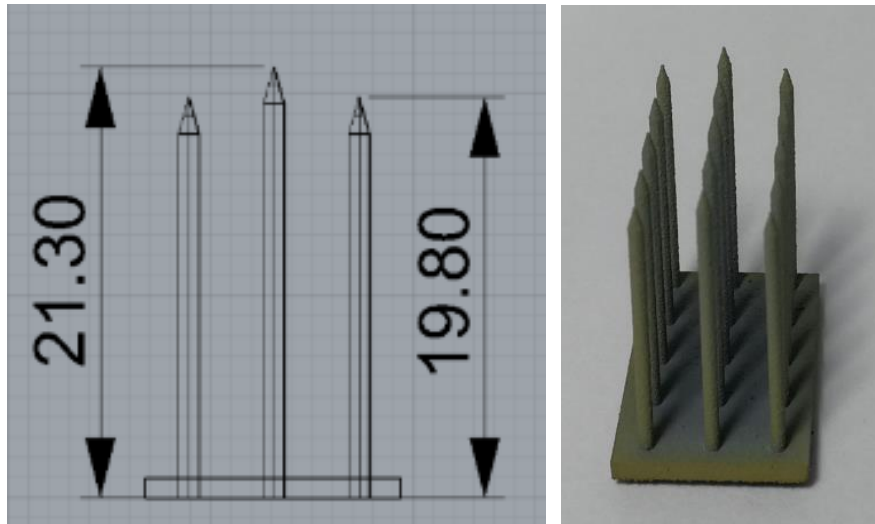


Figure 73. CAD file for the experiment and its parameters (left); the metal scaffolding was manufactured by SLM (right).



Figure 74. 15 silver spheres neatly arranged on the metal scaffolding.

The experiment results show that the purple enamel S76 flowed obviously in two positions on the test piece. Firstly, after melting four times, the shape formed by the flow and contraction of the enamel became very thin at the joint between the middle row (Line A) and the right row (Line B), i.e., between two silver spheres, A1 and B1. Most purple enamel S76 flowed onto the blue enamel S58 between B1 and B2 (Figure 75: Line A-B-G1). Secondly, the same situation occurred at the other end of the test piece. The purple enamel S76 between silver spheres A4 and A5 (Line A-G5) flowed onto the blue-green enamel S49 between silver spheres A5 and B5 (Line A-B-G2). This test piece also shows that the purple enamel S76 at Line B-G3 and Line C-G2 contracts after melting to form a similar shape to other enamels, without drastic shape changes (Figure 75).

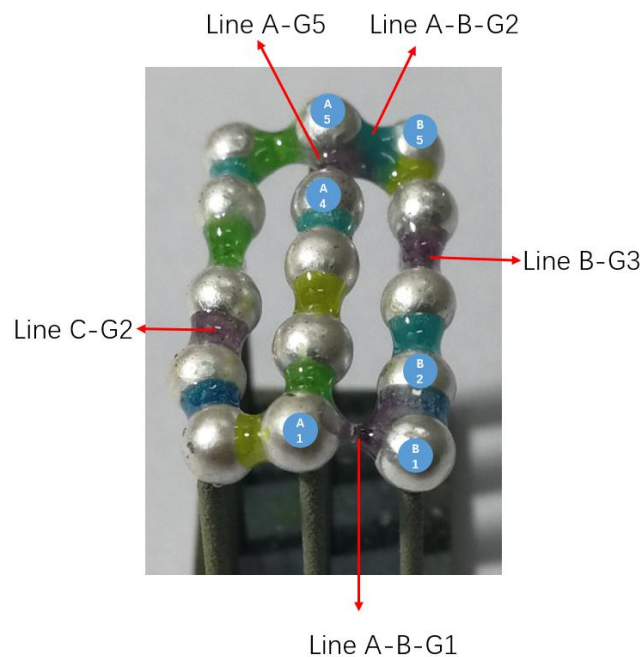


Figure 75. The test piece after the fourth melt.

A new finding in this experiment is that the effect of enamel flow may be related to the structural design. The experimental results reveal that the two sites (Line A-B-G1, Line A-G5) where the flow of the purple enamel S76 is evident are both triangular structures formed by three silver spheres. In contrast, purple enamel S76 melts at Line C-G2 and Line B-G3 in similar to the other enamels. The

structure at these two sites is a linear system formed by two silver spheres in the same line (Figure 76). Therefore, the different structures may be an essential factor in the different flow results of the enamels. Looking at the two sites (Line A-B-G1, Line A-G5), not only does it produce a different visual effect from the enamel in the other sites, but more importantly, the thinning joint of the enamel is more prone to breakage and does not form a complete piece. It raises the rethink of the structure's design to suit the material's physical properties.

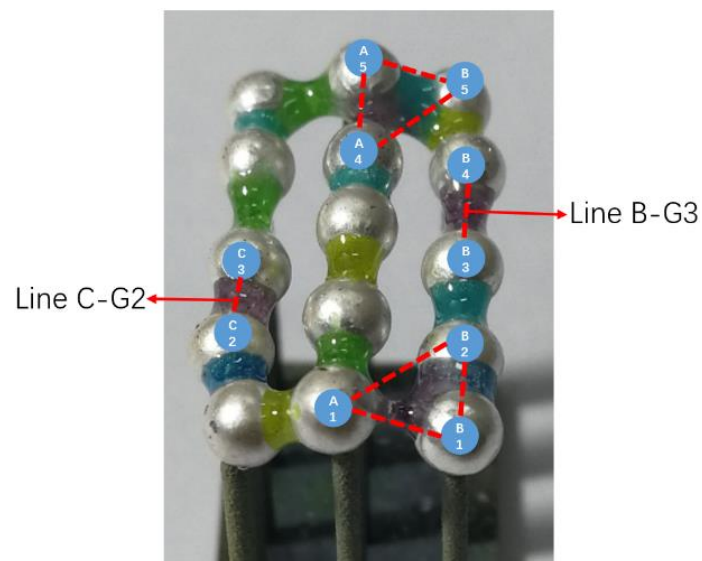


Figure 76. Two structures created by arranging silver spheres on a metal scaffold.

As many scholars describe, craft is associated with materials (Adamson, 2007; Risatti, 2007). Some scholars in the field of craft focus on the cultural meaning of the material (Porter and Rosser-Owen, 2012; Moran and O'Brien, 2014; Jansen, 2016), while some craft artists concentrate on the unique texture of the material and apply it to the creation of artworks (Hartung, 1965; Kapp et al., 1987). However, I believe that in the actual process of craft making, the perception of the material's physical properties is sometimes more crucial than the visual effects of the material, such as colour and texture. As Wang and Pan (2008: 1) stated that having a deep understanding of the properties of material is essential "not only to analysis and optimisation of material performance, but also to new material design". The experiment proves that only a profound

understanding of enamel fluidity can reveal which structures are feasible and which are prone to fracture. The adjustment of the structural design prompted by the physical properties of the material exemplifies the significance of material cognition in the practice of the process, while understanding is often gained through actual practice.

The three experiments (E19, E24, E25) above represent the initial stages of modeling exploration by SLM technology based on initial material testing. Compared to the early material testing phase, the metal support models for these three experiments became more complex, thus creating new forms of enamel bridging, identifying new problems and gaining new insights. The critical point is that the material property triggers thought about design and craft practice. The rainbow bridge experiment represents a breakthrough in the original perception of materials, and a challenge to the limits of materials. Perhaps, new possibilities are born when challenging traditional perceptions. The triangular body experiment is an adaptation to the material because the structure needs to be designed according to the material properties (Khouli et al., 2015). Though it can also be seen as a compromise to the material, it is better to regard it with respect to the material's original properties, which ultimately results in learning how to strike a balance between material and design.

#### **4.3.2 Constructing the scaffolding: technology 2 - resistance welding**

After applying the plaster mould and soldering block as the base to build the metal scaffoldings, metal bases were made through resistance spot welding, another modern processing technology. The following section demonstrates the aims, manufacturing process, data collection undertaken as part of the

Experiment 14 (E14), and also examines the pros and cons of resistance welding applied to MTG series experiments.

This experiment (E14) aims to identify selective manufacturing methods used to build precise metal scaffold aside from the SLM technology method. Resistance spot welding applies pressure to the electrode and generates resistance heat through the contact surface of the joint using electric current. Resistance spot welding is one kind of resistance welding technologies. Other methods include, seam welding, projection welding, flash welding and upset welding. Resistance welding technology is mainly used in the modern industrial manufacturing field.

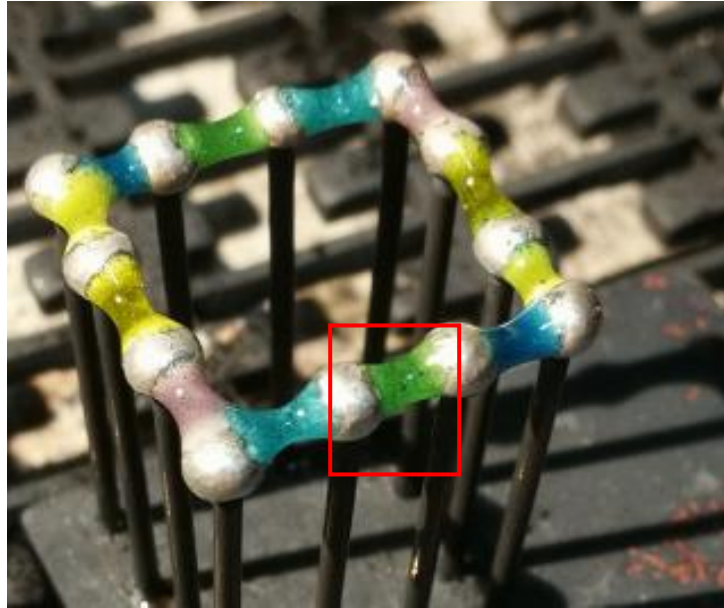
### **Fabrication process**

This experiment examines the feasibility of making a precise and square enamel piece with the assistance of resistance spot welding technology. This technology is applied to build the scaffolding part, which is composed of 12 stainless steel pillars 1.0mm in diameter and 25.0mm in height, and sheet copper with thickness of 1.0mm (Figure 77). First, a square with a side length of 15.0mm was accurately drawn on the copper plate. Then, the position of 12 pillars were marked based on a 4.0mm interval between two columns. Next, the holes are drilled manually in the copper plate, and finally the pillars were welded to it quickly and accurately through resistance spot welding technology. The next step was the same as the previous experiment: 12 silver spheres (with holes drilled on the back) were placed on the top of the metal pillar in turn, and then the enamel was applied. After firing 6 times, all the silver spheres were connected. Finally, the enamel connecting part was successfully separated from the metal scaffolding.



*Figure 77. A scaffolding part created by resistance spot welding technology.*

There were three main findings from this experiment. First of all, this experiment demonstrates the feasibility of adopting resistance spot welding technology to make metal scaffold in a MTG series of experiments. The benefit of this technology is that precise metal scaffolds can be quickly fabricated to assist the MTG series of experiments, with lower production costs and equipment requirements than SLM technology. Secondly, there were some difficulties with this technology. Although resistance welding technology can be used to accurately locate pillars on the metal plate, and quickly weld them, the method of installing each pillar on the copper plate of the base plate is still by hand. Therefore, it is difficult to ensure that each pillar is perpendicular to the base of copper plate, leading to different interval distances for each pair of pillars at the top. In addition, if the practitioner applies overcurrent or too much pressure during the operation, it can melt the metal part that is to be welded or burn a hole in the thin sheet of metal. Thus, this technology requires a great deal of practice to become proficient at controlling the level of current and pressure required to weld different metal parts. The final discovery from this experiment is that, the copper oxide produced after high temperature firing the copper plate can easily form some black specks on the surface of the enamel part, influencing the appearance of the enamel piece (Figure 78). Thus, copper is not a proper metal to make scaffolding for the MTG series.



*Figure 78. The copper plate formed copper oxide that contaminates the surface of the enamel part.*

### **4.3.3 Comparison of the methods of making scaffolding**

After the test of building metal scaffolding through resistance welding technology in MTG series of experiments, the previous three approaches to build and make scaffolding, namely the soldering block method, resistance welding method, and SLM method are compared.

Each method of production has its own advantages and limitations. In the following section, the respective advantages and disadvantages of each of the three methods is considered, as well as some findings and insights from the comparison based on five aspects, these being: the method of creating scaffolding; the ability to separate enamel work from scaffolding; the precise effect of the experimental results; the size of the possible enamel piece; and the influence of the materials used on the enamel firing in different methods.

Firstly, from the perspective of the convenience of the forming method and the cost of equipment, it is practical to use a soldering block as the material for the



base to build the scaffolding part. Compared to resistance welding and SLM technology, the method of soldering block construction of scaffolding is less demanding in terms of hardware equipment than resistance welding and SLM technology, as this approach only requires a soldering block and simple drilling equipment such as a hand drill. As a result, with low production costs, soldering block construction of the scaffolding is easy to implement in the studio without relying on expensive equipment.

Secondly, in terms of workability in dismantling the scaffold, it is easier using the soldering block method to separate the enamel piece from the metal scaffold than resistance welding and SLM technology. This is because in the base section of the metal scaffold constructed by this method, the connection between the metal pillar and the soldering block is not fixed or integral. As Figure 79 reveals, after the melting of the test piece, the metal support inserted in the plasterboard is movable, so that the enamel connecting part can easily be separated from the base in Experiment 12. In the case of the metal scaffolding part being made by resistance welding, the relationship between the metal pillar and the metal base is fixed, while the scaffolding part made by SLM is made in one piece (Figure 80). However, the enamel connecting part is very fragile and it is therefore a great technical challenge to separate the fragile enamel piece from a fixed metal support base, as the increase in force can cause the enamel part to break at any time. It follows that the soldering block method is a more favourable approach for the separation of the enamel piece from the metal base.



*Figure 79. Soldering block method: Metal pillars on soldering block are movable when the test piece is a simple structure (Experiment 12).*

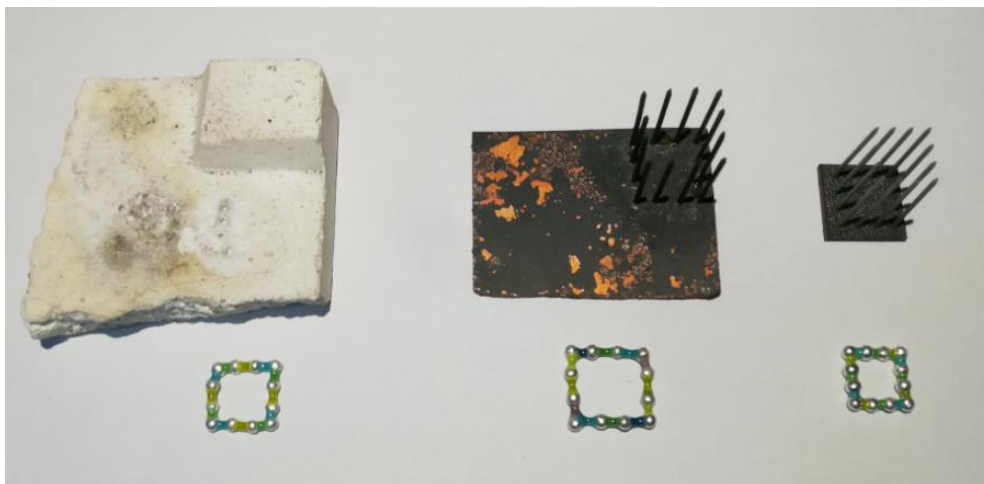


*Figure 80. Metal scaffolding applied resistance welding method (left) and metal scaffolding applied SLM technology (right).*

Thirdly, the soldering block method has advantages and disadvantages. On the one hand, the soldering block method facilitates the removal of the metal scaffolds to obtain the complete enamel connecting part. On the other hand, the disadvantage of the soldering block method, is that it is difficult to grasp the depth of the holes drilled in the soldering block and the perpendicularity of the metal pillars to the soldering block, which results in different heights and distances between each pillar, making it hard to obtain an accurate enamel

connecting part. This issue may be overcome by using a soldering block with a regular and flat surface, and a pillar drill with a “stop” on the drill bit. Compared to the soldering block, the resistance welding method produces more accurate enamel piece than the soldering block method, and the SLM method produces the most accurate enamel piece among the three experimental results. As can be seen in Figure 81, the enamel connecting part applied SLM method has equal spacing between the silver spheres and are squarer than compared with the other two experimental results (the soldering block method and the resistance welding method).

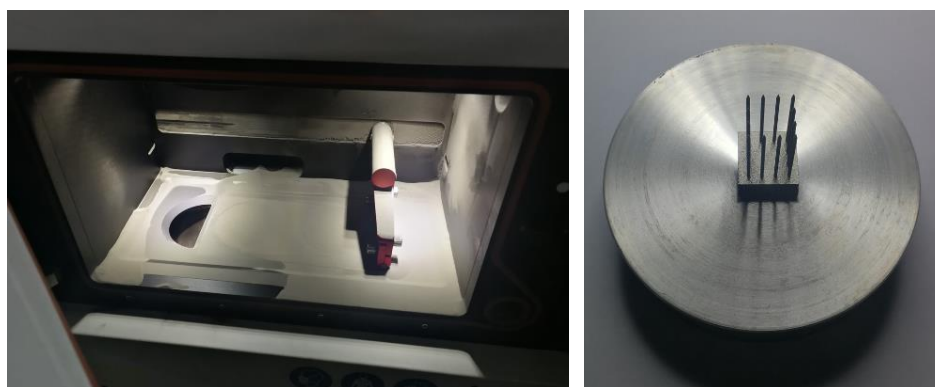
The precision of the metal support determines the accuracy of the results of the enamel piece. The method of making the bases of the metal scaffolds, from soldering blocks at the beginning, to resistance welding, and finally to SLM technology, is a process that goes from mostly hand-made, to semi-automated, to fully automated production. This is a continuous process of precision and mechanisation.



*Figure 81. The enamel piece created using three methods: soldering block method (left), resistance welding method (middle), SLM method (right).*

Fourthly, the design and production of the metal scaffolding part is one of the central elements in the MTG series of experiments, which not only affects the precise results of the enamel connecting part, but also determines its size.

While it can be seen from Figure 81 that the experimental results from the SLM production are more accurate than those from the other two methods. SLM production also has the disadvantage that the size of the piece that can be produced is limited to what can be produced by the metal printer. In the case of the metal printing facility at Guangzhou 3D printing factory, for example, because all the metal printed pieces need to be formed on a stainless-steel circular base, the sizes of the metal printable pieces need to be kept within the diameter of the base (Figure 82). In contrast, metal supports applied soldering blocks and resistance welding methods are not limited in size and offer more flexibility, allowing for the exploration of larger pieces in design and production.



*Figure 82. Print area of the SLM printing device (left), titanium scaffold on circular stainless- steel base: the printable object size is limited to the diameter of stainless-steel base (80mm) (right).*

Finally, it was found from previous experiments that the materials used to make the different metal bases affect the surface and the linkage of the fired enamel. For the soldering block method, the materials used consist of a magnesia soldering block and stainless-steel pillars. The magnesia soldering block is very heat reflective, and does not chip as easily as a plaster mould. Moreover, the magnesia soldering block is soft and easy to carve or make holes to pin into to hold pieces in place. The surface of this material is smooth and good for soldering filigree work. The resistance welding method consists of copper and stainless-steel, and the SLM method applies titanium for the metal scaffolding. The experimental data shows that the firing of the enamel on the soldering block

requires higher temperatures and longer firing times compared with the SLM and resistance welding methods. More importantly, although it is easier to remove the enamel piece from the scaffold constructed by soldering block method, the experimental results presented a higher rate of cracking. This may be related to the coefficient of heat absorption and dissipation of the material, as well as the coefficient of thermal contraction and expansion of the base material. There are still not enough experiments to fully prove this, and more experiments are needed to verify this conclusion.

By comparing these three different methods of making the metal bases, it can be concluded that the different production methods have their own strengths and weaknesses. In some past studies, there has been a tendency to emphasise the importance of one method or another, or to focus on craft, or digital technology. However, there is no exact boundary between these two methods, and it is pointless to define whether the object is made by hand or not, as many tools today are no longer made by hand. As Pye (1968: 25) says, "to distinguish between the different ways of carrying out an operation by classifying them as hand-or machine-work is, as well shall see, all but meaningless". MTG series experiments are a hybrid process and the key is how the designer and craft practitioner decide on the appropriate method of production for different design options.

#### **4.4 Material testing phase 4: discovering traditional making knowledge**

The three practical stages mentioned earlier start from the proposal of the original MTG concept and move to continuous improvement of the technology. However, it is not known whether the MTG series shows more structural

possibilities through the comprehensive application of design and craft practice. Moreover, the approach to effectively separate the enamelled parts from the metal scaffolding is a key issue that remained unsolved in this study. The remedy for this problem requires not only structural design and knowledge of material properties but also fabrication knowledge. In this section, the fourth and most challenging practical phase of this research is introduced, including the application of the disassembled structural design inspired by architecture, the exploration of new structures in the MTG series, and the application of traditional making knowledge to effectively remove scaffolding.

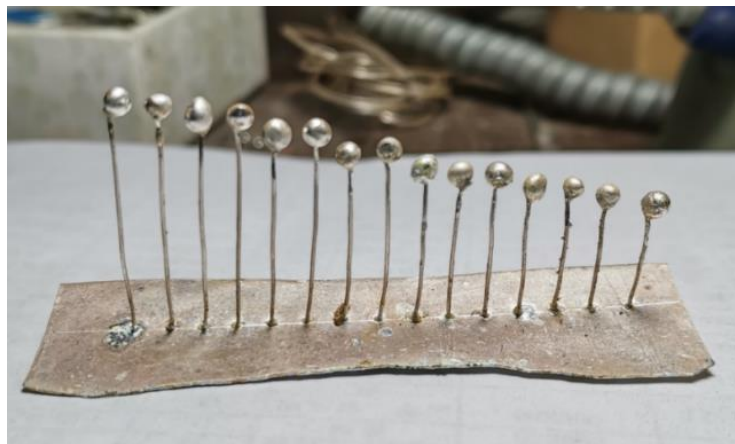
#### **4.4.1 Dismountable structure design for scaffolding**

##### **A new question generated from the preliminary experiments**

In the first phase of the experiments (see Section 4.1.2), the granulation technique was employed that uses a torch to melt and form a granule (sphere) on one side of a silver pin to make a single element used for constructing the metal scaffold. The advantage of this approach is that it is more convenient to make all the components and then establish the scaffolding part by soldering. However, there are several disadvantages to using this handmade method. Firstly, it is difficult to achieve the round shape and the same size for every granule (sphere) on the silver pin by the granulation technique. Secondly, due to the deformation of the silver pillar that occurs usually during the process of soldering by hand, it is not possible to make a scaffolding part that has the precise parameters for the height of the pillars and the distance between the pillars (Figure 83). Most importantly, the granulation technique on the silver pin leads to a dilemma creating a challenge for separating the granule (sphere) part which has already been connected by enamels from the scaffold with the use of a side cutter, as this will increase the possibility of cracking the enamel piece because of the high fragility of the enamel material and the force of cutting. The

more complex the scaffolding structure in design, the more difficult it is to separate from the work itself.

Looking back on the experiments from phase one to phase three of the research, various approaches to manufacturing a scaffold were employed and tested, including soldering using the handmade method, the plaster mould method, the soldering block method, the resistance welding method, and the SLM technology method. These previous experiments demonstrate that the plaster mould is not an ideal material for scaffolding, and the other four methods are available but all produce a fixed scaffold. However, ~~as previously described~~, removing a very fragile piece of enamel from a fixed scaffolding part underneath is difficult. Therefore, identifying approaches to removing the supporting part from the enamel part smoothly and easily becomes a key issue not only for the structural design but also for the technical application.



*Figure 83. A scaffolding part made by granulation and soldering technique in the 1st phase experiment (see Section 4.1.2).*

### **Dismountable structure design inspired by scaffolding in architecture**

Based on the question of removing the supporting part smoothly which was identified after three research phases, different methods and design thinking were examined from other areas and from daily life. Living in a modern industrial city Birmingham, many building sites can be seen in which scaffolding structures are widely used, either to construct a new building or to repair older

buildings such as churches. On the road from my dormitory to the Birmingham City University, there is an on-going building project transforming a historic factory called Victorian Belmont Works that was built in 1899 into an innovation centre for education and collaboration. I have observed the process of establishing the scaffolding over a period of time until the old architecture was covered by an additional steel structure (Figure 84). These scaffolding constructions seem to become another new type of aesthetic language in this city.



*Figure 84. Part of the old Victorian Belmont Works factory building covered by scaffolding, 2019.*

While the Victorian Belmont Works factory provided me with the aesthetic perspective to review the scaffolding design, a visit to the Church of Our Lady and the English Martyrs built in 1885 at the University of Cambridge in the Autumn of 2019 was a meaningful experience that inspired me to propose the dismantlable structural design as an innovation of plique-à-jour. I still remember the spectacular scene of the restoration project when I walked into the church, giving me insight into the process of repairing the decorative mural and relief sculpture by scaffolding (Figure 85), providing a dialogue between modern technology and traditional craft. The craftsmen/craftswomen used contemporary approaches and technologies for making and recreating traditional objects, inspiring me to consider this innovative process in the development of traditional plique-à-jour.





*Figure 85. The interior of the Church of Our Lady and the English Martyrs, 2019.*

According to observations of scaffolding in architecture including the two instances describing above, I have gained further understanding of the principle of scaffolding which is to create or repair an object through establishing an extra supporting part that can be dismantled or moved without negatively impacting the object. Therefore, I propose the idea of using the dismantable structure design method to solve the problem that arose during the process of making, which guides the further exploration of the new structure of the MTG series described in the next section.

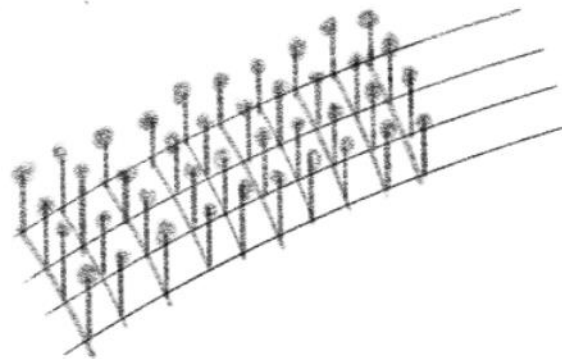
#### **4.4.2 New structural designs of the enamelling work**

The aim of this section is to further explore the possibilities of new structural designs for the MTG series based on the experience and data obtained from the previous experiments, in order to expand the MTG series for future applications. It can be seen from the results of the previous basic experiments that the structural design of the previous testing pieces was mainly a single row structure. This was because the early experiments were aimed at testing the possibility of using the enamel as a bonding agent for the orderly connection of the metal spheres, and thus did not explore much in terms of structure and form. In this section, I describe how the detachable structure design was applied to

the production of the MTG series, and detail the exploration of the MTG series in the forms of the multi-row arch and cylindrical structures using Experiment 39 (E39) and Experiment 52(E52) as examples.

### **Multi-row arch structure**

The greatest inspiration for the scaffolding structures on the construction sites is not only the construction method, but also the visual language formed by these scaffolds. Here the design of this structure was introduced into the MTG series. The previous Experiment 24, Arched Bridge (see Section 4.3.1.2), was a single row arch structure. Based on this, I adapted and arranged the lines to form a four-row arch structure, and tested the possibilities of this design through experimentation (Figure 86).



*Figure 86. Design sketch of multi-row arch structure.*

### **Fabrication process**

Experiment 39 was one of the tests carried out to examine the multi-row arch structure of the MTG series. The first step of the experiment was the construction of the metal scaffold. According to the design, silver pillars of different heights were arranged in an orderly manner and welded on the silver plate to complete the construction of the metal scaffolding. Silver spheres were then arranged on the scaffold also in an orderly manner (Figure 87). After repetitively applying and melting five times, the connection of the spheres was completed in the enamel. Finally, the enamel element part was separated from

the scaffold to become a complete testing piece with a four-row arch structure (Figure 88).



*Figure 87. Silver spheres were arranged in an orderly manner in the metal scaffolding.*



*Figure 88. An intact enamel element with a four-row arch structure.*

### **Data collection and analysis**

From the perspective of design, although the experiment was an exploration of a new form, it also raised new questions about the craft in that the experience of making a single row structure was not entirely appropriate for a multi-row arch structure. The following is an analysis of the problems encountered in this experiment and the production experience.

Firstly, with respect to the complexity of the structure, unlike the previous single-row structure, the structure of E39 was more complex than the previous E24. The test piece of E39 consisted of four side-by-side arches, separated by a

distance of 4.0mm between each row. It became a new technical challenge to connect the four arches by enamel into a complete enamel element part (Figure 89).



*Figure 89. The sequence of applying the enamel: start applying and melting the enamel in the horizontal direction first, then moving to the vertical direction.*

Secondly, in terms of the interaction of the enamel, compared to the previous test piece (E24) with the single row arch structure, the E39 testing piece had to be connected with more spheres. When applying the enamel, it was necessary to bridge the spheres at the front and back, as well as in the left and right directions. If too much enamel was applied, the enamel melted and tended to flow onto the nearby spheres and other parts of the enamel. On the contrary, if too little enamel was applied, the spheres would be incompletely connected to each other (Figure 90).



*Figure 90. The effect after applying the enamel five times: the complex structure will increase the difficulty of applying the enamel.*

Thirdly, due to the greater complexity of the structure and the fixed structure of the scaffolding below, it became harder to separate the fragile enamel element part from the scaffolding (Figure 91).



*Figure 91. The enamel element part of the multi-row arch structure in the scaffolding with a fixed structure.*

### **Cylinder structure**

Early in the research, I had the idea of trying to make a cylindrical object for the MTG series (Figure 92) inspired by the structure of DNA. After completing the tests examining the multi-row arch structure, I began to experiment with another new shape, the cylindrical structure of the MTG series, which was a more challenging exploration. The transition from the multi-row arch structure to the

cylinder structure not only became more complex in form, but also required the application of further technology. Creating a complete MTG cylindrical piece required a combination of design and fabrication. In what follows, I take Experiment 52 as an example to introduce the process of exploring the MTG series cylindrical form in terms of structural design, fabrication process, and the findings from the experiments.



*Figure 92. Sketch of the early MTG cylinder structure.*

### **Fabrication process**

To create an MTG cylinder, a metal scaffold first needed to be constructed. The metal scaffold of the cylindrical structure for this experiment was constructed with 27 columns and 4 rows of silver pillars arranged in order (Figure 93). The scaffold in this experiment differed from the previous in that the internal scaffolding structure was cylindrical. Notably, because of the cylindrical structure of the scaffold, the length of each pillar and the angle formed between each of the two pillars needed to be calculated precisely to ensure that when the spheres were placed on the pillars, the distance between the centres of each pair of spheres was 4.0mm (Figure 94). The metal scaffold utilised a welding technique using fine silver. After the fabrication of the scaffold, the next step was to arrange the half drilled silver sphere in an orderly manner on the pillars. The enamels were then inlayed and fired many times. Once all the

spheres had been connected, the final and hardest step was to separate the enamel part of the cylindrical structure from the metal scaffolding.

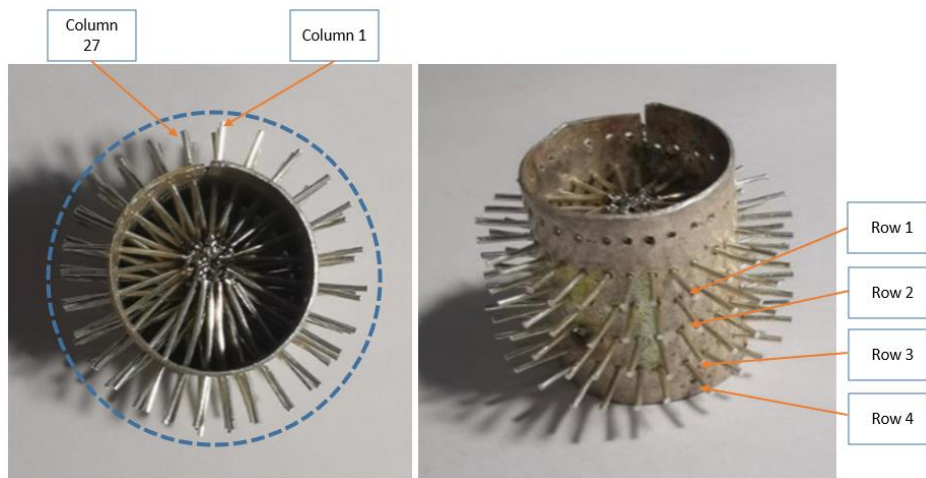


Figure 93. The scaffold of the cylinder constructed with 27 columns (left) and 4 rows (right).

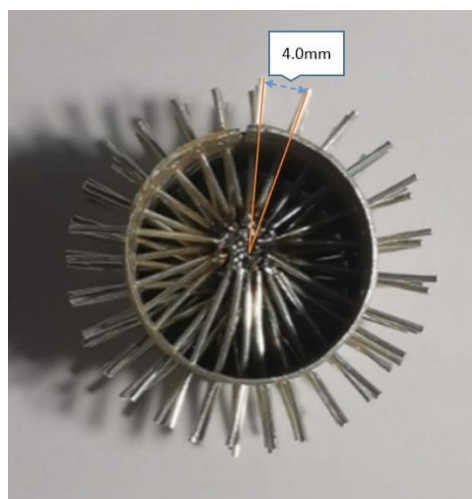


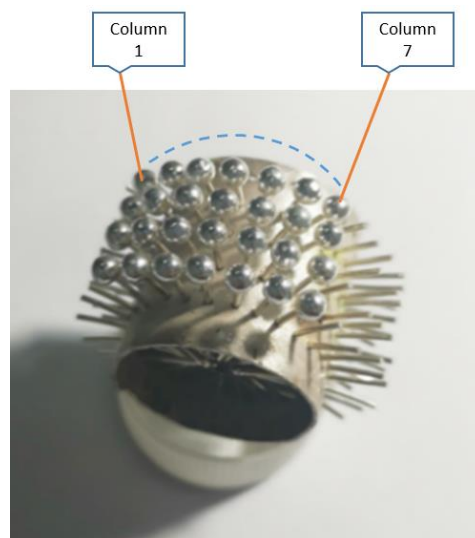
Figure 94. Cylindrical metal scaffolding (top view): the distances between the ends of each pair of pillars (the centres of each two spheres) is 4.0mm.

### Data collection and analysis

Experiment 52 was a challenging experimental process. Although I had accumulated a wealth of design and practical experience from my previous experiments on the MTG series, to produce a cylindrical MTG represented unprecedented exploration for me. Before the experiment began, I anticipated the problems and difficulties that might arise in this experiment and attempted to avoid them. However, the actual fabrication of a structural part of the

cylindrical MTG was far more complex and difficult than anticipated. In what follows, I describe in detail the process of this experiment and its findings.

Firstly, the main difference between the cylinder structure and the multi-row arch structure is the placing of the spheres and applying the enamel. The cylindrical MTG requires the placement of the spheres and the firing of the enamel to occur in one area and then another. Due to the cylindrical structure, the spheres cannot be placed all at once on the metal scaffolding. It is impossible to place the spheres on the downward-facing pins, so the spheres need to be placed on the upward-facing pins first. When the connection of the spheres in one area has been completed, the placement of the other spheres can be continued in the next area and then the enamel can be applied and melted. When making cylinder E52, the first placement of the spheres was limited to 7 of the 27 columns, that is Columns 1 to 7 (Figure 95). The first inlay and firing were then carried out to bridge these 7 columns, 28 silver spheres in total, by melting the enamel (Figure 96 and Figure 97).



*Figure 95. The first step in arranging the spheres: putting them in an orderly manner in the area with structural pillars facing upwards (Column 1 to Column 7).*





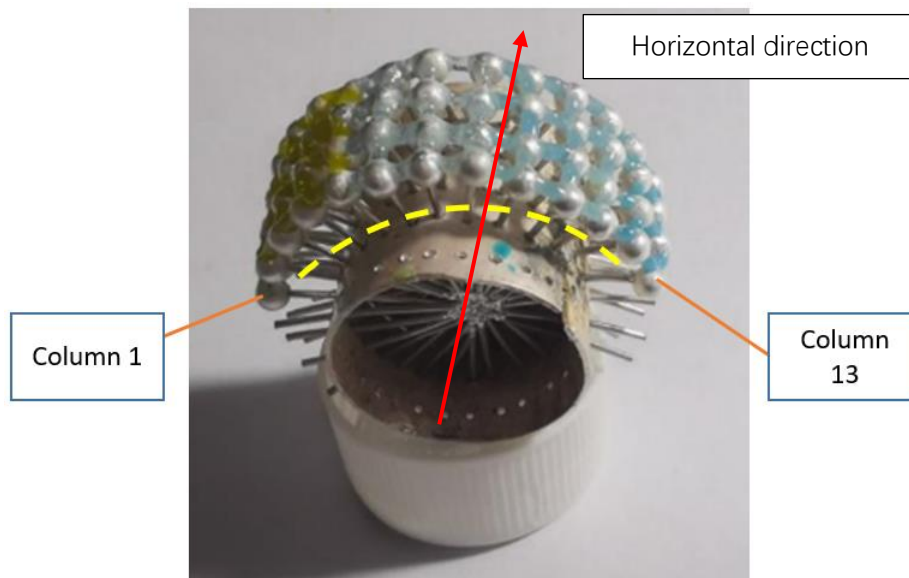
*Figure 96. Completed application of the enamels for the first time with the placed spheres.*



*Figure 97. 28 spheres in the first to seventh columns are connected by enamel after the first melting.*

The second technical difficulty of this experiment was related to the melting. As the testing piece had a cylindrical structure, when the area covered by enamel connecting spheres reached almost half of the entire cylindrical scaffold, it was no longer to place the spheres and melt the enamel in a horizontal orientation (Figure 98). Instead, the metal scaffold could only be erected to melt the remaining part of the enamel and connect the spheres (Figure 100). This was because the angle of the remaining part of the scaffold prevented the spheres from being placed smoothly on the pillars. Moreover, when melted at high temperatures, the flow of the enamel caused the spheres to move. In this

experiment (E52), for example, Figure 98 shows that after four firings, the enamel had completed the connection with the spheres in almost half of the area of the cylinder (from Column 1 to Column 13). During the firing of the enamel on the pillars (Column1 to Column 13), the metal scaffolding and the worktable were horizontal rather than vertical.



*Figure 98. The effect after melting the enamel part from Column 1 to Column 13 (horizontal direction).*

However, from the 14<sup>th</sup> column onwards, after the spheres were placed and the enamel was applied in the horizontal direction (Figure 99), the test piece needed to be fired in a direction vertical to the bench (Figure 100). It was a great challenge to finish the vertical firing by making the enamel connect with the spheres suspended from the pillar. It was necessary to melt the enamel to bridge the spheres, but not for too long or at a temperature that would cause the spheres to shift and fall off the scaffold. This is something I had never experienced in the previous 15 years.

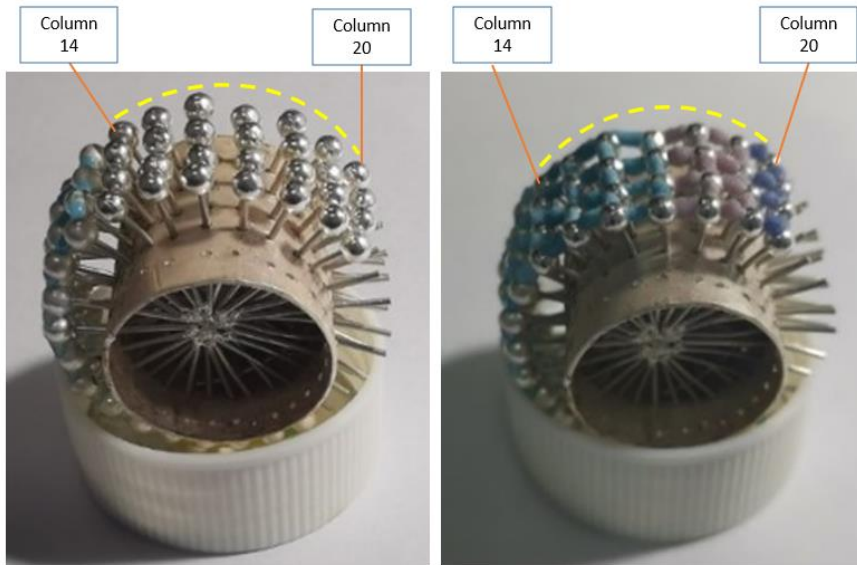


Figure 99. Place the silver spheres (left) and apply the enamel (right) on the 14-20 columns of the cylindrical scaffold (horizontal direction).

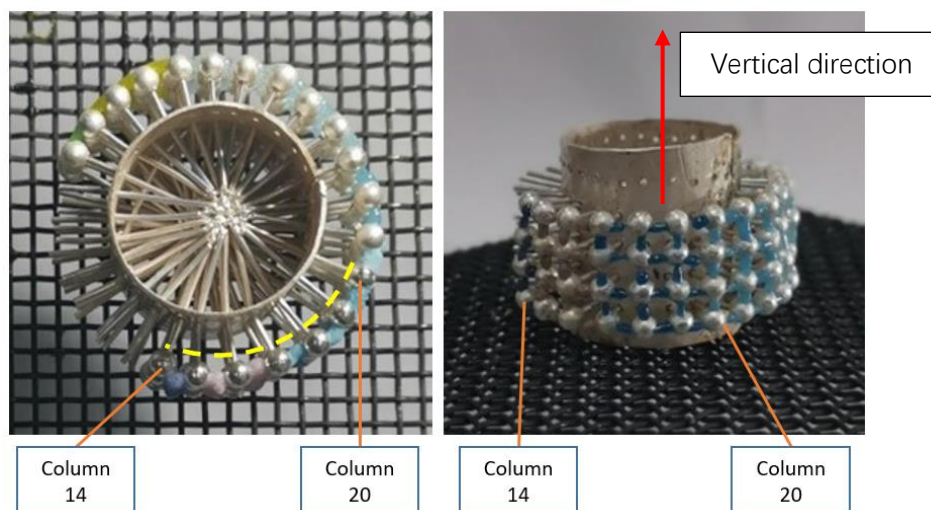
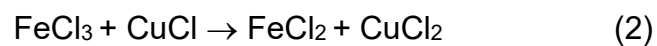
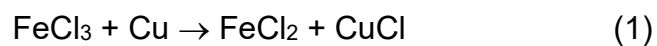


Figure 100. Position the cylindrical scaffold perpendicular to the worktable and then melt it in the kiln (vertical direction). Top view (before firing, left); Front view (after firing, right).

Finally, the separation of the enamel element part with the cylindrical shape from the scaffold was the last and most difficult technical challenge of the experiment. In this experiment, I mainly applied the method of cutting off the pillars in the middle of the cylindrical scaffold one by one using a cutter until all the pillars had been dismantled. Unfortunately, this experiment ended in failure again. During the process of disassembly, the already fragile cylindrical enamel part of the MTG series broke due to the forces involved.

#### 4.4.3 Methods of removing scaffolding part

According to analysis of the failed outcomes of the previous experiments, the cutting method using a handheld jewellery side cutter produces an unpredictable force on the testing piece. Identifying approaches which can be used to remove the metal scaffolding part without this force effect has become one of the critical questions for this study. At the moment, past practical experience suggests that it may be possible to employ a chemical etching approach to remove the metal scaffolding. In 2016, after mastering the filigree and piercing technique that are the two main methods of creating the metal framework of plique-à-jour, I started to practice another important traditional plique-à-jour technique “shotai jippo” to make several objects and thereby gain a basic understanding of this traditional way of creating plique-à-jour (Figure 101). The making procedure of shotai jippo is similar to wired cloisonné, but the key point of this method is that it is a chemical etching approach using ferric chloride which is a universal etchant for many kinds of metal and their alloys such as steel, copper, and aluminium, etc. More importantly, ferric chloride is especially good for etching the workpiece of copper on a small-scale project. In the chemical engineering field, extensive studies on etching copper have been conducted, viewing ferric chloride as an ideal etchant because of its reaction with metallic copper. The chemical formula of ferric chloride is  $\text{FeCl}_3$ . The reaction of copper with ferric chloride can be described as follows:



Source: Cakir et al. (2005: 277).

After  $\text{CuCl}$  is formed, the etchant solution is unable to work effectively. Besides

ferric chloride ( $\text{FeCl}_3$ ), cupric chloride ( $\text{CuCl}_2$ ) is another effective etchant for copper, but its etching rate is lower than  $\text{FeCl}_3$  (Cakir et al., 2005). Furthermore, another crucial feature of ferric chloride is that it works well on copper but does not react with silver. Thus, the technical principle of traditional shotai jippo is in utilising the chemical feature of ferric chloride to dissolve the copper base while retaining the enamel and silver part. In the preceding experiments, the metal of the scaffolding part was fine silver. Based on the lessons learnt from the past experiments and the making method of shotai jippo, the scaffolding part was redesigned with copper instead of silver so that it would be possible to remove the scaffolding part without any force effect. Instead of the cutting which is a physical method, my knowledge of shotai jippo suggested that it might provide a chemical solution to remove the scaffold part, significantly drawing on the value of past knowledge embedded in traditional craft.



*Figure 101. Two test pieces of plique-à-jour using the shotai jippo method, by the author, 2016.*

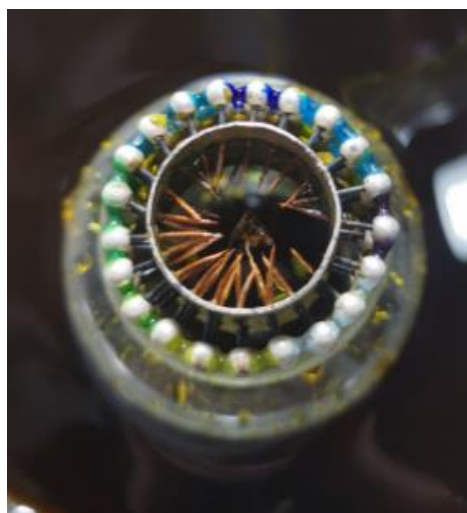
### **The chemical etching process**

After many failed attempts at separating the scaffold by a cutting method, the chemical etching method with ferric chloride was first employed to make a MTG cylinder in Experiment 56 (E56). In this experiment, firstly, a simple installation was designed to allow the flow of ferric chloride to concentrate on the middle part of the scaffolding made of copper (Figure 102). The etching of the copper part of the MTG cylinder lasted for nearly three hours, requiring that the

practitioner constantly dropped ferric chloride on the copper part. The pillars could then be removed to obtain the enamel piece until the connecting part at the middle of the scaffold was etched off (Figure 103). Looking back at this testing piece, although it failed to form a completed piece of MTG cylinder (Figure 104), one of the reasons for disconnecting, could have been the incompatibility of the enamels. It has already been demonstrated that utilising ferric chloride to etch scaffolding made of copper would not create a force effect on the enamel part.



*Figure 102. A specific equipment designed for directing the flow of ferric chloride.*



*Figure 103. The copper part of the scaffold was etched off.*



*Figure 104. The cracking of the MTG cylinder in Experiment 56.*

### **Disadvantages of the chemical etching method**

Although the acid etching method with ferric chloride enables the removing of the scaffolding part without force, it also creates some negative effects on the surface of the enamels and silver spheres. First of all, in contrast to traditional shotai jippo, the copper scaffolding part of the MTG cylinder is not covered by enamels. Copper oxide, thus, forms and drops easily on to the surface of the enamels during melting and influences the appearance of the enamel part (Figure 105). More importantly, as Bachrach (2006: 15) points out, “copper oxide prevents enamel adhesion and also results in colour problems”. This may be another reason for the cracking of the test piece in E56. Third, although ferric chloride will not etch fine silver, the reactant forms in the etching can easily attach to the silver spheres which are not covered by the enamels (Figure 106). In addition, due to high fragility, it is impossible to polish the surface of the enamels and silver spheres of the MTG series as strongly as for other kinds of enamel work, leading to reactant that cannot be removed. Thus, it raises a new question, how can the contact between the enamel surface, silver spheres, and ferric chloride solution be avoided.



*Figure 105. Copper oxide melted with enamels and attached to the surface of silver spheres.*



*Figure 106. Reactant covers the surface of the enamels and silver spheres.*

### **Re-designed scaffold for the chemical etching method**

The outcome of the above MTG cylinder Experiment 56 shows that it is necessary to redesign the scaffolding part to address the issues raised by the acid etching method. In response, a new design of the scaffold for MTG series was implemented. Take Experiment 44 (E44) as an example, the distinction between the previous scaffolding structure in Experiment 41 (E41) and the new design (E44) is that the metal for the foundational axis is copper rather than fine silver, and the metal for the pillars of scaffold remains silver (Figure 107). Compared to the prior scaffolding structure, the new design provides several benefits. Firstly, it reduces the negative effect of the copper oxide in melting since there is less copper that is used in the scaffolding. Secondly, due to the



new structural design, a bigger distance between the main axis of the copper, the silver spheres, and enamel part is created, allowing the chemical reaction to concentrate on the copper axis and preventing the reactant to reach the surface of the silver spheres and enamels (Figure 108).

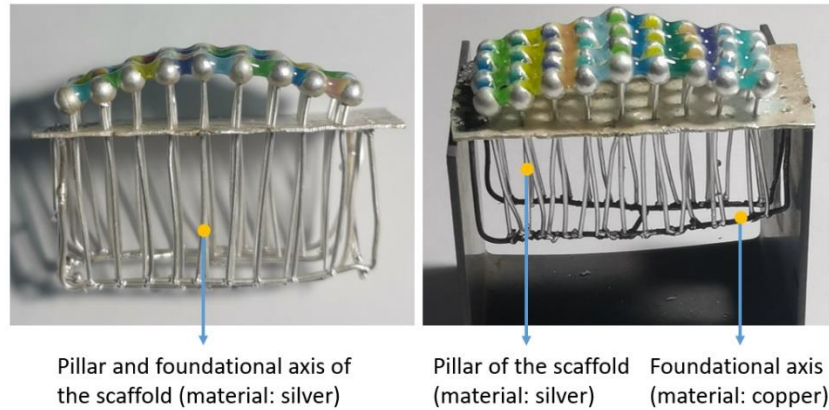


Figure 107. The metal scaffold of Experiment 41 was constructed with fine silver (left); a new scaffolding part in Experiment 44 combines fine silver and copper (right).

Based the new scaffold design and the replacement material, the issues of the chemical reaction and force effect were finally resolved. This new design and making approach could then be employed in the subsequent MTG cylinder experiment, but more testing was required as the inner structure of cylinder form is more complex.



Figure 108. The making process of Experiment 44: copper oxide formed on the copper axis without effecting the enamel part after melting (left); the outcome of Experiment 44: a completed enamel piece was removed smoothly from the scaffold after the acid etching process (right).

### The value of traditional making knowledge

In craft practice, the material is one of the essential factors that influences the

technical application and manufacturing. In the MTG series of experiments, due to the high fragility of the enamel part, previous experiments demonstrate that it is a challenge to separate the enamel part from the scaffold underneath by the cutting method. Although identifying a solution was the most critical challenge of this research, prior making knowledge and experience inspired me to finally achieve the solution. In recent years, more and more people have recognised the value of traditional craft. However, most studies have focused on the “pastoral side of craft” or the “different theoretical roles of amateurism” (Kjørup, 2018: 24) in craft. Through the application of traditional making knowledge in the process the investigation of the MTG series, I strongly believe that the core value of traditional craft is in providing practical solutions to contemporary issues.

The fourth phase of the experiments of the MTG series demonstrates that it is traditional making knowledge that eventually solved the critical problems associated with advanced digital technologies and manufacturing in the process of innovating in traditional plique-à-jour. Traditional shotai jippo was used to solve the technical question of how to detach the piece from its scaffolding, facilitating a kind of novel reapplication of the technique within this study. To some extent, this is an active and natural mode of transmitting and protecting heritage and traditional craft rather than passively or intentionally preserve it. Therefore, I believe that rediscovering practical value is a crucial route for the sustainability of traditional craft in contemporary applications.

# 5 Discussion and conclusion

After the previous four stages of practical exploration, I have gained valuable experience from many failures and have basically mastered methods to design and fabricate simple MTG structures. However, there are still many possibilities for MTG in terms of technical application and form exploration. As a practitioner and researcher, I have created the new enamelling technique, MTG, through the use of a combination of materials, fabrication, and design thinking in this study. In this complex process of exploration, what insights have I obtained? And what new thinking has the exploration brought me in the inheritance and development of traditional crafts? In the final chapter of this thesis, I discuss the contribution of this study to new knowledge, the enlightenment towards innovation in traditional crafts, and potential research directions that are worthy of further exploration in the future.

## 5.1 New visual language of enamelling work

The exploration of different structures of the MTG series has been challenging and unsuccessful in this study, but rewarding in many ways. In addition to finally finding a solution to effectively separate the enamel element from the scaffolding for the MTG series from the traditional production method (see Section 4.4.3), a visual effect was identified that had never been seen in the art of enamelling before. In the following section this inadvertent discovery is described in detail, analysing the reasons for this new visual language and its specifics.

**New visual language formed by a single row structure made out of connected spheres**

In the early stages of the experiments, I focused on whether enamel could be used as a bonding agent to connect spheres that are arranged in an orderly manner. Most of the testing pieces in these experiments had the structure of a single row or arch. Experiment 12 was the first experiment in the early stage to successfully test the MTG series using a square structure made out of a single row of connected spheres. The comparison of enamel effects before and after firing can be seen in Figure 109. The right picture shows that after the first melting of the enamel, the enamel and two spheres form a shape that is large at both ends and thin in the middle. An effect like the model of hard diamond (Figure 110).



Figure 109. The testing pieces of Experiment 12 after being inlaid (left), and being melted (right) in the first time.

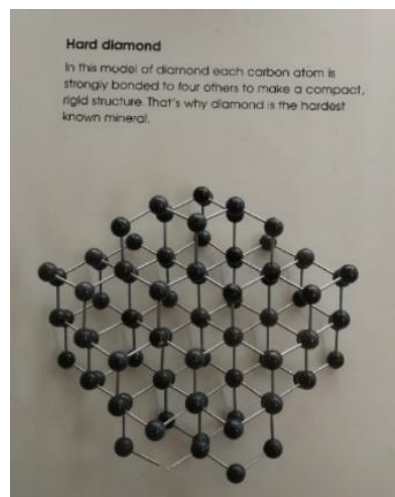


Figure 110. The model of hard diamond, which was photographed in the National History Museum in London, by the author, 2020. "In this model of diamond each carbon atom is strongly bonded to four others to make a compact rigid structure" (source from: The National History Museum, the UK).

Subsequent experiments including squares (Experiment 12, 21, 30) and circles (Experiment 17, 35, 36) presented this unique visual language (Table 3). Enamel connects spheres because of its viscosity and fluidity, and the effect of the model of hard diamond is due to another important physical property of the enamel, contract or surface tension (interfacial tension between glass and metal) after firing, which is also similar to another interesting phenomenon. In the process of making MTG, after cleaning the metal scaffolding, I found that the water stayed between two spheres and the middle part became thin, which was caused by surface tension of water (Figure 111).







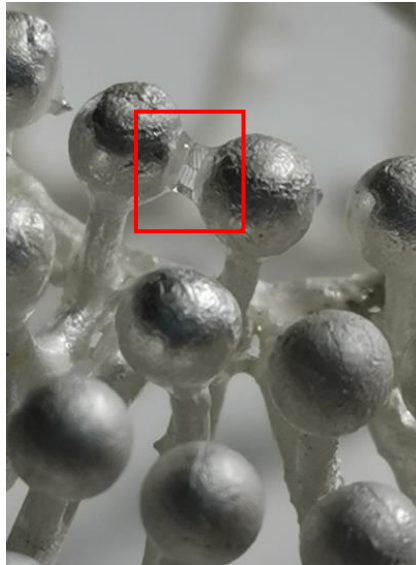
Experimental result (Image)			
Experiment	Experiment 12	Experiment 21	Experiment 30
Experimental result (Image)			
Experiment	Experiment 17	Experiment 35	Experiment 36

Table 3. The single row structure (square and circle) of the MTG series represents a visual language of the model of hard diamond.



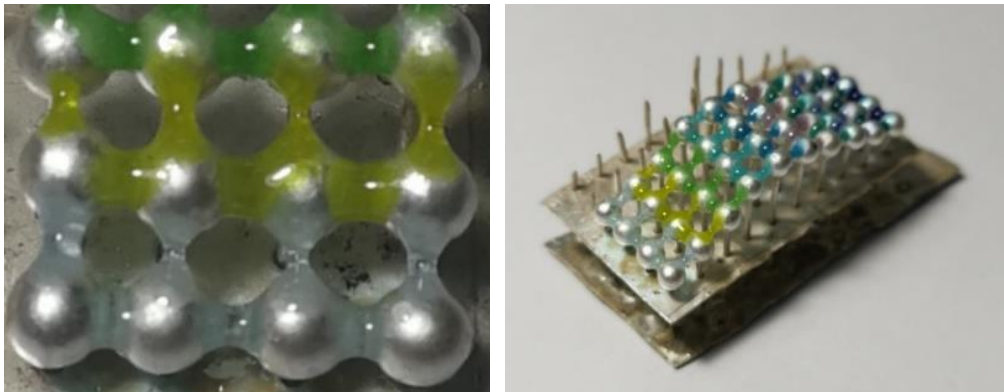
*Figure 111. An effect of water droplets between two silver spheres.*

### **New visual language formed by a multi-row structure of connected spheres**

In practice, in addition to these effects, there is a more surprising finding, that is a precise, orderly but differentiated visual language of the appearance of holes within a perforated surface. Experiment 38 (E38) was undertaken before Experiment 39 (E39) (see Section 4.4.2). In fact, this experiment E38 was the first to test a multi-row structure, but this was not discussed as a case in the previous chapter on the exploration of new structural forms due to a fracture occurring during separation (see Appendix 1: E38). It was in this seemingly "failed" experiment, however, that the visual language unique to the MTG series was created - precisely ordered but with distinct holes. This is one of the most significant contributions of this study.

After completing the first melting of E38, I accidentally identified a special effect, that is, in the area between every four spheres, the enamel after firing forms a small hole (Figure 112: left). This effect has not been seen in enamel art in the past. Moreover, due to the design of the scaffolding, spheres being arranged in an orderly square, at high temperatures, the enamel begins to melt, flow, and

contract among the regular gaps formed by these spheres, becoming rows of orderly but disparate holes (Figure 112: right). This special visual language is also caused by the contraction of enamel after firing at high temperature. In order to verify this special effect, I conducted several experiments as well as different experiments, such as Experiment 41 (E41), focused on colour, to expand the potential of this visual language (Figure 113).



*Figure 112. Local effect of Experiment 38 testing piece after the second melting (left); Experiment 38 testing piece shows the effect of an orderly arrangement of holes (right).*



*Figure 113. The outcome of Experiment 41 presents a special effect with various colours.*

From the above experimental comparison between a single-row and multi-row structure, it can be seen that the physical properties of enamel also produce different visual effects due to different structural designs. MTG series experiments show the importance of materials in craft practice and the interrelationship between materials and design (Kane, et al., 2016).

### **The uniqueness of the language of holes in the MTG series**

Filling in a cell (hole/opening) used to be a common action in the process of making enamel works. But the MTG series creates holes. In what follows, I compare my plique-à-jour works, Hilary Finck's ornaments and Alexandra Raphael's plique-à-jour bowl with the MTG series to illustrate the uniqueness of the language using holes in the MTG series.

Rothenberg (1969: 129) describes the works of plique-à-jour as follows: "If 80-mesh enamel is tamped into the holes, it will shrink as it melts, and more enamel must be packed, and refired. [...] The first firings will usually pull the enamel away from an edge or leave a hole in the center. These holes can be filled and given another firing". The I-PAJ 1 is a piece of plique-à-jour works I created in 2021 (Figure 114: left) (see Appendix 3). The description of Rothenberg confirms what I have seen during the production of plique-à-jour applying traditional wire soldering techniques. After the first melting, holes are left in the metal frame as the enamel contracts at high temperatures. Enamels are required to apply and melt many times until all the holes are filled (Figure 114: right).



*Figure 114. A piece of I-PAJ series (left) and the production process (right), by the author, 2021.*

In contemporary times, some enamel artists made plique-à-jour pieces by



deliberately leaving specific openings in the metal frame unfilled with enamel to create an effect of holes. Examples of this are the plique-à-jour collar bangle by Hilary Finck (Figure 115) and the plique-à-jour bowl by Alexandra Raphael (Figure 116). Finck uses a cutting process, first piercing small, neatly arranged holes in a sheet of copper, and then filling enamel into the specific holes. Raphael, on the other hand, uses the traditional shotai jippo technique, which also leaves certain metal cells unfilled with enamel.



*Figure 115. Plique-à-Jour Collar Bangle, by Hilary Finck.*



*Figure 116. Lace Plique-à-Jour Bowl, by Alexandra Raphael, 2022.*

The two plique-à-jour pieces above both show the visual effect of holes. This raises the question, why is the effect of holes in the MTG series a special visual language? This is because both artists' works have one thing in common: the holes in the plique-à-jour pieces are formed by pre-designed fixed metal cells.

The MTG holes are formed by the contraction of the enamel, which is the most unique feature of MTG (Figure 117). Holes created by the MTG technique are not predetermined, but rather unknown and uncertain, as enamel is no longer restricted by the cell. At the same time, it should be noted that the action of producing the holes of the MTG series is "filling in the gap" rather than "filling in the cell". Whether the cell is filled or not, examples of the past are limited by the cells of the metal.



*Figure 117. Detail of the testing piece in Experiment 41: Light shines from the back of the testing piece, revealing holes in various shapes and transparent enamel colours.*

### **MTG: A coexistence of certainty and uncertainty**

After much practice and many failures, a new visual language was finally created for the MTG series. The appearance of multiple holes within a perforated surface is both definitive and indeterminate. The appearance is certain because the metal scaffolding and spheres are produced through calculation and digital technology, while it is indeterminate because the enamelled parts are handmade and the enamel is not restricted by the cellular framework. Each melting, flow and contraction of the enamel that occurs in the hot kiln is different. When reviewing the previous discussion in Section 2.3, I realise that the MTG series embodies the fusion of digital technology and craftsmanship, which is produced by hybrid craft. In the past, when it comes to innovation in traditional crafts, the emphasis has often been on the potential of digital technology to bring about the development of craftsmanship (Shillito, 2013) . When talking about the homogeneity of digital technology, people recall

the irregularity and subtle variety of craft (Kane et al., 2016: 2). The MTG series emphasises the effective combination of technology, craftsmanship, and materials, rather than the role of one aspect alone. In the practice of the MTG series, different elements are linked to each other and together create the special porous visual language of MTG. Within the MTG series, the definite and the indefinite elements are interdependent. Without these ordered arrangements of spheres, no ordered holes would be created. And without the enamel, these spheres could not be connected as a whole.

## **5.2 Further exploration of enamelling work**

After completing basic material tests and experiments to explore new structures, I further explored different forms of MTG, including, one MTG pillar with a height of 7 layers, confirming the validity of the technology used to make the structure. The MTG series with scaffold and different forms show the potential for future applications of the MTG technique.

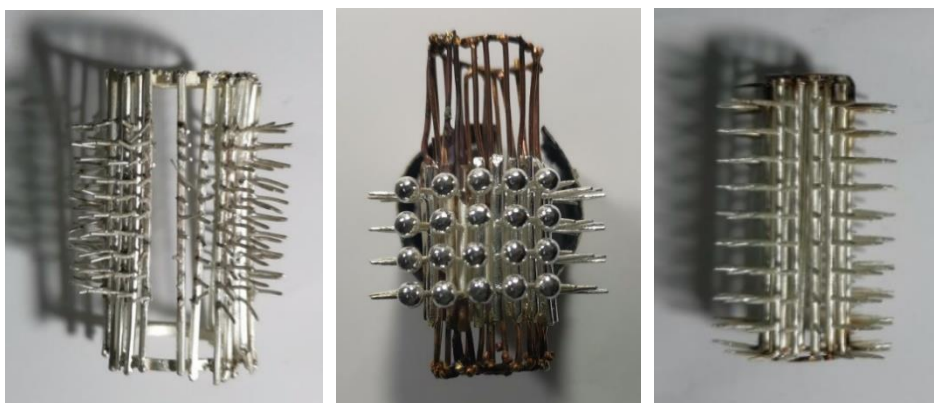
### **Seven-layer MTG cylinder**

Based on the previous experience of removing scaffolding by the acid etching method (see Section 4.4.3), I used this technique again to create an MTG cylinder with a height of 7 stories, which not only proves the effectiveness of the technique, but also creates the tallest MTG cylinder structure (without scaffold) to date (see Appendix 1: E58). It can be said that this MTG cylinder is the result of combining experience and experimental data from all previous MTG series (Figure 118).



*Figure 118. Seven-layer MTG cylinder.*

In order to achieve a higher height and a more regular surface finish for the MTG column, I first made further improvements to the design of the metal scaffold. In the meantime, to reduce the influence of acid corrosion, I tried to reduce the proportion of copper in the metal scaffold as much as possible. The metal scaffold for this experiment had a circular structure at the top and bottom of the pillar made of copper, while the remainder of the pillar made of fine silver, which is made by casting (Figure 119: right). Figure 119 and Figure 120 illustrate the evolution of the MTG series of cylindrical metal scaffolds, a process of continuous improvement in technology and structural design through reflective practice.



*Figure 119. Evolution of the cylindrical scaffold: the first cylindrical scaffold (left), the scaffold from Experiment 57 (medium), and the scaffold from Experiment 58 (right).*



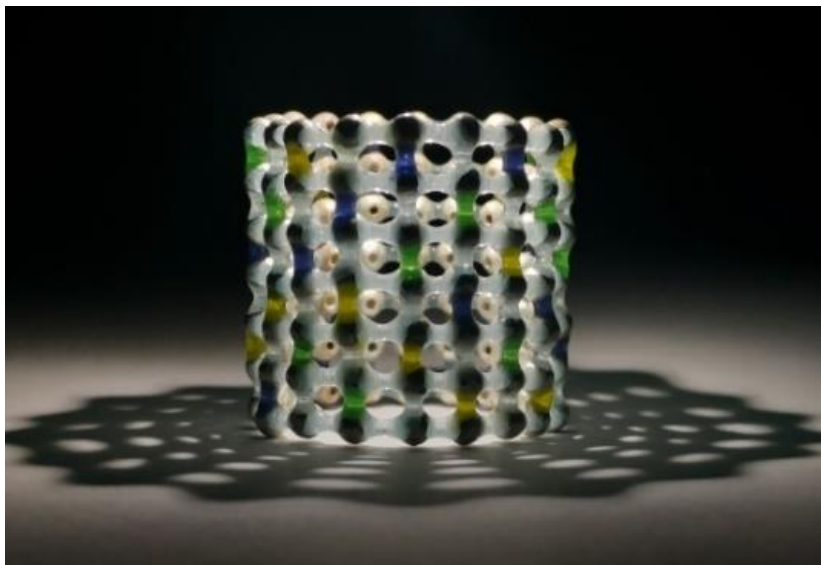
*Figure 120. Acid etching process for Experiment 58: only the copper ring at the upper and lower ends of the scaffold needs to be etched.*

Secondly, in terms of enamels, I have found in my previous extensive practice that a Chinese enamel, transparent light white, is very stable in its physical properties, connecting well to the metal s and does not break easily. Therefore, I mainly applied this enamel in this experiment, together with three coloured enamels from Japan (Figure 121). At present, however, my knowledge of the main components of this stable enamel "transparent light white" is limited, for I only know that it is a soft fusing enamel from the manufacturer.



*Figure 121. The process of applying the enamel: filling the gaps between the gaps on the metal scaffold with the enamel "transparent light white".*

Finally, in terms of visual effects, the "seven-layer MTG pillar" shows a special projection effect under the light (Figure 122), which will be an important factor in the future presentation of the MTG series.



*Figure 122. Lighted seven-layer MTG cylinder.*

### **MTG with scaffold**

After completing a series of experiments of the MTG without scaffold, and

inspired by the DNA structure, I began to explore the MTG with scaffold to expand the expression of the MTG series (see Appendix 1: E61). The greatest advantage of the MTG with scaffold compared to the previous unframed model is that it is no longer restricted to scaffold disassembly and has a more flexible shape. Certainly, there are technical challenges in the production of the MTG with scaffold. Below I illustrate the exploration of the MTG with scaffold with some practical examples (Figure 123).



*Figure 123. Exploring the MTG series with scaffold.*

First of all, the more complex structure of the MTG with scaffold in terms of shape means that the application of enamel requires a constant change in its angle based on the metallic scaffold structure, while also ensuring that the hand does not touch the enamel (Figure 124).



*Figure 124. The angle of application of enamel should be adjusted to the scaffold structure.*

Also, as some structures are enamelled at different angles, when melting, a normal metal trivet is sometimes not suitable for the series. Thus, it is necessary to redesign to create a suitable bracket to hang enamelled pieces and then place them in the kiln for melting (Figure 125).



*Figure 125. The multi-angle MTG with scaffold requires the use of a special stand to aid firing.*

### **The integration of MTG technique and plique-à-jour technology**

In the exploration of the MTG with scaffold, a new creation is made, entitled "MTG Crown" (see Appendix 1: E62). The most significant feature of this attempt is that for the first time, the MTG technique is combined with the traditional plique-à-jour technique (mica method) in one piece (Figure 126).



*Figure 126. MTG Crown: effect without light (left), effect with light (right).*



The difficulty of the "MTG Crown" is that it requires the practitioner to balance the sequence and the length of the firing. I first apply the MTG technique to complete the main part, the spaces between the spheres (Figure 127), and then the remaining opening is made by the traditional plique-à-jour mica method. Filling the round shape opening (diameter: 20mm) above the metal scaffold with enamel is a considerable challenge. Firstly, a plaster mould should be made to support the mica, then the round hole should be melted with enamels several times, and more importantly, the already fired part of the scaffold (Figure 128) should be taken into account. Based on many years of practical experience, I examined this creative idea and expanded the application of the MTG technique for the future.



*Figure 127. Filling the gaps between the metal spheres with different coloured enamels.*



*Figure 128. The opening of "MTG Crown" before being applied with enamels (left), after being applied with enamels (right).*

The above explorations are the final stage of practice in this research, which once again reflect the integrated application of materials, design, and technology. These examples not only provide different forms of the MTG series, but also present possibilities for the integration with past plique-à-jour techniques, providing further references for future practitioners and researchers. I believe that in the future, the MTG series will continue to expand the people's perception of enamel art, the application of design and new technologies, and the understanding of traditional craftsmanship.

### **5.3 Wheel of life: a circle of technique**

It was a challenging journey of discovery from plique-à-jour to MTG. The research started with traditional craft and ended with the knowledge of traditional making, from which I have gained many insights. Generally, this research has gone through four phrases of development. From the initial development of the MTG concept and initial experiments, to the second phase, which focused on manual production, to the third phase that combined with

digital technology, and finally to the reapplication of traditional making knowledge. Finally, a system model for the MTG series was finished. In fact, however, the above four stages are not entirely linear in their development, but rather different stages intersect and inspire each other. Reflective practice (Schön, 1983) takes a crucial role in this process, in which different techniques are mixed and repeatedly applied.

### **Circulation of techniques**

The design and production of scaffolding is one of the key elements necessary to complete the MTG series. When putting forward the MTG concept and carrying out initial experiments, I began to invest a great deal of time in exploring effective methods of scaffold construction and dismantling. The first method is using plaster mould as a base material, the advantage of which is that the plaster base can be dissolved by immersion in water to dismantle the scaffold. However, experiments reveal that plaster moulds are fragile during fabrication and cannot support the scaffold for a long time. A soldering block was therefore applied as a base material instead of plaster moulds. Although the method of applying a soldering block enables the metal scaffold to become more stable, the material of the soldering block makes it impossible to construct an accurate metal scaffold or collect accurate data. To solve these problems, I apply two digital techniques, SLM and resistance welding to create the scaffolding. Scaffolding made by SLM is more accurate than resistance welding because SLM is a fully automated technology. However, the common problem with both technologies is that the scaffolding produced by them is fixed, which can easily lead to fragile enamel pieces breaking when they are separated from the scaffolding. Therefore, I used the previous method of plaster moulding again, but add CNC drilled acrylic plates to improve the accuracy of the scaffolding. However, most of the experiments resulted in fractures. This could have been caused by different thermal expansions of the plaster mould and the

enamel, or the incompatibility of different enamels. I found the answer to this problem from my past practical experience, a traditional plique-à-jour technique called "shotai jippo", which is an acid etching method. The advantage of this method is that the metal scaffolding can be dismantled to obtain the complete enamel piece without external force. I can say that this iterative process of exploration (Figure 129) provided me with a deeper understanding of Schön's knowing in/on action. This is because through reflective practice I have been able to acquire knowledge from the practicing and learning from past experiments in order to continuously improve the design, materials, and making methods.

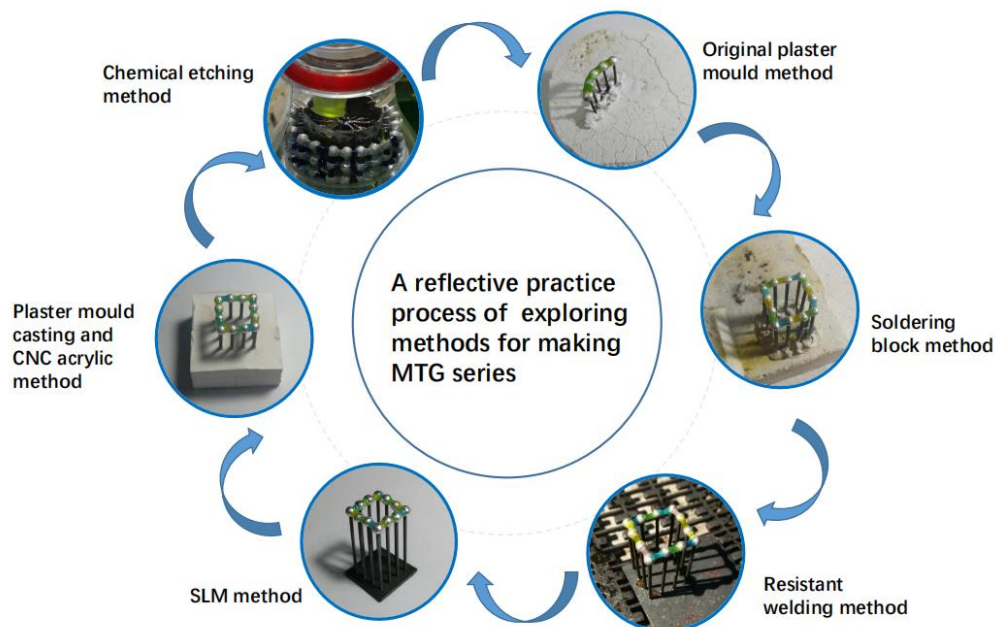


Figure 129. The circular development process of techniques for the MTG series.

### Re-understanding of traditional craft

In the past, there were many misconceptions about craft (see Section 2.1), which was thought to be decorative, marginal or even unintelligent (Greenhalgh, 1997). In this study, I have gained a new understanding of craft. In the process of technological reincarnation, the reapplication of traditional production knowledge not only successfully solved the problems generated by digital technology, but also contributed to the improvement of structural design of the

scaffold, which is an expression of craft-based design (see Section 2.4.2). This experience has shown that craft is not unintelligent, but plays an important, or even central role in design and practice. Therefore, I advocate that craft should no longer be understood purely from a “rhetoric” (Dormer, 1997: 14), “pastoral” (Kjørup, 2018: 24), or “amateur” (Miller, 2011: 17) perspective, but also from a “practical” (McCullough, 1996: 22) and innovation-driven perspective, and thereby consider the value of craft in contemporary times. I argue that craft will act as a significant resource to “give some individuals so much intellectual, imaginative and sensory pleasure to make things” (Dormer, 1997: 157), and to constantly provide effective development solutions for the future of human being.

Inheritance and development of traditional craft is a process of constant change to adapt to its environment. As a crucial element of craft, making knowledge originates from practice and aims to address the practical issues in production which is the value of the craft. I argue that at the core of the sustainability of craft is making knowledge that is continuously applied. For instance, in this research, the traditional acid etching technique was employed to address the practical issue of dismantling metallic scaffolds created by the digital technology SLM in the process of plique-à-jour innovation. Thus, the making knowledge of the traditional acid etching technique was preserved and passed down to subsequent generations. Making a piece of MTG enamel work, in fact, is a process of hybrid craft practice, requiring the cooperation of different crafts and technologies. When we review this study from a technical perspective, one of the most important contributions of enamel technique is that enamels are applied to fill in the gaps between metallic objects instead of filling in the cellular framework. The technique of applying enamels to a gap between two metal spheres is basically understood within the parameter of the gap, which provides reference for using this new enamel technique by future practitioners and

researchers.

## **5.4 MTG: a unity of radical and incremental innovation**

The MTG series, developed from traditional plique-à-jour, is a collaborative effort of radical and incremental innovation (Figure 130). Norman and Verganti (2014: 82) provide their own definitions of these two innovations incremental innovation means “improvements within a given frame of solutions (i.e., ‘doing better what we already do’)”; and radical innovation means “change of frame (i.e., ‘doing what we did not do before’)”. Obviously, radical innovation is vital to breakthrough development. As Elon Musk (2020) has expressed:

“I think we can go a long way towards making Starfleet real and making these, sort of, semi-utopian futures real, but it will definitely require radical innovation. One can’t get there by incrementally innovating expendable boosters, there’s just no way”.

In his discussion, Verganti (2011, 2014) on the one hand agrees with Norman’s view that technology can lead to innovation, and on the other hand, he further suggests that the core of radical innovation lies in the change of product meaning, a view supported by Klaus Krippendorf’s theory. Looking back at the development of plique-à-jour in the past, I find that the artisan’s action from wire soldering, piercing, to 3D printing and then casting, is in fact a continuous process of improving the production method of metal frames. It can therefore be interpreted as incremental, but not radical innovation, because the purpose and meaning of applying enamel has not changed, it is still fills in the cell. Another point is that applying digital technology in traditional craft does not necessarily lead to breakthrough innovation, but rather radical innovation can

be realised when there is a fundamental change in meaning.

If the aim of incremental innovation is the better performance of products, the technological reincarnation (see Section 5.3) discussed earlier is, in fact, a process of continuous technological improvement, which is an incremental innovation. However, the proposal of MTG concept is a radical innovation, the core of which is not about improving, but about creating new meaning and a new paradigm (Norman and Verganti, 2014). My personal understanding of radical innovation is that it creates a discontinuity with the past. Being different from the past may not mean that it is better than the past, but it creates difference and diversity. Thus, MTG, in a sense, is not an improvement of plique-à-jour. It is not due to the application of advanced technology that makes it faster, more precise and more complex, but the technique (making method) is fundamentally different from plique-à-jour.

Certainly, radical innovation and incremental innovation are one. “Without radical innovation, incremental innovation reaches a limit. Without incremental innovation, the potential enabled by radical change is not captured” (Norman and Verganti, 2014: 84). The MTG series is therefore the result of the integration of radical and incremental innovation. In the past, Verganti's innovation theory was applied mainly in the areas of product design and business management, but was not replicated in craft area. Thus, based on this study and combined with Verganti's theory, I propose an approach to innovate traditional craft that involves first radical innovation and then incremental innovation, which I summarise in four steps: to learn, to leave, to break, and to reunite.

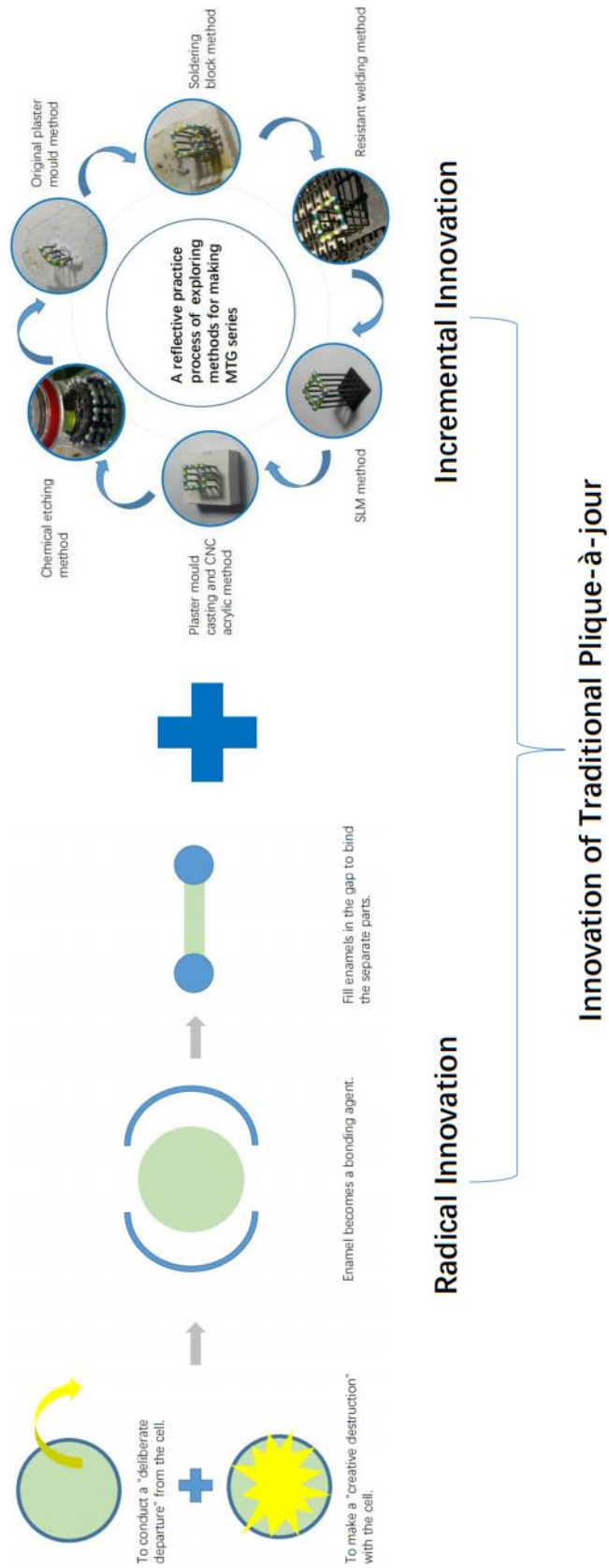


Figure 130. The process of innovating traditional plique-à-jour: radical innovation and incremental innovation.



## 5.5 Embracing failure

The process of craft innovation requires failure. However, for many traditional artisans, it seems unacceptable for failure or mistakes to be made in the process of craft practice. Traditional craftsmen have this perception mainly because of the way traditional crafts are passed down through the craft apprenticeship (Stein, 2019). The major difference between craft and many other specialised disciplines is that knowledge of craft cannot be acquired through books alone, but needs to be passed on through a master, especially in some ancient and undocumented handcrafted skills. In traditional craft training, the traditional apprenticeship requires the apprentice to learn a skill completely as taught by the master, repeating the same actions every day without any changes, until the skill is mastered (Gamble, 2001). In premodern England, an apprentice took around seven years to train, while elsewhere in Europe it can take as little as three to five years (Wallis, 2008). As already mentioned, I studied enamel craft in China with a master for three months (see Chapter 1). Although I cannot say that this was strictly an apprenticeship, it was a basic experience of this mode of training unique to this craft. In the East, especially among traditional craftsmen who are influenced by Zen thought, this repetitive labour is often seen as a process of inner cultivation to gain a calm state and maintain focus. Obviously, craftsmen under this training system do not produce crafts that do not meet expectations or which are supposedly substandard, because their practice is based on the valid experience of their predecessors. As long as they follow the master's production methods to the letter, there will be no deviations, let alone failures.

However, innovation requires failure, especially intelligent failure (Sitkin, 1996). Professor Amy Edmondson (2011) from the Harvard Business School argued that failure can sometimes be understood as 'good'. In the case of basic science, researchers tend to fail in 70% of their experiments and succeed in only a few.

These scientific researchers realise that although failure is not an option for them, they are often at the leading edge of scientific discovery and these failures convey valuable information. Edmondson agrees with Sitkin's view and further states that, discovering new drugs, creating a radically new business, designing an innovative product, and testing customer reactions in a brand-new market are tasks that require intelligent failures.

There were 62 experiments conducted in this study. If it is based on the criterion established at the beginning of this study that the fracture of enamel pieces after the removal of the scaffolding is a failure, nearly three quarters of the experiments were unsuccessful. However, it was the experience gained from numerous failures that eventually led to the effective method of creating the MTG series. As previously described, Frayling believes that writing is practice, making art is practice, and designing is practice. Therefore, can we see failure as a kind of practice? If people often say knowing by making, can we also say knowing by failing? I have gained a new understanding of failure through this research and see failure as a way of knowing things and creating new things. Let us gain the courage to embrace failure. As Elon Musk (2020) said, "if things are not failing, you are not innovating enough".

## **5.6 The model of innovating traditional craft**

This research has developed the MTG series from traditional plique-à-jour, at the core of which is innovation of traditional craft. Below I summarise a systematic approach and model (Figure 131) for innovating traditional craft using the process of creating traditional plique-à-jour as an example (case study). This approach provides a valuable reference for future practitioners and researchers in the field of craft and design.

The first step is to capture the knowledge of the traditional craft. A prerequisite for innovating in traditional craft is in-depth knowledge and mastery of how that craft is made. In the field of craft, traditional craft is generally taught and acquired through a strict apprenticeship, academic education system, or self-taught. Making knowledge of traditional crafts, especially tacit knowledge, cannot be acquired by reading books alone, but rather through repetitive and long-term practice. Having acquired basic production knowledge of a craft, the next step is to analyse works made by this craft in the past and currently, to draw out the common character in these pieces and their reasons. According to Adamson (2007) and Kjørup (2018), there are four factors that form a craft: technique, material, design, and meaning. The common character of a traditional craft is largely a result of an interaction of these four factors. For example, the common character of the traditional plique-à-jour is its cellular structure, which is produced from a technique used in the past to make the metal framework of the plique-à-jour along with an understanding of enamel.

For traditional crafts, the common character is that they are long-established, stable, and closed. This is because many traditional crafts are effective making methods that have been accumulated and passed down by people over generations, including the use of tools, and the choice and understanding of materials. This method usually corresponds to the values (meaning) of particular groups of people or cultures, and may even lead to a set of aesthetic criteria for the craft (design as style in this context). For example, in the case of traditional enamelling technique, fully melted enamel is regarded as success, whereas a firing that is not fully melted and still has a sandy effect of the enamels is seen as a failure. These are all key factors that bind a traditional craft to change. These elements (technique, material, design, meaning) are intertwined to form a closed metaphorical “cell”. On the one hand, this

metaphorical cell protects the knowledge of the traditional craft and its common character, and allows it to be passed on. On the other hand, this cell limits people's imagination and hinders the development of crafts. Therefore, to identify a common character of a traditional craft is to find the reasons that limits its development and to identify potential for innovation in that craft.

The second step is to implement radical innovation to leave the common character of the craft (Figure 131: step 2). Having identified the common character, the next step is to move on to the innovation phase of the craft. According to Robert Verganti's theory, there are two types of innovation, radical innovation and incremental innovation. While the former brings about changes in the frame and meaning of the product, the latter seeks to make an improvement to the product. Radical innovation and incremental innovation complement each other in the product innovation process (see Section 5.4). For innovation of traditional craft, both types of innovation are required. However, it is particularly important that innovation of traditional craft starts with radical innovation, namely a fundamental change in the meaning (Verganti, 2008; Battistella et al., 2012). To achieve radical innovation of craft, practitioners and researchers need to adapt the method of "deliberate departure" (Lehmann, 2012) to the common character of the craft, which is the cell that limits people's imagination and technological development. At this point, people can gain a clearer picture of the craft as an outsider.

The third step is to continue the radical innovation phase to break the common character of the craft (Figure 131: step 3). After departing from the cell, "creative destruction" (Schumpeter, 1942) is required to break the cell. After the cell is broken, the result of the craft is "the fundamental ontological rupture" and "radically different forms or concepts" (Lehmann, 2012: 151-152), which according to Verganti (2008: 436) is radical innovation ("radically changing the

emotional and symbolic content of products, i.e. their meanings and languages"). When the 'cell' is broken, the four elements that make up the craft are no longer restricted, but are rather in an open, unknown and unstable state (Figure 131: step 3). At this point, there is a great opportunity to offer new interpretation of the meaning, material, technique, and design to practitioners and researchers.

The fourth step is implementing incremental innovation, reuniting and refining. Once the radical innovation of the craft has been completed, the next step is the implementation of incremental innovation. Practitioners can implement the innovation from four elements of the craft, such as the incorporation of hybrid craft, the application of new materials, new design styling and a new cultural context. However, the prerequisite is to provide a new understanding of these four elements (radical innovation). In incremental innovation, practitioners and researchers need to use the bonding agent "practice" to bring together the four new elements, as seen in the role of enamel as the linking agent in the MTG series. Through reflective practice, or even repetitive practice conducted by practitioners and researchers, the four new elements are gradually brought together again to form a new, effective and stable system, and ultimately to create a new technique after a process of continuous refinement. It is important to note that incremental innovation is a process of accumulating new knowledge and experience. In this process, practitioners and researchers usually encounter many failures as previous experience cannot be drawn on to address the new issues. During the process of incremental innovation, failure plays a key role in the continuous improvement of the new craft and even as an approach to gathering new knowledge (see Section 5.5). In addition, unexpected discoveries can be made. For example, one of the most crucial contributions of this study, the multi-hole visual effect of the MTG series, was unintentionally created during the process of incremental innovation.

## **Summary**

The study and innovation of a traditional craft, in fact, is a dynamic and mutually reinforcing process (Figure 131: reflective cycle). Firstly, the knowledge accumulated in the learning of a traditional craft in the past is the basis for innovation of this craft. Moreover, traditional making knowledge sometimes provides effective solutions to the problems encountered in the innovation of new processes. The application of the traditional acid etching technique in this study to solve problems created by digital technology is an example. Secondly, radical innovation and incremental innovation are complementary in the innovation of traditional craft. Without incremental innovation, it is impossible to make the creative concepts that are proposed from radical innovation come to fruition. On the contrary, without incremental innovation, it is difficult to refine progress into usable outcomes. Finally, when the new concept proposed at the radical innovation phase is proven, and the new process is perfected through the incremental innovation phase, the new process is fixed again after a long period of time and becomes a new traditional craft, waiting for the next cycle of radical and incremental innovation.

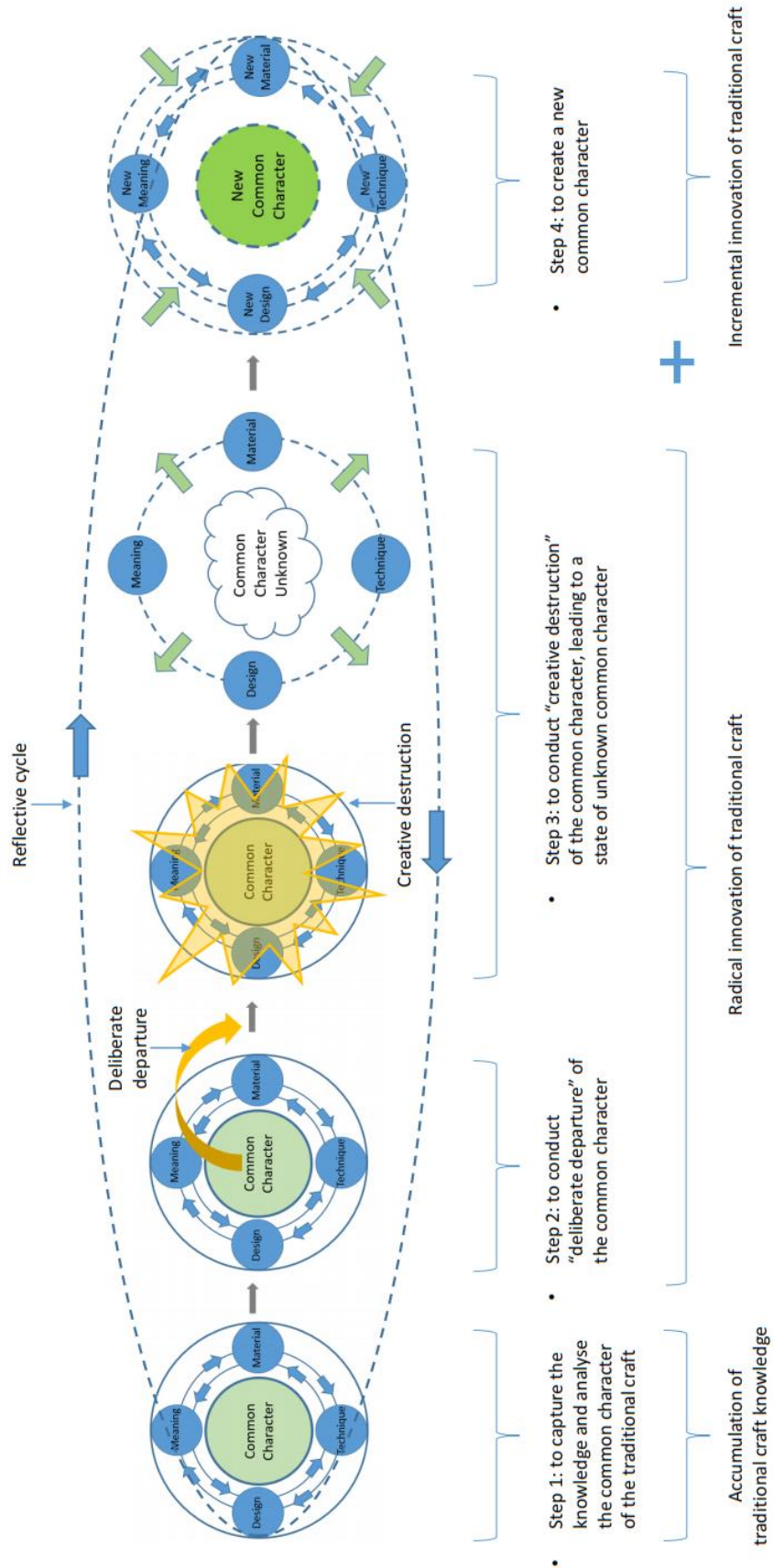


Figure 131. A model of innovating traditional craft., by the author.

### **Some misunderstandings of innovation in traditional craft**

Not all innovation in traditional crafts is radical. The role of radical innovation in traditional craft innovation is emphasised here because much of the research on innovation or revival of traditional crafts in the past has been broad. And the research is incremental innovation or refinement for traditional craft, rather than radical innovation. The following are three types of common misunderstanding.

Firstly, using the same traditional craft and changing the design style to fit modern aesthetics is not necessarily radical innovation. Some researchers would argue that the aesthetic of traditional crafts is not in tune with the times, and that design intervention should be used to innovate traditional crafts and create craft products that are in line with the “contemporary aesthetic” (Tung, 2012: 73) and “contemporary sensibilities” (Zhan, et al., 2017: s2927) to meet contemporary need. Design is then interpreted as a style (Battistella et al., 2012: 719). But how to define a timely aesthetic? Different countries, regions, and nations have their own aesthetics. In the digital age, it is difficult to define what is a contemporary aesthetic, and I would say that for a traditional craft, a change in pattern or artistic style without fundamental changes in the understanding of the craft is not a radical innovation.

Secondly, adding digital technology to an innovative traditional craft may not lead to radical innovation of the traditional craft. Take this study as an example, enamellist Amy Roper Lyons changed the traditional craft of making a metal framework to 3D modelling and precision casting in the process of making a plique-à-jour (see Section 2.7.1). Even if the more advanced digital technology SLM (direct metal printing) was applied in this study to produce a thinner, more delicate metal frame, this would not have resulted in radical innovation of the traditional plique-à-jour. Since the understanding of plique-à-jour has not changed fundamentally, enamel is still seen as a decorative material to be filled



in the cellular structure produced by SLM technology. Thus, the use of advanced digital technology to innovate traditional craft does not necessarily lead to radical innovation.

Thirdly, applying new materials does not always lead to a radical innovation of traditional techniques. All the metal-based enamel techniques of the past can be considered as “glass on metal”. If a newer type of enamel (glass) is melted onto the metal as a coating on the surface, then the relationship between enamel and metal has not fundamentally changed structurally. The MTG series of this study explores the structural relationship between vitreous enamel and metal parts in space. Enamel is no longer in the original 'on' relationship with metal but 'between' metal points in space.

Of course, the four elements of craftsmanship (meaning, material, technique, and design) are closely interrelated. It is not just one element that determines the radical innovation of traditional craft, but the combination of all four elements.

## **5.7 Summary of the research**

This study focuses on innovation in the traditional process of plique-à-jour. Through the study of different theories and repeated studio practice, this study has put forward a new enamel craft production method and visual language, and expanded the boundaries of plique-à-jour. In the process, many insights have been gained.

Firstly, previous practical experience played an important role in this study. Since 2007, I have been learning traditional metal crafts, including enamel crafts, and these craft practice experiences over the past fifteen years has laid

a firm foundation for this research. These past experiences not only provided the technical knowledge I needed to analyse plique-à-jour, but also helped the identification of the research gap and the introduction of the new concept of MTG. Moreover, this knowledge provided critical support when finding an effective solution to the design and production of MTG.

Secondly, the study of theories across different fields helped to promote practical innovation. At the beginning of the study, I read a lot of literature, including craft, design, and art, as well as the theories of business management and enterprise innovation. I gained inspiration from different theories and combined with the previous understanding of the traditional enamel process plique-à-jour, put forward the innovative concept of the MTG, which pointed the direction for subsequent studio practice.

Thirdly, reflective practice and failure in practice were key factors in realising the traditional process innovation. Since MTG is a new concept, previous making knowledge cannot fully support the achievement of the MTG series. Therefore, during the experiments, I failed many times. Through four stages of repeated experiments, I mastered the methods of designing and making with the MTG series and solved the first research problem of this study (see Chapter 4). On this basis, I further integrated design thinking, materials, and a variety of techniques to expand the possibilities of MTG, summarised the contributions of this study, and answered research questions 2 and 3 (see Chapter 5).

Finally, theory and practice are inseparable. The development of practice requires the promotion of theory, while new theory is based on the result of abundant practice. Craft is a combination of theory and practice as in many human activities. Today, theoretical research in craft should not be limited to the theory of art and design. moreover, the practice of craft is not just handcraft or

technology, but should be considered as a wider range of mixed applications of different knowledge.

## **5.8 Original Contribution**

After the theoretical studies and extensive studio practice, this research has resulted in four contributions to knowledge: a new approach to enamel craft, a new understanding of enamel material, a new visual language for enamel art, and a model of innovating traditional craft.

### **New method of making enamel work (echoing Q1)**

The MTG series that develops from plique-à-jour is a metal-based enamel. Enamel and metal scaffolding are two important components of the MTG series. There is a lot of time spent in exploring methods to construct and dismantle metal scaffoldings. After repetitive experiments and many failures, I finally found an effective and systematic model for the design and production of the MTG series, which consists of three aspects, the choice of materials, the design of the structure, and the application of the technology (see Chapter 4 and Chapter5). This new making method of enamel art answers the first research question (Q1). Certainly, there are still shortcomings in this approach. For example, the composition of enamels suitable for the MTG series has not been examined, and there are not many variations or very large objects of the MTG series, especially the scaffold-free types. These shortcomings should be investigated in future practice.

### **New understanding of enamel material (echoing Q1)**

The initial purpose of this research was to apply enamel as a bonding agent to connect orderly spheres and explore the potential of the connecting structures,

while the original aim of the experiment was to produce useful (i.e., applicable) knowledge (Michel, 2007: 16) rather than just aesthetics. However, this application-oriented design and practice created a new visual language. To some extent, this echoes Louis H. Sullivan's axiom – “form ever follows function” (1896: 408). In the past, enamellists tended to focus on surface effects such as the colour and transparency of the enamel, and the texture of the metal body, etc. The design and making methods of the MTG series differs significantly from the traditional aesthetics-oriented creation of enamel art. Thus, this research has offered a new understanding of enamel, in terms of the physical properties of the material (functional), rather than the visual effects of the material (aesthetic).

### **New visual language of enamel art (echoing Q2)**

After putting forward the innovative concept of the MTG, I applied enamel as a bonding agent to explore different forms of connection and structure with metal spheres. In an early series of experiments with a single-row structure, when the enamel was melted between two spheres at a certain distance from each other, a form similar to the model of hard diamond emerged. Moreover, when the single-row structure was transformed into a multi-row structure, the experimental result revealed the appearance of multiple holes within a perforated surface that is especially ordered but differentiated (see Section 5.4). This structure produces a special projection effect when exposed to light. These two effects are new discoveries in the visual language of enamel art and are some of the crucial contributions of this study, answering the second research question (Q2).

### **A model of innovating traditional craft (echoing Q3)**

The innovative methodological model of traditional crafts is the fourth and one of the most important contributions in this study, giving the answer to the third

research question (Q3). Looking back on the whole study, it is a journey of innovative exploration of traditional crafts from the traditional plique-à-jour to the new MTG series. In the study, I undergo the phase of accumulating and analysing the knowledge of producing the traditional craft, plique-à-jour, the phase of proposing the concept of the MTG (radical innovation), the phase of different experimental tests (incremental innovation), and finally developing a complete system of making and designing the new technology, the MTG. Based on this research, I have discovered approaches and methodology for innovating the traditional plique-à-jour. In the light of properties of traditional crafts, combined with the theory of radical and incremental innovation, I finally put forward a methodological model for effective innovation of traditional crafts that will provide valuable reference for future practitioners and researchers in the field of craft and design.

## **5.9 Areas for further research**

In reviewing this research, the boundaries of traditional plique-à-jour are expanded through a combination of different designs and techniques, thus, gaining several reflections and insights. There are also shortcomings to this research that can be further explored in the future. In the following, the potential possibilities for future research from the perspectives of technology, design and theory are considered.

Firstly, in terms of technology and materials, this study is the first to apply the advanced digital technology selective laser melting (SLM) in the creation and research of enamelling crafts. In the initial stage, I found that the application of SLM technology had not been described or studied in previous enamel practice. In this study, SLM technology is used to build precise scaffolds to provide

accurate data for the MTG series of experiments. At the beginning of the research, I tried firing enamels on sterling silver metallic substrate produced by the SLM technology. The results show that sterling silver metallic substrate produced by the SLM technology is suitable for enamel firing (see Appendix 1: E1). However, I did not deeply test the combination of enamel and metal spheres produced by the SLM technology in the MTG series of experiments. As a direct metal printing technology, the combination of SLM and enamel deserves further study especially in terms of the metal surface texture.

The second perspective relates to materials science. The MTG series of experiments in this study focused more on the physical properties of enamels (e.g., viscosity and thermal expansion), rather than the visual effects of enamels (e.g., colour and transparency). In the final stage of this study, I discovered a type of enamels - transparent silver white, which is suitable for the MTG series. However, due to time limitations, the chemical composition of this enamel was not analysed further. An important research direction for the future development of the MTG series includes gaining a greater understanding of the chemical component of enamels, and exploration of enamels that are suitable for the MTG series. Craft practice and materials are closely related. For craft design and creation, craftsmen or artists mainly consider the visual perspective first, thinking more about the colour and surface texture of the material. However, it is proposed here that material science is a crucial direction for the future development of craft. Practitioners and researchers can focus more on physical properties of materials combined with scientific experiments to create future crafts.

In the field of design, I no longer consider the shape of objects or the design of colours, but rather think about the relationship between MTG and its surroundings in a larger context. For traditional plique-à-jour, light is an

essential element. But the relationship between light and plique-à-jour has not been studied or explored in the past. Since MTG also needs light, it is worth thinking about how light, as a medium, can be more closely related to the MTG, which either captures, carries or omits light. Integrating space, projection, and other factors in the design of the MTG series is another area worthy of exploration in the future. Based on this idea, I believe that more designers and practitioners from different fields will become involved in the creation of the MTG series in the future, which will further expand the boundaries of this technique.

Finally, there is the theoretical side. For a long time, traditional crafts lacked a theoretical model that could bring radical and incremental innovation to crafts. Previous research on the revival of traditional crafts has mostly been considered from the perspective of changing styles to suit modern aesthetics or changing production methods to suit market demand, most of which is argued in general terms rather than in depth. Through this research, a theoretical model has been proposed for innovation that can fundamentally revolutionise a traditional craft. However, this model originates from a case study of traditional enamel craft study and current studio practice. The next step is to apply this model to different craft innovation projects with different craft practitioners and researchers. In doing so, the validity of the model can be tested in order to obtain more feedback and continuously improve the theoretical model, so that it can be used by a wider range of designers and practitioners across different fields.

## **5.10 Final remarks**

After many experiments and failures, this study reaches the research objectives

set out at the beginning of the study and answers the research questions. While achieving a breakthrough in plique-à-jour, the traditional enamel craft, the study proposes a methodological model of traditional craft innovation based on the characteristics of crafts and combined with radical and incremental innovation theory. This model replaces the previous methods of reviving traditional crafts based on design styles to suit popular aesthetics, or on production methods to meet mass production, or on market demand, and provides an effective path and framework for radical innovations in traditional crafts. The methodological model will also serve as a reference for designers, craft practitioners, and theoretical researchers in wider fields. In reviewing this research, I have gained different insights and suggestions which will be valuable for further research in the future.



# Glossary

- Bonding agent: Enamel as a medium for joining two separated metal spheres
- Compatibility: In terms of co-efficient of expansion rates, different enamels do not show visible cracks after melted at high temperatures.
- Copper oxide: heated metallic copper reacts with oxygen to form black copper oxide. Its formula is CuO. This substance prevents enamel adhesion and affects the colour and surface of the enamel.
- Enamel: A glassy material that is fused to the surface of metal objects.
- Enamelling: A process or technique that fuses enamel onto metal objects
- Etchant: A chemical substance used to etch metal objects, glass, or other materials.
- Ferric Chloride: An industrial chemical compound. When dissolved in water, this compound becomes a brown-red corrosive, acidic solution that is used to etch metals, such as copper, instead of fine silver. In this study, ferric chloride is used to etch the copper of the metal scaffold.
- Fluidity: Refers to a physical property of enamel. At high temperature, the enamel melts and flows. Different enamels have different fluidities.
- Frit: Different raw minerals are mixed and, placed in a preheated clay crucible. After being melted at high temperature, these raw materials

become viscous liquid. Then the molten glassy mass is poured into water to form a small fragment.

- Glass: A material composed of crystalline materials converted into a non-crystalline solid by high temperature.
- Granule: Small metal particle
- Granulation: A process or technique for making metallic granules
- Kiln: A device for fusing enamel onto metal objects
- Mesh: Refers to the size of the enamel grains. By sifting through different mesh screens, different sizes of enamel granules are produced. Mesh includes 80 mesh, 100 mesh, 200 mesh, and fines (325mesh) in the enamel industry.
- Pillar: A thin vertical metal structure that is part of a scaffold
- Plaster: A soft mixture of water with gypsum or lime. When the water evaporates, it becomes solid. Plaster is a versatile industrial and construction material used in plaster building products, model making, etc.
- Reactant: A substance formed during the chemical reaction between ferric chloride and copper part.
- Scaffold: A temporary platform built by metal pillars and other materials to support metal spheres and assist the firing of enamels.

- Selective laser melting (SLM): A 3D printing technology utilising a high power-density laser. During production, metallic powders are selectively melted and fused layer by layer to make 3D objects.
- Shotai-jippo: A traditional Japanese plique-à-jour process. The manufacturing method is similar to the enamel process cloisonné, except that after firing and polishing the enamel, the copper body is removed by acid etching, leaving only transparent enamel and metal wire. This technique is recorded as being introduced between 1900 and 1910.
- Sterling silver: Contains 92.50% fine silver and other different alloys, such as copper, zinc or palladium, making sterling silver stronger and more durable than fine silver (99.99% of silver)
- Thermal expansion: A feature of enamel. When enamel is melted, it expands; when the enamel is cooled, it contracts.
- Viscosity: A physical property of enamel. Resistance offered by fusion to flow.
- Vitreous enamel: At a specific temperature, a glassy inorganic metal oxide coating is fused to the metallic substrate.

# List of references

Adamson, G. (2007) *Thinking through craft*. Oxford: Berg.

Adner, R. and Snow, D. (2010). Old technology response to new technology threats: Demand heterogeneity and technology retreats. *Industrial and Corporate Change*, 19(5), pp. 1655-1675.

Anderson, C. (2013) *Makers: the new industrial revolution*. London: Random House Business Books.

Anttila, E. (2009) Critical issues in pedagogy and research: Perspectives on dance education theory and practice. *Congress on Research in Dance Conference Proceedings*, 41(S1), pp. 199-203. Available at: <https://www.cambridge.org/core/journals/congress-on-research-in-dance/article/abs/critical-issues-in-pedagogy-and-research-perspectives-on-dance-education-theory-and-practice/3D11F0C68B4C515D8C342A21E7976D84>.

Bachrach, L. (2006) *Contemporary enameling: art and techniques*. 2nd ed. Atglen, PA: Schiffer Publishing.

Barrett, E. (2007) Experiential learning in practice as research: context, method, knowledge. *Journal of visual art practice*, 6 (2). Available at: [https://www-tandfonline-com.bcu.idm.oclc.org/doi/pdf/10.1386/jvap.6.2.115\\_1](https://www-tandfonline-com.bcu.idm.oclc.org/doi/pdf/10.1386/jvap.6.2.115_1).

Barrett, E. and Bolt, B. (2010) *Practice as Research: Approaches to Creative Arts Enquiry*. London: I. B. Tauris & Company, Limited.

Battistella, C., Biotto G. and De Toni, A. F. (2012) From design driven innovation to meaning strategy. *Management decision*, 50 (4), pp. 718–743.

Bernabei, R. and Power, J. (2018) Hybrid design: Combining craft and digital practice. *Craft research*, 9 (1), pp. 119–134.

Blaxter, L., Hughes, C. and Tight, M. (2001) *How to research*. 2<sup>nd</sup> edn. London: Open University Press.

Bloom, B. S. (1969) *Taxonomy of educational objectives: The classification of educational goals: Handbook I, Cognitive domain*. New York: Mckay.

British Standards Institution (2017) *Vitreous and porcelain enamels – Terminology*. [pdf] Available at: <https://www.bsigroup.com/en-GB/standards/>. [Accessed 10 August 2021].

Burke, J.J. (2018) *Makerspaces: a practical guide for librarians*. Rowman & Littlefield.

Carpenter, W. W. (1982) Etymology of Enamel. *Glass on Metal*, 1(3), p. 65.

Carpenter, W. W. (2006) The Manufacture of Enamels. In: L. Bachrach, ed. *Contemporary enameling: art and techniques*. 2<sup>nd</sup> ed. Atglen, PA: Schiffer Publishing, pp. 18-28.

Çakır, O., Temel, H. A. M. D., and Kiyak, M. (2005) Chemical etching of Cu-ETP copper. *Journal of Materials Processing Technology*, 162. Available at: <https://www.sciencedirect.com/science/article/pii/S0924013605000816>.

Candy, L. (2006) Practice based research: A guide. *CCS report*, 1(2), pp. 1-19.

Charny, D. (2011) *Power of making: the importance of being skilled*. London: V&A Publishing and the Crafts Council.

Clarke, L. and Winch, C. (2004) Apprenticeship and Applied Theoretical Knowledge. *Educational philosophy and theory*, 36 (5), pp. 509–521.

Cohen, K. L. (2004) *The art of fine enameling*. New York: Chapelle.

Collingwood, R. G. (1958) *The principles of art*. Oxford: Oxford University Press.

Crane, W. (1892) *The claims of decorative art*. London: Lawrence and Bullen.

Cross, N. (1999) Natural intelligence in design. *Design studies*, 20 (1).

Available at:

<https://www.sciencedirect.com/science/article/pii/S0142694X9800026X>.

Cross, N. (2001) Designerly Ways of Knowing: Design Discipline versus Design Science. *Design issues*, 17 (3), pp. 49–55.

Crowe, C., Hustler, D. and Castonguay, G. (ca. 2013) *Fay Rooke*. Available at: <https://fireandfusion.wordpress.com/virtual-exhibition-2/fay-rooke/> [Accessed 17 July 2021].

Cunynghame, H. H. (2012) *On the theory and practice of art-enamelling upon metals*. 2<sup>nd</sup> ed. Milton keynes: Lightning source.

Darty, L. (2006) *The art of enameling : techniques, projects, inspiration*. New York.

De Massis, A., Frantini, F., Kotlar, J., Petruzzelli, A. M. and Wright, M. (2016) INNOVATION THROUGH TRADITION: LESSONS FROM INNOVATIVE FAMILY BUSINESSES AND DIRECTIONS FOR FUTURE RESEARCH. *Academy of Management perspectives*, 30 (1), pp. 93–116.

Dewey, J. (1997) *How we think*. Mineola, N.Y: Dover Publications.

Di Minin, A. and Faems, D. (2013) Building Appropriation Advantage: An Introduction to the Special Issue on Intellectual Property Management. *California management review*, 55 (4), pp. 7–14.

Dobel, J. P. (2001) Paradigms, Traditions, and Keeping the Faith. *Public administration review*, 61 (2), pp. 166–171.

Dormer, P. (1997) *The Culture of craft: status and future*. Manchester: Manchester University Press.

Durling, D. (2002) Discourses on research and the PhD in Design. *Quality Assurance in Education*, 10(2). Available at: <https://doi.org/10.1108/09684880210423564>.

Edmondson, A. C. (2011) Strategies for learning from failure. *Harvard business review*, 89(4), pp. 48-55.

Frayling, C. (1993) Research in art and design. *Royal College of Art research*

*papers*, 1, pp. 1-5.

Frayling, C. (2011) We must all turn to the crafts. In D. Charny, ed. *The Power of Making*. London: V&A Publishing, pp. 28-33.

Friedman, K. (2000) Creating design knowledge: from research into practice. In: *IDATER 2000 conference*. Loughborough, August 2000, pp. 5-32. Available at:

<https://citeseerx.ist.psu.edu/document?repid=rep1&type=pdf&doi=452ed916fe8c67fc5e788a2fc4caa736ae3c2e13>. [Accessed 20 June 2022].

Friedman, K. (2002) Theory construction in design research. Criteria, approaches, and methods. In: *Common Ground - DRS International Conference*. London, 5-7 September, 2002. DRS Digital Library, pp. 1-26.

Gamble, J. (2001) Modelling the Invisible: the pedagogy of craft apprenticeship. *Studies in continuing education*, 23(2), pp. 185-200.

Gauntlett, D. (2011) *Making is connecting the social meaning of creativity from DIY and knitting to YouTube and Web 2.0*. Cambridge: Polity Press.

Giddens, A. (2002) *Runaway World*. London: Profile.

Glynn, S. (1985) Science and perception as design. *Design Studies*, 6(3), pp. 122-126.

Gnesin, G. G. (2016) Revisiting the History of Materials Science Glass, Glaze, and Enamel over the Millennia. I. Glass. *Powder metallurgy and metal ceramics*, 54 (9-10), pp. 624–630.



Golsteijn, C. (2014) *Hybrid craft: towards an integrated physical-digital craft practice*. Ph.D. Thesis. University of Surrey.

Gray, C. and Malins, J. (2004) *Visualizing research a guide to the research process in art and design*. Aldershot: Ashgate.

Greenhalgh, P. (1997) The history of craft. In: D. Peter, ed. *The Culture of Craft: Status and Future*. Manchester: Manchester University Press, pp. 20-52.

Groth, C., Mäkelä, M. and Seitamaa-Hakkarainen, P. (2015) Tactile Augmentation: A Multimethod for Capturing Experiential Knowledge. *Craft Research*, 6(1), pp.57–81.

Guile, D. and Young, M. (1999) Beyond the institution of apprenticeship: Towards a social theory of learning as the production of knowledge. In: A. Partrick and R. Helen, eds. *Apprenticeship: Towards a New Paradigm of Learning*. London: Kogan Page.

Hart, C. (1998) *Doing a Literature Review: Releasing the Social Science Research Imagination*. London: SAGE.

Hartung, R. (1965) *Colour and texture in creative textile craft: colour and texture*. London: Batsford.

Hatch, M. (2014) *The maker movement manifesto: Rules for innovation in the new world of crafters, hackers, and tinkerers*. New York: McGraw Hill.

Helwig, B. (1992) Plique-à-jour – Valeri Timofeev. *Glass on Metal*, 11 (3), pp. 58-63.

Hibbert, P. and Huxham, C. (2011). The carriage of tradition: Knowledge and its past in network contexts. *Management Learning*, 42(1), pp.7-24.

Hobsbawm, E. (1983) Introduction: Inventing Traditions. In: E, Hobsbawm and T, Ranger, eds. *The Invention of Tradition*. Cambridge: Cambridge University Press, pp. 1-14.

Holmquist, A., Magnusson, M. and Livholts, M. (2019) Reinventing tradition: Exploring the creation of new meaning through innovations involving craft - based design. *Creativity and Innovation Management*, 28(1), pp. 124–137.

Ingold, T. (2009) The textility of making. *Cambridge journal of economics*, 34 (1), pp. 91–102.

Ingold, T. (2013) *Making: anthropology, archaeology, art and architecture*. Abingdon, Oxon: Routledge.

Jansen, M. A. (2016) *Moroccan fashion design, tradition and modernity*. London: Bloomsbury.

Jarvis, P. (1999). *The Practitioner-Researcher. Developing Theory from Practice*. San Francisco: Jossey-Bass.

Jefferies, J. (2011) Loving Attention: An Outburst of Craft in Contemporary Art. In: M. E. Buszek, ed. *Extra/Ordinary*. New York: Duke University Press. pp.

222–240.

Johansson, M. and Porko-Hudd, M. (2012) Editorial. Making, Materiality and Knowledge. *Techne A*, 20(3), pp. 1-3.

Johnston, L. (2017) *Digital handmade: craftsmanship in the new industrial revolution*. New edition. London: Thames & Hudson.

Jönsson, L. (2007) Rethinking Dichotomies: Crafts and the Digital. In: S. Alföldy, ed. *NeoCraft: Modernity and the Crafts*. Halifax NS: Press of the Nova Scotia College of Art and Design, pp. 240-48.

Jones, C. J. F. P. (1984) Design and construction methods. In: *Polymer grid reinforcement*. London, 22-23 March 1984. London: Thomas Telford Publishing, pp. 183-190.

Kane, F., Nimkulrat, N., and Walton, K. (2016) Introduction. In: N. Nimkulrat, F. Kane and K. Walton, eds. *Crafting Textiles in the Digital Age*. London: Bloomsbury Academic, pp. 1-13.

Kapp, L., Kapp, H. and Yoshihara, Y. (1987) *The Craft of the Japanese Sword*. Tokyo: Kodansha International.

Kelly, D. (2009) Methods for evaluating interactive information retrieval systems with users. *Foundations and Trends® in Information Retrieval*, 3(1–2). Available at: <http://dx.doi.org/10.1561/1500000012>.

Kim, W. C. and Mauborgne, R. (2005) *Blue ocean strategy: how to create uncontested market space and make the competition irrelevant*. Boston,

Mass: Harvard Business School.

Kim, W. C. and Mauborgne, R. (2005) Blue Ocean Strategy: From Theory to Practice. *California management review*, 47 (3), pp. 105–121.

KjØrup, S. (2018) Art as the other? Reflections on craft's and fine art's places in the aesthetic field. In: K. A. Bull and A. Gali, eds. *Material Perceptions*. Oslo: Norwegian Crafts, pp. 11-27.

Krippendorff, K. (1989) On the Essential Contexts of Artifacts or on the Proposition That 'Design Is Making Sense (Of Things)'. *Design issues*, 5 (2), pp. 9–39.

Kristiansen, H. T. and Gausdal, A. H. (2018) Design-driven innovation in design practice: The case of designing a ship-bridge vision. *Formakademisk*, 11 (5), pp. 1–18.

Lambert, I. (2019) *Narrative of Making: Modes of Articulating Tacit Knowledge*. Ph.D. Thesis. University of Edinburgh.

Lawson, B. (2005) *How Designers Think: Demystifying the Design Process*. Jordan Hill: Taylor & Francis Group.

Lehmann, U. (2012) Making as Knowing: Epistemology and Technique in Craft. *The journal of modern craft*, 5 (2), pp. 149–164.

Leonard-Barton, D. (1992) Core capabilities and core rigidities: A paradox in managing new product development. *Strategic management journal*, 13 (S1), pp. 111–125.

Lieberman, M. B. and Montgomery, D. B. (1988) First-mover advantages. *Strategic management journal*, 9(S1), pp. 41-58.

Mäkelä, M. and Nimkulrat, N. (2018) Documentation as a practice-led research tool for reflection on experiential knowledge. *FormAkademisk*, 11(2). Available at:

<https://web.s.ebscohost.com/ehost/pdfviewer/pdfviewer?vid=0&sid=3a1ecb25-9455-4324-af41-c5ce31535106%40redis>.

Malins, J., Gray, C., Bunnell, K., and Wheeler, E. (1995) *Appropriate Research Methodologies for Artists, Designers, and Craftspersons: Research as a Learning Process*. Malins and Gray. Available at:

<http://www.carolegray.net/assets/cc.pdf>.

Manghani, S. (2021) Practice PhD toolkit. *Journal of visual art practice*, 20 (4). Available at:

<https://web.p.ebscohost.com/ehost/pdfviewer/pdfviewer?vid=0&sid=593ba150-cc86-4c23-9db8-af6422961959%40redis>.

Mann, S. (2016) *The research interview: reflective practice and reflexivity in research processes*. Basingstoke: Palgrave Macmillan.

McCullough, M. (1996) *Abstracting craft: the practiced digital hand*. Cambridge, Massachusetts: MIT Press.

McKernan, J. (1999) *Curriculum Action Research*. 2<sup>nd</sup> edn. London: Kogan Page.

Metcalf, B. (2002) Contemporary craft: a brief overview. In: J. Johnson, ed. *Exploring Contemporary Craft: History, Theory and Critical Writing*. Toronto: Coach House Books, pp. 13-23.

Michel, R. (2007) *Design research now: Essays and selected projects*. Basel, Switzerland: *Birkhauser*.

Miles, M B., Huberman, A. M. and Saldaña, J. (2014) *Qualitative data analysis: a methods sourcebook*. 3<sup>rd</sup> edn. Thousand Oaks, California: SAGE Publications, Inc.

Miller, D. (2011) The Power of Making. in Charny, D., ed. *Power of Making: the importance of being skilled*. London: V&A Publishing and the Crafts Council, pp. 14-23.

Moran, A. and O'Brien, S. (2014) *Love objects: emotion, design, and material culture*. London: Bloomsbury.

Morris, A. (2012) Seeking new ways of living community in the classroom and the world: an action research study. *Research in dance education*, 13 (2).

Available at:

<https://www.tandfonline.com/doi/full/10.1080/14647893.2012.685465>.

Nelson, R. (2013) *Practice as Research in the Arts: Principles, Protocols, Pedagogies, Resistances*. London: Palgrave Macmillan UK.

Newson, A., Suggett, E., and Sudjic, D. (2017) *Designer Maker User*. London: Phiadon.

Nimkulrat, N. (2007) The Role of Documentation in Practice-Led Research. *Journal of research practice*, 3 (1), Article M6.

Nimkulrat, N. (2009) Paperiness: *expressive material in textile art from an artist's viewpoint*. Aalto University Learning Centre. Available through: <https://aaltodoc.aalto.fi/handle/123456789/11893>.

Nimkulrat, N. (2012) Hands-on intellect: Integrating craft practice into design research. *International journal of design*. 6 (3), pp. 1–14.

Nimkulrat, N. (2013) Situating Creative Artifacts in Art and Design Research. *Formakademisk*, 6 (2). Available at: <https://web.p.ebscohost.com/ehost/pdfviewer/pdfviewer?vid=0&sid=c16568e2-7b2b-46bb-9b93-1ad6461dfebb%40redis>.

Nimkulrat, N., Kane, F. and Walton, K. (2016) *Crafting Textiles in the Digital Age*. London: Bloomsbury Academic.

Norman, D. A. and Verganti, R. (2014) Incremental and Radical Innovation: Design Research vs. Technology and Meaning Change. *Design issues*, 30 (1), pp. 78–96.

Ostoia, V. (1945) A Late Mediaeval Plique-à-Jour Enamel. *The Metropolitan Museum of Art Bulletin*, 4(3). Available at: <https://www.jstor.org/stable/3258004>.

Petruzzelli, A. M., Rotolo, D. and Albino, V. (2012) The impact of old technologies on innovation: the case of the US biotechnology industry. *Technology Analysis & Strategic Management*, 24(5), pp. 453–466.

Polanyi, M. (1983) *The tacit dimension*. Gloucester, Mass: Peter Smith.

Porter, V. and Rosser-Owen, M. (2012) *Metalwork and material culture in the Islamic World: art, craft and text: essays presented to James W. Allan*. London: I.B. Tauris & Co, Ltd.

Pye, D. (1968) *The nature and art of workmanship*. Cambridge: Cambridge University Press.

Ratto, M. (2011) Critical Making: Conceptual and Material Studies in Technology and Social Life. *The Information Society*, 27 (4), pp. 252–260.

Redstrom, J. (2017) *Making Design Theory*. Cambridge MA: MIT Press.

Risatti, H. (2007) *A theory of craft function and aesthetic expression*. Chapel Hill: University of North Carolina Press.

Rossi, C. (2013) Bricolage, Hybridity, Circularity: Crafting Production Strategies in Critical and Conceptual Design. *Design and culture*, 5 (1), pp. 69–87.

Rothenberg, P. (1969) *Metal enameling*. London: Allen & Unwin.

Schön, D. A. (1983) *The reflective practitioner how professionals think in action*. New York: Basic Books.

Schumpeter, J. A. (1942) *Capitalism, Socialism, and Democracy*. New York: Harper & Brothers.



Scrivener, S. (2002) Characterising Creative-production Doctoral Projects in Art and Design. *International Journal of Design Sciences and Technology*, 10(2), pp. 25–44.

Shelby, J.E. (2005) *Introduction to Glass Science and Technology*. 2<sup>nd</sup> edition. Cambridge: Royal Society of Chemistry.

Shi, J. F. (2012) *Radiant Luminance: The Painted Enamelware of the Qing Imperial Court*. Taipei: National Palace Museum.

Shillito, A. M. (2013) *Digital crafts: industrial technologies for applied artists and designer makers*. London: Bloomsbury.

Shils, E. (1981) *Tradition*. University of Chicago Press: Chicago.

Shiner, L. (2012) ‘Blurred Boundaries’? Rethinking the Concept of Craft and its Relation to Art and Design. *Philosophy compass*, 7 (4), pp. 230–244.

Sitkin, S. B. (1996) Learning through failure: The strategy of small losses. In: M. D. Cohen and L. S. Sproull, eds. *Organizational learning*. Thousand Oaks, CA: Sage, pp. 541-578.

Sørensen, J. B. and Stuart, T. E. (2000) Aging, Obsolescence, and Organizational Innovation. *Administrative science quarterly*, 45 (1), pp. 81–112.

Speel, E. (1992) Plique-à-jour. *Glass on Metal*, 11 (3), pp. 56-59.

Stein, J. A. (2019) The Production of Toolboxes and Hand Tools in Industrial Craft Apprenticeship. *The journal of modern craft*, 12 (3), pp. 233–254.

Sullivan, L. H. (1896) The Tall Office Building Artistically Considered. *Lippincott's Magazine*, 57, pp. 403-409.

Taylor, J. and Townsend, K. (2014) Reprogramming the hand: Bridging the craft skills gap in 3D/digital fashion knitwear design. *Craft Research*, 5, pp. 155-174.

Teece, D. J. (2006) Reflections on 'Profiting from Innovation'. *Research policy*, 35 (8), pp. 1131–1146.

The Space Archive (2020) *Elon Musk Interview from Air Warfare Symposium 2020*. [Video] Available at: <https://www.youtube.com/watch?v=sp8smJFaKYE&t=171s> [Accessed 16 September 2022].

Thompson, J. B. (1990) *Ideology and modern culture: critical social theory in the era of mass communication*. Cambridge: Polity.

Tin, M. B. (2013). Making and the sense it makes. *FormAkademisk*, 6(2). Available at: <https://doi.org/10.7577/formakademisk.650> [Accessed 15 August 2021].

United Nations Educational, Scientific and Cultural Organization (2020) *What is Intangible Cultural Heritage?* Available at: <https://ich.unesco.org/en/what-is-intangible-heritage-00003/> [Accessed 19 August 2021].

Tung, F. W. (2021) An Entrepreneurial Process to Build a Sustainable Business for Indigenous Craft Revitalization. *The Design Journal*, 24 (3), pp. 363–383.

Utterback, J. M., Vedin, B.-A., Edvardo, A., Ekman, S., Sanderson, S. W., Tether, B. and Verganti, R. (2006) *Design-inspired innovation*. Singapore: World Scientific Publishing Co.

Verganti, R. (2003) Design as brokering of languages: Innovation strategies in Italian firms. *Design Management Journal*, 14 (3), pp. 34–42.

Verganti, R. (2008) Design, Meanings, and Radical Innovation: A Metamodel and a Research Agenda. *The Journal of product innovation management*, 25 (5), pp. 436–456.

Verganti, R. (2009) *Design-driven innovation changing the rules of competition by radically innovating what things mean*. Boston, Mass: Harvard Business Press.

Verganti, R. (2011) Radical Design and Technology Epiphanies: A New Focus for Research on Design Management. *The Journal of product innovation management*, 28 (3), pp. 384–388.

Veryzer, R. W. (1998) Discontinuous Innovation and the New Product Development Process. *The Journal of product innovation management*, 15 (4), pp. 304–321.

Wallis, P. (2008) Apprenticeship and training in premodern England. *The Journal of economic history*, 68(3), pp. 832-861.

Wang, J. and Wallendorf, M. (2006) Materialism, status signaling, and product satisfaction. *Journal of the Academy of Marketing Science*, 34 (4), pp. 494–505.

Wang, M. and Pan, N. (2008) Predictions of effective physical properties of complex multiphase materials. *Materials Science & Engineering R: Reports*, 63(1). Available at:  
<https://www.sciencedirect.com/science/article/pii/S0927796X08000673>.

Woolley, M., Huddleston, R. (2016) Maintaining the Human Touch Exploring “Crafted Control” within an Advanced Textile Production Interface. In: N. Nithikul, K. Faith and W. Kerry, eds. *Crafting Textiles in the Digital Age*. London: Bloomsbury Academic, pp. 91-102.







Zhan, X. and Walker, S. (2019) Craft as Leverage for Sustainable Design Transformation: A Theoretical Foundation. *The Design Journal*, 22 (4), pp. 483–503.

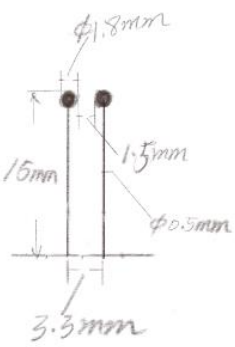


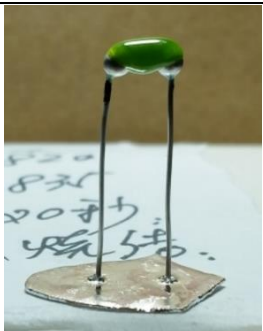


Zhan, X., Walker, S., Hernandez-Pardo, R. and Evans, M. (2017) Craft and sustainability: Potential for design intervention in crafts in the Yangtze River Delta, China. *The Design Journal*, 20(1), pp. S2919-S2934.






Zoran, A. and Buechley, L. (2013) Hybrid Reassemblage: An Exploration of Craft, Digital Fabrication and Artifact Uniqueness. *Leonardo*, 46(1). Available at:  
<https://web.s.ebscohost.com/ehost/pdfviewer/pdfviewer?vid=0&sid=c7d99df7-b3cc-4c8a-957f-c7e7876d1ace%40redis>.

Zoran, A., Shilkrot, R., Nanyakkara, S. and Paradiso, J. (2014) The hybrid artisans: A case study in smart tools. *ACM Transactions on Computer-Human Interaction (TOCHI)*, 21(3), pp. 1-29.

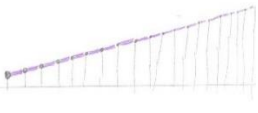





# Appendix 1: Material testing

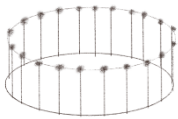




<b>Experiment Title</b>	E1-Enamelling on selective laser melting (SLM) metal part test		
<b>Date</b>	22.11.2019		
<b>Location</b>	Tech Hub, School of Jewellery, Birmingham City University		
<b>Participant</b>	Researcher/practitioner: Yinglong Li		
<b>Objective</b>	To test the possibility of melting enamels onto the surface of metal part produced by selective laser melting (SLM) technology.		
<b>Process design</b>	1.Produce the metal pieces by SLM machine; 2.Enamelling on the metal pieces		
<b>Materials</b>	sterling silver, vitreous enamel (transparent pink colour, China)		
<b>Dimensions</b>	Metal piece (round shape): height: 3.0 mm, diameter: 10.0mm		
<b>Facility and tool</b>	SLM printing machine "PRECIOUS M 080", produced by Cooksongold. Kiln for melting enamels.		
Image (Camera/Scan/CAD )	 <p>Printing process</p>	 <p>The printing result</p>	 <p>Remove the printed pieces by piercing and cutting</p>
	 <p>Two printed metal pieces before enamelling</p>	 <p>Put the testing piece into the kiln</p>	 <p>The outcomes</p>
<b>Observation</b>	The metal piece turned black after melting the enamels at around 800°C for 50 seconds.		
<b>Evaluation</b>	<p>This is the first time of melting enamels onto the surface of metal part produced by SLM technology in enamel art.</p> <p>SLM technology is able to produce a precise metal object that is feasible for enamelling. However, the metal powder for the SLM machine is sterling silver, leading to a black appearance after a melting in the kiln.</p>		





<b>Experiment Title</b>	E2-Initial connecting test (two silver spheres)		
<b>Date</b>	15.05.2020		
<b>Location</b>	Individual studio		
<b>Participant</b>	Researcher/practitioner: Yinglong Li		
<b>Objective</b>	To test the feasibility of connecting two silver spheres with enamel		
<b>Process design</b>	1. Make metal scaffolding; 2. Apply and melt enamels		
<b>Materials</b>	Fine silver, vitreous enamel (transparent green “浅黄绿”, China)		
<b>Dimensions</b>	Metal part: silver sphere: diameter: 2.2-3.0mm; pillar: diameter: 0.5mm.		
<b>Facility and tool</b>	Torch for soldering; spatula; kiln for melting enamels		
<b>Time and temperature for melting enamel</b>	Time last for: 20-30s/melt Temperature: 810-820°C		
<b>Image</b> (Camera/Scan/CA D)	 <p>Sketch-2 spheres</p>	 <p>2-1.2mm (two spheres-distance between the two spheres)</p>	 <p>2-2.0mm</p>
	 <p>2-4.0mm</p>	 <p>2-5.0mm</p>	 <p>2-5.5mm</p>
<b>Observation</b>	The enamels melted and covered the top of the silver spheres. The scaffolding parts are not regular.		
<b>Evaluation</b>	It is able to apply and melt enamels in the gap between two silver spheres. A bigger distance between two spheres made it easier to melt the enamels onto the upper surface of the spheres.		

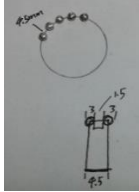
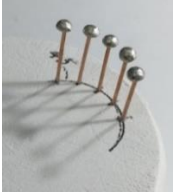
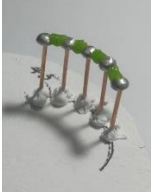


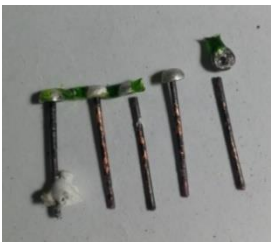
<b>Experiment Title</b>	E3-Initial connecting test (three silver spheres)		
<b>Date</b>	16.05.2020		
<b>Location</b>	Individual studio		
<b>Participant</b>	Researcher/practitioner: Yinglong Li		
<b>Objective</b>	To test the feasibility of connecting three silver spheres with enamel		
<b>Process design</b>	1.Make metal scaffolding; 2. Apply and melt enamels		
<b>Materials</b>	Fine silver, vitreous enamel (transparent green “浅黄绿”, China)		
<b>Dimensions</b>	Metal part: silver sphere: diameter: 2.2-3.0mm; pillar: diameter: 0.5mm.		
<b>Facility and tool</b>	Torch for soldering; spatula; kiln for melting enamels;		
<b>Time and temperature for melting enamel</b>	Time last for: 20-30s/melt Temperature: 810-820℃		
<b>Image</b> (Camera/Scan/CAD)	 Sketch-3 spheres	 2-1.8mm	 2-1.8mm
	 2-2.5mm	 2-4.8mm	
<b>Observation</b>	The enamels melted and covered the top of the silver spheres. The scaffolding parts are not regular.		
<b>Evaluation</b>	These experiments demonstrate that melting enamels in the gap between three silver spheres is feasible. A bigger distance between three spheres made it easier to melt the enamels onto the upper surface of the silver spheres. The method of creating the scaffolding part was soldering by hand mode, leading to the difficulty of achieving a precise metal part.		














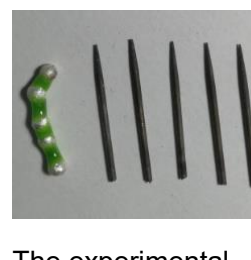
<b>Experiment Title</b>	E4-Initial connecting test (enamel: linear shape)		
<b>Date</b>	04.07-05.07.2020		
<b>Location</b>	Individual studio		
<b>Participant</b>	Researcher/practitioner: Yinglong Li		
<b>Objective</b>	<ol style="list-style-type: none"> <li>1. To test the possibilities of using enamel as a bonding agent.</li> <li>2. To test different forms of combination (linear shape).</li> <li>3. To test the possibility of removing the supporting structure.</li> </ol>		
<b>Process design</b>	1.Scaffolding structure design (sketches); 2. Make metal structure by soldering; 3. Apply and melt the enamels; 4. Remove the support part; 5. Conduct the 2 <sup>nd</sup> time of melting.		
<b>Materials</b>	Metal part: fine silver Enamel: vitreous enamel (transparent green “浅黄绿”, China)		
<b>Dimensions</b>	Metal part: silver sphere: diameter: 2.0mm; pillar: height: 5.0-15.0mm, diameter: 0.5mm. Enamel: 100 mesh		
<b>Facility and tool</b>	Metal part: welding torch, saw, pliers side cutter Enamel: kiln, spatula		
<b>Time and temperature for melting enamel</b>	Time last for: 20-30s/melt Temperature: 820-826℃		
Image (Camera/Scan/CAD )	 Sketch-Linear permutation	 Metal scaffolding part	 Applied enamel before firing
	 After melting the enamels	 After removing parts of the metal pillars	 The enamel piece collapsed after the 2 <sup>nd</sup> time of melting.
<b>Observation</b>	It is difficult to achieve a precise scaffolding by handmade mode. The enamel part presents a degree of uneven effect. The testing piece without support structure becomes more fragile.		
<b>Evaluation</b>	The enamel work without the supporting structure cracked and collapsed easily. The testing piece without pillar supporting can not be melted again. Temperature and time of melting are the two important factors to consider in the following experiment.		







<b>Experiment Title</b>	E5-Initial connecting test (enamel: circular shape)		
<b>Date</b>	06.07.2020		
<b>Location</b>	Individual studio		
<b>Participant</b>	Researcher/practitioner: Yinglong Li		
<b>Objective</b>	<ol style="list-style-type: none"> <li>1. To test the possibilities of using enamel as a bonding agent.</li> <li>2. To test different forms of combination (circular shape).</li> <li>3. To test the possibility of removing the supporting structure.</li> </ol>		
<b>Process design</b>	<ol style="list-style-type: none"> <li>1. Scaffolding structure design (sketches);</li> <li>2. Make metal structure by soldering;</li> <li>3. Apply and melt the enamels;</li> <li>4. Remove the support part;</li> <li>5. Conduct the 2<sup>nd</sup> time of melting.</li> </ol>		
<b>Materials</b>	Metal part: fine Silver Enamel: vitreous enamel (transparent green “浅黄绿”, China)		
<b>Dimensions</b>	Metal part: silver sphere: diameter: 2.5mm; pillar: height: 15.0mm, diameter: 0.5mm. Enamel: 100 mesh		
<b>Facility and tool</b>	Metal part: welding torch, saw, pliers side cutter Enamel: kiln, spatula		
<b>Time and temperature for melting enamel</b>	Time for melting: 20-30s/melt Time of melting: 1 Temperature: 820-826℃		
<b>Image</b> (Camera/Scan/CAD)	 Sketch-circular shape	 Metal scaffolding	 Apply enamel before firing
	 After melting the enamels	 After removing parts of the metal pillars	
<b>Observation</b>	The metal scaffold is not a regular shape. The enamel dropped easily when I applied them to the gaps. The testing result without pillar supporting is more fragile.		
<b>Evaluation</b>	This experiment demonstrates the feasibility of the MTG concept but requires more testing.		







<b>Experiment Title</b>	E6-Initial connecting test (enamel: a group of spheres)		
<b>Date</b>	15.05.2020		
<b>Location</b>	Individual studio		
<b>Participant</b>	Researcher/practitioner: Yinglong Li		
<b>Objective</b>	To test different forms of combination (a group of spheres) by using enamel as bonding agent.		
<b>Process design</b>	1.Design sketch; 2. Make metal scaffolding part; 3. Apply and melt enamels		
<b>Materials</b>	Metal part: fine Silver Enamel: vitreous enamel (transparent green “浅黄绿”, China)		
<b>Dimensions</b>	Metal part: sphere: diameter: 1.5-2.0mm; pillar: height: 15.0mm, diameter: 0.5mm Enamel: 100 mesh Distance between silver spheres: 2.0-2.5mm		
<b>Facility and tool</b>	Metal part: welding torch, saw, pliers side cutter Enamel: kiln, spatula		
<b>Time and temperature for melting enamel</b>	Time for melting: 20-30s/melt Time of melting: 2 Temperature: 820-826℃		
Image (Camera/Scan/CAD)			
	The metal scaffolding	After applying enamel	After melting the enamels (bottom view)
			
	After melting the enamels (top view)		
<b>Observation</b>	The silver spheres on the top of the pillars are not the same size. The enamels melted and filled all the gaps between the spheres. The enamels covered part of the silver spheres.		
<b>Evaluation</b>	This experiment presents a different form of combination of silver spheres, providing structural design potential for the following test phase.		

<b>Experiment Title</b>	E8-Base material (plaster mould) test			
<b>Date</b>	28.01.2021			
<b>Location</b>	Individual studio			
<b>Participant</b>	Researcher/practitioner: Yinglong Li			
<b>Objective</b>	To test the possibility of using plaster mould as base material for supporting the metal scaffold part.			
<b>Process design</b>	1.Design sketch; 2.Produce silver spheres; 3.Create plaster mould; 4.Create metal scaffold part onto the plaster mould; 5.Apply and melt the enamels; 6. Separate the enamel piece from scaffold			
<b>Materials</b>	Fine silver, copper, plaster powder, vitreous enamel (transparent green “浅黄绿”, China)			
<b>Dimensions</b>	Metal piece (silver hemisphere shape): diameter: 3.0mm; hole: diameter: 0.8mm; copper pillar: height: 15.0mm, diameter: 0.8mm			
<b>Time and temperature for melting enamel</b>	Time for melting: 20-50s/melt Time of melting: 7 Temperature: 710-720°C			
<b>Facility and tool</b>	Kiln, spatula, desktop drilling machine			
<b>Image</b> (Camera/Scan/CAD)				
	Design sketch	Build the metal scaffold onto the mould.	After the 1 <sup>st</sup> time of applying the enamels	
				
	After the 1 <sup>st</sup> time of melting	After the 3 <sup>rd</sup> time of melting	The experimental result	
	<b>Observation</b>	The enamel fractures after being separated from the scaffold. Cracks appeared in the plaster mould after high temperature firing. Test result: failed		
	<b>Evaluation</b>	The possible factors leading to the fracture of enamel parts include green transparent enamel and different thermal expansion between plaster mould and enamel. As the base material, plaster mould is not conducive to stabilising the metal scaffold.		

<b>Experiment Title</b>	E9-Base material (plaster mould) test		
<b>Date</b>	31.01.2021		
<b>Location</b>	Individual studio		
<b>Participant</b>	Researcher/practitioner: Yinglong Li		
<b>Objective</b>	To test the possibility of using plaster mould as base material for supporting the metal scaffold part.		
<b>Process design</b>	1.Design sketch; 2.Produce silver spheres; 3.Create plaster mould; 4.Create metal scaffold part onto the plaster mould; 5.Apply and melt the enamels; 6.Separate the enamel piece from scaffold		
<b>Materials</b>	Fine silver, copper, plaster powder, vitreous enamel (S40, Japan)		
<b>Dimensions</b>	Metal piece (silver sphere): D: 3.0mm, hole: D: 0.8mm; Copper pillar: H: 15.0mm, D: 0.8mm		
<b>Time and temperature for melting enamel</b>	Time for melting: 3min20s-4min/melt Time of melting: 3 Temperature: 740-780°C		
<b>Facility and tool</b>	Kiln, spatula, desktop drilling machine		
<b>Image (Camera/Scan/CAD)</b>			
	Construct the metal scaffold part onto the plaster mould	After the 1 <sup>st</sup> time of applying the enamels	After the 2 <sup>nd</sup> time of melting the enamels
			
	After the 3 <sup>rd</sup> time of melting	The experimental result (after separated from the plaster mould)	The experimental result (the back of the test piece)
<b>Observation</b>	In this experiment, a complete enamel piece is obtained, but the metal pillars are not separated from silver spheres. Test result: failed		
<b>Evaluation</b>	Copper is not an appropriate material as a pillar for the construction of metal scaffolding, because copper will produce copper oxide after firing at high temperature, which not only affects the firing of enamel, but also increases the difficulty of separating pillars from silver spheres.		

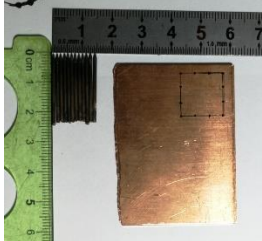

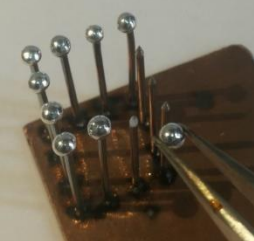



<b>Experiment Title</b>	E10-Base material (soldering block) test		
<b>Date</b>	31.01.2021		
<b>Location</b>	Individual studio		
<b>Participant</b>	Researcher/practitioner: Yinglong Li		
<b>Objective</b>	To test the possibility of using soldering block as base material for supporting the metal scaffold part.		
<b>Process design</b>	1.Design sketch; 2.Create metal scaffold part onto the soldering block; 3.Apply and melt the enamels; 4.Separate the enamel piece from scaffold		
<b>Materials</b>	Fine silver, stainless steel, vitreous enamel (S40, Japan), soldering block		
<b>Dimensions</b>	Metal piece (silver sphere): D: 3.0-3.5mm, hole: D: 1.0mm; Stainless steel pillar: H: 24.0mm, D: 1.0mm		
<b>Time and temperature for melting enamel</b>	Time for melting: 3min-4min/melt Time of melting: 4 Temperature: 820-850°C		
<b>Facility and tool</b>	Kiln (Efco, German), spatula, desktop drilling machine		
Image (Camera/Scan/CAD )			
	Construct the scaffold onto the soldering block	After the 2 <sup>nd</sup> time of applying the enamels	After the 3 <sup>rd</sup> time of applying the enamels
			
	After the 4 <sup>th</sup> time of melting	Separated from the soldering block	The experimental result
<b>Observation</b>	The enamel melts and connects five silver spheres. The stainless pillars become black. The enamel piece is successfully separated from the scaffold. Test result: successful		
<b>Evaluation</b>	Soldering block is more suitable for firing enamel as the base material. However, drilling on soldering block is more difficult than plaster mould as it is hard to obtain accurate drilling depth.		

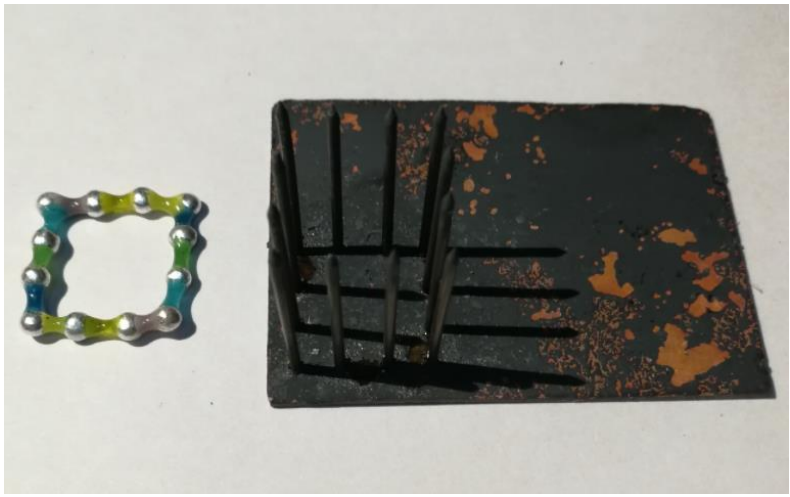
<b>Experiment Title</b>	E11-Base material (soldering block) test		
<b>Date</b>	05.02.2021		
<b>Location</b>	Individual studio		
<b>Participant</b>	Researcher/practitioner: Yinglong Li		
<b>Objective</b>	To test the possibility of using soldering block as base material for supporting the metal scaffold part.		
<b>Process design</b>	1.Design sketch; 2.Create metal scaffold part onto the soldering block; 3.Apply and melt the enamels; 4.Separate the enamel piece from scaffold		
<b>Materials</b>	Fine silver, stainless steel, vitreous enamel (S40, Japan), soldering block		
<b>Dimensions</b>	Metal piece (silver sphere): D: 3.0-3.5mm, hole: D: 1.0mm; Stainless steel pillar: H: 24.0mm, D: 1.0mm		
<b>Time and temperature for melting enamel</b>	Time for melting: 3min-4min/melt Time of melting: 4 Temperature: 820-850°C		
<b>Facility and tool</b>	Kiln (Efco, German), spatula, desktop drilling machine		
<b>Condition</b>	The enamels connected spheres after separating from the scaffold.		
<b>Image</b> (Camera/Scan/CAD)			
	Build the scaffold onto the soldering block	After the 1 <sup>st</sup> time of applying the enamels	After the 1 <sup>st</sup> time of melting the enamels
			
	After the 3 <sup>rd</sup> time of melting	Separation process	The experimental result
<b>Observation</b>	The enamel melts and connects five silver spheres. The stainless pillars turn black. One of the pillars could not be separated from the enamel piece because it is stuck by the enamel. Test result: failed		
<b>Evaluation</b>	The soldering block is an appropriate material for making scaffolding, in order to fabricate the MTG series. When applying and firing the enamel, the enamel should be prevented from flowing to the bottom of the metal spheres to stick to metal pillars below, resulting in the inability to separate the enamel from metal scaffolds.		

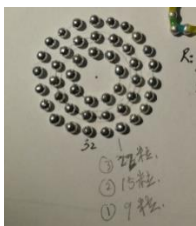





<b>Experiment Title</b>	E12-Base material (soldering block) test		
<b>Date</b>	05.02.2021		
<b>Location</b>	Individual studio		
<b>Participant</b>	Researcher/practitioner: Yinglong Li		
<b>Objective</b>	To test the possibility of using soldering block as base material for supporting the metal scaffold part.		
<b>Process design</b>	1.Design sketch; 2.Produce metal spheres; 3.Drill holes onto the soldering block; 4.Constrcute the scaffold; 5.Apply and melt the enamel; 6.Seperate the enamel piece from the scaffold		
<b>Materials</b>	Fine silver, stainless steel, vitreous enamel (transparent green S40, transparent yellow S27, transparent blue S49, produced in Japan), soldering block		
<b>Dimensions</b>	Metal piece (silver sphere): diameter: 3.0-3.5mm; hole: diameter: 1.0mm; stainless steel pillar: height: 24.0mm, diameter: 1.0mm		
<b>Time and temperature for melting enamel</b>	Time for melting: 3min-4min/melt Time of melting: 3 Temperature: 820-860℃		
<b>Facility and tool</b>	Kiln (Efco, German), spatula, desktop drilling machine		
<b>Condition</b>	The enamels connected five silver spheres after separating from the scaffold.		
Image (Camera/Scan/CAD)			
	Assemble the pillars and spheres onto the soldering block.	After the 1 <sup>st</sup> time of applying the enamels	After the 1 <sup>st</sup> time of melting the enamels
			
	After the 3 <sup>rd</sup> time of melting	Separate the enamel piece from the soldering block	The experimental result
<b>Observation</b>	Three colours of enamels connect 12 well-ordered silver spheres to form a square structure of enamel. Test result: successful		
<b>Evaluation</b>	The quantity of enamels for applying can not be too much at one time to avoid the dropping of the enamels, because it is difficult		



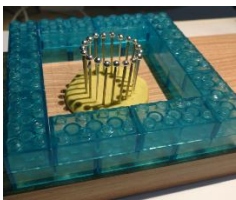





	<p>to separate the spheres and pillars if the enamels attached the pillars after melting.</p> <p>Second, I also find that applying enamels to the gaps between the spheres not only from the top but also the two sides to ensure the connection by melting the enamels. This is a new making experience obtained from this experiment rather than in traditional plique-à-jour.</p> <p>The time for melting depends on the type of enamels employed. In this experiment, I used enamels (S27, S40, S49) from Japan. The temperature of the furnace is around 860°C. And the time of melting the enamels last for three to four minutes. I find out that it is crucial to melt the enamels fully at the first time of melting, increasing the possibility of bonding.</p>
--	---

<b>Experiment Title</b>	E14-Resistance welding method for scaffold test		
<b>Date</b>	18-19.03.2021		
<b>Location</b>	Individual studio		
<b>Participant</b>	Researcher/practitioner: Yinglong Li		
<b>Objective</b>	To create a precise MTG piece by the resistance welding technology		
<b>Process design</b>	1.Solder the pillars and metal sheet (copper) with resistance welding; 2.Apply and melt the enamels; 3.Separate the enamel piece from the scaffold		
<b>Materials</b>	Fine silver, copper, stainless steel, vitreous enamel (produced in Japan)		
<b>Dimensions</b>	Silver sphere: D: 2.5-3.0mm; amount: 12 pieces Pillar (stainless steel): H: 23.0-25.0mm; D: 1.0mm; amount: 12 pieces. Copper plate: L: 53.0mm, W: 40.0mm, THK: 0.8mm		
<b>Time and temperature for melting enamel</b>	Time for melting: 3min-4min/melt Time of melting: 6 Temperature: 820-860 °C		
<b>Facility and tool</b>	Kiln, resistance welding machine, spatula, ruler, tweezer		
Image (Camera/Scan/CAD)			
	Draw and drill holes on the soldering block.	Assemble the pillars and spheres onto the soldering block.	The assembling of the pillars and spheres is complete.
			
	After the 1 <sup>st</sup> time of applying the enamels	After the 1 <sup>st</sup> time of melting	After the 6 <sup>th</sup> time of melting the enamels

	 <p data-bbox="523 696 826 734">The experimental result</p>
<b>Observation</b>	Test result: successful
<b>Evaluation</b>	Resistance welding technology is able to produce a more precise metal scaffold leading to a more accurate enamel piece than the previous methods plaster mould and soldering block.

<b>Experiment Title</b>	E15-Base material test: soldering block		
<b>Date</b>	05.03-28.03.2021		
<b>Location</b>	Individual studio		
<b>Participant</b>	Researcher/practitioner: Yinglong Li		
<b>Objective</b>	To make a three concentric circles structure with soldering block		
<b>Process design</b>	1.Produce silver sphere; 2.Drill holes onto the soldering block; 3.Place pillars onto the soldering block; 4.Apply and melt the enamels; 5.Separate the enamel piece from scaffold		
<b>Materials</b>	Fine silver, stainless steel, vitreous enamel (Japan), soldering block		
<b>Dimensions</b>	Sphere: D: 3.0mm; C1: D: 12mm, 9 spheres; C2: D: 22mm, 15 spheres; C3: D: 32mm, 22 spheres Pillar: C1: H: 25.0mm, C2: H: 24.0mm, C3: H: 23.0mm; D: 1.0mm		
<b>Time and temperature for melting enamel</b>	Time for melting: 3min-4min/melt Time of melting: 6 Temperature: 820-860°C		
<b>Facility and tool</b>	Kiln, soldering block, spatula, compasses, ruler, tweezer		
<b>Image</b> (Camera/Scan/CAD)			
	The design process (arrange the silver spheres)	Assemble the pillars and spheres onto the soldering block.	The assembling of the pillars and spheres is complete.
			
	After the 1 <sup>st</sup> time of applying	After the 1 <sup>st</sup> time of melting	After the 6 <sup>th</sup> time of melting the enamels
<b>Observation</b>	The experimental results show that, although the enamel connects all the silver spheres, it could not separate the enamel pieces from the scaffold. Test result: failed		
<b>Evaluation</b>	The reason why the enamel cannot be separated from the scaffold is that, the three concentric circles are too complex and the soldering block is insoluble in water. When the enamel		







	<p>connects all the spheres, a fixed but fragile enamel piece is formed. Another new finding in this experiment is that the enamel flows to the nearby enamel parts instead of the corresponding spheres when connecting different circles.</p>
--	---

<b>Experiment Title</b>	E16-Base material test: plaster mould casting method (round shape)		
<b>Date</b>	05.04-15.04.2021		
<b>Location</b>	Individual studio		
<b>Participant</b>	Researcher/practitioner: Yinglong Li		
<b>Objective</b>	To create the scaffold part with plaster mould casting method		
<b>Process design</b>	1.Design sketch; 2.Produce sphere; 3.Place pillars onto the plasticine modelling clay; 4.Make the plaster mould; 5.Apply and melt the enamels; 6.Separate the enamel piece from scaffold		
<b>Materials</b>	Fine silver, stainless steel, vitreous enamel (Japan), plaster powder, plasticine modelling clay		
<b>Dimensions</b>	Sphere: D: 2.5-3.0mm; Circle: 19 spheres; Pillar: H: 29.0mm, D: 1.0mm		
<b>Time and temperature for melting enamel</b>	Time for melting: 3min-4min/melt Time of melting: 3 Temperature: 820-860°C		
<b>Facility and tool</b>	Kiln (Efco, German), spatula, plastic building block, tweezer		
Image (Camera/Scan/CAD )			
	Make a pool with plastic building block and place pillars onto the plasticine modelling clay	Pour plaster paste into the pool	Remove the plastic building block and the plasticine modelling clay block after the plaster mould became dry
			
	After the 3 <sup>rd</sup> time of applying the enamels	After the 3 <sup>rd</sup> time of melting	The plaster mould was dissolved in water.
<b>Observation</b>	In this experiment that was carried out after the third firing, the enamel unites all the spheres. Nevertheless, the plaster mould fractures during the dissolution. Test result: failed		
<b>Evaluation</b>	This experiment is the first time to construct the base of the metal scaffold by the plaster mould casting method, which is better to stabilise the metal scaffold in the experiment compared with the previous method that drills holes in the plaster mould and inserts		

metal scaffolds. However, the experimental procedure shows that the plaster mould casting method is also difficult to avoid cracks after multiple firings. The experimental results reveal that the enamel pieces fracture during the dissolution of the plaster mould. This may be related to different thermal expansion of enamel and plaster mould, and it is also possible that the plaster mould produces powder in the furnace, which contaminates the surface of spheres and reduces the attachment between the enamel and the spheres.


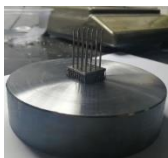


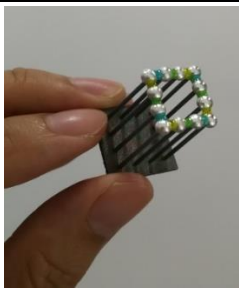
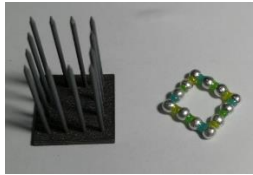







The experimental result






<b>Experiment Title</b>	E17-Base material test: plaster mould casting method (round shape)		
<b>Date</b>	18.04-26.04.2021		
<b>Location</b>	Individual studio		
<b>Participant</b>	Researcher/practitioner: Yinglong Li		
<b>Objective</b>	To create the scaffold part with plaster mould casting method		
<b>Process design</b>	1.Design sketch; 2.Make spheres; 3.Create metal scaffold onto plasticine modelling clay; 4.Make a pool with plastic building blocks; 5.Create plaster mould; 6.Apply and melt enamel; 7.Seperate enamel piece from scaffold part		
<b>Materials</b>	Fine silver, stainless steel, vitreous enamel (Japan), plaster powder, plasticine modelling clay		
<b>Dimensions</b>	Sphere: D: 2.5-3.0mm; Circle: 19 spheres; Pillar: H: 29.0mm, D: 1.0mm		
<b>Time and temperature for melting enamel</b>	Time for melting: 4min-13min/melt Time of melting: 9 Temperature: 820-860 °C		
<b>Facility and tool</b>	Kiln (Efco, German), spatula, plastic building block, tweezer		
Image (Camera/Scan/CAD)	 <p>Pour plaster paste into the pool constructed by the plastic building block</p>	 <p>After the 1<sup>st</sup> time of applying the enamels</p>	 <p>After the 1<sup>st</sup> time of melting</p>
	 <p>After the 9<sup>th</sup> time of applying the enamels</p>	 <p>The plaster mould was dissolved in water.</p>	 <p>The experimental result (a complete enamel piece supported by four silver pillars)</p>
<b>Observation</b>	A complete enamel piece is produced in this experiment. Test result: successful		
<b>Evaluation</b>	It is the first time that four of the spheres welded to pillars in this experiment in design, thus, there are still four silver pillars to		

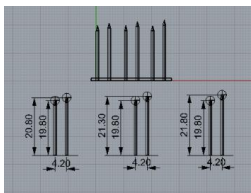

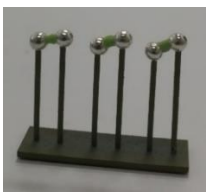

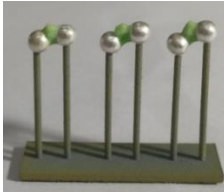



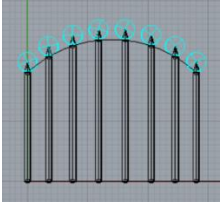





	<p>support this enamel piece in a round shape after disassembling the metal scaffolding (the stainless steel pillars). An anomaly in this experiment is that the enamel does not melt completely after a high temperature (850-860°C) and a long firing time (9-13mins). After the 9th firing, the enamel melts completely, but lost its usual transparency. This may be related to excessive number of firings and long firing time.</p>
--	---

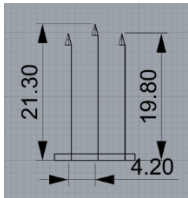




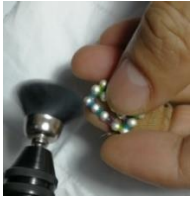
<b>Experiment Title</b>	E19-SLM technology for MTG test (square shape)		
<b>Date</b>	06.05-09.05.2021		
<b>Location</b>	Individual studio		
<b>Participant</b>	Researcher/practitioner: Yinglong Li		
<b>Objective</b>	To test the feasibility of making metal scaffold by SLM technology		
<b>Process design</b>	1.Create CAD file; 2. Print the scaffold by SLM machine; 3. Apply and melt enamel; 4. Separate enamel piece from scaffold		
<b>Materials</b>	Fine silver, titanium, vitreous enamel (S27, S40, S49, produced in Japan)		
<b>Dimensions</b>	Sphere: D: 3.0mm; 12 spheres Pillar: H: 26.0mm, D: 1.0mm Distance between every two pillars: 4.0mm		
<b>Time and temperature for melting enamel</b>	Time for melting: 3min-4min/melt Time of melting: 2 Temperature: 835-845°C		
<b>Facility and tool</b>	Kiln, SLM printing machine, spatula, tweezer		
Image (Camera/Scan/CAD)			
	Create the scaffold by the SLM printing machine	Achieve a piece of precise scaffold with supporting part	After cutting off the support part
			
	After the 1 <sup>st</sup> time of applying the enamels	After the 2 <sup>nd</sup> time of melting the enamels	The experimental result
<b>Observation</b>	A complete and precise shape enamel piece is produced in this experiment. Test result: successful		
<b>Evaluation</b>	This is the first time of using SLM technology for the MTG experiment. The testing piece shows that SLM technology improves the appearance of the enamel piece.		

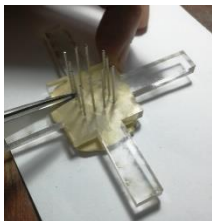

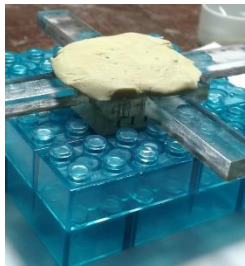



<b>Experiment Title</b>	E21-SLM technology for MTG test (square shape) and polishing test		
<b>Date</b>	28.05.2021		
<b>Location</b>	Individual studio		
<b>Participant</b>	Researcher/practitioner: Yinglong Li		
<b>Objective</b>	To test the feasibility of polishing the enamel piece after separated from SLM scaffold		
<b>Process design</b>	1. Produce the scaffold part with SLM; 2. Apply and melt enamel; 3. Separate enamel piece from scaffold; 4. Polish the enamel piece		
<b>Materials</b>	Fine silver, titanium, vitreous enamel (Japan)		
<b>Dimensions</b>	Sphere: D: 3.0mm; 12 spheres; Pillar: H: 26.0mm, D: 1.0mm; Distance between two pillars: 4.0mm		
<b>Time and temperature for melting enamel</b>	Time for melting: 3min-4min/melt Time of melting: 3 Temperature: 820-850°C		
<b>Facility and tool</b>	Kiln, spatula, tweezer, SLM printing machine		
<b>Image (Camera/Scan/CAD)</b>			
	Scaffold part	After the 1 <sup>st</sup> time of applying the enamels	After the 1 <sup>st</sup> time of melting the enamels
			
	After the 3 <sup>rd</sup> time of melting the enamels	The experimental result, after polishing	
<b>Observation</b>	The enamel pieces are separated from the titanium scaffold produced by the SLM technology. After polishing, the effect of spheres is better than that before polishing. Test result: successful		
<b>Evaluation</b>	This is the first time to polish the enamel piece of the MTG experiment. The results reveal that the enamel piece is not as fragile as previous expectation. To the contrary, it can withstand the forces generated by slow polishing.		

<b>Experiment Title</b>	E22-SLM technology for MTG connecting distance test		
<b>Date</b>	28.05.2021		
<b>Location</b>	Individual studio		
<b>Participant</b>	Researcher/practitioner: Yinglong Li		
<b>Objective</b>	To test the connecting distance and collect precise data		
<b>Process design</b>	1. Produce the scaffold part with SLM; 2. Apply and melt enamel; 3. Separate enamel piece from scaffold		
<b>Materials</b>	Fine silver, titanium, vitreous enamel (Japan)		
<b>Dimensions</b>	Sphere: D: 3.0mm; 9 spheres Pillar: H: 19.8mm, D: 1.0mm Distance between the pillars: 4.0mm, 4.2mm, 4.4mm, 4.6mm, 4.8mm, 5.0mm, 5.2mm, 5.4mm		
<b>Time and temperature for melting enamel</b>	Time for melting: 2min-3min/melt Time of melting: 4 Temperature: 830-850°C		
<b>Facility and tool</b>	Kiln, SLM printing machine, spatula, tweezer		
Image (Camera/Scan/CAD )			
	Scaffold part	After the 1 <sup>st</sup> time of melting the enamels	After the 2 <sup>nd</sup> time of melting the enamels
			
	After the 3 <sup>rd</sup> time of melting the enamels	The experimental result: after the 4 <sup>th</sup> time of melting the enamels	
<b>Observation</b>	The enamel successfully connects nine spheres. Test result: successful		
<b>Evaluation</b>	The experimental results indicate that the enamel is able to connect two 3.0mm diameter spheres in a 4.0mm to 5.4mm distance. It is important to test and collect accurate data on the linkable distances, which will provide the basic parameters for the subsequent design of the MTG series. The application of the digital technology SLM offers the possibility of accurate data collection.		

<b>Experiment Title</b>	E23-SLM technology for MTG height difference connecting test			
<b>Date</b>	23.08.2021			
<b>Location</b>	Individual studio			
<b>Participant</b>	Researcher/practitioner: Yinglong Li			
<b>Objective</b>	To test the connecting distance and collect precise data			
<b>Process design</b>	1. Produce the scaffold part with SLM; 2. Apply and melt enamel; 3. Separate enamel piece from scaffold			
<b>Materials</b>	Fine silver, titanium, vitreous enamel (Japan)			
<b>Dimensions</b>	Sphere: D: 3.0mm Pillar: H: P1: 19.8mm, P1-2: 20.8mm; P2: 19.8mm, P2-2: 21.3mm; P3: 19.8mm, P3-2: 21.8mm. D: 1.0mm Height difference between the pillars: Group 1: 1.0mm, Group 2: 1.5mm, Group 3: 2.0mm Distance between two pillars: 4.2mm			
<b>Time and temperature for melting enamel</b>	Time for melting: 2min-3min/melt Time of melting: 2 Temperature: 830-850 °C			
<b>Facility and tool</b>	Kiln, SLM printing machine, spatula, tweezer			
<b>Image</b> (Camera/Scan/CAD)				
	CAD file	Scaffold part	After the 1 <sup>st</sup> time of applying the enamels	
				
	After the 1 <sup>st</sup> time of melting the enamels	After the 2 <sup>nd</sup> time of applying the enamels	The experimental result: after the 2 <sup>nd</sup> time of melting the enamels	
	<b>Observation</b>	Three groups of spheres with different height differences were successfully connected by the enamel. Test result: successful		
	<b>Evaluation</b>	The experimental results show that the enamel is able to bridge two spheres with disparate height differences and a horizontal distance of 4.2mm. The data collected from this experiment provides a significant reference for the subsequent design of the structure.		

<b>Experiment Title</b>	E24-SLM technology for MTG: arched bridge (single row) structure		
<b>Date</b>	06.07-08.07.2021		
<b>Location</b>	Individual studio		
<b>Participant</b>	Researcher/practitioner: Yinglong Li		
<b>Objective</b>	To test a new form with SLM: arched bridge structure		
<b>Process design</b>	1. Produce the scaffold part with SLM; 2. Apply and melt enamel; 3. Separate enamel piece from scaffold		
<b>Materials</b>	Fine silver, titanium, vitreous enamel (Japan)		
<b>Dimensions</b>	Sphere: D: 3.0mm; 8 spheres Pillar: D: 1.0mm Distance between two pillars: 4.0mm		
<b>Time and temperature for melting enamel</b>	Time for melting: 2min30s-3min/melt Time of melting: 3 Temperature: 830-850°C		
<b>Facility and tool</b>	Kiln, SLM printing machine, spatula, tweezer		
Image (Camera/Scan/CAD )	 CAD file	 Scaffold part	 After the 1 <sup>st</sup> time of applying the enamels
	 After the 1 <sup>st</sup> time of melting the enamels	 After the 2 <sup>nd</sup> time of melting the enamels	 The experimental result: the enamel piece removed from the scaffold after the 2 <sup>nd</sup> time of melting
<b>Observation</b>	A complete enamel piece of the arched bridge (single row) structure is gained in this experiment. Test result: successful		
<b>Evaluation</b>	This experiment is the first in the MTG series experiments to achieve a single arch structure, and enamel becomes an integral part to support this arch structure.		

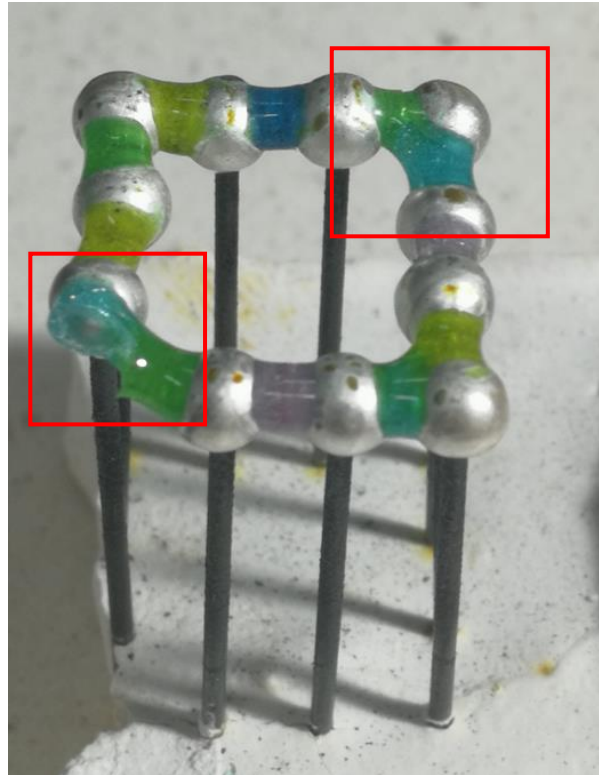
<b>Experiment Title</b>	E25-SLM technology for MTG: triangular prism structure		
<b>Date</b>	04.07-17.07.2021		
<b>Location</b>	Individual studio		
<b>Participant</b>	Researcher/practitioner: Yinglong Li		
<b>Objective</b>	To test a new form with SLM: triangular prism structure		
<b>Process design</b>	1. Produce the scaffold part with SLM; 2. Apply and melt enamel; 3. Separate enamel piece from scaffold		
<b>Materials</b>	Fine silver, titanium, vitreous enamel (Japan)		
<b>Dimensions</b>	Sphere: D: 3.0mm; 15 spheres; Pillar: H: P1: 19.8mm, P2: 21.3mm, P3: 19.8mm. D: 1.0mm; Distance between two pillars: 4.2mm		
<b>Time and temperature for melting enamel</b>	Time for melting: 2min30s-3min/melt Time of melting: 6 Temperature: 830-850 °C		
<b>Facility and tool</b>	Kiln, SLM printing machine, spatula, tweezer		
<b>Image</b> (Camera/Scan/CAD)			
	CAD file	Scaffold part	After the 1 <sup>st</sup> time of applying the enamels
			
	After the 5 <sup>th</sup> time of melting the enamels	The enamel piece is separated from the scaffold.	Polish the enamel piece
<b>Observation</b>	A complete enamel piece of triangular prism structure is obtained in this experiment. Some of the spheres move slightly during the firing process. Test result: successful		
<b>Evaluation</b>	This experiment is a further exploration of the new structure based on the previous tests of the linking distance. The results reveal that spheres shift at the top of the pillars, resulting in the enamel piece that is not precise enough. The diameter and depth of the hole in the back of the spheres is closely related to the diameter of the pillars and the shape of the topmost pillars. All these parameters influence how the spheres move at the top of the pillars and whether the enamel piece can be removed from the scaffold.		

<b>Experiment Title</b>	E28-Plaster mould and acrylic plate method (enamel: square shape)		
<b>Date</b>	31.07.2021		
<b>Location</b>	Individual studio		
<b>Participant</b>	Researcher/practitioner: Yinglong Li		
<b>Objective</b>	To test the effect of combing plaster mould and acrylic plate (CNC drilling hole) method for the MTG series		
<b>Process design</b>	1.Manufacture the acrylic plate with CNC drilling machine; 2.Produce the scaffold part with plaster mould and acrylic plate; 3.Apply and melt the enamel; 4.Separate enamel piece from scaffold		
<b>Materials</b>	Fine silver, stainless steel, vitreous enamel (Japan), plaster powder, plasticine modelling clay block		
<b>Dimensions</b>	Sphere: D: 3.0mm; 12 spheres; Pillar: D: 0.8mm; Distance between two pillars: 4.0mm		
<b>Time and temperature for melting enamel</b>	Time for melting: 4min-4min30s/melt Time of melting: 4 Temperature: 830-880°C		
<b>Facility and tool</b>	Kiln, CNC drilling machine, spatula, tweezer, plastic building block, acrylic plate with holes		
Image (Camera/Scan/CAD)			
	Build the scaffold part with the acrylic plate and plasticine modelling clay block.	Pour the plaster paste into the pool created by the plastic building blocks.	Reverse the metal scaffold part and put it into the pool
			
	After the 1 <sup>st</sup> time of applying the enamels	After the 1 <sup>st</sup> time of melting the enamels	After the 2 <sup>nd</sup> time of melting the enamels.
<b>Observation</b>	This experiment fails to produce a complete enamel piece due to a breakage in the plaster mould during the firing process. Test result: failed		

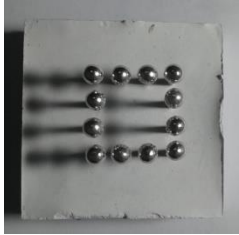







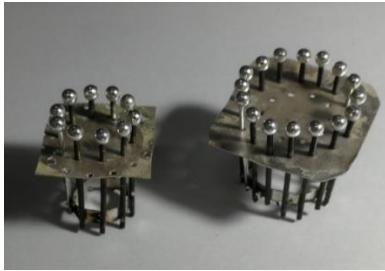
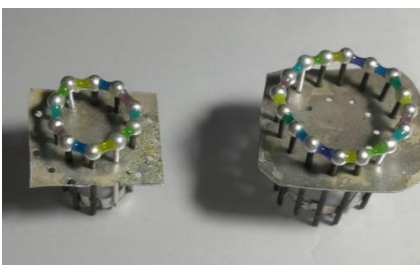

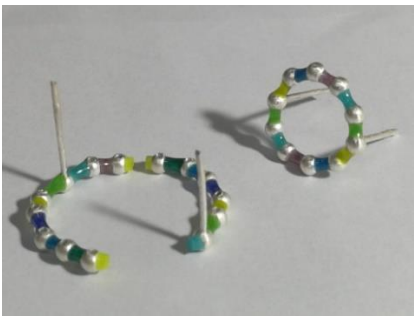
**Evaluation**

The results of this experiment after the fourth firing are shown in the figure. The red box in the upper right corner reveals a crack in the enamel, while the red box in the lower left corner shows that one of the stainless steel pillars and the spheres collapse because the plaster mould cracks when being fired. This is a disadvantage of the plaster mould method.









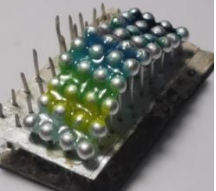


The experimental result

<b>Experiment Title</b>	E30-Plaster mould and acrylic plate method (enamel: square shape)			
<b>Date</b>	31.07.2021			
<b>Location</b>	Individual studio			
<b>Participant</b>	Researcher/practitioner: Yinglong Li			
<b>Objective</b>	To test the effect of combing plaster mould and acrylic plate (CNC drilling hole) method for the MTG series			
<b>Process design</b>	1.Manufacture the acrylic plate with CNC drilling machine; 2.Produce the scaffold part with plaster mould and acrylic plate; 3.Apply and melt enamel; 4.Separate enamel piece from scaffold			
<b>Materials</b>	Fine silver, stainless steel, vitreous enamel (Japan), plaster powder, plasticine modelling clay block			
<b>Dimensions</b>	Sphere: D: 3.0mm; 12 spheres; Pillar: D: 1.0mm; Distance between two pillars: 4.0mm			
<b>Time and temperature for melting enamel</b>	Time for melting: 4min30s-5min/melt Time of melting: 4 Temperature: 860-880 °C			
<b>Facility and tool</b>	Kiln, CNC drilling machine, spatula, tweezer, plastic building block, acrylic plate with holes			
<b>Image</b> (Camera/Scan/CAD)				
	The scaffold part	After the 1 <sup>st</sup> time of applying the enamels	After the 1 <sup>st</sup> time of melting	
				
	After the 2 <sup>nd</sup> time of melting	Dissolve the plaster mould in water	The experimental result	
	<b>Observation</b>	After dissolving the plaster mould, a complete enamel piece is attained in this experiment. Test result: successful		
	<b>Evaluation</b>	The stainless-steel pillars applied in this experiment are 1.0mm in diameter. It is found that stainless steel is a suitable material as the pillar. In addition, pillars in 1.0mm diameter can better support spheres in 3.0mm diameter.		

<b>Experiment Title</b>	E35-Metal scaffold method (enamel: two concentric circles)	
<b>Date</b>	09.08.2021	
<b>Location</b>	Individual studio	
<b>Participant</b>	Researcher/practitioner: Yinglong Li	
<b>Objective</b>	To test the feasibility of using metal materials (silver and stainless steel) to make the scaffold for the MTG series	
<b>Process design</b>	1.Make the scaffold part by resistance welding technology; 2.Apply and melt enamel; 3.Separate enamel piece from scaffold	
<b>Materials</b>	Fine silver, stainless steel, vitreous enamel (Japan)	
<b>Dimensions</b>	Sphere: D: 3.0mm; C1: 10 spheres, C2: 16 spheres Pillar: D: 1.0mm Distance between two pillars: 4.0mm	
<b>Time and temperature for melting enamel</b>	Time for melting: 1min30s-3min/melt Time of melting: 3 Temperature: 830-870°C	
<b>Facility and tool</b>	Kiln, spatula, tweezers, silver plate with holes	
Image (Camera/Scan/CA D)		
	The scaffold part	After the 3 <sup>rd</sup> time of melting
		
	The two enamel pieces of circle shape are removed from the scaffold.	The experimental result
<b>Observation</b>	In this experiment, the enamel piece with the larger diameter fractures in the combination of two concentric circles. Test result: failed	
<b>Evaluation</b>	The results of the experiment show that the MTG enamel pieces without scaffolds are very fragile. Both the dismantling of scaffolds and the assembling of a piece can lead to the breakage of enamel pieces.	

<b>Experiment Title</b>	E36-Metal scaffold method (enamel: circle shape)		
<b>Date</b>	10.08.-11.08.2021		
<b>Location</b>	Individual studio		
<b>Participant</b>	Researcher/practitioner: Yinglong Li		
<b>Objective</b>	To test the feasibility of using metal materials (fine silver) to make the scaffold for the MTG series		
<b>Process design</b>	1.Make the scaffold part by soldering; 2.Apply and melt enamel; 3.Separate enamel piece from scaffold		
<b>Materials</b>	Fine silver, vitreous enamel (Japan)		
<b>Dimensions</b>	Sphere: D: 3.0mm; 16 spheres Pillar: D: 0.8mm Distance between two pillars: 4.0mm		
<b>Time and temperature for melting enamel</b>	Time for melting: 1min30s-3min/melt Time of melting: 3 Temperature: 830-870°C		
<b>Facility and tool</b>	Kiln, spatula, tweezer, silver plate with holes		
<b>Image</b> (Camera/Scan/CAD)			
	Create the scaffold by soldering	The scaffold part	After the 1 <sup>st</sup> time of melting
			
	After the 2 <sup>nd</sup> time of melting	After the 3 <sup>rd</sup> time of melting	The experimental result
<b>Observation</b>	This experiment results in a complete enamel piece with circle shape after the metal scaffolding is removed by the cutting method. Test result: successful		
<b>Evaluation</b>	In order to reduce the impact of the forces on the fragile enamel piece which are generated when cutting the metal scaffold, finer silver wires are used to construct the metal scaffold. The results reveal that the adjustment of silver wire parameters better facilitates the dismantling of the scaffold. This is a continuous process of improving the method of dismantling the scaffold.		

<b>Experiment Title</b>	E38-Metal scaffold method (enamel: multi-row arch structure)		
<b>Date</b>	26.09-28.09.2021		
<b>Location</b>	Individual studio		
<b>Participant</b>	Researcher/practitioner: Yinglong Li		
<b>Objective</b>	To test a new structure of MTG series: the multi-row arch structure		
<b>Process design</b>	1.Make the scaffold part by soldering; 2.Apply and melt enamel; 3.Separate enamel piece from scaffold		
<b>Materials</b>	Fine silver, vitreous enamel		
<b>Dimensions</b>	Sphere: D: 3.0mm; 40 spheres Pillar: D: 1.0mm Distance between two pillars: 4.0mm		
<b>Time and temperature for melting enamel</b>	Time for melting: 1min20s-2min20s/melt Time of melting: 5 Temperature: 670-790℃		
<b>Facility and tool</b>	Kiln, spatula, tweezer, CNC drilling machine		
Image (Camera/Scan/CA D)			
	The scaffold part	After the 1 <sup>st</sup> time of applying	After the 1 <sup>st</sup> time of melting
			
	After the 2 <sup>nd</sup> time of applying	After the 2 <sup>nd</sup> time of melting	After the 4 <sup>th</sup> time of applying
			
	After the 4 <sup>th</sup> time of melting	After the 5 <sup>th</sup> time of applying	After the 5 <sup>th</sup> time of melting
<b>Observation</b>	The enamel piece cracks during the separation of from the scaffold in this experiment. Test result: failed		
<b>Evaluation</b>	This experiment is the first test of the multi-row arch structure in the MTG series. The results of the experiment present an exciting and unexpected lattice-like structure or the effect of multi holes.		

On the whole, it is a visual effect that combines order and disorder. The flow of the glass is originally free and nonsequenced. However, based on the orderly arrangement of the spheres, the flow of the glass takes on an orderly effect. The disorder is hidden within the order, creating an aesthetic effect of the combination of order and disorder (see the figure).

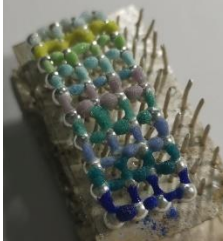









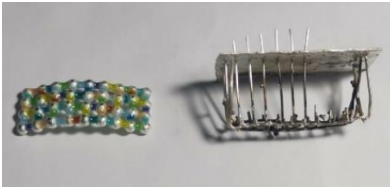

The testing result of the 2<sup>nd</sup> time of melting

After securing this effect, I further tried to fill all the holes in the middle to see the effect. However, the final result is not as good as the previous one that the porous effect of the enamel piece disappears (see the figure).

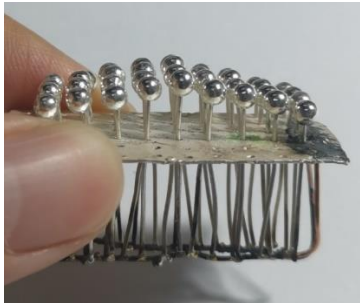





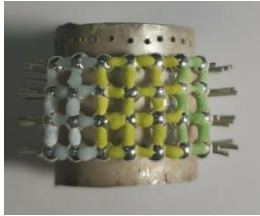




The experimental result of filling the holes





<b>Experiment Title</b>	E39-Metal scaffold method (enamel: multi-row arch structure)			
<b>Date</b>	03.10.2021			
<b>Location</b>	Individual studio			
<b>Participant</b>	Researcher/practitioner: Yinglong Li			
<b>Objective</b>	To test a new structure of MTG series: the multi-row arch structure			
<b>Process design</b>	1.Make the scaffold part by soldering; 2.Apply and melt enamel; 3.Separate enamel piece from scaffold			
<b>Materials</b>	Fine silver, vitreous enamel (S27, S40, S49, S58, S75, S51, S19, S52, produced in Japan; transparent white, transparent dark blue, produced in China)			
<b>Dimensions</b>	Sphere: D: 3.0mm; 40 spheres Pillar: D: 1.0mm Distance between two pillars: 4.0mm			
<b>Time and temperature for melting enamel</b>	Time for melting: 1min20s-2min20s/melt Time of melting: 4 Temperature: 670-790℃			
<b>Facility and tool</b>	Kiln, spatula, tweezers, CNC drilling machine			
Image (Camera/Scan/CAD)				
	After the 1 <sup>st</sup> time of applying	After the 1 <sup>st</sup> time of melting	After the 2 <sup>nd</sup> time of applying	
				
	After the 2 <sup>nd</sup> time of melting	After the 4 <sup>th</sup> time of melting	The experimental result	
	<b>Observation</b>	This experiment is carried out to obtain a complete enamel piece after separating it from the scaffold. Test result: successful		
	<b>Evaluation</b>	This experiment is the second test of multi-row arch structure in MTG series, with the enamel piece presents a multi-hole effect.		



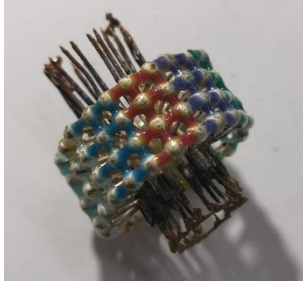
<b>Experiment Title</b>	E41-Metal scaffold method (enamel: multi-row arch structure)	
<b>Date</b>	10.11.2021	
<b>Location</b>	Individual studio	
<b>Participant</b>	Researcher/practitioner: Yinglong Li	
<b>Objective</b>	To test a new structure of MTG series: the multi-row arch structure	
<b>Process design</b>	1.Make the scaffold part by soldering; 2.Apply and melt enamel; 3.Separate enamel piece from scaffold with resistance welding technology	
<b>Materials</b>	Fine silver, vitreous enamel (S12, S15, S19, S27, S40, S49, S51, S55, S58, produced in Japan; transparent white, produced in China)	
<b>Dimensions</b>	Sphere: D: 3.0mm; 36 spheres Pillar: D: 1.0mm Distance between two pillars: 4.0mm	
<b>Time and temperature for melting enamel</b>	Time for melting: 1min20s-2min20s/melt Time of melting: 4 Temperature: 670-790°C	
<b>Facility and tool</b>	Kiln, spatula, tweezers, CNC drilling machine, resistance welding machine	
Image (Camera/Scan/CAD )		
	After the 1 <sup>st</sup> time of applying	After the 4 <sup>th</sup> time of melting
		
	The enamel piece and the scaffold	The experimental result
<b>Observation</b>	In this experiment, a complete enamel piece is produced after being separated from the scaffold. Test result: successful	
<b>Evaluation</b>	This experiment tests the application of more transparent enamels of different colours in multi-row arch structure, and provides reference for the future colour design of the MTG series.	

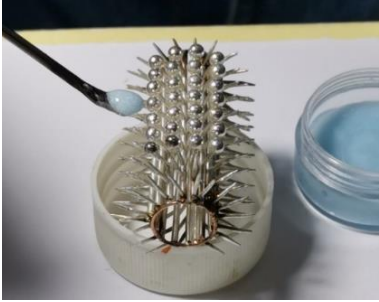
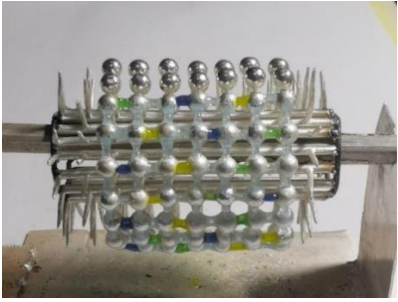

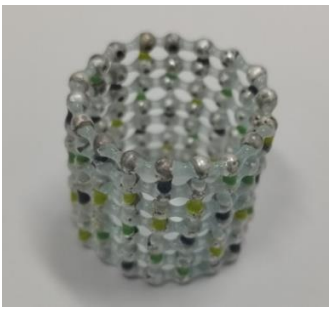





<b>Experiment Title</b>	E44-Acid etching method (enamel: multi-row arch structure)	
<b>Date</b>	11.11-15.11.2021	
<b>Location</b>	Individual studio	
<b>Participant</b>	Researcher/practitioner: Yinglong Li	
<b>Objective</b>	To test acid etching method for removing the metal scaffold	
<b>Process design</b>	1.Make the scaffold part by soldering; 2.Apply and melt enamel; 3.Separate enamel piece from scaffold with acid etching method	
<b>Materials</b>	Fine silver, copper, vitreous enamel	
<b>Dimensions</b>	Sphere: D: 3.0mm; 28 spheres Pillar: D: 1.0mm Distance between two pillars: 4.0mm	
<b>Time and temperature for melting enamel</b>	Time for melting: 1min20s-2min20s/melt Time of melting: 3 Temperature: 720-740 °C	
<b>Facility and tool</b>	Kiln, spatula, tweezer, resistance welding machine	
Image (Camera/Scan/CAD)		
	The scaffold part is made with fine silver and copper.	After the 3 <sup>rd</sup> time of melting
		
	The experimental result	
<b>Observation</b>	In this experiment, a complete enamel piece is produced after being separated from the scaffold. Test result: successful	
<b>Evaluation</b>	This experiment tests the effectiveness of the acid etching method in the MTG series of experiments.	





<b>Experiment Title</b>	E52-Enamel: cylinder form (metal scaffold cutting method)			
<b>Date</b>	10.10.2021			
<b>Location</b>	Individual studio			
<b>Participant</b>	Researcher/practitioner: Yinglong Li			
<b>Objective</b>	To make a cylinder form MTG			
<b>Process design</b>	1.Make the scaffold part by soldering; 2.Apply and melt enamel; 3.Separate enamel piece from scaffold by cutting method			
<b>Materials</b>	Fine silver, vitreous enamel			
<b>Dimensions</b>	Sphere: D: 3.0mm Pillar: D: 1.0mm Distance between two pillars: 4.0mm			
<b>Time and temperature for melting enamel</b>	Time for melting: 1min-1min30s/melt Time of melting: 22 Temperature: 700-755°C			
<b>Facility and tool</b>	Kiln, spatula, tweezers, resistance welding machine			
Image (Camera/Scan/CAD )				
	The scaffold part	After the 1 <sup>st</sup> time of applying the enamels	Place silver spheres onto the scaffold	
				
	After the 2 <sup>nd</sup> time of applying the enamels	After the 2 <sup>nd</sup> time of melting the enamels	After the 7 <sup>th</sup> time of melting the enamels	
	<b>Observation</b>	The enamel piece cracks after the separation of from the scaffold in this experiment. Test result: failed		
	<b>Evaluation</b>	The experimental result shows that the enamel piece of cylinder can easily crack using the cutting method. In addition, the key point of creating a cylinder form without scaffold is to maintain the flow of the enamels in a balanced condition.		

<b>Experiment Title</b>	E56-Enamel: cylinder form (acid etching method)	
<b>Date</b>	07.11.2021	
<b>Location</b>	Individual studio	
<b>Participant</b>	Researcher/practitioner: Yinglong Li	
<b>Objective</b>	To make a cylinder form MTG	
<b>Process design</b>	1. Make the scaffold part by soldering; 2. Apply and melt enamel; 3. Separate enamel piece from scaffold by acid etching method	
<b>Materials</b>	Fine silver, copper, vitreous enamel	
<b>Dimensions</b>	Sphere: D: 3.0mm Pillar: D: 1.0mm Distance between two pillars: 4.0mm	
<b>Time and temperature for melting enamel</b>	Time for melting: 1min-1min30s/melt Time of melting: 14 Temperature: 700-728°C	
<b>Facility and tool</b>	Kiln, spatula, tweezer, resistance welding machine	
Image (Camera/Scan/CAD)		
	After the 14 <sup>th</sup> time of melting the enamels	The acid acting process
		
	The acid etching process	The experimental result
<b>Observation</b>	The enamel piece fractures after being separated from the scaffold. Test result: failed	
<b>Evaluation</b>	The experimental result shows that the enamel piece cracks because of the incompatibility of the different enamels applied, although the acid etching method was able to remove the copper scaffold part without the need for extra force.	

<b>Experiment Title</b>	E57-Enamel: cylinder form (acid etching method)	
<b>Date</b>	01.01.2022	
<b>Location</b>	Individual studio	
<b>Participant</b>	Researcher/practitioner: Yinglong Li	
<b>Objective</b>	To make a cylinder form MTG	
<b>Process design</b>	1.Make the scaffold part by soldering; 2.Apply and melt enamel; 3.Separate enamel piece from scaffold by acid etching method	
<b>Materials</b>	Fine silver, copper, vitreous enamel	
<b>Dimensions</b>	Sphere: D: 3.0mm Pillar: D: 1.0mm Distance between two pillars: 4.0mm	
<b>Time and temperature for melting enamel</b>	Time for melting: 1min-1min20s/melt Time of melting: 11 Temperature: 700-740 °C	
<b>Facility and tool</b>	Kiln, spatula, tweezer, resistance welding machine	
Image (Camera/Scan/CAD)		
	After the 11 <sup>th</sup> time of melting the enamels	The acid etching process
		The experimental result
<b>Observation</b>	The enamel piece presents cracking before being separated from the scaffold. Test result: failed	
<b>Evaluation</b>	The experimental result also shows that the enamel piece cracks because of the incompatibility of different enamels applied.	

<b>Experiment Title</b>	E58-Enamel: cylinder form (acid etching method)	
<b>Date</b>	08.02.2022	
<b>Location</b>	Individual studio	
<b>Participant</b>	Researcher/practitioner: Yinglong Li	
<b>Objective</b>	To make a MTG cylinder form	
<b>Process design</b>	1.Make the scaffold part by casting and soldering; 2.Apply and melt enamel; 3.Separate enamel piece from scaffold by acid etching method	
<b>Materials</b>	Fine silver, copper, vitreous enamel	
<b>Dimensions</b>	Sphere: D: 3.0mm; Pillar: D: 1.0mm; Distance between two pillars: 4.0mm	
<b>Time and temperature for melting enamel</b>	Time for melting: 1min-1min30s/melt Time of melting: 21 Temperature: 715-750°C	
<b>Facility and tool</b>	Kiln, spatula, tweezer, resistance welding machine	
Image (Camera/Scan/CAD )	 <p>The scaffold part</p>	 <p>After the 5<sup>th</sup> time of melting the enamels</p>
	 <p>The acid etching process</p>	 <p>The experimental result (after removing the scaffold)</p>
<b>Observation</b>	In this experiment, a complete enamel piece produced after being separated from the new design scaffold. Test result: successful	
<b>Evaluation</b>	The experimental result is a piece of cylindrical structure with seven layers which was the most complex testing in the MTG series experiments. This experiment presents a successful outcome by the combination of material study and acid etching method.	

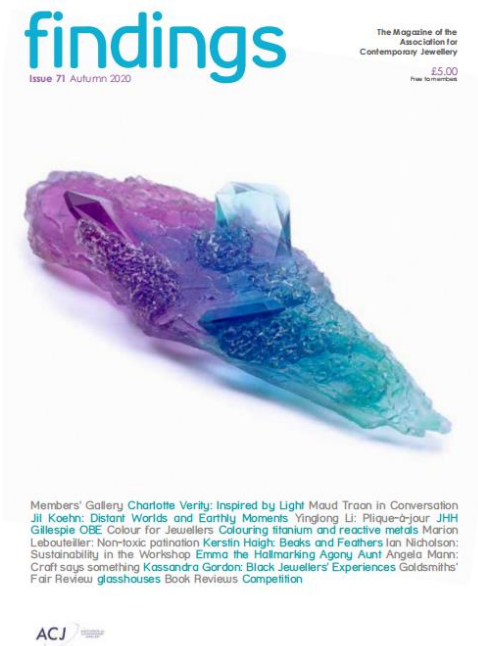
<b>Experiment Title</b>	E61-MTG with scaffold test	
<b>Date</b>	16.02-26.05.2022	
<b>Location</b>	Individual studio	
<b>Participant</b>	Researcher/practitioner: Yinglong Li	
<b>Objective</b>	To create MTG with scaffold	
<b>Process design</b>	1. Make the scaffold part by casting and soldering; 2. Apply and melt enamel; 3. Polish	
<b>Materials</b>	Fine silver, vitreous enamel	
<b>Dimensions</b>	Sphere: D: 3.0mm Distance between two pillars: 4.0mm	
<b>Time and temperature for melting enamel</b>	Time for melting: 1min-1min30s/melt Temperature: 715-750 °C	
<b>Facility and tool</b>	Kiln, spatula, tweezer	
<b>Image (Camera/Scan/CAD)</b>	 <p>The scaffold part</p>	 <p>The process of applying the enamels</p>
	 <p>The experimental result</p>	
<b>Observation</b>	Test result: successful	
<b>Evaluation</b>	These experiments show that the MTG with scaffold design requires the maker to apply the enamels based on the direction of the structure.	

<b>Experiment Title</b>	E62-Enamel: cylinder form (acid etching method)	
<b>Date</b>	12.06-02.07.2022	
<b>Location</b>	Individual studio	
<b>Participant</b>	Researcher/practitioner: Yinglong Li	
<b>Objective</b>	To combine MTG method with traditional plique-à-jour method	
<b>Process design</b>	1.Make the scaffold part by casting and soldering; 2.Apply and melt enamel; 3.Polish	
<b>Materials</b>	Fine silver, vitreous enamel	
<b>Dimensions</b>	Sphere: D: 3.0mm Distance between two pillars: 4.0mm	
<b>Time and temperature for melting enamel</b>	Time for melting: 1min-1min30s/melt Time of melting: 23 Temperature: 715-750°C	
<b>Facility and tool</b>	Kiln, spatula, tweezers, resistance welding machine	
Image (Camera/Scan/CAD)		
	The process of making scaffold part	After the 1 <sup>st</sup> time of applying the enamels to the opening
		
	The process of melting the enamels	The experimental result
<b>Observation</b>	Test result: successful	
<b>Evaluation</b>	This was the first experiment combining traditional plique-à-jour (mica method) with the MTG method into a single piece of work, expanding the potential of the MTG method.	

# Appendix 2: Paper published and symposium

## Paper publication

Magazine: Findings. Association for Contemporary Jewellery, 2020



Members' Gallery Charlotte Verity: Inspired by Light Maud Traou in Conversation Jill Koehn: Distant Worlds and Earthly Moments Yinglong Li: Plique-à-jour JHH Gillespie OBE: Colour for Jewellers Colouring titanium and reactive metals Marion Labouteiller: Non-toxic polination Kerstin Holigh: Beads and Feathers Ian Nicholson: Sustainability in the Workshop Emma de Hallmarking Agony Aunt Angela Mann: Craft says something Cassandra Gordon: Black Jewellers' Experiences Goldsmiths' Fair Review glasshouses Book Reviews Competition

THEME

### Window on the World: China Yinglong Li: Plique-à-jour

One of the oldest methods of adding colour to metal is enamelling. Plique-à-jour is a technique of applying transparent enamel to a metal frame, with no backing, and can almost give the effect of being pure colour – or at least like a miniature stained glass window.

Yinglong Li learned traditional plique-à-jour and filigree techniques in Hai Minority County, Hebei province, China, and has visited master enamellers in the UK, France and China as the course of his research. His current PhD research, at the School of Jewellery at Birmingham City University, questions whether material understanding and current technologies can help overcome the restrictions to developing this traditional and highly skilled enamelling technique.

Could you tell us about your research? How to develop traditional plique-à-jour creatively and sustainably is a major topic of my research. In my ongoing PhD program, I propose the idea of combining materials experiments, digital technology, and 3D modelling design to expand the boundaries of plique-à-jour. In recent years, hybrid craft that integrates hand skills and technology has become popular in contemporary craft disciplines.

Traditionally, plique-à-jour artists spend a lot of time on making a delicate metal framework before applying enamel. Today, digital technology allows enamellers to create the metal parts of a design with complexity and higher accuracy. I am on the first year of the PhD program; in the next two years, I will present a new perspective to revisit this ancient technique with cutting-edge digital technology and material study. <sup>1</sup>



Yinglong Li demonstrating the plique-à-jour method of enamel design. Photo: Cathy Wang.

Colour palette for plique-à-jour



'enamel plays a role in connection rather than only decoration'



18 Autumn 2020 Findings

THEME

### Happy Birthday Ian!



100 years old and still making

Findings and the ACJ Board would like to invite members to join us in wishing founder member John H Gillespie OBE (known as Ian) a very happy one hundred birthday. Ian still spends time in the studio – remarkable!

Professionally, Ian was a civil engineer in ports, which involved a lot of travelling. He and his wife, Ellen, used the opportunities this afforded to indulge their passion for jewellery making and silverworking. For example, they spent time with Navaho, Hopi and Zuni jewelers in Arizona, visited the Mikimoto Pearl Island in Japan and observed craftspeople decorating vases with cloisonné in a Beijing factory.

Ian recognises that working in silver and gold as a hobby has allowed him both design and economic freedom. He has never sold a piece, but has auctioned his work for charitable causes.

His background in engineering allowed him to find his own workshop solutions. He writes: 'My son-in-law and I made a 30ton hydraulic jack for forming the bowl of a spoon. Another piece of equipment we made is a grand device for drawing down wire. We incorporated an old car seat belt.'

When asked what advice he has for younger jewelers, he says,

'I am greatly indebted to the two Normans, Grant and Cherry for instilling in me the importance of quality in what you make. If it is worth doing, do it well to the best of your ability.' They also encouraged me to draw down each design. I am on my 13th design book.

He adds, 'Another observation aimed at young professionals is the great advantage of being a member of ACJ with all the opportunities of networking.'

You can read more about John H Gillespie's life and work on the ACJ website.

John Gillespie OBE, paper links etc.



Yinglong's work (order light)

Inset image of the work



Findings Autumn 2020 8



# Conference

Beyond Silver: 25 Years of the ACJ

Presentation title: Sustainability of Traditional Craft: rethinking the knowledge and value of making with the enamelling technique of plique-à-jour

Address: Exeter University; Date: 1<sup>st</sup>-3<sup>rd</sup> July 2022



**Beyond Silver: 25 Years of the ACJ** at Exeter University 1<sup>st</sup>-3<sup>rd</sup> of July 2022

**Bookings for the live streaming of the ACJ conference are now live**

This conference celebrates the 25th anniversary of the Association for Contemporary Jewellery. In 2017 the ACJ celebrated its 20<sup>th</sup> Anniversary by marking the past and the present through the exhibition 20:20 Visions and exploring the future through the conference of the same name. Now, five years on, the focus has shifted to the position of contemporary jewellery in a changed society.

We took inspiration from the translation of Marjan Unger's doctoral dissertation, *Jewellery in Context: A Multi-disciplinary framework for the study of jewellery*. After her passing, Theo Smeets and a number of jewellery institutions, scholars and interested individuals came together to publish Unger's work in her spirit, making it available in English over a decade after it was defended in 2010.

When we wear jewellery, we are communicating something about who we are and what is important to us. Contemporary jewellery doesn't just engage with the history of jewellery and the body but also expands upon an array of associations and *Jewellery in Context* seemed like an excellent place to begin our reflection and help frame the conference topics.

The call for papers sought submissions that discussed the following themes: Jewellery as a social connector; Jewellery: meanings and messages; Democratizing the field; and Jewellery as art. In addition, we sought to provide a platform for those that were new to research and looking to discuss their ideas and work so far.

Over the course of three days the conference will offer an opportunity for discussion, debate and engagement across a range of concerns that affect the discipline of jewellery. It hopes to provide a framework for discussion on and around British Contemporary Jewellery by posing a number of questions pertinent to the current global situation and exploring the discipline through some specific contextual lenses.

PTO...

Association for Contemporary Jewellery  
PO Box 71338, London, SE17 9DY, UK  
enquiries@acj.org.uk www.acj.org.uk

Association for Contemporary Jewellery  
PO Box 71338, London, SE17 9DY, UK  
enquiries@acj.org.uk www.acj.org.uk



**Saturday Afternoon - Access Programme for the Jewellery Enthusiast**

**2.00** Linda Lambert - welcome  
**2.20** Kelvin Birk - Thinking, Making, Wearing  
**3.20** break  
**3.45** Terry Hunt (ACJ Chair) discusses the ACJ touring exhibition *Meanings and Messages*  
**4.15** break  
**4.45** Linda Lambert and Anthony Wong in conversation discussing commissioning that special piece  
**5.10** Emma Paragresan (Sheffield Assay Office) - Hallmarking: one of the earliest forms of consumer protection  
**5.40** Linda Lambert - Questions  
**6.00** close

**Sunday Morning**

**9.30** Associate Professor Dr Supavee Sriniraporn & Dr Khajornsak Nakpan (Sukhothorn University) - Innovative synthesised bio melanin fibre from pre-historic soil to design ethnic contemporary body ornaments which reflect civilization and respect cultural diversity in Pang Ma Pa District, Mae Hong Son Province Thailand  
**10.10** break  
**10.30** Sic Tieu (School of Art & Design - UNSW Sydney) - Connecting Intercultural Values and Making  
**10.50** Yinglong Li - Sustainability of Traditional Craft: rethinking the knowledge and value of making with the enamelling technique of plique-à-jour

**11.10** break  
**11.30** Professor Theo Smeets (Hochschule Trier) - "Let There Be Rock!"  
**12.20** Professor Theo Smeets and Dr Jivan Astfalck - Plenary  
**12.40** Conference finishes

SUPPORTED BY



Association for Contemporary Jewellery  
PO Box 71338, London, SE17 9DY, UK  
enquiries@acj.org.uk www.acj.org.uk



We are delighted to announce the conference programme and the live streaming sessions

**Tickets and Booking Information**

The sessions are priced at £20 each or £70 for all four sessions. To access the live streaming please visit <https://www.eventbrite.co.uk/e/acj-conference-2022-beyond-silver-25-years-of-the-acj-live-streams-tickets-353731659917>

**Friday Afternoon**

**3.00** Welcome & Introduction Terry Hunt (ACJ Chair) joined by Charlotte Dew (The Goldsmiths' Centre)  
**3.20** Dr Jivan Astfalck - Where do we go from Here?  
**4.10** break  
**4.40** Charlotte Dew (The Goldsmiths' Centre) - What potential do NFTs (non-fungible tokens) and the metaverse hold for jewellery, beyond silver?  
**5.10** Meng He - Application of Additive Manufacturing in Jewellery  
**5.30** M.Kala - From African Symbol to Jewellery: how I became a jeweller  
**5.50** break  
**6.00** Silna Wien - Serendipity in Contemporary Jewellery  
**6.20** Bridie Lander (Birmingham School of Jewellery) - BJ\_3pa  
**6.30** Close

**Saturday Morning**

**9.30** Dr Stan Hinde (Birmingham School of Jewellery) - Jewellery's Circular Economy: materialising connectors through the gifting and wearing of adornments  
**10.10** Anthony Wong - The Blue Funnel Line and a Ring in his Pocket  
**10.40** Seun Kim - The Heritage Collection 100 Project  
**11.00** break  
**11.20** Anna Börcök - The Fields of the Hungarian Narrative Jewellery  
**11.50** Jo McAllister - Jewel Narratives: Past, Present and Intertwined  
**12.10** Mark Cutler (Presman Mastermelt) - Workshop Reclamation Seminar  
**12.45** Break

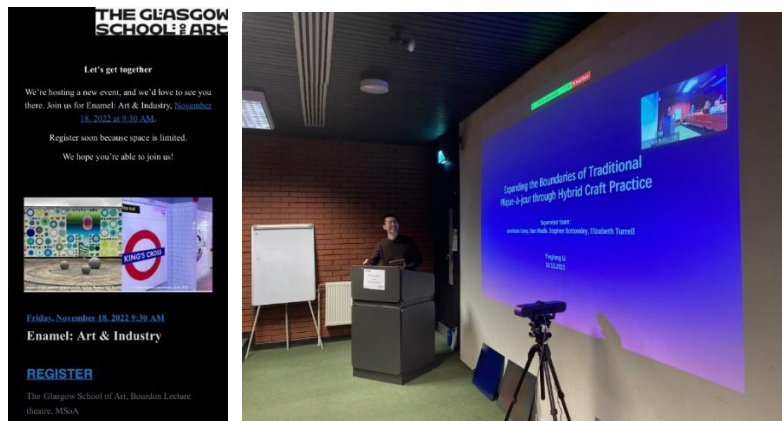
PTO...

# Symposium

## Symposium 1: Enamel: Art & Industry

Presentation title: Expanding the boundaries of traditional enamelling plique-à-jour through hybrid craft practice

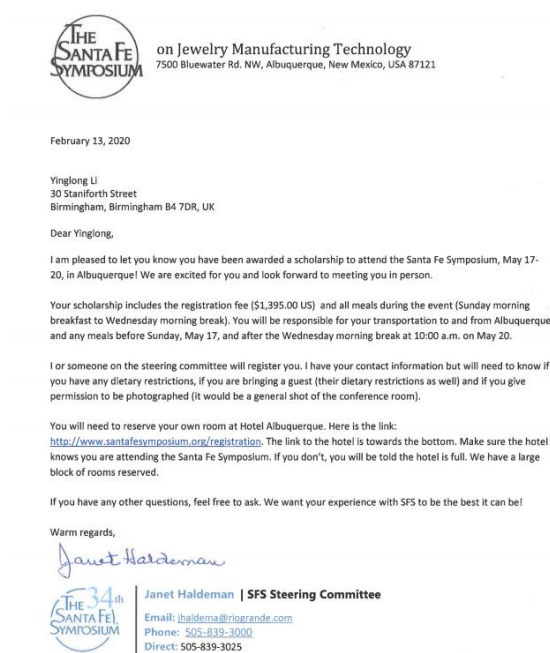
Address: Glasgow School of Art; Date: 18<sup>th</sup> November 2022



## Symposium 2: The Santa Fe Symposium: on Jewelry Manufacturing Technology

Achieve: Scholarship

Address: New Mexico, USA. Date: 17<sup>th</sup> – 20<sup>th</sup> May, 2020.



# Appendix 3: Art work award

## The I-PAJ series:

Title: I-PAJ 2; Technique: plique-à-jour; Date: 2021-2022



## Award and certificate:

**Goldsmiths' Craftsmanship & Design Council Competition 2022, London, the UK.**

- Gold award: Enamel & Enamel Painters 3D Craft-Junior
- Gold award: The Phil Barnes Enamelling Bursary
- Silver award: Enamellers 3D Design



**The I-PAJ series:**

Title: I-PAJ 3; Technique: plique-à-jour; Date: 2021-2022



**Award and certificate:**

**Integrity·Innovation-Beijing International Contemporary Enamel Art Exhibition.**

China Arts and Crafts Association, Academy of Arts and Design, Tsinghua University.

June, 2022. Beijing, China.

Work selected



*Poster of the exhibition*



*Certificate of the exhibition*

**TALENTE – Masters of the Future 2023 competition, Munich, German.**

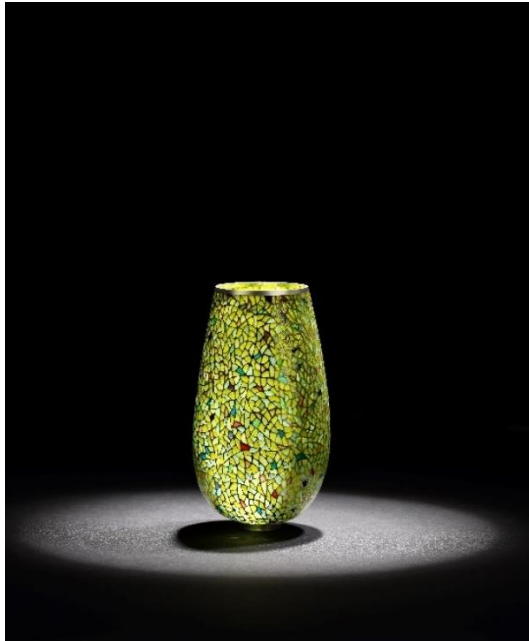
Achieved award: Talent Prize (Metal group) (work: I-PAJ 3)



*The works were presented at the Masters of the Future 2023 competition.*

**The I-PAJ series:**

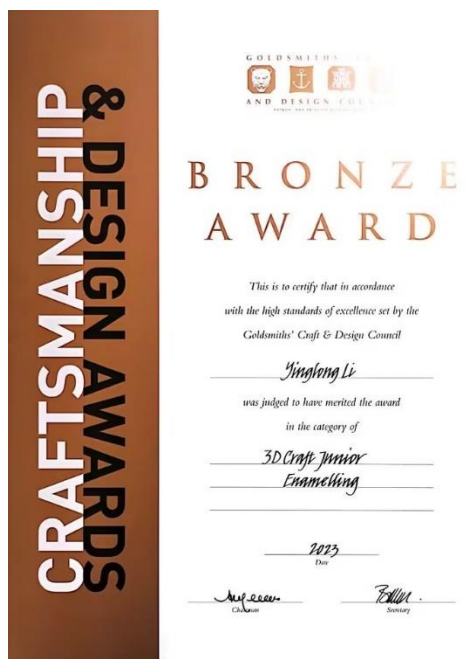
Title: I-PAJ 4; Technique: plique-à-jour; Date: 2022-2023



**Award and certificate:**

**Goldsmiths' Craftsmanship & Design Council Competition  
2023, London, the UK.**

- Bronze award: Enamel & Enamel Painters 3D Craft-Junior



**The I-PAJ series:**

Title: I-PAJ 5; Technique: plique-à-jour; Date: 2023



**Collection:**

The works I-PAJ 2, I-PAJ 3, and I-PAJ 4 are permanently collected by the Victoria & Albert Museum.

The work I-PAJ 5 is permanently collected by the Oriental Museum, Durham University.

## Appendix 4: Viva exhibition

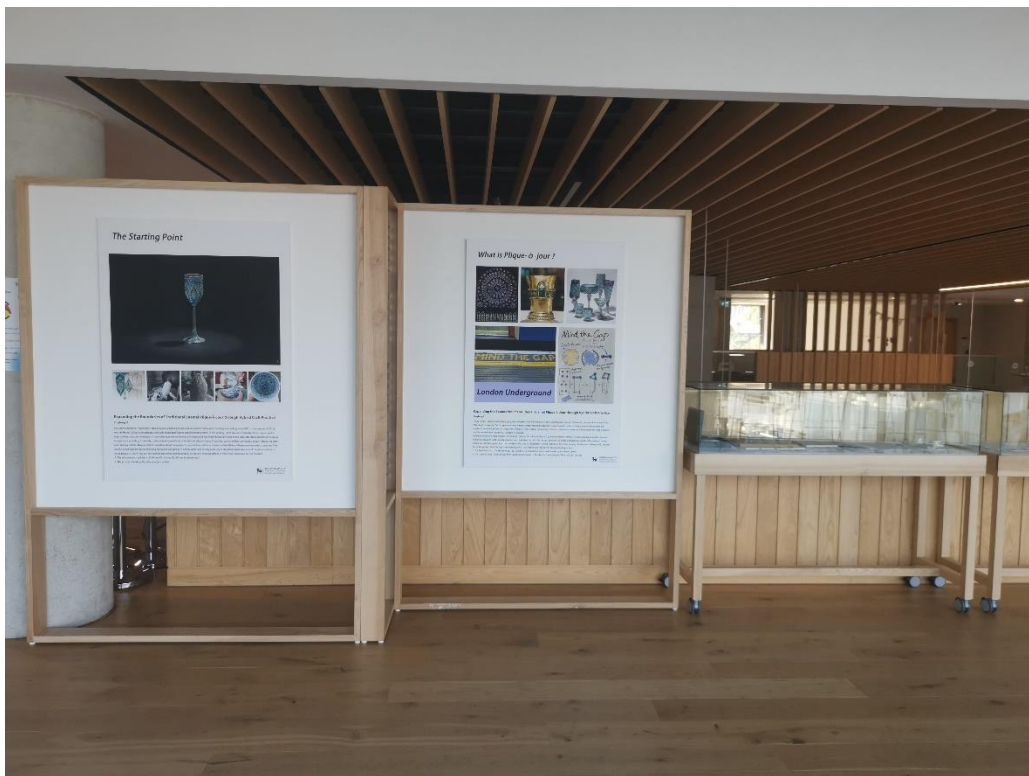
### Viva exhibition poster





## Viva exhibition at the Bradshaw Hall Exhibition Space, Royal Birmingham Conservatoire

- The exhibition space and the six exhibition boards







- The works in the three cabinets









