



# Sustainable Valorisation of Animal Manures via Thermochemical Conversion Technologies: An Inclusive Review on Recent Trends

Prangya Ranjan Rout<sup>1</sup> · Daya Shankar Pandey<sup>2,8</sup> · Macsen Haynes-Parry<sup>3</sup> · Caitlin Briggs<sup>4</sup> · Helmer Luís Cachicolo Manuel<sup>3</sup> · Reddicherla Umaphathi<sup>5</sup> · Sanjay Mukherjee<sup>6</sup> · Sagarika Panigrahi<sup>7</sup> · Mukesh Goel<sup>3</sup>

Received: 2 March 2022 / Accepted: 21 August 2022 / Published online: 10 September 2022  
© The Author(s) 2022

## Abstract

**Purpose** With its substantial CO<sub>2</sub>eq emissions, the agricultural sector is a significant greenhouse gas (GHG) emitter. Animal manure alone contributes 16% of the total agricultural emissions. With a rapidly increasing demand for animal-based protein, animal wastes are expected to rise if sustainable manure management practices are not implemented. Manures have the potential to be treated to generate valuable products (biofertiliser and biocrude) or feedstock for energy production. Thermochemical conversion technologies such as pyrolysis, combustion, supercritical gasification (SCWG), etc., have demonstrated their potential in manure management and valorisation. This study provides a broader overview of these technologies and envisages future manure valorisation trends.

**Methods** The paper presents a state-of-the-art review of manure valorisation. Characterisation of manure, modelling and optimisation of thermochemical conversion technologies along with life cycle analysis (LCA) are also reviewed.

**Results** The literature review highlighted that the thermochemical conversion technologies can generate bio-oils, syngas, H<sub>2</sub>, biofuels, heat, and biochar as carbon-free fertiliser. The reported calorific value of the produced bio-oil was in the range of 26 MJ/kg to 32 MJ/kg. However, thermochemical conversion technologies are yet to be commercialised. The major challenges associated with the scale-up of manure derived feedstocks are relatively high moisture and ash content, lower calorific

---

Prangya Ranjan Rout and Daya Shankar Pandey have contributed equally to this work.

---

✉ Mukesh Goel  
Mukesh.Goel@shu.ac.uk

- <sup>1</sup> Department of Biotechnology, Thapar Institute of Engineering and Technology, Patiala, Punjab, India
- <sup>2</sup> Center for Rural Development and Innovative Sustainable Technology, Indian Institute of Technology Kharagpur, Kharagpur, West Bengal, India
- <sup>3</sup> Department of Engineering and Mathematics, Sheffield Hallam University, Sheffield, UK
- <sup>4</sup> Department of Chemical Engineering, Newcastle University, Newcastle upon Tyne, UK
- <sup>5</sup> Department of Biological Engineering, Inha University, Incheon, Republic of Korea
- <sup>6</sup> Energy Systems Catapult, Birmingham, UK
- <sup>7</sup> Department of Biological and Chemical Engineering, Aarhus University, Høngøvej 2, Denmark
- <sup>8</sup> Clean Hydrogen Limited, University of Surrey, Guildford GU2 7XH, UK

value and higher concentration of impurities (N, Cl, and S). LCA studies conclude that gasification presents a sustainable option for manure valorisation as it is economical with modest environmental threats.

**Significance of Study** This review briefly states the current challenges faced in manure management and presents the case for a sustainable valorisation of animal manures using thermochemical technologies. The economic, environmental and societal advantages of these technologies are presented in order to promote the scientific and industrial development of the subject in the academic and research community.

**Conclusions** Thermochemical conversion technologies are promising for manure valorisation for energy and nutrient recovery. However, their commercialisation viability needs wide-ranging evaluations such as techno-economics, life-cycle analysis, technology take-up and identification of stakeholders. There should be clear-cut policies to support such technologies. It should be advocated amongst communities and industries, which necessitates marketing by the governments to secure a clean energy future for the planet.

### Graphical Abstract

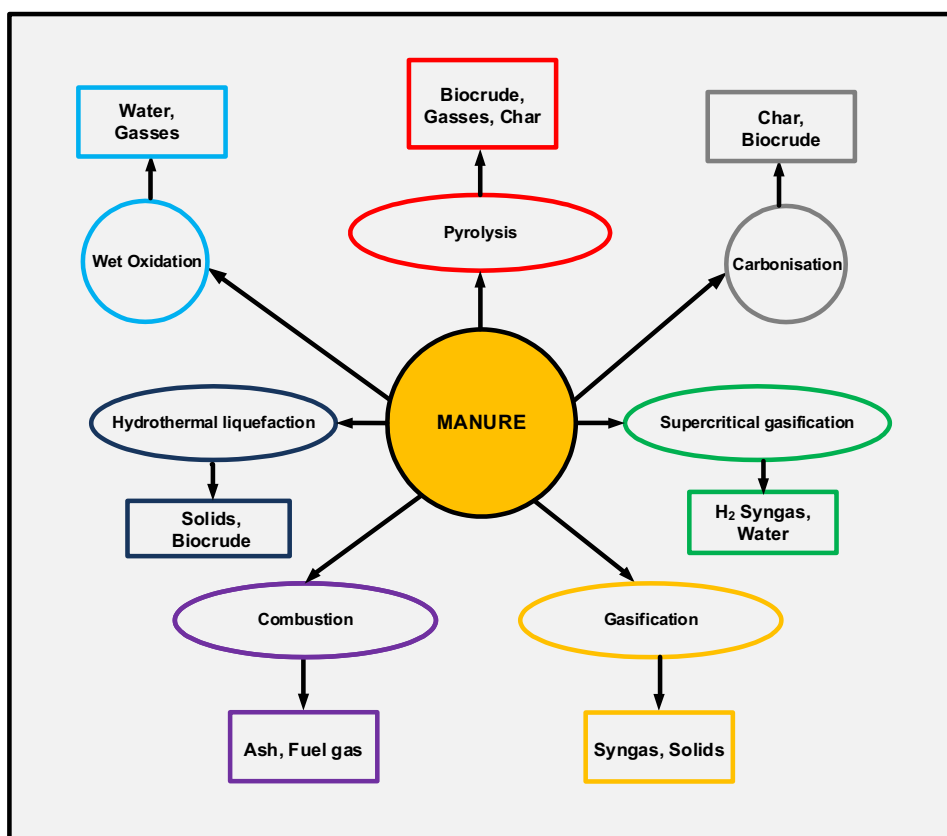

**Keywords** Review · Thermochemical conversion technologies · Manure valorisation · Pyrolysis · Gasification · Supercritical water gasification

### Statement of Novelty

The global livestock industry has been growing at unprecedented levels resulting in a rapid increase in manure production. Moreover, animal manure has the potential to be utilised as a renewable energy feedstock to produce bioenergy. Thermochemical conversion processes are fast-emerging sustainable technologies and are considered

one of the best options for animal manure management promoting a circular bioeconomy and decarbonising the agriculture sector. However, a wide-ranging review on various thermochemical processes for multitudes of manure is lacking in the literature. This review is a novel attempt to thoroughly discuss various thermochemical conversion processes for manure valorisation. To the best of the author's knowledge, this kind of holistic review is

not attempted before. The authors believe this work could accelerate research and discussion about exploiting thermochemical conversion processes as a sustainable manure valorisation technology. Discussion on LCA, reactor technologies for scale-up, and comparative study of pyrolysis, gasification, supercritical water gasification (SCWG) further adds to the novelty to the work.

## Introduction

The global livestock industry has been growing at unprecedented levels and is regarded as one of the largest anthropogenic land users, currently employing 1.3 billion people and accounting for 40 to 50% of agricultural gross domestic product [1]. Meat consumption, for instance, had a two-fold increase worldwide in 50 years, rising from 23.1 kg per person per year in 1961 to 42.20 kg per person per year in 2011 [2]. In addition, it was reported that due to the increase in human population, household incomes and urbanisation led to a five-fold increment of pig and poultry production [3]. Figure 1 illustrates the pig and cattle production in different countries during 2020. The share of EU meat production quantity is shown in Fig. 2. Consequently, the increase of animal protein demand led to intense livestock breeding, resulting in a rapid increase in manure production worldwide [4]. Nevertheless, the current demand for animal-based protein intake is the major factor behind the development of the global food trade market. China is the largest animal manure producer in the world: it produced approximately 3.8 billion tonnes of manure in 2017 as opposed to 243 million tonnes in 2007 [5, 6], while the European Union (EU-27) and the UK produced more than 1.4 billion tonnes of manure per year [7]. The six countries (Denmark, France, Spain, Poland, Italy, UK) produced approx. 68% of the total manure, followed by Ireland and the Netherland (Fig. 3).

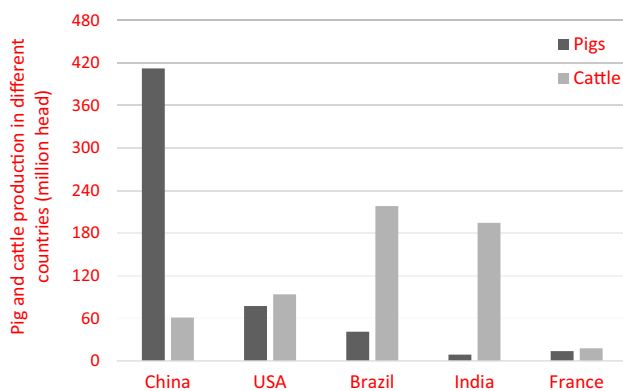
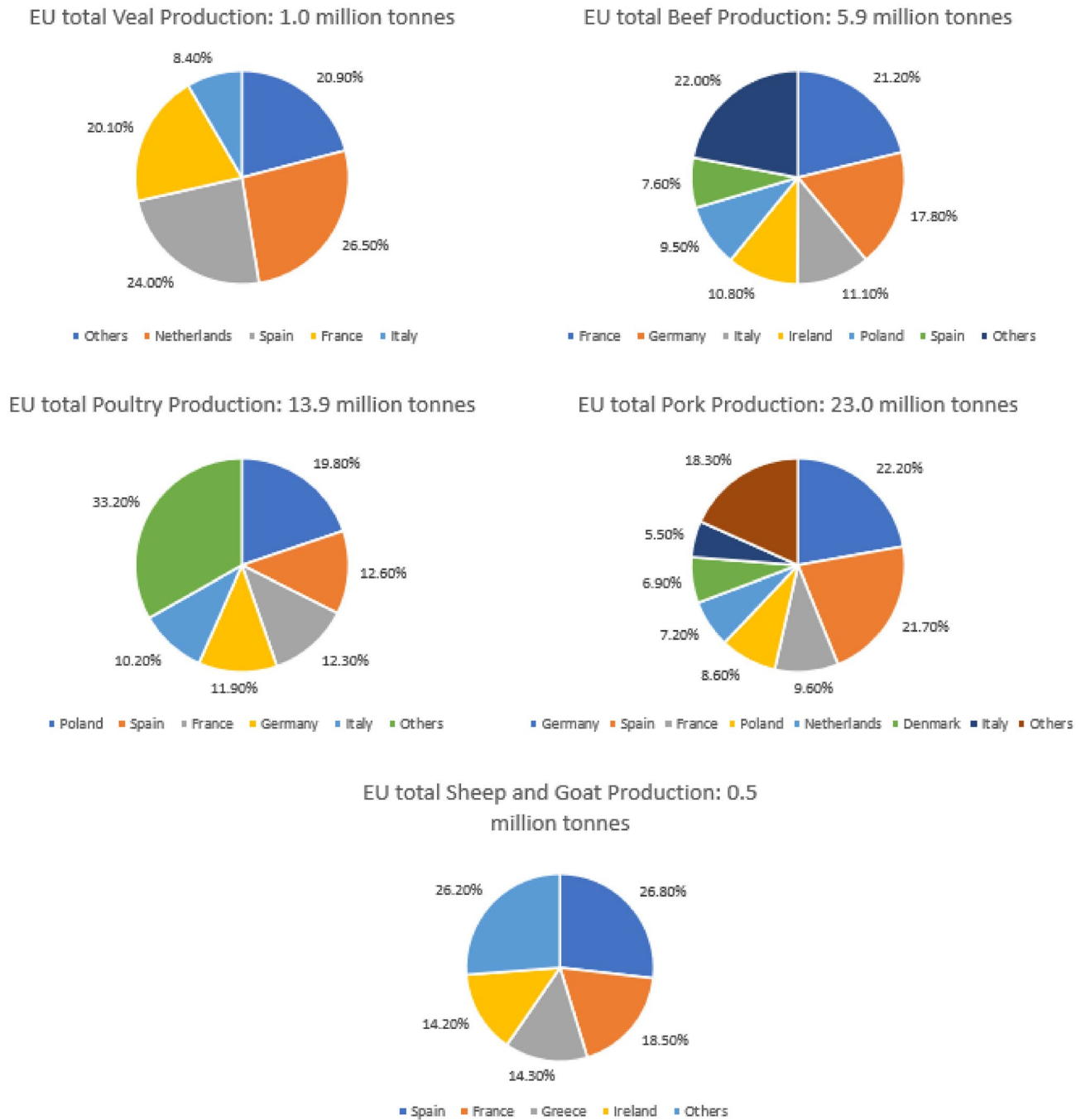

**Fig. 1** Pig and cattle production in different countries in 2020 (FAO, 2020)

Animal manure poses a severe threat to the environment as its decomposition releases chemical substances causing a significant risk of contamination and pollution to the soil, surface and underground water and atmospheric air, if not handled properly [8, 9] (Fig. 4). A common example is a formation of nitrate and ammonium ions and gaseous ammonia through nitrification and ammonification of nitrogen, respectively [10, 11, 12]. These naturally occurring processes form highly soluble compounds ( $\text{NO}_3^-$ ,  $\text{NH}_4^+$ ) and gases ( $\text{NH}_3$ ) that, if released at high concentrations, contaminate the groundwater, soil solutions and pollute the air [13, 14, 15, 16]. The emissions from global livestock continue to grow considerably, currently representing 14.5% of total anthropogenic greenhouse gas (GHG) emissions and amounts to 7.1  $\text{GtCO}_{2\text{eq}}$ /year [17, 18]. The formation of harmful substances, gases and volatile organic compounds from animal manures set manure management a central issue in international protocols that assess effective ways to reduce global warming and promote sustainable development [19, 20, 21].

Furthermore, animal manure's improper storage, handling and disposal constitute a health hazard to human and animal life [22]. Manure is a source of zoonotic pathogens and heavy metals [23], which can be transmitted to food and water sources by direct deposition, water runoff events or other routes, thus increasing the risks of contamination to direct and indirect consumers [24, 25, 26]. Excessive manure land spreading leads to abnormally high concentrations of nutrients (K, P) that may move from the soil to water bodies by runoff [27]. Nutrient over-enrichment of soils poses a particular threat to aquatic ecosystems, resulting in the eutrophication of lakes and death of fish and aquatic life forms [24, 27]. If the projections continue at the same rate, the mismanagement of manure could cause significant damage to the environment, leading to increased GHG emissions, climate change, deforestation and the loss of biodiversity [28]. Therefore, addressing the challenges associated with the nexus of food production, energy, water, climate change and health requires urgent attention to curb the negative impacts of mishandling animal manure.

Composting and incineration are traditional methods used in agronomy to treat manure [29, 30]. Although farmers extensively use these methods, their practical implementation is not viable due to several environmental concerns. These could be GHG emissions [31], discharge of mass of solid particles, odour development [32], and eutrophication [33], among others. Anaerobic digestion (AD) is one of the most common biochemical processes applied to solid waste and wastewater treatment [34, 35, 36]. Although it is considered a suitable technology to treat large quantities of animal manure, AD has its own drawbacks. It offers a limited flexibility for utilising different feedstock, restricted to only high moisture contentious feedstock such as sewage sludge and cow manure [37, 38, 39]. An alternative to biochemical

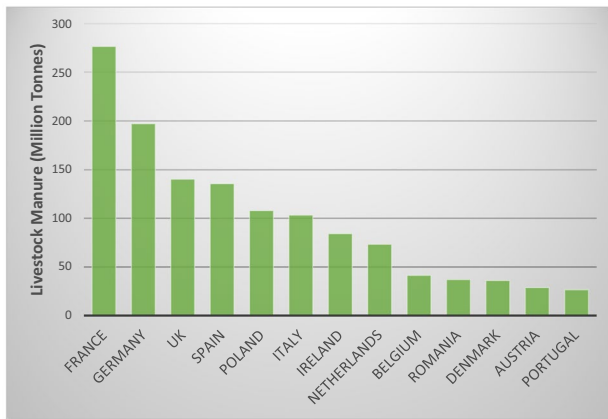

**Fig. 2** Share of quantity of EU meat production (2019) (Eurostat)

conversion is the thermochemical conversion process, which refers to the depolymerisation and reforming reactions of lignocellulosic compounds present in biomass, in heat and oxygen-controlled enclosure under low to relatively high pressure [40]. The main products of this process are bio-oil, syngas or product gas and bio-fertiliser [41, 42].

Thermochemical conversion comprehends both dry (non-aqueous) and hydrothermal (aqueous) techniques. Figure 5

depicts various thermochemical processes. One of the most frequently applied techniques is combustion, a process performed in an oxygen-rich ambience under high temperatures (700–1400 °C) and atmospheric pressure. It is commonly employed to generate heat and power and can only be used if the feedstock has a low moisture content [43]. Contrarily to combustion, pyrolysis is an oxygen-free process in which biomass is decomposed to directly produce bio-oil



**Fig. 3** Livestock manure production in the European Union and the UK (2016–2019). Adapted from Koninger et al. [7]

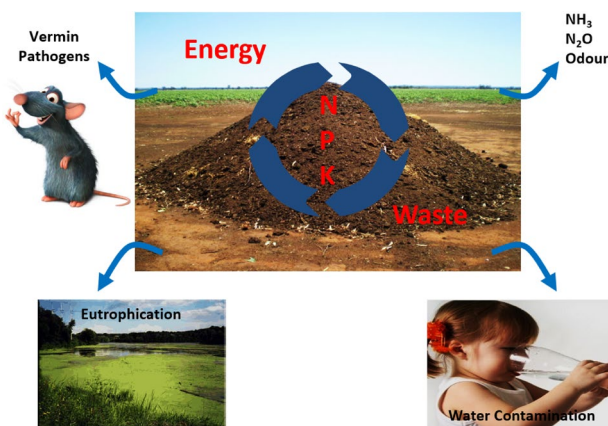

**Fig. 4** Direct land spreading issues with the manure

and syngas [44]. This process occurs at temperatures ranging from 300 to 850 °C under atmospheric pressure [45, 46]. Hydrothermal carbonisation (HTC) is another thermochemical conversion technique used to treat animal manure [47]. It involves the reaction between biomass and hot compressed water or steam, subject to temperatures and pressures within the ranges of 180–300 °C and 0.1 to 8 MPa in an oxygen-starved atmosphere [48, 49, 50]. Gasification involves converting organic matter into a gaseous mixture known as syngas (CO, H<sub>2</sub>, CO<sub>2</sub>, CH<sub>4</sub>) in an oxygen-deficient environment in the presence of a gasifying agent. It requires high temperatures (600–1300 °C) and atmospheric pressure [51]. The SCWG process is another thermochemical technology that requires operation at the water's supercritical condition. Lately, SCWG has been pushed as a frontier technology to decompose manure and produce valuable energy products [52].

It is expected that the world will face the problem of oil reserves depletion before 2050 [29], at which point there

would be an urgent necessity for an alternative source of energy. In this context, thermochemical conversion technologies present an essential solution to global energy demands: the bio-oil produced during these processes is considered a potential replacement for fossil fuels when upgraded to biofuel, with a reduced oxygen content and high heating value [53]. Moreover, biofuel is appreciated as an alternative to fossil fuel due to its potential to reduce global warming because of its greenhouse gas neutrality and renewability [16, 29].

Presently, numerous reviews on manure valorisation have been published. Font-Palma [133] produced a comprehensive study on cattle manure disposal. Yang et al. [54] discussed the distribution of antibiotics in livestock manure. The fate and distribution of heavy metals during the thermochemical conversion of manure are summarised by Li et al. [55]. Manogaran et al. [56] presented a detailed review of chicken manure treatment processes. Other extensive studies on thermochemical processes are reported [57, 58, 59, 60, 61]. However, a wide-ranging review on various thermochemical processes for multitudes of manures is lacking in the literature. This comprehensive review thoroughly analyses the state-of-the-art technologies employed in manure valorisation using thermochemical processes such as pyrolysis, gasification and the SCWG process as well as other thermochemical technologies like HTC and hydrothermal liquefaction (HTL). Manure is characterised in detail and its implementation is evaluated concerning the different thermochemical technologies available. The subsequent bio-oil, syngas, H<sub>2</sub>, biochar generation through thermochemical technologies are also reviewed. In addition, modelling and optimisation methods for thermochemical technologies, reactor technologies for scale-up, and comparative study of pyrolysis, gasification, SCWG are elaborately discussed. Furthermore, LCA studies involving thermochemical processes are also reviewed. The review concludes with challenges and future perspectives of thermochemical conversion technologies pertaining to animal manure-derived feedstocks.

## Characterisation of Manure

Manure is an important resource of nutrients for crops and can aid in enhancing soil productivity. It is an inevitable by-product of poultry and livestock production. The physicochemical properties of manures are one of the most crucial parameters for its valorisation and have an immense influence on thermochemical conversion processes and the final product formation. Manure is classified as a mixture of urine, faeces, bedding materials and wasted feed. Manure with bedding material is a good source of organic matter, increasing the quantity of soil. Manure components have

**Fig. 5** Various thermochemical conversion technologies for manure management

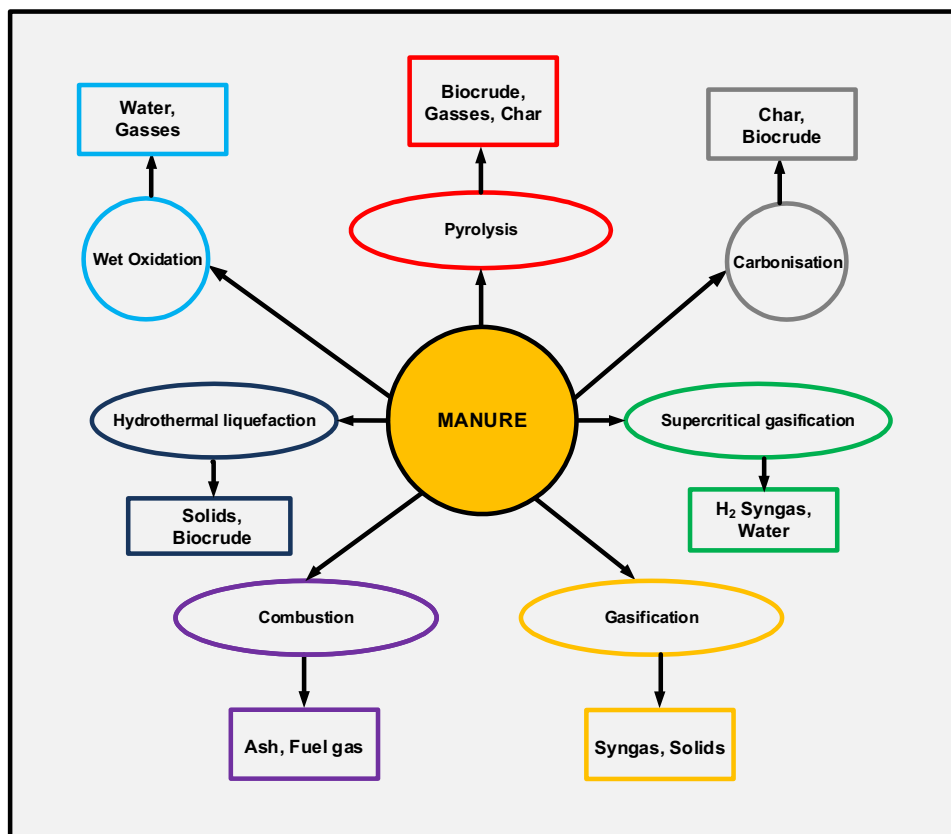

been divided into two types, viz inorganic and organic. Animal manure majorly consists of fibre, including cellulose, hemicellulose and lignin. Manure is also considered as an organic fertiliser that consists of macro (potassium (K), nitrogen (N), and phosphorus (P)) and micro nutrients such as zinc (Zn), iron (Fe), cobalt (Co), manganese (Mn), sodium (Na), magnesium (Mg), copper (Cu), sulphur (S) etc. [55, 62]. As an essential element in plant nutrition, K is required to function in all living cells. Dairy manure is a rich source of K for the growth of plants. Altogether, macro and micro elements make livestock manure an ultimate fertiliser for nutrient deficient soils to enhance the crop yield and quality. Nutrients, organic matter and manure water constituents are greatly varied, making them more complicated to manage than synthetic fertilisers. Characteristic properties of manure depend on various factors such as diet, proteins, species of animal, fibre content, digestibility, animal age, stage of production, housing and environment. Manure can be characterised in various ways. Vital characteristic properties for manure collection, handling, storage and utilisation include the solids content, makeup and particle size of the manure solids (fixed, dissolved and suspended solids). Factors affecting manure composition are feeding and nutrient excretion, water consumption, in-barn water use, livestock bedding, in-barn drying systems, weather, manure storage design, microbial decomposition, nutrients, settling of solids

and transformation of moisture [63]. A complex sample of the liquid manure is produced by (i) accumulating four or more distinct samples at a given phase of the pumping-out, (ii) mixing the individual samples in a single container, (iii) combining the contents, and (iv) filling a single sample container for transportation to the laboratory [64, 65, 66].

The definition of manure varies from region to region. Manure characteristics can be measured based on qualitative and quantitative methods. The qualitative analysis mainly deals with the odour whereas quantitative analyses include the physical, chemical and biological properties. Manure's physical properties are very important, owing to their operating and designing processing and handling systems. These properties include rheological properties, pH, particle size, ionic strength, electrochemical, surface charge, colloids, dissolved suspended solid, Newtonian fluid, plastic flow, suspended solids and slurry density. These characteristic features are well known for designing and developing pumps, storage tanks and separation equipment. Rheological properties and slurry density are significant for evaluating the energy requirement for handling and pumping manure. The particle size of the manure influences the sedimentation capacity during storage. Physical characteristics set the potential requirements for the advanced technologies for managing and handling the manure. Manure comprising more than 120 g/kg of dry matter is considered solid manure

[6, 65, 66]. The manure with lower than 120 g dry matter/kg is called liquid or slurry manure. In contrast to solid manure, liquid manure can be transported by pumping or drainage. Farmyard manure is produced by the animal houses where the excreted litter and solids strewed on the floor are brushed and transferred out of the shed.

The manure's composition, consistency, and quantity significantly influence the livestock manure storage facility design and its handling characteristics. Handling characteristics of the manure varies based on the types of solids present in the compound. Boundaries between the handling categories are not fixed but fluctuate with the composition of the specific component.

Nutrient values are also associated with the concentration of solids. Generally higher the concentration of solids, the higher will be the concentration of nutrients. Physicochemical estimations are accessible for most manure types. To assess what manure comprises, the laboratories must evaluate respective samples. Assessments and tabular standards and readings must be noted with caution. These can be used for planning purposes. Handling characteristics of the manure is of four types, i.e., (i) liquid, (ii) slurry, (iii) semi-solid, and (iv) solid [6, 65, 66].

Many regions need procedures to estimate manure nutrient administration plans for their facile operation. For the sampling and testing of manure following steps should be followed they are (i) choosing a testing and analysis laboratory, (ii) obtaining a sample, (iii) correct time to collect the sample, (iv) procedure for the collection of samples, (v) shipping of the samples, (vi) laboratory evaluation, (vii) testing frequency and (viii) reading and interpretation of laboratory analyses. Manure analysis will provide

the dry matter, moisture content, ammonium nitrogen, total nitrogen, phosphorous and potassium in the laboratory test evaluation. Further defining the concentration of nutrients, manure analysis can also be used to assess the proper functioning of the lagoon. To analyse manure, the lagoon should include electrical conductivity to assess the levels of chloride salts and pH. Manure is stored and handled based on the type of livestock, animal housing, manure collection, treatment of manure and manure application [65, 66, 67]. Detailed proximate and ultimate analyses of various manures are presented in Table 1.

## Pyrolysis of Manures

Pyrolysis (devolatilisation) is a thermochemical conversion process in which carbonaceous feedstocks are subjected to moderate temperature (> 300 °C) in an oxygen-free environment and produce non-condensable gases (CO<sub>2</sub>, CH<sub>4</sub>, CO, H<sub>2</sub> and other light hydrocarbons), bio-oil and solids (bio-char). The operating condition of the pyrolysis process can be decided based on the desired product. For instance, slow pyrolysis occurs at lower temperatures with long residence time whilst fast pyrolysis is conducted at higher heating rate and very short residence time and producing higher char and bio-oil yield, respectively [68, 69]. The produced bio-oil from pyrolysis process can offset fossil fuel or diesel use in furnaces, boilers, turbines and engines used for power generation purposes. During the pyrolysis process, condensable vapour originates from cellulose, whereas hemicellulose contributes to non-condensable vapour and lignin,

**Table 1** Proximate and ultimate analyses of various manures

Manure	Proximate analysis (wt%)				Ultimate analysis (dry basis, wt%)					Refs.
	MC	VM	FC	Ash	C	H	N	O	S	
Goat <sup>A</sup>	6.00	58.90	12.09	29.01	38.29	5.40	2.18	19.08	0.04	Zeng et al. [62]
Goat <sup>B</sup>	8.92	70.13	4.18	16.77	42.08	5.62	1.45	39.85	<1.00	Erdogdu et al. [88]
Dairy <sup>A</sup>	*	69.53	16.25	14.22	40.52	5.24	1.56	38.03	0.42	Zhou et al. [6]
Dairy <sup>B</sup>	*	62.00	15.00	23.00	35.20	3.10	2.20	33.30	0.70	Atienza-Martinez et al. [210]
Swine <sup>A</sup>	1.5	42.00	24.30	32.20	37.60	4.90	3.00	22.30	–	Azuara et al. [67]
Swine <sup>B</sup>	*	77.70	15.17	7.13	33.52	6.17	2.80	56.69	0.82	Janković [211]
Horse	8.20	70.40	11.00	10.50	43.30	5.90	0.90	30.40	0.80	Chong et al. [150]
Cattle <sup>A</sup>	6.75	52.96	5.41	34.88	30.96	2.34	2.67	63.62	0.41	He et al. [212]
Cattle <sup>B</sup>	6.94	70.31	–	13.70	49.94	6.39	3.53	38.78	0.60	Sánchez et al. [213]
Chicken <sup>A</sup>	*	69.23	19.13	11.64	31.54	4.52	3.34	60.18	0.56	Yıldiz et al. [214]
Chicken <sup>B</sup>	10.20	51.10	8.20	30.60	34.40	4.10	3.27	23.40	0.81	Ro et al. [215]
Layer Manure	–	–	–	–	29.15	4.13	6.42	36.56	0.36	Mante and Agblevor [216]

A, B indicates manures are collected from different locations

MC moisture, VM volatile matter, FC fixed carbon

\*Dried feedstock

which degrades at much slower rate, contributes to the char yield [70, 71, 72]. Although the pyrolysis process has been extensively studied on lignocellulosic biomass nevertheless, literature on pyrolysing animal derive feedstocks are scanty reported.

Pandey et al. [73] experimentally studied the technical feasibility of the fast pyrolysis process of poultry litter in a laboratory-scale bubbling fluidised bed reactor and assessed the potential use of pyrolytic gases and biochar as an organic nutrient or soil amendment. The authors reported that the bio-oil yield was over 27 wt% with a higher heating value (HHV) of 32.17 MJ/kg (dry basis), almost 2/3 of that of petroleum fuels. Interestingly, the bio-oil produced from poultry litter had 1.5 times HHV of the bio-oil that was made from woody biomass. Nevertheless, the reported nitrogen content in poultry derived bio-oil was > 7 wt% as compared to the bio-oil produced from wood (0.1 wt%) [74]. The produced bio-oil analysis also revealed that it could not be used in diesel engines due to the higher total acid number but can be used as a lubricant additive. Although the retention of P and K in the biochar was over 75%, indicating its potential to be used as a soil amendment, the higher concentration of alkali and alkaline metals may restrict its use in the soil. Chicken manure with four different bedding materials (hay, rice husk, straw and wood shavings) was pyrolysed at low temperatures between 350 and 450 °C. The study revealed that chicken litter mixed with rice husk resulted in the highest biochar yield (67 wt%), whereas wood shaving mixed feedstock had the highest liquid yield (44 wt%) at 400 °C [75].

Jung et al. [76] investigated the possible utilisation of biochar as a green catalyst produced from chicken manure for biodiesel (fatty acid methyl ester-FAME) production. The authors reported that the pseudo-catalytic transesterification reaction performance of chicken manure biochar produced at 350 °C was comparable to those of commercially available porous materials (SiO<sub>2</sub>) because of the calcium presence in chicken manure and resulted in 95.6% FAME yield. Moreover, the presence of the Ca in Chicken manure can enhance the thermal cracking of FAMES. It was recommended that the biochar from chicken manure should be produced at temperatures lower than 350 °C to avoid the thermal cracking of FAME.

The slow pyrolysis process of poultry litter was experimentally studied at 400–800 °C temperatures in a laboratory-scale fixed-bed reactor under nitrogen flow. The evolved non-condensable gases (CO, CO<sub>2</sub>, CH<sub>4</sub>) were used to raise the temperature of the reactor, and it was estimated that the pyrolysis process could be thermally self-sustainable (auto-thermal) at 550 °C. The energy balance analysis showed that 1/3 of the total heating value of the poultry litter was transferred to the condensate. The maximum reported liquid condensate yield was obtained at 550 °C [77]

Mante and Agblevor [78] investigated the stability of biocrude oils produced from fast pyrolysis of manure (poultry litter), wood (pine and oak) and mixtures of manure and wood in mass ratios (75:25, 50:50 and 25:75 wt%). The authors have found that feedstocks with high nitrogenous and hydrocarbon compounds yielded biocrude oil with the highest stability. However, the presence of wood (used as a bedding material in the shed) increased the amount of oxygenated compounds, decreasing the oil stability. It was evident that the reactions of proteins with aldehydes and pyrolytic lignin were making biocrude oils less stable. Solvent addition was found to provide a platform of molecular dilution to slow down these reactions. The study concluded that to improve biocrude oils stability, eliminating specific oxygenated groups from the feedstock (mixture of manure and wood) is a must.

Cantrell et al. [79] experimentally investigated the effect of pyrolysis temperature (300 and 700 °C) on five manure-derived feedstocks (i.e., swine-separated solids; paved feedlot manure; dairy manure; poultry litter; and turkey litter). It was reported that the biochar produced from poultry litter showed the highest electro-conductivity (measurement of nutrients in the substrate). In contrast, biochar produced from swine manure reported to have the highest P, N, and S contents and the lowest pH and electro-conductivity. Biochar derived from dairy has the highest volatile matter, carbon and energy density, and the lowest ash, N and S contents. The study concluded that biochar mass recovery was directly linked with the feedstock's proximate analysis and C/N elemental ratio.

Agblevor et al. [80] used a fast pyrolysis fluidised bed reactor to convert poultry litter from broiler and turkey houses and hardwood bedding material into biocrude oil. The reported bio-oil yield from chicken broilers, turkey litter and bedding alone were 36–46 wt%, 50 wt% and 63 wt%, respectively. Furthermore, the pH of the poultry litter derived bio-oil was approximately 6, whilst the reported pH value for turkey litter and hardwood were 4.2 and 2.7, respectively. It was clearly evident that the poultry litter derived biocrude oil has much higher pH than typical bio-oils [69]. The HHV of the poultry litter derived biocrude oils was in the range of 26 MJ/kg to 29 MJ/kg compared to the bedding material 24 MJ/kg. The comparatively HHV of biocrude oil from poultry could be linked to the higher protein content. The major findings of this investigation were that the biochar and biocrude yield were affected by the ash content in the feedstock and the biochar contains high amounts of macro nutrients (P, K, Ca, Na, Mg), the chemical composition and viscosity of produced biocrude oils varies considerably and is dependent on the source material and pyrolysis temperature.

In a fluidised bed reactor, Kim et al. [81] performed fast pyrolysis studies under nitrogen as a fluidising media on



chicken litter, chicken litter mixed with woodchips and turkey litter using silica sand as bed material. The experiments were conducted between 450 and 550 °C and the vapour residence time was varied from 0.5 s and 5 s. Each experiment lasted for an hour and the feeding rate was 0.2 kg/h. The high ash content in the feedstock yielded high char content (22–45 wt%) and a comparatively lower liquid yield (15–30 wt%) compared to woody biomass, which produced up to 42 wt% bio-oil. The gas yield increased from 32 to 61 wt% with the increase in temperature. The biochar retained most of N–P–K and Ca present in the original litter samples, suggesting that it could be used as a fertiliser [82].

Koutcheiko et al. [83] investigated physico-chemical properties of a bio-organic char derived from poultry litter and suggested that it can be used a source material to produce activated carbon. The study concluded that biochar with around 35% carbon and 43–45% inorganic mineral can be utilised to produce activated carbon.

Whitely et al. [84] studied the thermal decomposition behaviour of poultry litter under a nitrogen atmosphere using a thermogravimetric analyser (TGA) combined with mass spectrometry and Fourier transform infrared spectroscopy to produce activated carbon and carbon black. The decomposition process was divided into four stages to obtain activation energy ( $E$ ). The ammonia evolution was linked to the evolution of ammonium salts in the first stage (160 °C,  $E = 100.6$  kJ/mol), devolatilisation of lignin and hemicellulose, with the evolution of sulphur compounds  $H_2S$  occurred in the second stage (160 and 290 °C,  $E = 52.11$  kJ/mol), devolatilisation of cellulose linked to the release of  $N_2O$  in the third stage (290 and 390 °C,  $E = 193.9$  kJ/mol) while the actual decomposition of cellulose occurred in the fourth stage (390 and 500 °C, with highest  $E = 242.3$  kJ/mol). A summarised performance analysis of pyrolysis products from animal manure is described in Table 2.

Azuara et al. [67] investigated fast pyrolysis of pig manure at temperatures of 400, 500 and 600 °C and found

that 92–97% of phosphorus present in the pig manure could be recovered from the biochar formed and following combustion of the biochar 100% of the phosphorus can be leached as ortho-phosphate. The optimum temperature for the maximum bio-oil yield of 18.48 wt% and HHV of 13.59 MJ/kg was reported at 600 °C for swine manure [85]. The researchers recommended that the swine manure be mixed with other manure feedstocks due to its low energy yield and high-moisture content. Similarly, Selim and Amano [86] also advocated mixing manure feedstocks to increase biochar output and process efficiency. The study compared pyrolysis of cow and chicken manure at varying concentrations and heat rates with nitrogen used as a gas agent, it was found for slow heat rates, cow and chicken manure differ when thermally degraded and that a 40% cow manure concentration keeps an exothermic reaction over the pyrolysis period. Azargohar et al. [87] researched the fast pyrolysis of waste biomasses such as wheat straw, sawdust, flax straw and poultry litter at temperatures 400, 475 and 550 °C. Overall, as temperature increased, the share of methane and hydrogen in the gaseous phase increased, in addition to an increase in bio-oil collected for wheat and poultry litter. Similarly, pyrolysis of goat manure resulted in the highest bio-oil yield of 26.1 wt% in a fixed bed reactor at 500 °C. The temperature ranges examined were 300–600 °C. The bio-oil obtained had a carbon content of 51.75% increase from the 42.08% found in the raw feedstock [88].

### Catalytic Pyrolysis

Catalytic pyrolysis is deemed to be a cost-effective method for improving the pyrolysis process and producing substantial biofuels. The catalyst addition reduces the activation energy and energy costs while enhancing the bio-oil yield and shaping product distributions [89]. It has been reported that the catalytic pyrolysis of cow manure using HZSM-5 zeolites significantly increased the production of aromatic

**Table 2** Performance analysis of pyrolysis product from animal manure

Feedstock	Reactor type	Temperature °C	Bio-oil yield (wt%)	Biochar yield (wt%)	Gas yield (wt%)	Bio-oil heating value (MJ/kg)	References
Poultry litter	Fluidised bed	530	27.6	31.5	21.9	33.0	[73]
Chicken litter—broiler 1	Fluidised bed	500	45.7	40.6	13.6	28.25	[80]
Chicken litter—broiler 2	Fluidised bed	500	36.8	40.8	22.3	28.0	[80]
Chicken litter—broiler 3	Fluidised bed	500	43.5	32.9	23.6	29.57	[80]
Turkey litter	Fluidised bed	500	50.2	27.6	21.7	26.25	[80]
Poultry litter	Fluidised bed	500	23.39	33.85	42.76	27.98	[81]
Turkey litter	Fluidised bed	500	26.32	24.49	49.19	26.24	[81]
Pig manure	Fluidised bed	500	26.3	39.2	15.5	28.5	[67]
Goat manure	Fixed bed	550	26.1	42.5	31.4	NA	[88]
Swine manure	Fluidised bed	600	18.48	6.0	~36.0	13.59	[85]

compounds in biofuels such as benzene, toluene, etc. This was a consequence of effective deoxygenation and aromatisation. The authors also observed that increasing the catalyst to feedstock ratio from 1:1 to 5:1 also boosted the production of biofuels [90].

Similarly, Shim et al. [91] noted that the catalytic pyrolysis of chicken manure yielded increased production of aromatic compounds. HZSM-5 zeolites were again observed to be the best functioning catalysts for pyrolysis studies. In a novel study, Lee et al. [37] stated that CO<sub>2</sub>-assisted pyrolysis using biochar catalyst resulted in enhanced formations of pyrolytic gases compared to non-catalytic pyrolysis. The authors concluded that such catalytic pyrolysis could be environmentally friendly and reasonably sustainable for pyrolytic gas production and manure valorisation.

### Fish Waste Pyrolysis

Fish waste is another animal manure with a vast scope for utilisation as a feedstock for thermochemical processes, predominately pyrolysis. Currently, island nations and countries with a higher-than-average fishing culture pioneered research in this field. However, the scope for usage on the mainland can also be seen with the high amounts of oily fish such as mackerel, providing the majority of UK fishing [92]. Pyrolysis of trans-esterified fish waste results in bio-oil yields of 72–73 wt% in the temperature ranges of 300–500 °C [93]. It can be seen that high calorific values obtained from the residual bio-oil of around 9391 kcal/kg [94] were higher than European bio-diesel specifications and more similar to petroleum [95]. Identical to other pyrolysis feedstocks, fish waste also manifested a heavy reliance on the type of catalyst utilised. Catalysts including Na<sub>2</sub>CO<sub>3</sub>, Al<sub>2</sub>O<sub>3</sub>, MgSO<sub>4</sub>, K<sub>2</sub>CO<sub>3</sub>, SiO<sub>2</sub>, MgSO<sub>4</sub>, Zeolite and hybrid mixtures of catalysts have been investigated [93], with combinations of these catalysts yielding greater performance than the individual catalysts.

In contrast to the desirable high calorific value, higher acidity and viscosity are also obtained vis-vis similar biofuels limiting the use of biofuel as an alternative to diesel [94], and this currently stands as the main limitation on the utilisation of fish waste as biofuel. The lower acidity can be obtained with the utilisation of absorbents. With absorbent

addition, pyrolysis of fish waste effluent oil fractions can be seen as a viable bio-fuel alternative to diesel, sharing similar characteristics and properties to petroleum [93].

### Bio-oil and Biochar

Comparable to the effect of changing from slow pyrolysis to fast pyrolysis, changing the type of manure used as feedstock has a high impact on the compositions of the biochar, bio-oil and their respective yields. It can be observed from Zhou et al. [6] that cattle manures lead to biochar with a higher fixed carbon (34.7–38.18 wt%) and lower ash content (45.69–47.44 wt%) than chicken and swine manure feedstocks when undergoing slow pyrolysis at 500 °C. Zhou et al. [6] further stated that dairy manure had both the lowest ash (20.69 wt%) and highest carbon content (40.91 wt%), which could suggest a lower biochar recovery than other manures such as swine or chicken manure where the ash content is higher and the carbon content lower. Interestingly, despite the decrease in the yield of biochar dairy cattle manure had the highest HHV (15.3 MJ/kg), which could still lead to it as a favourable feedstock. Further to this, Cantrell et al. [79] suggested that the more volatile matter, carbon and nitrogen present in the raw manure feedstock, the lower the recovery of biochar following pyrolysis. It is worth to mention that in order to assess the quality of biochar and before it can be classified as an organic nutrient and used as a soil amendment, further characterisation, analyses and validation are needed. The chemical compositions of biochar for various manure feedstocks are presented in Table 3. Table 4 provides the detailed inorganic composition of biochar produced from the poultry litter.

A detailed analysis of manure derived bio-oil is presented in Table 5. It is imperative to mention that since the produced bio-oil contains high moisture content, therefore; chemical fractionation needs to be carried out before the bio-oil can further be analysed. Apart from high moisture content, manure derived bio-oils are viscous in nature, unstable and reported to have a high total acid number. Since the produced bio-oil is acidic and contains high water content which limits its usability in internal combustion engines. The feedstock impurities (ash, alkali and alkaline metals) are also present in bio-oil. The amount of inorganic trace

**Table 3** Chemical compositions of biochar for various manure feedstocks [6]

	Proximate analysis (wt%)			Ultimate analysis (%wt)					HHV (MJ/kg)
	Fixed carbon	Ash	Volatile Matter	S	H	N	O	C	
Layer chicken manure	22.48	58.03	19.49	0.74	1.05	2.21	4.59	33.38	11.76
Broiler manure	31.33	54.07	14.60	1.11	1.23	3.69	3.11	36.78	13.05
Beef cattle manure	34.70	47.44	17.85	0.41	1.32	1.87	9.09	39.88	13.75
Dairy cattle manure	38.18	45.69	16.13	0.55	1.54	2.27	6.91	43.04	15.3
Swine manure	30.86	55.18	13.96	0.46	1.14	2.27	6.04	34.92	12.15

**Table 4** Inorganic composition of biochar produced from the poultry litter (in mg/kg, dry) [73]

Biochar produced at 460 °C				Biochar produced at 530 °C			
Major elements		Minor elements		Major elements		Minor elements	
Al	3300	As	<0.5	Al	5400	As	<0.5
Ca	36,400	Ba	70	Ca	37,800	Ba	69
Fe	3800	Cd	0.05	Fe	3800	Cd	0.2
Mg	20,500	Co	4.3	Mg	20,300	Co	4.9
Mn	1500	Cr	35	Mn	1500	Cr	40
P	23,700	Cu	190	P	25,500	Cu	220
K	67,900	Hg	<0.02	K	75,500	Hg	<0.02
Si	17,000	Mo	11	Si	16,300	Mo	14
S	8500	Ni	35	S	8900	Ni	42
Zn	1300	Pb	3.2	Zn	1200	Pb	4.1
		Sb	<0.5			Sb	<0.5
		Tl	<0.5			Tl	<0.5
		Ti	240			Ti	230
		V	9.2			V	9.8

**Table 5** Bio-oil composition for various manure feedstocks

	Poultry litter [73]	Poultry litter [73]	Broiler-1 [80]	Broiler-2 [80]	Broiler-3 [80]	Turkey [80]
Carbon, dry wt%	68.7	69.7	63.24	64.06	62.84	60.62
Hydrogen, dry wt%	8.2	8.2	7.22	8.14	8.31	7.16
Nitrogen, dry wt%	7.2	7.7	5.05	4.94	7.23	4.21
Oxygen, dry wt% *	16	14	23.89	22.27	20.72	28.68
O/C ratio	0.2	0.2	0.38	0.35	0.33	0.47
H/C ratio	1.4	1.4	0.11	0.13	0.13	0.12
TAN, mg KOH/g	46.3	38.5	–	–	–	–
HHV, MJ/kg	32.8	33	28.25	28.00	29.57	26.25

elements (ash) in the poultry litter derived bio-oil was over 0.32 wt% [73] exceeding the allowable limit of ash content in the biofuels (<0.02 wt%) [96].

## Gasification of Manures

Gasification of poultry litter has become increasingly popular in the recent past. Although most of the studies were conducted on the bench-scale reactor or simulation based nevertheless, poultry litter has been regarded as the potential feedstock for gasification [97, 98]. Gasification has been projected as an alternative route for processing waste and poultry litter sustainably and is considered a cleaner technology compared to incineration concerning the level of gaseous emissions produced [99, 100]. Gasification is a thermochemical conversion process where a carbonaceous fuel is partially oxidised into a gaseous product (syngas). A schematic diagram of a bubbling fluidised bed gasifier is illustrated in Fig. 6. Gasification is usually carried out at a temperature (typically over 650 °C)

and under sub-stoichiometric ratio. The quality and yield of the product or syngas largely rely on the gasifying medium (air, steam and/or oxygen), feedstock properties (moisture, ash and elemental composition), gasifier reactor type (fixed bed, fluidised bed, entrained flow) and the process operating conditions (temperature and equivalence ratio). Gasification also provides fuel flexibility to produce heat and power based on clean biomass, and the derived syngas can be used as a chemical building block [101]. It can be an effective technology and support cleaner energy strategy by generating hydrogen-rich syngas and helping decarbonise the whole energy system. The lower heating value can range from 4 to 7 MJ/Nm<sup>3</sup> when oxidised with air to 10–15 MJ/Nm<sup>3</sup> when oxidised with pure oxygen. Gasification with steam yields hydrogen rich syngas with higher heating value in the range of 15–20 MJ/Nm<sup>3</sup> [102, 103].

Although the gasification of animal manure has received increased attention but is yet to be deployed on an industrial scale. The major obstacles are the selection of the suitable gasifier for the specific fuel, high amount of

**Fig. 6** Schematic diagram of a bubbling fluidised bed gasifier (from Pandey et al. [100])

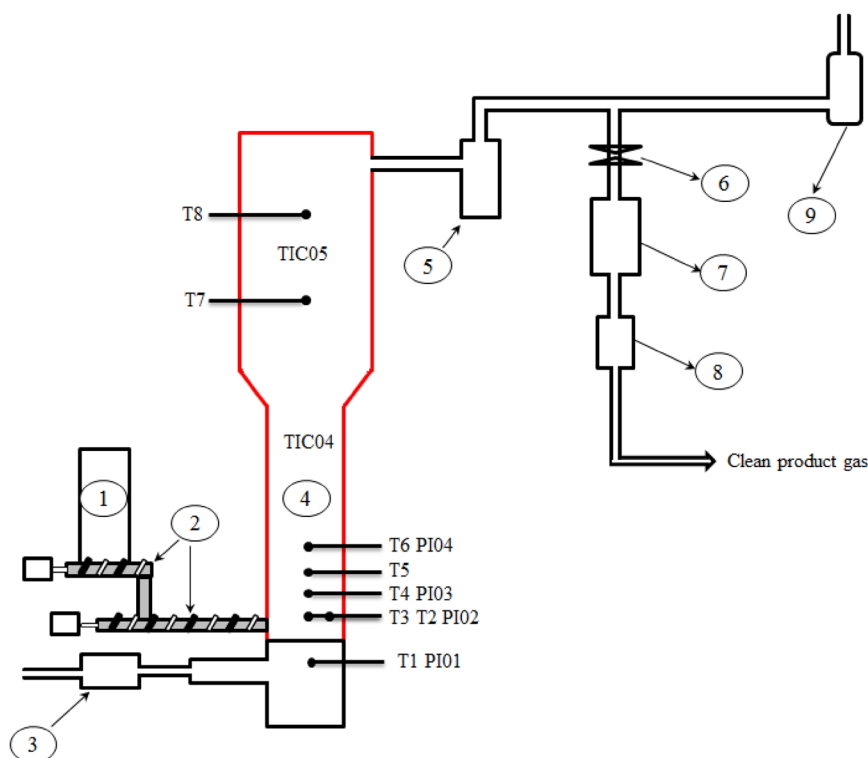

**(1) biomass hopper (2) feeding screws (3) air preheater (4) gasifier reactor (5) cyclone (6) valve (7) hot filter (8) cold filter (9) flare.**

tar in the product gas limiting its use, low carbon conversion efficiency, and disposal of by-product [104]. Despite these challenges, gasification offers greater flexibility with higher thermal efficiency (34%) compared to incineration (20%) and by-products (unconverted fixed carbon and ash) can be used as a soil amendment [100, 105].

Pandey et al. [100] investigated the effect of air, steam, gasifier temperature and addition of limestone on product gas yield, cold gas, carbon and hydrogen conversion efficiencies of poultry litter gasification process in a bubbling fluidised bed reactor. Limestone was added primarily to minimise the defluidisation or agglomeration of the bed due to high mineral content (P and K) in poultry litter ash. At an optimum operating condition (equivalence ratio of 0.25 and temperature of 800 °C), poultry litter blended with limestone yielded a product gas with an average heating value of 4.5 MJ/Nm<sup>3</sup> and a cold gas efficiency of 89%. Billen et al. [106] identified that the higher concentration of P in poultry litter ash causes the bed defluidisation problem and recommended that calcite addition could reduce the risk of agglomerate formation. Walawender et al. [107] reported that blending the bed material (silica sand) with limestone (75:25 wt%) helped to prevent the bed agglomeration during the gasification of animal feedlot.

Di Gregorio et al. [108] experimentally gasified poultry litter in a pre-pilot scale fluidised bed gasifier operating at

atmospheric pressure and critically analysed the behaviour of ash composition. The elemental composition of the poultry litter ash indicated that the higher fraction of alkali metals could have contributed to ash sintering and facilitated the bridging between bed particles. The study concluded that whilst gasification of poultry litter is technically feasible, prior fuel characterisation is absolutely necessary pertaining to the heterogeneous nature of the feedstock and to counteract the possibility of sintering and agglomerate formation.

Katsaros et al. [109, 110] successfully carried out poultry litter gasification at low temperature (700 °C) in a lab-scale fluidised reactor and obtained a gaseous product with lower heating value of 3.3 MJ/Nm<sup>3</sup>. The authors have chosen to perform the tests at a lower temperature to prevent ash sintering and agglomeration problems. To sidestep agglomeration issues, co-gasification of poultry litter experiments was conducted by several contemporary researchers in a fixed- and fluidised bed reactors. The study reported that the produced gas composition and the heating values from co-gasification of poultry litter were quite comparable. Priyadarsan et al. [111] co-gasified cattle manure and chicken litter with coal in a 10 kW<sub>th</sub> in an updraft gasifier under batch mode operation. Interestingly, the concentration of CO<sub>2</sub> and H<sub>2</sub> in the product gas derived from poultry litter gasification was slightly higher compared to coal. However, the average heating values the gases evolved from poultry litter and coal

were in the range 4.5 to 5.1 MJ/Nm<sup>3</sup>, indicating that poultry litter can be a suitable feedstock for co-gasification. Fixed bed gasifiers have extensively been used to gasify poultry litter for energy recovery [112, 113, 114] and most importantly, to reduce odour emissions and nutrient run-off while curbing land spreading. Taupe et al. [115] successfully gasified poultry litter in a small-scale updraft (batch) gasifier at low temperature (680 °C). The gaseous product reported having an average HHV of 3.3 MJ/Nm<sup>3</sup>, which is slightly lower than the heating value reported by other researchers [100, 111]. Dried swine manure was subjected to air gasification in a fluidised bed gasifier. The authors reported that an increase in gasifier temperature yielded higher product gas and energy recovery [116].

A detailed environmental and economic sustainability study on poultry litter gasification revealed that the electricity and heat generation routes reduce global warming potential and water body eutrophication [117]. A life cycle assessment (LCA) of the pyrolysis and gasification processes and their contribution in value chains to the circular economy have been investigated. Bora et al. [118] analysed the thermochemical processes of poultry litter and found that it outperformed the conventional land spreading application, which has an observable climate change impact with an improvement of 15–53%. A detailed LCA study on manure management is presented in “Life Cycle Assessment (LCA) Studies of Thermochemical Technologies” section. In conclusion, the valorisation of animal manure provides a sustainable alternative to conventional land spreading and is expected to be technically and economically feasible. Therefore, gasification and pyrolysis processes are expected to positively impact the environment while strengthening the circular bioeconomy concept in the livestock farming sector. Table 6 summarises gasification conditions and gasification products from animal manure. Although the produced syngas has the potential to be utilised in boiler or gas engines nevertheless, a prior syngas cleaning is required.

## Supercritical Water Gasification Process (SCWG) of Manures

The SCWG is an emerging technology that can efficiently convert high-moisture and low-quality wastes such as sewage, food wastes, livestock manure, etc., to electricity, heat, hydrogen and other green/future fuels. It involves a complex series of chemical reactions and works under more extreme conditions (374 °C, 22.1 MPa) to produce syngas (mixture of H<sub>2</sub>, CO<sub>2</sub>, CH<sub>4</sub>, CO, C<sub>2+</sub> etc.). High moisture content leads to increased drying duty, which could overshadow the heat of combustion, making the wastes unfit for the combustion process or even gasification. Organic waste to future fuels using SCWG have sparked tremendous interest amongst

scientists, academicians and researchers [119, 120]. The increased solubility of hydrocarbons and organic in supercritical water is the most attractive characteristic of the SCWG process [121]. Under supercritical conditions, water shifts from polar solvent to non-polar solvent, leading to enhanced solubility of organics. The density of water also decreased from 1000 at room temperature to 89 kg/m<sup>3</sup> at 500 °C and 24 MPa. Additionally, viscosity and dielectric constant are significantly reduced for supercritical water, facilitating the behaviour of water more like a non-ideal gas [122, 123, 124]. However, technology is not commercialised, and its integration with carbon capture and other established technologies needs to be thoroughly explored to make it a viable technology.

Figure 7 shows a proposed schematic of the SCWG process, using manure as a feedstock and a potassium salt catalyst. The main steps could be (i) mixing of feedstock materials, (ii) gasification reaction, (iii) Steam-methane reforming, (iv) membrane separation of C<sub>2+</sub> from natural gas, (v) water–gas-shift reaction, (vi) second membrane separation of H<sub>2</sub> from effluent, (vii) burner with zeolite catalyst to remove CH<sub>4</sub> and CO from effluent, (viii) amine separation to remove CO<sub>2</sub> from effluent, (ix) flue-gas desulphurisation to remove sulphur impurities from effluent.

Several researchers have studied the SCWG of manure. Cao et al. [125] investigated the gasification characteristics of chicken manure in SCWG using a fluidised-bed reactor. The authors studied the effects of reaction temperatures, manure concentrations and activated carbon's catalytic effect on the SCWG process's hydrogen production. It was found that temperature is a central parameter in SCWG performance since it controls the reaction mechanisms and the subsequent syngas formation. The manure was fully gasified at 620 °C without a catalyst. The process resulted in a carbon gasification efficiency as high as 99.2%. The authors also characterised the aqueous phase. Phenols, substituted phenols, carbocyclics, benzene, substituted benzenes and N-heterocyclics were the leading components in the liquid phase. It was also revealed that using a catalyst (activated carbon) significantly improved the hydrogen yield, promoting carbon conversion efficiency at a lesser temperature. The gasification process yielded 25.2 mol H<sub>2</sub>/kg biomass at 600 °C with activated carbon loading of 6 wt%.

In another study, Babaei et al. [52] examined the SCWG of chicken manure to produce hydrogen rich syngas. The authors reported the optimum conditions to be 450 °C, 15 min and 2.5 wt% feedstock under non-catalytic conditions. Two nickel-based catalysts were used: Ni/Activated carbon (AC) and Ni/AC-CeO<sub>2</sub> nanorods. The catalysts significantly improved the carbon recovery of gaseous products. It was also revealed that the Ce-modified catalyst increased H<sub>2</sub> efficiency. The gasification yield was as high as 53.7%, whereas H<sub>2</sub> production was 10.12 mol/

**Table 6** Summary of gasification conditions and gasification product from animal manure

Feedstock	Reactor type	Temperature (°C)	Equivalence ratio (-)	H <sub>2</sub> (vol%)	CO (vol%)	CO <sub>2</sub> (vol%)	CH <sub>4</sub> (vol%)	Cold gas efficiency (%)	Carbon conversion efficiency (%)	Heating value (MJ/Nm <sup>3</sup> )	References
Poultry litter	Fluidised bed	750	0.21	10.15	11.40	11.60	2.12	58	85.1	4.20	[109]
Poultry litter and beech wood (50:50)	Fluidised bed	750	0.21	7.97	10.65	12.59	3.21	55.93	78.9	4.43	[217]
Poultry litter	Fluidised bed	700	0.21	8.5	7.01	13.06	1.90	40.5	85.0	3.40	[110]
Poultry litter	Fluidised bed	700	0.30	12.04	9.69	15.60	2.46	72.5	81.8	4.72	[100]
Poultry litter (92 wt%) and lime-stone (8 wt%)	Fluidised bed	700	0.29	17.59	9.35	17.74	2.59	83.6	88.0	5.36	[100]
Poultry litter (92 wt%) and lime-stone (8 wt%)	Fluidised bed	800	0.25	10.49	9.14	12.78	2.54	84.6	89.2	4.52	[100]
Poultry litter	Fluidised bed	700–770	0.32–0.40	4.61–7.17	4.76–6.86	19.61–21.56	2.02–2.24	60.0	NR	2.80	[108]
Poultry litter	Fluidised bed	800	0.16	2.9	16.8	22.0	1.1	NR	NR	NR	[218]
Poultry litter	Fixed bed—Updraft	580–680	0.15	4.2	12.8	18.9	1.01	0.26	44	3.39	[115]
Poultry litter	Fixed bed—Updraft	817	0.34	6.1–7.3	3.7–11	28.1–28.8	0.9–1.4	NR	NR	4.3–4.6	[113]
Horse manure	Fixed bed—Down-draft		0.45	13.2	20.4	11.30	1.6	NR	NR	4.90	[219]

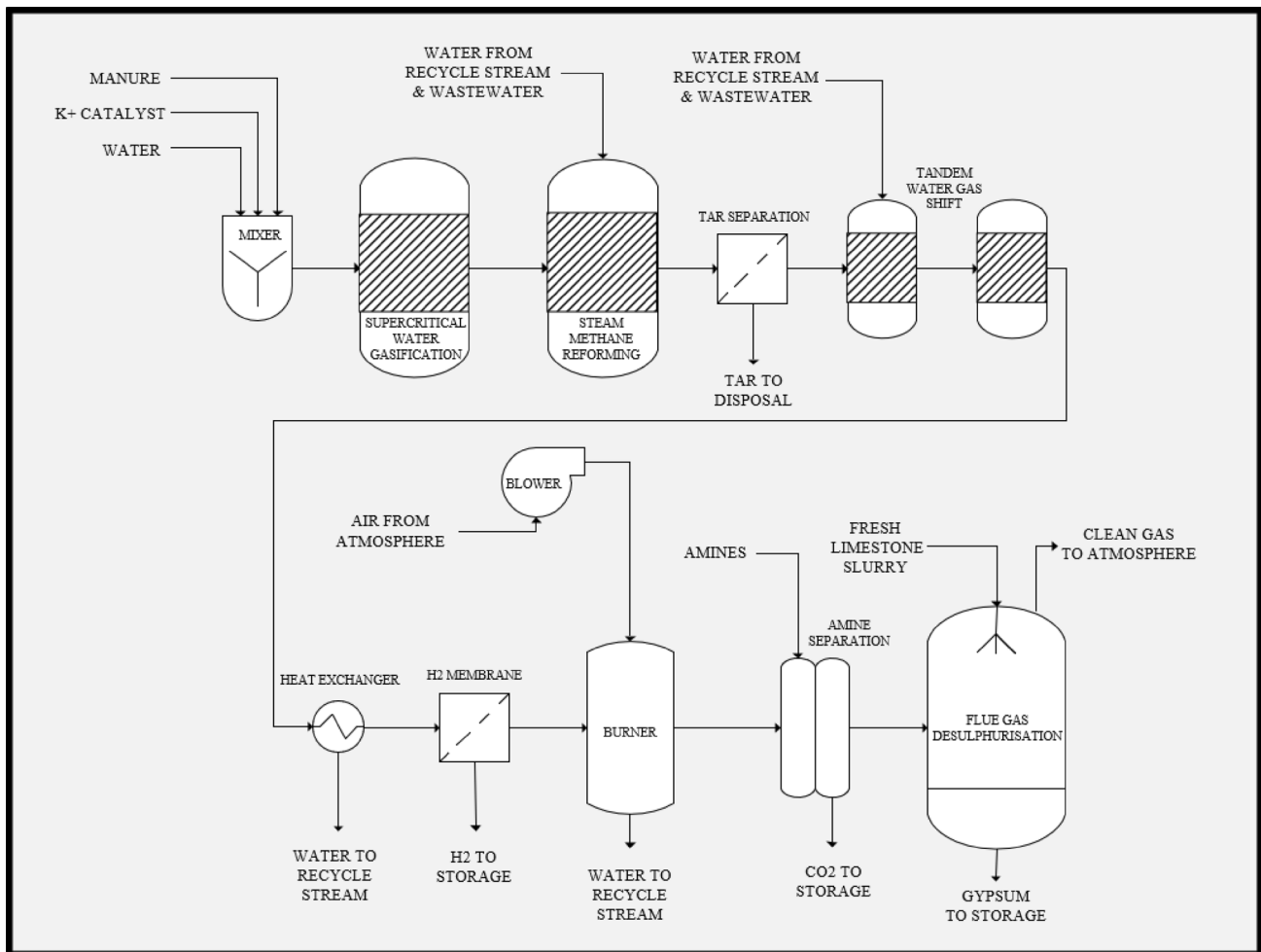

**Fig. 7** Proposed schematic of a Supercritical water gasification process using manure as a feedstock. Modified from [208]

kg of the waste. This could result from improved dispersion of metallic activated sites, as it promotes better C–C bond cleavage and methanation reaction. The AC-CeO<sub>2</sub> nanorods prevent any accumulation of metallic sites, offering the sites a prospect of opening more free radicals. The catalysts also influenced the composition of derived bio-oils. A significantly increase of phenol and phenol-containing molecules were reported. Similarly, Yong and Matsumura [126] experimented with the effect of wood addition on SCWG of chicken manure. The manure (0.5 wt%) was blended with Eucalyptus wood (0–0.3 wt%) and subjected to the SCWG in a continuous reactor. The reactor was operated in an isobaric condition (25 MPa), and the temperature varied from 550 to 650 °C. It was found that various organic matters in the manure produced fuel gases such as H<sub>2</sub>, CO<sub>2</sub> and CH<sub>4</sub>. The combination of manure and wood also resulted in reactions between their decomposition products. Interestingly, the authors found that the cellulose and hemicellulose from the wood are effortlessly transformed compared to manure's organic

matters. However, the higher loading of wood decelerated the gas production. At 0.3 wt% loading, efficiency was only 25% compared to 55% at 0.1 wt% wood content. The authors also observed that the carbon conversion efficiency increased with an increase in temperature as well as when the activated carbon was used as a catalyst.

Many researchers also explore the SCWG of various other manures. The SCWG of horse manure revealed the SCWG to be a competent remediation technology for manures to produce high quality syngas [127]. Horse manure was subjected to SCWG process to optimise the influence of temperature, biomass-to-water ratio and reaction time. The operating pressure was selected in the range of 23–25 MPa. The catalytic effect was also noted. The authors observed that gasification with 2 wt% Na<sub>2</sub>CO<sub>3</sub> at 600 °C and 1:10 feed/water ratio for 45 min produced the highest hydrogen yield (5.31 mmol/g), simultaneously generating total gas yields of 20.8 mol/kg and carbon conversion efficiency of 43.1%. Overall, the catalyst application increased the yield by 52%, compared to non-catalytic reactions. The other catalysts,

$K_2CO_3$  and NaOH, also enabled higher  $H_2$  generation. The biochar from the process, especially at higher temperatures, likewise exhibited greater thermal stability and high carbon content (> 70 wt%). This could easily facilitate their usage as soil fertiliser and for carbon sequestration. The subsequent characterisation of manure and the ensuing biochar revealed dehydration, bond breakages and transformational products formation. The biochar manifested enhanced stability compared to the horse manure as revealed by the thermogravimetric analysis (TGA) curves. It was also found that thermal stability increased with the increase in gasification temperature. The authors concluded that horse manure is a likely contender to produce  $H_2$ -rich syngas using the SCWG process. Similarly, Youssef et al. [128] examined the catalytic SCWG and partial oxidation of hog manure for hydrogen production at 500 °C and 28 MPa. The authors used several catalysts such as Pd/AC, Ru/ $Al_2O_3$ , NaOH, etc. They found that Pd/AC produced the maximum  $H_2$  (480 mol/g COD) during the gasification process, compared to other catalysts. On the other hand, the highest chemical oxygen demand (COD) reduction efficiency was achieved using NaOH catalyst. However, the sequential gasification and oxidation process resulted in reduced  $H_2$  yields but higher COD reduction, ammonia reduction, as well as reduced  $H_2S$  in the effluent gas. Comparably Xie et al. [129] observed that LiOH supplement as a catalyst increased  $H_2$  composition and the gas yield during the SCWG of horse manure. The gasification of swine manure and cattle manure were also studied by Nakamura et al. [130]. The experiments were performed in a pilot plant with a feed rate of 1 tonne/day. The results indicated that complete gasification was not accomplished for both the manures. It was speculated that this could be due to the presence of sawdust in the manures. The lignin in the sawdust reduces gasification efficiency in the supercritical water. Besides, large size sawdust cannot be fed to the reactor. Pulverisation could be the deciding factor in increasing the efficiency. However, swine manure product gas had higher methane content leading to greater heating value.

## Other Thermochemical Conversion Technologies

Several other thermochemical conversion technologies exist for the treatment of manure feedstocks. Tavasoli et al. [131] reported the production of hydrogen-rich gas and bio-oil via hydrothermal gasification with a nickel catalyst and HTC of cattle manure and feed. They operated at 380–440 °C, 2.5–3.5 wt% feed concentration and 5–30 min reaction times to find ideal levels to produce a hydrogen-rich gas and phenol, nitrogen and aromatic rich bio-oil. They concluded that adding canola stalks and  $ZnCl_2$  to the HTC process supported the gasification process. Zhou et al. [6]

investigated differing manure feedstocks in slow pyrolysis process at 400–600 °C and HTC at 180–240 °C for char production. It was noted that hydrochars from swine, broiler and layer chicken manures had the highest energy yields at 210 °C (65.5, 56.9, 64.4% respectively), concluding that hydrothermal carbonisation is a more advantageous method for solid biofuel production when compared to pyrolysis. HTC of poultry litter was conducted at different temperatures (150 to 300 °C) and residence times (30 to 480 min). It was observed that the treatment temperature significantly impacted the yield of hydrochar yield and the HHV [132].

Font-Palma [133] investigated the current manure management technologies, specifically into the use of cattle manure due to its higher calorific value to other manure feedstocks. The same group also researched different farm practices and the effect on manure's physical and chemical properties. It was suggested that anaerobic digestion with co-processing with lignocellulosic biomass and thermochemical conversion could offer the production of valuable products such as syngas and biogas. Katsaros et al. [134] studied the combustion behaviour of poultry litter in a batch-scale fixed bed reactor. The authors proposed that the utilisation of poultry litter as farm fuel can offset fossil fuel consumption. However, poultry litter combustion resulted in higher aerosols emissions (2806 mg/ $Nm^3_{dry\ flue\ gas}$ ). Theegala and Midgett [135] studied lab-scale HTL with carbon monoxide process gas and  $Na_2CO_3$  catalyst of dairy manure as a means to produce transportable bio-oil. Energy conversion efficiency was up to 67.8%, lowering process oxygen demand to around 62%. HTL was indicated as a viable alternative to current methods of processing and encouraged research into continuous-flow systems. Similarly, Islam and Park [136] also experimented HTL processes. The authors examined the effect of operating parameters on bio-oil yield and concluded that HTL of biomass, particularly swine manure could be an advantageous method of converting livestock manure. Further, the authors also implied a need for more study into the continuous hydrothermal liquefaction process.

## Modelling and Optimisation of Thermochemical Conversion Technologies

The commercialised viability of biomass thermochemical conversion processes depend on design optimisation. The ability to model thermochemical processes enables an understanding of the reaction phenomena to be achieved and aids the ability to predict the conversion system's behaviour by more economical and efficient means than laboratory scale trials, making modelling a crucial stage in the course towards optimisation. However, the prosperity of modelling is highly dependent on how closely the system mirrors the mathematical model, with the complexity and sensitivity to



various physiochemical properties making modelling, and thus optimisation of thermochemical processes, challenging [137]. Therefore, over the recent years, increasing effort has been made to develop more efficient and accurate modelling and optimisation approaches for thermochemical conversion processes, such as those displayed in Fig. 8.

Modelling approaches can be generally classified as either statistical models that utilise empirical formulas curated from experimental data or computational models, which use a series of complex numerical formulas to simulate the real-life system. Statistical models developed for the thermochemical conversion of various biomass include techniques such as regression analysis and artificial neural network, while computational models can be observed in literature to utilise techniques such as computational fluid dynamics [137]. These models employ various assumptions, including particle size and reactor models. Thermodynamic modelling can be conducted utilising either a stoichiometric or non-stoichiometric approach. With the former, a set of chemical equations defining the thermochemical conversion system are used to calculate the chemical equilibrium, predicting the composition of the equilibrium product. In comparison, the latter approach obtains the equilibrium composition of the system through the minimisation of Gibbs free energy, which can be employed to verify equilibrium attainment from experimental results.

Yakaboylu et al. [138, 139, 140, 141, 142, 143] studied various approaches to model SCWG, developing a mixture of unconstrained and constrained thermodynamic equilibrium models to investigate gas product behaviour in tandem and variation of elements with operating conditions for a range of feedstocks, including cattle manure. From the studies, it is established that constrained equilibrium modelling improved the model accuracy. This is further supported by Moghaddam et al. [144], who developed multiphase-thermodynamic equilibrium models based on Gibbs free energy minimisation for SCWG of feedstocks, including cattle

manure, that accounted for carbon gas efficiency, producing constrained and thermal-quasi equilibrium models. In contrast, Balu and Chung [145] employed a non-stoichiometric thermodynamic equilibrium approach for horse manure gasification in a trailer-scale downdraft gasifier utilising the software MAPLE. The model enabled the prediction of the system’s thermodynamic efficiency, which were in good agreement with experimental data and other gasification studies. Further successful use of global thermodynamic equilibrium models can also be seen in the studies, including that by Yanagida et al. [146] to study the seven inorganic elements (N, K, S, P, Cl, Ca and Si) in layer poultry manure during SCWG with the results of the calculations agreeing with experimental data.

As thermochemical processes involve complicated mechanisms with the formation of a wide range of intermediates and products, the development of models accounting for all mechanisms is difficult. As a result, many thermochemical conversion kinetic models can be categorised as lumped models, where the biomass feedstock and products are generalised as either char, gas or tar. Outside of the lumped category, other, more complex distributed kinetic models exist such as the Discrete Activation Energy Model (DAEM), Network (or Structural) Models and Mechanist Models. Yuan et al. [147] utilised the popular isoconversional approaches: Friedman, Flynn–Wall–Ozawa (FWO) model, Starink and Kissinger–Akahira–Sunose (KAS) model to investigate the pyrolysis mechanism of cattle manure, determining that the process occurs through a multi-stage reaction which can be separated into three stages based on conversion degree. Using the Discrete Activation Energy Model, Cao et al. [148] demonstrated that 27 dominating reactions can characterise the pyrolysis of cattle manure. The study by Yuan et al. [147] showed that the activation energy curves presented results comparable to the literature. However, the results of the Friedman model were consistently higher. It was concluded that the Friedman model was more accurate

**Fig. 8** Modelling and optimisation approaches for thermochemical conversion processes

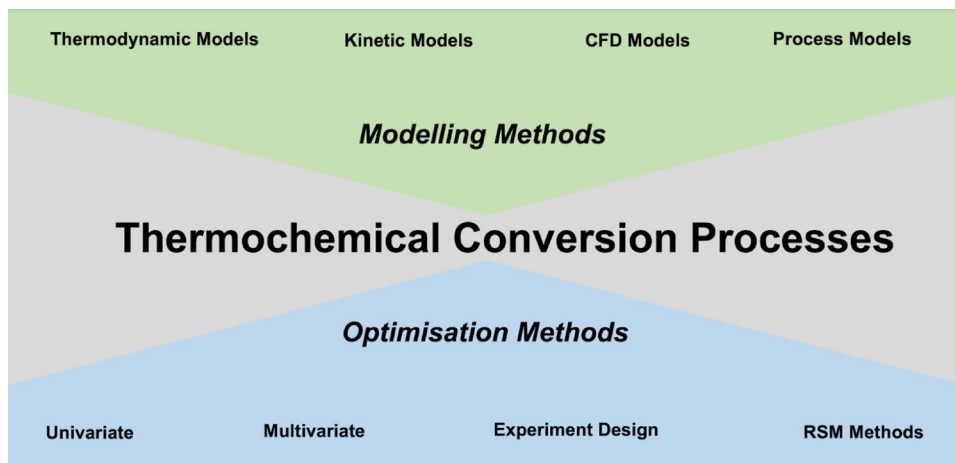

at predicting cattle manure activation energy due to the reduced assumptions and approximations the model employs in comparison to FWO model utilising Doyle's approximation for the temperature integral. The study produced a mean activation energy of approximately 194 kJ/mol, agreeing closely with Akyurek [149], which predicted 194.62 kJ/mol utilising the FWO method and that of Chong et al. [150]. Chong et al. [150] estimated the activation energy of horse manure pyrolysis to be 199.3 kJ/mol and 194.6 kJ/mol using the FWO and Friedman method, respectively.

Computational fluid dynamics (CFD) applies a combination of fluid mechanic principles, algorithms and numerical equations, including energy and momentum conservation over specified domains to solve fluid transport problems. This approach to modelling provides a means of estimating parameters such as heat duty and process economics while aiding optimisation through features such as enabling pinch point analysis conduction. ASPEN plus was utilised by Poddar and Babu [151] to simulate goat-swine manure mixture pyrolysis. The study details that pyro-char formation reduced with pyrolytic temperature across the range 470–1170 K. The inverse is true for pyro-oil and pyro-gas formation, observations mirrored by experimental results of Zeng et al. [62]. Poddar and Babu [151] established that a flowrate of 2 tonne/day at 800 K is required to optimise pyro-oil and pyro-gas production while minimising that of pyro-char.

Simbolon [152] employed ASPEN Plus to simulate chicken litter pyrolysis simulation at temperatures of 500 °C to achieve a high bio-oil yield to identify the maximum electrical energy that the system could generate. The simulation revealed that the combustion heat of 100% of the gas yield and 35% of the char yield would suffice to heat the process. The system was shown to have the ability to produce an electrical output of 150 kW with an overall conversion efficiency of 6.5%. Model development and simulation using Aspen Plus for a poultry litter gasifier is shown in Fig. 9 [153]. Caro and Dahl [154] studied the processing of horse

manure through pyrolysis, analysing the physical and chemical properties of the produced biochar, concluding that the major impacts on factors including biochar yield and composition was the highest heating temperature. It was further supposed that residence time and the heating rate displayed no noticeable trend for the parameters studied. Mong et al. [155] conducted a multivariant optimisation study of microwave pyrolysis as a method of valorisation of horse manure, with optimised yields of biogas and biochar given as 39.2 wt% and 32.5 wt%, respectively. The study established that a 38.7% increase in biochar energy density could be achieved by employing microwave pyrolysis. Zhu et al. [156] used factorial design and response surface methodology to investigate the optimisation process of poultry manure combustion. The study established that the parameters of moisture content, excess air, and secondary air injection height were significant at a critical level for carbon combustion efficiency.

Guo et al. [157] determined that 38.05% of total energy loss in SCWG of pig manure occurs within the recuperation process. The study also found that reconfiguration of the layout of the system's heat exchangers and critical streams could increase energy efficiency by 23%. Further more, rising feedstock concentration, preheating temperatures and turbine parameters while simultaneously lowering the water-slurry ratio also enabled an increase in system efficiency. Moghaddam et al. [144] determined that a comparison between experimental and theoretical data for the SCWG of cattle manure showed that a clear improvement in the accuracy of the global thermodynamic equilibrium model was observed using the perception of approach temperature. Furthermore, the study showed that increasing the number of constraints also improved model predictability, however, at the expense of the reliance on additional data points. Wu [158] investigated the gasification of feedlot manure to analyse syngas composition and optimise energy efficiency. Wu [158] established that increasing temperature increased the

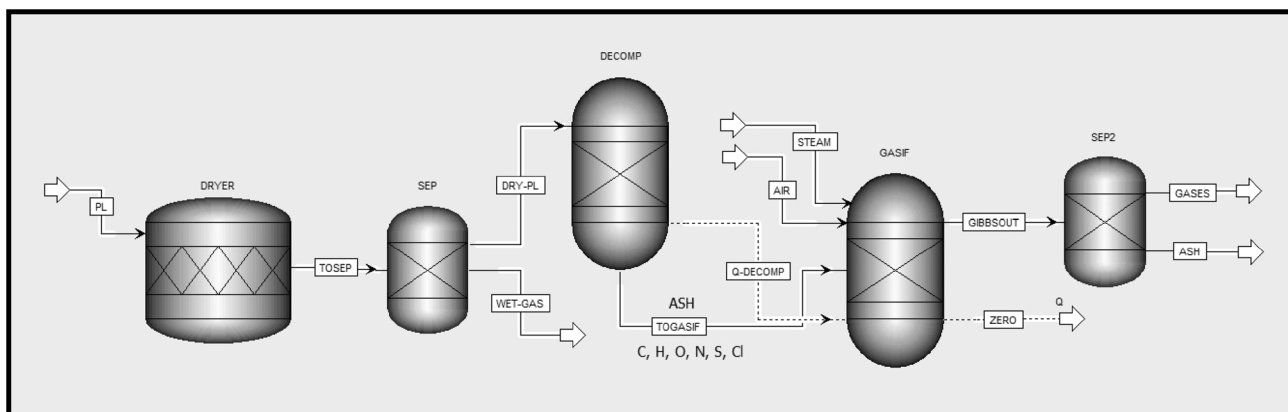

Fig. 9 Pseudo-Equilibrium based model development and simulation using Aspen Plus [153]

CO and H<sub>2</sub> concentration within the product gas, while the inverse was observed for CH<sub>4</sub> from 750 to 850 °C. Increasing the steam to biomass ratio (SBR) increased H<sub>2</sub> generation until the formation maximum SBR of 0.8 was reached. It was also found increasing the equivalence ratio promoted the conversion of CO to CO<sub>2</sub>, reducing the final CO concentration. A ridge max analysis found that the optimum energy efficiency was 40%, achieved at a temperature of 729 °C with an equivalence ratio of 0.2 and SBR of 0.5.

## Utilisation of Fly Ash from Gasifier

The disposal methods of by-product from poultry litter gasification could be used as a soil amender/fertiliser on the arable croplands. The use of treated ash from the thermal process of poultry litter must comply with the EU Waste Framework Directive (2008/98/EC) and acceptable upper limit set by poultry litter ash protocol relating to fertiliser. Moreover, studies indicated that phosphorous present in ashes from the gasification process is poorly soluble at soil conditions and contains heavy metal and soluble compounds, potentially hazardous to the food chain [159, 160, 161, 162]. Nevertheless, it was suggested that fly ashes should be subjected to further treatments (physical, chemical or thermal) before being used [163].

Although, fly ash showed that it has the potential to be used as a soil improver for agriculture and forestry. Nevertheless, it was categorically stressed that the suitability of specific fly ash should be carefully assessed before it can be classified as a soil amendment because it depends on feedstock and process conditions [164, 165, 166]. The plant (ryegrass *L. multiflorum Lam.*) uptake efficiency of trace elements from ashes produced during gasification process (fluidised bed, fixed bed and entrained flow) have been investigated with and without lime and fertiliser amendments. The study revealed that ashes from the gasification process retained a significant amount of phytotoxic heavy metals. After the fly ash was used as a soil amendment, a higher concentration of phytotoxic materials was reported in the plant material harvested from un-fertilised and un-limed soil. This also triggered to a greater risk to the food chain because it is toxic to animals under continuous long-term grazing conditions [167]. The growth of alfalfa and Swiss chard was tested in fly and bottom ash-amended soils originating from the municipal solid waste incinerator. The result showed that it could provide essential nutrients for plant growth, but high heavy metal and soluble salt content can cause problems for sensitive plants and the environment [168]. The disposal and recycling methods of fly ashes have been critically reviewed, and it was recommended that it could be utilised in the construction and ceramic industry, zeolite synthesis, adsorbent

for removal of pollutants, catalysis or metal extraction [169, 170, 171].

The reaction pathways of heavy metals in sewage sludge gasification have been investigated and due to the reducing environment in the gasifier, the temperature promotes the volatilisation of heavy metals [172]. The retention rate of heavy metals in the biochar produced during air gasification was higher compared to steam or air–steam gasification, probably due to thermally stable heavy metal oxides formation in an air atmosphere [173]. The gasification temperature showed that the percentage of heavy metal bound in biochar increased with temperature, resulting in higher environmental risks [174]. Elemental partitioning of the solid residue resulting from sewage sludge pyrolysis, gasification, and combustion processes has been studied in fluidised and packed bed reactor as a function temperature, residence time and Cl addition. The authors have concluded that the temperature and oxidising condition had a significant influence on the final concentration in the solid residue, whereas the effect of residence time was almost negligible [175]. Solubility of fly and bottom ash from the waste incinerator under various leaching conditions showed that alkali metals found in bottom ash were less soluble than fly ash [176]. A combined thermodynamic and kinetic approach was exploited to understand the interaction mechanism of heavy metals from municipal solid waste fly ash during chloride volatilisation. The authors have concluded that the findings could help design an efficient process to recover heavy metals from fly ash and its utilisation raw material for cement production [177].

In the recent past, poultry litter has been subjected to different thermochemical conversion processes in a quest for bioenergy production. Lately, the attention also shifted towards the nutrient recovery from fly and bottom ash generated during the gasification of animal waste leading to sustainable agriculture. Characterisation of fly ashes recovered from poultry litter gasification had exceeded the permitted limit of trace elements (Cd, Hg, Co, Cr, Cu, Hg, Mo, Ni, Pb and Se), restricting its use as an agriculture fertiliser and was suggested to be used as a supplementary fuel [178]. Chastain et al. [179] proposed that broiler litter ash should not be used as a liming agent. Moreover, small applications of broiler litter ash (2 tonnes/hectare or less) can provide sufficient micronutrients to the plants. A recent study identified poultry litter co-products (ash and biochar) as a feasible fertiliser. However, it was recommended that poultry litter co-products analysis be conducted for nutrient content (manure-to-energy nutrient mass balance) before it can be applied to the cropland [180]. Even though poultry litter contains higher phosphorus and can be categorised as a fertiliser [181, 182], research has mainly been focused on the characterisation of ashes derived wood, municipal solid waste and sewage sludge [183]. Moreover, studies focused

on characterising manure-based fly ash and bottom ash are scantily reported.

The latest research by Pandey et al. [184] investigated the effect of operating conditions on the gasification process (poultry litter alone and when blended with limestone) along with the transformation of inorganic matter and the final composition of the fly ash. The authors have also provided a detailed analysis of the by-product (ash) from fluidised bed gasification (Table 7) if that can potentially be classified into component material categories for effective recycling as fertilising products in line with the EU-STRUBIAS report [185]. The study concluded that although the solid by-products originated from poultry litter gasification do not meet the quality criteria to be categorised as component materials for EU fertiliser products. Moreover, it suggested that the blend of bed and fly ash could pave the way for their utilisation as a fertiliser but cautioned that this requires further investigation.

## Rector Technologies Involved in Thermochemical Conversion Processes

Two main types of gasifiers are primarily used in the gasification of biomass: the fluidised bed gasifier and the fixed bed gasifier. Fluidised bed reactors are suitable for large

scale plants, possessing advantages such as uniform mixing and heat transfer and enabling higher biomass conversion. Fluidised bed reactors are further divided into two categories: bubbling fluidised bed and circulating fluidised bed. Bubbling fluidised bed reactors can operate on a scale of up to a 25 MW<sub>th</sub> at approximately 800 °C, with a product gas containing moderate tar levels and high in particulates [186]. Circulating fluidised bed reactors can operate up to 100 MW<sub>th</sub> at temperatures of 850 °C, with a product gas also high in particulates but lower in tar. Fixed bed reactors operate on a smaller scale, with a downdraft fixed bed approximately 5 kW<sub>th</sub> to 2 MW<sub>th</sub> producing low tar and moderate particulates at 800 °C, while an updraft fixed bed can operate at > 10MW<sub>th</sub> producing very high tar but low particulates at a reaction temperature of 1000 °C [186]. Bubbling and circulating fluidised bed reactors are also commercial reactor technologies used for pyrolysis, providing a wide and shallow contact area between the solid and fluid, and presenting high reaction rates and heat transfer [187]. In addition, vacuum pyrolysis and ablative pyrolysis reactor technologies are also used in commercial pyrolysis [188]. However, vacuum pyrolysis offer longer residence times and lower heat transfer rates. They typically require high investment costs, while ablative pyrolysis have higher heat transfer and heating rates across a small contact area. In contrast, the absence of need for heating/cooling of the fluidised

**Table 7** Chemical composition of ash forming elements (cyclone ash samples) [184]

Elements	Fly ash ER = 0.22, 700 °C	Fly ash ER = 0.30, 700 °C	Fly ash ER = 0.29, 700 °C	Fly ash ER = 0.23, 750 °C	Fly ash ER = 0.28, 750 °C	Fly ash ER = 0.33, 750 °C	Fly ash ER = 0.30, 800 °C
	Poultry litter		Poultry litter with limestone				
mg/kg dry basis							
Si	72,528	71,003	63,452	67,146	64,948	62,891	62,049
Ca	110,362	108,036	104,943	111,053	107,357	104,033	102,608
K	101,898	102,032	91,527	84,948	99,342	98,674	95,620
Mg	56,845	57,204	60,274	59,117	61,921	61,918	65,425
Na	42,256	47,243	45,993	39,443	42,913	44,246	39,704
P	88,275	77,477	76,033	81,044	93,502	86,959	94,465
Fe	6888	7016	7173	7168	7079	7575	8444
Ti	531	478	505	535	517	501	494
Al	9816	9609	9334	9877	9554	13,115	9127
Cu	1673	1767	1580	1813	1416	1459	1430
Mn	2352	2362	2215	2490	2563	2368	2652
Zn	112	116	76	61	67	69	60
Cd	31	32	29	31	31	25	30
Cr	411	311	296	372	205	222	245
Mo	113	124	214	10	267	242	225
Ni	225	153	175	224	141	181	500
Pb	529	670	732	884	526	458	667
Se	1738	1700	2752	1766	1960	2248	2564

gases subsequently leads to higher energy and cost efficiency [187]. Verma et al. [189] identify fluidised bed reactors to be the simplest configuration to scale up, while the vacuum and ablative fluid pyrolysis are the most difficult ones. Nonetheless, biomass variability is higher for ablative pyrolysis in comparison to fluidised bed reactors [189]. Most literature detailing SCWG reactor technologies focuses largely on small lab scale experiments, typically with the aim of investigating the chemical and physical fundamentals of the process. Based on large-scale potential, tubular reactors, fluidised bed reactors and multiple reactors in series are often proposed [190]. Susanti et al. [191] presented a concept for a large-scale tubular reactor divided into zones to provide the optimal conditions for mixing and cooling etc. Kruse and Faquir [192] proposed using a CSTR followed by a tubular reactor to suppress coke and tar formation and increase gas yield through exalting back mixing. An alternative to tubular reactors is a fixed bed reactor, proposed in studies such as Lu et al. [193], which can process biomass efficiently while avoiding plugging or clogging issues associated with tubular reactors. However, the development of SCWG reactor technologies is in a considerably more infant stage than gasification or pyrolysis.

### Comparative Study of Pyrolysis/Gasification/SCWG

Due to the endothermic nature of pyrolysis and SCWG, high energy consumption is inevitable compared to the gasification process, in addition to the energy consumption associated with maintaining water at critical conditions within SCWG. Although catalysts have been developed to increase hydrogen production while reducing operating temperatures for SCWG, chief obstacles in their use include severe catalyst deactivation, corrosive nature, and plugging issues. Furthermore, another prominent drawback to SCWG is limitations to the dry biomass content within the liquid suspension, as required to maintain a pumpable feedstock [194]. The VERENA pilot plant, the largest SCWG facility, is limited to a maximum solid content of 20 wt%, processing 100 kg/h at 700 °C and 35 MPa [195].

Gasification also allows a higher conversion and energy recovery ratio than pyrolysis. In a study investigating the gasification and pyrolysis of chicken manure by Burra et al. [196], the authors showed that gasification produced more energy than pyrolysis and that considerably high temperature would have to be employed during pyrolysis for the process to match gasification energy yields. Furthermore, the control of the pyrolysis process is more complex than gasification, with the yield and dispersion of the multiple products severely affected by operating conditions and the presence of secondary reactions. In

addition to its higher efficiency and lower cost, gasification can accommodate a wider range of feedstocks than the other thermochemical routes, although generating a smaller range of products [197]. Although the liquid fuel produced through pyrolysis is more energy dense than the syngas produced through gasification, and subsequently, conventional transportation costs would be expected to be reduced, bio-oils corrosive nature results in heightened transportation and storage costs [186].

### Life Cycle Assessment (LCA) Studies of Thermochemical Technologies

This section is focused on assessing the environmental impact of pyrolysis, gasification and SCWG processes. The difference in input material/energy, objective and system boundaries in different thermochemical treatment technologies made the results of LCA significantly different. To quantify the uncertainties, it is highly recommended to conduct a sensitivity analysis. Previous LCA studies on thermochemical technologies are mostly concentrated on lignocellulosic waste and rarely focused on animal manure. Fernandez-Lopez et al. [198] reported pyrolysis of three different manure samples. A positive environmental impact was noticed for all studied samples. In the study of Mong et al. [155], LCA of microwave pyrolysis of horse manure was conducted. The environmental impact of microwave pyrolysis is more beneficial in comparison to conventional pyrolysis, composting and incineration. From the environmental protection point of view, there has been positive evidence in favour of gasification in comparison to pyrolysis or SCWG for a wide range of feedstocks (Fig. 10). The number of LCA studies was highest for gasification (15) followed by pyrolysis (7) and SCWG (5). Among the three focused techniques, the highest negative environmental impact of  $-0.62$  was noticed for gasification (a negative number indicates an environmentally friendly process). On the other hand, the SCWG process has the highest positive environmental impact. A comparative LCA study on the gasification of animal manure and land application was conducted by Wu et al. [199]. The authors confirmed that the gasification technology has a negative ( $-643$  kg CO<sub>2</sub>-eq per tonne dry manure) environmental impact and land application has a positive (119 kg CO<sub>2</sub>-eq per tonne dry manure) environmental impact. Similarly, Fernandez-Lopez et al. [200] found that the gasification of manures before anaerobic digestion is more environmental friendly compared to the gasification after the anaerobic digestion. In another work, Sharara et al. [201] evaluated the environmental impact of different stages (manure drying, syngas production, and

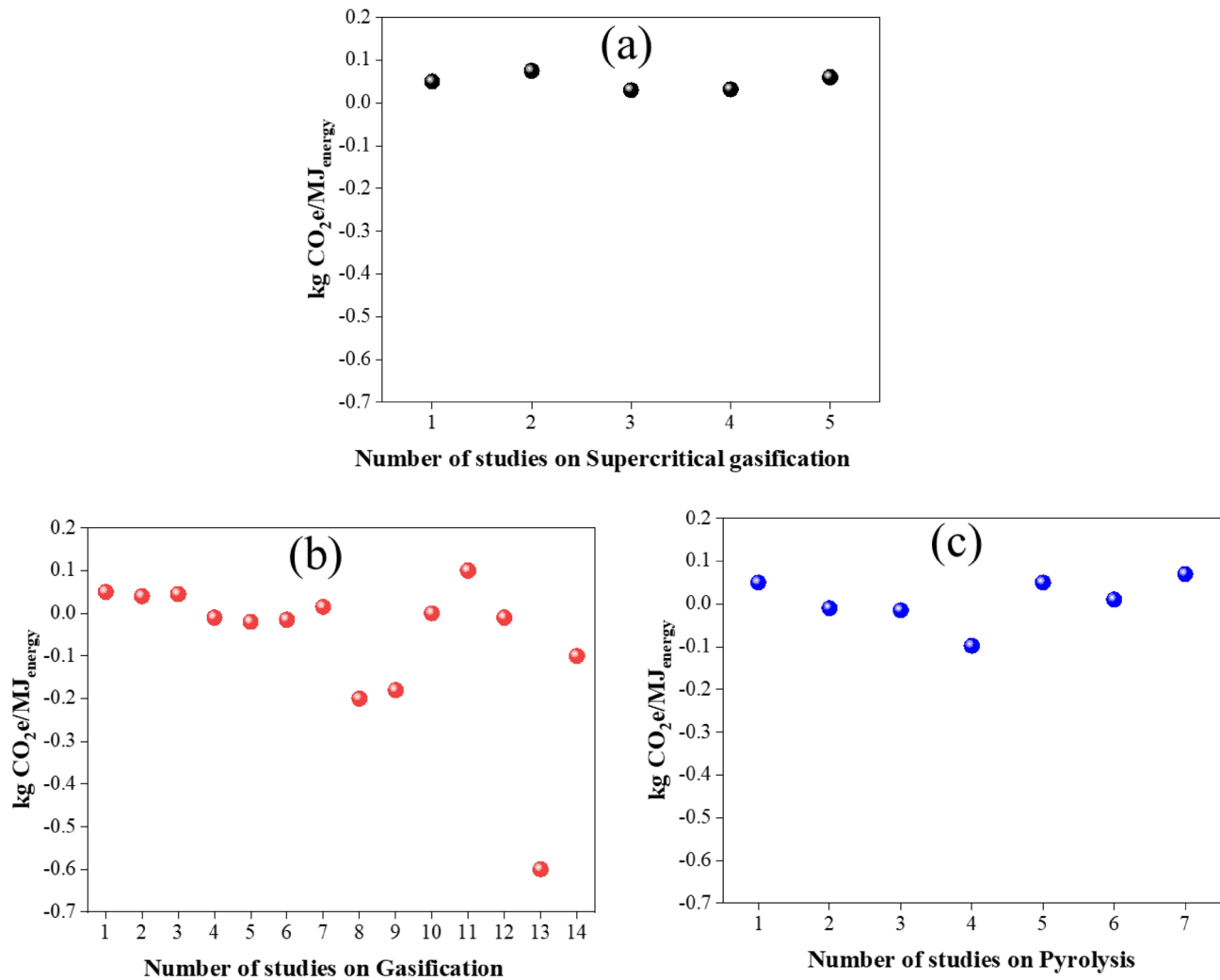

**Fig. 10** The comparative global warming potential (GWP) impact of the LCA studies on **a** Supercritical gasification process, **b** gasification and pyrolysis, (c). Modified from previous study [209]

biochar field application) during the gasification. Among the studied stages, the highest environmental impact was noticed for manure drying, followed by biochar field application and syngas production. Therefore, to reduce manure's environmental impact, focus should be given to manure drying management techniques.

### Challenges and Future Perspectives of Thermochemical Conversion Technologies

The world is facing a huge impact on the climate change due to fossil fuel burning and consequent emissions of CO<sub>2</sub>. It is, therefore, presently focusing on achieving the net zero ambitions, which could result in keeping global temperatures under control, an aspiring target of COP26. Net zero indicates greenhouse gases (GHG) released into the atmosphere

can be offset by sequestration of these gases, thus halting global warming. Due to intensive livestock farming, primarily driven by the demand for animal protein, the processing of accumulated livestock manure is also posing a significant environmental threat and causing GHG emissions. For example, the poultry industry alone generates 140 k to 456 k tonnes of manure in the UK every year with a total energy potential of 12 to 65 PJ [110]. Manure management, production of future fuels/green fuels like hydrogen, ammonia, methanol, green hydrocarbons, etc., is integral to the circular economy and net zero ambitions [202]. The emphasis is on the optimal and prudent uses of resources and averting waste. Mechanical separation and biological treatment, especially anaerobic digestion (AD), are two common manure management practices. The biogas generated from AD is an attractive energy product [203, 204]. However, AD of manures is full of restrictions due to the high protein

present in the waste. The constraints such as high digester pH, low C/N ratio, increased ammonia concentration makes the AD inefficient. It usually suffers from ammonia inhibition, terminating/reducing methane generation [205, 206]. Lignocellulosic biomass is generally added to the manure to increase the carbon content causing the high cost of the process. Other supplementations, such as bentonite addition, Fe<sup>2+</sup> addition, water extraction, etc., have their limitations. Additionally, AD processes are more efficient at thermophilic conditions (> 45 °C), as it increases biochemical reaction rates, organic compounds solubility and pathogen deactivation. Creating thermophilic conditions could be quite energy intensive, particularly in cold climates.

The heavy energy consumption and the resultant emission in the present society demand a belligerent attitude to renewable energy. The scarcity of non-renewable fuel sources has stressed the energy supply for industrial and domestic needs [202]. Various thermochemical conversion technologies discussed above can generate bio-oils, syngas, H<sub>2</sub>, heat, power, etc., and can potentially reduce our dependence on non-renewable fuel sources. It can also produce biochar/hydrochar as carbon-free fertiliser. It can eliminate odours, deactivates pathogens and reduces waste stream volume. However, despite all the research reports, the process is not economically appealing, specifically for large investments. The Technology Readiness Level (TRL) remains a crucial factor. Although well-studied and established, pyrolysis is suited for mostly small-scale plants with feed rates close to 10,000 tonnes per annum (TPA) [207].

On the contrary, many pilot plants are listed for gasification technologies [207]. It is being touted as a feasible future technology for generating low-carbon hydrogen and other green fuels in the UK and many developed countries. The gasification technology/process, however, requires pre-treatment of the feedstock to satisfy the technical provisions of the gasification process. Enerkem, Canada, has developed a matured technology (TRL 8) to manage 100,000 TPA of dry waste, simultaneously producing 38 million litres of ethanol per annum. GoBiGas, Sweden, has also demonstrated a mature technology to produce methane using biomass gasification. Other technologies (Kew Technology, Sumitomo Foster Wheeler, etc.) are detailed in BEIS Advanced Gasification Technology report [207]. In comparison to pyrolysis and gasification, the SCWG process is at a much more infant stage due to the requirement of high temperature and pressure. To date, there is no commercial installation. Other thermochemical conversion technologies like HTC and HTL etc. are also not marketed for large-scale installations.

Based on an extensive review, the following recommendations are proposed for sustainably managing waste generated from ever-growing livestock sector by utilising innovative thermochemical conversion technologies:

- a. The commercialised feasibility of thermochemical conversion technologies crucially depends on design optimisation. Increasing efforts should be made to grow modelling and optimisation attempts for thermochemical conversion technologies. The academic, industrial and research community should work collectively and validate the statistical and computational models, and paving the path for commercialisation.
- b. Co-digestion of manure with other waste biomass should be significantly explored, as it can provide high-quality biofuels and syngas.
- c. Reactors are crucial in establishing manure valorisation using thermochemical technologies as a feasible technology. The product quality is strongly affected by reactor design and operation parameters. The reactors should have technological strength and market competitiveness.
- d. A comprehensive cost comparison of a large integrated plant with regard to small-scale cooperative and private plants, mainly facilitated by public funding, should be encouraged.
- e. The application of bio-oil or syngas in the local framework, such as cooking gas grid connection, or production of other bioproducts, should be deeply explored.
- f. A study on biochar as a fertiliser for the regional soil types should be encouraged.
- g. Inappropriate disposal of gasification ashes could potentially degrade the soil quality and the leachate can pollute the groundwater. Therefore, characterisation and detailed understanding of the by-product of the gasification process is imperative.
- h. Exhaustive life cycle analysis of the process, contemplating the drivers of ecosystem services should be studied.

## Conclusions

Manure management is expected to pose a massive challenge that modern society will realise in the near foreseeable future. Furthermore, the energy sector will be governed in the future by the net zero requirements such as carbon-neutral and renewable green fuels/biofuels, which are considerably more viable than the existing reliance on fossil fuels. Green fuels can be produced using novel technologies from various wastes generated in society. This paper attempted an intensive literature review on manure management and mainly focused on thermochemical conversion technologies intending to produce bio-oil, syngas and biochar. The review primarily focused on pyrolysis, gasification and the SCWG processes. The critical view of the literature reveals that pyrolysis is one of the most studied thermochemical technologies and has many advantages over conventional manure management methods. However, it is not found to be suited for high throughputs, though various commercial

installations exist for small-scale plants. Gasification produces syngas and is considered to be a contender for large-scale manure management. While there are no industrial-scale plants yet, the considerably high efficiency of the gasification process can make this technology techno-economically feasible for high throughput manure, provided the tar content in the syngas is within the allowable limit. The review of LCA studies also confirmed that gasification is the most appropriate technology for the scale-up. The SCWG process is an emerging thermochemical technology and has huge potential to grow into a major technology for manure valorisation, especially for H<sub>2</sub> production. However, further research and development are required to make the process techno-economically viable.

The review also briefly explored other thermochemical conversion technologies such as HTC and HTL. The study also found growing attempts to develop modelling and optimisation approaches for thermochemical conversion processes. Reactor technologies involved in thermochemical conversion processes are also briefly reviewed. Lastly, a few recommendations are provided in the preceding section based on the literature survey in the circular economy context, with an overarching aim of achieving net zero. The authors believe that the outcomes of this review would stimulate the scientific, engineering and industrial community, and proper manure management using thermochemical conversion technologies could benefit the industrial clusters by making them self-sufficient in terms of energy usage and waste management. Applying these technologies could boost the avoidance of waste being landfilled and help many countries adopt the principles of the circular economy. The review will have long-term benefits for a broader range of researchers, particularly those considering low-carbon and low emissions energy sources. These technologies could usher society into a new era of the less carbon-intensive industry while utilising waste for decentralised energy systems.

**Acknowledgements** The authors are thankful to the Thapar Institute of Engineering and Technology (TIET) and Sheffield Hallam University for supporting this work.

**Funding** Not applicable.

**Data Availability** Not applicable.

## Declarations

**Conflict of interest** No conflict of interest had influenced either the conduct or the presentation of the research to the authors.

**Open Access** This article is licensed under a Creative Commons Attribution 4.0 International License, which permits use, sharing, adaptation, distribution and reproduction in any medium or format, as long as you give appropriate credit to the original author(s) and the source,

provide a link to the Creative Commons licence, and indicate if changes were made. The images or other third party material in this article are included in the article's Creative Commons licence, unless indicated otherwise in a credit line to the material. If material is not included in the article's Creative Commons licence and your intended use is not permitted by statutory regulation or exceeds the permitted use, you will need to obtain permission directly from the copyright holder. To view a copy of this licence, visit <http://creativecommons.org/licenses/by/4.0/>.

## References

- Herrero, M., Henderson, B., Havlík, P., Thornton, P.K., Conant, R.T., Smith, P., Stehfest, E.: Greenhouse gas mitigation potentials in the livestock sector. *Nat. Clim. Change* **6**(5), 452–461 (2016)
- Sans, P., Combris, P.: World meat consumption patterns : an overview of the last fifty years (1961–2011). *Meat Sci.* **109**, 106–111 (2015)
- Thornton, P.K.: Livestock production: recent trends, future prospects. *Philos. Trans. R. Soc. B* **365**(1554), 2853–2867 (2010)
- Dong, L., Cao, G., Guo, X., Liu, T., Wu, J., Ren, N.: Efficient biogas production from cattle manure in a plug flow reactor: a large scale long term study. *Bioresour. Technol.* **278**, 450–455 (2019)
- Fu, Q.-L., Liu, C., Achal, V., Wang, Y.-J., Zhou, D.-M.: Chapter one—Aromatic Arsenical Additives (AAAs) in the soil environment: detection, environmental behaviors, toxicities, and remediation. *Adv. Agron.* **140**, 1–41 (2016)
- Zhou, S., Liang, H., Han, L., Huang, G., Yang, Z.: The influence of manure feedstock, slow pyrolysis, and hydrothermal temperature on manure thermochemical and combustion properties. *Waste Manag.* **88**, 85–95 (2019)
- Königer, J., Lugato, E., Panagos, P., Kochupillai, M., Orgiazzi, A., Briones, M.: Manure management and soil biodiversity: towards more sustainable food systems in the EU. *Agric. Syst.* **194**, 103251 (2021)
- Kashif, A., Batool, A., Khan, A.A., Shahid, M.K.: The enzymatic treatment of animal wastewater and manure. In: *Urban Mining for Waste Management and Resource Recovery*, pp. 233–241. CRC Press (2021)
- Loyon, L.: Overview of animal manure management for beef, pig, and poultry farms in France. *Front. Sustain. Food Syst.* **2**, 36 (2018)
- Rout, P.R., Bhunia, P., Dash, R.R.: Assessing possible applications of waste organic solid substances as carbon sources and biofilm substrates for elimination of nitrate toxicity from wastewater. *J. Hazard. Toxic Radioactive Waste* **21**(3), 04016027 (2017)
- Rout, P.R., Dash, R.R., Bhunia, P., Lee, E., Bae, J.: Comparison between a single unit bioreactor and an integrated bioreactor for nutrient removal from domestic wastewater. *Sustain. Energy Technol. Assess.* **48**, 101620 (2021)
- Tadda, M.A., Altaf, R., Gouda, M., Rout, P.R., Shitu, A., Ye, Z., Liu, D.: Impact of Saddle-Chips biocarrier on treating mariculture wastewater by moving bed biofilm reactor (MBBR): mechanism and kinetic study. *J. Environ. Chem. Eng.* **9**(6), 106710 (2021)
- Lee, E., Rout, P.R., Bae, J.: The applicability of anaerobically treated domestic wastewater as a nutrient medium in hydroponic lettuce cultivation: nitrogen toxicity and health risk assessment. *Sci. Total Environ.* **780**, 146482 (2021)
- Natural Resources Conservation Service.: *Manure Chemistry—Nitrogen, Phosphorus, & Carbon (Manure Management Information Sheet Number 7)*. U.S. Department of Agriculture.



- (2007) [https://www.nrcs.usda.gov/Internet/FSE\\_DOCUMENTS/nrcs142p2\\_043440.pdf](https://www.nrcs.usda.gov/Internet/FSE_DOCUMENTS/nrcs142p2_043440.pdf)
15. Rout, P.R., Shahid, M.K., Dash, R.R., Bhunia, P., Liu, D., Varjani, S., Surampalli, R.Y.: Nutrient removal from domestic wastewater: a comprehensive review on conventional and advanced technologies. *J. Environ. Manag.* **296**, 113246 (2021)
  16. Shahid, M.K., Batool, A., Kashif, A., Nawaz, M.H., Aslam, M., Iqbal, N., Choi, Y.: Biofuels and biorefineries: development, application and future perspectives emphasizing the environmental and economic aspects. *J. Environ. Manag.* **297**, 113268 (2021)
  17. Gerber, P.J., Steinfeld, H., Henderson, B., Mottet, A., Opio, C., Dijkman, J., Tempio, G.: Tackling Climate Change Through Livestock: A Global Assessment of Emissions and Mitigation Opportunities. Food and Agriculture Organization of the United Nations (FAO), Rome (2013)
  18. Sridhar, P., Tyagi, R.D., Bhunia, P., Rout, P.R., Zhang, T.C., Surampalli, R.Y.: Greenhouse gas emissions in sludge ultrasonication followed by anaerobic digestion processes. *Bioreour. Technol.* **341**, 125754 (2021)
  19. Rout, P.R., Verma, A.K., Bhunia, P., Surampalli, R.Y., Zhang, T.C., Tyagi, R.D., Goyal, M.K.: Introduction to sustainability and sustainable development. *Sustainability* 1–19 (2020)
  20. Steinfeld, H., Gerber, P., Wassenaar, T.D., Castel, V., Rosales, M., Rosales, M., de Haan, C.: Livestock's Long Shadow: Environmental Issues and Options. Food & Agriculture Org, Rome (2006)
  21. Sudarsan, J.S., Deeptha, V.T., Maurya, D., Goel, M., Kumar, K.R., Das, A.: Study on treatment of electroplating wastewater using constructed wetland. *Nat. Environ. Pollut. Technol.* **14**(1), 95 (2015)
  22. Ström, G., Albiñ, A., Jinnerot, T., Boqvist, S., Andersson-Djurfeldt, A., Sokerya, S., Magnusson, U.: Manure management and public health: sanitary and socio-economic aspects among urban livestock-keepers in Cambodia. *Sci. Total Environ.* **621**, 193–200 (2018)
  23. Manyi-Loh, C.E., Mamphweli, S.N., Meyer, E.L., Makaka, G., Simon, M., Okoh, A.I.: An overview of the control of bacterial pathogens in cattle manure. *Int. J. Environ. Res. Public Health* **13**(9), 843 (2016)
  24. Kumar, R., Park, B., Cho, J.: Application and environmental risks of livestock manure. *J. Korean Soc. Appl. Biol. Chem.* **56**, 497–503 (2013)
  25. Priyadarshini, A., Sahoo, M.M., Raut, P.R., Mahanty, B., Sahoo, N.K.: Kinetic modelling and process engineering of phenolics microbial and enzymatic biodegradation: a current outlook and challenges. *J. Water Process Eng.* **44**, 102421 (2021)
  26. Rout, P.R., Zhang, T.C., Bhunia, P., Surampalli, R.Y.: Treatment technologies for emerging contaminants in wastewater treatment plants: a review. *Sci. Total Environ.* **753**, 141990 (2021)
  27. Carpenter, S.R.: Eutrophication of aquatic ecosystems: bistability and soil phosphorus. *Proc. Natl. Acad. Sci.* **102**(29), 10002–10005 (2005)
  28. Smith, P., Haberl, H., Popp, A., Erb, K.H., Lauk, C., Harper, R., Rose, S.: How much land-based greenhouse gas mitigation can be achieved without compromising food security and environmental goals? *Glob. Change Biol.* **19**(8), 2285–2302 (2013)
  29. Fang, J., Liu, Z., Luan, H., Liu, F., Yuan, X., Long, S., Wang, A., Ma, Y., Xiao, Z.: Thermochemical liquefaction of cattle manure using ethanol as solvent: effects of temperature on bio-oil yields and chemical compositions. *Renew. Energy* **167**, 32–41 (2021)
  30. Szulc, W., Rutkowska, B., Gawroński, S., Wszelaczyńska, E.: Possibilities of using organic waste after biological and physical processing—an overview. *Processes* **9**(9), 1501 (2021)
  31. Oshita, K., Sun, X., Taniguchi, M., Takaoka, M., Matsukawa, K., Fujiwara, T.: Emission of greenhouse gases from controlled incineration of cattle manure. *Environ. Technol.* **33**(13), 1539–1544 (2012)
  32. Leno, N., Sudharmaidevi, C., Byju, G., Thampatti, K., Krishnaprasad, P., Jacob, G., Gopinath, P.: Thermochemical digestate fertilizer from solid waste: characterization, labile carbon dynamics, dehydrogenase activity, water holding capacity and biomass allocation in banana. *Waste Manag.* **123**, 1–14 (2021)
  33. Jung, S., Kim, J.-H., Lee, D.-J., Lin, K.-Y., Tsang, Y., Yoon, M.-H., Kwon, E.: Virtuous utilization of biochar and carbon dioxide in the thermochemical process of dairy cattle manure. *Chem. Eng. J.* **416**, 129110 (2021)
  34. Adekunle, K., Okolie, J.: A review of biochemical process of anaerobic digestion. *Adv. Biosci. Biotechnol.* **6**, 205–212 (2015)
  35. Liang, Y.: A critical review of challenges faced by converting food waste to bioenergy through anaerobic digestion and hydrothermal liquefaction. *Waste Biomass Valoriz.* 1–16 (2021)
  36. Naidu, L.D., Saravanan, S., Goel, M., Periasamy, S., Stroeve, P.: A novel technique for detoxification of phenol from wastewater: nanoparticle assisted nano filtration (NANF). *J. Environ. Health Sci. Eng.* **14**(1), 1–12 (2016)
  37. Lee, D.J., Jung, S., Jang, Y., Jo, G., Park, S.H., Jeon, Y.J., Kwon, E.E.: Offering a new option to valorize hen manure by CO<sub>2</sub>-assisted catalytic pyrolysis over biochar and metal catalysts. *J. Carbondioxide Util.* **42**, 101344 (2020)
  38. Mohanty, A., Mankoti, M., Rout, P.R., Meena, S.S., Dewan, S., Kalia, B., Banu, J.R.: Sustainable utilization of food waste for bioenergy production: a step towards circular bioeconomy. *Int. J. Food Microbiol.* **365**, 109538 (2022)
  39. Ro, K.S., Cantrell, K., Elliott, D., Hunt, P.G.: Catalytic wet gasification of municipal and animal wastes. *Ind. Eng. Chem. Res.* **46**(26), 8839–8845 (2007)
  40. Sharma, A., Pareek, V., Zhang, D.: Biomass pyrolysis—a review of modelling, process parameters and catalytic studies. *Renew. Sustain. Energy Rev.* **50**, 1081–1096 (2015)
  41. He, B., Zhang, Y., Funk, T., Riskowski, G., Yin, Y.: Thermochemical conversion of swine manure: an alternative process for waste treatment and renewable energy production. *Am. Soc. Agric. Eng.* **43**(6), 1827–1833 (2000)
  42. MacDermid-Watts, K., Pradhan, R., Dutta, A.: Catalytic hydrothermal carbonization treatment of biomass for enhanced activated carbon: a review. *Waste Biomass Valoriz.* **12**(5), 2171–2186 (2021)
  43. Gebreegzabher, T., Oyedun, A., Yu, Z., Maojian, W., Yi, Z., Jin, L., Hui, C.: Biomass drying for an integrated power plant: effective utilization of waste heat. *Comput. Aided Chem. Eng.* **33**, 1555–1560 (2014)
  44. Iyer, K.S., Balsora, H.K., Dixit, S.D., Sharma, A., Sonar, P., Doherty, W.O., Chakinala, A.G., Joshi, J.B.: Elucidation of thermal degradation model for low and high density polyethylene by statistical parameters. *Chem. Select* **5**(44), 14153–14160 (2020)
  45. Hameed, S., Sharma, A., Pareek, V., Wu, H., Yu, Y.: A review on biomass pyrolysis models: kinetic, network and mechanistic models. *Biomass Bioenergy* **123**, 104–122 (2019)
  46. Kumar, G., Dharmaraja, J., Arvindnarayan, S., Shoban, S., Bakonyi, P., Saratale, G., Kim, S.-H.: A comprehensive review on thermochemical, biological, biochemical and hybrid conversion methods of bio-derived lignocellulosic molecules into renewable fuels. *Fuel* **251**, 352–367 (2019)
  47. Rout, P. R., Goel, M., Mohanty, A., Pandey, D. S., Halder, N., Mukherjee, S., Bhatia, S. K., Sahoo, N. K., Varjani, S.: Recent advancements in microalgal mediated valorisation of wastewater from hydrothermal liquefaction of biomass. *Bioenergy Res.* 1–16 (2022)

48. Goldfarb, J.L., Hubble, A.H., Ma, Q., Volpe, M., Severini, G., Andreottola, G., Fiori, L.: Valorization of cow manure via hydrothermal carbonization for phosphorus recovery and adsorbents for water treatment. *J. Environ. Manag.* **308**, 114561 (2022)
49. Lane, D., Truong, E., Larizza, F., Chiew, P., de Nys, R., van Eyk, P.: Effect of hydrothermal carbonization on the combustion and gasification behavior of agricultural residues and microalgae: devolatilization characteristics and char reactivity. *Energy Fuels* **32**, 4149–4159 (2018)
50. Ro, K., Libra, J., Bae, S., Berge, N., Flora, J., Pecenka, R.: Combustion behavior of animal-manure-based hydrochar and pyrochar. *ACS Sustain. Chem. Eng.* **7**, 470–478 (2019)
51. Kumar, A., Jones, D., Hanna, M.: Thermochemical biomass gasification: a review of the current status of the technology. *Energies* **2**, 556–581 (2009)
52. Babaei, K., Bozorg, A., Tavasoli, A.: Hydrogen-rich gas production through supercritical water gasification of chicken manure over activated carbon/ceria-based nickel catalysts. *J. Anal. Appl. Pyrol.* **159**, 105318 (2021)
53. Wu, Q., Wang, H., Zheng, X., Liu, F., Wang, A., Zou, D., Yuan, J., Xiao, Z.: Thermochemical liquefaction of pig manure: factors influencing on oil. *Fuel* **264**, 116884 (2020)
54. Yang, L., Si, B., Tan, X., Xu, J., Xu, W., Zhou, L., Zhou, X.: Valorization of livestock manure for bioenergy production: a perspective on the fates and conversion of antibiotics. *Resour. Conserv. Recycl.* **183**, 106352 (2022)
55. Li, S., Zou, D., Li, L., Wu, L., Liu, F., Zeng, X., Wang, H., Zhu, Y., Xiao, Z.: Evolution of heavy metals during thermal treatment of manure: a critical review and outlooks. *Chemosphere* **247**, 125962 (2020)
56. Manogaran, M.D., Shamsuddin, R., Yusoff, M.H.M., Lay, M., Siyal, A.A.: A review on treatment processes of chicken manure. *Clean. Circ. Bioecon.* **2**, 100013 (2022)
57. Kelleher, B.P., Leahy, J.J., Henihan, A.M., O'Dwyer, T.F., Sutton, D., Leahy, M.J.: Advances in poultry litter disposal technology—a review. *Bioresour. Technol.* **83**(1), 27–36 (2002)
58. Lu, J.S., Chang, Y., Poon, C.S., Lee, D.J.: Slow pyrolysis of municipal solid waste (MSW): a review. *Bioresour. Technol.* **312**, 123615 (2020)
59. Su, G., Ong, H.C., Mofijur, M., Mahlia, T.I., Ok, Y.S.: Pyrolysis of waste oils for the production of biofuels: a critical review. *J. Hazard. Mater.* **424**, 127396 (2022)
60. Su, G., Ong, H.C., Zulkifli, N.W.M., Ibrahim, S., Chen, W.H., Chong, C.T., Ok, Y.S.: Valorization of animal manure via pyrolysis for bioenergy: a review. *J. Clean. Prod.* 130965 (2022b)
61. Weir, A., del Barco Carrión, A.J., Queffélec, C., Bujoli, B., Chailleux, E., Uguna, C.N., Airey, G.: Renewable binders from waste biomass for road construction: a review on thermochemical conversion technologies and current developments. *Constr. Build. Mater.* **330**, 127076 (2022)
62. Zeng, X., Xiao, Z., Zhang, G., Wang, A., Li, Z., Liu, Y., Wang, H., Zeng, Q., Liang, Y., Zou, D.: Speciation and bioavailability of heavy metals in pyrolytic biochar of swine and goat manures. *J. Anal. Appl. Pyrol.* **132**, 82–93 (2018)
63. Rout, P. R., Dash, R. R., Bhunia, P., Rao, S.: Role of *Bacillus cereus* GS-5 strain on simultaneous nitrogen and phosphorous removal from domestic wastewater in an inventive single unit multi-layer packed bed bioreactor. *Bioresour. Technol.* **262**, 251–260 (2018)
64. Bernal, M.P., Albuquerque, J.A., Moral, R.: Composting of animal manures and chemical criteria for compost maturity assessment. A review. *Bioresour. Technol.* **100**(22), 5444–5453 (2009)
65. Sommer, S.G., Christensen, M.L., Schmidt, T., Jensen, L.S.: *Animal Manure Recycling: Treatment and Management*. Wiley, New York (2013)
66. Waldrip, H.M., Pagliari, P.H., He, Z. (eds.): *Animal Manure: Production, Characteristics, Environmental Concerns, and Management*, vol. 134. Wiley, New York (2020)
67. Azuara, M., Kersten, S.R., Kootstra, A.M.J.: Recycling phosphorus by fast pyrolysis of pig manure: concentration and extraction of phosphorus combined with the formation of value-added pyrolysis products. *Biomass Bioenergy* **49**, 171–180 (2013)
68. Atabani, A.E., Ali, I., Naqvi, S.R., Badruddin, I.A., Aslam, M., Mahmoud, E., Khan, T.Y.: A state-of-the-art review on spent coffee ground (SCG) pyrolysis for future biorefinery. *Chemosphere* **286**, 131730 (2022)
69. Bridgwater, A.V.: Review of fast pyrolysis of biomass and product upgrading. *Biomass Bioenergy* **38**, 68–94 (2012)
70. Basu, P.: *Biomass Gasification, Pyrolysis and Torrefaction: Practical Design and Theory*. Academic Press, New York (2013)
71. Hameed, Z., Aslam, M., Khan, Z., Maqsood, K., Atabani, A.E., Ghauri, M., Khurram, M.R.M.S., Rehan, M., Nizami, A.S.: Gasification of municipal solid waste blends with biomass for energy production and resources recovery: current status, hybrid technologies and innovative prospects. *Renew. Sustain. Energy Rev.* **136**, 110375 (2021)
72. Naqvi, S.R., Ali, I., Nasir, S., Taqvi, S.A.A., Atabani, A.E., Chen, W.H.: Assessment of agro-industrial residues for bioenergy potential by investigating thermo-kinetic behavior in a slow pyrolysis process. *Fuel* **278**, 118259 (2020)
73. Pandey, D.S., Katsaros, G., Lindfors, C., Leahy, J.J., Tassou, S.A.: Fast pyrolysis of poultry litter in a bubbling fluidised bed reactor: Energy and nutrient recovery. *Sustainability* **11**(9), 2533 (2019)
74. Oasmaa, A., Czernik, S.: Fuel oil quality of biomass pyrolysis oils state of the art for the end users. *Energy Fuels* **13**(4), 914–921 (1999)
75. Simbolon, L.M., Pandey, D.S., Horvat, A., Kwapinska, M., Leahy, J.J., Tassou, S.A.: Investigation of chicken litter conversion into useful energy resources by using low temperature pyrolysis. *Energy Procedia* **161**, 47–56 (2019)
76. Jung, J.M., Oh, J.I., Park, Y.K., Lee, J., Kwon, E.E.: Biodiesel synthesis from fish waste via thermally-induced transesterification using clay as porous material. *J. Hazard. Mater.* **371**, 27–32 (2019)
77. Baniasadi, M., Tugnoli, A., Conti, R., Torri, C., Fabbri, D., Cozzani, V.: Waste to energy valorization of poultry litter by slow pyrolysis. *Renew. Energy* **90**, 458–468 (2016)
78. Mante, O.D., Agblevor, F.A.: Storage stability of biocrude oils from fast pyrolysis of poultry litter. *Waste Manag.* **32**(1), 67–76 (2012)
79. Cantrell, K.B., Hunt, P.G., Uchimiya, M., Novak, J.M., Ro, K.S.: Impact of pyrolysis temperature and manure source on physicochemical characteristics of biochar. *Bioresour. Technol.* **107**, 419–428 (2012)
80. Agblevor, F.A., Beis, S., Kim, S., Tarrant, R., Mante, N.: Biocrude oils from the fast pyrolysis of poultry litter and hardwood. *Waste Manag.* **30**, 298–307 (2010)
81. Kim, S.S., Agblevor, F.A., Lim, J.: Fast pyrolysis of chicken litter and turkey litter in a fluidized bed reactor. *J. Ind. Eng. Chem.* **15**(2), 247–252 (2009)
82. Altaf, R., Lin, X., Zhuang, W. Q., Lu, H., Rout, P. R., Liu, D.: Nitrotrismethylenephosphonate sorption from wastewater on zirconium-lanthanum modified magnetite: reusability and mechanism study. *J. Clean. Product* **314**, 128045 (2021)
83. Koutcheiko, S., Monreal, C.M., Kodama, H., McCracken, T., Kotlyar, L.: Preparation and characterization of activated carbon derived from the thermo-chemical conversion of chicken manure. *Bioresour. Technol.* **98**(13), 2459–2464 (2007)

84. Whitely, N., Ozao, R., Cao, Y., Pan, W.P.: Multi-utilization of chicken litter as a biomass source. Part II. Pyrolysis. *Energy Fuels* **20**(6), 2666–2671 (2006)
85. Jeong, Y.W., Choi, S.K., Choi, Y.S., Kim, S.J.: Production of biocrude-oil from swine manure by fast pyrolysis and analysis of its characteristics. *Renew. Energy* **79**, 14–19 (2015)
86. Selim, O.M., Amano, R.S.: Co-pyrolysis of chicken and cow manure. *J. Energy Resour. Technol.* **143**(1), 011301 (2021)
87. Azargohar, R., Jacobson, K.L., Powell, E.E., Dalai, A.K.: Evaluation of properties of fast pyrolysis products obtained, from Canadian waste biomass. *J. Anal. Appl. Pyrol.* **104**, 330–340 (2013)
88. Erdogdu, A.E., Polat, R., Ozbay, G.: Pyrolysis of goat manure to produce bio-oil. *Eng. Sci. Technol. Int. J.* **22**(2), 452–457 (2019)
89. Mong, G.R., Chong, C.T., Ng, J.H., Chong, W.W.F., Lam, S.S., Ong, H.C., Ani, F.N.: Microwave pyrolysis for valorisation of horse manure biowaste. *Energy Convers. Manag.* **220**, 113074 (2020)
90. Valizadeh, S., Jang, S.H., Rhee, G.H., Lee, J., Show, P.L., Khan, M.A., Park, Y.K.: Biohydrogen production from furniture waste via catalytic gasification in air over Ni-loaded Ultra-stable Y-type zeolite. *Chem. Eng. J.* **433**, 133793 (2022)
91. Shim, J.W., Pyo, S., Lam, S.S., Jae, J., Jeon, B.H., Khan, M.A., Park, Y.K.: Catalytic pyrolysis of chicken manure over various catalysts. *Fuel* **322**, 124241 (2022)
92. Fadhil, A.B., Ahmed, A.I., Salih, H.A.: Production of liquid fuels and activated carbons from fish waste. *Fuel* **187**, 435–445 (2017)
93. Mrad, N., Paraschiv, M., Aloui, F., Varuvel, E.G., Tazerout, M., Nasrallah, S.B.: Liquid hydrocarbon fuels from fish oil industrial residues by catalytic cracking. *Int. J. Energy Res.* **37**(9), 1036–1043 (2013)
94. Kraiem, T., Hassen-Trabelsi, A.B., Naoui, S., Belayouni, H., Jeguirim, M.: Characterization of the liquid products obtained from Tunisian waste fish fats using the pyrolysis process. *Fuel Process. Technol.* **138**, 404–412 (2015)
95. Wiggers, V.R., Wisniewski, A., Jr., Madureira, L.A.S., Barros, A.C., Meier, H.F.: Biofuels from waste fish oil pyrolysis: continuous production in a pilot plant. *Fuel* **88**(11), 2135–2141 (2009)
96. EN 14214. Automotive Fuels—Fatty Acid Methyl Esters (FAME) for Diesel Engines—Requirements and Test Methods; European Standard: Pilsen, Czech Republic (2020)
97. Dalólio, F.S., da Silva, J.N., de Oliveira, A.C.C., Tinôco, I.D.F.F., Barbosa, R.C., de Oliveira Resende, M., Coelho, S.T.: Poultry litter as biomass energy: a review and future perspectives. *Renew. Sustain. Energy Rev.* **76**, 941–949 (2017)
98. Lynch, D., Henihan, A.M., Bowen, B., Lynch, D., McDonnell, K., Kwapinski, W., Leahy, J.J.: Utilisation of poultry litter as an energy feedstock. *Biomass Bioenergy* **49**, 197–204 (2013)
99. Arena, U.: Process and technological aspects of municipal solid waste gasification. A review. *Waste Manag.* **32**(4), 625–639 (2012)
100. Pandey, D.S., Kwapinska, M., Gómez-Barea, A., Horvat, A., Fryda, L.E., Rabou, L.P., Kwapinski, W.: Poultry litter gasification in a fluidized bed reactor: effects of gasifying agent and limestone addition. *Energy Fuels* **30**(4), 3085–3096 (2016)
101. Basu, P.: *Biomass Gasification and Pyrolysis: Practical Design and Theory*. Academic Press, New York (2010)
102. Lombardi, L., Carnevale, E., Corti, A.: A review of technologies and performances of thermal treatment systems for energy recovery from waste. *Waste Manag.* **37**, 26–44 (2015)
103. McKendry, P.: Energy production from biomass (part 3): gasification technologies. *Bioresour. Technol.* **83**(1), 55–63 (2002)
104. Horvat, A., Pandey, D.S., Kwapinska, M., Mello, B.B., Gómez-Barea, A., Fryda, L.E., Leahy, J.J.: Tar yield and composition from poultry litter gasification in a fluidised bed reactor: effects of equivalence ratio, temperature and limestone addition. *RSC Adv.* **9**(23), 13283–13296 (2019)
105. Murphy, J.D., McKeogh, E.: Technical, economic and environmental analysis of energy production from municipal solid waste. *Renew. Energy* **29**(7), 1043–1057 (2004)
106. Billen, P., Costa, J., Van der Aa, L., Van Caneghem, J., Vandecasteele, C.: Electricity from poultry manure: a cleaner alternative to direct land application. *J. Clean. Prod.* **96**, 467–475 (2015)
107. Walawender, W.P., Ganesan, S., Fan, L.T.: Steam gasification of manure in a fluid bed. Influence of limestone as a bed additive. Symposium Papers. In: *Energy from biomass and wastes V*. Lake Buena Vista, Florida, January 26–30, 1981, pp. 517–527. Institute of Gas Technology (1981)
108. Di Gregorio, F., Santoro, D., Arena, U.: The effect of ash composition on gasification of poultry wastes in a fluidized bed reactor. *Waste Manag. Res.* **32**(4), 323–330 (2014)
109. Katsaros, G., Pandey, D.S., Horvat, A., Tassou, S.: Low temperature gasification of poultry litter in a lab-scale fluidized reactor. *Energy Procedia* **161**, 57–65 (2019)
110. Katsaros, G., Pandey, D.S., Horvat, A., Almansa, G.A., Fryda, L.E., Leahy, J.J., Tassou, S.A.: Gasification of poultry litter in a lab-scale bubbling fluidised bed reactor: impact of process parameters on gasifier performance and special focus on tar evolution. *Waste Manag.* **100**, 336–345 (2019)
111. Priyadarsan, S., Annamalai, K., Sweeten, J.M., Holtzapple, M.T., Mukhtar, S.: Co-gasification of blended coal with feedlot and chicken litter biomass. *Proc. Combust. Inst.* **30**(2), 2973–2980 (2005)
112. Joseph, P., Tretsiakova-McNally, S., McKenna, S.: Characterization of cellulosic wastes and gasification products from chicken farms. *Waste Manag.* **32**(4), 701–709 (2012)
113. Priyadarsan, S., Annamalai, K., Sweeten, J.M., Mukhtar, S., Holtzapple, M.T.: Fixed-bed gasification of feedlot manure and poultry litter biomass. *Trans. ASAE* **47**(5), 1689 (2004)
114. Thanapal, S.S., Annamalai, K., Sweeten, J.M., Gordillo, G.: Fixed bed gasification of dairy biomass with enriched air mixture. *Appl. Energy* **97**, 525–531 (2012)
115. Taupe, N.C., Lynch, D., Wnetrzak, R., Kwapinska, M., Kwapinski, W., Leahy, J.J.: Updraft gasification of poultry litter at farm-scale—a case study. *Waste Manag.* **50**, 324–333 (2016)
116. Raman, K.P., Walawender, W.P., Fan, L.T.: Gasification of feedlot manure in a fluidized bed reactor. The effect of temperature. *Ind. Eng. Chem. Process Des. Dev.* **19**(4), 623–629 (1980)
117. Jeswani, H.K., Whiting, A., Martin, A., Azapagic, A.: Environmental and economic sustainability of poultry litter gasification for electricity and heat generation. *Waste Manag.* **95**, 182–191 (2019)
118. Bora, R.R., Lei, M., Tester, J.W., Lehmann, J., You, F.: Life cycle assessment and technoeconomic analysis of thermochemical conversion technologies applied to poultry litter with energy and nutrient recovery. *ACS Sustain. Chem. Eng.* **8**(22), 8436–8447 (2020)
119. Chen, J., Wang, L., Cheng, Z., Lu, L., Guo, L., Jin, H., Liu, S.: Performance simulation and thermodynamics analysis of hydrogen production based on supercritical water gasification of coal. *Int. J. Hydrog. Energy* **46**(56), 28474–28485 (2021)
120. Okolie, J.A., Nanda, S., Dalai, A.K., Berruti, F., Kozinski, J.A.: A review on subcritical and supercritical water gasification of biogenic, polymeric and petroleum wastes to hydrogen-rich synthesis gas. *Renew. Sustain. Energy Rev.* **119**, 109546 (2020)
121. Kamler, J., Soria, J.A.: Supercritical water gasification of municipal sludge: a novel approach to waste treatment and energy recovery. *Gasif. Pract. Appl.* 131–182 (2012)
122. Bandura, A.V., Lvov, S.N.: The ionization constant of water over wide ranges of temperature and density. *J. Phys. Chem. Ref. Data* **35**(1), 15–30 (2006)

123. Nanda, S., Gong, M., Hunter, H.N., Dalai, A.K., Gökalp, I., Kozinski, J.A.: An assessment of pinecone gasification in subcritical, near-critical and supercritical water. *Fuel Process. Technol.* **168**, 84–96 (2017)
124. Reddy, S.N., Nanda, S., Dalai, A.K., Kozinski, J.A.: Supercritical water gasification of biomass for hydrogen production. *Int. J. Hydrog. Energy* **39**(13), 6912–6926 (2014)
125. Cao, W., Cao, C., Guo, L., Jin, H., Dargusch, M., Bernhardt, D., Yao, X.: Hydrogen production from supercritical water gasification of chicken manure. *Int. J. Hydrog. Energy* **41**(48), 22722–22731 (2016)
126. Yong, T.L.K., Matsumura, Y.: Catalytic gasification of poultry manure and eucalyptus wood mixture in supercritical water. *Ind. Eng. Chem. Res.* **51**(16), 5685–5690 (2012)
127. Nanda, S., Dalai, A.K., Gökalp, I., Kozinski, J.A.: Valorization of horse manure through catalytic supercritical water gasification. *Waste Manag.* **52**, 147–158 (2016)
128. Youssef, E.A., Elbeshbishy, E., Hafez, H., Nakhla, G., Charpentier, P.: Sequential supercritical water gasification and partial oxidation of hog manure. *Int. J. Hydrog. Energy* **35**(21), 11756–11767 (2010)
129. Xie, Y., Zheng, X., Gao, W.: Gasification of horse dung in supercritical water. *Int. J. Hydrog. Energy* **47**(9), 5871–5878 (2022)
130. Nakamura, A., Shimizu, Y., Matsumura, Y., Minowa, T., Noda, Y., Kawai, Y.: Supercritical water gasification of layer poultry manure, swine manure and cattle manure with pilot scale plant. In: 18th European Biomass Conference and Exhibition, pp. 574–576. Lyon (2010)
131. Tavasoli, A., Aslan, M., Salimi, M., Balou, S., Pirbazari, S.M., Hashemi, H., Kohansal, K.: Influence of the blend nickel/porous hydrothermal carbon and cattle manure hydrochar catalyst on the hydrothermal gasification of cattle manure for H<sub>2</sub> production. *Energy Convers. Manag.* **173**, 15–28 (2018)
132. Ghanim, B.M., Pandey, D.S., Kwapinski, W., Leahy, J.J.: Hydrothermal carbonisation of poultry litter: effects of treatment temperature and residence time on yields and chemical properties of hydrochars. *Bioresour. Technol.* **216**, 373–380 (2016)
133. Font-Palma, C.: Methods for the treatment of cattle manure—a review. *C* **5**(2), 27 (2019)
134. Katsaros, G., Sommersacher, P., Retschitzegger, S., Kienzl, N., Tassou, S.A., Pandey, D.S.: Combustion of poultry litter and mixture of poultry litter with woodchips in a fixed bed lab-scale batch reactor. *Fuel* **286**, 119310 (2021)
135. Theegala, C.S., Midgett, J.S.: Hydrothermal liquefaction of separated dairy manure for production of bio-oils with simultaneous waste treatment. *Bioresour. Technol.* **107**, 456–463 (2012)
136. Islam, M.N., Park, J.H.: A short review on hydrothermal liquefaction of livestock manure and a chance for Korea to advance swine manure to bio-oil technology. *J. Mater. Cycles Waste Manag.* **20**(1), 1–9 (2018)
137. Perera, S.M.H.D., Wickramasinghe, C., Samarasinghe, B.K.T., Narayana, M.: Modeling of thermochemical conversion of waste biomass—a comprehensive review. *Biofuel Res. J.* **8**(4), 1481–1528 (2021)
138. Yakaboylu, O., Albrecht, I., Harinck, J., Smit, K.G., Tsalidis, G.-A., Di Marcello, M., Anastakis, K., de Jong, W.: Supercritical water gasification of biomass in fluidized bed: first results and experiences obtained from TU Delft/Gensos semi-pilot scale setup. *Biomass Bioenergy* **111**, 330–342 (2018)
139. Yakaboylu, O., Harinck, J., Gerton Smit, K.G., de Jong, W.: Supercritical water gasification of manure: a thermodynamic equilibrium modelling approach. *Biomass Bioenergy* **59**, 253–263 (2013)
140. Yakaboylu, O., Harinck, J., Smit, K.G., de Jong, W.: Supercritical water gasification of biomass: a thermodynamic model for the prediction of product compounds at equilibrium state. *Energy Fuels* **28**(4), 2506–2522 (2014)
141. Yakaboylu, O., Harinck, J., Smit, K.G., de Jong, W.: Testing the constrained equilibrium method for the modeling of supercritical water gasification of biomass. *Fuel Process. Technol.* **138**, 74–85 (2015)
142. Yakaboylu, O., Harinck, J., Smit, K., de Jong, W.: Supercritical water gasification of biomass: a literature and technology overview. *Energies* **8**(2), 859–894 (2015)
143. Yakaboylu, O., Yapar, G., Recalde, M., Harinck, J., Smit, K.G., Martelli, E., de Jong, W.: Supercritical water gasification of biomass: an integrated kinetic model for the prediction of product compounds. *Ind. Eng. Chem. Res.* **54**(33), 8100–8112 (2015)
144. Moghaddam, E.M., Goel, A., Siedlecki, M., Michalska, K., Yakaboylu, O., de Jong, W.: Supercritical water gasification of wet biomass residues from farming and food production practices: lab-scale experiments and comparison of different modelling approaches. *Sustain. Energy Fuels* **5**(5), 1521–1537 (2021)
145. Balu, E., Chung, J.N.: System characteristics and performance evaluation of a trailer-scale downdraft gasifier with different feedstock. *Bioresour. Technol.* **108**, 264–273 (2012)
146. Yanagida, T., Minowa, T., Nakamura, A., Matsumura, Y., Noda, Y.: Behavior of inorganic elements in poultry manure during supercritical water gasification. *J. Jpn. Inst. Energy* **87**(9), 731–736 (2008)
147. Yuan, X., He, T., Cao, H., Yuan, Q.: Cattle manure pyrolysis process: kinetic and thermodynamic analysis with isoconversional methods. *Renew. Energy* **107**, 489–496 (2017)
148. Cao, H., Xin, Y., Wang, D., Yuan, Q.: Pyrolysis characteristics of cattle manures using a discrete distributed activation energy model. *Bioresour. Technol.* **172**, 219–225 (2014)
149. Akyürek, Z.: Sustainable valorization of animal manure and recycled polyester: co-pyrolysis synergy. *Sustainability* **11**(8), 2280 (2019)
150. Chong, C.T., Mong, G.R., Ng, J.-H., Chong, W.W.F., Ani, F.N., Lam, S.S., Ong, H.C.: Pyrolysis characteristics and kinetic studies of horse manure using thermogravimetric analysis. *Energy Convers. Manag.* **180**, 1260–1267 (2019)
151. Poddar, S., Babu, J.S.C.: Modelling and optimization of a pyrolysis plant using swine and goat manure as feedstock. *Renew. Energy* **175**, 253–269 (2021)
152. Simbolon, L.M.: Investigations into the utilisation of chicken litter for power generation [Doctoral thesis] (2021)
153. Pandey, D.S.: Experimental and mathematical modelling of biowaste gasification in a bubbling fluidised bed reactor. PhD Dissertation, University of Limerick, Ireland (2016)
154. Caro, S., Dahl, O.: Thermochemical valorisation of waste: pyrolytic conversion of horse manure. *Clean. Eng. Technol.* **4**, 100181 (2021)
155. Mong, G.R., Chong, C.T., Ng, J.-H., Chong, W.W.F., Ong, H.C., Tran, M.V.: Multivariate optimisation study and life cycle assessment of microwave-induced pyrolysis of horse manure for waste valorisation and management. *Energy* **216**, 119194 (2021)
156. Zhu, S., Liu, Y., Lee, S.: Optimization process of biomass combustion in the advanced fbc using factorial design and response surface methodology. In: 18th International Conference on Fluidized Bed Combustion (2005)
157. Guo, S., Ren, C., Wang, Y., Liu, S., Du, M., Chen, Y., Guo, L.: Thermodynamic modelling and analysis of the heat integration and power generation in pig manure supercritical water gasification system. *Energy Convers. Manag.* **248**, 114809 (2021)
158. Wu, H.: Biomass gasification: an alternative to animal waste management [Dissertation] (2013)

159. Basu, M., Pande, M., Bhadoria, P.B.S., Mahapatra, S.C.: Potential fly-ash utilization in agriculture: a global review. *Prog. Nat. Sci.* **19**(10), 1173–1186 (2009)
160. Gómez-Barea, A., Fernández-Pereira, C., Vilches, L.F., Leiva, C., Campoy, M., Ollero, P.: Advanced utilisation options for biomass gasification fly ash. In: *Proceedings of the 15th European Biomass Conference & Exhibition*, pp. 7–11. Berlin, Germany (2007)
161. Pels, J.R., de Nie, D.S., Kiel, J.H.: Utilization of ashes from biomass combustion and gasification. In: *14th European Biomass Conference & Exhibition*, vol. 17, pp. 17–21 (2005)
162. Rout, P.R., Bhunia, P., Dash, R.R.: Response surface optimization of phosphate removal from aqueous solution using a natural adsorbent. *Trends Asian Water Environ. Sci. Technol.* 93–104 (2017b)
163. Gómez-Barea, A., Vilches, L.F., Leiva, C., Campoy, M., Fernández-Pereira, C.: Plant optimisation and ash recycling in fluidised bed waste gasification. *Chem. Eng. J.* **146**(2), 227–236 (2009)
164. Ram, L.C., Masto, R.E.: Fly ash for soil amelioration: a review on the influence of ash blending with inorganic and organic amendments. *Earth Sci. Rev.* **128**, 52–74 (2014)
165. Shaheen, S.M., Hooda, P.S., Tsadilas, C.D.: Opportunities and challenges in the use of coal fly ash for soil improvements—a review. *J. Environ. Manag.* **145**, 249–267 (2014)
166. Shrestha, P., Chun, D.D., Kang, K., Simson, A.E., Klinghoffer, N.B.: Role of metals in biochar production and utilization in catalytic applications: a review. *Waste Biomass Valoriz.* 1–26 (2021)
167. Francis, C.W., Davis, E.C., Goyert, J.C.: Plant uptake of trace elements from coal gasification ashes, vol. 14, no. 4, pp. 561–569. American Society of Agronomy, Crop Science Society of America, and Soil Science Society of America (1985)
168. Rosen, C.J., Olson, D., Bierman, P.M.: Swiss chard and alfalfa responses to soils amended with municipal solid waste incinerator ash: growth and elemental composition. *J. Agric. Food Chem.* **42**(6), 1361–1368 (1994)
169. Ahmaruzzaman, M.: A review on the utilization of fly ash. *Prog. Energy Combust. Sci.* **36**(3), 327–363 (2010)
170. Chand, S., Rout, P.R., Pathak, P.: Basic concepts, potentials, and challenges of urban mining. In: *Urban Mining for Waste Management and Resource Recovery*, pp. 1–15. CRC Press (2021)
171. Pathak, P., Rout, P.R. (eds.): *Urban Mining for Waste Management and Resource Recovery: Sustainable Approaches*. CRC Press, Boca Raton (2021)
172. Udayanga, W.C., Veksha, A., Giannis, A., Lisak, G., Chang, V.W.C., Lim, T.T.: Fate and distribution of heavy metals during thermal processing of sewage sludge. *Fuel* **226**, 721–744 (2018)
173. Saveyn, H., Ferrasse, J.H., Hernandez, A.B., Rose, J., Meeren, P.V., Roche, N.: The distribution of heavy metals following sewage sludge gasification. *J. Residuals Sci. Technol.* **8**, 61–66 (2011)
174. Li, L., Xu, Z.R., Zhang, C., Bao, J., Dai, X.: Quantitative evaluation of heavy metals in solid residues from sub-and super-critical water gasification of sewage sludge. *Bioresour. Technol.* **121**, 169–175 (2012)
175. Ronda, A., Gómez-Barea, A., Haro, P., de Almeida, V.F., Salinero, J.: Elements partitioning during thermal conversion of sewage sludge. *Fuel Process. Technol.* **186**, 156–166 (2019)
176. Haberl, J., Schuster, M.: Solubility of elements in waste incineration fly ash and bottom ash under various leaching conditions studied by a sequential extraction procedure. *Waste Manag.* **87**, 268–278 (2019)
177. Kurashima, K., Matsuda, K., Kumagai, S., Kameda, T., Saito, Y., Yoshioka, T.: A combined kinetic and thermodynamic approach for interpreting the complex interactions during chloride volatilization of heavy metals in municipal solid waste fly ash. *Waste Manag.* **87**, 204–217 (2019)
178. Pandey, D.S., Kwapinska, M., Leahy, J.J., Kwapinski, W.: Fly ash from poultry litter gasification—can it be utilised in agriculture systems as a fertiliser? *Energy Procedia* **161**, 38–46 (2019)
179. Chastain, J.P., Coloma-del Valle, A., Moore, K.P.: Using broiler litter as an energy source: energy content and ash composition. *Appl. Eng. Agric.* **28**(4), 513–522 (2012)
180. Reiter, M.S., Middleton, A.: Nutrient availability from poultry litter co-products. A summary of findings funded by the Farm Manureto-Energy Initiative, Appendix F (2016)
181. Reiter, M.S., Daniel, T.C., Slaton, N.A., Norman, R.J.: Nitrogen availability from granulated fortified poultry litter fertilizers. *Soil Sci. Soc. Am. J.* **78**(3), 861–867 (2014)
182. Rout, P.R., Dash, R.R., Bhunia, P.: Nutrient removal from binary aqueous phase by dolochar: highlighting optimization, single and binary adsorption isotherms and nutrient release. *Process Saf. Environ. Prot.* **100**, 91–107 (2016)
183. Mohanty, A., Meena, S.S., Pathak, P., Rout, P.R.: Cellulose and extracellular polymer recovery from sludge. In: *Clean Energy and Resource Recovery*, pp. 395–404. Elsevier (2022b)
184. Pandey, D.S., Yazhenskikh, E., Müller, M., Ziegner, M., Trubetskaya, A., Leahy, J.J., Kwapinska, M.: Transformation of inorganic matter in poultry litter during fluidised bed gasification. *Fuel Process. Technol.* **221**, 106918 (2021)
185. Huygens, D., Saveyn, H., Tonini, D., Eder, P., Delgado Sancho, L.: Technical proposals for selected new fertilising materials under the Fertilising Products Regulation (Regulation (EU) 2019/1009). *FeHPO CaHPO*, 4 (2019)
186. Roos, C.J.: *Clean Heat and Power Using Biomass Gasification for Industrial and Agricultural Projects*. US Department of Clean Energy (2010)
187. Uddin, M.N., Techato, K., Taweekun, J., Mofijur, M., Rasul, M.G., Mahlia, T.M.I., Ashrafur, S.M.: An overview of recent developments in biomass pyrolysis technologies. *Energies* **11**(11), 3115 (2018)
188. Khan, A.: *Advanced Technology for the Conversion of Waste into Fuels and Chemicals, Chemical Processes*, vol. 2. Woodhead Publishing, Oxford (2021)
189. Verma, M., Godbout, S., Brar, S.K., Solomatnikova, O., Lemay, S.P., Larouche, J.P.: Biofuels production from biomass by thermochemical conversion technologies. *Int. J. Chem. Eng.* (2012)
190. Castello, D.: *Supercritical water gasification of biomass*. [Doctoral Thesis]. Environmental Engineering (2013)
191. Susanti, R.F., Veriansyah, B., Kim, J.-D., Kim, J., Lee, Y.-W.: Continuous supercritical water gasification of isooctane: a promising reactor design. *Int. J. Hydrog. Energy* **35**(5), 1957–1970 (2010)
192. Kruse, A., Faquir, M.: Hydrothermal biomass gasification—effects of salts, backmixing and their interaction. *Chem. Eng. Technol.* **30**(6), 749–754 (2007)
193. Lu, Y., Jin, H., Guo, L., Zhang, X., Cao, C., Guo, X.: Hydrogen production by biomass gasification in supercritical water with a fluidized bed reactor. *Int. J. Hydrog. Energy* **33**(21), 6066–6075 (2008)
194. Lamb, J.J., Hillestad, M., Rytter, E., Bock, R., Nordgård, A.S.R., Lien, K.M., Burheim, O.S., Pollet, B.G.: Traditional routes for hydrogen production and carbon conversion. *Hydrogen, biomass and bioenergy*, pp. 21–53. Academic Press, London (2020)
195. Boukis, N., Stoll, I.K.: Gasification of biomass in supercritical water, challenges for the process design—lessons learned from the operation experience of the first dedicated pilot plant. *Processes* **9**(3), 455 (2021)

196. Burra, K.G., Hussein, M.S., Amano, R.S., Gupta, A.K.: Syngas evolutionary behavior during chicken manure pyrolysis and air gasification. *Appl. Energy* **181**(1), 408–415 (2016)
197. Sikarwar, V.S., Zhao, M., Clough, P., Yao, J., Zhong, X., Memon, M.Z., Shah, N., Anthony, E.J., Fennell, P.S.: An overview of advances in biomass gasification. *Energy Environ. Sci.* **9**(10), 2939–2977 (2016)
198. Fernandez-Lopez, M., Puig-Gamero, M., Lopez-Gonzalez, D., Avalos-Ramirez, A., Valverde, J., Sanchez-Silva, L.: Life cycle assessment of swine and dairy manure: pyrolysis and combustion processes. *Bioresour. Technol.* **182**, 184–192 (2015)
199. Wu, H., Hanna, M.A., Jones, D.D.: Life cycle assessment of greenhouse gas emissions of feedlot manure management practices: land application versus gasification. *Biomass Bioenergy* **54**, 260–266 (2013)
200. Fernandez-Lopez, M., López-González, D., Puig-Gamero, M., Valverde, J.L., Sanchez-Silva, L.: CO<sub>2</sub> gasification of dairy and swine manure: a life cycle assessment approach. *Renew. Energy* **95**, 552–560 (2016)
201. Sharara, M., Kim, D., Sadaka, S., Thoma, G.: Consequential life cycle assessment of swine manure management within a thermal gasification scenario. *Energies* **12**(21), 4081 (2019)
202. Mohanty, A., Rout, P.R., Dubey, B., Meena, S.S., Pal, P., Goel, M.: A critical review on biogas production from edible and non-edible oil cakes. *Biomass Convers. Biorefin.* 1–18 (2021)
203. Goel, M., Ramesh, M., Sreekrishnan, T.R.: Mixed culture acclimatization and biodegradation of chlorophenols in shake flasks: effect of the inoculum source. *Pract. Periodical Hazard. Toxic Radioactive Waste Manag.* **13**(1), 29–34 (2009)
204. Irfanudeen, N.M., Prakash, I.A., Saundaryan, R., Alagarraj, K., Goel, M., Kumar, K.R.: The potential of using low cost naturally available biogenic substrates for biological removal of chlorophenol. *Bioresour. Technol.* **196**, 707–711 (2015)
205. Kwak, W., Rout, P.R., Lee, E., Bae, J.: Influence of hydraulic retention time and temperature on the performance of an anaerobic ammonium oxidation fluidized bed membrane bioreactor for low-strength ammonia wastewater treatment. *Chem. Eng. J.* **386**, 123992 (2020)
206. Lee, E., Rout, P.R., Shin, C., Bae, J.: Effects of sodium hypochlorite concentration on the methanogenic activity in an anaerobic fluidized membrane bioreactor. *Sci. Total Environ.* **678**, 85–93 (2019)
207. BEIS. Biomass Policy Statement. London: Department for Business, Energy and *Industrial Strategy*. (2021). [https://assets.publishing.service.gov.uk/government/uploads/system/uploads/attachment\\_data/file/1031057/biomass-policy-statement.pdf](https://assets.publishing.service.gov.uk/government/uploads/system/uploads/attachment_data/file/1031057/biomass-policy-statement.pdf)
208. Hantoko, D., Su, H., Yan, M., Kanchanatip, E., Susanto, H., Wang, G., Xu, Z.: Thermodynamic study on the integrated supercritical water gasification with reforming process for hydrogen production: effects of operating parameters. *Int. J. Hydrog. Energy* **43**(37), 17620–17632 (2018)
209. Ubando, A.T., Rivera, D.R.T., Chen, W.-H., Culaba, A.B.: A comprehensive review of life cycle assessment (LCA) of microalgal and lignocellulosic bioenergy products from thermochemical processes. *Bioresour. Technol.* **291**, 121837 (2019)
210. Atienza-Martínez, M., Ábrego, J., Gea, G., Marías, F.: Pyrolysis of dairy cattle manure: evolution of char characteristics. *J. Anal. Appl. Pyrol.* **145**, 104724 (2020)
211. Janković, B.: Devolatilization kinetics of swine manure solid pyrolysis using deconvolution procedure. Determination of the bio-oil/liquid yields and char gasification. *Fuel Process. Technol.* **138**, 1–13 (2015)
212. He, S., Cao, C., Wang, J., Yang, J., Cheng, Z., Yan, B., Pan, Y., Chen, G.: Pyrolysis study on cattle manure: from conventional analytical method to online study of pyrolysis photoionization time-of-flight mass spectrometry. *J. Anal. Appl. Pyrol.* **151**, 104916 (2020)
213. Sánchez, M.E., Martínez, O., Gómez, X., Morán, A.: Pyrolysis of mixtures of sewage sludge and manure: a comparison of the results obtained in the laboratory (semi-pilot) and in a pilot plant. *Waste Manag.* **27**(10), 1328–1334 (2007)
214. Yıldız, Z., Kaya, N., Topcu, Y., Uzun, H.: Pyrolysis and optimization of chicken manure wastes in fluidized bed reactor: CO<sub>2</sub> capture in activated bio-chars. *Process Saf. Environ. Prot.* **130**, 297–305 (2019)
215. Ro, K.S., Cantrell, K.B., Hunt, P.G.: High-temperature pyrolysis of blended animal manures for producing renewable energy and value-added biochar. *Ind. Eng. Chem. Res.* **49**(20), 10125–10131 (2010)
216. Mante, O.D., Agblevor, F.A.: Parametric study on the pyrolysis of manure and wood shavings. *Biomass Bioenergy* **35**(10), 4417–4425 (2011)
217. Katsaros, G., Pandey, D.S., Horvat, A., Almansa, G.A., Fryda, L.E., Leahy, J.J., Tassou, S.A.: Experimental investigation of poultry litter gasification and co-gasification with beech wood in a bubbling fluidised bed reactor—effect of equivalence ratio on process performance and tar evolution. *Fuel* **262**, 116660 (2020)
218. Dayananda, B.S., Sreepathi, L.K.: A study on gasification of chicken litter with saw dust in a laboratory scale fluidized bed gasifier. *Int. J. Innov. Res. Sci. Eng. Technol.* **2**, 3901–3907 (2013)
219. Shen, Y., Tan, M.T.T., Chong, C., Xiao, W., Wang, C.H.: An environmental friendly animal waste disposal process with ammonia recovery and energy production: experimental study and economic analysis. *Waste Manag.* **68**, 636–645 (2017)

**Publisher's Note** Springer Nature remains neutral with regard to jurisdictional claims in published maps and institutional affiliations.