

**UNIVERSITY OF BELGRADE  
TECHNICAL FACULTY BOR**



**PROCEEDINGS**  
**XXIV International Conference**  
**Ecological Truth**

**Editors**

**Radoje V. Pantovic**

**Zoran S. Marković**

*EcoIst '16*

**12 – 15 June 2016**

**Hotel "BREZA" Vrnjacka Banja,  
SERBIA**

This page is intentionally left blank



UNIVERSITY OF BELGRADE  
TECHNICAL FACULTY BOR



XXIV International Conference  
"ECOLOGICAL TRUTH"

*Eco-Ist'16*

***PROCEEDINGS***

Edited by  
**Radoje V. PANTOVIC**  
and  
**Zoran S. MARKOVIC**

12 – 15 June 2016  
Hotel "Breza", Vrnjacka Banja, SERBIA

**XXIV International Conference  
"ECOLOGICAL TRUTH" Eco-Ist'16**

PUBLISHER:  
UNIVERSITY OF BELGRADE - TECHNICAL FACULTY IN BOR, BOR, MAY 2016

FOR THE PUBLISHER:  
DEAN: Prof. dr Dragana ZIVKOVIC

EDITOR IN CHIEF:  
Prof. dr Radoje PANTOVIC

TECHNICAL EDITOR  
Zeljko PAJKIC, MSc.

PRINTED BY:  
»Happy Trend« Zajecar

CIP – Каталогизација у публикацији –  
Народна библиотека Србије, Београд

502/504(082)  
613(082)

INTERNATIONAL Conference Ecological Truth  
(24 ; 2016 ; Vrnjačka Banja)  
Proceedings / XXIV International Conference  
"Ecological Truth", Eco-Ist '16, 12-15 June 2016,  
Vrnjačka Banja, Serbia ; [organizer] University of  
Belgrade, Technical Faculty, Bor ; edited by Radoje  
V. Pantovic and Zoran S. Markovic. - Bor : University,  
Technical Faculty, 2016 (Zaječar : Happy Trend). -  
XIX, 882 str. : ilustr. ; 25 cm

Tiraž 250. - Bibliografija uz svaki rad. - Registar.

ISBN 978-86-6305-043-3

1. Technical Faculty (Bor)  
a) Животна средина - Заштита - Зборници  
b) Здравље - Заштита - Зборници

COBISS.SR-ID 223956748

**ORGANIZER:**

**UNIVERSITY OF BELGRADE – TECHNICAL FACULTY BOR**

**Co-ORGANIZERS:**

**University of Zagreb, Faculty of Metallurgy - Sisak, Croatia**

**University in Banja Luka, Faculty of Technology - Banja Luka,  
RS, B&H**

**University Christian “Dimitrie Cantemir”, Faculty of Management in  
Tourism and Commerce - Timisoara, Romania**

**University of Pristina, Faculty of Technical Science - Kosovska  
Mitrovica, Serbia**

**Institute for Nature Conservation of Serbia - Belgrade, Serbia**

**Society of Young Researchers - Bor, Serbia**

---

**GENERAL SPONSOR:**

**The Ministry of Education, Science and Technological  
Development of the Republic of Serbia**

---

This page is intentionally left blank



## COMMITTEES

*XXIV International Conference*  
**"ECOLOGICAL TRUTH" Eco-Ist'16**

---

### HONORARY COMMITTEE

Emeritus Prof. dr Stevan Stankovic, Belgrade, **President**  
Dr Petar Paunovic, Zajecar  
Prof. dr Miodrag Miljkovic, Bor  
Prof. dr Novica Randjelovic, Nis  
Prof. dr Zvonimir Stankovic, Bor  
Dr Miodrag Todorovic, Zajecar  
Mihajlo Stankovic, S. Mitrovica

### SCIENTIFIC COMMITTEES

Prof. dr Dragana Zivkovic, **President**  
Prof. dr Radoje Pantovic, **Vice President**  
Prof. dr Zoran S. Markovic, **Vice President**

#### *International Committee*

Prof. dr Hami Alpas, Middle East Tech. Univ., Ankara (*TURKEY*)  
Prof. dr Gerassimos Arapis, Univ. of Athenas, Athenas (*GREECE*)  
Prof. dr Roberto E. Villas Boas, Ministerio da ciencia (*BRASIL*)  
Prof. dr Mladen Brncic, Univ. of Zagreb, Zagreb (*CROATIA*)  
Prof. dr Ilhan Bušatlić, Univ. of Zenica, Faculty of metallurgy and materials (*B&H*)  
Prof. dr Risto Dambov, Univ. "Goce Delcev" Stip (*FRY MACEDONIA*)  
Dr B. Das, CSIR-IMMT, Bhubaneswar (*INDIA*)  
Dr Kremena Dedelyanova, STUMGM, Sofia (*BULGARIA*)  
Prof. dr Genc Demi, Univ. of Tirana, Tirana (*ALBANIA*)  
Prof. dr Zoran Despodov, Univ. "Goce Delcev", Stip (*FRY MACEDONIA*)  
Doc. dr Natalija Dolić, Univ. of Zagreb, MF, Sisak (*CROATIA*)  
Prof. dr Antonello Garzoni, Libera Univ. Mediterranea, Bari (*ITALY*)  
Doc. dr Irena Grigorova, Univ. of Min.&Geol. "St Ivan Rilski", Sofia, (*BULGARIA*)  
Prof. dr Violeta Holmes, Univ. of Huddersfield (*UK*)  
Prof. dr Slavomir Hredzak, Slovak Academy of Science, Kosice (*SLOVAKIA*)  
Prof. dr Rajko Igic, JSHCC, Chicago (*USA*)  
Prof. dr Totyo Iliev, TU, Gabrovo (*BULGARIA*)  
Dr Florian Kongoli, Flogen Technologies, Inc., (*CANADA/USA*)  
Dr Marius Kovacs, INCD INSEMEX, Petroșani (*ROMANIA*)

Prof. dr Jakob Lamut, Univ.Lj FNT, Ljubljana (SLOVENIA)  
Prof. dr Ladislav Lazic, Univ. of Zagreb, MF, Sisak (CROATIA)  
Dr Aleksander Lutyński, Silesian University of Technology, Gliwice (POLAND)  
Prof. dr Konstantinos Matis, Aristotle Univ., Thessaloniki (GREECE)  
Prof. dr Marius Miculescu, FMTC, Timisoara (ROMANIA)  
Prof. dr Mirela Mazilu, Univ. of Craiova (ROMANIA)  
Prof. dr B. K. Mishra, Director CSIR-IMMT, Bhubaneswar (INDIA)  
Prof. dr Irena Nikolić, UMN, FMT, Podgorica (MONTENEGRO)  
Prof. dr Ivan Nishkov, Univ.of Min.&Geol. "St Ivan Rilski", Sofia (BULGARIA)  
Prof. dr Adila Nuric, Univ. of Tuzla, RGGF, Tuzla (B&H)  
Prof. dr Samir Nuric, Univ. of Tuzla, RGGF, Tuzla (B&H)  
Prof. dr Guven Onal, Techn. Univ., Istanbul (TURKEY)  
Prof. dr Jelena Penavin-Skundric, UBL, Faculty of Technology, Banja Luka, RS (B&H)  
Prof. dr Jelena Pjescic, UMN, FMT, Podgorica (MONTENEGRO)  
Prof. dr Helena Prosen, University of Ljubljana, FCCT, Ljubljana (SLOVENIA)  
Prof. dr. Svilen Ratchev, TU, Gabrovo (BULGARIA)  
Prof. dr Cipriana Sava, FMTC, Timisoara (ROMANIA)  
Prof. dr Umran Seven Erdemir, Uludag University, FAS, Bursa (TURKEY)  
Prof. dr Slavica Sladojevic, Univ. of Banja Luka, TF, Banja Luka, RS (B&H)  
Prof. dr Petr Solzhenkin, Russian Academy of Science, Moskow (RUSSIA)  
Prof. dr Natalia Shtemenko, DN Univ. "Oleg Goncar", Dnepropetrovsk (UKRAINE)  
Prof. dr Nada Sumatic, Faculty of Forestry, Banja Luka, RS (B&H)  
Prof. dr Barbara Tora, Academy GH, Krakow (POLAND)  
Prof. dr Darko Vuksanovic, UMN, FMT, Podgorica (MONTENEGRO)  
Prof. dr Jim Yip, College of Science&Technology, Salford (UK)  
Prof. dr Jacques Yvon,ENSG, Nancy (FRANCE)

#### **Local Committee**

Prof. dr Grozdanka Bogdanovic, UB TF, Bor  
Prof. dr Mile Dimitrijevic, UB TF, Bor  
Prof. dr Gordana Drazic, Faculty Futura, Belgrade  
Prof. dr Dejan Filipovic, UB GF, Belgrade  
Prof. dr Tibor Halasi, UNS PMF, Novi Sad  
Prof. dr Predrag Jaksic, UNI PMF, Nis  
Prof. dr Djordje Janicijevic, UB TMF, Belgrade  
Prof. dr Zeljko Kamberovic, UB TMF, Belgrade  
Prof. dr Milena Kostovic, UB RGF, Belgrade  
Dr Dejan Kozelj, Rakita Exploration, Bor  
Dr Dragan Milanovic, IRM, Bor  
Prof. dr Snezana Milic, UB TF, Bor  
Prof. dr Dusko Minic, UP FTS, K.Mitrovica  
Prof. dr Zoran Milosevic, UNI MF, Nis  
Prof. dr Maja Nikolic, UNI MF, Nis  
Dr Nina Obradovic, ITN SANU, Belgrade  
Prof. dr Slavisa Putic, UB TMF, Belgrade  
Prof. dr Ivica Radovic, UB FB, Belgrade  
Prof. dr Vesela Radovic, UB IRM, Belgrade  
Prof. dr Ivica Ristic, UB RGF, Belgrade

Prof. dr Mirjana Rajcic-Vujasinovic, UB TF, Bor  
Prof. dr Novica Staletovic, FEZZS, Belgrade  
Prof. dr Nenad Stavretovic, UB FF, Beograd  
Prof. dr Snezana Serbula, UB TF, Bor  
Prof. dr Jasmina Stevanovic, IHTM, Belgrade  
Prof. dr Dejan V. Stojanovic, UNS Inst. for lowland forestry, Novi Sad  
Dr Mirjana Stojanovic, ITNMS, Beograd  
Prof. dr Nada Strbac, UB TF, Bor  
Prof. dr Dejan Tanikic, UB TF, Bor  
Prof. dr Milan Trumic, UB TF, Bor  
Prof. dr Snezana Urosevic, UB TF, Bor  
Prof. dr Nebojsa Vidanovic, UB RGF, Belgrade  
Prof. dr Maja Vukasinovic- Sekulic, UB TMF, Belgrade  
Prof. dr Miodrag Zikic, UB TF Bor

#### **PROGRAM COMMITTEE**

Prof. dr Dragana Zivkovic, UB TF Bor  
Prof. dr Radoje Pantovic, UB TF Bor  
Prof. dr Zoran S. Markovic, UB TF Bor  
Prof. dr Snezana Serbula, UB TF Bor  
Prof. dr Mirjana Rajcic-Vujasinovic, UB TF Bor  
Dragan Randjelovic, Spec. MBA

#### **ORGANIZING COMMITTEE**

Prof. dr Radoje V. Pantovic, **President**  
Prof. dr Zoran S. Markovic, **Vice President**  
Prof. dr Snezana Serbula, **Vice President**  
Prof. dr Snezna Urosevic  
Doc. dr Sasa Stojadinovic  
Doc. dr Dejan Petrovic  
Dragan Randjelovic, MBA

This page is intentionally left blank



## TABLE OF CONTENTS

### PLENARY LECTURE

<i>Dejan V. Stojanovic</i> NATIONAL ENTOMOLOGICAL MUSEUM AT FRUSKA GORA .....	1
<i>Ivana Smiciklas</i> POTENTIAL APPLICATION OF WASTE MATERIALS AS SORBENTS FOR PURIFYING RADIONUCLIDE AND HEAVY METAL LADEN WATER.....	11
<i>Djurđica Stojanovic, V. Knezevic</i> LOGISTICS OPERATORS IN WASTE MANAGEMENT IN THE REPUBLIC OF SERBIA.....	19
<i>Florian Kongoli</i> THE ECOLOGICAL TRUTH AND VARIOUS SCIENTIFIC, ECONOMIC AND SOCIAL APPROACHES TOWARDS IT.....	32

### PROTECTION AND PRESERVATION OF NATURAL RESOURCES

<i>Nenad Stavretovic, K. Buvac, N. Karanac, S. Tilinger</i> OPENING SMALL AND MEDIUM SIZED COMPANIES IN THE FIELD OF LANDSCAPE ARCHITECTURE AND HORTICULTURE.....	33
<i>Orhideja Strbac, M. Vucanovic</i> A RECORD OF NOSTOC COLONIES AT VRSAC'S MONTANTAINS.....	40
<i>Orhideja Strbac, Z. Gavrilovic</i> FIRST FINDINGS RECORD REPORT REGARDING HALYOMORPHA HALYS IN SERBIA.....	44
<i>Mihajlo Stankovic</i> THE AMENDMENT LEAVES SPECIES DIVERSITY OF FAUNA INVERTEBRATA SPECIAL NATURE RESERVE ZASAVICA.....	48
<i>Ana Cuculovic, R. Cuculovic, S. Nestorovic, D. Veselinovic</i> ACTIVITY LEVELS OF <sup>137</sup> Cs AND <sup>40</sup> K IN MOSS FROM NP DJERDAP IN 2015.....	55
<i>Katarina Zoric, V. Markovic, J. Tomovic, A. Atanackovic, B. Vasiljevic, J. Canak Atlagic, S. Andjus, M. Kracun-Kolarevic, N. Marinkovic, N. Popovic, M. Rakovic, J. Djuknic, V. Djikanovic, B. Tubic, M. Ilic, M. Paunovic, V. Nikolic, G. Stamenkovic</i> TOWARDS ASSESSING GENETIC DIVERSITY OF <i>Theodoxus danubialis</i> (C. PFEIFFER, 1828)(GASTROPODA; NERITIDAE) FROM CENTRAL BALKAN.....	61

**Katarina Zoric, V. Markovic, J. Tomovic, A. Atanackovic, B. Vasiljevic,  
J. Canak Atlagic, S. Andjus, M. Kracun-Kolarevic, N. Marinkovic,  
N. Popovic, M. Rakovic, J. Djuknic, V. Djikanovic, M. Ilic, B. Tubic, M. Paunovic**  
ASSESSMENT OF BIOPOLLUTION IN THE SERBIAN PART  
OF THE DANUBE RIVER..... 66

**TECHNOLOGIES, WASTES RECYCLING AND THE ENVIRONMENT**

**Tihomir Popovic, B. Jovic, J. Knezevic**  
INITIAL IMPACT OF NEW BOR COPPER SMELTER ON AIR QUALITY..... 71

**Dusanka Miljkovic, G. Lazic, D. Marinkovic**  
THE CONTENT OF HEAVY METALS IN THE PRECIPITATED  
OVERFLOW WATER AFTER THE TREATMENT..... 77

**Biljana Jovanovic, B. Todorovic**  
ATMOSPHERIC PARTICULATE MATTER CONCENTRATION  
AND THEIR HEAVY METAL CONTENT IN BOR, SERBIA..... 84

**Vesna Cvetanovski, B. Jovanovic**  
SO<sub>2</sub> AS AN INDICATOR OF AIR POLLUTION IN BOR..... 91

**Snezana Serbula, J. Milosavljevic, A. Radojevic, J. Kalinovic,  
T. Kalinovic, T. Apostolovski Trujic**  
SULPHUR DIOXIDE LEVEL IN THE AIR IN THE PERIOD 2009-2015  
(BOR, EASTERN SERBIA)..... 97

**Marcin Lutynski, S. Lutynska**  
INVENTORY OF POLISH CRITICAL RAW MATERIALS ESSENTIAL  
FOR THE ECONOMY OF THE EUROPEAN UNION..... 104

**Marius Kovacs, G. A. Gaman, A. Calamar, L. Toth, S. Simion**  
EFFECTS OF WOOD DUSTS ON WORKER'S HEALTH  
IN ROMANIAN WOOD INDUSTRY..... 109

**Umran Seven Erdemir, H. Arslan, G. Guleryuz, S. Gucer**  
INDUCTIVELY COUPLED PLASMA MASS SPECTROMETRY AS  
A TOOL FOR CASE STUDY OF ABANDONED TUNSTEN MINE..... 117

**Irena Nikolic, D. Djurovic, B. Mugosa**  
STABILIZATION/SOLIDIFICATION OF ELECTRIC ARC FURNACE DUST IN  
SLAG BASED ALKALI ACTIVATED BINDERS..... 122

**Ilhan Busatlic, S. Muhamedagic, N. Busatlic, N. Merdic, N. Haracic**  
THE PRELIMINARY EXAMINATION OF TECHNOGENIC WASTE MATERIALS FROM  
BOSNIA AND HERZEGOVINA USAGE POSSIBILITY  
IN PORTLAND-COMPOSITE CEMENT PRODUCTION..... 128

<b>Sanja Dobrnjac, J. Penavin Skundric, Z. Levi, D. Lazic, Lj. Vasiljevic</b> THE RESEARCH OF TEMPERATURE INFLUENCE AND ADSORBENTS STRUCTURE ON THE EFFICIENCY OF THE ORGANIC DYES ADSORPTION.....	133
<b>Samir Nuric, A. Nuric, J. Zenunovic</b> NOISE AT THE OPEN PIT MINE.....	141
<b>Suzana Lutovac, R. Tokalic, B. Gluscevic, N. Vidanovic, C. Beljic</b> EFFECT OF BLASTING ON THE ADJACENT BUILDING AND MINING STRUCTURES AT THE OPEN PIT KIJEVO.....	148
<b>Violeta Cibulic, M. Trifunovic, N. Staletovic, V. Presburger Ulnikovic, S. Polavder, S. Mrazovac Kurilic</b> WASTE WATER FROM PRODUCTION OF GLASS.....	156
<b>Aleksander Lutynski</b> PROCESSING OF SAND-GRAVEL AGGREGATES IN POLAND.....	162
<b>Miroslav M. Pavlovic, M. Pantovic, V. Pavelkic, J. Stevanovic, M. G. Pavlovic</b> BIODEGRADABLE POLYMERS AS MATRICES FOR ELECTROCONDUCTIVE COMPOSITES.....	169
<b>Jaroslava Budinski Simendic, Z. Bjelovic, Lj. Tanasic, T. Erceg, J. Pavlicevic, V. Aleksic, V. Micic</b> THERMAL PROPERTIES OF POLYURETHANES BASED ON RENEWABLE POLYOL COMPONENT.....	177
<b>Sasa Stojadinovic, R. Pantovic, M. Zikic, M. Denic</b> CEROVO COPPER MINES CONTROLLED BLASTING DESIGN.....	185
<b>Stevo Jacimovski, J. Setrajcic, R. Radovanovic, S. Miladinovic</b> ANALYSIS OF AIR POLLUTION FROM POINT SOURCES ON THE EXAMPLE OF STEEL PLANT SMEDEREVO.....	192
<b>Slobodan Miladinovic, S. Jacimovski</b> AIR POLLUTION ANALYSIS OF STEEL PLANT ZELEZARA SMEDEREVO AND THERMAL POWER PLANT KOSTOLAC AND ASSESSMENT OF ENVIRONMENTAL IMPACT ON SMEDEREVO-POZAREVAC DANUBE REGION.....	201
<b>Maja Trifunovic, V. Cibulic, N. Staletovic, S. Mrazovac Kurilic</b> INDUSTRIAL WASTE IN HEATING PLANTS.....	212
<b>Uros S. Stamenkovic, S. Ivanov, I. Markovic</b> OPTICAL MICROSCOPY AND SEM/EDS ANALYSIS OF PHASES IN AGE HARDENABLE AND RECYCLABLE ALUMINUM ALLOYS FROM 6000 SERIES.....	216
<b>Zorica Lopacic, M. Stojanovic, J. Milojkovic, M. Petrovic, M. Mihajlovic, T. Sostaric, J. Petrovic</b> APPLICATION OF ELOVICH EQUATION IN ANALYSIS OF ADSORPTION KINETICS IN Cu-LCW SYSTEM.....	223

<b>Zaklina Z. Tasic, M. B. Petrovic Mihajlovic, A. T. Simonovic, M. B. Radovanovic, S. M. Milic, M. M. Antonijevic</b> THE INFLUENCE OF PH VALUE ON THE INHIBITION EFFICIENCY OF MIXED SYSTEM OF AZOLES AND GELATIN IN SULFURIC ACID MEDIUM.....	231
<b>Irma Dervisevic, A. Dervisevic</b> CHARACTERIZATION OF PCBS OF COMPUTER AND MOBILE PHONE, RECYCLING AND SEPARATION OF GOLD AND SILVER.....	238
<b>Gordana Kulic, V. Radojicic, S. Alagic, M. Malnar, N. Mandic</b> USABILITY OF TOBACCO WASTE IN RECONSTITUTED TOBACCO PRODUCTION...	245
<b>Miodrag Zikic, S. Stojadinovic, R. Pantovic, M. Zivkovic, D. Tanikic</b> TREATMENT OF USED TIRES WITHIN THE RTB BOR-GROUP.....	253
<b>Milan Cekerevac, M. Zdravkovic, Lj. Nikolic Bujanovic, M. Tomic</b> MEDIATED OXIDATION OF SUCROSE BY FERRATE(VI) ELECTROCHEMICALLY GENERATED IN THE TREATMENT REACTOR.....	258
<b>Snezana Devic, M. Cocic</b> MINERALGICAL CHARACTER OF THE MIXER SLAG.....	265
<b>Gracijan Strainovic, Z. Markovic, Z. Stirbanovic</b> FLOTATION RECOVERY OF COPPER MINERALS BY DIFFERENT KIND OF COLLECTORS AND FEED FINES.....	272
<b>Srdjana Magdalinovic, Z. Markovic, I. Jovanovic, R. Pantovic, S. Petrovic, D. Milanovic, Z. Stirbanovic</b> RECONSTRUCTED SMELTING SLAG PROCESSING PLANT. PART 1 - FLOTATION CONCENTRATION.....	277
<b>Aleksandra Bozic, J. Rusmirovic, M. Stamenovic, V. Alivojvodic, N. Bukumiric, S. Putic</b> ALKYD RESINS BASED ON WASTE PET .....	282
<b>Vesna Alivojvodic, N. Bukumiric, A. Bozic, M. Stamenovic, S. Djarmati</b> THE CONCEPT OF SUSTAINABLE LANDFILLS.....	288
<b>Ivan Ristic, T. Erceg, I. Krakovsky, R. Radicevic, B. Pilic, A. Miletic, D. Manjencic</b> MECHANICAL PROPERTIES OF RIGID POLYURETHANE FOAMS WITH ADDITION OF RECYCLED POLYURETHANES.....	293
<b>Ivana Jovanovic, S. Petrovic, S. Magdalinovic, R. Pantovic, D. Milanovic, I. Andjelovic, M. Mikic</b> RECONSTRUCTED SMELTING SLAG PROCESSING PLANT. PART 3 – DEWATERING OF TAILINGS.....	302
<b>Sanja Petrovic, I. Jovanovic, S. Magdalinovic, D. Petrovic, D. Milanovic, M. Mikic</b> RECONSTRUCTED SMELTING SLAG PROCESING PLANT. PART 2 - DEWATERING OF DEFINITIVE COPPER CONCENTRATE.....	308

<i>Vesna Lazarevic, I. Krstic, M. Stanisavljevic</i> POTENTIAL TOXIC EFFECTS OF COPPER IN METAL INDUSTRY.....	313
<i>Zoran Stirbanovic, J. Sokolovic, Z. Markovic, R. Stanojlovic, R. Pantovic, V. Gardic, D. Milanovic, G. Strajinovic</i> POSSIBILITIES FOR REUSING FLOTATION TAILINGS FROM SMELTER SLAG FLOTATION.....	321
<i>Silvana B. Dimitrijevic, A. T. Ivanovic, S. R. Magdalinovic, S. Z. Ivanovic, S. Krstic, B. T. Trumic, S. S. Dragulovic, K. R. Pantovic</i> RECYCLING OF PLATINUM FROM CRUCIBLES FOR MELTING AND CASTING.....	327
<i>Ljiljana Avramovic, R. Jonovic, D. Urosevic, A. Shibayama, K. Haga, H. Baisui, Z. Stevanovic, J. Petrovic, R. Pantovic</i> PROCESS FOR CONCENTRATION OF COPPER FROM MINE TAILING BY FLOTATION.....	334
<b>SOIL AND WATER CONSERVATION ENGINEERING</b>	
<i>Helena Prosen, M. Starc, S. Ognjanovic</i> SORPTION AND PHOTODEGRADATION OF NEONICOTINOID INSECTICIDES IN SOIL.....	341
<i>Artem V. Kolesnikov, E. N. Gaidukov, V. A. Kolesnikov</i> EXTRACTION AND SEPARATION OF SPARINGLY LANTHANUM AND CERIUM COMPOUNDS FROM AQUEOUS SOLUTIONS USING ELECTROCHEMICAL METHODS.....	349
<i>Marijana Saric, M. Domazet, S. Leovac, N. Vranic, S. Andric</i> FLOATING LANDFILLS IN ACCUMULATIONS OF 'DRINSKO-LIMSKE HYDROPOWER PLANTS' .....	354
<i>Novica Momcilovic, J. Vukasinovic</i> UNDERGROUND AND SURFACE WATER PROTEKTION OF HEATING FACILITY VREOCI POLUTANTS, BY USING HDPE GEOMEMBRANES.....	362
<i>Bozidarka Arsenovic, B. Ivanovic, S. Stanisic</i> PURIFICATION WASTE WATER AND POLLUTED AIR GALVANIC-CHEMICAL PROCESSES.....	368
<i>Vesna Djurovic, S. Tanaskovic, D. Djukic, L. Mandic, S. Gvozdenac, D. Knezevic</i> WATER QUALITY AND ECOLOGICAL STATUS OF THE TRIBUTARIES OF WESTERN MORAVA IN THE ČAČAK AND KRALJEVO REGION.....	378
<i>Gordana Sekularac, R. Ristic, D. Markovic</i> CALCULATION OF THE SEDIMENT YIELD OF THE COLOVICA BROOK CATCHMENT, WESTERN SERBIA.....	384

<b>Gordana Sekularac, R. Ristic, M. Djuric, M. Aksic, D. Markovic, N. Gudzic, B. Pejic</b> NATURAL AND ANTROPOGENIC INFLUENCE ON THE SOIL EROSION INTENSITY IN THE KARAUJSKI BROOK CATCHMENT – WESTERN SERBIA.....	391
<b>Borislav N. Malinovic, T. Malinovic, S. Bunic</b> TREATMENT OF WASTEWATER CONTAINING CYANIDES IN A FLOW ELECTROCHEMICAL REACTOR.....	398
<b>Zora Levi, J. Penavin-Skundric, S. Sladojevic, D. Bodroza</b> INFLUENCE OF SURFACE ACTIVE SUBSTANCES ON 4A ZEOLITE CHARACTERISTICS.....	407
<b>Dusanka Miljkovic, G. Lazic, B. Todorovic, M. Popovic</b> THE POSITIVE EFFECTS OF THE NEW TECHNOLOGY TO THE AIR POLLUTION CAUSED BY SO <sub>2</sub> IN BOR AND ITS SURROUNDINGS.....	414
<b>Violeta Cibulic, M. Trifunovic, V. Presburger Ulnikovic, N. Staletovic, S. Polavder</b> MONITORING OF SURFACE WATER.....	421
<b>Ljiljana Nikolic Bujanovic, M. Cekerevac, M. Tomic, M. Zdravkovic</b> APPLICATION OF TETRA-OXY Fe(VI) SALTS IN SOLID STATE IN THE OXIDATIVE DEGRADATION OF PESTICIDE CLOMAZONE IN WATER.....	430
<b>Marija Petrovic, T. Sostaric, M. Stojanovic, J. Petrovic, M. Mihajlovic, J. Milojkovic, Z. Lopacic</b> CORN COB AND CORN SILK AS BIOSORBENT FOR METAL IONS REMOVAL FROM AQUEOUS SOLUTION: COMPARATIVE ANALYSIS.....	437
<b>Marija Sljivic Ivanovic, I. Smiciklas, M. Jovic, S. Dimovic, I. Jelic</b> KINETIC STUDY OF Co <sup>2+</sup> SORPTION BY DIFFERENT SOIL TYPES.....	442
<b>Miroslava Maric, M. Antonijevic, A. Cvetkovic</b> PHYTOREMEDIATION - GREEN TECHNOLOGY FOR SUSTAINABLE SOIL DEVELOPMENT.....	449
<b>Dragan Pajic, I. Ristanovic Ponjavic, S. Mladenovic, A. Tanaskovic</b> QUALITY OF WATER OF THE SAVA LAKE ON ADA CIGANLIJA IN THE PERIOD 2012.-2015. ....	457
<b>Zarko Veljkovic, T. Petrovic Pantic, M. Tomic, M. Mandic, K. Samolov</b> VULNERABILITY OF GROUNDWATER POLLUTING IN THE AREA OF NATIONAL PARK „FRUSKA GORA“.....	464
<b>Snezana Urosevic, M. Smelcerovic, D. Djordjevic</b> TECHNO-ECONOMIC ASPECTS OF THE TREATMENT OF WASTEWATER INCURRED DYEING TEXTILES.....	470

## ENERGY EFFICIENCY, ENVIRONMENT AND CLIMATE

<i>Marcin Lutynski, A. Lutynski</i> ENERGY POTENTIAL OF COAL SLURRIES DEPOSITED IN ENVIRONMENT.....	477
<i>Ladislav Lazic, M. Lovrenic Jugovic, A. Varga, J. Kizek</i> IMPROVING ENERGY EFFICIENCY OF FIRED HEATER BY HIGH EMISSIVITY COATING.....	482
<i>Zdravko Praunseis</i> AN INFLUENCE OF DOMINANT ENERGY EFFICIENCY FACTORS ON ENERGY RENOVATION OF AN OLDER HOUSE.....	490
<i>Marcin A. Lutynski, M. A. Gonzalez, J. Szczepanski, P. Słomski</i> SHALE GAS POTENTIAL AND METHODS OF GAS CONTENT MEASUREMENT IN POLAND.....	501
<i>Ivana Jelic, D. Antonijevic, G. Drazic, J. Aleksic, I. Petric</i> UTILIZATION OF <i>MISCANTHUS GIGANTEUS</i> AS THERMAL INSULATION MATERIAL.....	507
<i>Bojan Stojcetovic, Z. Sarkocecic, M. Misic, M. Jovanovic</i> RENEWABLE ENERGY SOURCES IMPACTS ON ENVIRONMENT.....	515
<i>Bozidar Rancic, N. Rancic, S. Otasevic, B. Kocic, B. Petrovic, M. Ilic</i> ECO-DRIVING AS MEASURE OF INCREASE ENERGY EFFICIENCY IN ROAD TRANSPORTATION.....	521
<i>Predrag Stolic, S. Stolic, A. Milosavljevic, M. Pantovic</i> MONITORING AND IMPROVEMENT ENERGY EFFICIENCY OF COMMERCIAL VEHICLE FLEET BASED ON DATA DRIVEN APPROACH.....	526
<b>NUTRITION AND HEALTH</b>	
<i>Ivica Vujcic, S. Masic, M. Medic, I. Vukoje, S. Putic, M. D. Dramicanin</i> ESTABLISHING GAMMA IRRADIATION METHOD OF PRUNES CONSERVATION.....	533
<i>Vesela Radovic, S. Krnjajic, B. Ilic</i> PROVIDING FOOD SECURITY HAVING IN MIND ONE RISK MORE –PLANT PEST AND DISEASES.....	538
<i>Zorica Basic, S. Masic</i> CONTENTS OF SOME OLIGOELEMENTS IN SERBIAN WINES AND FRUIT WINES....	547
<i>Gorica Paunovic, R. Ilic, V. Vukosavljevic, I. Glisic, Lj. Boskovic Rakocecic</i> ECONOMIC IMPORTANCE OF WILD FRUIT AND AUTOCHTHONOUS VARIETIES OF GRAPE .....	551

*Gorica Paunovic, M. Kulina, R. Ilic, Lj. Boskovic Rakocevic, I. Glisic*  
ARONIA - FRUIT FOR ECOLOGICAL GROWING..... 558

**AGRICULTURE: AGRIBUSINESS, AGROENGINEERING AND ORGANIC  
FOOD PRODUCTION**

*Snezana Tanaskovic, B. Popovic, S. Gvozdenac, Zs. Karpati, C. Bognar, M. Erb*  
INFLUENCE OF ARTIFICIAL INFESTATION WITH WCR EGGS  
ON MAIZE ROOT DAMAGES AND BIOMASS ..... 564

*Snezana Tanaskovic, G. Draskovic, M. Marjanovic, S. Gvozdenac*  
EFFICACY OF Voliam Targo 063 SC IN SUPPRESSION *Cydia pomonella*  
ACCORDING TO CAS ..... 571

*Slobodan Neskovic*  
ECONOMIC CONTEXT OF ORGANIC AGRICULTURE AND FARMS  
IN SERBIA-CASE STUDY..... 578

*Gordana Milojevic Miodragovic, Lj. Torovic, S. Bobic, D. Lukic*  
NITRATE IN GREEN LEAFY VEGETABLES FROM CONVENTIONAL  
AND ORGANIC PRODUCTION..... 585

*Rodica Caprita, A. Caprita*  
PHYSICOCHEMICAL FACTORS WHICH AFFECT MILK DENSITY..... 590

*Rodica Caprita, A. Caprita*  
SOME RHEOLOGICAL ASPECTS OF WHOLE MILK..... 596

*Aleksandra Fedajev, D. Durkalic, D. Riznic*  
IMPACT OF NATURAL DISASTERS AGRICULTURE PRODUCTION  
IN THE WESTERN BALKANS COUNTRIES..... 603

*Misko M. Milanovic, A. D. Markovic, M. S. Ilic*  
THE IMPORTANCE SUSTAINABLE AGRICULTURE ON THE EXAMPLE  
RED WORMS COMPOSTING..... 610

**ECOLOGICAL MANAGEMENT AND ECOLOGICAL EDUCATION**

*Bojana Babic*  
INVESTMENT TREATY CLAIMS CONCERNING ENVIRONMENTAL  
LAW CHANGES..... 617

*Eva Tomkova, E. Mikusova*  
ECO-LOGISTICS - CONNECTION OF ECOLOGY, ENVIRONMENT  
PROTECTION AND LOGISTICS..... 626



<i>Anja Basic, M. Velickovic</i> STAKEHOLDER BASED CLASSIFICATION OF SUSTAINABLE INDICATORS IN FREIGHT TRANSPORTATION.....	631
<i>Visnja Mihajlovic</i> DEVELOPMENT OF WASTE MANAGEMENT SYSTEM IN SERBIA – NOVI SAD WASTE REGION.....	638
<i>Natasa Bukumiric, A. Bozic, V. Alivojvodic, M. Stamenovic, S. Djarmati</i> CONTRIBUTION TO PHARMACY MANAGEMENT SYSTEM UNUSABLE DRUGS IN THE REPUBLIC OF SERBIA.....	643
<i>Cipriana Sava, G. Pinteala</i> ASPECTS REGARDING THE CERTIFICATION OF ROMANIAN ECOTURISM.....	650
<i>Aleksandra Bozic, N., Bukumiric, V. Alivojvodic, M. Stamenovic</i> IMPORTANCE OF WASTE MANAGEMENT AND ITS PLACE IN EDUCATIONAL SYSTEM OF THE REPUBLIC OF SERBIA.....	657
<i>Dina Maria Luț</i> ENVIRONMENTAL ASPECTS OF SUSTAINABLE DEVELOPMENT.....	663
<i>Nenad Stavretovic</i> PLAN FOR ESTABLISHING LAWNS.....	670
<i>Dejan Filipovic, G. Trbic, V. Secerov, I. Samardzic</i> THE ROLE OF SPATIAL PLANNING IN SERBIA ON ADAPTATION TO CLIMATE CHANGE.....	675
<i>Dejan Filipovic, M. Milincic, M. Pecelj</i> COMPETENCE OF LOCAL GOVERNMENT IN ENVIRONMENTAL PROTECTION – TOWARDS EU STANDARDS.....	682
<i>Mirjana Marinkovic, Lj. Ilic</i> EDUCATION FOR INOVATIONS AGAINST REBUILDING LANDSLIDES.....	688
<i>Nada Strbac, A. Mitovski, D. Zivkovic, M. Sokic, Lj. Balanovic, V. Grekulovic</i> COMPARATIVE REVIEW OF THE INOVATION STRATEGIES FOR THE E-WASTE MANAGEMENT.....	696
<i>Marko Velickovic, Dj. Stojanovic, D. Pantic</i> ENVIRONMENTAL PROTECTION IN GLOBAL LOGISTICS COMPANIES.....	703
<i>Slobodan Rakic, A. Kekez Kljajic, N. Raspopovic</i> SOIL PROTECTION POLICY – EU AND SERBIAN PERSPECTIVE.....	711
<i>Obrad Anicic, S. Jovic, B. Pejovic, Lj. Savic</i> MODELING AND SIMULATION COST-TIME PROFILE OF BUSINESS GREEN PROCESSES.....	718

<i>Velimir Komadinic, S. Manasijevic, R. Radisa</i> HOW TO INTEGRATE STANDARDIZED MANAGEMENT SYSTEMS.....	726
--	-----

#### ENVIRONMENTAL IMPACT ASSESSMENT

<i>Samir Nuric, A. Nuric, K. Gutic, M. Brcaninovic, H. Husic</i> EXPLOSION GASES AFTER BLASTING IN OPEN PIT MINE.....	732
--	-----

<i>Milan Milenkovic, V. Babic, V. Ducic, M. Krstic, B. Lazic</i> THE CONNECTION BETWEEN ARCTIC OSCILLATION (AO) AND THE FOREST FIRES IN MANITOBA PROVINCE (CANADA).....	740
---	-----

<i>Merita Borota, T. Rakocevic, A. Simic</i> IMPACT OF REGIONAL SANITARY LANDFIL "VRBAK" ON GROUNDWATER QUALITY.....	747
--	-----

<i>Aleksandar Nikolic, V. Vujacic, E. Nikolic, L. Pezo, T. Brandmajer</i> PRESENCE OF EXCESSIVE ENVIRONMENTAL NOISE – CASE STUDY MUNICIPALITY OF HERCEG NOVI.....	754
---	-----

<i>Irena Stefanovska, T. Mitev, E. Bozhinovska, K.A. Sackarska, A. Pavlov</i> ENVIRONMENTAL IMPACT ASSESSMENT OF ROAD CONSTRUCTION: A CASE STUDY OF CORRIDOR VIII, ROAD A2, SECTION RANKOVCE – KRIVA PALANKA, MACEDONIA.....	760
---	-----

<i>Sasha Petrushevska, D. Lazarevska</i> URBAN ENVIRONMENT NOISE ASSESSMENT.....	772
---	-----

<i>Danijela Stojadinovic, V. Domjan, N. Arsic</i> LEVEL OF RIVER WATER POLLUTION IN KRUSEVAC USING PROMETHEE METHOD.....	778
--	-----

<i>Jelena Majstorovic, M. Korac, S. Savkovic</i> THE IMPACT IN SITU OF GEOMECHANICAL INVESTIGATIONS ON EFFECTS OF THE ENVIRONMENTAL PROTECTION – ZAGRAD.....	785
--	-----

<i>Milan Milenkovic, V. Babic, V. Ducic, M. Krstic, B. Lazic</i> THE WATER TEMPERATURE TRENDS OF THE SAVA RIVER IN SERBIA.....	792
---	-----

<i>Biserka Dimishkovska, N. Dimishkovski, J. Dimishkovski</i> ATMOSPHERIC POLLUTERS RELEASED FROM INDUSTRIAL PLANTS FACTORS OF RISK PERTAINING TO CANCER.....	799
---	-----

<i>Saska Sekulic, K. Simeonov</i> METHODOLOGY FOR IMPACT ASSESSMENT OF HEATING PLANT ON THE ENVIRONMENT – EXAMPLE.....	806
--	-----

<b>Darko Drmanac</b> ROOF STRATA STRESS AND STRAIN INVESTIGATION WITH A VIEW TO EXPLORE TERRAIN SUBSIDENCE ABOVE THE MINING SITE AT POBRDJE BORATE ORE DEPOSIT.....	814
<b>Darko Drmanac, M. Ignjatovic, V. Cvetkovic, M. Dogandzic</b> THE IMPACT OF “POBRDJE” BORATE ORE MINING ON THE ENVIRONMENT.....	821
<b>Savo Perendic, J. Sokolovic, B. Stakic, D. Ciric</b> RECLAMATION OF MINE WASTE DUMP IN ANTHRACITE MINE „VRSKA CUKA“-AVRAMICA.....	828
<b>PREVENTIVE MEDICINE AND ECOLOGY</b>	
<b>Liljana Sokolova, K. Berenji, Z. Prijic, N. Djokic</b> THE PLACE THE MASS MEDIA IN PREVENTION OF OBESITY.....	835
<b>Boban Mugosa, D. Djurovic, M. M. Vrvic</b> ASSESSMENT OF ECOLOGICAL RISK INDEX AND NON-CANCEROUS HAZARD INDEX IN PLAYGROUNDS AND PARKS IN NORTHERN AREA OF MONTENEGRO.....	841
<b>Danijela Lukic, Lj. Torovic, S. Bjelovic</b> TOXICOVIGILANCE – WHAT DOES IT TELL US?.....	848
<b>Pero Sailovic, B. Rodic Grabovac, R. Djudjic</b> INFLUENCE OF TEMPERATURE ON OBTAINING BIOLOGICALLY ACTIVE CELLULOSIC FIBERS WITH BOUND CEPHALEXIN.....	856
<b>Angelica Calamar, G. A. Gaman, D. Pupazan, M. Kovacs, S. Simion</b> IMPACT OF CARBON MONOXIDE ON THE ENVIRONMENT AND HUMAN HEALTH.....	862
<b>Milka Glavendekic, G. Nakic, D. Kaseric, V. Popovic</b> SETAE FROM PINE PROCESSIONARY MOTH AND BROWN-TAIL MOTH CAUSE ALERGIES IN HUMANS AND ANIMALS.....	869
<b>AUTORS' INDEX.....</b>	877

This page is intentionally left blank



## NATIONAL ENTOMOLOGICAL MUSEUM AT FRUSKA GORA

Dejan V. Stojanovic<sup>1,2</sup>

<sup>1</sup>University of Novi Sad, Institute for Lowlands Forestry and Environment,  
Antona Cehova 13, 21000 Novi Sad, SERBIA

<sup>2</sup>National Park "Fruska gora", Zmajev trg 1, 21208 Sremska Kamenica, SERBIA

*dejanstojanovic021@yahoo.co.uk*

### ABSTRACT

The National Entomological Museum is a project of the management of the Public Enterprise National Park Fruška Gora which allows in a sustainable way and enriches in terms of content, the general availability of the institutions of science, environment protection, education and culture with strategic contents of general interest. The formation of the National Entomological Museum as an institution of culture would create a specific scientific and educational base of the Republic of Serbia, while museum depots would be used as guardians of national heritage and the deposited museum specimens would be used in the creation of activities of an educational and learning centre. The National Entomological Museum would be an attractive tourist destination of this region but also a unique space that would foster the development of knowledge and skills in this area as well as the training ground for improving entomological research in our country.

**Key words:** Entomological Museum, National Park Fruška Gora, Republic of Serbia.

The Public Enterprise National Park Fruška Gora has the capability and obligation to provide in the area which it manages a range of programs and projects of public interest without jeopardizing the sustainability of its operations. One of the projects which have the potential to expand and enrich the enterprise's current activities with useful features of common interest is the formation of the National Entomological Museum. This cultural institution would represent a specific scientific and educational base with the museum depots taking the role of the guardians of national heritage while the deposited museum specimens would provide the basis for creating various activities within its educational and learning centre. The National Entomological Museum would be an attractive tourist destination of the region which could also function as a unique place for fostering the development of new knowledge and skills as well as the training ground for improving the entomological research in our country.

The establishment of the Entomological Museum of the Republic of Serbia, its idea, realization, and concept, enables the implementation of all the complex tasks that it

would face through the sustainable resolution of complex issues addressed by this institution of science, education, and culture.

The history of the formation of museums in our country is related to the realization of teaching in the education of young naturalists but also to their unique educational content. The Natural History Museum, originally called *Jestastvenički muzej*, was founded in 1895, seven years after the death of Josif Pančić. However, the first collection of the Museum consisted of the specimens of plants, rocks, minerals, fossils and stuffed animals that Pančić and his students and followers had gathered for the Natural History Cabinet which was founded, again by Pančić, for teaching science at the Lyceum. These very objects became the nucleus around which many rich and diverse collections of the Natural History Museum were created as tangible witnesses of the composition, properties, and changes in the nature of Serbia and the Balkans.

Systematic scientific development of the collections which formed the initial core of the Museum started in 1853 when the Chair of Natural History was founded at the Lyceum and Pančić was appointed a professor under contract there.

From the Great School, the former Lyceum, natural history collections will be officially transferred to the Museum in 1901, according to the decision of the Minister of Education (in today's Natural History Museum [1] those collections are referred to as Historical Collections (of the Great School)).

In the explanation of his particular interest in the collection of the fauna of our country, Pančić writes: "In this double bond aspiration I collected, in addition to plants, also animals and minerals, and left it all to our conservatoire cabinet in the hope that it could sometimes provide the basis for the scientific topography of our principality to those who would like to commit themselves to this work. But, due to inadequate conservation and unskilled preparation of the skin of mammals and birds and natural products of these animals, a large amount of the collected material has become unusable". It should be added that many of Pančić's insect collections have been ruined, or become too unfit for scientific purposes due to various pests, primarily small butterfly *Tinea tapeziella* (whose larvae damage stuffed insects).

"Young men who start teaching in secondary schools, particularly those outside Belgrade, mostly enter empty schools – schools without a library and without sufficient equipment and collections, which are necessary for teaching natural history."

"In order to prevent the well-informed teachers from neglecting their education and to force those who are weaker to improve over time, schools should be provided with what they need to teach natural history: natural history books and collections."

"In addition to the libraries and collections, every school should have some equipment and tools which are necessary for the collection, preservation and conservation of natural things" [2].

Physical separation of this institution from the Museum of Natural History of the Republic of Serbia is necessary in order to focus on the issues of this complex and multifaceted scientific field, and more efficient and successful management of objectives, while avoiding the inevitable encounter with the problems of many other much smaller biological areas and their many interests. In a similar way the Museum of Contemporary Art is separated from the National Museum and the Entomological

Society of Serbia is separated from the Serbian Biological Society as is the case with entomology and biology as scientific disciplines.

Protected areas and national parks as the most important representatives of the preservation of wild plants and animals are authentic museums in the wildlife. The setting of this museum in the exterior is constantly changing and dynamic and an insight into its wealth is not readily accessible to nature lovers. During a visit to the protected area nature lovers usually find a limited or very scarce display of the hidden, upset and scared wildlife which cannot be observed carefully. Somewhat more representative display of the living world in these areas can be found on the official websites and presentations of the protected natural areas, but these settings can also be incomplete and aesthetically unadaptable, subjective and lacking data and information.

Too often, due to various forms of tourist use of these resources, protected natural areas experience negative and frequently fatal consequences that these factors have on their ecosystems. Entomological museums represent a tourist model which is safe, creative and multifunctional and which enables the observation of the biodiversity of a given ecosystem in a way which is completely safe, as far as tourist use is concerned, and without any negative impact on the ecosystems in the form of disturbing and endangering their wildlife.

The geographical position of Fruška Gora National Park provides an excellent destination for the Entomological Museum (which would be built within this protected area) as a representative tourist, learning, educational and cultural facility. Situated 15 kilometres from Novi Sad, the capital of the Autonomous Province of Vojvodina (350 000 inhabitants) and 80 kilometres from Belgrade, the capital of the Republic of Serbia (more than 2 000 000 inhabitants) it offers an optimum density of potential visitors.

The optimal position of the Entomological Museum of Fruška Gora National Park is enhanced by its location near the prestigious tourist facility (Hotel Premier Aqua) which provides maximum accommodation and the highest level of useful tourist services and resources.

The scientific contribution of this institution and its supporting activities and facilities would primarily take the form of acquainting our tourist, scientific and professional public with the importance of here presented, the biggest group of living organisms within the known living world. Our tourist offer would be enriched by providing the opportunity to pursue the knowledge and curiosity about the hidden and spectacularly attractive living world of the protected areas. Scientific and professional institutions and their staff would have an ordered and accessible institutional base for conducting scientific research, preparing and publishing scientific papers as well as creating and defining complex scientific objectives.

The contribution of the Entomological Museum of the Republic of Serbia to the area of education is manifold: pre-school children could, from an early age, become aware of and educated about the complexity, importance and criteria for the study and research of the world of insects. Presentation of knowledge in this field at this young age is a potential generator of many complex developments in the future that could have a significant applicative character.

The area of nanotechnology and the modern discoveries related to the origin of the structures and use of various materials which resulted from the research of these

complex organisms, their biochemistry, energy dependence, complicated sensuality, motor skills and characteristics of exoskeleton could provide an introduction to future progress and new global biotech revolution.

School children and youth would be stimulated towards the potential use of unlimited knowledge in this field in well-equipped rooms, through the presentations of various creative contents, lectures by eminent experts and training at the museum premises. Students and young talents could use the Entomological Museum of the Republic of Serbia as a base for the realization of study programs, various research projects, seminar, specialist, master and other theses as well as doctoral studies.

Schools and educational institutions across the country would have the opportunity to promote and educate children in creative workshops as well as in the exhibitions, laboratories, and offices of the museum where permanent displays could be visited by organized, pre-planned and pre-arranged groups. Special interactive lectures could be created periodically to teach and educate attendees on multiple topics which would be presented by eminent experts in this field from our country and abroad.

The cultural contribution of the Entomological Museum of the Republic of Serbia in the form of its communication with visitors, its aesthetic experience, numerous exhibitions and various cultural events would continually contribute to the civil and cultural advancement in general.

The question is how and in what way such a complex endeavour can be realized, what project and preliminary tasks stand in its conceptualization and what human and material resources are necessary for its implementation.

Developed and advanced countries, rich empires and kingdoms, royal legacies and collections of wealthy individuals and families, powerful republics and cities offered and allowed their citizens insights into the elaborate richness of their treasuries in order to satisfy the aesthetic, creative, cultural and other needs, but also as a form of personal promotion (showing their pride in being the noble selected promoters of science, education and culture). The treasures of Vienna, Milan, Bologna, the Medici family, the Vatican and other famous world museums are well known.

Naturally, being a small principality, later kingdom, and republic, Serbia aspired to be in a chosen company of the selected elite in this field. Learned Serbs travelled the world and upon return brought the stories of the beauty and wonders of the world. Listening to this, Serbian citizens initially wanted their children to experience the immensity and abundance of these experiences during their study and stay in these cities. The reality was that only a small segment of the wealthier population had the opportunity to experience the pleasure and cultural enrichment and share it with their loved ones, relatives, and fellow citizens. Exceptional individuals have permanently strived to enrich their people following the noble examples of these great civilizational traditions (e.g. king Milan Obrenović and his support of academician and naturalist Josif Pančić) and present their collected knowledge (possessions). As colonial masters, rulers and tyrants, the developed and powerful countries often enslaved and humiliated other peoples by stealing, plundering, destruction and other imperial and destructive methods, and enslaved and humiliated them by depriving them of these benefits. Due to the lack and denial of these benefits, many nations and countries have for centuries and until the present been forced to experience the intellectual dimension of knowledge exclusively in



the countries of the superior race, in the constant state of stagnation and overall subjugation.

The battle of the giants among us has lasted as long as the written or preserved history of our regions (if it is not saved, it was stolen in the above-mentioned way and deposited with the tyrants or occupiers). Striving for freedom, independence and cultural and educational emancipation has become the hallmark of the authentic, the progressive and the deprived.

Basic functional models of entomological museums are based on set operational tasks. These tasks are classified into 4 areas:

1. Creation and collection of valuable entomological specimens

The museum's entomological collection is created and updated, by collecting valuable entomological specimens, by accepting gifts, donations and presents or by purchase. In order to perform the identification of the museality of entomological specimens and evaluate their importance, it is necessary that the assessor is a competent entomologist. The criteria for the inclusion of entomological specimens in the museum treasure primarily results from the vision of the exhibition we want to implement. The selection of the collected entomological specimens from nature can be passive or accidental or else active as a product of previous research.

2. Storing entomological museum collections and other artifacts from this area

Collection as a composition of valuable specimens has a specific value and is stored with the highest security. A systematic collection functions as a comprehensive institution which is accompanied by a supporting documentation without which the collection has little value. Legacy, additional and deterministic label with all the required information is always an integral part of any entomological specimen. Museum specimens must remain in their original state without changing their colour or shape and must be protected from physical deterioration.

3. Extensive research of the collected values

A properly formed entomological collection is a significant facility for conducting extensive scientific research. Publication of works based on the samples deposited in an entomological collection of a museum significantly increases its value. Published papers inform us about the importance, relevance and informational value of entomological specimens within the museum collection. Scientific utilization of resources of entomological collections is directly evaluated and proportional to the citation index and the number of publications in which the role and importance of all the collection specimen were recorded.

4. Public activities in relation to the experiences and achievements of science and profession

Featured and recognized values of museum specimens from entomological museum collections which are installed as an integral part of human consciousness and cognitive spheres represent an outcome of successful museum communication. Detection and popular presentation of the findings related to museum items is the ultimate meaning

and purpose of any museum's existence. A museum is a sort of media centre whose main function is a mass transfer of information of popular, research, scientific, documentary, educational and entertaining character.

Presentations, publishing, and general educational activities as forms of a museum's communication process model its operations [3]. Theory of museum communications, which corresponds to the character of museum items, distinguishes three groups of information transfer:

1. It can be a presentation communication in which relations, communications or interactions are formed between visitors and the forms of exhibition presentation.
2. Communication in printed editions in the form of scientific, professional and popular publications. This type of communication supports the exhibition in the form of printed information in connection with the exhibition.
3. General communication which can be in the form of speeches, lectures, presentations, films, video files, photos, brochures, flyers, catalogues, and posters.

Article 27 of the *Law on Nature Protection* under "Protected natural areas" in section III "Protected natural areas" in the same rank with 1. Protected areas, and 2. Protected species, states as 3. Mobile protected natural documents [4].

In Article 37 of the Law, Mobile protected natural documents are defined as: Parts of geological and paleontological heritage, as well as biological documents which have high scientific, educational and cultural significance, can be protected as mobile protected natural documents.

The legislator further regulates in this area by dividing Mobile protected natural documents into four segments.

Under section 4). Mycological, botanical and zoological collections, as well as individual conserved preparations of organic species, and their holotypes and syntypes. The last note of this article reads: "It is forbidden to collect and / or destroy mobile natural documents as well as to destroy or damage their sites."

In Section IX "Procedure for designating protected natural areas", in Article 49 after the sub-heading in item 3. Mobile protected natural documents the legislator defines in the first sentence: "The geological, paleontological and biological documents which have been endangered in terms of this law, are recognized as protected natural areas by the minister in agreement with the minister in charge of protection of cultural heritage following the proposal from the Natural History Museum, on obtaining the opinion of the institute". In the same section, in Article 50, the legislator concludes that Protected natural areas are entered in the register, which may be 1. Central, 2. Provincial and 3. Register of mobile protected natural documents that is kept in the Natural History Museum. Registration and deletion of mobile protected natural documents shall be based on the act on establishing, proclaiming, on the previous protection or act on the termination of protection. The Ministry shall prescribe the content and manner of keeping registers of protected natural resources. Data from the register of protected natural resources are public [4].

Museums are specific documentation centres, in which significant data on the collected museum items are deposited, particularly in cases when particular biotopes on

legacy cards have been destroyed or irretrievably lost due to biotic and abiotic factors. In particular, sand area and wetland biotopes in Vojvodina plains have been irreversibly lost due to the implementation of melioration and land consolidation in the 1940s. The museums hold deposits of entomofauna, the inhabitants of many mikrobiotopa and biocenoses which are largely unreachable due to distance, inaccessibility or recent climate change. Collections are accumulation material and are as necessary as the library of publications that are not in constant use but must be available if needed. Collections of insect groups that are prepared for more valid taxonomic studies must be extended and possibly supplemented covering as large area or space as possible. Therefore, it is imperative that collections be united. It is also important that the museum be specialized because only in this way can all the strengths and resources be focused on the well-being, in this particular case, on the study of insects. The indeterminate and undefined material in entomological collections can be described as being in a sort of hibernation and is, for some time, practically unusable. A huge number of taxonomists carry out entomological research on the materials they themselves have gathered in their own field research. It is advantageous that all the stages in the development of the research are controlled by an expert, although the available time is not always sufficient for such an extensive scientific commitment. During monitoring and field research an expert collects (in relation to their own scientific work or collaboration with other professionals) the familiar, interesting or potentially scientifically profitable taxa and, while still on the field, makes mosaics of future laboratory research and, in relation to the scientific actuality, develops the ideas for the future scientific papers. That is the attraction of experts' field research: it is there, at the source of discovery, that their knowledge, accumulated over many years, comes to full affirmation. An expert will know when to collect a series of species which has a twin not faunally proven, in order to single out a related species from the abundance of material from a number of sites with different heights, climatic zones and vegetation systems. An expert will take care not to burden the collection with unnecessary multitude of items that require a large temporal and spatial potential to be primarily processed on the site and deposited in the database, which will take up the already limited space on the site and present problems during transport, in laboratory research (where they can significantly increase the volume of work), in making preparations, in the process of maceration or when depositing the permanent serial exhibition. The optimal utilization of time and space during field research with the limitation in covering a multitude of insect groups that often require completely different methodological approach while taking photographs of mikrobiotopa and exemplars and simultaneously taking samples of living material in various stages, presents a self-imposed global challenge, proportional to the scientific volume and eloquence of the researcher. Taxonomists practice the approach where they collect material during the growing season of the year and process and publish the papers and books during the winter period. The accumulation of this extensive material necessarily requires the involvement of a large number of specialists, experts capable of high-quality processing of materials. Paper [5], *The management of entomological research in protected areas in the Republic of Serbia*, partly covers this issue. It is necessary to surround experts with a multitude of young, well-educated associates who will work in competition and interaction with the aim to process the material deposited in the

collections, acquire the qualifications, inherit the knowledge and apply their new skills on processing groups that have not been processed in the Republic of Serbia. The value of a single well-processed museum group exceeds many times the equivalent number of items in a chaotic, haphazard collection. Many techniques of collecting, preservation, taxidermy, methodology and work with exhibits of insects are described in standard publications, manuals, and textbooks but they also represent the internal achievement of individual entomologists. Although insect collections and related specimens are the bases of taxonomic research, the information exploited on the basis of the preserved insects is often insufficient. Cultivation of individual insect species allows us to obtain information which significantly expands our current knowledge about them. Also, it is necessary to form a collection of all metamorphic stages, sexually dimorphic, aberrant and variable specimens. A collection of museum entomological material besides taxonomic, faunal and comparative morphological should allow ecologists, evolutionists and experts in related fields to observe the area from their perspectives and contribute to the general entomological exploration. Cultivating certain insects we come to the significant members visually extremely attractive in the subsequent food chains, parasitoids, parasites, hyperparasites and predators and their role and position in the balance of biocenosis in which they reside. A rich museum entomological collection of photographs and films through its complex contents rapidly enhances the level of communication to unprecedented dimensions. The contribution to the knowledge of the biological diversity of a geographical area or climate zone provided by a well-established entomological museum collection is immeasurable.

### **CONCLUSION**

A careful research and analysis of the situation in this area, leads us to several complementary conclusions:

1. Natural History Museum in Belgrade did not optimize the necessary communication with the visitors in order to present information on entomological museum items in its depots.
2. Entomological museum items within the collection of the Natural History Museum in Belgrade are not systematized, classified and determined.
3. There is no permanent entomological exhibition of the Natural History Museum in Belgrade.
4. Regarding its staff, the Natural History Museum in Belgrade does not have the capacity to provide an optimal response to the tasks ahead.
5. There are a number of entomological collections in the Republic of Serbia that are in a worse situation than the entomological collection (collections of Miloš Rogulja, Momčilo Zečević and others) of the Natural History Museum in Belgrade (the collection of Professor Konstantin Vasić at the Faculty of Forestry in Belgrade, the collection of butterflies of Stanko Radovanović in the Provincial Institute for Nature Conservation in Novi Sad and others).
6. There is no list of entomological collections in Serbia with a comprehensive list of museum items.

7. Extensive surveys of taxonomy, faunistic and comparative morphology cannot be realized with a dispersed, undefined and inadequately stored museum specimens. Correct classification is possible if adequate supplies of a large number of species are available for comparison.
8. It is necessary to optimize the promulgation of entomological values of the Republic of Serbia in all spheres. A national entomological museum which works responsibly on implementing its tasks is one of the main centres and zones of activity.
9. The National Entomological Museum should be one of the educational centres qualified for the dissemination of scientific and research achievements in entomology.
10. A comprehensive entomological collection of the National Entomological Museum, which is specialized, functional and operational, can be the driving force of a large number of activities of the Serbian Entomological Society, the Plant Protection Society of Serbia, the Serbian Biological Society with the aim to sustain the production of entomological staff and extensive entomological research in the Republic of Serbia, and be the pride and promoter of the national heritage of the Academy Committee for the Fauna of the Republic of Serbia.
11. The National Entomological Museum allows in a sustainable and enriches in terms of content the general availability of the institutions of science, environment protection, education and culture with strategic contents of general interest.
12. The National Entomological Museum as an institution of culture presents a particular scientific and educational base of the Republic of Serbia.
13. The depots of the National Entomological Museum would be the custodians of the national heritage and the museum items deposited in it would be used in the creation of activities of an educational and learning centre.
14. The National Entomological Museum would be a popular tourist attraction of this region [6,7,8,9,10].

#### ***Acknowledgement***

*This paper was financially supported by the Ministry of Education, Science and Technological Development of Republic of Serbia (Projects Nos. 173038 and III-43002).*

#### **REFERENCES**

1. Vasić, O., Niketić, M. (2015) Deo publikacije uz izložbu pod nazivom "Putovanje Josif Pančić (1814-1888)" Prirodnjački muzej u Beogradu, 2015. 1-62str.
2. Tatić, B., (1998). "Život i delo Josifa Pančića" Deo rezimea, iz knjige broj 11. Sabranih dela 1998. 11: 1-355.
3. Savić Aleksandra. (2012). Muzeji u javnosti, javnost u muzejima. Muzejski PR: savremeni pristup. Zavod za udžbenike. Beograd, 2012. 1-223 str.
4. Zakon o zaštiti prirode ("Službeni glasnik RS", br. 36/09 i 88/10)

5. Stojanović, D. V., Ćurčić, S. B. & Belij, S. (2013). Upravljanje entomološkim istraživanjima u zaštićenim područjima prirode republike Srbije. Plenarni referat. Simpozijum entomologa Srbije 2013. Tara, 18-22. septembar 2013. *Zbornik plenarnih referata i rezimea*, 5-11, Beograd.
6. Gari, Edson, Muzeji i etika. "Clio". Beograd, 2003. 1-378 str.
7. Deloš, B., Virtuelni muzej. "Clio". Beograd, 1996. 1- 129 str.
8. Krivošijev, V., (2011). Muzejska politika u Srbiji: Nastajanje, kriza i novi početak. Sažetak doktorske disertacije. Narodni muzej Valjevo. Valjevo, 2011. 291-317str.
9. Šola, T., K., Marketing u muzejima ili o vrlini i kako je obznaniti. "Clio". Beograd, 2002.
10. Žilber, K., Muzeji i publika. "Clio". Beograd, 2005. 1-129 str.



## POTENTIAL APPLICATION OF WASTE MATERIALS AS SORBENTS FOR PURIFYING RADIONUCLIDE AND HEAVY METAL LADEN WATER

Ivana Smiciklas

University of Belgrade, Vinca Institute of Nuclear Sciences,  
11000 Belgrade, SERBIA

*ivanat@vin.bg.ac.rs*

### ABSTRACT

The mining, industry and agriculture are the activities that contribute the most to the occurrence of contaminated effluents and increased concentrations of heavy metals and radionuclides in surface and ground water. At the same time, enormous amounts of solid waste is generated, accumulated and in need of further management. Accordingly, there is a growing interest in finding sustainable technological solutions to use one type of waste to treat or mitigate the negative effects of other waste types. This review summarizes the recent trends concerning the potential use of solid by-products and wastes in water purification technologies.

**Key words:** heavy metals, radionuclides, industrial wastes, separation, water purification.

### INTRODUCTION

The environment is constantly and increasingly exposed to pollutants of both organic and inorganic nature. While organic pollutants undergo degradation processes at different rates, persistence is one of the key factors considered in assessing the risks of heavy metals and some radionuclides. Ecological and human exposure to such pollutants is a long-term problem which draws special attention of the scientific community in all research fields. The term "heavy metals" is used for a group of metals and metalloids with atomic density greater than  $4 \text{ g/cm}^3$ , which can be classified into three different types including [1]: toxic metals (Hg, Cr, Pb, Zn, Cu, Ni, Cd, As, Co, Sn, etc.), precious metals (Pd, Pt, Ag, Au, Ru etc.) and radionuclides (U, Th, Ra, Am etc).

Heavy metals can contaminate water through both natural and anthropogenic sources, by atmospheric deposition, discharge or leaching of contaminated effluents. Typical heavy metals comes mainly from metal mining and smelter activities, production and application of pesticides, fungicides, fertilizers, paints, batteries, from welding, electroplating, paper industry, exhaust gas emission, etc., and they exhibit a variety of adverse effects on human health [2]. The discharge of radioactive contaminants can largely be attributed to regular operation of nuclear power plants and research reactors, and also to accidental releases, dismantlement of instruments containing radioisotopes, medical uses, above ground nuclear testing, and various natural sources [3].

Radionuclides in liquid radioactive waste (LRW) vary from TENORM - Technologically Enhanced Naturally Occurring Radioactive Materials (uranium, thorium and radium) to complex fission and corrosion products mixtures (Cs, Sr, Co, etc.). Many radionuclides are dangerous not only due to radioactivity but also due to chemical toxicity of typical heavy metals.

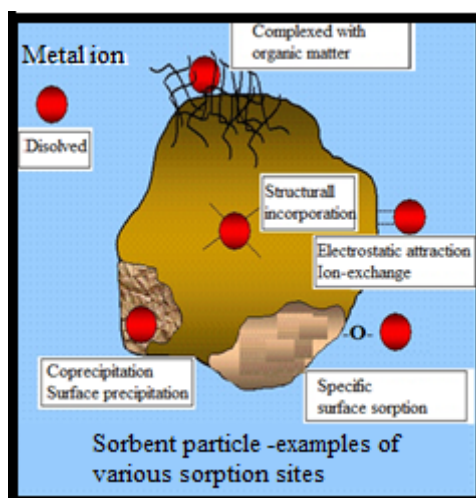
In contrast to communal wastewater, which nature and composition is relatively constant and predictable, industrial waste effluents exhibit extreme diversity in terms of chemical composition, concentration ranges, generated volumes, etc. [4]. As a result of such specificities, individual approach is required for the management of each waste stream and scientists are motivated to develop purification and extraction methods using a variety of techniques.

### **CONVENTIONAL WATER PURIFICATION VS. SORPTION PROCESSES**

Numerous chemical and physical processes for heavy metal and radionuclide removal from contaminated water have been well established and applied over the years. Such conventional processes include chemical precipitation, membrane filtration, ion-exchange, reverse osmosis, electrodialysis, solvent extraction, evaporation, oxidation and activated carbon adsorption [2, 3, 5]. Among them, chemical precipitation, based on pH adjustment, is the most widely applied approach for the separation of metal ions. However, even though they are in use, conventional methods exhibit many disadvantages, such as low selectivity, high consumption of chemicals and energy, generation of large amounts of sludge or residues for disposal, and finally - high overall costs. At the moment, all technologies show some advantages and some disadvantages, and their applicability is being evaluated on a case-by-case basis. For some waste streams, the application of several consecutive or simultaneous treatment steps is necessary in order to gain the recommended or maximum permissible concentrations/activities for the safe release of treated effluents. Consequently, the alternative treatment processes are constantly tested, in order to overcome the existing problems.

By definition, adsorption is a mass transfer process by which a substance from the liquid phase is transferred to the surface of a solid phase [6]. In aqueous solutions, the mechanisms of substance binding to solid surface can be very complex and may occur through physical and/or chemical interactions. Thus, more general term "sorption" is often in use for the processes at solid/liquid interface, as it covers different interactions types (Fig. 1).





**Figure 1.** The possible sorbent-metal interactions

The research of the extent and the nature of a particular sorption process is of a fundamental importance, and represents a first step towards practical implementation. The mathematical modelling of sorption isotherms, kinetic, and thermodynamic data, as well as desorption and leaching studies, give basic information about the nature of the process. Furthermore, microscopic and spectroscopic analyses are being employed for the investigation of the material structures on the local atomic scale [7,8]. Based on both the macroscopic indicators and the evidences gained at the microscopic level, the conclusion on the mechanism of heavy metal/radionuclide sorption can be reached, and these findings affect the potential applicability of the process.

Physical sorption is a reversible process, while chemisorption is a result of the chemical interaction between the solid surface and the metal ion, thus it is largely irreversible [6,7]. Both the reversible and the irreversible types of interactions can be beneficially used. For example, sorbents which may be regenerated are more suitable for the treatment of waste water in batch and column systems, while sorbents at which surface pollutants are bounded irreversibly are candidates for the construction of engineered barriers beneath an around the nuclear waste processing facilities and repositories [9], and for the permeable reactive barrier systems (PRBs) for the protection of ground water quality [10].

With regard to conventional heavy metal/radionuclide removal methods, the main advantages of the sorption processes are high and tunable selectivity, high purification efficiencies even at very low initial concentrations of pollutants and relatively low cost. Moreover, the general flexibility of the process design ensures the application in batch conditions, flow systems, or in conjunction with other purification methods. On the other hand, the main drawbacks associated with the sorption technologies are the issues with sorbent and metal recovery, disposal following the exhaustion of sorbent capacity, and the total costs which are very difficult to estimate.

Some important adverse characteristics and limitations can be overcome by using waste materials as sorbents.

### SORBENT MATERIALS: COMMERCIAL VS. WASTE DERIVED

The most common sorbent applied in water purification systems is activated carbon (AC), due to the large micro- and mesopore volumes and high surface area. However, the sorption of heavy metals and radionuclide ions onto the surface of AC is non-specific, therefore, AC is not particularly effective and selective material. Moreover, the sources of coal-based AC are running out resulting in the increased price of the commercial products. As a consequence, there is a huge trend in converting carbonaceous waste materials into AC for heavy metals removal [11]. In general, in the field of water purification technologies, searching for effective and economical sorbents has become a main research challenge. So-called “low-cost” sorbents were explored among largely available naturally occurring minerals such as zeolites, clay, and diatomite [12]. These inorganic sorbents are locally available, effective even in their raw form or following minor processing, and very selective towards heavy metal or radionuclide ions [13,14]. However, in accordance with the resources saving policy in the European Union and with the European directives on waste, an alternative to excavation and use of non-renewable virgin minerals is – utilization of waste materials as sorbents.

At the moment, the research focus has been relocated to possible valorization of waste materials and by-products of different branches of economy such as the agriculture and various industries (Table 1).

**Table 1.** The origin of the waste and by-product materials most studied as low-cost sorbents for heavy metals and radionuclides [12, 15-17]

Major groups of waste sorbents	Waste types
Waste bio-materials	<i>Agricultural</i> Coffee husks, tea factory waste, sugar beet pulp, waste pomace of olive oil factory waste, grape stalk wastes, potato peels, sawdust, citrus peels, cashew nut shell, etc.
	<i>Animal</i> Animal bones, eggshell, seashell, crabshell, etc.
Industrial wastes	Coal fly ash, blast furnace sludge, waste slurries, lignin, iron (III) hydroxide, red mud, waste biogas residual slurry, etc.

Usability study of a waste begins on a laboratory level, by determining its chemical composition, crystal structure, content and type of organic matter, particle morphology, specific surface area and porosity, surface functional groups, radioactivity, pH, solubility, leachability of potentially hazardous substances, etc. Along with the physicochemical characterization, the potential toxicity of the waste itself is being evaluated. Preliminary sorption studies include the batch and/or column experiments at different experimental conditions (concentration of pollutants of interest, solid/solution

ratio, contact time, temperature, presence of coexisting cationic and anionic species, etc.), as well as the recovery of metal ions and the enhancement of sorbents capacity through its modification [2].

The basic requirements that a waste material sorbent must fulfill are [2,3,16]:

- chemical stability in a wide range of wastewater parameters,
- availability in large quantities, locally, and at low price,
- high sorption capacity as well as selectivity for heavy metals/radionuclides,
- ability to reduce metal concentration to very low levels such as drinking water standards,
- possibility of regeneration/safe disposal after saturation,
- cost-effectiveness of the overall sorption process compared to alternative processes.

The two most important factors for economical feasibility are efficiency and cost of the sorbent. Sorption capacity depends on many process conditions and it is evaluated in relation to the capacity of commercial sorbents. A review of low-cost sorbents' capacities towards typical heavy metals and radionuclides is presented in Table 2. The effectiveness and potential of the heavy metal removal is highly dependent on the type of the metal, sorbent used and the nature of the waste water treated. Still, it is evident that, compared to commercially available sorbents (activated carbon, zeolite, bentonite), certain types of waste or their treated/activated forms reach many times higher capacities.

The cost of sorbent depends on its availability, the required processing and treatment conditions, as well as the recycling costs and the overall lifetime. Although the expected costs are rarely reported in the literature, the rough estimates show that various waste materials such as fly ash, waste baggase fly ash, blast furnace waste, waste metal sludge, carbonaceous sorbents (fertilizer and waste metal sludge industry waste) cost  $\leq 0.1$  US\$ per kg [16]. On the other hand, commercial activated carbons normally cost  $> 3.0$  US \$ per kg. Therefore, low-costs of waste sorbents, and many times higher sorption capacities, make them promising materials. Particularly interesting sorbent (ApatiteII<sup>TM</sup>) with superior power of sorption of a large number of toxic metals (Pb, Cu, Zn, Cd, ...) and radionuclides (U, Pu, Am, Sr ...) is obtained from fish bones (Patent Number 6,217.77 [18]). This phosphate (apatite) based material exhibits huge application possibilities (waste water treatments, radionuclide immobilization, remediation of acid rock drainage and diary lagoons, ground water protection, etc.), and, depending on the ordered quantities, costs  $> 1.1$  US \$ per kg.

### **THE KEY RESEARCH CHALLENGES AND FUTURE PROSPECTS**

Despite of numerous research studies proving effectiveness of waste sorbent materials, huge market size and needs for such materials, significant commercialization of heavy metal sorption by waste materials is still missing. The issues associated with the commercialization of any technological innovation (technical, regulatory, financial issues and the overall lack of the interest and awareness of the potential beneficiaries) lie behind the unsuccessful process utilization on a large scale. For the future of waste

material inclusion in heavy metal and radionuclide separation from aqueous media, two promising directions are being highlighted [1]: development of hybrid technologies for pollutants removal, and practicing the “partnership” approach, i.e. establishing connections between solid waste generators and the generators of contaminated effluent, for synergic waste management.

To increase the application potential of waste derived sorbents, future research should address: estimation of the potential risks associated with the material application, including a long term studies, optimization of treatment conditions for the improvement of metal uptake, evaluation of exact sorption mechanisms, optimization of conditions for sorbent regeneration and recovery of heavy metals/radionuclides, optimization of methods for safe disposal of the metal-laden waste, raising awareness of waste generators about the possible beneficial applications.

**Table 2.** Sorption capacities of various sorbents materials [13, 15-17, 19-21]

Pollutant	Sorbent	Maximum sorption capacity (mg/g)
Zn(II)	Bentonite clay, commercial	43.16
	Blast-furnace slag	103.33
	Cashew nut shell, modified	455.7
Pb(II)	Activated carbon, commercial	5.90
	Rose petals waste, unmodified	119.92
	Fly ash, unmodified	444.7
	Orange peel, modified	476.1
Ni(II)	Activated carbon, commercial	6.1
	Orange peel, unmodified	62.3
	Red mud	160.0
	Cashew nut shell, modified	465.30
Cd(II)	Activated carbon, commercial	0.70
	Coal Fly ash, unmodified	18.98
	Banana waste, unmodified	67.2
	Orange peel, modified	293.3
	Cashew nut shell, modified	436.7
Cu(II)	Blast-furnace slag	133.35
	Orange peel, modified	154.9
As(V)	Kaolinite, commercial	0.23
	Coconut coir pith, modified	13.75
Cr(VI)	Activated carbon, commercial	4.72
	Fly ash	23.86
	Rice Husk Ash	25.64
	Coir pith, unmodified	165.00
Co	Zeolite, commercial	2.93
	Arca shell, modified	11.53
	Animal bones, modified	29.15
	Red mud, unmodified	30.62
Sr	Zeolite, commercial	9.8
	Red mud, unmodified	27.15
	Animal bones, modified	34.86

## CONCLUSION

Management of heavy metal and radionuclide laden water by waste sorbent materials is potentially both effective and economically beneficial approach. This strategy has considerable advantages over commercially available sorbents, and contributes to the overall waste minimization. A detailed assessment of benefits in respect to competing technologies is needed, particularly for metal-plating and metal-finishing operations, mining and ore processing operations, metal processing, battery and accumulator manufacturing operations; thermal and nuclear power generation.

## *Acknowledgement*

*This work was supported by the Ministry of Education Science and Technological Development of the Republic of Serbia (Project III43009).*

## REFERENCES

1. Wang, J. Chen C., 2009. Biosorbents for heavy metals removal and their future. *Biotech. Adv.*, 27, 195-226.
2. Abas S.N.E, Ismail M.H.S, Kamal M.L., Izhar S, 2013, Adsorption process of heavy metals by low-cost adsorbent: A review, *World Appl. Sci. J.*, 28, 1518-1530.
3. IAEA-TECDOC-1336, 2003, Combined methods for liquid radioactive waste treatment, IAEA, Vienna.
4. Wang L.K., Chen J.P., Hung Y., Shamma N.K., 2009, Heavy metals in the environment, CRC Press, Technology & Engineering, 516 pages.
5. Akpor O. B., Muchie M, 2010, Remediation of heavy metals in drinking water and wastewater treatment systems: Processes and applications, *Int. J. Phys. Sci.*, 5, 1807-1817.
6. Artioli Y., 2008, Adsorption, *Encyclopedia of Ecology*, Academic Press, Oxford, 60–65.
7. Brown, G.E., Parks, G.A., 2001, Sorption of trace elements on mineral surfaces: modern perspectives from spectroscopic studies and comments on sorption in the marine environment. *Int. Geol. Rev.*, 43, 963-1074.
8. Bruce D.W., O'Hare D., Walton R.I., 2013, Local structural characterisation: inorganic materials series, Willey, UK, 380 pages.
9. IAEA-TECDOC-1255, 2001, Performance of engineered barrier materials in near surface disposal facilities for radioactive waste, IAEA, Vienna.
10. EPA/600/R-98/125, 1998, Permeable reactive barrier technologies for contaminant remediation, US EPA, Cincinnati, Ohio.
11. Dias, J.M., Alvim-Ferraz, M.C.M., Almeida, M.F., Rivera-Utrilla, J., Sanchez-Polob, M., 2007, Waste materials for activated carbon preparation and its use in aqueous-phase treatment: a review, *J. Environ. Manage.*, 85, 833-846.
12. Fu F., Wang Q., 2011, Removal of heavy metal ions from wastewaters: A review, *J. Environ. Manage.*, 92, 407-418.

13. Smičiklas I., Dimović S., Plećaš I., 2007, Removal of Cs<sup>1+</sup>, Sr<sup>2+</sup> and Co<sup>2+</sup> from aqueous solutions by adsorption on natural clinoptilolite, *Appl. Clay Sci.*, 35, 139-144.
14. Šljivić M., Smičiklas I., Plećaš I., Pejanović S., 2009, Comparative study of Cu<sup>2+</sup> adsorption on a zeolite, a clay and a diatomite from Serbia, *Appl. Clay Sci.*, 43, 33-40.
15. Nguyen T.A.H., Ngo H.H., Guo W.S., Zhang J., Liang S., Yue Q.Y., Li Q., Nguyen T.V., 2013, Applicability of agricultural waste and by-products for adsorptive removal of heavy metals from wastewater, *Biores. Technol.*, 148, 574-585.
16. Ahmaruzzaman M., 2011, Industrial wastes as low-cost potential adsorbents for the treatment of wastewater laden with heavy metals, *Adv. Colloid Interface Sci.*, 166, 36-59.
17. Kurniawan T.A., Chan G., Lo W., Babel S., 2006, Comparisons of low-cost adsorbents for treating wastewaters laden with heavy metals, *Sci. Total Environ.*, 366, 409-426.
18. [www.pimsnv.com](http://www.pimsnv.com)
19. Smičiklas I., Dimović S., Šljivić M., Plećaš I., Lončar B., Mitrić M., 2010, Resource recovery of animal bones: study on sorptive properties and mechanism for Sr<sup>2+</sup> ions, *J. Nucl. Mater.*, 400, 15-24.
20. Dimović S., Smičiklas I., Plećaš I., Antonović D., Mitrić M., 2009, Comparative study of differently treated animal bones for Co<sup>2+</sup> removal, *J. Hazard. Mater.*, 164, 279-287.
21. Milenković A., Smičiklas I., Marković J., Vukelić N., 2014, Immobilization of Co-60 and Sr-90 ions using red mud from aluminum industry, *Nucl. Tech. Radiat.*, 29, 79-87.



## LOGISTICS OPERATORS IN WASTE MANAGEMENT IN THE REPUBLIC OF SERBIA

Djurdjica Stojanovic<sup>1\*</sup>, V. Knezevic<sup>2</sup>

<sup>1</sup>University of Novi Sad, Faculty of Technical Sciences,  
Trg D. Obradovica 6, Novi Sad, SERBIA

<sup>2</sup>Sabacki put 3, Loznica, SERBIA

\*[djurdja@uns.ac.rs](mailto:djurdja@uns.ac.rs)

### ABSTRACT

The paper objective is to explore and reveal the role and importance of logistics services and operators in waste industry. Reported practice in the Republic of Serbia, as well as some experiences of other countries is presented. The focus is on strategic level of waste logistics and usage of logistics service providers in waste management. The research goal is to contribute to a general picture about the role of logistics in waste industry in the Republic of Serbia. Presented results highlight the crucial importance of logistics in waste industry and make a ground for further research and policy measures.

**Key words:** Waste logistics management, Waste industry, Logistics providers, The Republic of Serbia

### INTRODUCTION

Beside its crucial importance for environment and human health, waste industry has an important economic aspect. It opens the opportunities for new enterprises, new jobs, increasing the volumes of sales and income [1]. The main processes in waste management are collection, transport, recycling/reusing, treatment and disposal [2]. More detailed processes description may include separation (sorting) and collection, transport, temporary storage, transfer, recycling/reuse, treatment and final disposal as the elements of waste management system. The later description also indicate that four out of seven processes are clearly logistic processes and activities, while other ones involve internal logistics in waste flows in order to perform core business process (in direct flows also called "plant logistics"). This fact indicates a vital importance of logistics in waste management.

The paper objective is to explore the current state in waste logistics and to recognize the role and importance of logistics services and operators in waste industry. For that purpose, we used available literature with reported practice in both high and low income countries and a case study of Serbia. The later includes the analysis of a database about logistics providers, who have obtained the licenses for waste logistics operations in

the Republic of Serbia. The research goal is to contribute to a general picture about the role of logistics services and operators in waste industry. The research is concerned with the popularity of particular logistics services, tendency to bundle the services and the investigation how much logistics operations tend to be outsourced among enterprises which main activities are non-logistics operations - i.e. treatment, recycling/reusing and disposal. Thus, the focus is on strategic level of logistics management within waste management.

The paper is organized as follows. In the second Section, an overview of logistics actors and operations in waste logistics is given. Already recognized importance of waste logistics is pointed out, particularly in low and middle income countries. The main data about waste, waste management and waste operators in Serbia are also presented. In the third Section, the research methodology is given. Main research results and discussion are in the fourth and fifth Sections respectively. The last Section contains final remarks and conclusion.

## **WASTE LOGISTICS AND LOGISTICS PROVIDERS**

### *A literature review*

One of the widespread characteristics of modern civilization is a significant and uncontrolled growth in the quantities of generated waste. As one of the responses to this urgent situation, the most developed countries have already defined the concepts of "zero waste cities", which assumes waste prevention and 100% recycling rate [3]. There are also the first records about successful steps toward waste prevention and communal waste decreasing in practice, not only in most developed countries, but also in the Balkan countries (e.g. see [4], [5], [6] etc.). Zero waste means minimizing waste generation, but also recycling the most of generated waste, which further implies new material flows and, consequently, a need for more complex and efficient waste logistics. In December 2015, European Union adopted a very ambitious plan toward new Circular Economy Package to support all business parties and consumers in transition toward more circular and more sustainable economy.

Still, waste logistics entities and operations are not much explored in the literature, particularly in developing countries. In a few available papers, authors point out the vital importance of logistics in waste management (e.g. in [7]). Some experts notice that collection and transportation within the system of municipal solid waste management may account more than 60% of the overall budget [8], while some other authors point out that such costs may reach up to 85% of the total expenditure on waste management in India [9].

Both public and private sectors are active in waste management. In developing countries, there is an emerging trend in encouraging private sector to enter into solid waste management operations. Some authors recognize several important kinds of private sector operators in developing countries [10]: waste pickers, waste buyers, small and medium enterprises involved in recycling industry, large-scale operators in recycling industry, community-based organizations, non-governmental organizations and for-profit micro-enterprises. According to this classification, logistics operators may be among



waste pickers, and micro-enterprises which deliver services, though their role is not clearly pointed out in the research. Other actors, which main business is not logistics, may also own transport fleet, transfer or storage waste facilities. The enterprises from public sector, usually responsible for municipality waste, also use to have own-account transport capacities and transfer stations. As a rule, municipality is responsible at least for a part of the infrastructure and equipment for collection, transport and transfer of household waste.

Informal sector may be developed particularly in primary collection and sorting. It is applicable in both developed and developing countries. Still, in developing countries, the significance of informal sector is often higher [10]. The reasons for significant role of grey economy in such countries lay in poorness, unemployment or underemployment.

Further, in low and middle income countries, waste logistics systems are often characterized by improper collection systems [11], poor route planning, lack of information about collection scheduling [12], which implies suboptimal solutions in scheduling, insufficient infrastructure [13], poor roads, old and insufficient transport fleets for waste collection [14] and, consequently, a decreased efficiency, increased transport and logistics costs and increased environmental impact.

Thus, identification of a current state and practices is the first step toward development of a sustainable and efficient waste logistics and, consequently, overall waste management.

Waste flows may be realized with own-account capacities and by using external sources - logistics service providers. This is recognized as one of the most important and for decades-long trends in logistics - logistics outsourcing. Logistics outsourcing may be defined as using external firms to perform activities which could be, or have been, performed in house [15]. It is considered as a strategic decision. The main reasons for logistics outsourcing are cost reduction, service improvement, operational flexibility, or business focus on core competency [16]. Similarly like in traditional supply chain flows, waste operators may perform one or more logistics operations.

There are not much evidence about the practice related with logistics outsourcing in waste industry. According to the available literature, both own-account fleet and third parties may be used to collect different kind of waste. Public-private partnerships (PPP) is a significant mean for modernization of Municipal Solid Waste Management (MSWM) in both transition economies and in EU member states. The modernization of MSWM assumes four aspects [17]: the modernization of vehicles and equipment, the construction of sanitary landfills to EU standards, the adoption of integrated and holistic MSWM strategies and the regionalization of collection and transport services. These aspects are strongly interdependent. For example, it is prohibitively expensive to transport uncompact waste over long distances to a new regional landfill with old and low capacity trucks. The recent practices has recorded that the investment into transport fleet renewal and the management of logistics operations is often transferred to the private sector within PPP (*ibid.*), which is also a kind of "soft outsourcing".

The European Green Dot concept, developed from German recycling organization Duales System Deutschland (DTD), assumes that the obligation of the

packaging manufacturers and distributors to take back used packages and to arrange its reuse or recycling, can alternatively be transferred to a third party [18]. Today such party may be provider who offer a range of services, from basic logistics activities to developed integrated, customized waste management solutions. In the UK, commercial waste is collected either by a national or local contractor, by the local authority, where they offer such a service, or in-house, using the business' own vehicles; in some cases, commercial waste may be taken, often illegally, to household waste recycling centres [19]. Only few papers consider outsourcing of reverse logistics services in extended supply chains, related both with recycling and waste flows in specific industries (e.g. in high tech industry, in [20]).

Some authors recognize that service providers' support to the system is among the key elements for the efficiency of the collection, transfer and transport of solid waste [21].

### ***Waste logistics and operators in Serbian waste industry***

The waste industry is relatively new economy branch in Serbia. Still, the recently estimated annual turnover at waste market in Serbia is almost 1 billion EUR a year [22]. The waste volume in the Republic of Serbia is still hard to estimate. The main reason is a lack of comprehensive and historically developed database on waste and, consequently, a lack of qualitative and quantitative analysis. The collection of communal waste records an increase from 60 % in 2007 to 80% of population in 2013 [23]. A rest of communal waste is still disposed or incinerated without control. The recent public reports also reveal a slight decrease of generated communal waste - from 2.71 to 2.41 million tons [6] and generated special waste in last few years [24]. According to available data, about 8.7 million tons of waste was generated in the Republic of Serbia in 2013, of which less than 6% is hazardous waste. Only for 26% of totally generated waste, producers reported how they handled with this waste. Approximately 13% of waste is temporarily stored in the warehouse of another plant, 10% is given to operators to be reused/recycled and 2% to be deposited, while 1% is exported by producers [6]. The recycling industry is, depending on the product, processing less than 20% of the available waste, while the waste is even imported to serve local industry in some cases [22]. In 2013, the administration collected about 87 million EUR for environmental (recycling) taxes, and at the same time it was supposed to spend some 16 million EUR for various incentives (*ibid.*).

In the Republic of Serbia, a traditional way of waste management is still dominant, characterized by low level of primary selection, sorting and recycling. To reach the environmental standards of European Union (EU), Serbia needs approximately 5 billion euros for the big infrastructure investments in the field of waste and waste water management. These funds should be obtained mainly from EU, and from national, provincial and local governments. The investments into the infrastructure for treatment, disposal and recovery, as well as secondary industry which use the products of recovery, should bring out 20.000 new jobs [22]. Due to increasing waste volume and cost of municipal solid waste management, the Serbian Government has adopted the strategy to promote PPP [25]. That means that public utility can use legal or natural persons to provide logistics services or invest into modern facilities and infrastructure [26]. In the

praxis, the share of private partners is related with both big investments and non-logistics operations (e.g. The City of Belgrade wishes to develop the waste treatment and disposal facilities through a long-term PPP model, see [27]), and with logistics service, which may include the renewal of transport fleet, collection and transport ([26], [28]).

The short-term and long-term national goals related with the database and network infrastructure development has been defined in The National Strategy on Waste Management in the Republic of Serbia [25] and they mostly implicitly regard with waste logistics. However, the first experiences reveal that, once when the waste infrastructure network is developed, the success in covering operations costs strongly impact on successful implementation of adopted EU standards in the practice. Therefore, it is important to recognize the importance of logistics operations into the planning projects on time and develop efficient mechanisms which support a development of good practice.

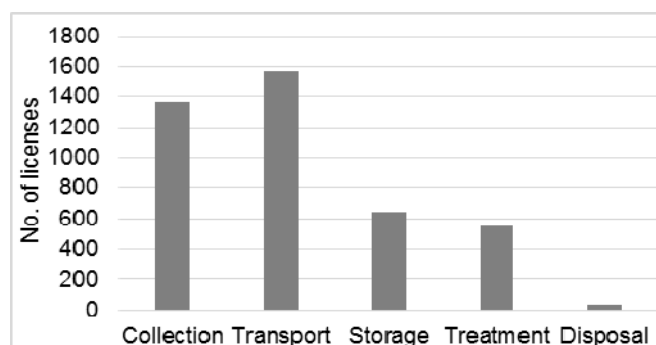
Formally, only operators with the licenses for waste management are allowed to perform the business in waste industry sector. The national, provincial and city governments give the licenses to operators who wish to operate in waste industry and meet required standards. The licenses may cover single operations, i.e. collection, transport, storage, treatment (including recycling) and disposal, or be related with several operations ("integral licenses"). Some recent research reveal that the licenses related with logistics operations prevail among the issued licenses ([29], [30]). This fact, coupled with a scarce literature about the importance of logistics in waste management, inspired us to explore more in-depth a current role of logistics providers in waste industry in Serbia. The informal sector in collection and transport also exists, but its role will not be considered here.

## **METHODOLOGY**

We explored a comprehensive database about operators which obtained legal permissions/license for waste management. The focus was on the licenses which are valid for 2015. The operators have obtained either long-term licenses which are still valid in 2015, or they have started to be valid in 2015. The database is published in February 2015 by the Environmental Protection Agency, which belongs to the Ministry of Energy, Development and Environmental Protection [6]. Additionally, we used the historical database for the period 2010–2012 about registered operators, from the same source, to compare the number and types of issued licenses in both periods and identify changes, if they exist. Obtained data are systematized in Excel worksheets, and used for statistical analysis and graphical presentations.

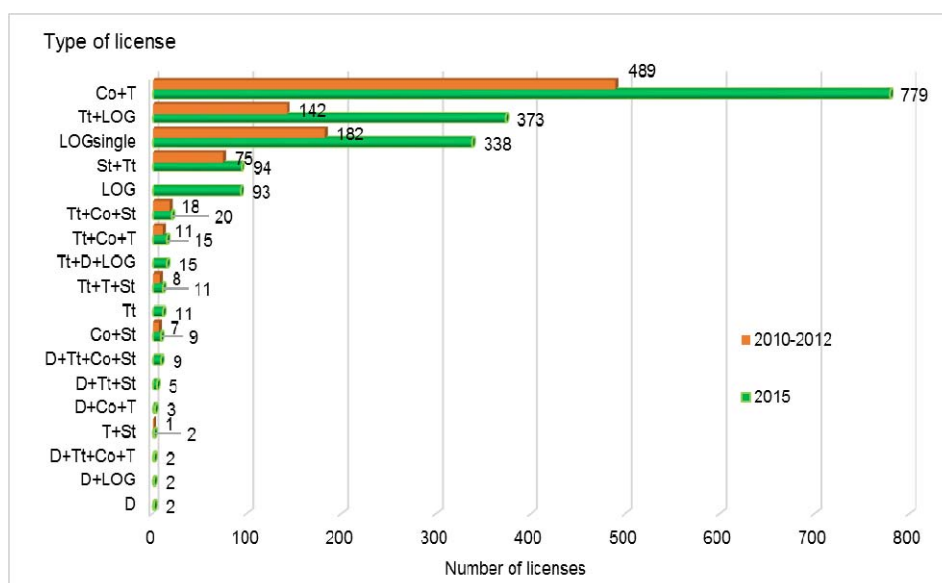
## **RESULTS**

In total, 1783 operators have got the licenses to join the waste industry market in the Republic of Serbia in 2015. For each operation in waste management, operators have to obtain permission separately. Figure 1 shows for which operations operators have been interested to obtain the licenses, i.e.: collection, transport, storage, treatment and disposal. The licenses for enterprises can be integral, which means to cover the permissions to perform several operations.



**Figure 1.** Operations covered by waste management licenses in 2015

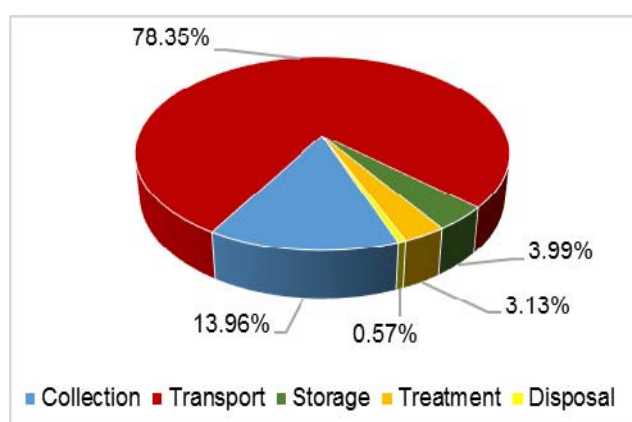
Comparing the number of operators and the number of operation licenses, it can be noticed that operators use to request integral licenses, for two or more operations. Figure 2 shows the number of operators/licenses per type of license in the period 2010–2012 and in February 2015. The licenses for single operations are Tt - treatment, D - Disposal and LOGsingle - summarized single-operation licenses for three logistics operations: collection, transport and storage. The rest of presented licenses are integral, i.e. cover more than one operation. The total sum of all licenses per year is equal to the number of operators in the market in given periods.



**Figure 2.** The number of operators/licenses in the period 2010-2012 and in February 2015 per type of license: Co - collection, T - transport, St - storage, LOG - all logistics operations, collection, transport and storage, LOGsingle - single-operation licenses for all three logistics operations, Tt - treatment, D - Disposal

Again, in both cases we used the database of the Environmental Protection Agency, published regularly on the official website. It can be noticed that the newer database is more comprehensive, cover more data about the operators' licenses structure and covers one year, instead of two years. For example, the database for 2010–2012 has not contained any data about disposal licenses. An increase of number of licenses can also be noticed for all types of licenses, sometimes very significant for so short time period.

To gain more insight into the characteristics and aspirations of waste operators, we have further explored the operators' interest for single operation licenses. Figure 3 shows the main results. Only 351 operators out of 1783 (19.69%) have the licenses for only one operation within waste management, and logistics licenses are dominant over the treatment and disposal ones. Out of 351 single-operation licenses, 78.35% are transport licenses, while less than 4% of operators are licensed only for treatment of disposal, which are basically non-logistics waste operations.



**Figure 3.** The structure of single-operation waste licenses

Table 1 shows the structure of licenses only for logistics operations. In addition to the single operation logistics licenses, eleven operators are licensed only for treatment and two only for disposal activities.

**Table 1.** The number of logistics providers - operators which obtained licenses only for logistics operations

Single-operation licenses			Integral licenses				Sum
Collection (Co)	Transport (T)	Storage (St)	Co+St	Co+T	T+St	Co+T+St	
49	275	14	9	779	2	93	1221
4.01%	22.52%	1.15%	0.74%	63.80%	0.16%	7.62%	100.00%

Finally, it was also explored how much is developed the logistics services diversity among logistics providers. The number of single and integral licenses obtained by logistics providers is presented in Table 1. It can be noticed that the share of integral

licenses for collection and transport highly prevail among operators (63.80%), and they are followed by transport licenses (22.52%). Other kinds of single or integral licenses are significantly less presented and all together have a share of 13.68%. A whole package of integrated logistics services (collection, transport and storage) offers less than 1% of providers (0.74%).

Five hundred and forty-nine firms (30.79%) perform treatment, disposal or both of these operations and 71.03% of them have the licenses to also perform the whole package of logistics operations - collection, transport and storage (Table 2, the next-to-the last column).

**Table 2.** Insourcing logistics services in waste management - the operators who perform Tt, D, and types of their logistics service(s)

<b>Tt+Co</b>	<b>Tt+T</b>	<b>Tt+St</b>	<b>Tt+Co+T</b>	<b>Tt+Co+St</b>	<b>Tt+T+St</b>	<b>Tt+LOG</b>	<b>Sum</b>
0	0	94	15	20	11	373	513
0.00%	0.00%	18.32%	2.92%	3.90%	2.14%	72.71%	100.00%
<b>D+Co</b>	<b>D+T</b>	<b>D+St</b>	<b>D+Co+T</b>	<b>D+Co+St</b>	<b>D+T+St</b>	<b>D+LOG</b>	<b>Sum</b>
0	0	0	3	0	0	2	5
0.00%	0.00%	0.00%	60.00%	0.00%	0.00%	40.00%	100.00%
<b>D+Tt+Co</b>	<b>D+Tt+T</b>	<b>D+Tt+St</b>	<b>D+Tt+Co+T</b>	<b>D+Tt+Co+St</b>	<b>D+Tt+T+St</b>	<b>D+Tt+LOG</b>	<b>Sum</b>
0	0	5	2	9	0	15	31
0.00%	0.00%	16.13%	6.45%	29.03%	0.00%	48.39%	100.00%

## DISCUSSION

The majority of academic papers and policy documents related with waste management are focused mostly on recycling, treatment and disposal. Still, these activities are impossible without collecting, transport, storage and transfer of waste. The later ones are the main subsystems of waste logistics in waste flows and usually are dominant costs in waste budgets. Therefore, the characteristics of logistics services and logistics operators directly impact on overall waste management system costs and efficiency. The available data in reports, research papers, whitepapers etc. about logistics operators' characteristics in waste industry are scarce. Only some indications about the practice in both developed and developing countries may be found in the literature, mostly mentioned in analysis of other waste management issues. The prestigious papers focused on waste logistics, mostly deal with processes and operational issues, such as cost optimization [31], vehicle routing and allocation [32], and sometimes with more strategic decisions, like reverse network design [33]. However, a strategic decision about the usage of external logistics resources is almost neglected in the literature, with rare exceptions (e.g. [20]). There is not much evidence about the operators' motivations and obstacles to keep in-house or outsource logistics operations, about the role of logistics operators on the market and the structure of their services in waste flows. According to the literature, logistics outsourcing may reduce costs, increase service quality and allow

the focal firms to focus on core activities. During the decades, logistics providers have been evolved from firms which offer basic activities to global companies with integrated, complex and customized logistics services, including waste logistics solutions. Logistics costs can take a significant share in overall reverse flows costs. More important, once when reverse network is established, operative costs will be a key factor for sustainability of established network. Therefore, they have to be identified, well estimated and controlled within reverse network. Only in that case, policy makers and stakeholders can create appropriate model for logistics management within waste management (e.g. PPP), or make other decisions which are crucial for reaching overall targets related with waste recycling and management, such as legislative framework, subventions, taxes, permissions, market conditions etc.

Considering the overall business environment, it can be concluded that the database about the generated waste, and consequently, about a need for service, is still incomplete in the Republic of Serbia. Huge investments into the waste management infrastructure network have been already realized and the additional funds are also planned for the forthcoming period. The database about generated waste volume is continuously improving, the statistical reports about waste management are more and more comprehensive and the number of operators in waste industry is increasing. The majority of investment is expected to be directed toward the infrastructure, and therefore they currently keep the focus of experts and governmental institutions. Still, it should be noted that a significant part will be also dedicated for equipment and transport capacities replacement. Also, once when networks are established, waste logistics is crucial for profitable and efficient moving waste and making and keeping waste management systems "alive".

Considering the number and the quality of reports and databases about the waste and waste operators, a significant progress has been recorded in the Republic of Serbia. An increasing interest for waste management licenses is an encouraging indicator that private firms and entrepreneurs more and more recognize waste industry as a profitable sector. Operators are mainly interested for integral licenses, which cover several operations in waste management. The licenses for various logistics providers are dominant in the structure. The most popular kind of licenses are those ones which cover collection and transport (44% of all issued licenses), and treatment with all logistics functions - collection, transport and storage (21% of all licenses). While the former has continuously recorded the highest rate during last five years, later expresses a rapid rising of popularity over all other kind of licenses. This integral license is the second most popular kind of license in 2015 (Figure 2). Various licenses for logistics providers highly prevailed over the licenses for operators who perform treatment or disposal, with or without accompanying logistics services - the former make 68.48% of total number of licenses (Table 1). Amongst them, most popular are transport and collection, transport, and integral licenses for collection, transport and storage, respectively (Table 1, Figure 1). Integrated waste logistics services – collection, transport and storage – are not so popular among logistics providers, as it could be expected, considering the popularity of integrated logistics services and providers in direct material flows. In the forthcoming period, waste logistics market maturity, gradual development of logistics operators, and service improvement related with modernization of waste management systems may

bring changes in that sense.

The reasons for popularity of basic logistics activities in waste management may lay in the fact that it is a new economy branch and firms need less capabilities and facilities to start the business in these operations. They also need less capital investments, because transport and storage capacities are usually less expensive than investments into the modern treatment facilities and disposal places which have to meet the standards of European Union. Therefore, firms, mostly micro, small and middle sized, have recognized that it is more profitable and less risky to focus on one or two linked basic logistics activities. Sometimes, operators may even use the existing fleet and storage capacities to adjust them for waste management and so enter into the waste industry with a minimum of investments. The offer of highly developed, even customized logistics services might be the future of waste logistics providers on Serbian market.

The waste logistics is popular even among the firms which perform treatment and disposal, because they tend to keep one or more logistics services in house. Interestingly, the operators who perform treatment, disposal or both of these operation, more like to develop integrated logistics service than logistics providers. More than 70% of operators who perform treatment, disposal or both of these operations (out of 549 operators in Table 1) have developed all three logistics services in house. Their number is significant even in total amount of registered operators for waste management - they make one fifth of operators (390 operators, or 21.87%).

It can be concluded that waste logistics in Serbia seems to look as a very important and promising field in the imminent period for actors in waste industry. Actually, all operators have recognized the vital importance of logistics activities. Two main indicators support this viewpoint. Firstly, the majority of operators who perform treatment, disposal or both of these activities wish to keep in-house the whole package of logistics activities and so meet at least a part of own service demands by own-account capacities. Secondly, the logistics providers who perform one or more logistics activities are currently significantly prevailing among operators in waste industry. An interesting and somewhat unexpected result is that firms which perform waste treatment and disposal tend to develop integrated logistics service in house. More in-depth research is necessary to explore the reasons for this declination from prevailing logistics outsourcing trend.

The presented research indicates the critical role of waste logistics in waste industry and make a suitable ground for further research in various directions. Logistics should be clearly recognized in financial and environmental plans and policy actions related with waste management. It has a critical role in modernization of MSWM systems in three out of four elements given (Section 2.1), as well as in building successful and synergic relationships between the elements.

Further research could include more sharp analysis regarding the waste operators market, waste flows and logistics providers' characteristics, which could be related with the particular kind of waste (e.g. municipal waste, hazardous waste, etc.), capacities, spatial distribution, revenues, or their impact on environment. This could give some useful additional remarks related with the economic, legislative and environmental policy instruments focused on actors in waste logistics industry, in order to achieve modernization of overall waste management systems and their compliance with EU legislatives and standards.



## CONCLUSION

The logistics operations are of vital interest for successful waste management. They can be performed in-house, by operators which main focus is on recycling, treatment and disposal activities, or they can be outsourced to logistics providers.

Logistics outsourcing and the development of specialized logistics companies are among the main trends in logistics all over the world. In the Republic of Serbia, most of operators (almost 70%) decide to enter into the waste industry as logistics providers, who offer one or more logistics services. Since 2010, the most popular kind of license has been the integral license for collection and transport. The license popularity and the dominant rate of collection and transport costs in total budget for waste management ([8], [9]) both indicate the priority of these logistics activities. On the other side, a majority of waste operators specialized for treatment and disposal also use to develop all logistics services in-house. The integral license for treatment, collection, transport and storage records the most rapid growth from 2010–2015. All obtained results indicate that waste logistics have been, and will continue to be of critical importance for all actors in waste flows. PPP provides the opportunity for a kind of "soft outsourcing", through joint ventures and other kinds of stronger relationships than individual market transactions.

The highest initial investments into the waste management are related with infrastructure network (including logistics capacities and facilities), but the collection and transport are dominant costs once when waste management system runs. For all these reasons, it can be concluded that waste logistics has to be recognized by stakeholders, policy makers and researchers as one of the vital pillars in waste management.

## REFERENCES

1. Urošević, S., Pejčić, B., Đorđević, D. (2012), "Contemporary Tendencies in Waste Management in Serbia", *Economics Management Information Technology*, Vol. 1, No 3, pp. 159–166.
2. Nešić B. (2010), *Municipal waste management and recycling potentials for South and Southeast Serbia* // [http://www.protecta.org.rs/public\\_docs/Kom\\_otpad\\_i\\_reciklaza.pdf](http://www.protecta.org.rs/public_docs/Kom_otpad_i_reciklaza.pdf) (referred on 10/04/2016), (in Serbian)
3. Zaman, A.U., Lehmann, S. (2011), "Urban growth and waste management optimization towards 'zero waste city'", *City, Culture and Society*, Vol. 2, No 4, pp. 177–187.
4. Ancuța, C., Olaru, M., Ivan Ișfănescu, R., Ianăș, A. (2014), "Characteristics of the Pollution by Solid Municipal Waste in Timișoara City and its Surrounding Area", *Carpathian Journal of Earth and Environmental Sciences*, Vol. 9, No 1, pp. 141–148.
5. BMZ - Federal Ministry for Economic Cooperation and Development, (2012), *Economic Instruments in Solid Waste Management - Case Study Bulgaria* // <http://www.giz.de/de/downloads/giz2013-en-economic-instruments-bulgaria.pdf> (referred on 06/04/2016).
6. Agency for Environmental Protection, (2015a), *State of the Environment in the*

*Republic of Serbia - a brief overview*, Ministry of Agriculture and Environmental Protection, Belgrade //

<http://www.sepa.gov.rs/index.php?menu=5005&id=19&akcija=showExternal> (referred on 12/04/2016), (In Serbian).

7. Fehr, M. (2014), "The management challenge for household waste in emerging economies like Brazil: Realistic source separation and activation of reverse logistics", *Waste Management & Research*, Vol. 32, No 9, pp. 32–39.
8. Jovičić, N.M., Bošković, G.B., Vujić, G.V., Jovičić, G.R., Despotović, M.Z., Milovanović, D.M., Gordić, D.R. (2010), "Route Optimization to Increase Energy Efficiency and Reduce Fuel Consumption of Communal Vehicles", *Thermal Science*, Vol. 14, No 5, pp. 67–78.
9. Kinobe, J.R., Gebresenbet, G., Vinneras, B. (2012), "Reverse logistics related to waste management with emphasis on developing countries – a review paper". *Journal of Environmental Science and Engineering B*, Vol. 1, No 9, pp. 1104–1118.
10. Shafiul, A.A., Ali, M. (2004), "Partnerships for solid waste management in developing countries: linking theories to realities", *Habitat International*, Vol. 28, No 3, pp. 467–479.
11. Kularatne, R.K.A. (2015), "Case study on municipal solid waste management in Vavuniya township: practices, issues and viable management options", *Journal of Material Cycles and Waste Management*, Vol. 17, No 1, pp. 51–62.
12. Hazra, T., Goel, S. (2009), "Solid waste management in Kolkata, India: practices and challenges", *Waste Management*, Vol. 29, No 1, pp. 470–478.
13. Moghadam, M.R.A., Mokhtarani, N., Mokhtarani, B. (2009), "Municipal solid waste management in Rasht City, Iran", *Waste Management*, Vol. 29, No 1, pp. 485–489.
14. Henry, R.K., Yongsheng, Z., Jun, D. (2006), "Municipal solid waste management challenges in developing countries – Kenyan case study", *Waste Management*, Vol. 26, No 1, pp. 92–100.
15. Lynch, C.F. (2000), *Logistics outsourcing: A Management Guide*, Illinois, Council of Logistics Management Publications.
16. Wilding, R., Juriado, R. (2004), "Customer perceptions on logistics outsourcing in the European consumer goods industry", *International Journal of Physical Distribution & Logistics Management*, Vol. 34, No 8, pp. 628–644.
17. European Commission, Directorate-General Regional Policy (2004), *Resource book on PPP case studies*.
18. Staudt, E., Schroll, M. (1999), "The German packaging ordinance: the questionable effects of a fragmentary solid waste management approach", *Journal of Material Cycles and Waste Management*, Vol. 1, No 1, pp. 17–24.
19. McLeod, F.N., Cherrett, T.J. (2007), "Maximising efficiency in domestic waste collection through improved fleet management", *Proceedings of the Logistics Research Network Annual Conference*, September, Hull, UK (referred on 12/03/2015)<http://citeseerx.ist.psu.edu/viewdoc/download?doi=10.1.1.408.6568&rep=rep1&type=pdf>.
20. Cheng, Y.H., Lee, F. (2010), "Outsourcing reverse logistics of high-tech manufacturing firms by using a systematic decision-making approach: TFT-LCD sector in Taiwan", *Industrial Marketing Management*, Vol. 39, No 7, pp. 1111–1119.

21. Guerrero, L.A., Maas, G., Hogland, W. (2013), "Solid waste management challenges for cities in developing countries", *Waste Management*, Vol. 33, No 1, pp. 220–232.
22. Vasiljević, D. (2014), Greening Serbia, Report, East West Bridge // <http://www.ewb.rs/editone.aspx?id=227> (referred on 24/05/2015).
23. Agency for Environmental Protection, (2015b), *Overview of licenses issued for waste management*, Ministry of Agriculture and Environmental Protection, Belgrade//<http://www.sepa.gov.rs/index.php?menu=20174&id=20055&akcija=ShowExternal> (referred on 22/04/2015), (in Serbian).
24. Agency for Environmental Protection, (2014), *Products that after use become special waste streams in the Republic of Serbia in 2013*, Ministry of Agriculture and Environmental Protection, Belgrade // [http://www.sepa.gov.rs/download/Posebni TokoviOtpada\\_2013.pdf](http://www.sepa.gov.rs/download/Posebni_TokoviOtpada_2013.pdf) (referred on 22/04/2015), (In Serbian).
25. GRS, (2010), *National Strategy of Waste Management in the Republic of Serbia 2010-2019*, Official Gazette of the Republic of Serbia, No 29/10.
26. Standing Conference of Towns and Municipalities, (2009), *Local municipality - regulations and practices*, Pravni bilten, No 2/2009, Belgrade // [http://www.skgo.org/upload/files/Bilten\\_Propisi\\_i\\_praksa\\_br\\_2\\_09.pdf](http://www.skgo.org/upload/files/Bilten_Propisi_i_praksa_br_2_09.pdf) (referred on 20/05/2015), (In Serbian).
27. IFC, (2015), *Belgrade Waste Treatment and Disposal PPP Project*, Belgrade // [http://www.beograd.rs/download .php/documents/BWTDTeaser.pdf](http://www.beograd.rs/download.php/documents/BWTDTeaser.pdf) (referred on 25/03/2016).
28. Working Group for Transformation of Public Municipal Enterprises, (2007), *Transformation of public municipal enterprises in the Republic of Serbia*, Belgrade //[http://www.lokalnirazvoj.rs/upload/LocalGovernmentAdministration/SrAttachments/ 2014-03/Transformacija\\_Javnih\\_Komunalnih\\_Preduzeca.pdf](http://www.lokalnirazvoj.rs/upload/LocalGovernmentAdministration/SrAttachments/2014-03/Transformacija_Javnih_Komunalnih_Preduzeca.pdf) (referred on 24/03/2016), (In Serbian).
29. Bajić, D., Stojanović, Đ. (2013), "Legal and Strategical Framework Design of Logistic Processes in Waste Streams in the Republic of Serbia", *Zbornik radova Fakulteta tehničkih nauka*, Vol. XXVIII, No 10, pp. 1733–1736, (In Serbian).
30. Knežević, V. (2014), "Logistics Providers In Waste Management", *Zbornik radova Fakulteta tehničkih nauka*, Vol. XXIX, No 8, pp. 1725–1728, (In Serbian).
31. Hu, T.L., Sheu, J.B., Huang, K.H. (2002), "A reverse logistics cost minimization model for the treatment of hazardous wastes", *Transportation Research Part E: Logistics and Transportation Review*, Vol. 38, No 6, pp. 457–473.
32. McLeod, F.N., Cherrett, T.J. (2012), "Reverse logistics for sustainable waste management processes", In: Evangelista, Pietro, McKinnon, Alan, Sweeney, Edward and Esposito, Emilio (eds), *Supply Chain Innovation for Competing in Highly Dynamic Markets: Challenges and Solutions*, Hershey, US, IGI Global (doi:10.4018/978-1-60960-585-8.ch015).
33. Fleischmann, M., Beullens, P., Bloemhof-Ruwaard, J.M., Van Wassenhove, L.N. (2001), "The Impact of Product Recovery on Logistics Network Design". *Production and Operations Management*, Vol. 10, No 2, pp. 156–173.



**THE ECOLOGICAL TRUTH AND VARIOUS SCIENTIFIC, ECONOMIC  
AND SOCIAL APPROACHES TOWARDS IT**

**Florian Kongoli<sup>1,2,3</sup>**

<sup>1</sup>CEO, FLOGEN Technologies Inc. Montreal, QC, Canada, H3P 2T1

<sup>2</sup>Chairman, FLOGEN STARS OUTREACH, Montreal, QC, Canada, H3P 2T1

<sup>3</sup>CEO, FLOGEN Technologies Inc., Wilmington, De, 19808, USA

*fkongoli@flogen.com*

**ABSTRACT**

The ecological issues have been in the spotlight in the recent years. These issues have been approached from many different angles and sometimes from contradictory points of view. This plenary paper will make a critical review of various approaches during the years since Kyoto protocol and will suggest the best sustainable and promising approach.



## OPENING SMALL AND MEDIUM SIZED COMPANIES IN THE FIELD OF LANDSCAPE ARCHITECTURE AND HORTICULTURE

Nenad Stavretovic\*, K. Buvac, N. Karanac, S. Tilinger

University of Belgrade, Faculty of Forestry, Belgrade, SERBIA

\*[nenad.stavretovic@sfb.bg.ac.rs](mailto:nenad.stavretovic@sfb.bg.ac.rs)

### ABSTRACT

On the territory of Republic of Serbia it's not enough to just recognize the potential for business entrepreneurship in the area of landscape architecture and horticulture. The opening of small and medium sized businesses which would be working on this field would create competition on the market and would as well raise awareness for the green areas. The basic principles for establishing six types of companies are elaborated in this paper, which are: company for designing green spaces, company for raising or establishing of the green spaces, company for the care and maintenance of green areas, company for designing and establishing green areas, company for establishment, care and maintenance of green spaces and a company for designing, establishing, care and maintenance of the green areas. Small and medium sized businesses in the field of landscape architecture have similar or the same structure of the company but the needed capital in order to start the business, the risks and the market are not the same for every kind of the before mentioned enterprises.

**Key words:** small and middle sized companies, landscape architecture, horticulture.

### INTRODUCTION

The creation of complex, functional and spacious green systems is a very popular tendency in the whole world. On the territory of the Republic of Serbia, until recent years the potential for it wasn't noticed, there was no interest in the cultivation and nursing of green areas. The establishment of small and medium sized businesses which would be engaged in the areas of landscape architecture and horticulture would create competition on the market that will contribute in bigger efficiency and better economy. In order to use the functionality of one area in most effective way it is necessary to design an area which correspond to the conditions of that particular area, construct the area according to the regulations and then properly maintain and cultivate the green area.

The green area in the city urban life has a big ecological, esthetic and physiological meaning. The greenery affects on the microclimate of the area, it makes it more pretty, it motivates the population to use it for recreation, creates a pleasant feeling while staying in it. Therefore, the green areas are places for relaxation, rest, recreation, casual meetings (Anastasijevic, 2007).

## **TYPES OF COMPANIES**

In the previous work we are dealt with some elements of the six types of enterprises in the field of landscape architecture and horticulture: company for designing green spaces, company for raising or establishing of the green spaces, company for the care and maintenance of green areas, company for designing and establishing green areas, company for establishment, care and maintenance of green spaces and a company for designing, establishing, care and maintenance of the green areas.

When starting a business, should take into account a number of things: founding deposit, existing infrastructure, competition, market, qualifications of staff, necessary tools and equipment to carry out transactions etc. Later, in the registration a license is required (one or two, depending on the range of activities of the company) and the code of the primary activities. Activity code consists 4 digits and describes the activity that's the company mainly occupation. The main activity covers 51 % of company activities. From this we can see that the company may engage in other activities, if they are within the law. Small and medium sized companies, which are engaged in Landscape architecture and horticulture, have the primary activity code 8130, and the exact name of the activity "Services of establishing and maintenance environment". It includes: development and maintenance of parks and gardens for private houses and apartment buildings, public buildings (schools, hospitals, administrative buildings, churches, etc.), the city green spaces and cemeteries, greenery along the roads, industrial and commercial buildings; designing and maintenance of greenery and sports grounds for building, outdoor play, lawns for sunbathing and other green areas for recreation, coast around bodies of water; planting trees to protect against noise, wind, erosion, etc. Other activity code which also can be used by previously described company, is 7111, and the name of this activity is "Architectural activities". Includes giving an architectural advices, which are related to the drafting of plans and projects, urban and spatial planning, designing landscapes ("Pursuant to Article 3 of the Government Law Classification of Activities ("Službeni glasnik RS ", no. 104/09) and Article 42, paragraph 1 of the Government Law ("Službeni glasnik RS", no. 55/05, 71/05-correction, 101/07 and 65/08)").

### **1. Organization of the company for designing green spaces**

For the services which this company provides, engineer od landscape architecture is required (activity code: 216202), which has a license for responsible designer od landscaping arranging free spaces (license number 373). If necessary, engage the stuff of necessary professions and qualifications.

**Description of activities:** Project development of landscape design of open spaces such as parks, public gardens, outdoor recreational spaces, walking trails, picnic areas, squares and plazas, open spaces of apartment blocks, hotel gardens, courtyards, school, hospitals, children's institutions and other, the protective green belts, green roads, cemeteries, botanical and zoo gardens, roof gardens, home gardens, bio interior design projects, etc.

## **2. Organization of the company for raising or establishing of the green space**

For the services which this company provides, engineer of landscape architecture is required (activity code: 216202), which has a license for responsible contractor of landscaping arranging free spaces (license number 474). If necessary, engage the extra maintenance workers (activity code: 921401).

**Description of activities:** carrying out preparation and sanitary work, clearing of trees, shrubs, removing weeds, removing stumps, etc.; ground works leveling and surface drainage; installation of park facilities (pergola, hayloft, stairs, ramps, fences, fountains, etc.); installation of park and urban furniture-equipment; Lighting system for watering the greenery; cropping land preparation (substrate); planting and seeding of plants; the establishment of all types of lawns to park areas, parking lots and sports fields (football, golf, etc.); works of reconstruction of park and natural heritage (protection, restoration, conservation, reconstruction, etc.).

## **3. Organization of the company for the care and maintenance of green areas**

For the services which this company provides, engineer of landscape architecture is required (activity code: 216202), which has a license for responsible contractor of landscaping arranging free spaces (license number 474). It's necessary for responsible contractor to have knowledge of care and maintenance (pruning trees and shrubs, knowledge in the field of entomology and phytopathology, care I maintenance of grass surface, etc.)

**Description of activities:** maintenance of sports fields, parks and other public and private green spaces and care of lawns, trees, shrubs, flowers (just one and / or all of the above which are mentioned); maintenance of garden and architectural elements.

## **4. Organization of the company for designing and establishing green areas**

For the services which this company provides, engineer of landscape architecture is required (activity code: 216202), which has a license for responsible designer of landscaping arranging free spaces (license number 373) and a license for responsible contractor of landscaping arranging free spaces (license number 474). There is a need for employment the extra maintenance workers (activity code: 921401) and technical drawing assistant (activity code: 202001).

**Description of activities:** designing and establishment of all types of green areas (for more details see the description of the activities of companies under number 1 and 2)

## **5. Organization of the company for establishment, care and maintenance of green areas**

For the services which this company provides, engineer of landscape architecture is required (activity code: 216202), which has a license for responsible contractor of landscaping arranging free spaces (license number 474). It's necessary for

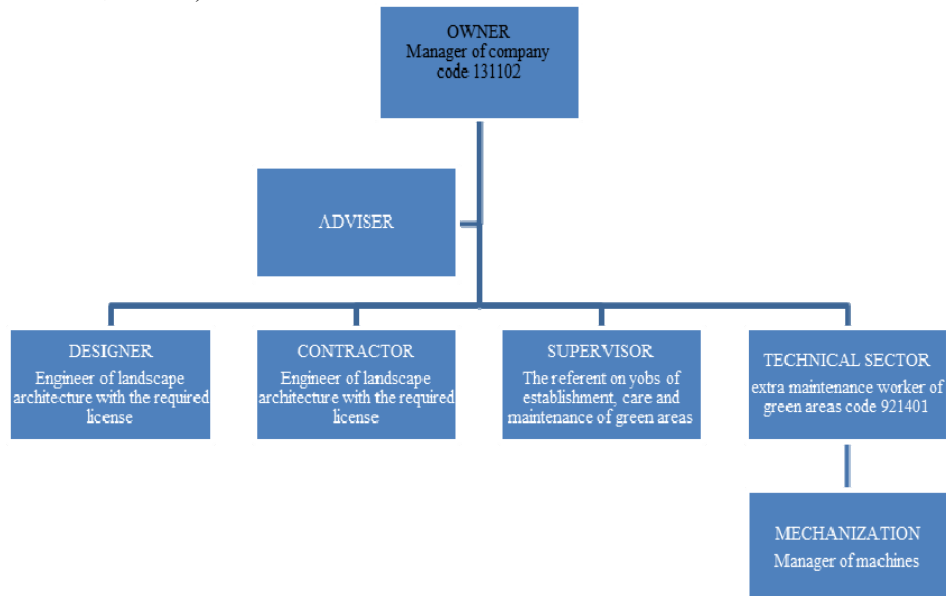
responsible contractor to have knowledge of care and maintenance of green spaces. There is a need for employment the extra maintenance workers (activity code: 921401).

**Description of activities:** establishment, care and maintenance of green spaces (for more details see the description of the activities of companies under number 2 and 3).

#### 6. Organization of the company for designing, establishing, care and maintenance of the green areas

For the services which this company provides, engineer of landscape architecture is required (activity code: 216202), which has a license for responsible designer of landscaping arranging free spaces (license number 373) and a license for responsible contractor of landscaping arranging free spaces (license number 474). It's necessary for responsible contractor to have knowledge of care and maintenance of green spaces. There is a need for employment the extra maintenance workers (activity code: 921401) and technical drawing assistant (activity code: 202001).

**Description of activities:** for designing, establishing, care and maintenance of the green areas (for more details see the description of the activities of companies under number 1, 2 and 3).



**Picture 1.** Scheme of the organization of the company for designing, establishing, care and maintenance of green areas (based on pc5.8, p.33, Dragovic, N. (2010))

With the expanding scope of work in any of the above types of companies, there is a need for increasing the number of workers of all qualifications (with or without qualification, and engineers).



## **DISCUSSION**

Establishment of companies in the Republic of Serbia encourage greater competition in the market, and is therefore the quality of services firms in the profession better. Small businesses have a very important role in local and regional development of a country. They are often the main source of new workplaces, and young people have the opportunity to self-create a working environment that suits them. Yet the establishment of businesses is not easy, it is necessary to plan the direction in which the company develops and which services may qualify as the best possible. Also, we must be aware of the risks that leave a negative impact on the firm's work. We should not expect constant success, but it must exist.

As a rule, small companies are established by an individual entrepreneur, who is also the owner and manager of the company. He independently makes all decisions related to the business and bears the risk of business (Živković, 2014). What goes as the basics of good functioning of the company is having workers whose relationship is based on trust and who are sufficiently skilled to perform tasks, to avoid problems and workarounds generated during the works. It is preferable to professionals licensed, which determines the degree of competence for the given tasks, and gives confidence to customers.

When starting a business, it is necessary to pay attention to the laws that are associated with the profession and should be monitored legal regulations.

One of most important features during the establishment is the initial capital, which is necessary for the functioning of the company until the first profit. Only established companies rarely have their own legal and financial services, so it is better to engage legal and accounting agencies, but with the increase in workload and capital it can be formed sectors for administration and accounting. After the founding of the company, entrepreneur at the beginning investing in equipment and technology as much as it is able and in accordance with the workload. Constantly extraction part of the profit in upgrading working conditions of companies is the right way by which the company should take.

It should be mentioned that it is not needed a large capital for the establishment of small and medium companies, and that there is a possibility to easily and quickly expand businesses. It fit into the economic space that large companies do not cover, tasks which are not interested in or jobs that are not profitable. For a company that only deals with the design requires minimum initial capital, which is a mitigating factor for starting of businesses. It should be kept in mind that the design services do not need a large number of people. This company can have only one employee, who would be the owner of the company, at least until the job starts.

## **CONCLUSION**

When starting a business it is essential to have designed a business plan, which defines the structure, strategy and objectives of the company, as well as start-up capital, in order to avoid errors and problems in the early beginning of the work. In the previous text are given 6 types of companies that can be small or middle sized. It can be

concluded that the companies given the nature of the profession of landscape architecture and horticulture are necessary for the state and society.

By increasing the number of firms or companies in the field of landscape architecture and horticulture, the cities will be prettier and healthier, because of the raising and greening exterior with plants that will be adequately cared for and maintained.

Small and middle companies (or businesses) are the biggest movers of the economic growth. Their big advantage is the fact that they are flexible and they can quickly adapt to the changes and the needs of the market. The economic stability of the country will get better because of the bigger number of companies that will develop. With that in mind, the competition will increase, and with the elimination of the market monopoly the prices will drop, and the services that companies with landscape architecture and horticulture provide will be more available to the customers. From all that we can conclude that the budget of Republic of Serbia will increase, and the economic gain from this occupation will be bigger. Special positive effect founding this type of companies has on the decreased number of unemployment. With increased number of employed the GDI (gross domestic income) will raise.

Except projecting and raising green areas, it should be noted and plant in the consciousness of human population that maintenance and care of plants are an essential purpose for green area. It is not enough just projecting or raising green areas, she must be properly fostered, that they could manifest her positive characteristics, potentialities, and gives the best possible effect on the environment.

Depending on the possibilities, wishes, skills, it can be opened businesses which will be deal with only one of this activities, or combination couple of them.

This represents some of the most important reasons why we should invest in Landscape architecture and horticulture.

### ***Acknowledgements***

*This paper has been realised as a part of the project, "Studying climate change and its influence on the environment: impacts, adaptation and mitigation" (43007) financed by the Ministry of Education and Science of the Republic of Serbia within the framework of integrated and interdisciplinary research for the period 2011–2015.*

### **REFERENCES**

1. Anastasijević, N. (2007) Podizanje i negovanje zelenih površina, Faculty of Forestry, Belgrade (p. 41., p. 140-141.)
2. Dragović, N. (2010) Upravljanje projektima u pejzažnoj arhitekturi, script, Library of Faculty of Forestry, Belgrade
3. Evans-Klock, C. (2003) Start Your Business. Workbook, International Labour Organization; Translation from english: Tomičević, J. (2009) Kako da započnete sopstveni biznis. Priručnik i vežbanka. International labour organization Geneva, Faculty of Forestry, Belgrade. ISBN: 978-86-7299-158-1

4. Jovanović, P. (2008) Upravljanje projektom, Project management college, Belgrade, ISBN 978-86-86897-05-3
5. Pursuant to Article 3 of the Law on Classification of Activities ("Službeni glasnik RS ", no. 104/09) and Article 42, paragraph 1 of the Law on Government ( "Službeni glasnik RS", no. 55/05, 71/05-correction, 101/07 and 65/08). The Government shall issue a regulation on the classification of activities.
6. Stavretović, N. (2012) Proizvodnja travnih tepiha, monografija, Serbian biological society, Belgrade, ISBN 978-86-81413-06-7
7. Živković, M., Ilić,S., Bevanda, V. (2014) Ekonomika poslovanja, Sedmo izmenjeno i dopunjeno izdanje, Megatrend university, Belgrade, ISBN: 978-86-7747-511-6
8. [www.ingkomora.org.rs/licence/?id=sve](http://www.ingkomora.org.rs/licence/?id=sve)



## A RECORD OF NOSTOC COLONIES AT VRŠAC'S MOUNTAINS

Orhideja Strbac\*, M. Vucanovic

PE "Varos" Dvorska 10a, Vrsac, SERBIA

\**sorhideja@gmail.com*

### ABSTRACT

On November 11<sup>th</sup> at the northwest slopes of the Vršac's Mountains 35 gelatinous ruby red balls were found. It was confirmed at the Institute for Biological Research "Siniša Stanković" in Belgrade, they were colonies of cyanobacteria of genus Nostoc. The aims of this paper were a thorough characterization of one Nostoc colonies and the presentation of the cooperation JP Varoš as a custodian of Vršac's Mountains with scientific institutions in the case of determination of these algae. Since these organisms are not sufficiently explored in this region, their every finding is very important to study the biodiversity at local scale.

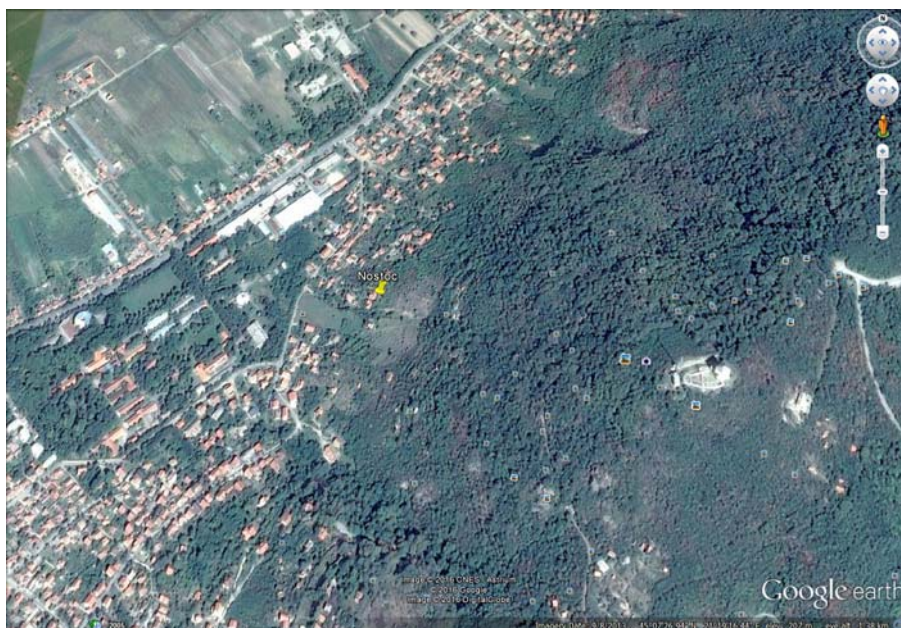
**Key words:** Nostoc genus, Vršac's Mountains, biodiversity.

### INTRODUCTION

Successful active protection of nature requires a permanent monitoring and recording the observed phenomena in the field. Therefore, the close cooperation between the managers of protected natural resources and scientific and professional institutions is needed. This paper presents an example of cooperation between JP „Varoš” from Vršac and the Institute for Biological Research "Siniša Stanković" from Belgrade in determination algae of the genus Nostoc.

### MATERIAL AND METHODS

Thirty five red balls in diameter about 1 cm were found on 11<sup>th</sup> November along the residential zone of Vrsac Mountain at 45° 07'29" N, 21° 19' 10" E and 144 m above sea level. They were measured and sent to the Institute for Biological Research "Siniša Stanković" in Belgrade where Prof. dr Reinhard B<sup>©</sup>cker from University of Hohenheim, was identified them as a colony cyanobacteria of the genus Nostoc.



**Figure 1.** The locality of the Nostoc record (GoogleEarth®)

## RESULTS AND DISCUSSION

Nostoc is a genus of blue-red algae which can be very long in a dormant state until the conditions favourable to the metabolic activity are created. It has special life cycle, during which forms a few characteristic stages. They are important contributors to global photosynthetic biomass production<sup>1</sup>, common in both terrestrial and aquatic habitats. Also, it has capability to fix dinitrogen from the atmosphere.<sup>2</sup> Most of species from Nostoc genus live in symbiotic interactions with fungi, lichens and mosses. Some of the cyanobacteria have ability to protect from detrimental effect of UV radiation<sup>3</sup> because of its UV-A/B absorbing pigment. A few types of Nostoc are edible and had been used as a source of protein and vitamin.<sup>4</sup>

They are found in gelatinous colonies, composed of filaments called "trichomes" surrounded by a thin sheath. Thallus which was collected from the field is spherical, approximately around 1 cm in diameter. Prof Dr Reinhard Böcker from University of Hohenheim, who has been in visit to Institute for Biological Research "Siniša Stanković" in Belgrade, microscopically has observed and determined them as Nostoc spp.



**Figure 2.** The Nostoc colonies in the field (photo:Milivoj Vučanović)

The genus of Nostoc is poorly studied and described and without the help of experts it was not possible to carry out the identification<sup>5</sup>. Further doubts according the identification of this species appeared due pronounced ruby red colour of the colonies that are not common in the field. The more precise determination to the species level requires the examination of the life cycle and the genetic analysis.



**Figure 3.** A size of the thallus (photo:Milivoj Vučanović)



After the identification by the Prof Dr Reinhard Böcker, this record of Cyanobacteria was incorporated in Geographical information system of the Vršac's Montantains.

### CONCLUSION

The identification of cyanobacteria is often difficult and requires the application of morphological, molecular and eco physiological techniques. For mostly findings in the field it is necessary specific expertise. Therefore, it is of great importance to improve collaboration between the managers of the protected areas and scientific and professional institutions, with the aim of recording and studying the species. In addition, better knowledge of the biodiversity at the local scale will improve ecological awareness among the stakeholders.

### *Acknowledgment*

*Authors would like to thank to Slobodan Perić, mountaineer who was found this algae and forwarded to Milivoj Vučanović, ranger in PE „Varoš“ from Vršac.*

### REFERENCES

1. Ehling-Schulz, M.: "Physiological and Protein-Biochemical Analysis of UV-A and UV-B Tolerance of the Terrestrial Cyanobacterium *Nostoc commune*", Institute for Microbiology, Technical University in München, 1-115, 2000.
2. Dodds, W. K., Gudder, D. A. and Mollenhauer, D. : The ecology of *Nostoc*, *Journal of Phycology*, 31: 2-18., 1995.
3. Ehling-Schulz, M. et Scherer, S.: "UV protection in cyanobacteria, *European Journal of Phycology*, 34:4, 329-338, 1999.
4. Temina, M., Rezankova, H., Rezanka, T. et Dembitsky M. V.: "Diversity of the fatty acids of the *Nostoc* species and their statistical analysis", *Microbiological research* 162, 308-321, 2007.
5. Mateo, P., Perona, E., Berrendero, E., Leganés, F., Martin, M. et Golubić, S.: "Life cycle as a stable trait in the evaluation of diversity of *Nostoc* from biofilms in rivers", *FEMS Microbiology ecology* 76, 185-198, 2011.



## FIRST FINDINGS RECORD REPORT REGARDING HALYOMORPHA HALYS IN SERBIA

Orhideja Strbac<sup>1\*</sup>, Z. Gavrilovic<sup>2</sup>

<sup>1</sup>PE "Varos" Dvorska 10a ,Vrsac, SERBIA

<sup>2</sup>Border Police Station " Vrsac " Andje Rankovic 12 ,Vrsac, SERBIA

\**sorhideja@gmail.com*

### ABSTRACT

The adults of brown marmorated stink bug-Halyomorpha halys (Stål, 1855) were first officially recorded in Serbia (Vršac) in October of 2015. However, the immature stages of these invasive insects have been recorded in June of 2015, also in Vršac. In this paper the findings and the brief review of this species are given. This highly polyphagous pest from Asia, is considered pose a risk to the crops and ornamental plants in other continents, where its natural enemies are absent. For the rapid response to a new invasive species it is important to timely notify the public, which is the main objective of this paper.

**Key words:** Halyomorpha halys, Vršac, first record, invasive species.

### INTRODUCTION

The various impacts of invasive insects on natural protected and local agricultural areas are evident worldwide. In order to decrease their negative impact on these areas, one must first understand their life cycle and distribution. Halyomorpha halys (Stål, 1855) was officially reported from the Europe in 2004 in Liechtenstein<sup>1</sup>. A several adults were noticed in 2013. in Budapest, for the first time in Hungary<sup>2</sup>. On June 22<sup>th</sup> 2015, an egg mass of the brown marmorated stink bug was photographed in urban area in Vršac, on potted plant of strawberry, but first published record was in October 9<sup>th</sup> of 2015 at the slopes of Vršac's Mountains.

Vršac's Mountains are protected as an area of outstanding features with the prescribed care regime of I, II and III level. This finding of brown marmorated stink bug was identified as a threat to the locus of the endangered species which grows in zone of the first level of protection.

### MATERIAL AND METHODS

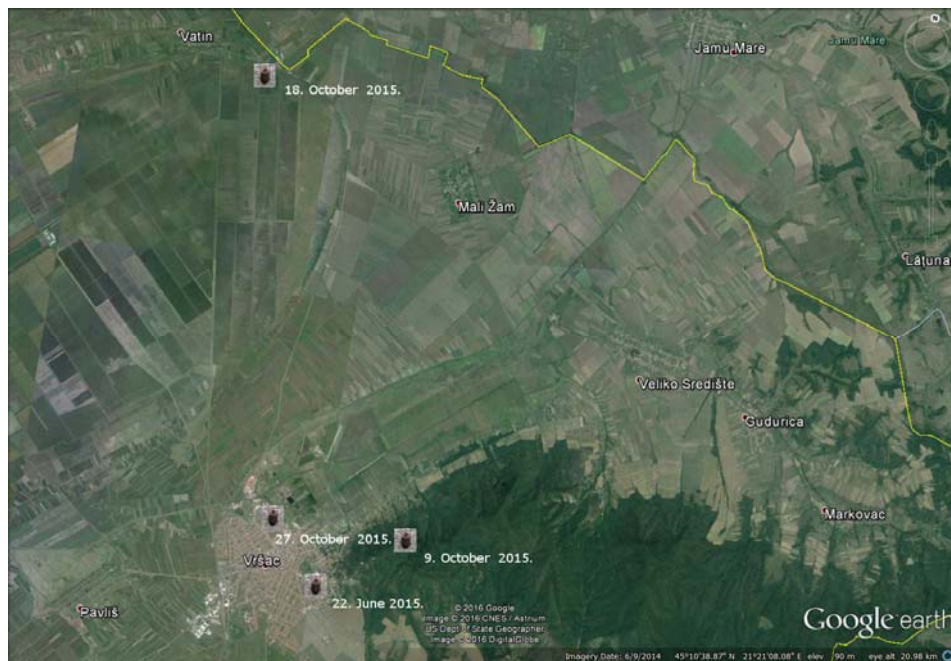
On 22<sup>th</sup> June 2015, the eggs of Halyomorpha halys (Stål, 1855) were noticed and photographed on the leaves of strawberry potted in terrace from house in Vršac at



45° 06'60" N, 21° 18' 21" E and 104 m above sea level. A few months later, on 9<sup>th</sup> October 2015, the adult specimen was observed at Vršac's Mountains at 45° 7'39"N, 21°20'11"E and 345 m above sea level then forwarded to entomologist Jelena Šeat for the identification. Another specimen was found on 18<sup>th</sup> October 2015, in the arable land from village Vatin, towards Romanian border at 45°13'44" N, 21° 16' 11" E and 76 m above sea level. By the end of October 2016, more precisely on October 27<sup>th</sup> one more specimen of *Halymorpha halys* was registered in downtown of Vršac at 45° 7' 16" N, 21° 17' 47" E and 91 m above sea level. Two adults collected from this area were deposited in the Faculty of Forestry in University of Belgrade.

## RESULTS AND DISCUSSION

Vršac Mountains are the specific geological and geomorphological phenomenon, covered by forests and meadow ecosystems which are the habitats of many different plant and animal species. The introduction of invasive species can have a negative effect on natural resources of Vršac Mountains. As polyphagous pest attacking more than hundred plant species, the brown marmorated stink bug *Halymorpha halys* (Stål, 1855) may become important agricultural and horticultural pest in Serbia. Forest trees and shrubs threatened by this insect are from *Acer*, *Salix*, *Euonymus*, *Sorbus*, *Carpinus* and *Rosa* genus.



**Figure 1.** The first records of *Halymorpha halys* (GoogleEarth®)

The white cylindrical eggs are laid in clusters on the underside of leaves, the nymphs ranging in size from 2.4 to 12 mm and the adults are 12 to 17 mm long.<sup>3</sup> In Vršac eggs first were appeared in June of 2016, on potted plant of strawberry.



**Figure 2.** An egg mass surrounded by nymphs (photo Aleksandar Jovančić)

The nymphs progress through five stages. First nymphal instars are orange or red and remain clustered around the eggs. The lateral margins of the abdomen of adults are marked with alternate bands of brown and white.<sup>3</sup> The head, thorax and legs are black. They are shield shape such as other stink bugs, very similar to native *Rhaphigaster nebulosa* (Poda, 1761).



**Figure 3.** Differences between *Halyomorpha halys* and *Rhaphigaster nebulosa* (photo: Zoran Gavrilović)

In 2015 a single generation of *Halyomorpha halys* was recorded in Vršac. However, in southern China records indicate from four to six generation per year<sup>4</sup>. In summer, females lay from 50 to 150 eggs and up to 400 eggs, clustered by groups of 20-30 on the underside of the leaves. During the growing season it can move from host to host rapidly. The brown marmorated stink bug feeds on fruits of apple, *Malus domestica* L., cherry, *Prunus avium* L., *Citrus* spp., mulberry, *Morus* sp., peach, *Prunus persica* Batsch and pear, *Pyrus pyrifolia* Nakaithe. Other host plants include princess tree (*Paulownia tomentosa* Thunb), *Hibiscus rosa-sinensis* L., black night-shade (*Solanum nigrum* L.), soybean (*Glycine max* Merrill)...<sup>3</sup>

## CONCLUSION

It is important to provide timely notification to the public for rapid response to a new invasive species and to encourage the sharing of information. After the experts verification of identification of the new potentially invasive species for Serbia it will need to monitor their dissemination and expand the knowledge about biosecurity measures. The main contribution to work on the management strategies which might apply against *Halyomorpha halys* is spreading the knowledge about this pest among stakeholders.

## Acknowledgment

*Authors would like to thank to Jelena Šeat, entomologist who was identify this pest from photos taken from the field.*

## REFERENCES

6. Šeat, J. :“ *Halyomorpha halys* (Stål, 1855) (Heteroptera: Pentatomidae) a new invasive species in Serbia”, *Acta entomologica serbica*,20, 167-171, 2015.
7. Véték, G., Papp, V., Haltrich, A. et Rédei, D: First record of the brown marmorated stink bug, *Halyomorpha halys* (Hemiptera: Heteroptera: Pentatomidae), in Hungary, with description of the genitalia of both sexes, *Zootaxa* 3780 (1): 194–200 , 2014.
8. Gyeltshen, J., Bernon, G., Hodges, A., Stocks, S. et Brambila, J. : “Brown marmorated stink bug - *Halyomorpha halys*”, [http://entnemdept.ufl.edu/creatures/veg/bean/brown\\_marmorated\\_stin...](http://entnemdept.ufl.edu/creatures/veg/bean/brown_marmorated_stin...)
9. Jacobs, S.: Brown Marmorated Stink Bug-*Halyomorpha halys*, Entomological Notes, The Pennsylvania State University, 2010.



## THE AMENDMENT LEAVES SPECIES DIVERSITY OF FAUNA INVERTEBRATA SPECIAL NATURE RESERVE ZASAVICA

Mihajlo Stankovic

Special nature reserve Zasavica - Pokret gorana Sr.Mitrovica, SERBIA

*zasavica@zasavica.org.rs*

### ABSTRACT

To watercourse and ephemeral waters live: *Asellus aquaticus*, *Argulus foliaceus*, *Podura aquatica*, a *Astacus leptodactylus* is on the IUCN Red List. Pedofauna make *Trombidium holosericeum* and *Lepisma saccharina*. For other *Forficula smyrnensis* this is the second of a *Luciola lusitanica* is the third report in Serbia. There are 12 species of Hymenoptera. A significant finding of non-native species *Isodontia mexicana*. These types *Rhyss persuasoria* and *Scolii hirta* were recorded once. Type *Leptura sanguinolenta* the new Vojvodina a *Lethrus apterus* is potentially new to Serbia. Rare species are: *Egaenus convexus*, *Forficula smyrnensis*, *Hispa atra*, *Necrophorus littoralis*, *Nicrophorus interruptus*, *Hololepta plan*, *Rutpela maculata*, *Bostrychus capucinus*, *Meloe brevicollis*, *Trox sabulosum* *Enoplopus dentipes*. Shellfish has two types *Sphaerium corneum* and *Sinanodonta woodiana*.

**Key words:** Zasavica, invertebrata.

### INTRODUCTION

Special Nature Reserve Zasavica is located on the border of the two in terms of diversity of very important areas: Balkan Peninsula, which is characterized by extremely rich and unique fauna and the Pannonian Plain, which also has a specific fauna depending on the habitat. The Government of the Republic of Serbia has declared 1997 the Zasavica Special Nature Reserve. This paper aims to show the new data that complement the overall value of diversity SNR Zasavica. And this research identified a large number of rare animals and of international significance. Altitude terrain ranges from 76 to 82 meters above sea level, and the terrain is gently sloping from south to north. Greater rainfall, have caused a high level of groundwater and the emergence of peat and peat-swamp a complex and Zasavica, resulting outpouring of the Sava and Drina in the Atlantic phase of the Holocene. The records of the early nineteenth century, the area of western Zasavica was under the wetland complex, an area of 25,000 ha where the floating peat islands, while from the Black bars to Salas Noćajski formed peat layer depth of 50 cm. The total length of Zasavica watercourse is 33.1 km, width up to 80 m and 2 m deep. The reserve has an area of 1,821 ha, of which 671 ha in the second degree of protection. Reserve seems waters Zasavice the mosaic arrangement of

hydrophilic, hygrophile and steppe habitat and groundwater is fed by the Drina and Cerska water. It belongs to the Black Sea basin.

## MATERIAL AND METHODS OF WORK

Material for this study was collected from so far published papers on the research reserve in the period from 1997 to 2011 with the completion of the data that are not yet published.

## THE RESULTS OF THE DISCUSSION

The ephemeral watercourse and surrounding waters recorded cosmopolitan aquatic isopod *Asellus aquaticus*. From subclasses Branchiura at sea Zasavice recorded the ichthyophagous ectoparasitic species *Argulus foliaceus*. In spring and autumn in the waters of Colembola found the presence of Fam. Poduridae type *Podura aquatica*. From Fam. Astacidae the reserve Zasavica found *Astacus leptodactylus* (Simić, et al., 2008), which favors a relatively calm waters and is located on the IUCN Red List. (Gherardi F., Souty-Grosset, C., (2010) The Reserve has recorded seven species of which Opilion in Serbia species *Egaenus convexus* has the status of rare species. Type *Phalangium opilio* is paleoartic cosmopolitan species, while other species have a European (Alpine-Carpathian-Subatlantic), southeast European, Ponto-Mediterranean (Trans Adriatic) and the Asia-sub-Mediterranean distribution. During the research of invertebrates have been found Apterygota whose representatives are the first official data reserve. From fauna Apterygota handled the type of the order Collembola and Thysanura. During research pedofauna in the reserve are found representatives of the order Thysanura and Acarina. From Acarina was found from the suborder Prostigmata Fam. Trombididae species *Trombidium holosericeum*. This is one of the largest terrestrial acarina in the northern temperate zone with a body length of 4 mm. From the order of Thysanura there was a representative from Fam. Lepismatidae species *Lepisma saccharina*. From Fam. Forficulidae in the Reserve are found two species of which earwig for type *Forficula smyrnensis* findings in the Reserve is the second in Serbia. From the suborder Auchorrhyncha in the Reserve stated, 6 species, among which is one of the Mediterranean species *Tibicina haematodes*. Three types of cycads have a very good mimicry while resting on plants such as the type *Stictocephala bisonia* which from a distance looks like a green thorn plants and there are *Dictyophara europaea* and *Centrotus cornutus* that look as usual thickening of the tree. From Hymenoptera until now have been processed following families: Fam. Apidae, Fam. Sphecidae, Fam. Scoliidae, Fam. Sphecidae, Fam. Ichneumonidae, Fam. Scoliidae, Fam. Xylocopinae and a total of 12 species were recorded. From Fam. Sphecidae the track record of the three types is important to mention finding of *Isodontia mexicana*. This is a non-indigenous invasive wasp originating from America, which is of 2010. The first time in Serbia was found in Belgrade and then 2012., and on Fruska Gora. Otherwise, this alohtona wasp was first recorded in Europe in southern France. (Četković, et al., 2012) According to Četković, et al., (2011) in the reserve is present and the type *Sceliphron curvatum*. Some species of Hymenoptera were recorded for the 18 years of research only once, from



Fam. Ichneumonidae species *Rhyss persuasoria* (2006.), and from Fam. Scolidae type *Scolii hirta* (2010.). According Pi.N.,Stanković,M.,(2006), longhorn beetle fauna in the Reserve has 30 species, these new data sheet is expanded to 12 species. Among these 12 species of beetles by Pavićević,et.al.,(2015), a rare species *Rutpela maculata* is a species *Leptura (Anastrangalia) sanguinolenta* the new Vojvodina. Of these 12 species of beetles are 4 types of European red list (*Prionus coriarius*,*Saperda punctata*, *Clytus arietis*, *Chlorophorus sartor*) status LRLc and Lrnt. (Nieto, Alexander, 2012)

Of the two types of Fam Lampyridae for type *Luciola lusitanica* findings in the Reserve is the third in Serbia for 50 years. Fam. Scarabidae in the Reserve is represented with 10 species, of which *Lethrus apterus* species potentially new to Serbia sawing Scarabidae Serbia that have published Gavrilovi,Ćurčić, (2010), while other authors *Geotrupes stercorarius* Gavrilović,Ćurčić (2010) are not mentioned in the list or the type mentioned in the entomological monograph Zivojinovic, S., (1950) and the authors Janković, Lj. (1972). Species with less than 5 findings of 18 years of research reserves are *Tibicina haematodes*, *Lamia textor*, *Dicerca alni* until the following types *Astacus leptodactylus*, *Rhyss persuasoria*, *Scolii hirta*, *Trox subulosus*, *Luciola lusitanica*, *Copris lunaris*, *Lethrus apterus*, *Saperda punctata* for this research period recorded only once. Almost regularly every year in the reserve records the presence of the following species: *Asellus aquaticus*, *Mantis religiosa*, *Forficula auricularia*, *Cicadella viridis*, *Stictocephala bisonia*, *Cercopis sanguinolenta*, *Xylocopa violacea*, *Chrysomela (Melasoma) populi*, *Cetonia aurata*, *Oxythyrea funesta*, *Tropinota hirta*, *Valgus hemipterus*, *Paederus fuscipes*, *Dorcus parallelipedus*, *Sisyphus schafferi*, *Panorpa communis*, *Eristalis tenax*, *Pentodon idiota* and other.

In rare or rarer species in fauna include: *Forficula smyrnensis*, *Hispa atra*, *Necrophorus littoralis*, *Nicrophorus interruptus*, *Hololepta plan* *Bostrychus capucinus*, *Meloe brevicollis*, *Trox sabulosum* *Enoplopus dentipes* because for the past 50 years, we have less than 10 findings in Serbia.

Shellfish u reserve are represented with two types and this Fam.Sphaeriidae paleoartic type of *Sphaerium corneum* (Linnaeus,1758) from a Fam.Anodontidae type *Sinanodonta (Anodonta) woodiana* (Rea,1834) which is in Serbia was found at 44 sites mainly on the Danube and Tisa and Morava River at the mouth of the Danube and Sava (Paunović,et.al.,(2006), these East Asian mussel is often in itself has a parasitic phase (*glochidium*), which infects the host fish. (Douda,et.al.,(2012)

**Table 1.** List of amendments species diversity of invertebrate fauna SRP Zasavica

<u>INVERTEBRATA</u>	subclasses: Pterygota
Nematomorpha	DYCTIOPTERA
Fam.Gordiidae	Fam. Mantoidea
Species:	Species: <i>Mantis religiosa</i> (Linnaeus,1758)
<i>Gordius cf.aquaticus</i> Linnaeus,1758	
ARTHROPODA	DERMAPTERA
Classes: Crustacea	Fam.Forficulidae
Subclasses: Branchiura	Species:
Fam:Argulidae	<i>Forficula auricularia</i> (Linnaeus,1758)
Species: <i>Argulus foliaceus</i> (Linnaeus,1758)	<i>Forficula smyrnensis</i> Serville,1839

<p>DECAPODA Fam.Astacidae Species: <i>Astacus leptodactylus</i> Eschscholtz,1823</p> <p>MALACOSTRACA Ordo: Isopoda Fam.Asellidae Species: <i>Asellus aquaticus</i> (Linnaeus,1758)</p> <p>OPILIONES Fam.Phalangiidae Species: <i>Phalangium opilio</i> Linnaeus,1761 <i>Zachaeus crista</i> (Brullé,1832) <i>Leiobunum rupestre</i> (Herbst,1799) <i>Opilio parietinus</i> (Degeer,1778) <i>Trogulus</i> sp. <i>Pyza bosnica</i> (Roewer,1919) <i>Egaenus convexus</i> (C.L.Koch,1835)</p> <p>ACARINA Subordo: Prostigmata Fam. Trombididae Species: <i>Trombidium holosericeum</i> (Linnaeus,1758)</p> <p>MYRIAPODA Fam. Scutigerae Species: <i>Scutigera coleoptrata</i> (Linnaeus,1758)</p> <p>CLASSES: INSECTA subclasses: Apterygota</p> <p>Ordo: Collembola Fam.: Poduridae Species: <i>Podura aquatica</i> Linnaeus,1758</p> <p>Ordo: Thysanura Fam.: Lepismatidae Species: <i>Lepisma saccharinum</i> Linnaeus,1758</p> <p>COLEOPTERA Fam. Cerambycidae Species: <i>Lamia textor</i> (Linnaeus,1758) <i>Neodorcadion bilineatum</i> (Germar,1824) <i>Pedestredorcadion pedestre</i> (Poda,1761) <i>Prionus coriarius</i> (Linnaeus,1758) <i>Saperda punctata</i> (Linnaeus,1767) <i>Leptura (Anastrangalia) sanguinolenta</i> (Linnaeus,1761) <i>Plagionotus floralis</i> (Pallas,1776) <i>Rutpela maculata</i> (Poda,1761) <i>Agapanthia dahli</i> (Richter,1821)</p>	<p>HEMIPTERA Subordo: Auchenorrhyncha Fam. Cicadidae Species: <i>Tibicina haematodes</i> (Scopoli,1763) Fam. Cicadellidae Species: <i>Cicadella viridis</i> (Linnaeus,1758) Fam. Membracidae Species: <i>Centrotus cornutus</i> (Linnaeus,1758) <i>Stictocephala bisonia</i> Kopp&amp; Yonke,1977 Fam. Dictyopharidae Species: <i>Dictyophara europaea</i> (Linnaeus,1758) Fam. Cercopidae Species: <i>Cercopis sanguinolenta</i> (Scopoli,1763)</p> <p>HYMENOPTERA Fam. Apidae Species: <i>Bombus lapidarius</i> (Linnaeus,1758) <i>Apis mellifera</i> Linnaeus,1758 Fam. Sphecidae Species: <i>Amophila sabulosa</i> Linnaeus,1758 <i>Sceliphron curvatum</i> (F.Smith,1870) <i>Isodontia mexicana</i> (Sausure,1867) Fam. Ichneumonidae Species: <i>Rhyssa persuasoria</i> (Linnaeus,1758) <i>Ophion luteus</i> (Linnaeus,1758) Fam. Scoliidae Species: <i>Scolia hirta</i> (Schrank,1781) Fam. Xylocopinae Species: <i>Xylocopa valga</i> Gerstaecker,1872 <i>Xylocopa violacea</i> (Linnaeus,1758) Fam. Crabronidae Species: <i>Philonthus politus</i> Say,1824 Fam. Chrysididae Species: <i>Chrysis ignita</i> (Linnaeus,1758)</p> <p>Fam. Staphylinidae Species: <i>Staphylinus caesareus</i> Cederehjelms,1798 <i>Paederus fuscipes</i> Curtis,1826 <i>Ocyrops oleus</i> (O.F.Muller,1764). Fam. Lucanidae Species: <i>Lucanus cervus</i> (Linnaeus,1758) <i>Dorcus parallelipedus</i> (Linnaeus,1758) Fam. Lampyridae Species: <i>Lampyris noctiluca</i> Linnaeus,1758 <i>Luciola lusitanica</i> (Charpentier,1825)</p>
--	--

<i>Carinatodorcadion fulvum</i> (Scopoli,1763)	Fam.Scarabidae
<i>Carinatodorcadion aethiops</i> (Scopoli,1763)	Species:
<i>Chlorophorus sartor</i> (Muller,1766)	<i>Geotrupes stercorarius</i> (Linnaeus,1758)
<i>Neoclytus acuminatus</i> (Fabricius,1775)	<i>Copris lunaris</i> (Linnaeus, 1758)
<i>Clytus arietis</i> (Linnaeus,1758)	<i>Lethrus apterus</i> (Laxmann,1770)
Fam. Chrysomelidae	<i>Onthophagus ovatus</i> (Linnaeus, 1767)
Species: <i>Chrysolina coeruleans</i> (Scriba,1791)	<i>Pentodon idiota</i> (Herbst,1789)
<i>Chrysolina fastuosa</i> (Scopoli,1763)	<i>Sisyphus schafferi</i> (Linnaeus,1758)
<i>Chrysomela (Melasoma) populi</i> Linnaeus, 1758	<i>Euoniticellus fulvus</i> Goeze,1777
<i>Clytra laeviuscula</i> Ratzeburg,1837	<i>Trichius sexualis</i> Bedel,1906
<i>Cryptocephalus aureolus ssp.purpureus</i> Csiki,1953	<i>Anisoplia deserticola</i> Fischer von Waldheim,1824
<i>Galeruca tanacetii</i> (Linnaeus,1758)	<i>Anomala vitis</i> (Fabricius,1775)
<i>Hispa atra</i> Linnaeus,1758	Fam.Scarabidae- Subfam.Dynastinae
<i>Tamarcha pratensis</i> Duftschmid,1825	Species: <i>Oryctes nasicornis</i> (Linnaeus,1758)
<i>Donacia crassipes</i> Fabricius 1775	Fam. Meloidae
<i>Cryptocephalus sericeus</i> (Linnaeus,1758)	Species: <i>Lytta vesicatoria</i> (Linnaeus,1758)
<i>Labidostomis longimana</i> (Linnaeus,1761)	<i>Meloe proscarabaeus</i> Linnaeus,1758
<i>Galerucella luteola</i> (Linnaeus,1758)	<i>Meloe violaceus</i> Marsham,1802
<i>Galeruca tanacetii</i> (Linnaeus,1758)	<i>Meloe brevicollis</i> Panzer,1703
Fam. Trogidae	Fam. Tenebrionidae
Species: <i>Trox subulosus</i> (Linnaeus,1758)	Species: <i>Blaps mortisaga</i> (Linnaeus,1758)
Fam.Lagriidae	<i>Enoplopus dentipes</i> (Rossi,1790),
Species: <i>Lagria hirta</i> (Linnaeus,1758)	<i>Gnaptor spinimanus</i> (Pallas,1781)
Fam.Silphidae	<i>Opatrum sabulosum</i> (Linnaeus,1758)
Species: <i>Phosphuga atrata</i> (Linnaeus,1758)	Fam.Melolonthidae
<i>Necrophorus littoralis</i> Linnaeus,1758	Species:
<i>Thanatophilus sinuatus</i> (Fabricius,1775)	<i>Melolontha melolontha</i> (Linnaeus,1758)
<i>Nicrophorus interruptus</i> Stephens,1830	<i>Anisoplia austriaca</i> (Herbst,1783) <i>Rhysotrogus</i>
Fam. Buprestidae	<i>aequinoctialis</i> (Linnaeus,1758)
Species: <i>Dicerca alni</i> (Fischer,1824)	Fam.Bostrichidae
Fam.Silvanidae	Species:
Species: <i>Uleiota planata</i> (Linnaeus,1758)	<i>Bostrychus capucinus</i> (Linnaeus,1758)
Fam. Histeridae	
Species:	RAPHIDIOPTERA
<i>Hister quadrimaculatus</i> Linnaeus,1758	Fam.Raphidiidae
<i>Hololepta plana</i> (Sulzer,1776)	Species: <i>Raphidia ophiopsis</i> Linnaeus, 1758
Fam.Cetonidae	MECOPTERA
Species: <i>Cetonia aurata</i> Linnaeus, 1758	Species: <i>Panorpa communis</i> Linnaeus,1758
<i>Oxythyrea funesta</i> (Poda,1761)	
<i>Protaetia cuprea</i> (Fabricius,1775)	
<i>Tropinota hirta</i> (Poda,1761)	
<i>Valgus hemipterus</i> (Linnaeus,1758)	
DIPTERA	
Fam. Bombyliidae	
Species: <i>Bombylius major</i> Linnaeus,1758	
Fam. Syrphidae	
Species: <i>Volucella zonaria</i> (Poda,1761) <i>Volucella</i>	
<i>pellucens</i> Linnaeus,1758	
<i>Eristalis tenax</i> (Linnaeus, 1758)	
Fam. Scathophagidae	
Species:	
<i>Scathophaga stercoraria</i> Linnaeus,1758	



<i>Calliphora vomitoria</i> Linnaeus,1758 <i>Lucilia caesar</i> Linnaeus,1758 <i>Musca domestica</i> Linnaeus,1758 Fam.Asilidae Species: <i>Laphria flava</i> (Linnaeus, 1768) <i>Asilus crabroniformis</i> Linnaeus,1758  GASTROPODA-Bivalvia Fam. Sphaeriidae Species: <i>Sphaerium corneum</i> (Linnaeus,1758) Fam. Anodontidae Species: <i>Sinanodonta (Anodonta) woodiana</i> (Rea, 1834).	
---	--

### CONCLUSION

The ephemeral watercourse and surrounding waters have been reported following types: *Asellus aquaticus*, *Argulus foliaceus*, *Podurs aquatica*. From Fam.Astacidae the reserve Zasavica found *Astacus leptodactylus*, which is located on the IUCN Red List. Of the seven types of Opilion in Serbia species *Egaenus convexus* has the status of rare species. During the research of invertebrates have been found Aptorigota whose representatives are the first official data reserve. From fauna Aptorigota handled the type of the order Collembola and Thysanura. During the research pedofauns in the reserve are found representatives of the order Thysanura and Acarina and of acarina was found *Trombidium holosericeum* species, a species of the order Thysanura *Lepisma saccharina*. From Fam.Forficulidae for type *Forficula smyrnensis* findings in the Reserve is the second in Serbia. From Hymenoptera total recorded 12 species. From Fam.Sphecidae important to mention finding of non-native invasive species originating from America wasps *Isodontia mexicana*. Some species of Hymenoptera were recorded for the 18 years of research only once, from Fam. Ichneumonidae species *Rhyss persuasoria* (2006.), And from Fam. Scoliididae type *Scolii hirta* (2010.). Fauna beetles in the Reserve with the new data is expanded to 12 species. Among these 12 species of rare species of beetles *Rutpela maculata* is a species *Leptura (Anastrangalia) sanguinolenta* the new Vojvodina. Of these 12 species of beetles are 4 types of European red list (*Prionus coriarius*, *Saperda punctata*, *Clytus arietis*, *Chlorophorus sartor*). For the type *Luciola lusitanica* findings in the Reserve is the third in Serbia for 50 years. From Fam. Scarabidae *Lethrus apterus* species potentially new to Serbia sawing Scarabidae Serbia that have published Gavrilovic, Curcic, (2010) Three species have less than 5 findings of 18 years of research reserve, while eight species have been recorded only once in the reserve. Rare or rarer species in fauna are *Forficula smyrnensis*, *Hispa atra*, *Necrophorus littoralis*, *Nicrophorus interruptus*, *Hololepta plan* *Bostrychus capucinus*, *Meloe brevicollis*, *Trox sabulosum* *Enoplopus dentipes* because for the past 50 years, we have less than 10 findings in Serbia.

Shellfish in the reserve are represented with two types and this type of Fam.Sphaeriidae paleoartic *Sphaerium corneum* from a Fam.Anodontidae type *Sinanodonta (Anodonta) woodiana*.

## REFERENCES

1. Četković, A., Čubrilović, B., Plećaš, M., Popović, A., Savić, D., Stanisavljević, Lj., (2012): First records of the invasive american wasp *Isodontia mexicana* (Hymenoptera: Sphecidae) in Serbia, *Acta Entomologica Serbica*, 17 (1/2), Belgrade
2. Četković, A., Mokrousov, M., Plećaš, M., Bogusch, P., Antić, D., Đorović-Jovanović, Lj., Krpo-Četković, J., Karaman, M., (2011): Status of the potentially invasive Asian species *Sceliphron deforme* in Europe and an update on the distribution of *S. curvatum* (Hymenoptera: Sphecidae), *Acta Entomologica Serbica*, 16 (1/2), Belgrade
3. Douda, K., Vrtílek, M., Šlavík, O., Reichard, M., (2012): The role of host specificity in explaining the invasion success of the freshwater mussel *Anodonta woodiana* in Europe, *Biological Invasions* 14
4. Gavrilović, B., Čurčić, S.B., (2010): Diversity of species of the fauna Scarabidae (Coleoptera) in Serbia, *Arch. Biol. Sci.*, No. 63(3), Beograd
5. Gavrilović, D.B., Čurčić, B.S., (2011): Diversity of species of the fauna Chrysomelidae (Insecta, Coleoptera) in Serbia with an overview of previous researches, *Acta zoologica bulgarica*, 63 (3), *Arch. Biol. Sci.*, No. 63(3), Beograd
6. Gherardi, F., Souty-Grosset, C., (2010): "*Astacus leptodactylus*". IUCN Red List of Threatened Species. Version 3.1. International Union for Conservation of Nature.
7. Ilić, N., Čurčić, S., (2015): A checklist of longhorn beetles (Coleoptera, Cerambycidae) of Serbia, *Zootaxa*, Monograph 4026 (1), Magnolia Press.
8. Janković, Lj., (1972): Visokoplaninska fauna Coleoptera na Kopaoniku, SANU, Posebna izdanja knj. CDXLIX, Odeljenje Prirodno-Matematičkih nauka, knj. 38, Beograd
9. Nieto, A., Alexandar, A.N. Keith, (2012): European Red List of Saproxylic Beetles, Luxembourg Publications Office of the European Union
10. Paunović, M., Csányi, B., Simić, V., Stojanović, B., Cakić, P., (2006): Distribution of *Anodonta (Sinanodonta) woodiana* (Rea, 1834) in inland waters of Serbia, *Aquatic Invasions*, Vol. 1., Iss. 3, Journal Reabic
11. Pavićević, D., Ilić, N., Đurić, M., (2015): Strižibube Srbije, Zavod za zaštitu prirode Srbije-HabiProt, Beograd
12. Pil, N., Stanković, M., (2006): Cerambycidae (Coleoptera) of the Zasavica Special Nature Reserve (Serbia), *Acta Entomologica Serbica*, 11 (1/2), Belgrade
13. Simić, V., Petrović, A., Rajković, M., Paunović, M., (2008): Crayfish of Serbia and Montenegro-the population status and the level of endangerment, *Koninkliijke Brill nuleiden*, 81 (10).
14. Živojinović, S., (1950): Fauna insekata šumske domene Majdampek (Entomološka monografija), SANU, Posebna izdanja knj. CLX, Institut za Ekologiju i Biogeografiju, knj. 2, Beograd



## ACTIVITY LEVELS OF $^{137}\text{Cs}$ AND $^{40}\text{K}$ IN MOSS FROM NP DJERDAP IN 2015

Ana Cuculovic<sup>1\*</sup>, R. Cuculovic<sup>2</sup>, S. Nestorovic<sup>3</sup>, D. Veselinovic<sup>4</sup>

<sup>1</sup>University of Belgrade, Institute for the Application of Nuclear Energy – INEP,  
Banatska 31b, 11080 Zemun, SERBIA

<sup>2</sup>Higher Business school in Leskovac, Vlade Jovanovića 8, 16000 Leskovac, SERBIA

<sup>3</sup>National Park Djerdap, Kralja Petra I 14a, 19220 Donji Milanovac, SERBIA

<sup>4</sup>University of Belgrade, Faculty of Physical Chemistry,  
P.P. 47, 11001 Belgrade, SERBIA

\**anas@inep.co.rs*

### ABSTRACT

Activity levels of  $^{137}\text{Cs}$  and  $^{40}\text{K}$  in (Bq/kg) in moss (29) and substrate (5) samples collected on the territory of the Djerdap National Park in May 2015 have been analyzed in this work. The presence of  $^{137}\text{Cs}$  and  $^{40}\text{K}$  radionuclides was established in all moss samples. Activity levels of  $^{137}\text{Cs}$  in moss was from 9.2 to 512 (Bq/kg), while it was from 36 to 2047 Bq/kg in moss substrates. Activity levels of  $^{40}\text{K}$  in moss were from 51 to 592 (Bq/kg), while in substrates from 133 to 660 (Bq/kg). This data compared with data from previous measurements shows that no new contaminations with  $^{137}\text{Cs}$  occurred on the territory of NP Djerdap and that the natural activity levels of isotopes on the territory of NP Djerdap have not changed.

**Key words:** Moss, NP Djerdap,  $^{137}\text{Cs}$ ,  $^{40}\text{K}$

### INTRODUCTION

Ion radiation of different origin and characteristics is present in the environment. According to origin, ion radiation can be classified to have an Earth or cosmic origin. According to genesis and occurrence in the environment ion radiation can be: natural, anthropogenic and radioactive waste. During their lifetime organisms are constantly exposed to radioactive radiation. Radionuclides reach water and soil by migration and accumulation processes, and from them to food of plant and animal origin, thus contributing to total irradiation of the population of a certain territory<sup>1</sup>. Investigation of  $^{137}\text{Cs}$  (artificially produced radionuclide) and  $^{40}\text{K}$  (naturally produced radionuclide) is significant for this research.

Accidents in nuclear facilities and nuclear probes release large amounts of polluting radioactive material into the atmosphere. The Chernobyl accident (26.4.1986., Ukraine), thirty years ago, released a large amount of polluting radionuclides into the environment –  $10^{18}$  Bq, of which  $3.7 \times 10^{16}$  Bq  $^{137}\text{Cs}$ , most often reaching plants from the

atmosphere by dry and wet fall<sup>2</sup>. Pollution with these radionuclides generally has a regional character, but it can have a wider scale in the case of strong nuclear explosions. Physico-chemical properties of <sup>137</sup>Cs are such that it actively participates in the human and animal food chains through plants as it metabolically replaces potassium. The cesium ion is the chemical and biochemical homologue of potassium and follows its metabolism in the organism. It is completely soluble in body fluids and is evenly distributed in the organism. The physical half-life of <sup>137</sup>Cs is 30.2 years so this year its activity should be half in relation to the starting value. The length of retention of <sup>137</sup>Cs in an organism influences the body damage of the organism polluted by this radionuclide. The second radionuclide studied in this work is <sup>40</sup>K, and this is an essential natural radionuclide found in nature as a mixture of stable potassium isotopes <sup>39</sup>K and <sup>41</sup>K. The physical half-life of <sup>40</sup>K is  $1.5 \times 10^9$  years, while its biological half-life is 58 days. It is part of the human organism and is under homeostatic control<sup>3</sup>.

Information on the spatial and time distribution and trends in pollution of air and the environment with radionuclides can be collected from moss. Moss is an old and primitive group of organisms that easily absorbs polluting substances from the environment thus indicating their presence and giving qualitative and quantitative information on pollution levels and indicating changes with time. Investigation of activity levels of radionuclides in moss gives a reliable insight into the level of contamination of ecological systems with radioactive isotopes. Depending on the species and age of moss, morphological and physiological characteristics, location and substrate, altitude, moss has shown to be a good bioindicator of pollution of the environment with radionuclides<sup>4-8</sup>.

Our earlier research of activity levels of radionuclides in moss samples from the territory of NP Djerdap has shown that the Chernobyl accident resulted in non-uniform distribution of <sup>137</sup>Cs and the highest activity of this radionuclide was registered in samples from the Crni vrh management unit (MU). With the aim of establishing the distribution of radioactive isotopes (<sup>137</sup>Cs and <sup>40</sup>K) in the Djerdap national park 29 years after the Chernobyl accident moss and substrate samples were collected.

## MATERIAL AND METHODS

Moss (29) and selected substrate (5) samples were collected in May 2015 in the area of the Djerdap national park on 28 localities. These were the following management units (MU): Kožica, Leva reka, Čezava, Desna reka, Boljetinska reka, Porečke šume, Djerdap, Štrbačko korito, Zlatica, Crni vrh. The localities and corresponding management units where samples were collected were intentionally selected in order to be able to compare activity levels of <sup>137</sup>Cs and <sup>40</sup>K with the activity levels determined in samples collected in 2006 or 2010<sup>6-8</sup>.

The samples of mosses and substrate were dried in air and then homogenized, and the activities were measured gamma-spectrometrically. Radioactivity measurements were performed using an HPGe gamma-ray spectrometer (ORTEC-AMETEK, with 8192 channels, resolution of 1.65 keV and relative efficiency of 34% at 1.33 MeV for <sup>60</sup>Co). Samples were measured in Marinelli vessels 1.0 L. Sample weight was about 0.1 kg (moss) to 1.0kg (substrate). The counting time for each sample was 60000 s. The relative

error for sample preparation and measurement was 10%. Gamma Vision 32 MCA emulation software was used to analyze gamma-ray spectra. The specific activity of the artificially produced radionuclide  $^{137}\text{Cs}$  was measured via the  $\gamma$ -line at the energy of 661.6 keV. The specific activity of the  $^{40}\text{K}$  radionuclide was determined from its 1460.8 keV gamma-ray line. Nuclides were identified using a library driven search routine and quantitative analyses were carried out using the appropriate detector calibration. Radionuclide results were reported in Bq/kg on a dry weight basis.

## RESULTS AND DISCUSSION

Table 1 shows the localities in the NP Djerdap where moss and substrate samples were collected in May 2015, activity levels of  $^{137}\text{Cs}$  and  $^{40}\text{K}$  in them (Bq/kg), and also data from 2006 and 2010. Both radionuclides were present in all samples.

Activity levels of  $^{137}\text{Cs}$  (Bq/kg) in dry moss from NP Djerdap collected in 2015 were from 9.2 (sample 7) to 512 (sample 25). Average activity levels of  $^{137}\text{Cs}$  in moss and the standard deviation was  $125\pm 137$  Bq/kg. Activity levels of  $^{40}\text{K}$  (Bq/kg) in moss were from 51 (sample 27) to 592 (sample 24). Average activity levels of  $^{40}\text{K}$  in moss and the standard deviation was  $172\pm 97$  Bq/kg. Activity levels of  $^{137}\text{Cs}$  (Bq/kg) in moss substrates collected in 2015 were from 36 (sample 10) to 2047 (sample 34). Average activity levels of  $^{137}\text{Cs}$  in substrates and the standard deviation was  $571\pm 863$  Bq/kg. Activity levels of  $^{40}\text{K}$  in substrates (Bq/kg) were from 133 (sample 30) to 660 (sample 34). Average activity levels of  $^{40}\text{K}$  in substrates and the standard deviation was  $396\pm 247$  Bq/kg.

Of the 19 moss samples analyzed in 16 samples lower activity levels of  $^{137}\text{Cs}$  were measured in 2015 than in 2006 or 2010. The ratio between previous and current activity levels was from 0.2 (sample 25) to 22 times (sample 6). In three samples the activity levels of  $^{137}\text{Cs}$  were higher than in the previous years. This is not the result of new contaminations with this radionuclide, but rinsing  $^{137}\text{Cs}$  from the substrate with water and additional pollution of the ecosystem. Of 19 samples lower activity levels of  $^{40}\text{K}$  were measured in 13 samples in 2015 compared to 2006 or 2010. The ratio between previous and current activity levels in moss was from 0.4 (sample 12) to 3.1 (sample 5).

The activity levels of  $^{137}\text{Cs}$  and  $^{40}\text{K}$  determined in moss and moss substrates were used to calculate the transfer factors and these values are given in Table 2. The transfer factor (TF) represents the ratio between radionuclide activity in moss and the activity level in the substrate (Bq/kg).

Transfer factors of moss substrates for  $^{137}\text{Cs}$  were from 0.11 to 1.16 (average value 0.55). Transfer factors of moss substrates for  $^{40}\text{K}$  were from 0.24 to 1.05 (average value 0.53).

**Table 1.** Activity levels (Bq/kg) of <sup>137</sup>Cs and <sup>40</sup>K in moss and substrate samples on localities in NP Djerdap, measured in 2015, and data measured in 2006 and 2010.

S. No.	LOCALITY, Management unit MU, (division), mnv*	Activity (Bq/kg)			
		<sup>137</sup> Cs 2015	<sup>137</sup> Cs/year	<sup>40</sup> K 2015	<sup>40</sup> K/year
1.	MU Kožica, (26/a)	33	127/2010	93	240/2010
2.	MU Kožica, (63/a), 590 mnv	17.5	---	113	---
3.	MU Leva reka, (27/a), 400 mnv	67	304/2006	118	---
4.	MU Leva reka, (29/a), 250 mnv	22	166/2006	124	233/2006
5.	MU Čezava, (36/a), 400 mnv	44	72/2006	123	386/2006
6.	MU Čezava, (37/d), 380 mnv	9.4	208/2010	89	238/2010
7.	MU Čezava, (40/a), 150 mnv	9.2	---	144	---
8.	MU Desna reka, (1/c), 170 mnv	22	---	220	---
9.	MU Desna reka, (47/a), 320 mnv	38	190/2006	153	174/2006
10.	Substrate MU Desna reka, (47/a),320 mnv	36	---	145	---
11.	MU Desna reka, (56/b), 200 mnv	115	---	127	---
12.	MU Boljetinska reka, (2D), 480 mnv	31	---	165	249/2010
13.	MU Boljetinska reka, (9/c), 490 mnv	39	---	229	---
14.	Substrate MU Boljetinska reka, (9/c)	130	---	598	---
15.	Boljetinska reka, (10/a), 460 mnv	296	---	278	184/2010
16.	MU Porečka wood, (44)	51	---	163	160/2010
17.	MU Porečka wood, (60)	50	199/2010	153	157/2010
18.	MU Štrbačko korito, (47a)	45	82/2006	96	---
19.	MU Djerdap, Manastirački gaj, (8a)	133	83/2006	152	154/2006
20.	MU Djerdap, Brzujka, (41a)	78	---	120	---
21.	MU Djerdap, Brzujka	243	508/2006	176	191/2006
22.	MU Djerdap, Faca Tekija, (48b)	127	365/2006	124	172/2006
23.	MU Djerdap, (67i)	151	186/2006	194	471/2006
24.	MU Djerdap, (75b)	226	131/2006	592	284/2006
25.	MU Djerdap, Popovac, (78f)	512	124/2006	192	108/2006
26.	Substrate, MU Djerdap, Popovac, (78f)	632	---	442	---
27.	MU Djerdap, Dafin	30	158/2006	51	---
28.	MU Zlatica, (86/a)	120	---	257	248/2010
29.	MU Zlatica, (86/b)	73	87/2010	125	190/2010
30.	Substrate, MU Zlatica, (86/b)	63	---	133	---
31.	MU Crni vrh, Donji Milanovac	230	451/2010	156	115/2010
32.	MU Crni vrh, D. Milanovac	303	3463/2006	210	481/2006
33.	MU Crni vrh, D. Milanovac	504	847/2010	237	98/2010
34.	Substrate, MU Crni vrh, D. Milanovac	2047	3892/2006	660	521/2006

\*mnv – altitude

**Table 2.** Activity levels of  $^{137}\text{Cs}$  and  $^{40}\text{K}$  (Bq/kg) in moss and moss substrates and transfer factors

S. No.	LOCALITY	$^{137}\text{Cs}$ (Bq/kg)	TF	$^{40}\text{K}$ (Bq/kg)	TF
1.	MU Desna reka, 47/a	38	1.05	153	1.05
2.	podloga MU Desna reka, 47/a	36		145	
3.	MU B reka, 9/c	39	0.30	229	0.38
4.	Substrate MU B reka, 9/c	130		598	
5.	MU Djerdap 78f	512	0.81	192	0.43
6.	podloga, MU Djerdap 78f	632		442	
7.	MU Zlatica, 86/b	73	1.16	125	0.94
8.	Substrate, MU Zlatica, 86/b	63		133	
9.	MU Crni vrh, Donji Milanovac	230	0.11	156	0.24
10.	MU Crni vrh, D. Milanovac	303	0.15	210	0.32
11.	MU Crni vrh, D. Milanovac	504	0.25	237	0.36
12.	Substrate, MU Crni vrh, D.M.	2047		660	

### CONCLUSION

The presence of radionuclides was established in all moss samples. This confirmed that moss is a good bioindicator of environment pollution.

Activity levels of  $^{137}\text{Cs}$  and  $^{40}\text{K}$  in moss samples from the Djerdap national park indicate that there was no new contamination with  $^{137}\text{Cs}$  on the territory of Eastern Serbia, or it was below measurement errors

### Acknowledgement

This work was financed by the Ministry for Education, Science and Technological development of the Republic of Serbia (Project number: III 43009)

### REFERENCES

1. Vukanović, V., Atomistika, Naučna knjiga, Beograd, 1977.
2. Savezni komitet za rad, zdravstvo i socijalnu zaštitu, "Nivo radioaktivne kontaminacije čovekove sredine i ozračenosti stanovništva Jugoslavije 1986. godine usled havarije nuklearne elektrane u Černobilju", Beograd, 1987.
3. Gržetić, I., Jelenković R.J., Prirodni radioaktivni elementi, geološko poreklo i oblici pojavljivanja i migracije, monografija: Jonizujuća zračenja iz prirode, Jugoslovensko društvo za zaštitu od zračenja, Beograd, INN Vinča, 1995, 3-39.
4. Richardson, D.H.S., The Biology of Mosses, Blackwell Scientific Publications, Oxford, 1981.
5. Čučulović A., Veselinović D., Miljanić Š.S., Akumulacija radionuklida u bioindikatorima NP Djerdap, Zbornik radova Ekološka istina, EkoIst'05, Univerzitet u Beogradu, Tehnički fakultet u Boru, Borsko Jezero, 2005, 105-108.

6. Čučulović A., Veselinović D., Nivoi aktivnosti  $^{137}\text{Cs}$  u uzorcima mahovina sa područja NP Đerdap, Zbornik radova Ekološka istina, EkoIst'08, Univerzitet u Beogradu, Tehnički fakultet u Boru, Sokobanja, 2008, 43-46.
7. Čučulović A., Veselinović D., Nivoi aktivnosti  $^{137}\text{Cs}$  i  $^{40}\text{K}$  u mahovina Istočne Srbije, Zbornik radova Ekološka istina, EkoIst'09, Univerzitet u Beogradu, Tehnički fakultet u Boru, Kladovo, 2009, 37-40.
8. Čučulović A., Marković D., Čučulović R., Veselinović D., Moss as biomonitors of radio pollution of NP Djerdap, Proceedings, EkoIst'10, Univerzitet u Beogradu, Tehnički fakultet u Boru, Banja Junaković, 2010, 57-60.





**TOWARDS ASSESSING GENETIC DIVERSITY OF *Theodoxus danubialis*  
(C. PFEIFFER, 1828)(GASTROPODA; NERITIDAE) FROM  
CENTRAL BALKAN**

**Katarina Zoric<sup>1\*</sup>, V. Markovic<sup>1</sup>, J. Tomovic<sup>1</sup>, A. Atanackovic<sup>1</sup>, B. Vasiljevic<sup>1</sup>,  
J. Canak Atlagic<sup>1</sup>, S. Andjus<sup>1</sup>, M. Kracun-Kolarevic<sup>1</sup>, N. Marinkovic<sup>1</sup>, N. Popovic<sup>1</sup>,  
M. Rakovic<sup>1</sup>, J. Djuknic<sup>1</sup>, V. Djikanovic<sup>1</sup>, B. Tubic<sup>1</sup>, M. Ilic<sup>1</sup>, M. Paunovic<sup>1</sup>,  
V. Nikolic<sup>2</sup>, G. Stamenkovic<sup>1</sup>**

<sup>1</sup>University of Belgrade, Institute for Biological Research "Sinisa Stankovic",  
Bulevar despota Stefana 142, 11000 Belgrade, SERBIA

<sup>2</sup>Department of Zoology, Faculty of Biology, University of Belgrade,  
Studentskitrg 16, 11000 Belgrade, SERBIA

\*katarinas@ibiss.bg.ac.rs

**ABSTRACT**

Specimens from three populations of native neritid snail *Theodoxus danubialis* (C. Pfeiffer, 1828) from the Balkan (the Una, Lepenica and Nišava Rivers) were processed. Obtained 16s rRNA sequences, along with additional sequences taken from GenBank were analysed. Maximum likelihood consensus tree showing relations of plotted sequences was discussed. Sequences from the Nišava River sample differ from the other *T. danubialis* sequences, pointing to specific 16s rRNA haplotype. In order to better assess intraspecific variability and diversity of *T. danubialis*, an use of less conservative markers should be implemented.

**Key words:** 16s rRNA, haplotype, Danube nerite, Balkan.

**INTRODUCTION**

*Theodoxus danubialis*, Danube nerite, as the name suggests, is native to the Danube and its tributaries. Although not on the IUCN red list of threatened species, this species is critically endangered in the northern part of its range: Germany [1], Austria [2] and Czech Republic (Red List of the molluscs (Mollusca) of the Czech Republic). Danube nerite, once common in large rivers, today mainly has been observed in the Danube tributaries and smaller watercourses [3].

The 16s RNA is one of the most popular and widely used mitochondrial markers in phylogeography studies. The *Theodoxus* genus, although being one of the oldest and the most interesting snail lineages, and despite efforts of a few authors is yet rather understudied. This is particularly true in the case of the Balkan, which although considered as one of the most important regions of Europe, regarding biodiversity, is till date poorly studied. Hence, we aim to assess genetic variability and diversity of

members of this snail genus in the Balkan. Here we present results of preliminary analysis regarding 16s rRNA variability in the case of *T. danubialis* from this region.

## MATERIAL AND METHODS

For our analysis we used snail specimens from the samples from the Una, Nišava and Lepenica Rivers. All samples were fixed in 95% ethanol and stored in the zoological collection of Institute for Biological Research Siniša Stanković (IBISS), Belgrade, Serbia.

An identification of snails was performed using appropriate determination keys [4, 5].

In total, 10 individuals from three populations of *T. danubialis* were processed. The DNA was extracted from the snail material (the foot and the head of snail specimens) by using the kit for the isolation of genomic DNA from eukaryotes tissues (AccuPrep® Genomic DNA Extraction Ki, Bioneer Inc. Alameda, CA, USA). Universal primers 16Sar and 16Sbr [6] were used, and PCR products were obtained according to the protocol given in [7]. An automatic sequencing of amplified 16s rRNA fragments, were done bidirectional, on an automatic sequencer by chain-termination method (ABI 310, AppliedBiosystems, Foster, CA, USA). Obtained amplicons were sequenced using BigDye Terminator Cycle Sequencing v.3.1 kit (PE Applied Biosystems, Foster City, CA, USA), and the sequences were read using an appropriate software (ABI software v.5.1 and Sequencing Analysis SeqScape software, v.2.5). In order to assess the quality of acquired forward and reverse 16s rRNA sequences (chromatograms), and to eliminate ambiguities in these sequences, the software Finch TV, v.1.4.0 (<http://www.geospiza.com>) was used. For analysis purposes, an additional 16s r RNA sequences of *Theodoxus* and *Nerita polita* (as outgroup) were taken from the GenBank (<http://www.ncbi.nlm.nih.gov/genbank>). Assess numbers and basic information of these sequences are provided in the Table 1.

An alignment of all analysed sequences was done by Clustal W method [8] in the software MEGA, ver. 5.2 [9]. Phylogenetic analysis and cladograms were performed by Maximum likelihood method (ML) [10] in the same software. In order to assess the most suitable ML model, the lowest BIC (Bayesian Information Criterion) scores were tested [11] by phylogenetic Bootstrap analysis, a popular statistical method for estimating the mean values in phylogenetic analyses [12].

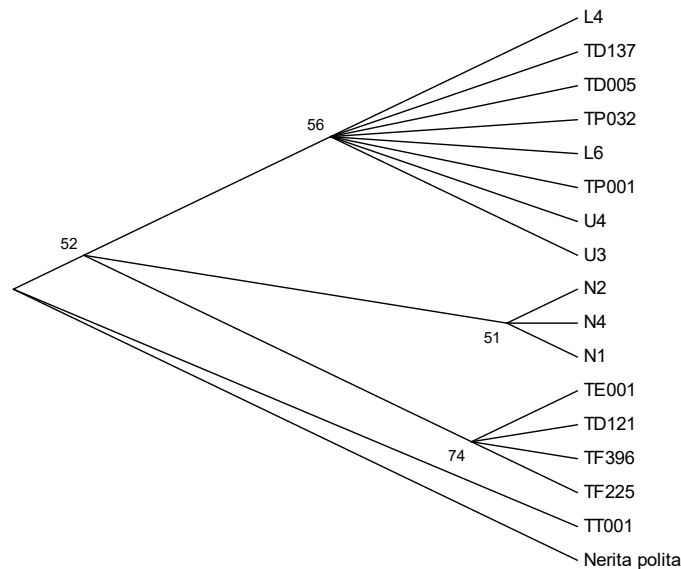
**Table 1.** Basic data on 16S rRNA sequences taken from GenBank

Species	Code	Access Number (GenBank)	Locality
<i>T. danubialis</i>	TD005	AY771236	Garda, Italija
<i>T. danubialis</i>	TD137	AY771238	Kustány, Mađarska
<i>T. danubialis</i>	TD093	AY771236	Pischeldorf, Austrija
<i>T. prevostianus</i>	TP001	AY771254	Bad Vöslau, Austrija
<i>T. prevostianus</i>	TP032	AY771255	Kács, Mađarska
<i>T. euxinus</i>	TE001	AY771239	Bilhorod-Dnistrovs'kyi, Ukrajina
<i>T. fluviatilis</i>	TF396	AY771245	Rugia, Nemačka
<i>T. fluviatilis</i>	TF225	AY771241	Rheinsberg, Nemačka
<i>T. fluviatilis</i>	TD121	AY771237	Esztergom, Mađarska
<i>T. transversalis</i>	TT001	AY771259	Edelény, Mađarska
<i>Neritapolita</i>	/	KJ458472	

\*sequences coded TD005 and TD093, belong to the same haplotype (access number AY771236), so for the analysis was used only one of them (TD005)

## RESULTS AND DISCUSSION

The chromatograms of forward and reverse 16S rRNA sequences of 10 specimens from three snail populations (Una (code "U"), Lepenica (L) and Nišava (N)) have been reviewed by software FinchTV (ver. 1.4.0) and from further analysis were excluded three sequences (L1, N3 and U5) due to insufficient quality (i.e. high ambiguity). The minimum length of remaining sequences selected for further analysis was 296bp (base pairs). A substitution of purine bases (adenine (A) instead of guanine (G)) at 154<sup>th</sup> nucleotide site in sequences from the Nišava was spotted, pointing to a separate haplotype. Moreover, registered pyrimidine ambiguity (cytosine (C)/thymine (T)) at the 159<sup>th</sup> nucleotide site in case of one "Nišava sequence" (N1) could indicate another potential base substitution, i.e. another new haplotype. Testing of most suitable ML models for analysis, was carried out in accordance with the lowest BIC scores, and as the most suitable model singled out "Tamura 3-parameter" substitution model with gamma-distributed substitution pattern, which then was applied to perform phylogenetic analysis. The obtained bootstrap consensus tree based on 500 replicates was shown in Figure 1.



**Figure 1.** Consensus ML (Maximum likelihood) tree based on 16S rRNA sequences. Bootstrap values are shown for branches with more than 50% support. The tree is rooted with outgroup *Nerita polita*. The sequences taken from GenBank are coded as follows: species are labelled as TF for *T. fluviatilis*, TD for *T. danubialis*, and TT for *T. transversalis*, with three-digit numbers as suffix; our sequences of *T. danubialis* are labelled as N (Nišava), L (Lepenica) and U (Una), with single-digit numbers.

Observing this result a few points should be made. Firstly, used 16S rRNA marker is not so suitable for resolution at finer taxonomic scale (intraspecific analysis) in

case of these snails, given its pronounced phylogenetic conservatism and relative youth especially close-related species of snails. This is consistent with the literature, so besides Bunje [7,13], 16Sr RNA was rarely had been used for analyses of this genus. In GenBank only two 16Sr RNA haplotypes of *T. danubialis* (Table 1) could be found till date. Our analysis thus gains importance, particularly by indicating presence of a new, separate haplotypes from the Nišava sample. These "Nišava haplotypes" were separated from the others by only one (or two, in case of N1 specimen) base/nucleotide substitution. Similar result with low degree of divergence for this snails was obtained by [14] in his comprehensive analysis of *T. danubialis*/*T. prevostianus* based on another conservative mitochondrial marker COI.

Similar research to [14] was conducted by [15], but samples from the eastern part of *T. danubialis* range (the Drina, Nišava and Crni Timok Rivers) were included as well. According to these authors *T. danubialis* populations from the area we investigated here, belong to so-called "central group", which includes the "Danube clade" (D2; the Nišava sample), and the "Sava clade" (S; The Kupa River and the Drina, as the samples geographically nearest to our samples). In the same research a segregation of haplotypes from the Nišava (and the Crni Timok) relative to western haplotypes from this "central group" was observed. These COI data are in accordance with our findings (based on 16s rRNA), and point to distinction of the eastern (the Nišava) populations. Moreover, a more than one "Nišava haplotype" could be present, according to our 16s r RNA analysis. Observed genetically differences of the Nišava populations were supported by morphological differences, registered, as well [3]. In order to better assess genetically variability of *T. danubialis*, an additional samples from this area should be analysed, and additional and less conservative molecular markers used. As there is general lack of data from the eastern part of *T. danubialis* range (and the Balkan) our result could be considered as a small complement to knowledge regarding genetic diversity of these snails.

#### **Acknowledgements**

*This study was supported by the Ministry of Education, Science and Technological Development of the Republic of Serbia, Projects TR 37009 and III 43002. The authors would like to thank colleagues from the Institute for Water, Bijeljina (RepublikaSrpska, BiH) for valuable help during field research.*

#### **REFERENCES**

1. Jungbluth J. H., Von Knorre D. (2009). Rote Liste der Binnenmollusken [Schnecken (Gastropoda) und Muscheln (Bivalvia)] in Deutschland. 6. revidierte und erweiterte Fassung 2008. *Mitteilungen der Deutschen Malakozoologischen Gesellschaft*, **81**: 1-28.
2. Reischütz A., Reischütz P. L. (2007). Rote Liste der Weichtiere (Mollusca) Österreichs, 150 pp.
3. Marković V. (2014). Morfološkavarijabilnost i distribucija roda *Theodoxus* Montfort, 1810 (Neritomorpha, Gastropoda) u centralnom delu Balkanskog

- poluostrva i na južnom obodu Panonske nizije. Disertacija, Univerzitet u Beogradu, 142.str (eng. Morphological variability and distribution of *Theodoxus* Montfort, 1810 (Neritomorpha, Gastropoda) in the central Balkan and southern edge of Pannonian plain)
4. Pflieger V. (1999). A field guide in colour to Molluscs. Blitz Editions, Leicester, United Kingdom, 216 pp.
  5. Glöer P. (2002). Süßwassergastropoden Nord-und Mitteleuropas: Bestimmungsschlüssel, Lebensweise, Verbreitung, ConchBooks, Hackenheim, **73**: 327 pp.
  6. Hillis D. M., Mable B. K., Larson A., Davis S .K., Zimmer E.A. (1996). Nucleic acids IV: sequencing and cloning. In: Hillis, D.M., Moritz, C., Mable, B.K. (Eds.), *Molecular Systematics*. Sinauer, Sunderland, Mass, pp. 321–381.
  7. Bunje P. M., Lindberg D. R. (2007). Lineage divergence of a freshwater snail clade associated with post-Tethys marine basin development. *Molecular Phylogenetics and Evolution*, **42**: 373-387.
  8. Thompson B. (2004). Exploratory and confirmatory factor analysis: Understanding Concepts and Applications. American Psychological Association, Washington, 195 pp.
  9. Tamura K., Peterson D., Peterson N., Stecher G., Nei M., Kumar S. (2011). MEGA5: molecular evolutionary genetics analysis using maximum likelihood, evolutionary distance, and maximum parsimony methods. *Molecular biology and evolution*, **28**: 2731-2739.
  10. Tamura K. (1992). Estimation of the number of nucleotide substitutions when there are strong transition-transversion and G + C-content biases. *Molecular Biology and Evolution*, **9**: 678-687.
  11. Nei M., Kumar S. (2000). *Molecular Evolution and Phylogenetics*. Oxford University Press, New York, 333 pp.
  12. Felsenstein J. (1985). Confidence limits on phylogenies: An approach using the bootstrap. *Evolution*, **39**:783-791.
  13. Bunje P. M. (2004). Diversification and comparative phylogeography of neritid gastropods. *Unpublished PhD Dissertation*, University of California, Berkeley, pp. 411.
  14. Bunje P. M. (2007). Fluvial range expansion, allopatry, and parallel evolution in a Danubian snail lineage (Neritidae: *Theodoxus*). *Biological Journal of the Linnean Society*, **90**: 603–617.
  15. Fehér Z., Zettler M., Szabo K. (2009). An attempt to reveal the systematic relationship between *Theodoxus prevostianus* (C. Pfeiffer, 1828) and *Theodoxus danubialis* (C. Pfeiffer, 1828) (Mollusca, Gastropoda, Neritidae). *Mollusca*, **27**: 95-107



## ASSESSMENT OF BIOPOLLUTION IN THE SERBIAN PART OF THE DANUBE RIVER

Katarina Zoric\*, V. Markovic, J. Tomovic, A. Atanackovic, B. Vasiljevic,  
J. Canak Atlagic, S. Andjus, M. Kracun-Kolarevic, N. Marinkovic,  
N. Popovic, M. Rakovic, J. Djuknic, V. Djikanovic, M. Ilic, B. Tubic, M. Paunovic

University of Belgrade, Institute for Biological Research "Sinisa Stankovic",  
Bulevar despota Stefana 142, 11000 Belgrade, SERBIA

\*katarinas@ibiss.bg.ac.rs

### ABSTRACT

Introduction of alien species in aquatic ecosystems may or may not produce negative ecological and/or socio-economic impacts. In a case where impacts of introduced alien species are measurable, the biological pollution of the ecosystem should be evaluated. Assessment of biopollution of the Serbian reach of the Danube River was based on samples collected during August and September 2013. In total, 20 alien macroinvertebrate species were registered. For four species strong biopollution level was estimated: *Chelicorophium curvispinum*, *Corbicula fluminea*, *Dikerogammarus villosus* and *Dreissena polymorpha*. As these species were already proven to be highly invasive in other European waterways it indicates that applied biopollution level could be a valuable method for estimation of invasiveness of alien species.

**Key words:** Allochthonous macroinvertebrates, Danube River, BPL index, Serbia.

### INTRODUCTION

Danube River is the second largest river in Europe with a 2857 km long watercourse. The Serbian stretch of the Danube is about 20.6% of its total length which is 588 km [1], from Bezdan to the mouth of the Timok River. Along this stretch a numerous tributaries are present. Among them the Tisa with catchment area of 157200 km<sup>2</sup> and the Sava with catchment area of 96400 km<sup>2</sup> are two the most significant tributaries not only in Serbia, but regarding entire Danube basin [1].

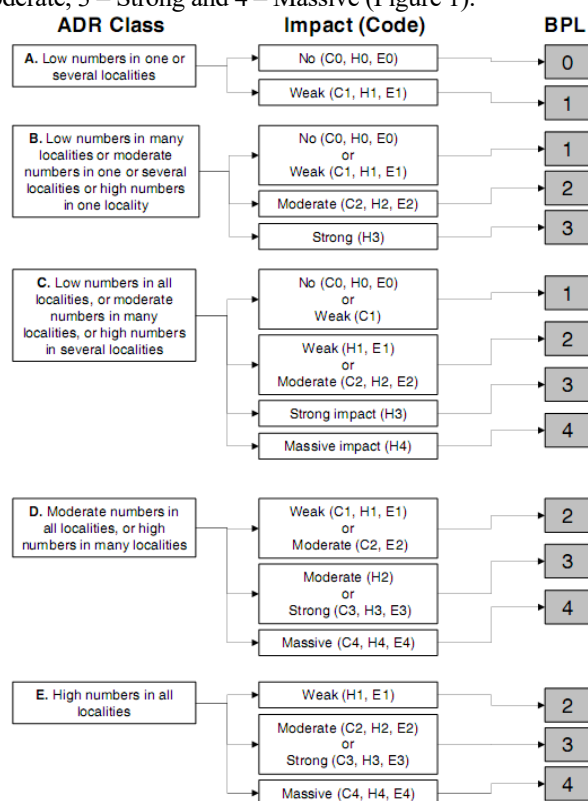
The examined sector of the Danube is highly affected by hydromorphological alterations, the most notable by damming. A construction of two dams and hydropower plants (Iron Gate I and II) at rkm 943 and rkm 862.8 led to a permanent modification of natural conditions [2] which had pronounced effect on native communities and ecosystem as well.

As a part of a South Invasion Corridor, the Danube River basin is one of the most interesting area for monitoring of alien species [3], but allochthonous species of the Danube and other aquatic ecosystems in Serbia were studied in more details only in a few publications [4, 5, 6, 7, 8, 9]. On the other hand, risk assessment methodology for biological invasions was thoroughly studied for the entire watercourse of the Danube [10] with special emphasis on the territory of Serbia.

## MATERIAL AND METHODS

Macroinvertebrate samples were collected in August and September 2013 during the International expedition Joint Danube Survey 3 supported by International Commission for the Protection of the Danube River (ICPDR). In total, 16 localities of the main course of the Danube in Serbia were examined: upstream from the Drava confluence, Bogojevo, Bačka Palanka, Novi Sad (upstream and downstream), Stari Slankamen, upstream from the Sava confluence, Pančevo (upstream and downstream), Velika Morava confluence (upstream and downstream), Banatska Palanka, Golubac, Tekija, Vrbica and locality upstream from the Timok confluence. Benthic samples were taken by benthological hand net (mesh size 500 µm and 1000 µm).

In order to estimate the biopollution of the Danube in Serbia Biopollution level (BPL) was used [11]. Assessment of the biopollution level is one of the most comprehensive methods regarding the effects of introduced alien species, because it combines alien species abundance and distribution in relation to their impacts on community, habitat and ecosystem functioning. According to this method five levels of biopollution could be estimated: 0 – No, 1 – Weak, 2 – Moderate, 3 – Strong and 4 – Massive (Figure 1).



**Figure 1.** Scheme for assessment of Biopollution level (BPL). ADR was used for abundance and distribution range, C for community, H for habitats and E for ecosystem – according to [11].

## RESULTS AND DISCUSSION

During the expedition 20 allochthonous macroinvertebrate species were found in the examined sector of the Danube. Based on the level of biopollution, for 16 alien species negative impact was confirmed, while for four species BPL was not evaluated. Of all species high D class was only estimated for two species – *Corophium curvispinum* and *Dikerogammarus villosus*, due to moderate numbers of individuals in many or all localities. Strong impact on community, habitat and/or ecosystem was assessed for species: *Corbicula fluminea*, *Dikerogammarus villosus*, *Dreissena polymorpha*, *Dreissena bugensis*, *Orconectes limosus*, *Pectinatella magnifica* and *Sinanodonta woodiana*. In accordance with abovementioned, strong biopollution level (BPL= 3) have had four species: *C. curvispinum*, *C. fluminea*, *D. villosus* and *D. polymorpha*. Massive biopollution level (BPL= 4) was assessed for none species.

Negative impacts on one or all components of the ecosystems of those four species contribute to their assessed strong biopollution level. For example, numerous experimental studies had proven predations of *D. villosus* on native amphipod species [12], which in combination with its high fertility and fecundity rate could cause severe impacts on macroinvertebrate and moreover fish communities in freshwater ecosystems [13]. Another allochthonous amphipod species *C. curvispinum* is one of the most widespread species in Europe [14]. Its high growing rate, an early maturation with few generations yearly and high fecundity rate, are stated as the most important features contributing to its rapid colonisation of European waterways [15]. An invasion potential of *D. polymorpha* has been increased by presence of free-living larval stage with high dispersion potential [16], wide ecological tolerance (for example, temperature and dissolved oxygen concentration) as well as ability to survive short period outside water [17]. Beside mainly negative impact, positive effects between *D. polymorpha* and two other allochthonous amphipod species *C. curvispinum* and *E. ishnus* are well documented, as well as their positive effects on native fauna [18, 19].

Registered species were already proven to be highly invasive in aquatic ecosystems all around Europe, indicating that biopollution level could be a valuable method for estimation the level of biological invasions of certain region. Risk assessment methodology on national level, should include this parameter as well, for more accurate estimation of impacts of allochthonous species.

### *Acknowledgements*

*This study was supported by the Ministry of Education, Science and Technological Development of the Republic of Serbia, Projects TR 37009 and III 43002.*

## REFERENCES

1. Babić Mladenović, M., Kolarov, V. (2010). Natural characteristics of the Danube River in Serbia. In: Danube in Serbia – Joint Danube Survey 2 (eds. Paunović, M., Simonović, P., Simić, S., Simić, V.). Directorate for Water Management, Belgrade, pp. 59-78.



2. Petkovic, S., Babic-Mladenovic, M., Damnjanovic, M. (2004). Technical, Hydrological And Environmental Aspects of Iron Gate I and II, Report on International IAD Workshop „Hydrology and Limnology – another boundary in the Danube River Basin“, Vienna, Austria, pp. 42-44.
3. Panov, V.E., Alexandrov, B., Arbaciauskas, K., Binimelis, R., Copp, G.H., Grabowski, M., Lucy, F., Leuven, R.S.E.W., Nehring, S., Paunovic, M., Semenchenko, V., Son, M.O. (2009). Assessing the Risks of Aquatic Species Invasions via European Inland Waterways: From Concepts to Environmental Indicators. *Integrated Environmental Assessment and Management* 5(1): 110-126.
4. Paunovic, M., Borkovic, S.S., Pavlovic, S.Z., Saicic, Z.S., Cakic, P.D. (2008). Results of the 2006 Sava Survey – aquatic macroinvertebrates. *Archives of Biological Sciences* 60(2): 265-271.
5. Tomović, J., Csanyi, B., Stefanović, K., Atanacković, A., Tubić, B., Cakić, P., Paunović, M. (2010). Alien Mollusca in Serbian waters. BALWOIS Conference, Ohrid, Macedonia.
6. Zorić, K., Vranković, J., Cakić, P., Tomović, J., Vasiljević, B., Simić, V., Paunović, M. (2010b). Introduced species of aquatic macroinvertebrates. In: *Danube in Serbia – Joint Danube Survey 2* (eds. Paunović, M., Simonović, P., Simić, V., Simić, S.). Directorate for Water Management, Belgrade, pp. 267-280.
7. Zorić, K., Jakovčev-Todorović, D., Đikanović, V., Vasiljević, B., Tomović, J., Atanacković, A., Simić, V., Paunović, M. (2011). Distribution of the Ponto-Caspian polychaeta *Hypnina invalida* (Grube, 1860) in inland waters of Serbia. *Aquatic Invasions* 6(1): 33-38.
8. Zoric, K., Markovic, V., Vasiljevic, B., Tomovic, J., Atanackovic, A., Ilic, M., Kracun, M., Paunovic, M. (2013). Alien macroinvertebrate species of the Velika Morava River. „EcoIst '13“, Conference Proceedings, Bor, Serbia, pp. 43-47.
9. Zoric, K., Vasiljevic, B., Tomovic, J., Atanackovic, A., Tubic, B., Popović, N., Raković, M., Novaković, B., Paunovic, M. (2015). Allochthonous macroinvertebrate species of the Serbian stretch of the Tisa River. „EcoIst '15“, Conference Proceedings, Kopaonik, pp. 621-624.
10. Zorić, K. (2015). Invasiveness of allochthonous macroinvertebrate and fish species of the Danube River. Doctoral dissertation. University of Belgrade, Faculty of Biology, p. 141. [in Serbian]
11. Olenin, S., Minchin, D., Daunys, D. (2007). Assessment of biopollution in aquatic ecosystems. *Marine Pollution Bulletin* 55: 379-394.
12. Dick, J.T.A., Platvoet, D. (2000). Invading predatory crustacean *Dikerogammarus villosus* eliminates both native and exotic species. *Proceedings of Royal Society of London, Series B* 267: 977-983.
13. Devin, S., Piscart, C., Beisel, J.N., Moreteau, J.C. (2003). Ecological traits of the amphipod invader *Dikerogammarus villosus* on a mesohabitat scale. *Archiv für Hydrobiologie* 158(1): 43-56.
14. Van der Velde, G., Rajagopal, S., Kelleher, B., Muskó, I.B., Bij de Vaate, A. (2000). Ecological impact of crustacean invaders: general considerations and examples from the River Rhine. U: *The biodiversity crisis and Crustacea:*

- Proceedings of the 4th International Crustacean Congress (ur. Von Vaupel Klein, J.C., Schram, F.R.). Amsterdam, Brill, Leiden, Crustacean Issues, pp. 3-33.
15. Den Hartog, C., Van den Brink, F.W.B., Van der Velde, G. (1992). Why was the invasion of the river Rhine by *Corophium curvispinum* and *Corbicula* species so successful? *Journal of Natural History* 26: 1121-1129.
  16. Stoeckel, J.A., Schneider, D.W., Soeken, L.A., Blodgett, K.D., Sparks, R.E. (1997). Larval dynamics of a riverine metapopulation: implications for zebra mussel recruitment, dispersal, and control in a large river system. *Journal of North American Benthological Society* 16: 586-601.
  17. Zaiko, A., Lehtiniemi, M., Narščius, A., Olenin, S. (2011). Assessment of bioinvasion impacts on a regional scale: a comparative approach. *Biological Invasions* 13: 1739-1765.
  18. Jażdżewski, K., Konopacka, A. (2002). Invasive Ponto-Caspian species in waters of the Vistula and Oder basin and the southern Balic Sea. U: *Invasive Aquatic Species of Europe* (ur. Leppäkoski, E., Gollasch, S. Olenin, S.), Kluwer Academic Publishers, Dordrecht, Boston, London, 384-398.
  19. Köhn, J., Waterstraat, A. (1990). The amphipod fauna of Lake Kummerow (Mecklenburg, German Democratic Republic) with reference to *Echinogammarus ischnus* Stebbing, 1899. *Crustaceana* 58: 74-82.



## INITIAL IMPACT OF NEW BOR COPPER SMELTER ON AIR QUALITY

Tihomir Popovic\*, B. Jovic, J. Knezevic

Serbian Environmental Protection Agency  
Ministry of Agriculture and Environmental Protection, SERBIA

\*[tihomir.popovic@sepa.gov.rs](mailto:tihomir.popovic@sepa.gov.rs)

### ABSTRACT

The paper analyzes the initial impact of new copper smelter in Bor on air quality. Period of working only new smelter, Nov 2015 - May 2016, is estimated comparing with the standard and comparing to the average state before activating a new smelter, which is represented with a several year period 2010 - 2014.

Although in the period when worked only a new smelter, Nov 2015 - May 2016 were exceedences of LV daily concentration of SO<sub>2</sub>, implemented analysis indicates a significant reduction in the frequency and intensity of exceedances; 4 times is rarer exceeding LV, and 7 times rarer exceeding 2 x LV.

**Key words:** AQ in Bor, new copper smelter in Bor, reduction in SO<sub>2</sub> exceeding LV in Bor.

### INTRODUCTION

According to the Law on Air Protection ("Off. Gazette RS" No. 36/09, 10/13) and Regulation on determination of zones and agglomeration ("Off. Gazette RS" No. 58/11, 98/12 and 105/15) Bor area is designated as agglomeration Bor although it has less than 250 000 inhabitants. In accordance with the EU Directive 2008/50/EC it is done due to the specific problem of air quality in the area of Bor.

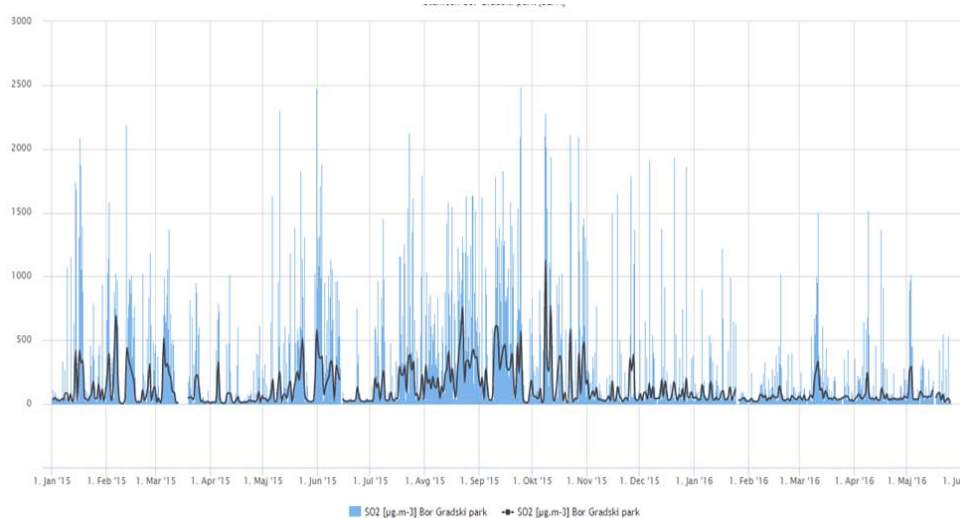
Since the establishment of the national network for automatic air quality monitoring and assessment of air quality in zones and agglomerations, agglomeration Bor has III category of air quality - excessive air pollution [1]. It is only in the agglomeration Bor where sulfur dioxide is pollutant which excessive presence causes this state. Emissions of sulfur dioxide from the copper smelter in Bor were dominant in the Bor area and are one of the largest in Serbia [2].

So, it is understandable expectation that the activation of new copper smelter in Bor, with significantly lower emissions of SO<sub>2</sub>, contribute to the improvement of air quality in Bor. In order to get insight into the initial impact of new copper smelter in Bor on air quality, it was analyzed the intensity and frequency of air pollution in the current period of working only new smelter.

## MATERIALS AND METHODOLOGY

On location Gradski Park, within the national network for air quality monitoring in the Republic of Serbia, AAQMS Bor\_Gradski Park functions operationally. It is one of five AAQMS in the Bor area (others are Bor\_Institut RiM, Bor\_Brezonik, Bor\_Krivelj and recently Bor\_Slatina). At this measuring station were registered the most often and the most intensive exceedings of air quality standards. They were confirmed in 2006 as one of Europe's maximum daily concentration of SO<sub>2</sub>, [3].

Continuous, automatic monitoring of SO<sub>2</sub> is realized with gas analyzers SO<sub>2</sub> TELEDYNE API using the reference method - ultraviolet fluorescence, (SRPS EN 14212). Gas analyzer calibration is done at least twice a year, in calibration laboratory of the Serbian Environmental Protection Agency.



**Figure 1.** Hourly and daily concentrations SO<sub>2</sub> at AAQMS BOR\_Gradski Park in period 1 Jan 2015 - 24 May 2016

For analysis were used daily concentrations of SO<sub>2</sub> from AAQMS Bor\_Gradski Park. Although the new smelter were activated in April 2015, for the assessment of the impact of the new smelter was taken the period after November 1, 2015, when it was suspended the use of the old smelter.

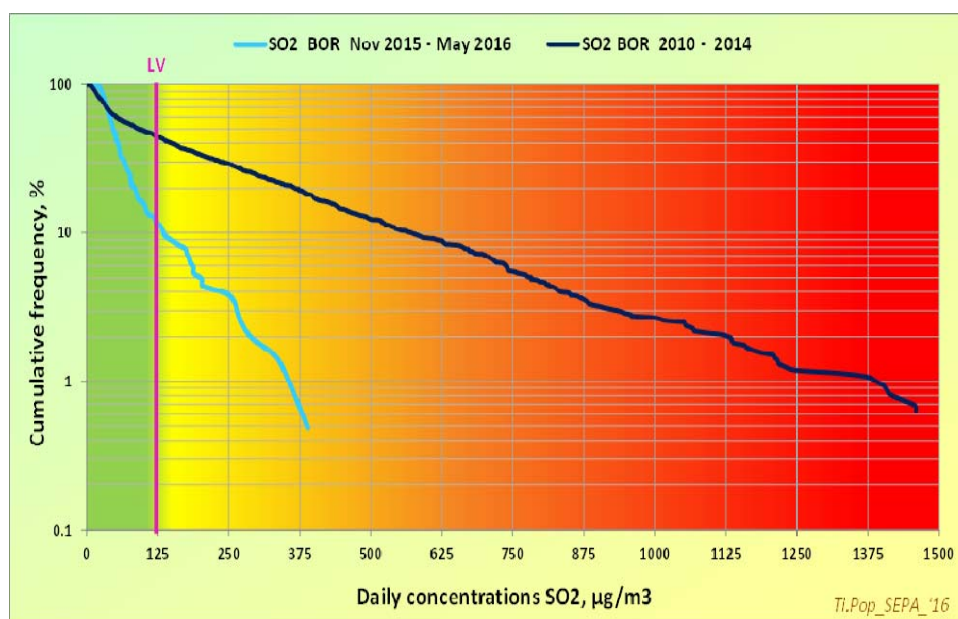
Assessment of the state of air quality in the period 1. XI 2015 do 24. V 2016 (when this paper was written) was carried out in two ways: assessment with comparasion with EU air quality standards, which have been transferred to domestic regulations – Regulation on monitoring conditions and air quality standards (“Off. Gazette RS” No. 11/10, 75/10 and 63/13) and comparing with the values of daily concentration of SO<sub>2</sub> at the same location in the period 2010 – 2014.

For this purpose the appropriate data processing were done for getting empirical cumulative distribution of daily SO<sub>2</sub> concentrations at the site Bor\_Gradski Park.

## RESULTS AND DISCUSSION

Graphic of empirical cumulative distribution of daily concentration of SO<sub>2</sub> in the AAQMS Bor\_Gradski Park in the period 2010-2014 and the period of working only new smelter is shown in Fig. 2.

Review will be used for assessment of the state of air quality in Bor compared to the standard and compared to the average state before activating a new smelter which is represented in several years period 2010 – 2014.



**Figure 2.** Empirical cumulative distribution of daily SO<sub>2</sub> concentrations at the site BOR\_Gradski Park in period 2010-2014 and period of working only new smelter, Nov 2015 – May 2016

During the period of operation only a new smelter, Nov 2015 - May 2016, the limit values, LV, of daily concentrations of SO<sub>2</sub> which is 125 µg/m<sup>3</sup> were exceeded. During the seven-month period of operation only new smelter, the average concentration of SO<sub>2</sub> in the AAQMS Bor\_Gradski Park was 67.8 µg/m<sup>3</sup>, and the number of days with exceedances LV was only 23. The same parameters for year 2015 according to data from the same measuring point was 145.3 µg/m<sup>3</sup> with 139 days with daily concentrations above the LV.

**Table 1.** Empirical probability, in %, of certain or higher daily concentrations of SO<sub>2</sub> in location Bor\_Gradski Park in period 2010-2014 and period of working only new smelter, Nov 2015 – May 2016.

Daily SO <sub>2</sub> , µg/m <sup>3</sup>	BOR XI 2015 - V 2016	BOR 2010 - 2014
125 (1x LV)	11.5	44.5
250 (2x LV)	3.9	29.2
375 (3x LV)	0.5	19.2
1250 (10x LV)	-	1.2

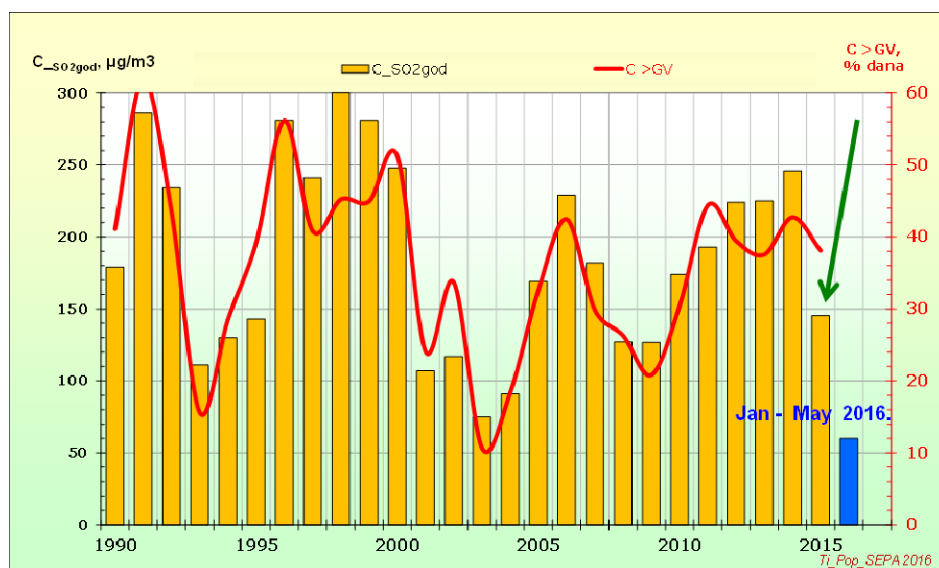
Numerical values of comparison of period of working only a new smelter and average state are given in Tab. 1. The empirical probability of occurrence of daily mean SO<sub>2</sub> concentrations higher than 125 µg/m<sup>3</sup>, which is the LV, in the period of working new smelter is only 11.5%. For the period 2010 - 2014, period that we take as the representative of the average state before working only new smelter, empirical probability of occurrence of daily mean SO<sub>2</sub> concentrations higher than 125 µg/m<sup>3</sup> is 44.5%! This practically means that in the period of working the new smelter is 4 times less chance of occurrence daily concentrations higher than allowed under EU and national regulations.

Available data show that in the previous period exceeding of LV could be several times higher than allowed, [4]. Therefore, in Tab.1 are compared empirical probability for occurrence daily concentrations higher 2, 3 and 10 times than allowed.

During the period of working only new smelter there were cases when the daily value was more than 250 µg/m<sup>3</sup>, which is more than 2 x LV. Their empirical probability of occurrence is 3.9%. Such situations were recorded in the period 2010-2014, but with a probability of 29.2%. For the next period, it practically means that the double exceeding LV can be expected 7 times less than before the start of working only a new smelter.

In the case of a triple exceeding LV reduction of the probability of occurrence is even higher and is even 38 times.

Ten times exceeding LV were recorded in the previous period. In terms of working only new smelter such cases should not be expected more.



**Figure 3.** Annual concentration of SO<sub>2</sub> at the site BOR\_Gradski Park and percentage of days during the year exceeding daily LV in the period 1990-2015

Although only the new smelter worked since the beginning of November 2015, the annual concentration of SO<sub>2</sub> in the AAQMS Bor\_Gradski Park is significantly lower than in previous years, [5]; 2014 it was 246 µg/m<sup>3</sup> and in 2015 it was 145 µg/m<sup>3</sup>, Fig. 3. In the period Jan–May 2016. SO<sub>2</sub> concentrations have dropped to 60 µg/m<sup>3</sup>.

It is important to note that after the 6 previous years with the continual growth of the annual concentration of SO<sub>2</sub> in Bor, the average for 2015 is lower than in previous years.

## CONCLUSION

The initial impact of new copper smelter in Bor on air quality in the city is very encouraging.

Assessment of the state of air quality in Bor was performed compared to the standard and compared to the average state before activating only a new smelter which is represented in several years period 2010 – 2014.

During the period of operation of only a new smelter, Nov 2015 - May 2016, there were the exceedances of limit values of daily concentrations of SO<sub>2</sub>, which indicates the need to continue actions to improve air quality in Bor.

However, an analysis of data from the period when it was only a new smelter, Nov 2015 - May 2016, and the period 2010 – 2014, indicates a decrease in the frequency and intensity of daily exceedances of LV for SO<sub>2</sub> in Bor; 4 TIMES is rarer exceeding LV (125 µg/m<sup>3</sup>), 7 TIMES is rarer exceeding double values of LV (250 µg/m<sup>3</sup>) and for a 38 times rarer occurrence exceeding 3 x LV (375 µg/m<sup>3</sup>).

Reliability of these estimates can be increased by analyzing a longer period of work only a new smelter. The authors will that fact bear in mind in the coming period when such analysis can be repeated.

#### **REFERENCES**

1. Tihomir Popović, B. Jović, L.Marić, J. Knežević, 2015, DO THEY IMPROVE AIR QUALITY - EVALUATION OF AIR QUALITY IN THE REPUBLIC OF SERBIA IN THE PERIOD 2011 -2014 (in Serbian), Udruženje za zaštitu vazduha Srbije, Plenarno predavanje, Zbornik radova, str. 23 – 27, Zrenjanin 2015.
2. Agencija za zaštitu životne sredine 2015, Izveštaj o stanju životne sredine u Republici Srbiji 2014, <http://www.sepa.gov.rs/download/Izvestaj2014.pdf>
3. European Environment Agency, 2008, European exchange of monitoring information and state of the air quality in 2006, ETC/ACC Technical paper 2008/1, [http://acm.eionet.europa.eu/reports/ETCACC\\_TP\\_2008\\_1\\_EoI\\_AQ\\_metta\\_info2006](http://acm.eionet.europa.eu/reports/ETCACC_TP_2008_1_EoI_AQ_metta_info2006)
4. Tihomir Popović, J. Knežević, B. Jović, L.Marić, B. Dimić, 2015, KEY ELEMENTS OF THE BASIS FOR THE PREPARATION OF THE NATIONAL STRATEGY FOR AIR PROTECTION (in Serbian), 43. Savetovanje “ZAŠTITA VAZDUHA 2015“, Udruženje za zaštitu vazduha Srbije, Plenarno predavanje, Zbornik radova, str. 15 – 22, Zrenjanin 2015.
5. Agencija za zaštitu životne sredine 2016, IZVEŠTAJ O STANJU KVALITETA VAZDUHA U REPUBLICI SRBIJI 2010, 2011, 2012, 2013, 2014 and 2015 (in preparation), <http://www.sepa.gov.rs/download/VAZDUH2014.pdf>





## THE CONTENT OF HEAVY METALS IN THE PRECIPITATED OVERFLOW WATER AFTER THE TREATMENT

Dusanka Miljkovic\*, G. Lazic, D. Marinkovic

RTB Bor, TIR DOO  
Djrdja Vajferta 20, 19210 Bor, SERBIA

\*[tirekologija@gmail.com](mailto:tirekologija@gmail.com)

### ABSTRACT

The waste waters coming out of the industrial facilities in the copper production technological process, carry contaminants in them which may pollute the surface or underground water resources, damaging them permanently.

In the facility for waster waters treatment, neutralization of waste water and chemical buildup of metals in the form of hydroxides are conducted, which remain in the sludge, and the precipitated waster waters are used in the ore flotation process. In this study, the analyses of waste waters from old facilities (when there was no adequate waste water treatment) are presented, along with the analyses of waste waters from new facilities of the copper production technological process from the concentrate according to BAT, after the treatment in the effluent industrial water Plant. The analysis of the heavy metal content was carried out in the waste waters of the smelter complex after its treatment, paying special attention to Cu, Zn, Cd, and Pb in them.

**Key words:** effluent industrial waters, Cu, Zn, Cd i Pb.

### INTRODUCTION

The growing production of copper in the world and the ever increasing rigid standards with regard to the environmental protection, demand perfecting of the existing and the development of new technologies. The modern trends transform pyro metallurgic facilities into so called industrially – ecological complexes. During the technological processes of copper production, waster waters are generated, which contain heavy metals, which represent serious environmental pollutants due to their toxicity.[1-3].

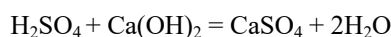
The development of metallurgic processes leans towards application of the best available technologies which significantly contribute to the improvement of environmental protection [4-8]. The quality of the precipitated waste water is supposed to be suitable to the the limit values of the emission, prescribed for certain kinds of industries, based on the best available technique for precipitation in case of a direct release into water bodies [14].

## MATERIAL AND METHODS

The effluent treatment plant hosts joint waste waters generated from the scrubbers for gas precipitation and cooling from the flash furnace (FSF flow) 4.8 m<sup>3</sup>/h and from the scrubbers for gas precipitation and cooling from the converters along with the suspension from the electrostatic filters with the liquid phase of the sulfuric acid Plant (PSC flow) 3,9 m<sup>3</sup>/h. [9].

The treatment of waster waters is made up of FSF and PSC neutralization process and the process of chemical buildups.

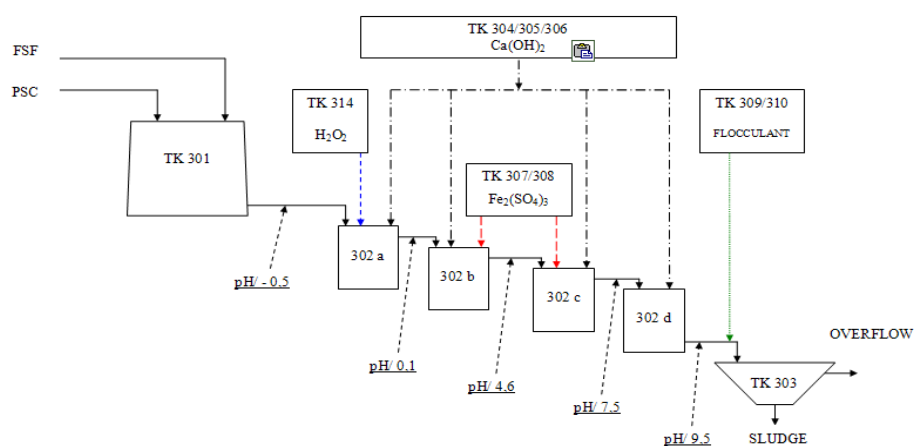
The neutralization is conducted by means of lime milk according to the reaction:



In order to reduce pH values to acceptable ones.

The chemical buildup is based on converting the soluted metallic ions from the waste water, by using appropriate reagents, into insoluble compounds, such as hydroxies, sulfides, and metal carbonates. In the effluent treatment plant, the best available technique for the treatment of waster waters from the primary copper smelter is used (*BAT for Non-ferrous metals industries, 2009*). [16,17] through the method of metal buildup in the form of hydroxides with the lime.

The tecnological block scheme of the waste water treatment is shown in the Figure no.1



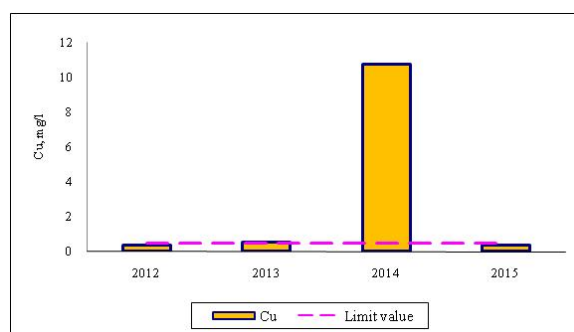
**Figure 1.** The tecnological block scheme of the waste water treatment

## RESULTS AND DISCUSSION

In the facility for waster waters treatment, neutralization of waste water and chemical buildup of metals in the form of hydroxides are conducted, which remain in the sludge, and the precipitated waster waters are used in the ore flotation process. The

quantities of heavy metals in the waste water from the old facilities (when there was no adequate waste water treatment) from 1.1.2012 to 1.11.2015 are compared to the quantities of heavy metals in waste water from the new plant of the technological process for copper production according to BAT, after the treatment in effluent water treatment Plant, from 4.11.2015 to 2.2.2016 [10].

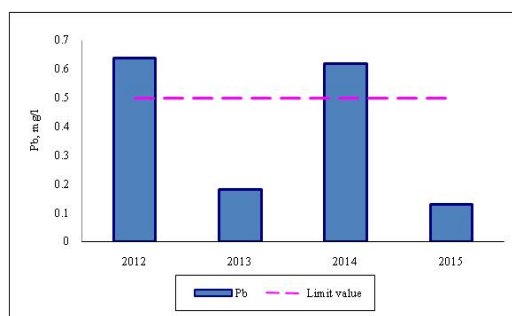
From 4.11.2015 – 2.2.2016 the analysis of the heavy metal content was carried out in the waste waters generated from the scrubbers for gas precipitation and cooling from the flash furnace and from the scrubbers for gas precipitation and cooling from the converters along with the suspension from the electrostatic filters with the liquid phase of the sulfuric acid Plant, after their treatment in the neutralization Facility, paying special attention to Cu, Zn, Cd i Pb in them. The results obtained were compared to the limit values according to the current law regulation of the Republic of Serbia. [13]. The content of heavy metals Cu, Zn, Cd i Pb of the precipitated waste water before the test start up of the effluent treatment plant for the observed period from 1.1.2012 to 1.11.2015 is shown in the Figures 2-5 [11].



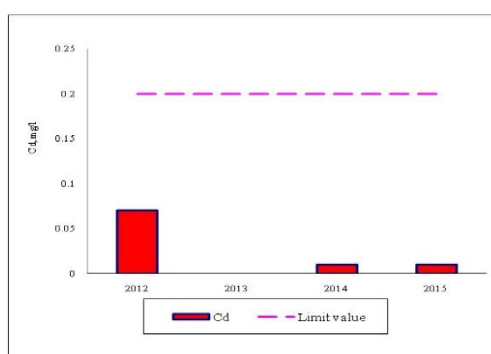
**Figure 2.** Median yearly content of Cu(mg/l) in the precipitated water from 1.1.2012 to 1.11.2015



**Figure 3.** Median yearly content of Zn(mg/l) in the precipitated water from 1.1.2012 to 1.11.2015

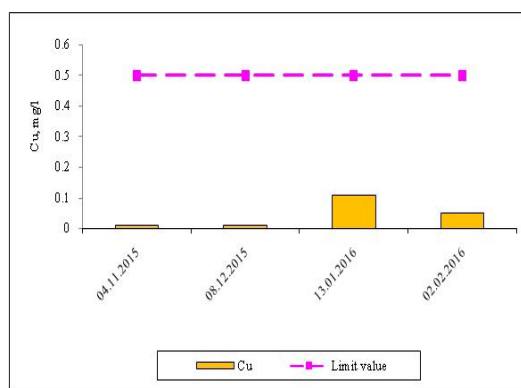


**Figure 4.** Median yearly content of Pb(mg/l) in the precipitated water from 1.1.2012 to 1.11.2015



**Figure 5.** Median yearly content of Cd(mg/l) in the precipitated water from 1.1.2012 to 1.11.2015

The achieved quality of the output water from the effluent water treatment plant for the observed period from 4.11.2015 to 2.2.2016 is shown in Figures 5-8 [12].



**Figure 6.** Content of Cu(mg/l) in the precipitated water from 4.11.2015 to 1.11.2016

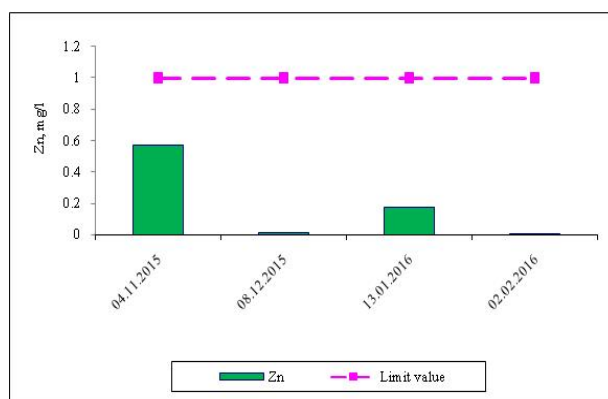


Figure 7. Content of Zn(mg/l) in the precipitated water from 4.11.2015 to 1.11.2016

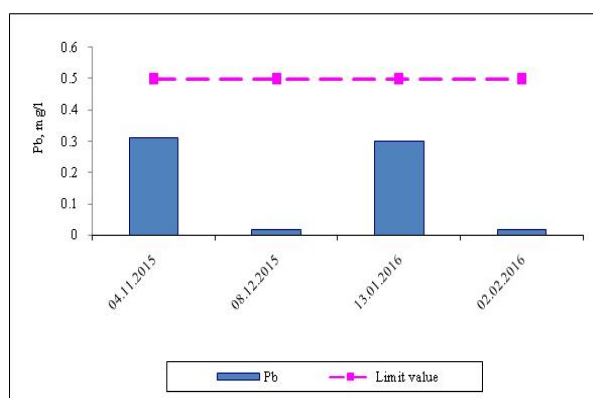


Figure 8. Content of Pb(mg/l) in the precipitated water from 4.11.2015 to 1.11.2016

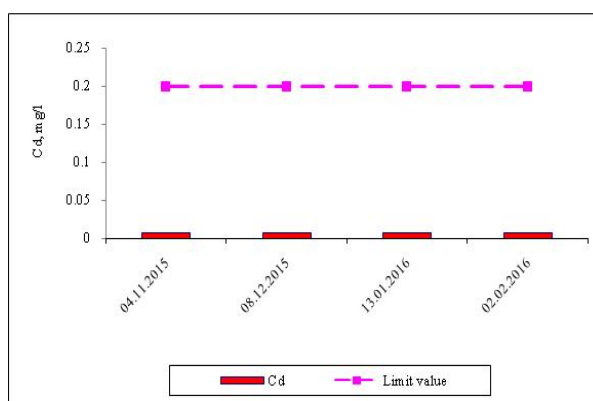


Figure 9. Content of Cd(mg/l) in the precipitated water from 4.11.2015 to 1.11.2016

## CONCLUSION

The quantities of heavy metals in the waste water from the old facilities during the period when there was no adequate treatment of waste water, compared to the quantity of heavy metals in the waste waters from the new facilities of the technological process of copper production from the concentrate according to BAT, after being treated in the effluent water treatment Plant, were significantly higher.

By comparing the content of heavy metals in the output precipitated water from the effluent water treatment Plant with the limit values according to the law regulation of the Republic of Serbia, it can be concluded that the heavy metals Cu, Pb, Zn, and Cd, are well below the limit values.

By applying the BAT technology in the field of effluent water treatment of the technological process of copper production, the persistent issue of waste waters which were inadequately treated and leaked into the recipient, has finally been resolved. The waste waters which contain heavy metals are precipitated in the effluent water treatment plant and are then used in the technological process of slag flotation.

## REFERENCES

1. H.S. Lim, J.S. Lee, H.T. Chon, M. Sager, Heavy metal contamination and health risk assessment in the vicinity of the abandoned Songcheon Au–Ag mine in Korea, *Journal of Geochemical Exploration* 96 (2008) 223–230.
2. H.X. Weng, Y.M. Zhu, Y.C. Qin, J.Y. Chen, X.H. Chen, Accumulation discrepancy of heavy metal and organic pollutants in three near-shore depositional environments, southeastern China, *Journal of Asian Earth Sciences* 31 (2008) 522–532
3. K.S. Kumar, K.S. Sajwan, J.P. Richardson, K. Kannan, Contamination profiles of heavy metals, organochlorine pesticides, polycyclic aromatic hydrocarbons and alkylphenols in sediment and oyster collected from marsh/estuarine Savannah GA, USA, *Marine Pollution Bulletin* 56 (2008) 136–149
4. O. Rentz, O. Kripner, F. Shultmann, Report on Best Available Techniques (BAT) in Copper Production, Final Draft, Deutsch –Französisches Institut für Umweltforschung, *French-German Institute for Environmental Research, University of Karlsruhe, Karlsruhe (1999)*, 275
5. Cochilco, Statistics of copper and other minerals, *Chilean copper commission, 2001*
6. A.Valenzuela, D. Palacios, D. Cordero, M. Sanchez, The Chilean Copper Metallurgical Industry - An update, *Yazawa International Symposium, San Diego, California, 2003*
7. D. Hitchens, F. Farrell, J. Lindblom, U. Triebswetter, The Impact of BAT on the Competitiveness of European Industry, *Institute for Prospektive technological Studies, European Commission, Report EUR 20133 EN, 2001*

8. Marja Riekkola-Vanhanen, Finnish expert report on best available techniques in copper production and by-production of precious metals, *The Finnish Environment*, 1999
9. SNC LAVALIN International, Osnovni i preliminarnom projekat Effluent Treatment plant - *Process Description Summary* - rev.01, Kanada, 2012
10. IC TMF, Rekonstrukcija postojećeg postrojenja za neutralizaciju slabe kiseline u cilju tretmana otpadnih tokova FSF i PSC topionice bakra u Boru, *Tehničko-tehnološko rešenje*, Univerzitet u Beogradu, Beograd, 2014
11. Nacionalni registar izvora zagađivanja – Beograd
12. Institut za rudarstvo i metalurgiju Bor, Izveštaji o ispitivanju broj: 18512, 18987, 12128 i 195140-33/2016.
13. Uredba o graničnim vrednostima emisije zagađujućih materija u vode i rokovima za njihovo dostizanje („Službeni glasnik RS”, br.55/05, 71/05- ispravka 101/07, 65/08 i 16/11)
14. Best Available Techniques (BAT) Reference Document for Common Waste water and Waste Gas Treatment/Management Systems in the Chemical Sector



## ATMOSPHERIC PARTICULATE MATTER CONCENTRATION AND THEIR HEAVY METAL CONTENT IN BOR, SERBIA

**Biljana Jovanovic\***, B. Todorovic

RTB Bor Grupa, TIR DOO  
Djordja Vajferta 20, 19210 Bor, SERBIA

\**tirekologija@gmail.com*

### ABSTRACT

Mining and metallurgical activities have had a significant impact on the ambient air. Air quality monitoring data for particulate matter (PM) with an aerodynamic diameter  $\leq 10 \mu\text{m}$  and their heavy metal content have been analyzed. Atmospheric samples of PM<sub>10</sub> were collected from five ambient air-monitoring station (AAMS) located in Bor Municipality area, for the period 2015.-2016. and analyzed for lead, cadmium and nickel. Standard gravimetric method was used for determining particulate matter content and inductively coupled plasma mass spectrometry (ICP-MS) method was used for determining the concentration of Pb, Cd, Ni, in suspended particles PM<sub>10</sub>, with great precision. The collected data was processed and analysed in accordance with the Regulation on the conditions for monitoring and air quality requirements - Legislation of the Republic of Serbia. Improvement of air quality confirmed the application of new technologies – Flash smelting and new Sulphuric Acid Plant.

**Key words:** air quality, particulate matter (PM<sub>10</sub>), lead, cadmium, nickel

### INTRODUCTION

The sources, characteristics, and potential health effects of suspended particles and particles with aerodynamic diameter less than  $10 \mu\text{m}$  (PM<sub>10</sub>) are very different. Natural emissions (crustal minerals, forest fires and oceans), traffic and industrial emissions (combustion of fossil fuel and industrial metallurgical processes) are the principal sources of atmospheric heavy metals [1-7].

Atmospheric particulate matter (PM) is more complex than other air contaminants because of its chemical composition and physical properties including density, concentration, and size distribution [8,9].

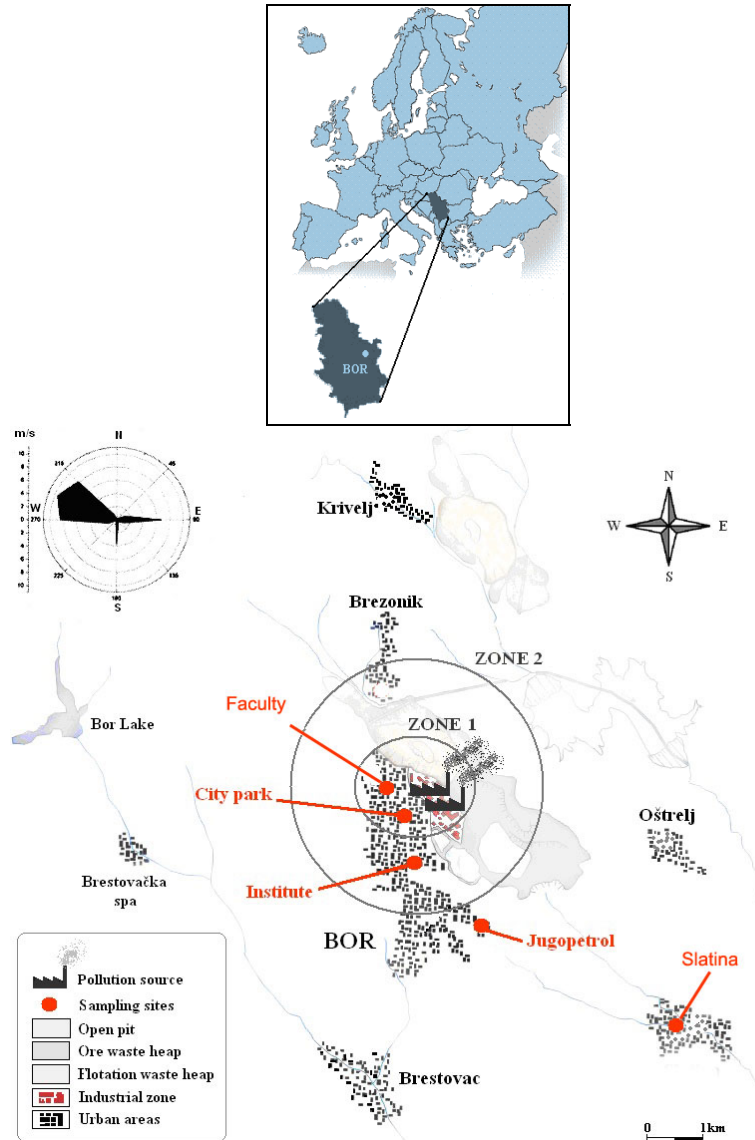
Accelerated industrialization has resulted in heavy metal air pollution increasing largely unchecked around the world, especially in many developing countries [10,11].

Lead (Pb), cadmium (Cd) and nickel (Ni), which can be found in PM, are considered potential public health risk factors because of their carcinogenic properties [12-15].



## MATERIAL AND METODS

Figure 1 presented a map of the Bor Municipality area with measuring points of air quality control. Five measured ambient air quality values were included: 1. Park; 2. Institut; 3. Faculty; 4. Jugopetrol; 5. Slatina.



**Figure 1.** Map of the Bor Municipality area with sampling sites (1. Park, 2. Institut, 3. Faculty, 4. Jugopetrol, 5. Slatina) and location of Copper Smelter smokestacks

Mining and Metallurgy Institute Bor measured the air quality in Bor in the period from January 2015. to January 2016. - Annual Report on the Air Quality in Bor.

Standard gravimetric method was used for determining particulate matter content pursuant to the standard SRPS EN 12341:2015 – Ambient air.

Inductively coupled plasma mass spectrometry (ICP-MS) method was used for determining the concentration of Pb, Cd, Ni, in suspended particles PM10, with great precision, pursuant to the standard SRPS EN 14902:2008.

The collected data was processed and analysed in accordance with the Regulation on the conditions for monitoring and air quality requirements (Official Gazette RS no.11/10, 75/10, 63/13).

**Table 1.** Ambient air – Standards and Guidelines (Official Gazette RS no.11/10,75/10, 63/13).

Parameter	Legislation of the Republic of Serbia
PM10, $\mu\text{g}/\text{m}^3$	50
Pb, $\mu\text{g}/\text{m}^3$	1
Cd, $\text{ng}/\text{m}^3$	5
Ni, $\text{ng}/\text{m}^3$	20

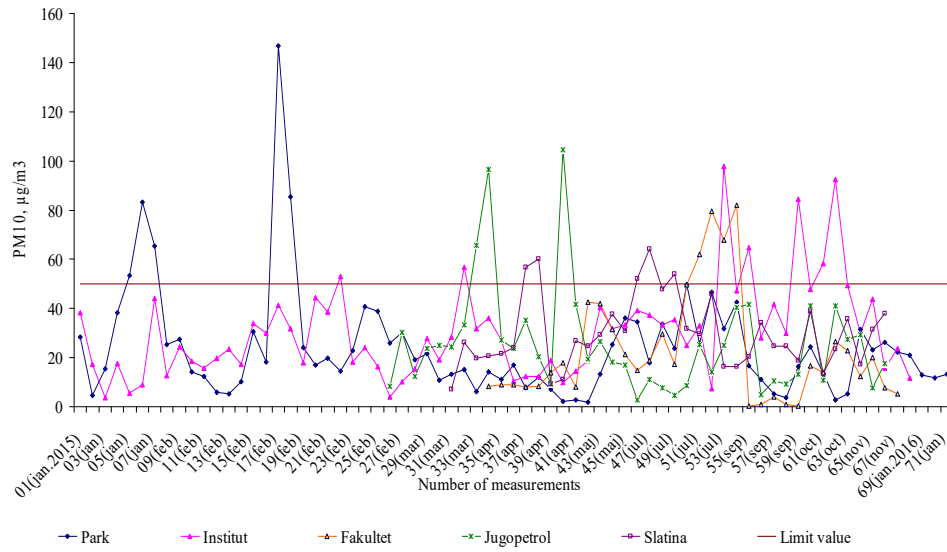
## RESULTS AND DISCUSSION

Copper production process in Bor was done in accordance with a standard smelting scheme and classified as a traditional copper production process.

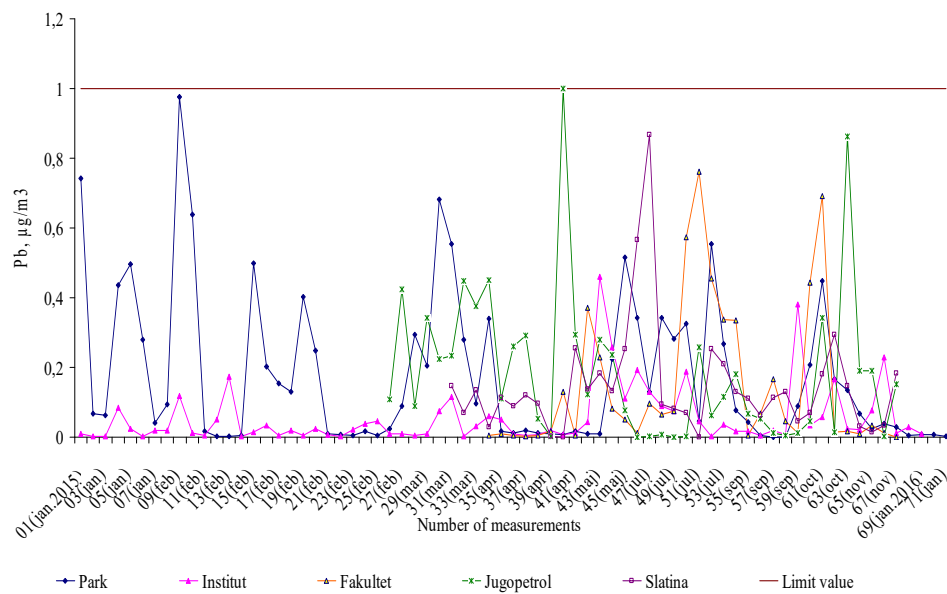
With the aim of reducing the emission and improving environmental conditions, introduction of new technological solutions, RTB Bor started by reconstruction of the existing smelter, application of autogenous processes.

New Flash Smelting processes and new Sulphuric Acid Plant has started in November 2015.

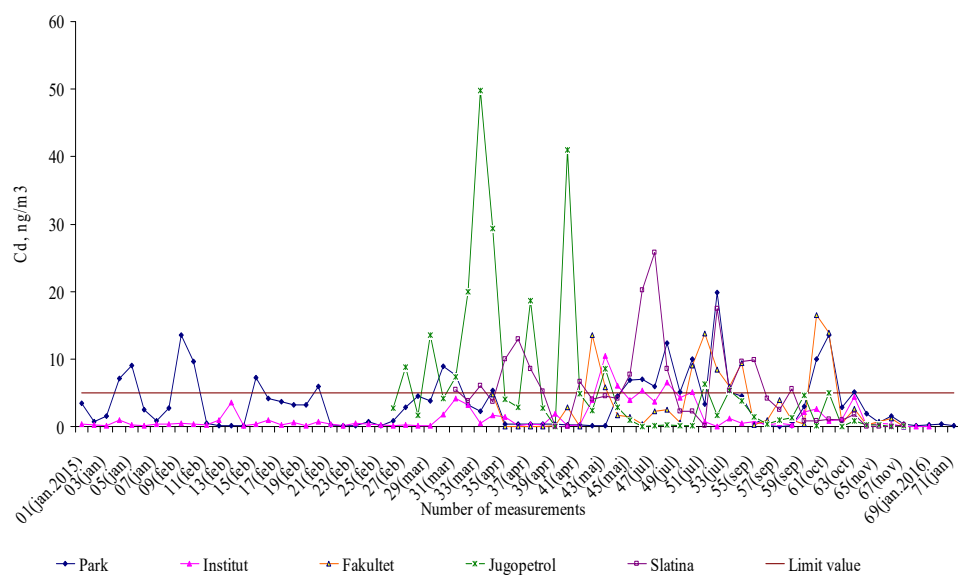
Concentration of Pb, Cd and Ni in suspended particulate (PM10) were calculated from data obtained from five ambient air-monitoring station (AAMS) located in town and surrounding: 1. Park, 2. Institut, 3. Faculty, 4. Jugopetrol, 5. Slatina, and presented in figure 2-5.



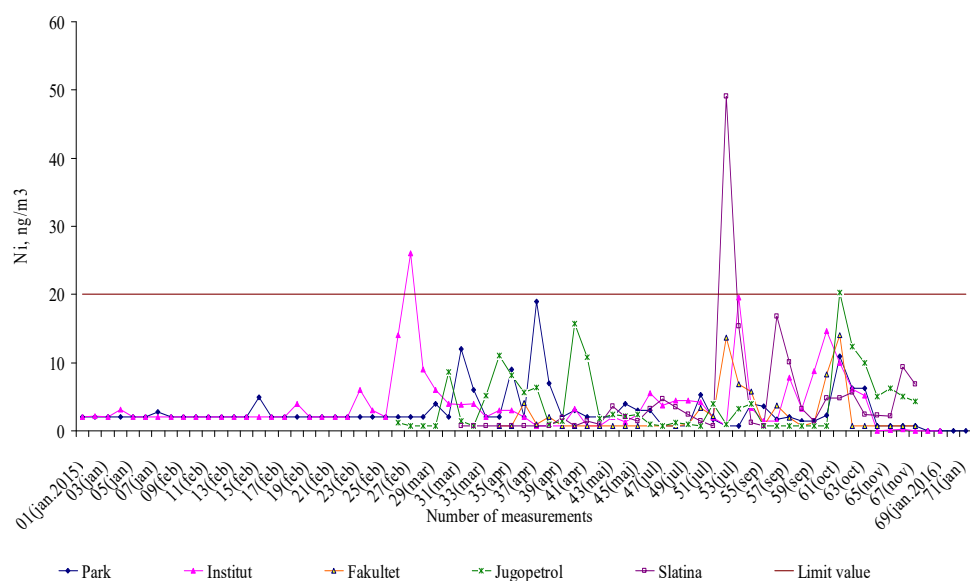
**Figure 2.** Concentration of particulate matter (PM10) from 5 ambient air-monitoring station, during the period January 2015. – January 2016.



**Figure 3.** Concentration of Pb µg/m<sup>3</sup> in PM10 from 5 ambient air-monitoring station, during the period January 2015. –January 2016.



**Figure 4.** Concentration of Cd  $\text{ng/m}^3$  in PM10 from 5 ambient air-monitoring station, during the period January 2015. – January 2016.



**Figure 5.** Concentration of Ni  $\text{ng/m}^3$  in PM10 from 5 ambient air-monitoring station, during the period January 2015. – January 2016.

## CONCLUSION

Concentration of particulate matter (PM10) from 5 ambient air-monitoring station, during the period January – October 2015. were higher than limit values  $50 \mu\text{g}/\text{m}^3$ .

Concentration of Pb in all samples were in accordance with the limit values  $1 \mu\text{m}/\text{m}^3$  while 71,83 % of PM10 samples had Cd content higher than allowed values which amount to  $5 \text{ ng}/\text{m}^3$ . Concentration of Ni in ambient PM10 samples in 2 days were higher than guidelines for the protection of human health  $20 \text{ ng}/\text{m}^3$ , at the measuring points "Institut"  $26 \text{ ng}/\text{m}^3$  and "Slatina"  $49,1 \text{ ng}/\text{m}^3$ .

New smelter has started with production in November 2015. From November 2015. to January 2016. particulate matter concentration and their heavy metal content (Pb, Cd, Ni) have been lower and in accordance with the law of the Republic of Serbia.

Applying BAT technology within the New Flash Smelting and Sulphuric Acid plant are significantly improve the environment.

## REFERENCES

1. Martin Ferm, M., Sjoberg, K., 2015. Concentrations and emission factors for PM2.5 and PM10 from road traffic in Sweden. *Atmospheric Environment* 119, 211-219.
2. Bozlaker, A., Buzcu-Güven, B., Fraser, M.P., Chellam, S., 2013. Insights into PM10 sources in Houston, Texas: Role of petroleum refineries in enriching lanthanoid metals during episodic emission events. *Atmospheric Environment* 69, 109-117.
3. C. Ehrlich, C., Noll, G., Kalkoff, W.D., Baumbach, G., Dreiseidler, A., 2007. PM10, PM2.5 and PM1.0 - Emissions from industrial plants - Results from measurement programmes in Germany. *Atmospheric Environment* 41, 6236–6254.
4. Zhiyuan Li, Z., Zibing Yuan, Z., Li, Y., Alexis K.H. Lau, A.K.H., Louie, P.K.K., 2015. Characterization and source apportionment of health risks from ambient PM10 in Hong Kong over 2000-2011. *Atmospheric Environment* 122, 892-899.
5. Park, E.J., Kim, D.S., Park, K., 2008. Monitoring of ambient particles and heavy metals in a residential area of Seoul, Korea. *Environ. Monit. Assess.* 137, 441-449.
6. Fang, G.C., Huang, Y.L., Huang, J.H., 2010. Study of atmospheric metallic elements pollution in Asia during 2000-2007. *J. Hazard. Mater.* 180, 115-121.
7. Cheung, K., Daher, N., Kam, W., Shafer, M.M., Ning, Z., Schauer, J.J., Sioutas, C., 2011. Spatial and temporal variation of chemical composition and mass closure of ambient coarse particulate matter (PM10-2.5) in the Los Angeles area. *Atmospheric Environment* 45, 2651-2662.
8. Amodio, M., Bruno, P., Caselli, M., de Gennaro, G., Dambruoso, P.R., Daresta, B.E., Ielpo, P., Gungolo, F., Placentino, C.M., Paolillo, V., Tutino, M., 2008.

- Chemical characterization of fine particulate matter during peak PM10 episodes in Apulia (South Italy). *Atmospheric Research* 90, 313-325.
9. Hieu, N.T., Lee, B.K., 2010. Characteristics of particulate matter and metals in the ambient air from a residential area in the largest industrial city in Korea. *Atmospheric Research* 98, 526-537.
  10. Wei, B., Yang, L., 2010. A review of heavy metal contaminations in urban soils, urban road dusts and agricultural soils from China. *Microchemical Journal* 94, 99-107.
  11. Ahmed, E., Kim, K.H., Kim, J.O., Park, J.K., Chambers, S., Feng, X., Sohn, J.R., Jeon, E.C., 2016. Pollution of airborne metallic species in Seoul, Korea from 1998 to 2010. *Atmospheric Environment* 124, 85-94.
  12. Melaku, S., Morris, V., Raghavan, D., Hosten, C., 2008. Seasonal variation of heavy metals in ambient air and precipitation at a single site in Washington, DC. *Environmental Pollution* 155, 88-98.
  13. Chen, L.C., Lippmann, M., 2009. Effects of metals within ambient air particulate matter (PM) on human health. *Inhalation Toxicology* 21, 1-31.
  14. Mutlu, A., Lee, B.K., Park, G.H., Yu, B.G., Lee, C.H., 2012. Long-term concentrations of airborne cadmium in metropolitan cities in Korea and potential health risks. *Atmospheric Environment* 47, 164-173.
  15. Zhang, J.J.Y., Sun, L., Barrett, O., Bertazzon, S., Underwood, F.E., Johnson, M., 2015. Development of land-use regression models for metals associated with airborne particulate matter in a north American city. *Atmospheric Environment* 106, 165-177.



## SO<sub>2</sub> AS AN INDICATOR OF AIR POLLUTION IN BOR

Vesna Cvetanovski\*, B. Jovanovic

RTB Bor Grupa, TIR doo, Bor, SERBIA

\*[vesnacvt@yahoo.com](mailto:vesnacvt@yahoo.com)

### ABSTRACT

The generation of large quantities of waste gases from the metallurgic facilities as well as the low return of matter and energy during the technological processes are the chief causes of environmental pollution in Bor and its vicinity. Air pollution has been an issue during the past decades. The smelter plant in Bor is one of the main emitters of harmful particles into the air. By measuring air quality in Bor and vicinity at six measuring locations, the SO<sub>2</sub> concentration values in the ambient air have been provided during the given period, when the old copper smelting plant was in operation and after the shut-down of the old technological line for copper production and when the new smelter plant was started. It has been confirmed that by means of using the BAT technology for copper production since November 2015, the air quality has been significantly improved.

**Key words:** air pollution, monitoring, sulphur dioxide.

### INTRODUCTION

The air quality monitoring is based upon monitoring the polluting particles concentrations with regard to the allowed values, as well as their impact on the environment [1-4]. Sulfur dioxide is one of the most common sources of air pollution in the world. Erupting volcanoes can be a significant natural source of sulfur dioxide emissions [5]. One of the most significant artificial sources of sulfur dioxide is fossil fuel combustion [6-10] and the smelting of mineral ores containing sulfur. The obsolete technologies for production of non-ferrous metals have a large impact to the air pollution and increased SO<sub>2</sub> emissions into the atmosphere.

Sulphur dioxide reacts on the surface of various solid particles diffused in the air, is soluble in water and is oxidized when reacting with water droplets in the atmosphere, producing sulphuric acid. This acidic pollution is often transported by wind over many hundreds of kilometres, and produces acid rain [12]. Acid rain is also responsible for crop damage, buildings' decay and the negative consequences to people and animals through transfer of poisonous substances to the food chain.

Many studies have indicated the correlation between SO<sub>2</sub> concentrations in the ambient air and the meteorological parameters, especially the wind velocity and blowing direction, air temperature, humidity and atmospheric pressure [13-17]. The correlation of

air pollution with the weather conditions as well as the analysis of the correlation between the meteorological factors and the concentrations of air polluting particles represents the basis for determining air quality [18-21].

SO<sub>2</sub> emissions gaseous tend to affect peoples' respiratory system, cause cancer, cardiovascular and vision problems [22] responsible for ecosystem instability and the global warming effect.

By applying modern technologies in the copper metallurgy, the air quality can be significantly improved, through reducing air polluting emissions, SO<sub>2</sub> and the suspended particles containing heavy metals.

## **MATERIAL AND METODS**

Six measuring locations have been analysed in the city and its vicinity. 1. City park (0.5 km away from the smelter stack in the direction of east wind) ; 2. Jugopetrol (in the direction of the prevalent, north wind); 3. The Institute (1 km away from the smelter complex); 4. Brezonik (2.5 km away from the smelter complex) 5. The Faculty; 6. Slatina.

The data concerning the SO<sub>2</sub> concentrations in the ambient air can be observed in real time on The Environmental Protection Agency web site [www.sepa.gov.rs](http://www.sepa.gov.rs) – the state network organized monitoring.

At the measuring location, City park, the following equipment was installed: DKK-TOA Corp. Model GFS-312E Ambient SO<sub>2</sub> Analyzer, for automatic SO<sub>2</sub> monitoring in the ambient air.

At the measuring location, The Institute, the following equipment was installed: API Teledyne Ambient SO<sub>2</sub> Analyzer M100E.

At the measuring location, Jugopetrol, the following equipment was installed: DKK-TOA Corp. Model GFS-312E Ambient SO<sub>2</sub> Analyzer.

At the measuring location, Brezonik, the following equipment was installed: DKK-TOA Corp. Model GFS-312E Ambient SO<sub>2</sub> Analyzer.

At the measuring location, the Faculty and Slatina, the following equipment was installed: PROEKOS, Beograd.

For the purpose of controlling SO<sub>2</sub> content the method SRPS ISO 4220/1997 for determining the index of acidic, gaseous and polluting matter in the air is used. The technique of examination: titrimetry.

At the automated stations for determining SO<sub>2</sub> concentrations the UV EN 14212 method is used. The air quality control within this monitoring is conducted by the authorized, independent firm „Mining and Metallurgy Institute Bor“.

The table 1 shows the standards and rules regarding the ambient air quality in Serbia, the limit value, the tolerable value, and the tolerance limit for sulfur dioxide according to the Conditions for Monitoring and Air Quality Demands Act („Official Gazette of Republic of Serbia no. 11/2010, 75/10 i 63/13).

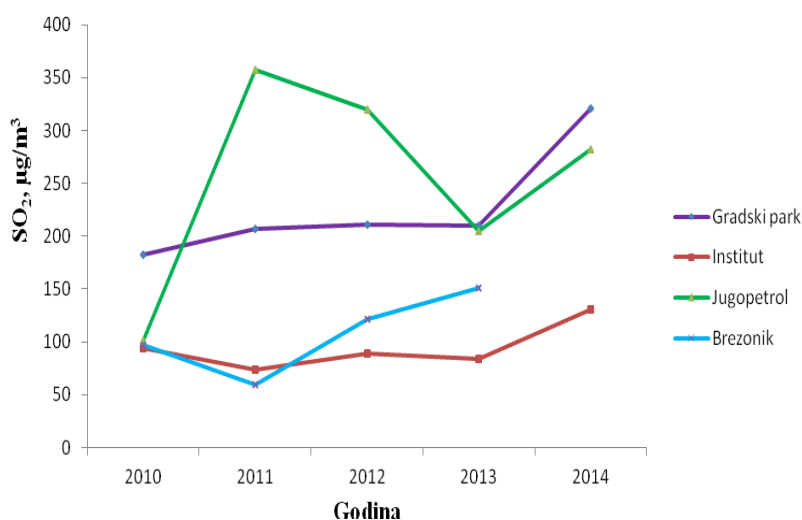


**Table 1.** The limit value, tolerable value and tolerance limit of SO<sub>2</sub>

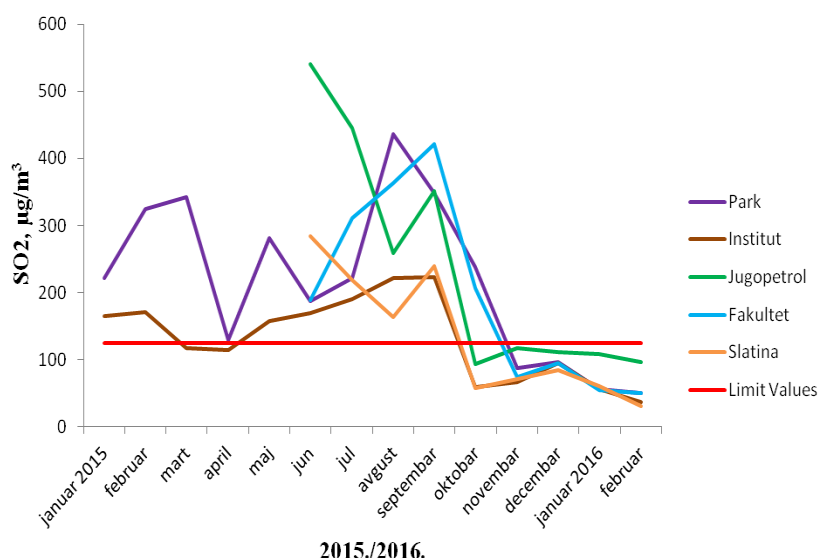
Averaging period	Limit value	Granica tolerancije	Tolerance limit	Deadline for reaching the limit value
One hour	350 µg/m <sup>3</sup>	150 µg/m <sup>3</sup>	500 µg/m <sup>3</sup>	01.01.2016.
One day	125 µg/m <sup>3</sup>	-	125 µg/m <sup>3</sup>	01.01.2016.
Calendar year	50 µg/m <sup>3</sup>	-	50 µg/m <sup>3</sup>	01.01.2016.

## RESULTS AND DISCUSSION

The SO<sub>2</sub> concentration, in µg/m<sup>3</sup> in the ambient air of Bor and its vicinity, for the period from 2010 to 2016 is given in figures 1-2. Figure No.2 shows median daily concentrations of SO<sub>2</sub> in µg/m<sup>3</sup> in 2015 during the period when the old smelter plant was in operation and from the moment it was shut down (November 2015). By means of applying the BAT technology in the copper metallurgy, the air quality has been considerably improved since November 2015.



**Figure 1.** The average yearly SO<sub>2</sub> concentrations in the ambient air from 2010. to 2014.



**Figure 2.** The average monthly SO<sub>2</sub> concentrations in the ambient air form January 2015 to February 2016

## CONCLUSION

Air pollution in Bor has been an issue for many years. The ever increasing rigid standards of environmental protection require perfecting of the existing and the development of new technologies. By making use of the best technologies available in the copper metallurgy, there has been a considerable improvement in life conditions quality, taking into account that the harmful gases emissions are within the limits prescribed by the law regulation of the Republic of Serbia.

In period observed, from 2010 to November 2015, the SO<sub>2</sub> concentration in µg/m<sup>3</sup> in the ambient air, at all measuring locations, was above the limit values prescribed by the Conditions for Monitoring and Air Quality Demands Act („Official Gazette of Republic of Serbia no. 11/2010, 75/2010 i 63/2013).

In order to reduce emissions and improve environmental conditions in Bor, several technological actions were taken, such as the reconstruction of the existing smelter plant, applying autogenic processes and constructing the new sulfuric acid plant. Since November 2015, when the new copper smelting plant was started for the purpose of testing, daily SO<sub>2</sub> concentrations in µg/m<sup>3</sup> have been well within the limit of allowed values which justifies the application of modern technologies in copper metallurgy in light of the environmental protection aspects and improving air quality in Bor and its vicinity.

## REFERENCES

1. Zhao, L., Xie, Y., Wang, J., Xu, X., 2015. A performance assessment and adjustment program for air quality monitoring networks in Shanghai. *Atmospheric Environment* 122, 382-392.
2. Allegrini, I., Costabile, F., 2008. Monitoring Air Quality in Urban Areas. *Sustainable Development and Environmental Management*, pp. 125 – 139.
3. G. Righini, G., Cappelletti, A., Ciucci, A., Cremona, G., Piersanti, A., Vitali, L., Ciancarella, L., 2014. GIS based assessment of the spatial representativeness of air quality monitoring stations using pollutant emissions data. *Atmospheric Environment* 97, 121-129.
4. A. Baklanov, A., Luisa T. Molina, L.T., Gauss, M., 2016. Megacities, air quality and climate. *Atmospheric Environment* 126, 235-249 .
5. A. Junling, Ueda, H., Matsuda, K., Hasome, H., Iwata, M., 2003. Simulated impacts of SO<sub>2</sub> emissions from the Miyake volcano on concentration and deposition of sulfur oxides in September and October of 2000. *Atmospheric Environment* 37, 3039–3046.
6. Turalioğlu, F.S., 2005. An assessment on variation of sulfur dioxide and particulate matter in Erzurum (Turkey). *Environmental Monitoring and Assessment*, 104, 119-130.
7. Athanasios, I.C., Pilavachi, P.A., 2007. Objective and subjective evaluation of power plants and their non-radioactive emissions using the analytic hierarchy process. *Energy Policy*, 35, 4027-4038.
8. Jiming, H., Litao, W., Minjia, s., Lin, l., Jingnan, H., 2007. Air quality impacts of power plant emissions in Beijing. *Environmental Pollution* 147, 401-408.
9. Henschel, S., Querol, X., Atkinson, R., Pandolfi, M., Zeka, A., Le Tertre, A., Analitis, A., Katsouyanni, K., Chanel, O., Pascal, M., Bouland, C., Haluza, D., Medina, S., Goodman, P.G., 2013. Ambient air SO<sub>2</sub> patterns in 6 European cities. *Atmospheric Environment* 79, 236-247 .
10. Yao, X., Lee, C.J., Evans, G.J., Chu, A., Godri, K.J., McGuire, M.L., Ng, a.C., Whitelaw, C., 2011. Evaluation of ambient SO<sub>2</sub> measurement methods at roadside sites. *Atmospheric Environment* 45, 2781-2788.
11. Crawford G.A., 1995. Environmental improvements by the mining industry in the Sudbury Basin of Canada. *Journal of Geochemical Exploration* 52, 267-284.
12. T.J. Wang, T.J., Jin, L.S., Li, Z.K., Lam, K.S., 2000. A modeling study on acid rain and recommended emission control strategies in China. *Atmospheric Environment* 34, 4467-4477.
13. Luvsan, M.E., Shie R.H., Purevdorj, T., Badarch L., Baldorj B., Chan C.C., 2012. The influence of emission sources and meteorological conditions on SO<sub>2</sub> pollution in Mongolia. *Atmospheric Environment* 61, 542-549.
14. Akpınar, S., Oztop, H., Kavak Akpınar, E., 2008. Evaluation of relationship between meteorological parameters and air pollutant concentrations during winter season in Elazığ, Turkey. *Environmental Monitoring and Assessment* 146, 211-224.

15. Bridgman, H.A., Davies, T.D., Jickells, T., Hunova, I., Tovey, K., Bridges, K., Surapipith, V., 2002. Air pollution in the Krusne Hory region, Czech Republic during the 1990s. *Atmospheric Environment* 36, 3375-3389.
16. Ilic, I.Z., ¶ Zivkovic, D.T., Vu¶ sovic, N.M., Bogdanovic, D.M., 2010. Investigation of the correlation dependence between SO<sub>2</sub> emission concentration and meteorological parameters: case studydBor (Serbia). *Journal of Environmental Science and Health, Part A* 45, 901-907.
17. Wang, M., Zhu, T., Zhang, J.P., Zhang, Q.H., Lin, W.W., Li, Y., Wang, Z.F., 2011. Using a mobile laboratory to characterize the distribution and transport of sulfur dioxide in and around Beijing. *Atmospheric Chemistry and Physics* 11, 11631-11645.
18. MacDougall, M., Smith, R.I., et al., 2005. Comprehensive sensitivity analysis of an SO<sub>2</sub> deposition model for three measurement sites: consequences for SO<sub>2</sub> deposition fluxes. *Atmospheric Environment* 39 (28), 5025–5039.
19. Mao, Q., Gautney, L.L., et al., 2006. Numerical experiments on MM5–CMAQ sensitivity to various PBL schemes. *Atmospheric Environment* 40 (17), 3092–3110.
20. Speidel, M., Nau, R., et al., 2007. Sulfur dioxide measurements in the lower, middle and upper troposphere: deployment of an aircraft-based chemical ionization mass spectrometer with permanent in-flight calibration. *Atmospheric Environment* 41 (11), 2427–2437.
21. Meng, Y., Chen, C., 2002. Impact of surface synoptic situations on air pollution in Beijing area. *Meteorologica* 4 (28), 42–46 (in Chinese).
22. Pandey, J.S., Kumar, R., Devotta, S., 2005. Health risks of NO<sub>2</sub>, SPM and SO<sub>2</sub> in Delhi (India). *Atmospheric Environment* 39, 6868–6874.



## SULPHUR DIOXIDE LEVEL IN THE AIR IN THE PERIOD 2009-2015 (BOR, EASTERN SERBIA)

Snezana Serbula<sup>1\*</sup>, J. Milosavljevic<sup>1</sup>, A. Radojevic<sup>1</sup>, J. Kalinovic<sup>1</sup>,  
T. Kalinovic<sup>1</sup>, T. Apostolovski Trujic<sup>2</sup>

<sup>1</sup>University of Belgrade, Technical Faculty Bor, V. J. 12, 19210 Bor, SERBIA

<sup>2</sup>Mining and Metallurgy Institute Bor, Zeleni bulevar 35, 19210 Bor, SERBIA

\**ssherbula@tf.bor.ac.rs*

### ABSTRACT

Air pollution level at six measuring sites in Bor was evaluated during the 7-year period. The average annual SO<sub>2</sub> concentrations were above the limit value (50 µg m<sup>-3</sup>) during the examined period, while daily SO<sub>2</sub> concentrations frequently exceeded the limit value (125 µg m<sup>-3</sup>). Maximum daily SO<sub>2</sub> concentration of 3734 µg m<sup>-3</sup> was recorded at the site Jugopetrol during 2012. Location of the sites Jugopetrol and Technical Faculty which are at the prevailing wind directions, as well as the vicinity of the site Town Park to the copper smelter are the main reasons for high level of air pollution.

**Key words:** sulphur dioxide, copper smelter, emission, air pollution, Bor .

### INTRODUCTION

Emission sources of sulphur dioxide (SO<sub>2</sub>) in the atmosphere can be of natural and anthropogenic origin, such as volcanic emissions, smelting of sulfide ores or burning of fossil fuels [1,2]. Although SO<sub>2</sub> can be oxidized [3] and removed from the atmosphere by wet and dry deposition [4], it can also be transported several hundred kilometers depending upon meteorological conditions [5].

Regarding that the copper smelter, a part of the Mining–metallurgical Complex Bor, represents a major source of pollution in Bor, constant monitoring of the air pollution is necessary because SO<sub>2</sub> has negative impact on ecosystems as well as on human health [3]. Assessment of air pollution level caused by SO<sub>2</sub> emissions during the period 2009–2015 was the aim of the study.

### METHODOLOGY

Exploitation of copper has led to industrial development of the Bor region. However surface mining of copper ore and pyrometallurgical production of copper from sulfide concentrates are primary sources of environmental pollution. Fugitive dust from overburden dumps and flotation tailings ponds also cause pollution of agricultural land.

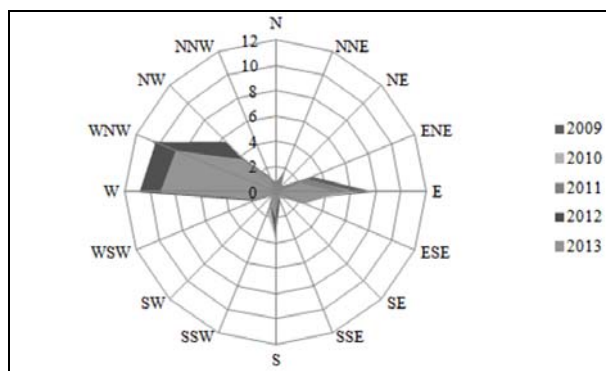
Due to low average utilization of waste gases (about 40%) in the sulphuric acid plant, the rest of gases are discharged untreated into the atmosphere [2]. New sulphuric acid plant and smelter are built near existing ones, in order to significantly reduce air pollution in the area.

The air quality monitoring was performed at the sites [6]:

- ✓ Town Park (TP) – 0.5 km SW of the smelter in the urban–industrial zone (UI);
- ✓ Institute (IN) – 2 km S of the smelter in the UI zone ;
- ✓ Jugopetrol (JP) – 3.3 km SE of the smelter in the suburban zone (SU);
- ✓ Brezonik (BR) – 2.5 km N of the smelter in the SU zone;
- ✓ Technical Faculty (TF) – 1 km WNW of the smelter in the UI zone;
- ✓ Slatina (SL) – 6 km SE of the smelter in the rural zone (R).

## RESULTS AND DISCUSSION

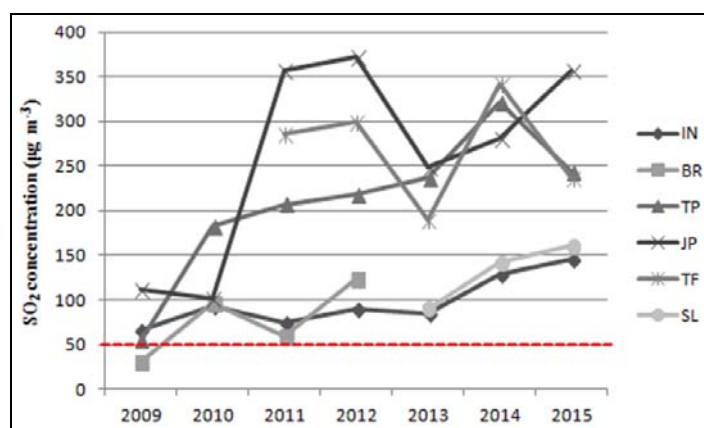
Wind rose diagram for the Bor region is shown in Figure 1. The predominant winds in the study area are WNW, NW, W and E winds, while less frequent winds are of S, ENE, ESE, NNE and SSW directions [6]. The climate of the studied area is moderately continental.



**Figure 1.** Rose diagram based on the annual wind frequencies (%) for the period 2009-2013

The average annual and maximum daily  $\text{SO}_2$  concentrations, as well as number of exceedances of the limit value (LV) are given in Figure 2 and Table 1, respectively.

During the 7-year period, the average annual  $\text{SO}_2$  concentrations significantly exceeded the annual LV, amounting  $50 \mu\text{g m}^{-3}$  [7] at all the sites, except at the measuring site BR during 2009. At the measuring site JP the highest average annual  $\text{SO}_2$  concentrations were recorded, during the whole period, except for 2010 and 2014 when the maximum average annual  $\text{SO}_2$  concentrations were recorded at the measuring sites TP and TF, respectively. Although the site JP is located further from the copper smelter, compared to the TP and TF sites (which are located in the prevailing E wind directions),  $\text{SO}_2$  concentrations at the JP were largely influenced by the prevailing W wind directions.



**Figure 2.** Average annual SO<sub>2</sub> concentrations (µg m<sup>-3</sup>) during the study period (dashed line – limit value according to the Serbian Regulation)

The maximum daily concentrations during the study period were above the Serbian LV [7], the European Commission Directive LV [8] and the WHO Air Quality Guidelines for 24-hour average [9]. The most extreme value was measured at the site JP in 2012 (Table 1). At the measuring site IN during 2014, SO<sub>2</sub> concentrations have exceeded the LV [7] in 178 days, while at the BR site the LV [7] was exceeded 119 times during 2012. At the measuring sites TP and JP exceeding of the LV [7] was recorded at 245 times during 2014. The LV [7] was exceeded 312 and 165 times during 2014 at the sites TF and SL, respectively. A long-term study (2001–2008) of emissions from one of the largest Cu-smelter in Europe (Huelva, Spain) has shown that SO<sub>2</sub> levels did not exceed the daily limit [10].

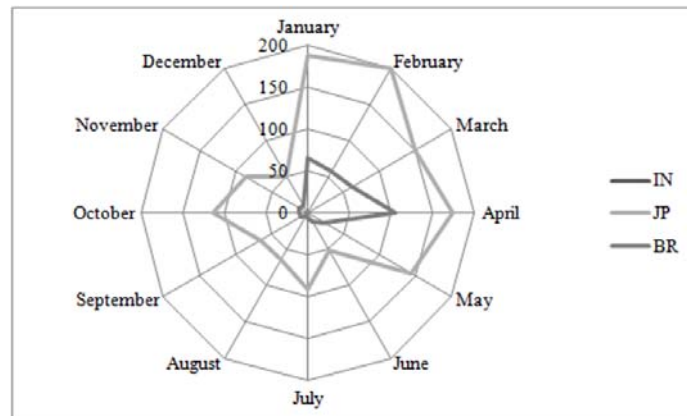
**Table 1.** Maximum daily SO<sub>2</sub> concentrations (µg m<sup>-3</sup>) and the number of exceedances of the LVs during the study period

Year	Max daily SO <sub>2</sub> concentration (µg m <sup>-3</sup> )						Number of days above the daily LV <sup>a</sup>					
	IN	BR	TP	JP	TF	SL	IN	BR	TP	JP	TF	SL
2009	241 <sup>b</sup>	446	663	1412	/	/	3 <sup>b</sup>	18	36	83	/	/
2010	320	303	2079	367	/	/	23	69	180	71	/	/
2011	545	889	1434	2565	2386	/	68	52	164	136	156	/
2012	1707	2135	2584	3734	2037	/	98	119	156	198	159	/
2013	1241	/	2006	2153	1110	821	74	/	172	194	129	20
2014	1217	/	3339	1851	2040	977	178	/	245	245	312	165
2015	723	/	1357	3181	1088	650 <sup>c</sup>	171	/	208	159 <sup>c</sup>	111 <sup>c</sup>	113 <sup>c</sup>
LV <sup>a</sup>	125 <sup>a</sup>						–					
LV <sup>d</sup>	125						–					
LV <sup>e</sup>	20						–					

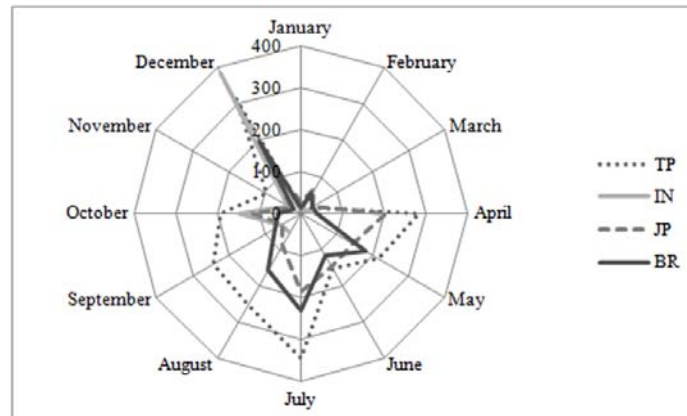
<sup>a</sup> LV was changed from 150 µg m<sup>-3</sup> to 125 µg m<sup>-3</sup> in April of 2010; <sup>a</sup> Serbian Regulation [7]; <sup>b</sup> from 1<sup>st</sup> to 21<sup>st</sup> January; <sup>c</sup> from June to December; <sup>d</sup> EC Directive [8]; <sup>e</sup> WHO Air Quality Guidelines [9]; / no data; – not defined

The average monthly SO<sub>2</sub> concentrations, from 2009 to 2015, are given in Figure 3 [6]. The highest average monthly SO<sub>2</sub> concentrations in 2009 (Fig. 3a), 2013 (Fig 3e) and 2014 (Fig. 3f) were measured during February at the sites JP (199 μg m<sup>-3</sup>), TP (557 μg m<sup>-3</sup>) and TF (582 μg m<sup>-3</sup>), respectively. During 2010 the average monthly SO<sub>2</sub> concentrations was 387 μg m<sup>-3</sup> in December at the site IN (Fig. 3b), while during 2012 (Fig. 3d) was measured in March at the site JP (803 μg m<sup>-3</sup>). Only in 2011 (Fig. 3c) and 2015 (Fig. 3g) the highest monthly SO<sub>2</sub> concentrations were measured during the summer months at the sites JP in August (765 μg m<sup>-3</sup>) and Jun (539 μg m<sup>-3</sup>).

a)

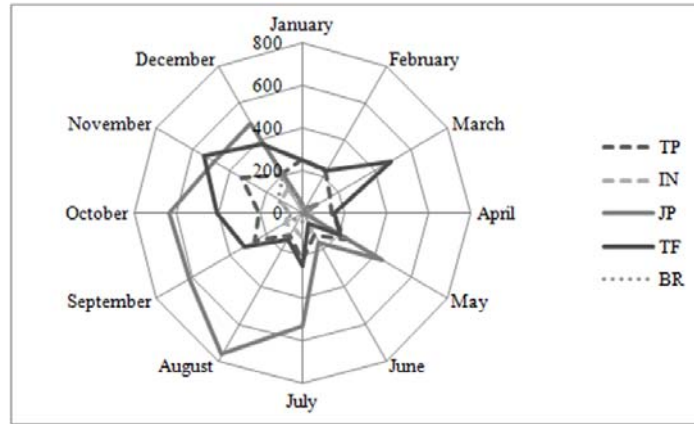


b)

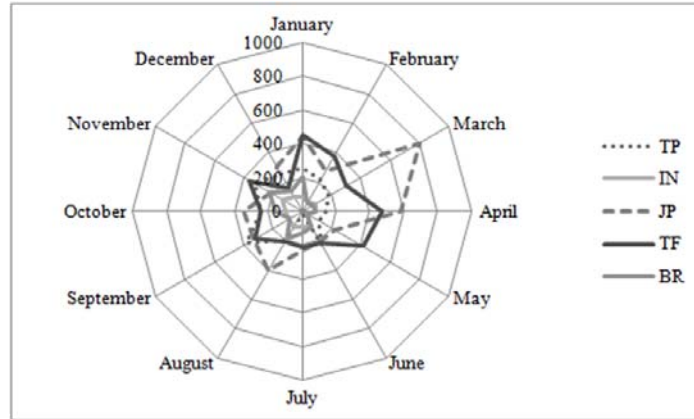




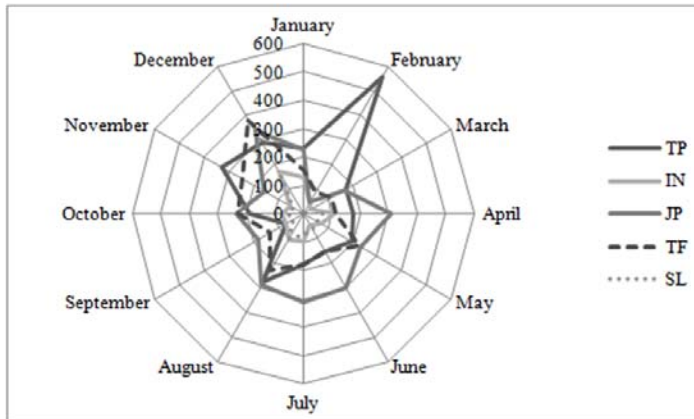
c)



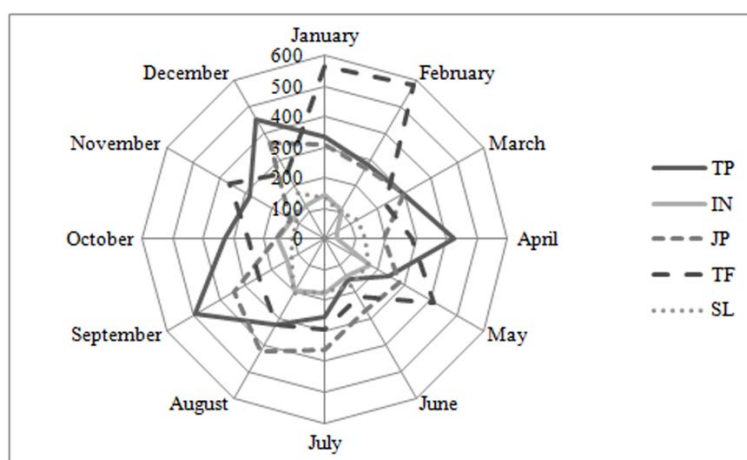
d)



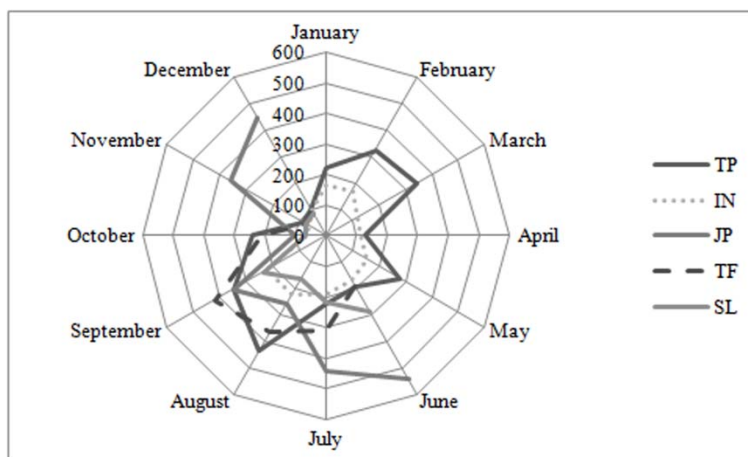
e)



f)



g)



**Figure 3.** The average monthly SO<sub>2</sub> concentrations (µg m<sup>-3</sup>) during the years a) 2009; b) 2010; c) 2011; d) 2012; e) 2013; f) 2014; g) 2015

### CONCLUSION

The average daily, monthly and annual SO<sub>2</sub> concentrations at the measuring sites in the Bor region from 2009 to 2015 were presented. The annual SO<sub>2</sub> concentrations at all the measuring sites exceeded the proposed annual limit (50 µg m<sup>-3</sup>) by the Serbian Regulation [7], except at the site BR during 2009. Daily SO<sub>2</sub> concentrations were frequently above the current air quality guidelines at all the measuring sites, during the

study period. The most polluted sites were JP, TF and TP because of location in regard to the prevailing W and E wind directions, and the vicinity of the copper smelter, respectively. Frequent exceeding of the daily and annual LVs have negative impact on human health since many epidemiological studies have associated sulphur dioxide inhalation and respiratory diseases.

### ***Acknowledgements***

*The authors are grateful to the Ministry of Education, Science and Technological development of the Republic of Serbia for financial support. Our thanks go to Professor Mara Ž. Manžalović from the University of Belgrade, Technical Faculty in Bor, for providing language assistance.*

### **REFERENCES**

1. Lu Z, Streets D, Zhang Q, Wang S, Carmichael G, Cheng Y, et al., Sulphur dioxide emissions in China and sulphur trends in East Asia since 2000, 6311–6331, *Atmos Chem Phys* 10, 2010.
2. Serbula S, Kalinovic T, Kalinovic J, Ilic A, Exceedance of air quality standards resulting from pyro-metallurgical production of copper: a case study, Bor (Eastern Serbia), 1989–1998, *Environ Earth Sci* 68, 2013.
3. Afif C, Chélala C, Borbon A, Abboud M, Adjizian-Gérard J, Farah W, et al., SO<sub>2</sub> in Beirut: air quality implication and effects of local emissions and long-range transport, 167–178, *Air Qual Atmos Health* 1, 2008.
4. Pires J, Sousa S, Pereira M, Alvim-Ferraz M, Martins F, Management of air quality monitoring using principal component and cluster analysis-Part I: SO<sub>2</sub> and PM<sub>10</sub>, 1249-1260, *Atmos Environ* 42, 2008.
5. Sharma S, Datta A, Saud T, Saxena M, Mandal T, Ahammed Y, et al., Seasonal variability of ambient NH<sub>3</sub>, NO, NO<sub>2</sub> and SO<sub>2</sub> over Delhi, 1023–1028, *J Environ Sci* 22 (7), 2010.
6. The Mining and Metallurgy Institute Bor, Laboratory for Chemical Investigation, Examination of the air quality in Bor, an Annual Reports from the period 2009-2015.
7. The Official Gazette of the Republic of Serbia, No. 19/06, 63/13.
8. EC Council Directive 2008/50/EC of the European Parliament and of the Council of 21 May 2008 on ambient air quality and cleaner air for Europe. *Off J Eur Union* L 152/1, 2008.
9. WHO Air Quality guidelines for particulate matter, ozone, nitrogen dioxide and sulphur dioxide. Global update 2005. Regional Office for Europe, Copenhagen, 2006.
10. Sánchez de la Campa A, de la Rosa J, González-Castanedo Y, Fernández-Camacho R, Aastuey A, Querol X, et al., Levels and Chemical composition of PM in a city near a large Cu-smelter in Spain, 1276–1287, *J Environ Monit* 13, 2011.



## INVENTORY OF POLISH CRITICAL RAW MATERIALS ESSENTIAL FOR THE ECONOMY OF THE EUROPEAN UNION

Marcin Lutynski\*, S.Lutynska

Silesian University of Technology, Gliwice, POLAND

\*[marcin.lutinski@polsl.pl](mailto:marcin.lutinski@polsl.pl)

### ABSTRACT

The article presents definitions and insights on the global critical raw materials inventory and lists countries where these materials are most abundant. According to European Commission critical analysis was based on three groups of criteria: economic effects of supply constraints, the risk of supply reduction (erode or break), the environmental risk associated with limitation of production in various countries, resulting from the environmental protection requirements (maintenance of environmental quality standards, minimizing hazards). The list of critical materials in European Union is given with particular focus on Poland. In Poland, 11 out of 20 selected critical raw materials can be found. Any economic importance may have raw materials such as fluorspar, phosphate rock, cobalt, magnesite, platinum group (limited), tungsten, rare earth elements and coking coal. Among this group only cobalt, magnesite and coking coal are economically operated (without taking into account the secondary recovery).

**Key words:** critical raw materials, EU economy.

### INTRODUCTION

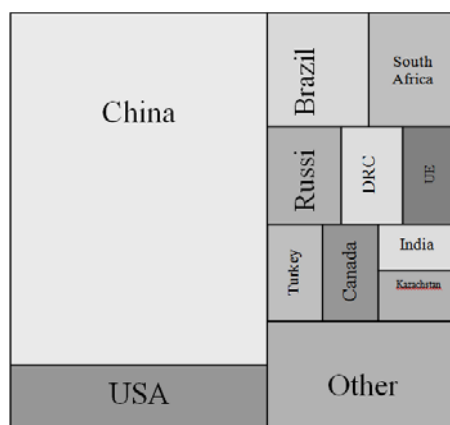
Raw materials policy is increasingly important for both the national economies of the European Union and across the globe. The increasing demand for raw materials is associated with the growing global population, rapid economic development and the spread of new technologies. The range of raw materials necessary for the EU economy increases, but their availability becoming more and more threatened. A particularly important problem is the issue of critical raw materials for which the risk of supply shortage and its consequences for the economy are larger than most of the other raw materials [4,7].

The European Commission defines raw material criticality as follows “To qualify as critical, a raw material must face high risks with regard to access to it, i.e. high supply risks or high environmental risks, and be of high economic importance. In such a case, the likelihood that impediments to access occur is relatively high and impacts for the whole EU economy would be relatively significant.”

### GLOBAL CRITICAL RAW MATERIALS

Analysis of the global primary supply of critical raw material identifies that less than 3% originate from EU sources. The major producers of critical raw materials are

China, whose market share is 49%. They are the main exporter of raw materials such as antimony, fluorspar, gallium, germanium, graphite, indium, magnesium, rare earths elements (REEs), tungsten. Several other countries have dominant supplies of specific raw materials: USA (beryllium), Russia (tungsten, platinum group metals - PGMs), Democratic Republic of Congo (cobalt, tantalum) and Brazil (niobium). Supply of other materials (e.g. platinum group metals, borates), is more diverse but is still relatively concentrated. The risks associated with such concentration of sourcing is in many cases compounded by low substitutability and low level of recycling [3,7].



**Figure 1.** World primary supply of critical raw materials [6]

### EU REGULATIONS CONCERNING CRITICAL RAW MATERIALS

The first criticality analysis regarding raw materials for UE was published in 2010 by the European Commission. Fourteen critical raw materials were identified from a candidate list of forty-one non-energy, non-agricultural materials (Tab.1). The Commission undertook to continue to monitoring the situation to identify priority actions and the review and update the list at least every three years.

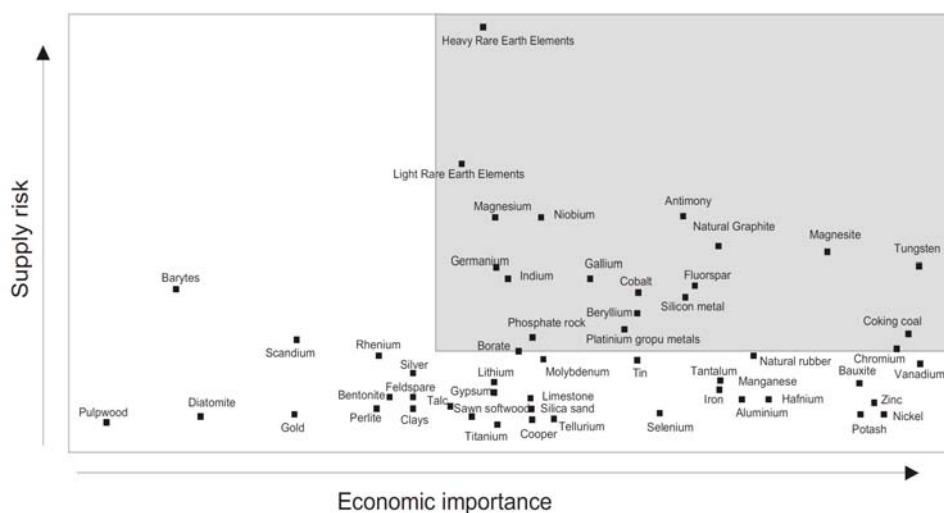
Critical analysis was based on three groups of criteria:

- economic effects of supply constraints,
- the risk of supply reduction (erode or break),
- the environmental risk associated with limitation of production in various countries, resulting from the environmental protection requirements (maintenance of environmental quality standards, minimizing hazards) [5].

The next communication on critical raw materials was published in 2014. In this report fifty-four non-energy, non-agricultural materials were analysed, using the same quantitative methodology as in the previous study. This extended list includes seven new abiotic materials (borates, chromium, coking coal, lithium, magnesite, phosphate rock and silicon metal) and three biotic materials (natural rubber, sawn softwood and pulpwood). This 2014 list includes thirteen of the fourteen materials identified in the

previous report, with only tantalum moving out of the EU critical material list (due to reducing the risk of supply shortages) (Tab.1).

In comparison with report from 2010 information about the rare earth elements are more detailed – previously REEs were considered as a single group. To provide greater insight in this report, and to reflect the different supply and demand issues faced by different REEs, this single group is been split into three in this analysis: light rare earth elements (LREE), heavy rare earth elements (HREE) and scandium.



**Figure 2.** Analysis of the criticality of raw materials selected in 2014 [6].

**Table 1.** The list of critical raw materials from the 2011 and 2014 [3,6].

Lp.	2010	2014
1	Antimony	Antimony
2	Beryllium	Beryllium
3	Cobalt	Borates
4	Fluorspar	Chromium
5	Gallium	Cobalt
6	Germanium	Coking coal
8	Indium	Fluorspar
9	Magnesium	Gallium
7	Natural Graphite	Germanium
10	Niobium	Indium
11	Platinum Group Metals	Magnesite
12	Rare Earth Elements	Magnesium
13	Tantalum	Natural Graphite
14	Tungsten	Niobium
15		Phosphate rock
16		Platinum Group Metals
17		Rare Earth Elements – Heavy
18		Rare Earth Elements – Light
19		Silicon metal
20		Tungsten

**CRITICAL RAW MATERIALS IN POLAND**

The resources of critical raw materials in Poland, their forms of occurrence, quantity and potential perspective of exploitation are presented below (Tab.2) [1,2].

**Table 2 . Critical raw materials in Poland**

Lp.	Raw materials	Resources	Exploitation/ perspective
1	Antimony	-	-
2	Beryllium	-	-
3	Borates	-	-
4	Chromium	-	-
5	Cobalt	Cu ore in Fore-Sudetic Monocline -120 720 t; potential sources – coal deposits in Upper Silesian Coal Basin – estimated resources 400 000 t	<b>Yes</b> In KGHM Polska Miedź mines (e.g. “Lubin-Małomice”): 82- 250 g Co per ton of ore)
6	Coking coal	Balance resources - 13737,99 mln t Industrial resources - 1520 mln t	<b>Yes</b>
8	Fluorspar	Barite deposit Stanisławów – 542 000 t	No
9	Gallium	Zn-Pb gallium-bearing ore in Silesian-Cracow series	No
7	Germanium	Zn-Pb ore in Silesian-Cracow series – trace amounts	No
10	Indium	-	-
11	Magnesite	Owl Mountains - 6 deposits with balance resources of 14,38 mln t	<b>Yes</b> Open pit mine “Konstanty” from Braszowice deposit
12	Magnesium	Dolomite deposit	No (methods of obtaining magnesium oxide and magnesium from dolomite was implemented in the quarter-scale in ZM Trzebinia in 1950s)
13	Natural Graphite	-	-
14	Niobium	-	-
15	Phosphate	Radom - Itża - Annopol - Gościeradów – Modliborzyce belt - 42,4 mln t	No (exploitation in Annopol deposit was end in 1971)
16	Platinum Group Metals	Cu ore in Fore-Sudetic Monocline, in polymetallic shale – up to 1000 ppm in Lubin and Polkowice deposit	No
Lp.	Raw materials	Resources	Exploitation/ perspective
17	Rare Earth Elements – Heavy	Lower Silesia: near to Szklarska Poręba (up to 0,5% RRE) and Bogatynia (up to 1,5% RRE); Phosphogypsum dump of chemical plant “Wizów” – 8 280 t of RRE (mainly yttrium and europium)	No
18	Rare Earth Elements – Light		
19	Silicon metal	Crystalline quartzites in Holy Cross Mountain; quartz veins from deposits of Lower Silesia	No
20	Tungsten	Mo-W-Cu ore deposit Myszków- 0,238 mln t of W	No

## CONCLUSION

In recent years, the problem of resources of critical raw materials in the European Union is a priority, because risk of disturbing or discontinuation of the supply liquidity and delivery can have serious consequences for the entire economy. Therefore, it is important to the development of mining sciences and other, such as chemical or environmental engineering, allowed for the safe exploitation of resources or recovery of materials from waste or anthropogenic deposits. In Poland, 11 out of 20 selected critical raw materials can be found. Any economic importance may have raw materials such as fluorspar, phosphate rock, cobalt, magnesite, platinum group (limited), tungsten, rare earth elements and coking coal. Among this group only cobalt, magnesite and coking coal are economically operated (without taking into account the secondary recovery).

## REFERENCES

1. Bilans Gospodarki Surowcami Mineralnymi Polski i Świata 2013, 2015, Instytut Gospodarki Surowcami Mineralnymi i Energią Polskiej Akademii Nauk, PIG-PIB, Warszawa
2. Bilans zasobów złóż kopalin w Polsce wg stanu na 31.12.2014 r., 2015, Praca zbiorowa pod red.: Szuflicki M., Malon A., Tymiński M., PIG-PIB, Warszawa
3. Critical Raw Materials for the EU. Report of the Ad-hoc Working Group on defining critical raw materials (30 lipca 2010);
4. Dubiński J., 2013, Zrównoważony rozwój górnictwa surowców mineralnych, *Journal of Sustainable Mining*, Vol.12, Nr 1, pp 1-5
5. Galos K., Nieć M., Radwanek-Bąk B., Smakowski T., Szymanek K., 2012, Bezpieczeństwo surowcowe Polski w Unii Europejskiej i na Świecie, *Biuletyn Państwowego Instytutu Geologicznego* 452:43-52
6. Komunikat Komisji do Parlamentu Europejskiego, Rady, Europejskiego Komitetu Ekonomiczno-społecznego i Komitetu Regionów z dnia 26.05.2014 r. w sprawie przeglądu wykazu surowców krytycznych dla UE i wdrażania inicjatywy na rzecz surowców, Bruksela.
7. Smakowski T., 2011, Surowce mineralne – krytyczne czy deficytowe dla gospodarki UE i Polski, *Zeszyty Naukowe Instytutu Gospodarki Surowcami Mineralnymi i Energii Polskiej Akademii Nauk*, nr. 81





## EFFECTS OF WOOD DUSTS ON WORKER'S HEALTH IN ROMANIAN WOOD INDUSTRY

Marius Kovacs\*, G. A. Gaman, A. Calamar, L. Toth, S. Simion

National Institute for Research and Development in Mine Safety and Protection to  
Explosion – INSEMEX Petroșani, 32-34 G-ral Vasile Milea Street, Petroșani 332047,  
ROMANIA

\*[insemex@insemex.ro](mailto:insemex@insemex.ro)

### ABSTRACT

Wood is one of the most important renewable resources in the world, chemically composed of organic and inorganic substances.

In Romania health and safety at work legislation transposes the European Directives on insertion of measures to encourage improvements in worker's safety and health at work, also when it comes to timber industry.

Woodworking through various technological operations releases wood dusts in the workplace air, dust that is hazardous to worker's health (leading to asthma, dermatitis, nasal cancer, pneumonia, and cough).

Analysis of the effects of wood dust on health of workers resulted from epidemiological studies of various abroad health institutes.

**Key words:** wood dust, occupational disease, cancer, worker's health.

### INTRODUCTION

Wood is one of the most important renewable resources and grows in forests around the world. Forests cover about one third of the total area of the globe, about 3.4 million km<sup>2</sup>. This area represents more than 1.0 trillion m<sup>3</sup> of the total biomass; of this biomass, about 3500 million m<sup>3</sup> per year are harvested, of which about half is used as fuel, mostly in developing countries. (1)

The species of trees that grow and are harvested in different countries vary considerably. Hardwoods dominate, for example, in Italy (oak, chestnut, beech) and are important species. In other colder regions, conifers are predominating: for example, pine and spruce and northern countries pine, spruce, hemlock, cedar and fir in Canada.

Wood processing industry is divided into mechanical and chemical processing industries. In turn, the mechanical wood processing industry is divided into the following sub-sectors: timber industry, plywood and board industry, furniture industry, production of matches and so on.

Physical / chemicals agents that workers are exposed to in wood processing production processes are presented in table 1.

**Table 1.** Physical / chemicals agents that wood processing workers are exposed to depending on the technological process

No.	Technological process		Physical/chemicals agents that workers are exposed to
1	Raw materials preparation	Disbarking	- softwood, hardwood and mixed dusts
		Sectioning	
		Chopping	
		Flattening	
		Chipping	
2	Treatment against fungus and insects		- Preservatives (organic solvents or water based) Example: chromium, copper and / or arsenic aqueous salts
3	Machinery processing	Chopping in length	- softwood, hardwood and mixed dusts
		Chipping	
		Calibrating	
		Grinding	
		Shaping	
		Mill off	
		Holing	
4	Assembly		- wood dusts - Solvents (in varnishes, paints, solvents, adhesives, paint strippers, stains, wood preservatives) Examples of harmful chemical agents: toluene, xylem, methanol, formaldehyde and so on.
5	Polishing up	Bleaching	- Peroxides, acids, bases
		Colouring	- Organic or water based dyes
		Puttying	- Lute, bitumen
		Grinding	- wood dusts and solvents
		Varnishing	Solvents (in varnishes, paints, solvents, adhesives, paint strippers, stains, wood preservatives) Examples of harmful chemical agents: toluene, xylem, methanol, formaldehyde and so on.
		Painting	
		Drying	
	Covering with laminated boards		

Consequently, workers in wood processing industry, at their workplaces, may be exposed to: softwood, hardwood and mixed wood dusts various solvents contained in paints and adhesives, preservatives such as toluene, xylene, methanol, isocyanate formaldehyde and other hazardous chemical agents.

The furniture industry accounts for approximately 80% of the raw material produced by the timber industry. In the second half of the twentieth century it

experienced a remarkable development because of population growth, intense urbanization process and rising of general standards of living. This industry is developed in large industrial centers where both extensive outlet and qualified work force can be found. The biggest producers of furniture are: USA, Russia, France, Germany, Italy, Sweden, Japan, Canada, and Romania.

### **ROMANIAN LEGISLATION ON WOOD DUST**

In Romania health and safety at work legislation transposes the European Directives on initiating measures to encourage improvements in the safety and health of workers at work. (3)

Related to occupational diseases the national legislative framework includes:

- Law 319/2006 on safety and health at work as amended, with implementing rules approved by Government Decision no. 1425/2006, as amended and
- Government Decision no. 1218/2006 and 1093/2006 on establishing minimum health and safety requirements to protect workers from the risks related to exposure to chemical agents respectively carcinogens or mutagens in workplaces.

In Romania, the limit value for softwood and hardwood dusts is  $5 \text{ mg} / \text{m}^3$ , and for cedar wood dust is  $0.5 \text{ mg} / \text{m}^3$ .

### **EFFECTS OF WOOD DUSTS ON TIMBER INDUSTRY WORKER'S HEALTH**

Particulates existing workplace atmosphere are disperse systems (solid dispersion phase and gaseous dispersion environment). This type of disperse systems is divided in turn into aerosol and aero-emulsion, depending on the size of the dispersion phase. (2)

Given these considerations, particulates in workplace environment can be defined as heterogeneous solid particles disperse systems (aerosol) found in a gas (air), particle size distribution being predominantly that of a colloid.

In America and Europe there are a number of studies on effects of wood dust on the health of workers.

Studies in the woodworking industry in North America and Canada have shown that up to 13.5% of people exposed to wood dust suffer from respiratory disorders.

Extensive data and studies clearly show lower respiratory tract sensitivity to wood from red cedar, alder, oak and limba species. There are reports of asthma triggered by timber dust from pine and cherry. (4)

A recent Danish study has shown that a wide range of respiratory organs diseases and disorders can be caused by wood dust, specifically asthmatic diseases and deterioration of pulmonary functions. European industrial medicine agrees that working and processing wood as raw material or work material may cause occupational diseases including cancer.

Means of entering the body, signs and symptoms of illness and effects of acute and chronic exposure on workers' health are shown in table 1.

**Table 1.** Effects on worker's health as well as means of entering the body

Effects on worker's safety	Means to enter the body	Signs and symptoms of exposure	Effects on worker's health
Risks of fire and explosion	-Inhalation (most important) By breathing in an work environment containing wood particulates -Contact with eyes and skin On contact with the wood dusts	Acute exposure: may lead to eye irritation, asthma, erythema, blistering, erosion and secondary infections of the skin, peeling, itching and blistering dermatitis. Chronic exposure: may lead to dermatitis, asthma, pneumonia, cough, shortness of breath, fever and other signs and symptoms associated with chronic bronchitis. Chronic exposure can lead to nasal cancer.	-Irritation of the eyes and skin -Dermatitis -Effects on the respiratory system (including asthma) -Nasal cancer (hardwood dusts)

Limit values for long term exposure of workers (8 hours) in some EU countries are shown in table.2.

**Table 2.** Exposure limit values for different countries

Country	Limit values (8 hours) mg/mc	Limit values (short time exposure) mg/mc
Austria(1)	Inhalable aerosol 2(A)	Inhalable aerosol 5(A)
Belgium	3(A)	
Denmark	1(A)	2(A)
European Union (2)	5(B)	
France (3)	1(A)	
Finland	2(A) 1 (new and refurbished factories)	
Germany	2(4,5) (A) 5(4,6) (A)	
Germany	- (B)(7) (C)(8)	
Hungary	5(A+C)	
Italia	Inhalable aerosol 5 (A)	
Norway	1 (B) 2 (C)	
Poland	4 (A) 2 (B) 2 (A + B)	
Spain	5 (A)	
Sweden	2 (A), 0.5 (pressure impregnated wood)	
Switzerland	Inhalable aerosol 2 (A)	
Holland	2 (B)	
Great Britain	5(A)	
Romania	5 (A)	

Caption:

A - All wood types, B - Hardwood, C – Pinewood

- (1) CTR (reference technical concentration) - based on technical feasibility.
- (2) Occupational exposure limit value tokens [2,3] and limit values for occupational exposure [4] Compulsory occupational exposure limit values – VLOEP.
- (3) Restrictive statutory values.
- (4) Caused by carcinogenicity, are not included in the VLOEP list; instead, concentration values are prescribed in the Technical Guidebook on wood dust.
- (5) Concentration values described in the Technical Guidebook on wood dust.
- (6) Concentration values described in the Technical Guidebook on wood dust based on technologies state of some workplaces / tools. For these situations additional control measures are provided.
- (7) Classified as being of Class "C 3B" - suspected carcinogen; commonly there is no differentiable value in terms of maximum allowable concentration.
- (8) Beech and oak dusts are classified as Class "C 1" - known human carcinogen; commonly there is no differentiable value in terms of maximum allowable concentration.

Table 2 shows differences between accepted limit values for worker's exposure to dust in workplaces, according to technical and technological level of wood processing in each country.

The lowest (less severe) inhalable dust limit values (1mg / m) for all types of wood for an 8 hours exposure of workers are registered in Denmark, France and Norway (1mg / m) for hardwood.

#### **The effect of wood dust on humans**

For worker in timber processing industry, several epidemiological studies investigated the risk of cancer, particularly cancer of the nasal cavity and paranasal sinuses. Some studies have provided specific information on the risk of cancer associated with exposure to wood dust, and these studies were given the greatest weight in the evaluation.

Most of the case studies available about nasal cavity and paranasal sinuses cancer showed increased risks associated with exposure to wood dust. These findings are supported by numerous case reports. Very high relative risks for adenocarcinoma associated with exposure to wood dust were observed in many countries, especially in Europe.

In the few studies where exposure was primarily to softwood dust risk of nasal cavities and paranasal sinuses cancer was high, but considerably lower than in studies of exposure to hardwood or mixed wood. In addition, in studies of exposure to softwood, hardwood exposure may not be clearly excluded. Wood dust concentration and exposure time may also contribute to differences in risks of workers exposed to different types of wood dusts. These studies consistently indicate that occupational exposure to wood dust is causally related to adenocarcinoma of the nasal cavity and the paranasal sinuses.

### Prevention of occupational diseases

Further, we will detail the measures to prevent occupational diseases.

• Changing the production process can be achieved through:

- Adapting work to the individual; job designing, choice of work equipment, choice of working and production methods, improving monotonous work.
- Partially or totally replacing hazardous substances. Substitution of substances known to be hazardous with others less hazardous, such as replacing benzene with toluene or xylene or replacing solvent-based adhesives and dyes with water based ones.
- Automation and / or closed processes; encapsulating equipment or parts of equipment to avoid worker's exposure to dust.



**Figure 1.** Model for encapsulating dust generating equipment

- Local aspiration (absorption) / general proper ventilation.



**Figure 2.** Exhauster model

- Work organizing- Action in Man-Machine-Environment System

- Safe storage:

- Organize storage;
- Ensuring compatibility of products stored together;
- Adequate ventilation, dryness and temperature;
- Proper labeling;
- Maintain FDS near chemicals.

- Personal Protective Equipment (PPE)

PPE should only be used when assessing the risk warrants, respectively when it is not possible to use collective protection measures.



**Figure 3.** Personal protective equipment (mask)

## CONCLUSIONS

- Wood is one of the most important long cycle renewable resources, based on which multiple sylvan, primary processing and furniture production activities have developed, supporting the development of Romanian economy.
- Wood industry produces raw products, semi-finished wood products with modified structures.
- Risk prevention and promoting measures to protect workers health is structured on "Product specific directives ", issued with the aim of ensuring the free movement of products within the European Community and on so-called "Social directives ", targeting health and safety of workers at the workplace.
- The presence of hazardous substances contained in the wood structure led to setting limit values for exposure of workers to these dusts, in most European Union countries.
- In Romania for inhalable cedar dusts, very hazardous to workers' health, the exposure limit value for 8 hours is  $0.5 \text{ mg} / \text{m}^3$  and for softwood and hardwood inhalable dusts limit value is  $5 \text{ mg} / \text{m}^3$ .
- Workers in wood manufacturing workplaces can be exposed to softwood, hardwood and mixed dusts and various solvents contained in paints and adhesives, preservatives such as toluene, xylene, methanol, isocyanate, formaldehyde and other hazardous chemical agents used in the wood industry.

- Research conducted abroad has shown that certain fractions of total dust are responsible for diseases of different parts of the worker's respiratory system.
- Analysis of wood dust effects on health of workers resulted from epidemiological studies conducted by various abroad health institutes.
- There are differences between the accepted limit values for worker's exposure, according to wood processing technical and technological level in each country. The lowest (less severe) inhalable dust limit values for all types of wood are registered in Denmark, France and Norway (1mg / m) for hardwood.

#### **REFERENCES**

1. INCD INSEMEX Petrosani, Nucleu Program (PN-16 43 01 06), "Assessing the risk of occupational exposure of workers to inhalable wood dusts and dispersion particle size determination in workplaces." , phase I, 2016
2. IARC, Monographs on the Evaluation of Risks carcinogenic to humans, vol. 62, Wood dust and formaldehyde, World Health Organization International Agency for Research on Cancer
3. Corneliu Neagu, Mihaela Negru, Guidebook on general issues of Industrial Toxicology, National Institute of Public Health - 2013
4. Occupational risks, dusts and fibers, Ministry of Labor, Family and Social Protection





## INDUCTIVELY COUPLED PLASMA MASS SPECTROMETRY AS A TOOL FOR CASE STUDY OF ABANDONED TUNGSTEN MINE

Umran Seven Erdemir<sup>1</sup>, H. Arslan<sup>2</sup>, G. Guleryuz<sup>2</sup>, S. Gucer<sup>1\*</sup>

<sup>1</sup>Uludag University, Faculty of Art and Science, Department of Chemistry  
16059 Bursa, TURKEY

<sup>2</sup>Uludag University, Faculty of Art and Science, Department of Biology  
16059 Bursa, TURKEY

\*sgucer@uludag.edu.tr

### ABSTRACT

Plants growing on the abandoned Tungsten mine on Uludag Mountain, highly contaminated with W, and Mo have been studied for their biogeochemical indication/prospecting and mine restoration potential. The selected native species were *Anthemis cretica* L. subsp *carpatica*, and *Trisetum flavescens* (L.) P. Beauv., *Marrubium astracanicum*, *Erysimum pulchellum*, and *Plantago holosteum*. Trace element contents of different parts of plants and their soils were analyzed simultaneously by inductively coupled plasma mass spectrometry (ICP-MS) after acid digestion process.

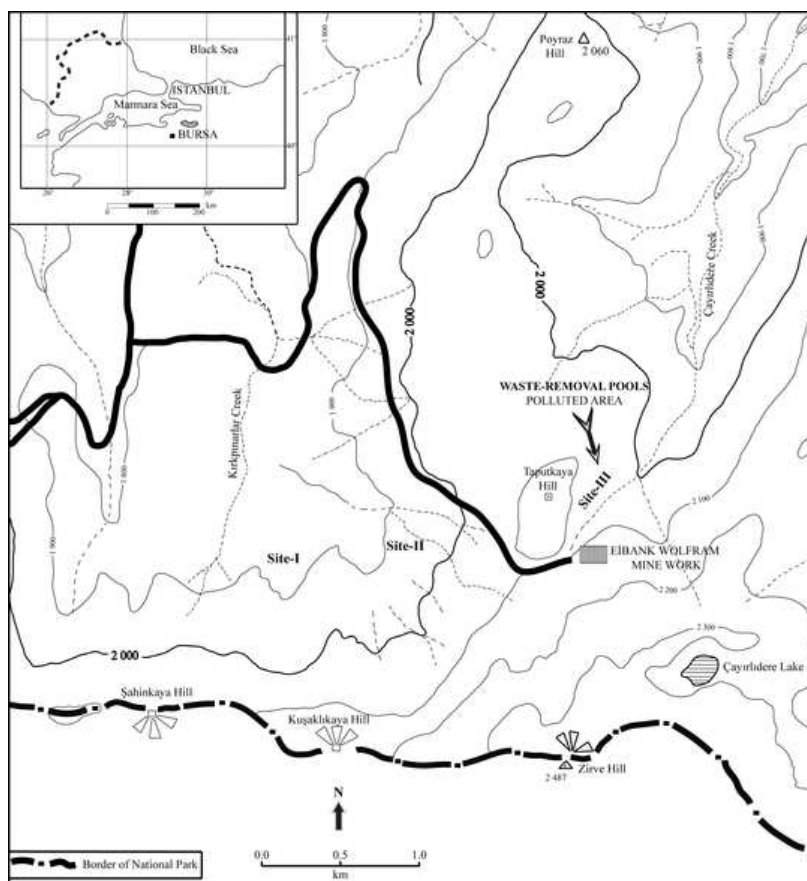
**Key words:** Tungsten, molybdenum, bioaccumulation, bioindication, mine restoration, native plants, soils, inductively coupled plasma-mass spectrometry.

### INTRODUCTION

The abundances of trace element in plants significantly depend on plant species, their ages and growth condition in environment. In our early studies, Atomic Absorption Spectrometry were used for single element analysis in Tungsten mine monitoring<sup>1</sup>. On the other hand, multi element screening of the ecological samples are required in ecology for better understanding their biological and physiological functions. In ICP-MS measurements, many elements are subjected to isobaric or polyatomic interferences.<sup>2, 3</sup> More serious problems are often encountered with polyatomic interferences which may be formed in the plasma or interface region, while some interfering species already exist in the sample matrix and survive the journey through the ICP. These interferences arise from atoms associated with the plasma gas (i.e. Ar) associated reagents (e.g. O, H, N, Cl, S), and the sample matrix.<sup>4</sup> They are particularly problematic at masses below m/z 80.<sup>4,5</sup> In our study, quality parameters of any analytical data that were obtained by ICP-MS were evaluated for the content of W and Mo elements in mentioned species.

## MATERIAL AND METHOD

The study was carried out around abandoned Wolfram Mine Work on Uludag Mountain. Waste removal pools and waste canals were constructed on the granite substratum. Two sample sites were selected from unpolluted areas (Site I and II) and one from waste removal pool (Site-III). Soil and plant samples were taken from three different places at each sampling site. Sampling area is shown in Figure-1.



**Figure 1.** Investigation area and sampling sites (re-drawn from Güleriyüz et al., 2002).

Soils samples were sifted with a standard 2-mm sieve and then dried in air. Plant parts were separated carefully, washed, and then were dried in an oven until their weights become constant. Dried samples were grounded for analysis. Elan 9000 inductively coupled plasma–mass spectrometry (ICP-MS) (PerkinElmer SCIEX, Shelton, CT, USA) was used for the analysis of Mo, and W in the plant parts separately. Perkin-Elmer Ryton cross-flow nebulizer, a Scott-type double-pass spray chamber, a

standard glass torch, nickel sampler and skimmer cones (i.d.:1.1 mm and 0.9 mm, respectively) were the components of ICP-MS equipment. Additionally, the optimum instrument conditions were as follows: RF power: 1000 W; plasma argon flow rate: 17.0 L min<sup>-1</sup>; nebulizer gas flow rate: 0.85 L min<sup>-1</sup>; sample uptake rate: 1.5 mL min<sup>-1</sup>; dwell time: 50 ms; scanning mode: peak hopping; and detector mode: dual. The classical open wet digestion procedure was applied to the samples (300-500 mg) with HNO<sub>3</sub> and H<sub>2</sub>O<sub>2</sub> in a borosilicate glass vessel. Working solutions for external calibration. Calibration curves were constructed with seven points (5.6–3000 µg L<sup>-1</sup> for W). The differences among the sampling sites regarding the element contents of plants and soil samples were tested by one-way ANOVA. We used Tukey's HSD test to determine the differences among sample sites.

## RESULTS AND DISCUSSION

Selection of measured isotopes is the key factor for eliminating the isobaric interferences. In our case, it is easy to find sensitive and interference free isotopes for measurement.

These interferences arise from atoms associated with the plasma gas (i.e. Ar) associated reagents (e.g. O, H, N, Cl, S), and the sample matrix.<sup>3</sup> They are particularly problematic at masses below m/z 80.<sup>4,5</sup> The Main problem in this case is the use of chloride free acids for digestion procedures. It was selected in our digestion procedure. The other precaution is the dilution of the samples in a proper level in our working range. Besides these, reference standard materials or standard addition methods may be used for to check the selectivity of the measurements. W has 5 and Mo has 7 isotopes. As a result of our study, <sup>98</sup>Mo and <sup>134</sup>W were used in our measurements. This isotopes are also the most abundance ones and show no interference except Ru, Os and their oxides. Although standard deviation of the standard solutions is small, it can be at least ten factors higher in plant and soil samples. It is not possible to control the homogeneity of samples beside the triplicate samples were used. The ratio of determined levels of the bioconcentration factor (BF) was obtained by dividing the total content in shoots by the total content in the soil. The calculated BF values can be used for different transport behavior of species to different elements, in our case W and Mo for unpolluted areas and waste removal pools, in respectively. (Table 1-4). BF ratios are also shown in Table 5. W and Mo levels are different for selected species under stress conditions that shows their different biological responses for Mo and W. *Trisetum flavescens* was the sensitive species against W according to BF ratios in Table 5.

**Table 1.** Determined W levels from unpolluted area

Species	W				BF
	Soil	Root	Shoots	Total	
<i>Antemis cretica</i>	61 ± 13	5 ± 2	5 ± 2	10 ± 3	0.08
<i>Trisetum flavescens</i>	32 ± 8	1 ± 0	8 ± 2	9 ± 0	0.25
<i>Marrubium astracanicum</i>	3 ± 1	1 ± 0.04	1.0 ± 0.4	1.5 ± 0.4	0.33
<i>Erysimum pulchellum</i>	90 ± 26	3 ± 1	7 ± 0.2	10 ± 1	0.77
<i>Plantago holostium</i>	3.4 ± 0.4	0.05 ± 0.03	0.5 ± 0.2	0.58 ± 0.18	0.15

**Table 2.** Determined Mo levels from unpolluted area

Species	Mo				
	Soil	Root	Shoots	Total	BF
<i>Antemis cretica</i>	0.6 ± 0.2	2 ± 1	3 ± 1	5 ± 1	5
<i>Trisetum flavescens</i>	0.3 ± 0.01	4 ± 1	7 ± 1	11 ± 1	23
<i>Marrubium astracanicum</i>	8 ± 1	9 ± 3	7 ± 2	16 ± 5	0.88
<i>Erysimum pulchellum</i>	0.7 ± 0.03	2 ± 0.6	4 ± 1	6 ± 1	6
<i>Plantago holosteum</i>	3 ± 0.4	0.2 ± 0.02	0.2 ± 0.04	0.4 ± 0.05	0.06

**Table 3.** Determined W levels from waste removal pools

Species	W				
	Soil	Root	Shoots	Total	BF
<i>Antemis cretica</i>	1379 ± 672	9 ± 0	55 ± 24	64 ± 24	0.04
<i>Trisetum flavescens</i>	1093 ± 224	8 ± 0	35 ± 16	43 ± 16	0.03
<i>Marrubium astracanicum</i>	2117 ± 131	12 ± 2	397 ± 61	408 ± 62	0.19
<i>Erysimum pulchellum</i>	883 ± 178	21 ± 13	185 ± 112	206 ± 124	0.21
<i>Plantago holosteum</i>	2591 ± 112	28 ± 5	62 ± 6	85 ± 17	0.02

**Table 4.** Determined Mo levels from waste removal pools

Species	Mo				
	Soil	Root	Shoots	Total	BF
<i>Antemis cretica</i>	0.8 ± 0.01	0.3 ± 0.2	1.6 ± 0.8	1.9 ± 0.8	2
<i>Trisetum flavescens</i>	0.7 ± 0.02	1.4 ± 1	2 ± 1.2	3.4 ± 1.2	2.9
<i>Marrubium astracanicum</i>	6 ± 1	0.04 ± 0.01	0.9 ± 0.1	0.9 ± 0.1	0.15
<i>Erysimum pulchellum</i>	0.5 ± 0.1	1.0 ± 0.3	1 ± 0.3	2 ± 0.6	2
<i>Plantago holosteum</i>	7 ± 1	0.5 ± 0.1	2.8 ± 0.1	3 ± 0.1	0.4

**Table 5.** BF ratios of the selected species

	W	Mo
	<i>Antemis cretica</i>	200
<i>Trisetum flavescens</i>	830	790
<i>Marrubium astracanicum</i>	173	587
<i>Erysimum pulchellum</i>	366	300
<i>Plantago holosteum</i>	750	15

## CONCLUSION

ICP-MS was found as a useful technique for the interpretation of biological and physiological responses of different species under any elemental stress conditions, in our case study about W and Mo. Further studies have to be performed and have being planned by our research group by different invasive technique based on Laser Ablation-ICP-MS for micro distributions in plants and metal imaging studies together.

## REFERENCES

1. Guleryuz,G., Arslan ,H., Kırmızı ,S., Gucer,S. (2002).Investigation of influence of tungsten mine wastes on the elemental composition of some alpine and subalpine plants on Mount Uludag , Bursa, Turkey. *Environmental Pollution* 120, 707–716
2. Jarvis, K. E., Gray A. L. and Houk, R. S., *Handbook of Inductively Coupled Plasma Mass Spectrometry*, Blackie, Glasgow, 1992.
3. Evans, E. H. and Giglio J. J.(1993) Interferences in inductively coupled plasma mass spectrometry. A review, *Journal of Analytical Atomic Spectrometry* 8, 1-18
4. Tittes, W., Jakubowski, N., Stuver, D., Tolg G. and Broekaert, J. A. C. (1994) Reduction of Some selected spectral interferences in inductively coupled plasma mass spectrometry. *Journal of Analytical Atomic Spectrometry*, 9, 1015-1020
5. Reed , N.M., Cairns, R. O., Hutton R.C. and Takaku ,Y. (1994) Characterization of polyatomic ion interferences in inductively coupled plasma mass spectrometry using a high resolution mass spectrometer *Journal of Analytical Atomic Spectrometry*, 9, 881-896
6. Tan S. H. and Horlick ,G.(1986) *Applied Spectroscopy. Background Spectral Features in Inductively Coupled Plasma/Mass Spectrometry*, 40, 445-450



## STABILIZATION/SOLIDIFICATION OF ELECTRIC ARC FURNACE DUST IN SLAG BASED ALKALI ACTIVATED BINDERS

Irena Nikolic<sup>1\*</sup>, D. Djurovic<sup>2</sup>, B. Mugosa<sup>2</sup>

<sup>1</sup>University of Montenegro, Faculty of Metallurgy and Technology,  
Dzordza Vasingtona bb, 81 000 Podgorica, MONTENEGRO

<sup>2</sup>Institute of Public Health of Montenegro,  
Dzona Dzeksona bb, 81 000 Podgorica, MONTENEGRO

\*[irena@ac.me](mailto:irena@ac.me)

### ABSTRACT

Steel making process in electric arc furnaces generates the waste materials: non-hazardous electric arc furnace slag (EAFS) and hazardous electric arc furnace dust (EAFD). The possibility of stabilization/solidification of EAFD in EAFS based alkali activated binders was investigated.

The results have shown that EAFD addition in amount up to 5 % can be fixed using the alkali activation of EAFS. EAFD addition affected the properties of fresh and hardened alkali activated binders based on EAFS.

**Key words:** steel slag, alkali activation, steel dust, stabilization/solidification, heavy metals.

### INTRODUCTION

Electric arc furnace dust (EAFD) is a waste material generated during electric arc furnace steel making process. The quantity of EAFD generated is about 1% of the steel produced [1]. This dust is mainly comprises of iron oxide (approx. 50%) and zinc oxide (approx. 21%) while other constituents include: oxides of calcium, magnesium, silicon, nickel, chromium, etc. [1]. This dust is considered as hazardous waste due to the heavy metals content and cannot be disposed of in a landfill due to their leaching into the environment.

Moreover, the steel production in electric arc furnaces generates another by-product the electric arc furnace slag (EAFS). This slag is generated generates much higher quantity of EAFS (up to 15 % per tone of slag), in comparison to the EAFD but the EAFS, based on its properties, is classified as non-hazardous waste [2]. The EAFS is mainly comprises of iron oxides, such wustite, magnesioferrite/magnetite and hematite [3] but it mainly depend on the charge composition, desired grade of steel purity and the furnace operation conditions [2].

The EAFD and EAFS impose a different way of handling due to the difference in the composition. Worldwide approximately, 70% of EAFD is sent for land fill, the

remaining 30% is processed for Zn recovery and other purposes, [1]. On the other hand, a high percentage of EAFS is used in a civil engineering, in different applications but the 35% remaining slags are still dumped [3]. Limiting factor for EAFS application in a civil engineering is content of free CaO and MgO which are sensitive to weathering conditions and induce the volume instability of EAFS. In recent decade, innovative alkali activation/geopolymerization technology is a considering as a promising method for EAFS valorization in civil engineering [4,5]. Alkali activated binders/ geopolymers are considering as a new generation of building materials which show the comparable or better properties than traditionally used cement based materials [6,7].

On the other hand, considering the toxicity of EAFD, especial attention is paid to its recycling. A various methods are proposed for this purpose, like returning EAFD to the electric arc furnace with the aim to increase the Zn content to the value which will be cost effective for its recovery, recovery of valuable metal mainly Zn, by pyro- or hydro-metallurgical processes [8,9] and stabilization/solidification in construction materials which potentially can be used in a civil engineering [10].

Moreover, our previous research indicated that innovative technology (alkali activation/geopolymerization) may be successfully used for immobilization (stabilization/solidification) of EAFD [11]. In this process, the non-hazardous waste (coal fly ash) can be successfully used for stabilization of toxic waste (EAFD) and both of them converted in a in useful environmental acceptable materials. Alkali activation technology enables fixation of heavy metals from EAFD in amorphous alkali activated binders and convert this waste in a more stable form. Mechanical properties and mobility of toxic materials to the environment when contaminated alkali activated binder expose to the different aquatic conditions is crucial factor limiting their potential application. In this paper we have investigated the possibility of use of non-hazardous waste from steel production for stabilization/solidification of toxic waste from the same industrial process. Alkali activation of EAFS is used for stabilization/solidification of EAFD.

## EXPERIMENT

The EAFS and EAFD used in this investigation was supplied from the Steel Mill Nikšić in Montenegro. Chemical composition of EAFS and heavy metal content in EAFD are given in the table 1.

EAFS based alkali activated binders were prepared by mixing the EAFS with alkaline activator in a mass ratio of 4. The alkaline activator was prepared by the mixing of 10 M NaOH and Na<sub>2</sub>SiO<sub>3</sub> solution ( molar ratio SiO<sub>2</sub>/Na<sub>2</sub>O= 3.2 ) in a mass ratio of 1.5. Obtained paste was casted in a cylindrical plastic mould, cured for 48 h at 65 °C in the oven. After demoulding, the samples were cured additional 14 days at ambient temperature.

The EAFS based alkali activated binders contaminated with EAFD were prepared in the way that EAFD was first mixed with NaOH solution for 10 min to allow leaching of leachable component from EAFD and than Na<sub>2</sub>SiO<sub>3</sub> solution was added. At the end, EAFS was added into the mixture of alkali silicate solution and dust, and mixing was continued for additional 5 min. The percentage of EAFS substitution with EAFD was 1, 3, 5 and 7 %. The casting and curing procedure of contaminated alkali activated binders was the same as in a case of pure EAFS based binders.

**Table 1.** Chemical composition of EAFS and heavy metals in EAFD.

EAFS		EAFD	
Component	%	Component	%
CaO	39.1	Zn	29.33
CaF	2.9	Pb	3.19
FeO	3.0	Cr	0.42
SiO <sub>2</sub>	26.1	Cd	0.10
Fe <sub>2</sub> O <sub>3</sub>	0.2	Cu	0.35
MgO	13.64		
MnO	0.27		
Cr <sub>2</sub> O <sub>3</sub>	0.02		
Al <sub>2</sub> O <sub>3</sub>	14.24		
C	0.27		
S	0.01		
TiO <sub>2</sub>	0.3		

Initial and final setting times of fresh alkali activated pastes were determined using the Vicat needle. The hardened samples were tested for compressive test. The immobilization efficacy was evaluated using TCLP Method No. 1311, (USEPA -US Environmental Protection Agency) and EN 12457-2 (EULFD -European Landfill Directive) leaching tests. For the purpose of TCLP and EN 12457-2 reproduction, grinded specimens are used for leaching tests. During TCLP test, the solid was pulverized and mixed with an extraction fluid (acetic acid solution pH = 3,) at the solid: liquid ratio 1:20 for 18 h. In the case of EN 12457-2 test, solid phase was mixed with a deionized water at the solid:liquid ratio 1:10 for 24 h. After the tests, solid and liquid phases were separated by filtration and the eluates were acidified with nitric acid to the value of pH less than two. Metals content was determined using ICP-OES.

## RESULTS AND DISCUSSION

Influence of EAFD addition on the initial and final setting time of EAFS based alkali activated binders is given in the table 2. The results show that EAFD addition to the EAFS decrease the initial and final setting time. This decrease was higher as the content of EAFD was higher. When EAFD was added to the EAFS in a amount of 7 %, an extremely viscous paste (Fig.1) was obtained which enabled the casting of paste in a mould and thus this sample was not tested for setting time and compressive strength.

**Table 2.** Influence of EAFD addition on the initial and final setting time of EAFS based alkali activated binders

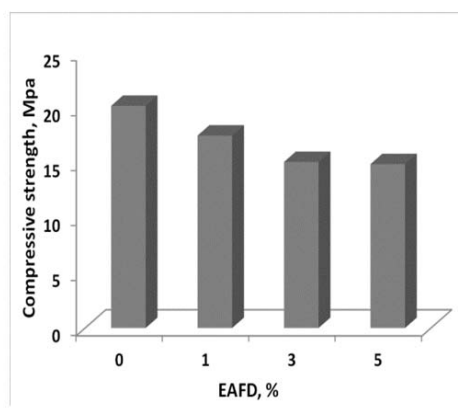
EAFD content (%)	Initial setting time(min)	Final setting time(min)
0	25	55
1	19	47
3	12	35
5	10	25



The results of investigations of EAFD addition on the mechanical properties of EAFS based alkali activated binders are given in the Fig. 2. The pure EAFS based alkali activated binders reach the compressive strength of 20.2 MPa. It is evident that EAFD addition in amount from 1-5 % decrease the compressive strength of EAFS based alkali activated binders. 1,3 and 5 % of EAFD decrease the strength of alkali activated binders for 13.3 %, 23 % and 23.5 %, respectively.



**Figure 1.** Fresh EAFS based alkali activated binder with the 7 % of EAFS



**Figure 2.** Influence of EAFD addition on the compressive strength of EAFS based alkali activated binders

The results of investigation of the efficiency of immobilization of heavy metals from electric arc furnace evaluated using TCLP and EN 12457-2 compliance tests were presented in the tables 3 and 4. The efficiency was evaluated by comparing the metals concentration in a TCLP and EN 12457 leachates with limits established by US EPA and EULFD. It is evident that concentrations of heavy metals in leachates are below the limits defined by US EPA and EULFD for non hazardous waste, what indicate to the successful fixation of heavy metals from EAFD.

**Table 3.** Content metal analysis from EAFS based alkali activated binders contaminated with EAFD (mg/kg) ( EN 12457-2) and EULFD limits (<means under detection limit).

EAFD, (%)	Metal content				
	Cd	Cr	Pb	Zn	Cu
1	<0.005	0.009	0.006	0.02	0.008
3	<0.005	0.008	0.006	0.03	0.009
5	<0.005	0.009	0.008	0.02	0.007
Inert waste	0.04	0.5	0.5	4	2
Non-hazardous waste	1	10	10	50	50
Hazardous waste	5	70	50	200	100

**Table 4.** Content metal analysis from EAFS based alkali activated binders contaminated with EAFD (mg/l) (TCLP) and USEPA limits (<means under detection limit).

EAFD, (%)	Metal content				
	Cd	Cr	Pb	Zn	Cu
1	< 0.003	0.015	0.008	0.01	0.007
3	<0.003	0.012	0.007	0.01	0.005
5	<0.003	0.015	0.008	0.04	0.007
US EPA limits	1	5	5	300	

## CONCLUSIONS

The results of investigation have proved that EAFD can be fixed into the EAFS based alkali activated binders. Concentrations of heavy metals in leachates are below the limits defined by US EPA and EULFD for non-hazardous waste. The limiting factor for EAFD stabilization /solidification using the EAFS based alkali activated binders is workability of fresh paste. The maximal amount of EAFD which can be added to the EAFS with respect to workability is 5 %. Addition of EAFD in amount higher than 5 %, lead to extremely viscous paste and disables the casting of fresh paste into the mould. Addition of EAFD in amount up to 5 % decrease the compressive strength of EAFS based alkali activated binders for 23.5 %.

## REFERENCES

- Maslehuddina M., Awan F.R., Shameem M., Ibrahim M., Ali M.R., Effect of electric arc furnace dust on the properties of OPC and blended cement concretes, *Construction and Building Materials* 25 (2011) 308–312.
- Rastovčan- Mioč A., Sofilić T., Mioč B., Application of electric arc furnace slag, *Conference Proceeding MATRIB 2009* (2009) 436–444.
- M. Frías Rojas, M.I. Sánchez de Rojas, Chemical assessment of the electric arc furnace slag as construction material: Expansive compounds *Cement and Concrete Research* 34 (2004) 1881–1888.
- Nikolić I., Karanović Lj., Janković – Častvan I., Radmilović V.V., Mentus S., Radmilović V.V., Improved compressive strength of alkali activated slag upon heating, *Materials Letters*, *Materials Letters* 133 (2014) 251–254.
- Nikolić I., Marković S., Janković – Častvan I., Radmilović V.V., Karanović Lj., Radmilović V.R., Modification of mechanical and thermal properties of fly ash based geopolymers by the incorporation of steel slag, *Materials Letters*, 176 (2016) 301–305.
- Pacheco-Torgal F., Castro-Gomes J., Jalali S., Alkali-activated binders: A review Part 1. Historical background, terminology, reaction mechanisms and hydration products, *Construction and Building Materials* 22 (2008) 1305–1314
- Li C., Sun H., Li L., A review: The comparison between alkali-activated slag (Si+Ca) and metakaolin (Si+Al) cements, *Cement and Concrete Research* 40 (2010) 1341–1349.

8. Tsakiridis, P.E., Oustadakis, P., Katsiapi, A., Agatzini-Leonardou, S., Hydrometallurgical process for zinc recovery from electric arc furnace dust (EAFD). Part II: Downstream processing and zinc recovery by electrowinning. *Journal of Hazardous Materials* 179 (2010) 8–14.
9. Chen, H.K., Kinetic study on the carbothermic reduction of zinc oxide. *Scandinavian Journal of Metallurgy* 30 (2001) 292–296.
10. Salihoglu, G., Pinarli, V., Salihoglu, N.K., Karaca, G., Properties of steel foundry electric arc furnace dust solidified/stabilized with Portland cement. *Journal of Environmental Management* 85 (2007) 190-197.
11. Nikolić I., Đurović D., Blečić D., Zejak R., Karanović Lj., Mitsche S., V.R. Radmilović, Geopolymerization of coal fly ash in the presence of electric arc furnace dust, *Minerals Engineering* 49, (2013) 24-32.



**THE PRELIMINARY EXAMINATION OF TECHNOGENIC WASTE MATERIALS FROM BOSNIA AND HERZEGOVINA USAGE POSSIBILITY IN PORTLAND-COMPOSITE CEMENT PRODUCTION**

**Ilhan Busatlic<sup>1</sup>, S. Muhamedagic<sup>1</sup>, N. Busatlic<sup>1</sup>, N. Merdic<sup>2</sup>, N. Haracic<sup>2</sup>**

<sup>1</sup>University of Zenica, Faculty of metallurgy and materials,  
Zenica, BOSNIA AND HERZEGOVINA

<sup>2</sup>Kakanj cement plant, Selima ef. Merdanovica 146,  
72240 Kakanj, BOSNIA AND HERZEGOVINA

**ABSTRACT**

Cement producers are trying as much as possible to use technogenic industrial waste. On one side, it is provided a big saving in energy consumption by using these materials, and on the other side, the less usage of natural resources has a positive effect on the environment. In this paper are discussed granulated blast furnace slag, fly ash and silica fume as industrial waste materials which can be used in a large extent during the cement production because these materials have hydraulic and pozzolanic properties. By replacing a portion of the cement with the above mentioned additives, their accumulation will be significantly reduced and at same time, it will be reduced the amount of cement that can lower the price of the final product. These replacement additives also have very good resistance to aggressive environments. Also, by replacing portion of clinker with granulated blast furnace slag, fly ash and silica fume it would be produced more environmentally friendly cement.

**Key words:** granulated blast furnace slag, fly ash, silica fume.

**INTRODUCTION**

Particular importance in the cement production is given to the significance of reducing CO<sub>2</sub> emissions in the cement industry. Reducing the content of clinker and the use of other additives in the cement production, creates the possibility of reducing CO<sub>2</sub> emissions during production. It's not just the environmental aspect given as an argument for favoring the production of portland-composite cement, but also it is given sustainable alternative to cement from a technical point of view, since certain additives in the cement production are much softer for the grinding than pure portland cement, and thus large amounts of electricity energy are saved. Otherwise, the cement industry is one of the largest consumers of electrical energy. Possibilities of combining multiple additives (fly ash, granulated blast furnace slag, silica fume), provide portland-composite cement great advantages while using these types of cement in various fields.

## **CHARACTERISATION OF CONSTITUENTS**

Constituents that are discussed in this paper are:

- granulated blast furnace slag from company ArcelorMittal Zenica,
- fly ash from Thermal power plant Kakanj,
- silica fume from company B.S.I. d.o.o. Jajce

Granulated blast furnace slag is a byproduct from the production of iron in blast furnaces. It is a latent hydraulic material, because in the process of cement hydration after release of  $\text{Ca(OH)}_2$ , hydration of blast furnace slag further runs undisturbed. It is formed when the agents (the ash from the coke and limestone) are added to the iron ore to remove impurities. In the process of iron extraction from iron ore, is formed liquid slag (composed primarily from silicates and aluminosilicates of calcium and other phases) which floats on the top of liquid iron. Liquid slag is then separated from liquid metal and cools down. If the liquid slag cools fast enough with water, it will be formed granulated blast furnace.[1]

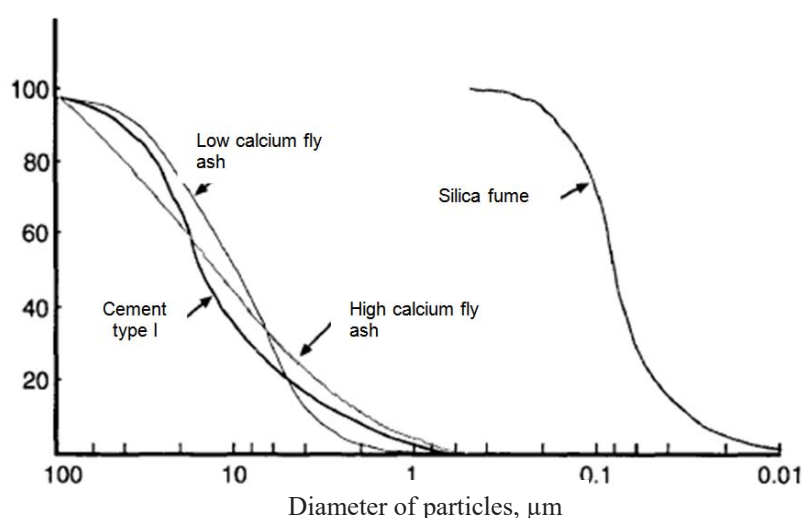
Granulated blast furnace slag consists of glassy and crystalline phases. Usually, granulated slag contains more than 85 wt. % of glassy phase. The content of glassy phase and alkalinity are considered the most important factors that influence the hydraulic properties. Crystalline slag (slag that is formed if it is not rapidly cooled) has a small reactive properties. The amount of glassy phase in the slag can be controlled by the manufacturer. The glassy phase in the blast furnace slag is much more homogeneous than in fly ash. Granulated blast furnace slag is the most commonly used additive in cement production. It has an advantage ahead of other mineral raw materials because of easy transport to the factory, deposit and manipulation in the cement factory.[1]

Fly ash is silico-aluminum material which is capable to react with the  $\text{Ca(OH)}_2$  at the room temperature and at the same forms compounds that have hydraulic properties. Fly ash consists of fine, spherical particles with a fineness that is similar to cement fineness. With this granulometric characteristics fly ashes are able to reduce the standard consistency of cement and improve the cement composite workability. Depending on the type of coal fly ashes have a different chemical composition and different properties. Fly ash from bituminous coal and anthracite is pozzolanic (EN 197-1 Type V, ASTM Class F), while the fly ash generated from combustion of sub-bituminous coal and lignite is pozzolanic and hydraulic due to the high content of CaO (EN 197-1, Type W, ASTM Class C). Both types of fly ash contain significant amounts of amorphous phase. Each type of fly ash may have particles with different morphology, different distribution of particle size and glassy phase. There are also other forms of fly ashes division based on the the carbon content, reactivity and solubility of  $\text{SiO}_2$  or based on the pozzolanic activity. Fly ash, which is mentioned in this paper belongs to the calcium fly ashes (class W) according to EN 197-1. [2]

Fly ash with low CaO content, due to the high share of  $\text{SiO}_2$  and  $\text{Al}_2\text{O}_3$  consist mainly from aluminosilicate glass. When in the furnace large spherical shapes of molten glass fail to quickly and uniformly cool down, inside the spherical shape occurs crystallization in the form of thin needles of aluminosilicates called sillimanite ( $\text{Al}_2\text{O}_3 \cdot \text{SiO}_2$ ) and mullite ( $3\text{Al}_2\text{O}_3 \cdot 2\text{SiO}_2$ ). Relative non reactivity of flying ash with low CaO is

conditioned by this partial "deglazing" and by the presence of crystalline aluminosilicate. Fly ashes with high CaO content, and which may contain a considerable amount of MgO, alkalis and sulphates, per structural composition are more complex than fly ashes with a low content of CaO.[1]

Silica fume (SF-silica fume) is formed by reduction of high purity quartz with coal in electric arc furnaces in the production of silica and ferro-silica alloys and it consists of very fine spherical particles that contain at least 85 wt. % of amorphous SiO<sub>2</sub>. Silica fume consists primarily of pure non crystalline silicon dioxide. XRD analysis of silica fume indicates that it is a glassy silicon dioxide. Slow cooling of silica fume, that is pre-heated to 1100 ° C, leads to the formation of the crystalline form of silicon dioxide cristobalite. Particles of silica fume are much finer than fly ash or cement particles. Thus, silica fume has a strong pozzolanic character. Silica fume samples are showing particle size distribution that is two orders of magnitude finer than the other samples (Figure 1) [3].



**Figure 1.** Comparison of the particle size distribution of the silica fume, fly ashes and portland cement [3]

### THE EXAMINATION RESULTS

The chemical analysis of granulated blast furnace slag, fly ash and silica fume is given in Table 1. Mineralogical composition of granulated blast furnace slag is given in Table 2, and the mineralogical composition of the fly ash is given in Table 3. [2]. To be able to use technogenic industrial waste for cement production, it is necessary for technogenic industrial waste to conform specific requirements of the European standard EN 197-1 (table 4). [2]

**Table 1.** The chemical composition of constituents [3]

	SiO <sub>2</sub>	Al <sub>2</sub> O <sub>3</sub>	Fe <sub>2</sub> O <sub>3</sub>	CaO	MgO	SO <sub>3</sub>	Na <sub>2</sub> O	K <sub>2</sub> O
	%	%	%	%	%	%	%	%
GBFS	39,90	7,70	1,58	36,70	6,98	0,89	0,34	1,22
Fly ash	46,00	17,70	7,00	19,40	3,62	0,60	0,82	2,98
Silica fume	93,94	0,07	0,15	0,19	0,91	0,60	0,82	2,98

**Table 2.** Mineralogical composition of GBFS [3]

Minerals	Glassy phase	Mervinite (C <sub>3</sub> MS <sub>2</sub> )	Akermanite (C <sub>2</sub> MS)	Quartz (SiO <sub>2</sub> )	Calcite (CaCO <sub>3</sub> )
weight (%)	98,2	0,1	0,7	0,1	0,8

**Table 3.** Mineralogical composition of fly ash [2]

Minerals	C <sub>3</sub> S	C <sub>2</sub> S	C <sub>4</sub> AF	Anhydrite (CaSO <sub>4</sub> )	Mullite (Al <sub>6</sub> Si <sub>2</sub> O <sub>13</sub> )	Quartz (SiO <sub>2</sub> )	Hematite (Fe <sub>2</sub> O <sub>3</sub> )	Maghemite (Fe <sub>2</sub> O <sub>3</sub> )	Amorphous phase
weight (%)	4,4	8,0	5,0	0,8	3,9	3,1	0,5	3,8	62,0

**Table 4.** The requirements of EN 197-1 for constituents [3]

	Requirements EN 197-1	GBFS	Fly ash	Silica fume
Reactive CaO	>10,0 wt. %		15,20	
Reactive SiO <sub>2</sub>	>25,0 wt. %		40,60	
Wet sieving	10<x<30 wt.%		23,00	
Activity index	≥75 %		90	
Expansion	≤ 10 mm		1,00	
CaO+MgO+SiO <sub>2</sub>	≥66,6 wt. %	83,58		
(CaO+MgO)/SiO <sub>2</sub>	>1,0	1,09		
Loss by annealing	<4,0 wt.%			1,00
Specific surface area	>15000 cm <sup>2</sup> /g			18700

## DISCUSSION AND CONCLUSIONS

The results of the conducted study have shown that those materials that are treated as industrial waste, from physico-chemical approaches, can be useful material for the manufacture of portland-composite cement. Granulated slag satisfies the requirements of EN 197-1 where the sum of CaO, MgO and SiO<sub>2</sub> is 83,58% and the ratio of CaO / SiO<sub>2</sub> is 1,09. Granulated blast furnace slag contains 98,2% of a glassy phase, and it is considered that the optimum amount of glassy phase in GBFS is about 98%.

Chemical analysis of fly ash (Table 1) shows that, in accordance with EN 197-1, fly ash from Thermal power plant Kakanj belongs to the calcium fly ash, because its content of reactive CaO is greater than 10 wt. % (15,20%), and the content of reactive SiO<sub>2</sub> exceeds 25% (40,60%). The specific surface of fly ash is 2440 cm<sup>2</sup>/g, a bulk

density 2,70 g/cm<sup>3</sup>. Loss by annealing of fly ash is 0,42%, which is within the limits prescribed by standards EN 197-1 (max. 5 wt.%). The high content of amorphous phase in the ash is desirable, because the amorphous phase contains reactive aluminosilicates, which makes fly ash very valuable pozzolanic material, while the crystalline phases are poorly reactive at normal temperatures. In the fly ash discussed in this paper the content of the amorphous phase is 62,0%

Silica fume that was used in this study meets the EN 197-1 in terms of amorphous SiO<sub>2</sub> amount which is 93,94 wt. % (according to Standard at least 85 wt.% SiO<sub>2</sub>) and in terms of loss by annealing which is 1,0 wt. % (according to the Standard maximum loss by annealing amounts to 4,0 wt.%).

Since the materials mentioned in this paper conform all the requirements prescribed by EN 197-1, it is safe to begin to use these materials as additives in the portland-composite cement production. Of course, during the production of any of the aforementioned types of cements it is necessary to have information about the quality of the individual constituents, to avoid getting results out of mentioned standards. By using additive materials for the cement production, it will be obtained more environmentally friendly cement, because in this case it is reduced the need for producing larger quantities of the clinker and therefore it is discharged to the atmosphere much less CO<sub>2</sub> and other gases during the production of clinker and that is the tendency of industrial manufacturers worldwide.

An additional benefit with less clinker production would be the economic effect, producing the cement with additives would save on fuel consumption for the clinker production and other materials related to the production of clinker.

#### **REFERENCES**

1. I. Bušatlić, Dodaci cementu, Hijatus, Zenica, 2013.
2. EN 197-1, Cement - Part 1: Composition, specifications and conformity criteria for common cements
3. N. Merdić, Razvoj nove klase portland-kompozitnih cementa u tvornici Cementa Kakanj, doktorska disertacija, Univerzitet u Zenici, Fakultet za metalurgiju i materijale u Zenici, Zenica, 2015.





**THE RESEARCH OF TEMPERATURE INFLUENCE AND ADSORBENTS  
STRUCTURE ON THE EFFICIENCY OF THE ORGANIC DYES  
ADSORPTION**

**Sanja Dobrnjac<sup>1</sup>, J. Penavin Skundric<sup>2</sup>, Z. Levi<sup>3</sup>, D. Lazic<sup>4</sup>, Lj. Vasiljevic<sup>4</sup>**

<sup>1</sup>„Projekt“ Banja Luka, Republic of Srpska, BOSNIA AND HERZEGOVINA

<sup>2</sup>University of Banja Luka, Faculty of Natural Sciences and Mathematics,  
Banja Luka, BOSNIA AND HERZEGOVINA

<sup>3</sup>University of Banja Luka, Faculty of Technology, Banja Luka,  
BOSNIA AND HERZEGOVINA

<sup>4</sup>University of East Sarajevo, Faculty of Technology, BOSNIA AND HERZEGOVINA

**ABSTRACT**

In many industries the colour of the product is often taken into account for example in production of motor oils, foodstuffs, paper, textiles and medicines. It is also very necessary to remove the colour from the waste water. For that purpose, the adsorption is a simple and economical method for the removal of dye in the place of origin. We have researched adsorption methylene blue from aqueous solution on the synthetic zeolite 5A and zeolite AW-500. To determine the BET specific surface and tests of textural properties of adsorbents, the low-temperature nitrogen adsorption - desorption from the gas phase was carried out. The adsorption from the liquid phase is held at temperatures of 293 and 303 K. The concentration of methylene blue was determined by spectrophotometric methods. The parameters of adsorption were counted based on the obtained Freundlich's adsorption isotherm. These results open up new possibilities of using adsorbents that have characteristics of molecular sieves in order to protect the environment and process improvements.

**Key words:** organic dye, methylene blue, waste water, zeolite 5A, zeolite AW-500.

**INTRODUCTION**

In many industries the colour of the product is often taken into account for example in production of motor oils, foodstuffs, paper, textiles and medicines. Organic dyes are an integral part of many industrial effluents and demand for appropriate methods to dispose them is urgent. Most commercial dyes are chemically stable and are difficult to be removed from wastewater. At present, more than 10,000 dyes have been effectively commercialized [1]. There are various conventional methods of removing dyes from waters. Among these methods, adsorption is by far the most versatile and widely used method because of its low cost and ease of operation [2]. Zeolites are microporous silicate minerals which have a very highly developed external and internal surface and excellent adsorptive abilities. The overall surface in these minerals can be up to one thousand bigger

than the geometric surface [3] This implies that they are very effective in terms of removal of undesired compounds. They are characterized by thermic and crystal structure stability.

In this research, the water solution of methylene blue has been used as adsorbate, in order to research the possibility of removal of organic dyes by adsorption into two synthetic zeolites 5A i AW-500. Methylene blue (3,7-Bis(dimethylamino)phenothiazin-5-ium chloride) is a heterocyclic aromatic compound belonging to the group of cationic phenothiazine colours, with molecular formula  $C_{16}H_{18}N_3SCl$ . It is used in the printing industry for dyeing, as an indicator of the chemistry and in the treatment of some diseases in medicine. It is suitable for use as the adsorbate, because of the easily dissociates to methylene blue chloride anion and a cation, wherein the solution gives a dark blue colour. Adsorption of methylene blue on porous materials, provides basic information about the porosity of these materials and their general adsorption properties.

## MATERIALS AND METHODS

In the adsorption from the liquid phase adsorbate is an organic dye - methylene blue, product Merck KGaA Darmstadt. The standard aqueous solution of concentration 100 mg/L has been used. To research the possibility of adsorption, organic dyes were prepared with a concentrations would be expected in practice. Mass solution concentrations of 1.0, 2.0, 2.8, 4.0, 6.0 and 8.0 mg/L were prepared for this purpose. The absorbance of methylene blue solutions were measured on the basis spectrum of an absorption with wavelength 663 nm. For determination of the concentration before and after adsorption suitable for use, the staining solution, the method of UV / VIS spectroscopy. To determine the concentration of methylene blue solutions before and after adsorption was used method of UV/VIS spectroscopy. The experimental part was developed in the Laboratory of General and Inorganic Chemistry, Faculty of Technology, University of Banja Luka, on the spectrophotometer JENWAY 6300 and the Laboratory of instrumental analysis of the Faculty of Technology, University of Banja Luka on the instrument Lambda 25 UV/VIS spectrometer PERKIN ELMER [4]. As the adsorbents have been used synthetic zeolites:

- 5A zeolite, faujasite class ( $Ca_nNa_{12-2n}[(AlO_2)_{12}(SiO_2)_{12}] \cdot xH_2O$ ), product Sigma-Aldrich Co. LLC and
- AW-500 ( $M_x[(AlO_2)_x(SiO_2)_y] \cdot zH_2O$  ( $M=Na, K, Ca, Mg$ )), product UOP LLC.

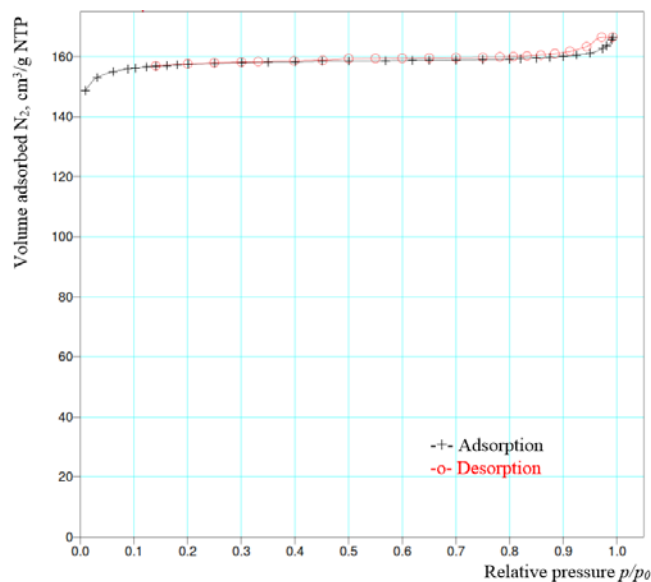
Texture characteristics of these zeolites (specific surface, average porous diameter, total microporous volume) were determined by the method of low temperature nitrogen adsorption (LTNA) with Micromeritics ASAP 2010 equipment at the Laboratory for physical chemistry and catalysis of the Novi Sad, Faculty of Technology. The samples were tableted and degassed at a temperature of 150<sup>0</sup>C before the test.

## RESULTS AND DISCUSSION

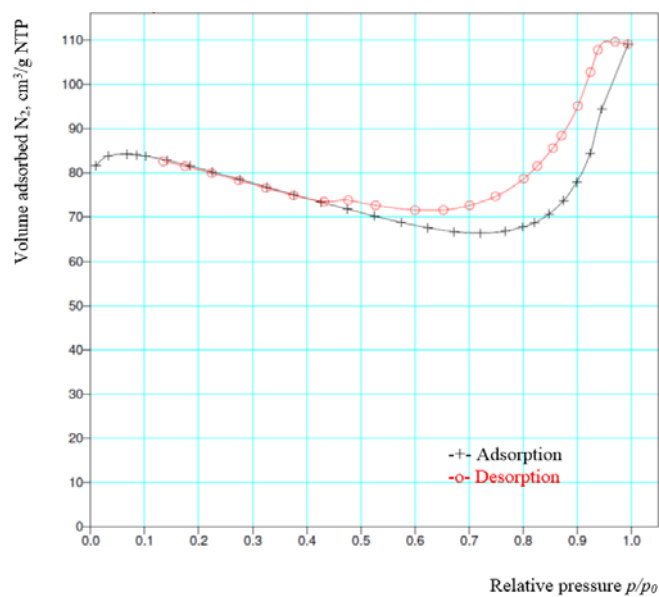
### *Adsorption from gaseous phase*

The method of low temperature nitrogen adsorption/desorption (LTNA) under high vacuum was performed on the zeolites 5A and AW-500, to determine significant

features of adsorbents. Figures 1 and 2 show the obtained adsorption isotherms for zeolites 5A and AW-500, which were used to determine the type of adsorption, adsorption capacity, specific surface and size and shape of pores.



**Figure 1.** Adsorption-desorption isotherm of nitrogen at 77,35 K on 5A zeolite



**Figure 2.** Adsorption-desorption isotherm of nitrogen at 77,35 K on AW-500 zeolite

The obtained adsorption-desorption isotherms of nitrogen, show the advantage in the adsorption characteristics of zeolite 5A compared to AW-500. Isotherms can be classified for zeolite 5A in type II, and the AW-500 in type IV adsorption isotherms according to IUPAC [5]. By analysis of the hysteresis loops may be concluded that the adsorbent 5A shows the type H4 (according to IUPAC classification hysteresis loops) that is characteristic of adsorbents having a pore size which resemble the narrow cracks. The zeolite AW-500 is represented by the pores of the type H3 consisting of particles in the form of a leaves or plates with porous structure [5]. The obtained information on the textural characteristics of zeolite 5A and AW-500 are represented in Table 1. Number of adsorbed molecules of nitrogen adsorbed per weight and surface unit of the adsorbent, and the maximum adsorption capacity of the adsorbent, are shown in Table 2.

**Table 1.** Textural characteristics of 5A and AW-500 zeolite

Parameter	Unit	ADSORBENT	
		5A	AW-500
BET specific surface	m <sup>2</sup> /g	524,3377	255,5874
Langmuir specific surface	m <sup>2</sup> /g	690,5992	342,8503
Total microporous volume of adsorption	cm <sup>3</sup> /g	0,0201	0,0766
Total microporous volume of desorption	cm <sup>3</sup> /g	0,0208	0,0726
Average porous diameter of adsorption	nm	6,2531	24,3233
Average porous diameter of desorption	nm	5,5826	14,9689

**Table 2.** Number of adsorbed molecules of nitrogen per surface unit and the maximum adsorption capacity of adsorbent

Adsorbent	BET specific surface	Number of adsorbed molecules on the plateau	Number of adsorbed molecules on the plateau	Maximum adsorption capacity of the adsorbent
	m <sup>2</sup> /g	molecules/g	molecules /m <sup>2</sup>	cm <sup>3</sup> /g
5A	524,3377	4,26·10 <sup>21</sup>	8,12·10 <sup>18</sup>	158,64
AW-500	255,5874	2,26·10 <sup>21</sup>	8,84·10 <sup>18</sup>	77,76

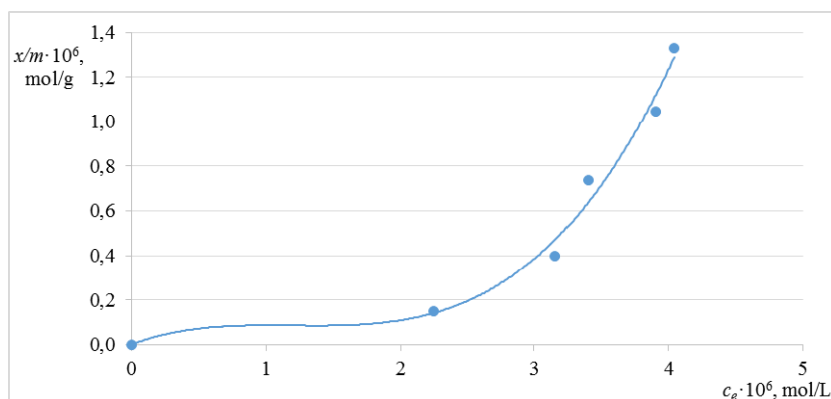
#### *Adsorption from liquid phase*

The adsorption of substances from one phase to the surface of the second phase is a specific thermodynamic process, in which after reaching the equilibrium adsorption the adsorption process was finished. In researching the adsorption process is always carried out at a constant temperature because adsorption isotherms define distribution of adsorbate at equilibrium. The diagrams showed amount of adsorbate adsorbed per mass unit of adsorbent,  $x/m$  at the equilibrium concentration of adsorbate in solution  $c_e$ . The results are shown in tables and diagrams.

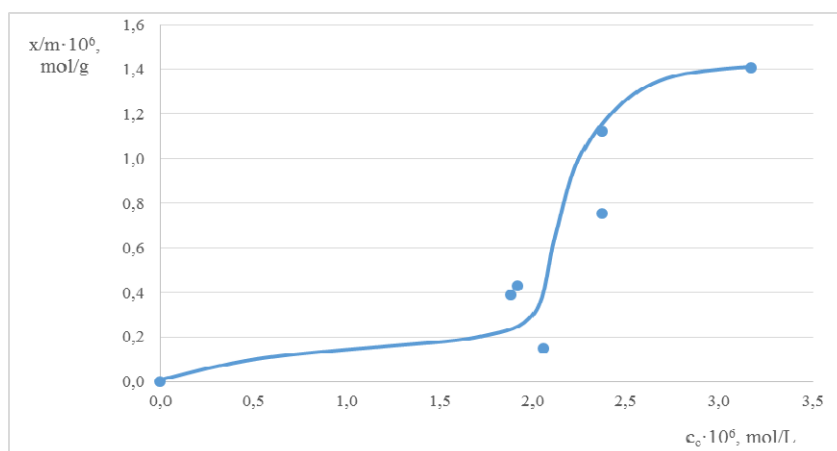
The research of adsorption from the liquid phase about dependence the adsorbed quantity of methylene blue in the function of the concentration of adsorbate

was given by Freundlich's adsorption isotherm. The research of adsorption from the liquid phase about dependence the adsorbed quantity of methylene blue in the function of the concentration of adsorbate was given by Freundlich's adsorption isotherm. Freundlich's constant, the height of adsorption plateau and total number of adsorbed molecules on the plateau were calculated from Freundlich's isotherm.

Adsorption of methylene blue at the synthetic zeolite 5A was performed at temperatures of 293 K and 303 K. The Figures 3 and 4 show the obtained experimental dependence of  $x/m$  in the function of the equilibrium concentration methylene blue on 5A or Freundlich adsorption isotherms.



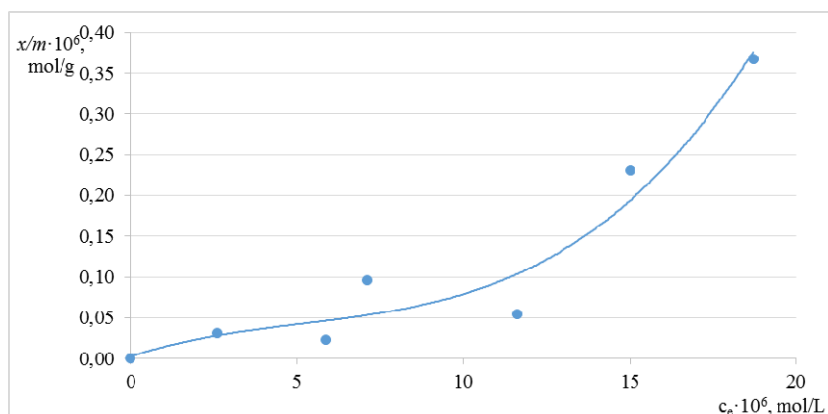
**Figure 3.** Freundlich adsorption isotherm, dependence  $x/m$  of the equilibrium concentration of the methylene blue on 5A zeolite,  $T=293K$



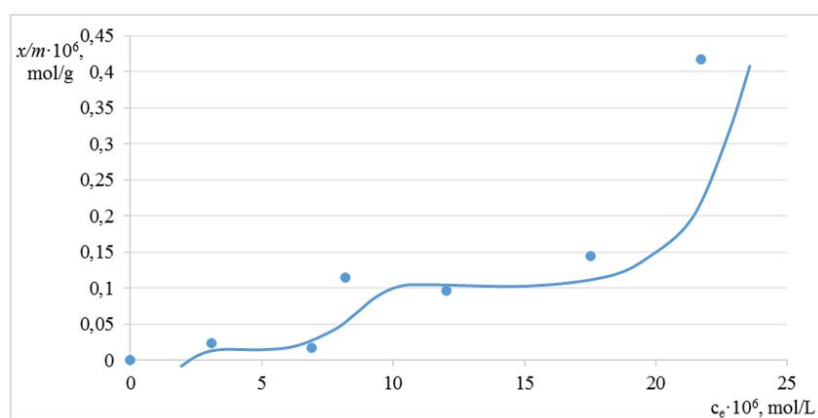
**Figure 4.** Freundlich adsorption isotherm, dependence  $x/m$  of the equilibrium concentration of the methylene blue on 5A zeolite,  $T=303K$

Adsorption of methylene blue at the synthetic zeolite AW-500 was performed at 295 K, but in two granulations, extruded and in the form of powder. Figures 5 and 6

show the obtained experimental dependence of  $x/m$  in the function of the equilibrium concentration methylene blue on AW-500, or Freundlich adsorption isotherms.



**Figure 5.** Freundlich adsorption isotherm, dependence  $x/m$  of the equilibrium concentration of the methylene blue on AW-500 zeolite (extruded),  $T=295K$



**Figure 6.** Freundlich adsorption isotherm, dependence  $x/m$  of the equilibrium concentration of the methylene blue on AW-500 zeolite (powder),  $T=295K$

Table 3 presents summary data on specific areas of adsorbents and adsorption parameters obtained on the basis of Freundlich's adsorption isotherm: Freundlich's constants  $n$  and  $K_F$ , the height of the plateau, the number of molecules adsorbed methylene blue, and the heat of adsorption on zeolite 5A and AW -500 (extruded and powder).

**Table 3.** Data of the specific areas of adsorbents and adsorption parameters obtained on the basis of Freundlich's adsorption isotherm; constants  $n$  and  $K_F$ , height of the plateau on the isotherms, number of molecules adsorbed methylene blue and the heat of adsorption on zeolites 5A and AW-500

Adsorbent	Specific surface, $m^2 \cdot g^{-1}$	Temp. K	Freundlich constant, $n$	Freundlich constant, $K_F$	Height of the plateau $x/m$ $mol \cdot g^{-1}$	Number of molecules on the plateau, $Nt/m^2$	$\Delta_{ads}H$ $Jmol^{-1}$
5A	524,34	293	0,268	$1,56 \cdot 10^{14}$	$1,00 \cdot 10^{-7}$	$6,00 \cdot 10^{17}$	-653,64
5A	524,34	303	0,397	$1,18 \cdot 10^8$	$1,80 \cdot 10^{-7}$	$8,50 \cdot 10^{17}$	-999,42
AW-500 (extrud.)	255,58	295	0,811	0,151	$5,00 \cdot 10^{-8}$	$1,34 \cdot 10^{18}$	-1989,00
AW-500 (powder)	255,58	295	0,699	1,126	$1,00 \cdot 10^{-7}$	$2,69 \cdot 10^{18}$	-1714,29

### CONCLUSION

The resulting adsorption-desorption isotherms of nitrogen at low temperature and high vacuum can be classified for zeolite 5A in type II, and for AW-500 in type IV. By the analysis of obtained hysteresis loops can be concluded that the adsorbent 5A shows type H4, while the AW-500 shows type H3 of pores.

Zeolite 5A has a 2 times stronger adsorption capacity under nitrogen from the zeolite AW-500.

It is assumed that the adsorption on researched zeolites molecule of methylene blue (dimensions  $0,74 \times 1,69 \times 0,38$  nm) has been adsorbed only on the external surface. This molecule can hardly pass through the holes with diameter about 0.5 nm in internal channels of adsorbents, where there are significant active centers for adsorption [6]. The calculated amount of adsorbed methylene blue colour on zeolite 5A at  $20^\circ C$  corresponds to the number of molecules of  $6,0 \cdot 10^{17}$ , and at  $30^\circ C$  to the number of  $8,5 \cdot 10^{17}$  molecules of methylene blue, what is in the case of such large numbers very approximate. The heights of the plateau obtained for the both temperatures are also approximately, that we can concluded that the change in temperature did not effect on the adsorption capacity of the zeolite.

Experimental data of adsorption of methylene blue from aqueous solution on the AW-500 and 5A zeolites, confirm that their adsorption characteristics and the nature of the active sites on the surface of these samples which are decisive for the adsorption very similar [7] [8].

The order of adsorbents according to decline of adsorption capacity, based on a review in Table 3, is:

$$AW-500 \text{ powder} > AW-500 \text{ extruded} > 5A.$$

To the adsorption of methylene blue from aqueous media, on zeolites AW-500 and 5A like adsorbents, it can be concluded that neither temperature change, nor a change of zeolites, as well as changes in granulation of zeolite, did not affect to the adsorption capacity. This confirm that the adsorption takes place only at the active centers on the external surface of the zeolites [9].

#### REFERENCES

1. T. Santhi, S. Manonmani, *Adsorption of methylene blue from aqueous sollution onto a waste aquacultural shell powders (prawn waste)*, Sustainable Environment Research 22(1), pp. 45-51, 2012.
2. C.H. Weng, Y.F. Pan, *Adsorption characteristics of methylene blue from aqueous solution by sludge ash*, Colloids and Surfaces A 274 154-162., 2006.
3. E.E. Kiš, G.A. Lomić, R.P. Marinković-Nedučin, G.C. Bošković, T.J. Vulić, *Ekperimentalna kataliza*, Univerzitet u Novom Sadu, Tehnološki fakultet, Novi Sad, Srbija, 2009.
4. S. Dobrnjac, *Površinske pojave na alumini i nekim alumosilikatnim mineralima*, Master's thesis, University of Banja Luka, Faculty of Technology, Banja Luka, Bosnia and Herzegovina, 2014.
5. G. Bošković, *Heterogena kataliza u teoriji i praksi*, Univerzitet u Novom Sadu, Tehnološki fakultet, Novi Sad, Srbija, 2007.
6. Z. Levi, J. Penavin, N.Čegar, D. Lazić, D. Bodroža, *Fizičko-hemijska identifikacija katjon modifikovanih zeolita tipa A*, *Glasnik hemičara, tehnologa i ekologa RS 2009*, br.1, str.1-10, Banja Luka, 2009.
7. B. Škundrić, S. Sladojević, J. Penavin, N. Čegar, D. Lazić; *Zeolites as Adsorbens for Methyl Violet from Water Solutions*, 35th International October Conference on Mining and Metalurgy 2003, Proceedings Bor Lake Serbia and Montenegro, 417-423, 2003.
8. G. Mourchid, I. Maghri, M. Elkouali, A. Kenz, M. Talbi, A. Amougay. *Removal of Cationic Dye Methylene Blue onto Moroccan Clay*, Global Journal of Science Frontier Research Chemistry, Vol.13, Issue 4, pp. 22-30, 2013.
9. D. Bodroža, S. Sladojević, J. Penavin-Škundrić, D. Lazić, Lj. Vasiljević, B. Škundrić; *Study of Beta Zeolite Physical Chemical Characteristics by Observing Adsorption of some Acid and Base Components from Aqueous Solutions*, XXIII International Conference Ecological Truth, Proceedings Kopaonik 2015, Serbia, 128-137, 2015.





## NOISE AT THE OPEN PIT MINE

Samir Nuric<sup>1\*</sup>, A. Nuric<sup>1</sup>, J. Zenunovic<sup>2</sup>

<sup>1</sup>University of Tuzla, Faculty of Mining Geology and Civil Engineering,  
Tuzla, BOSNIA AND HERZEGOVINA

<sup>2</sup>University of Tuzla, Faculty of Mining Geology and Civil Engineering, Tuzla,  
BOSNIA AND HERZEGOVINA

\**samir.nuric@untz.ba*

### ABSTRACT

Depending on the particular production process noise is emitted in the working area of the open pit, and their analysis can be noted their significant fluctuations. Based on the "in-situ" measured values are proposed methods and preventative measures to protect to avoid or reduce to a minimum adverse effect of noise on workers in the open pit mine. Based on the results of the measurements can be performed by a general conclusion that occasionally occurs exceeding the allowed level of noise, but the noise a short duration, so it leaves no adverse consequences. In places where the noise level exceeds the permitted intensity adequate protective equipment applied.

**Key words:** open pit mine, noise, production processes, workers, environment.

### INTRODUCTION

On open pit mines, working environment consists of contoured mining workspace, with climatic conditions and adverse impact factors, which are the result of execution of production processes during exploitation of mineral resources. The main characteristics of surface mining are: working on open space, which is directly exposed to the climatic elements, with the involvement of robust and powerful highly productive machinery and other equipment with a relatively small crew (drilling, excavators, crushers, conveyor systems, stackers, etc.). With increasing depth of open pit mines, depending on the applied technology and the system of exploitation, designed the structure and configuration of the open pit, the geographical position of deposits and other conditions, there are serious problems with air pollution in the area of the crater mine and its immediate environment. The process of modernization of production in surface mining has led to the improvement of working conditions through reducing physical exertion, better working comfort, increase safety and general humanization of work. This paper explores the impact of production processes on the working conditions at open pit mines on the example of the open pit mine "Potočari" Đurđevik. Data were collected by measuring the level of noise on characteristic places in the surface mine.

The data was used to analyse the impact of manufacturing processes on pollution pit mine in terms of noise.

### **THE PURPOSE AND OBJECTIVES OF RESEARCH**

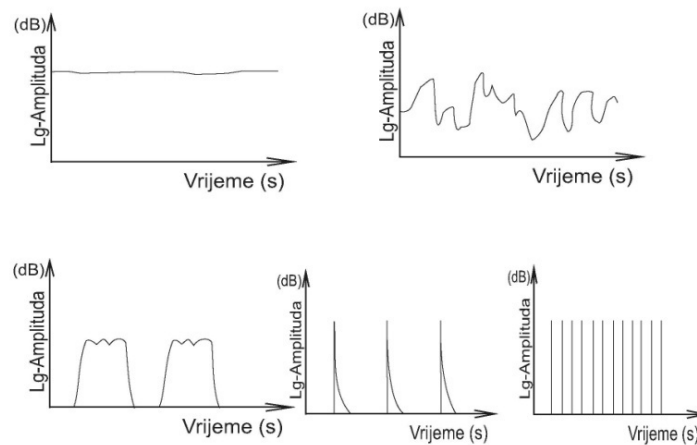
In accordance with the subject matter of research main purpose and objectives of the research work are as follows: identifying the sources of noise and air pollution of the open pit; determination of the emission and noise levels per manufacturing processes in the open pit; a systematic and methodological approach to the issue of the impact of production processes on the working conditions in the open pit in terms of noise; plotting iso-phones or maps of pollution of the working environment of the open pit by noise; on the basis of the measured values make recommendations for reducing the impact of production processes on the working conditions in terms of noise.

### **RESEARCH METHODOLOGY**

The research methodology can be represented by the following items: analysis of the available literature and references related to the subject matter; analysis and synthesis of previous research in the subject area; In-situ measurements of working conditions in the open pit (noise, as well as temperature and air humidity at the site); analysis of the impact of production processes on the working conditions in the open pit, particularly in terms of noise.

### **GENERAL TERMS OF NOISE**

Noise, in the physiological sense, is any unwanted sound in the environment in which people live and work, with results in an unpleasant feeling or may adversely affect health. Reactions to noise are individual and depend on the subjective parameters of noise. Depending on the level and frequency of noise, and the period of exposure to noise, they can be from mild and transient to lasting damage. The body which vibrates produces movement of particles in a flexible environment. Sound is a form of energy of mechanical movement of particles and is usually measured in units associated with energy. Depending on the source of noise, distinguish the following types of noise: according to the timeline, according to the frequency spectrum, according to the participation of the noise source, according to source of impulse noise.



**Figure 1.** Types of noise according to the characteristics in the time domain; uniform, continuous variable, intermittent, isolated pulses, quasi impulse noise

Frequency represents the number of repeated cycles of sound waves per second. The frequency is inversely proportional to the wavelength of the sound. Sounds of low frequency have a longer wavelength, and high-frequency sounds short wavelength. The wave length is important, when taking into account sound propagation from the source to the recipient, and when taking into accounts the most appropriate technique of noise control. The level of low audible frequency ranged from about 20 to 150 Hz. Sounds low frequencies tend to be spread over long distances. Hearing system is most sensitive to the frequency of the middle-range of 1000-4000 Hz. Frequency analysis allows determining the character of noise and possible corrections, as well as the identification of frequency bands to be taken into account in the application of measures to reduce noise. Types of noise with different characteristics in the frequency domain are: broadband noise, narrowband noise and total noise. The duration of the noise is related to the time form its height. The simplest form is when the height is constant in time (eg. transformer humming). Noise differences depending on whether the height changes rhythmically or irregularly.

### THE NOISE OF TRUCKS ON THE OPEN PIT MINE "POTOČARI"

Sources of noise at the pit can be considered by the production processes, as follows: drilling, mining, loading and digging excavator and transport. In addition to machines, devices, equipment and resources by the basic processes, a significant source of noise in the pit mine the machines and devices that are used to extra production processes such as bulldozers and graders on the development and maintenance of roads, loaders, pumps and compressors, etc.

The primary noise by truck transport is aerodynamic and mechanical origin. In the internal combustion engine, due to the expansion of oil in the engine cylinders, produce aerodynamic noise. Mechanical noise occurs due to vibration of the engine and

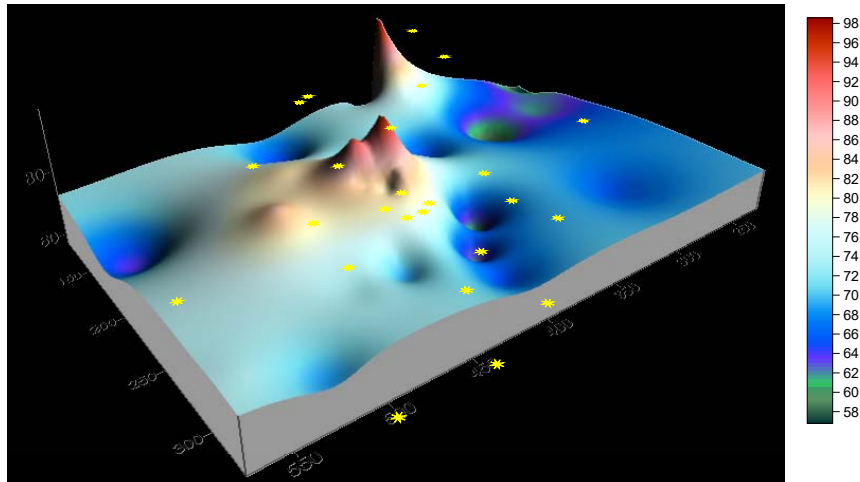
other parts of the truck caused the movement of the engine, ventilation, and other devices. Noise movement of trucks by the decline consists of factors lower intensity, but with the dominant noise levels of electric braking system. The noises of trucks are periodically changed, and the estimated impact of the adverse effects on employees.

**Table 1.** Measured noise of trucks per sections, with the GPS coordinates on the pit mine Potočari (part of a complete table)

Measured site Around part pit mine „Potočari“	Day	Night	Noise (dB)	Date	Time	Temperature (°C)	Density (%)	GSP Coordinate
1	/		051, 9	29-10	10:54	36, 3	32%	065-50-417 049-19-456 266m; 11m
2	/		050, 8	29-10	11:00	36, 4	32%	065-50-671 049-19-568 276m; 5m
3	/		038, 4	29-10	11:15	34, 5	31%	065-50-822 049-19-669 278m; 4m
4	/		034, 2	29-10	11:20	35, 6	30%	065-50-955 049-19-639 259m; 8m
5	/		034, 1	29-10	11:30	33, 4	30%	065-51-103 049-19-673 244m; 4m

#### NOISE COMPLEX EXCAVATOR-TRUCK ON THE OPEN PIT MINE "POTOČARI"

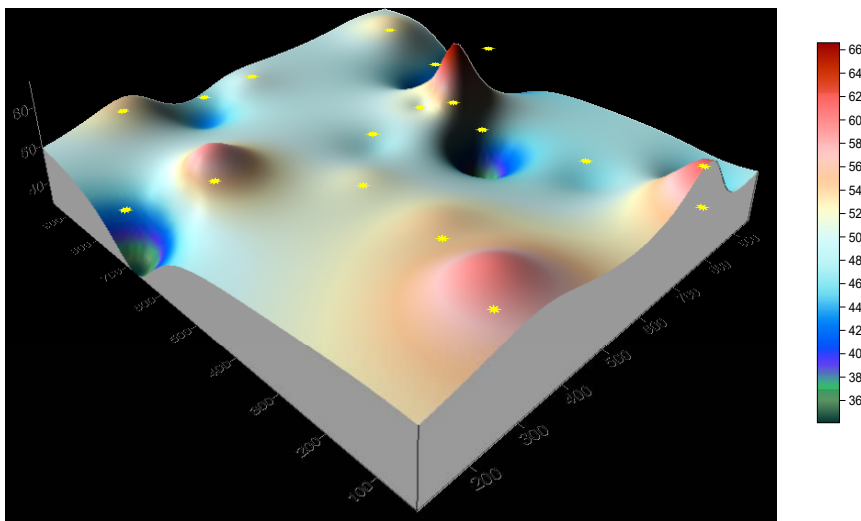
Production processes related to loading of material by complex excavator-truck emit significant levels of noise that spread in working and living environment. In order of full-scale analysis of the impact of noise of excavator system to ergonomic conditions of employees, adequate measurements of the noise level for the excavators EŠ 6/45, EŠ 10/70, RB 195 were made. Noise emission, of the excavators in various stages of production cycle, periodically changes. Basic characteristics of the noise that their influence impair optimal performance requirements of manufacturing processes, and adversely affects the health of employees are presented with the aim to analyze the influence of noise excavator working on the ergonomic conditions of employees.



**Figure 2.** Distribution of noise around excavator EŠ 6/45

### **NOISE EMISSION AROUND THE ACTIVE AREA OF THE OPEN PIT MINE "POTOČARI"**

Truck transport on open pit mines emits considerable noise which extends in the working and living environment. Since the noise decreases with increasing distance, in order to review the situation were carried out tests and measurements of noise levels truck transport in different locations (Figure 3). The purpose of these tests is to provide a basis for evaluation of the impact of truck noise in living and working environments.



**Figure 3.** Distributions of noise around active area of pit mine "Potočari"

## NOISE OF AUXILIARY WORKING MACHINES AT THE OPEN PIT

The exploitation of mineral resources in the open pit is based on coordinated production processes of basic and auxiliary working machines. Production processes auxiliary working machines in the open pit consist of: maintenance of transport communication-route; maintenance plateau workspace excavators; planning of landfill; drilling of the rock mass; drainage of water from the crater of the open pit, etc. Since the noise of production processes of auxiliary machinery in the open pit in various stages of the cycle changes periodically, it was evaluated impact of adverse effects on employees, reference, and equivalent level.

### EARTH EMBANKMENTS – BARRIERS

Deposits of mineral raw material in the open pit mines during the operation become deeper, and it is necessary to provide larger capacity of mining machinery to meet the technical and economic conditions. By increasing of number of mining machinery, the impact of noise is increasing on the ergonomic conditions of employees, working environment of the open pit and immediate environment. In order to reduce noise emissions of production processes at the open pit it is necessary to implement organizational measures attenuation of noise levels. Considering the specific working environment there is a possibility of making the berm - the protective embankment, which has significant absorption properties. The protective berm located at a distance 15 m from the direction of movement of the truck, and 10 m from the measuring point is presented on figure 4.

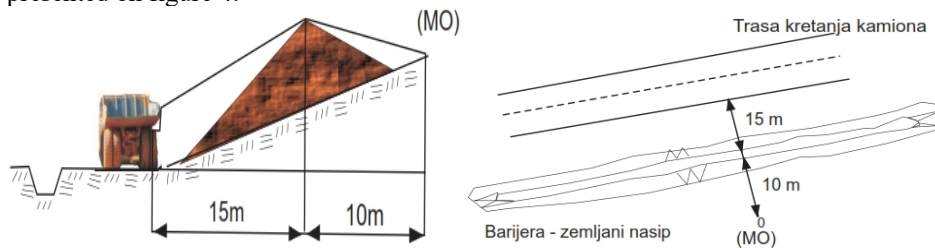


Figure 4. Schematic representation of developing protective berm of soil

### CONCLUSION

This paper discusses the impact of production processes on the working conditions at the open pit mine on the example of the pit mine "Potočari". Although working conditions evaluated reviewing a series of influential parameters such as temperature, humidity, air quality (content of gases, dust and the presence of smoke), brightness and vibration, the focus of paper was evaluating the presence and intensity of noise. In order to estimate impact of production processes on working conditions at the open pit mine, were carried out measurements of noise levels, temperature and humidity during 2013 and 2014. Digital multimeter - universal noise meter, temperature and humidity, brand PCE - EM886 used for measurement. Analysing the results of the

measurements it can be concluded that the measured noise levels in the vicinity of a fully loaded damper Belaz (capacity 136 t) along the horizontal route is 92.2 dB, 76.4 dB in a curve, on the incline 99.3 dB, down the route (empty damper in driving the decline) 66.5 dB. The measured level - the intensity of noise in the vicinity for excavator RB195 it ranges from 66.2 to 99.8 dB. The noise level in excavation for EŠ 6/45 it ranges from 66.6 to 83.7 dB. The intensity of the noise in the vicinity for the excavator the EŠ 10/70 ranges from 52.4 to 82.9 dB. The intensity of the noise level for the working bulldozer is in the interval from 58.8 to 99.7 dB. The measured intensity - the noise level for the loader in work is 75.2 to 102.0 dB. For separation unit open pit Potočari, depending on the distance of the measuring point from the noise source, recorded sound levels from 58.2 to 89.4 dB. In order to obtain a greater number of reliable data for the noise level in the mine, the measurement was made around of the active part of the open pit mine, with the recorded variation of 34.1 to 66.7 dB.

On the basis of measured data was presented the distribution of the noise using the software SURFER 8.0. Based to results of the measurements can be made a general conclusion that occasionally occurs exceeding the allowed level of noise, but the noise is short term, leaving no harmful effects in the vicinity of mobile machines no employees except the operator, that the noise could leave the consequences longer exposure. In places where the noise level exceeds the permitted intensity applied the appropriate protective equipment.

## REFERENCES

1. Drinčić G. D., Krstić V. S., Kecojević S. Z.: *Akustičko pojačanje u audio sistemima za dopunsko ozvučenje*, Beograd, 2008
2. Zakon o zaštiti od buke Federacije Bosne i Hercegovine, 2012
3. Ministarstvo životne sredine, rudarstva i prostornog planiranja Republike Srbije, *Uputstvo za merenje buke u životnoj sredini*, 2011
4. Brigić A.: *Analiza i uticaj buke na površinskim kopovima na kvalitet životne i radne sredine*, magistarski rad, RGGF, Tuzla, 2008
5. Simonović M., Kalić D., Pravica P.: *Buka-štetno djelovanje, mjerenje i zaštita*, Niš, 1982
6. RMU „Đurđevik“, PK „Potočari“, Tehnička dokumentacija
7. Engel J. R., Kosała K.: *Source of vibroacoustic hazards in open-pit mines of mineral raw Materials*, Archives of Acoustics 32, 2, 251–262, 2007
8. *Noise feasibility study for a proposed gravel pit*, Howe Gastmeier Chapnik Limited, Ontario Canada, 2014
9. *Environmental sound and vibration assessment (blasting)*, Goldcorp Canada Ltd., 2010
10. Burkhardt R., Rosenbluth P., Boan J.: *Mining in Ontario – A Deeper Look*, Ivey Foundation and Mountain Equipment Co-op., 2010
11. Lednická M., Kaláb Z.: *Vibration response of the waste rock dump in open pit mine caused by blasting operation*, Acta Montanistica Slovaca Vol. 20, No. 2, pp. 71-79, 2015
12. Stanci A. C., Tataru D., Stanci A.: *Attenuation of noise pollution produced by band conveyors from the mining unit of career rosia due to climatic conditions*, International Journal of Emerging Engineering Research and Technology, Vol. 3, Issue 1, pp. 45-50, 2015, ISSN 2349-4395 (Print) & ISSN 2349-4409 (Online)
13. *Mining and Health*, [www.hesperian.org](http://www.hesperian.org)





## EFFECT OF BLASTING ON THE ADJACENT BUILDING AND MINING STRUCTURES AT THE OPEN PIT KIJEVO

Suzana Lutovac\*, R. Tokalic, B. Gluscevic, N. Vidanovic, C. Beljic

University of Belgrade, Faculty of Mining and Geology, Belgrade, SERBIA

\*suzana.lutovac@rgf.bg.ac.rs

### ABSTRACT

This paper presents the results of measurements of seismic effects caused by blasting operations during exploitation of limestone at the open pit Kijevo near Belgrade. Protection measures during blasting are carried out by measuring the soil oscillation velocity and frequency.

A large number of countries have regulations governing the level of shocks caused by blasting operations. Such regulations have not yet been adopted in our country, so that in solving this issue, we use regulations and standards of other countries. In determining the effect of blasting on the adjacent building and mining structures of the open pit Kijevo, we used criterion of the Institute of Physics of the Earth of the Russian Academy of Sciences (IPE RAS), criterion of DIN 4150 and criterion according to Russian norms for mining and building structures.

**Key words:**blasting, seismic effect, oscillation velocity.

### GENERAL CHARACTERISTICS OF DEPOSITS

Wider area of Straževica deposits has a complex and diverse geological structure. *Volcanogenic and sedimentary formations of Upper Jurassic epoch*, which is presented with a variety of clastics, primarily sandstones, shales, cherts, silicified marl and limestone calcarenite type limestone and *sedimentary series of the Upper and Lower Cretaceous period* consisting of dacite and dotted interlayers, Neogene sediment and Quaternary alluvial formations [1].

**Geological structure of deposits** – Based on the results of geological research, it has been found that geological structure of Straževica deposits is consisted of humus cover, proluvial and alluvial sediments, shales and marl with layers of limestone and marl, marly clay, shales and marly limestone.

**Tectonics of deposits** – Limestone of Straževica deposits are lithological member of Mesozoic series of sediments, which is intensively harvested. Two main directions of propagation are clearly distinguished on the ground: longitudinal and transverse direction. The faults of NW-SE direction belong to the older tectonic activity, while transverse faults were formed by subsequent tectonic activity. There are three types of fracture systems in limestone massif. The first system is represented by tension



fractures that have NNW-SSE direction of propagation. The other two systems belong to the shear fractures in the direction of ENE-WSW.

**Physical and mechanical characteristics of deposits** – Average values of physical and mechanical parameters of limestone based on performed analyses:

Compressive strength in dry state	175,0 [MPa]
Compressive strength in water-saturated state	169,0 [MPa]
Compressive strength after freezing	162,0 [MPa]
Abrasion resistance by scraping	16,61 [cm <sup>3</sup> /50cm <sup>2</sup> ]
Bulk density without pores and cavities	2,67 [g/cm <sup>3</sup> ]
Bulk density with pores and cavities	2,71 [g/cm <sup>3</sup> ]
Porosity	0,33[%]
Water absorption	0,31[%]
Resistance to frost	Resistant
Resistance to the effect of Na <sub>2</sub> SO <sub>4</sub>	Resistant

### PROTECTION MEASURES DURING BLASTING

**Seismic effect of blasting** - When performing large-scale blasting or blasting in urban areas, where from a few kilograms to several thousand of kilograms of explosives can be activated at once, side effects of blasting may occur and may be manifested as air shock waves, seismic effects, blast induced fly rock and occurrence of harmful gases.

Seismic effects of blasting represent the elastic deformations of the rock mass caused by the dynamic action of an explosive charge. The resulting elastic deformations extend in the form of elastic waves radially from the blast site. According to the form of transmission of elastic deformation, seismic waves can be divided into two main groups: bulk and surface waves [2]. Among bulk elastic waves, the most famous are longitudinal and transverse waves, while among surface elastic waves, the most famous are Rayleigh and Love elastic waves. The action of explosion in the working environment creates all kinds of elastic waves at the same time, whereby the change of the distance changes their intensity. The intensity of seismic waves can be determined by measuring one of the basic dynamic parameters of the actuated environment as follows: oscillation velocity  $v$ , acceleration  $a$ , or displacement of soil  $x$ . A parameter, which is most frequently used for the evaluation of seismic intensity is oscillation velocity of the actuated soil  $v$ .

The maximum resulting soil oscillation velocity  $V_{max}$  [3] is obtained as the intensity of the vector components in directions of X, Y and Z-axis, using the formula:

$$v_{max} = \sqrt{v_v^2 + v_l^2 + v_t^2} \left[ \frac{1000}{g} \right],$$

where  $v_v$ ,  $v_l$  and  $v_t$  are vertical, longitudinal and transverse soil oscillation velocities.

The instruments used to register the soil oscillation velocity (seismograph Vibraloc-ABEM, Sweden) shall be set on a concrete base or buried in the ground in front of the building structure in the direction of incoming seismic wave.

## CRITERIA FOR EVALUATION OF THE SEISMIC EFFECTS OF BLASTING

In larger number of countries there are regulations governing the level of shocks caused by explosions with which buildings can be loaded, depending on their nature, status and dynamic resistance. These regulations have not yet been adopted in our country, so that in solving this issue we use regulations and standards of other countries [4], mostly Russian, German and American.

♦ **Criterion of the Institute of Physics of the Earth, Russian Academy of Sciences<sup>1</sup>** - Seismic scale of the Institute of Physics of the Earth, Russian Academy of Sciences, which is used for the assessment of blast induced shocks is shown in the Table 1.

**Table 1.** Seismic scale of the Institute of Physics of the Earth of the Russian Academy of Sciences for assessment of blast induced shocks

Oscillation Velocity v [mm/s]	Level of seismic intensity	DESCRIPTION OF ACTIONS
To 2.0	I	Action is revealed only by instruments
2.0 – 4.0	II	Action is felt only in some cases when there is a complete silence
4.0 – 8.0	III	Action is felt by very few people or only those who are expecting it
8.0 – 15.0	IV	Action is felt by many people, the clink of the windowpane is heard
15.0 – 30.0	V	Plaster fall, damage on buildings in poor condition
15.0 – 30.0	V	Plaster fall, damage on buildings in poor condition
30.0 – 60.0	VI	Air cracks in plaster, damage, damage to buildings that already have developed deformations
60.0 – 120.0	VII	Damage to buildings in good condition, cracks in plaster, parts of the plaster fall down, air cracks in walls, cracks in tile stoves, chimney wrecking
120.0 – 40.0	VIII	Considerable deformations on buildings, cracks in bearing structure and walls, bigger cracks in partition walls, wrecking of factory chimneys, fall of the ceiling
240.0 – 480.0	IX	Wrecking of buildings, bigger cracks in walls, exfoliation of walls, collapse of some parts of the walls
Bigger than 480.0	X - XII	Bigger destruction, collapse of complete structures etc.

Permissible oscillation velocities in building structures (residential, industrial, etc.) depend on the type of structure, character and its purpose.

♦ **Criterion according to DIN – Effect on building structures** – This standard contains information on the determination and evaluation of vibrations on building structures. This standard defines the approximate values, whose compliance cannot cause damages in terms of reducing the usability of the building structure.

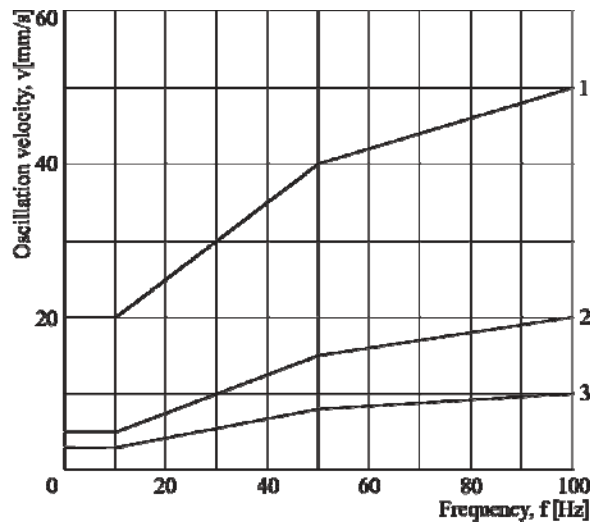
Assessment of total vibrations on structures is carried out from a numerous measurements of oscillation velocity on the foundation and ceiling structures. For this assessment, the maximum value is taken for three individual components of oscillation

<sup>1</sup> Федеральное государственное бюджетное учреждение науки Институт физики Земли им. О.Ю. Шмидта Российской академии наук (ИФЗ РАН)

velocity. Approximate values for oscillation velocity  $v$  and oscillation frequency are given in Table 2 and Figure 1.

**Table 2.** Approximate values for oscillation velocity  $v$  and oscillation frequency according to DIN

	Type of the structure	Approximate values of vibration velocity, $v$ [mm/s]			
		Foundation			Top floor ceilings
		Frequency, Hz			All frequencies
		< 10	10-50	50-100	
1	Structures used for craftsmanship, industrial and similar structural structures	20	20 – 40	40 – 50	40
2	Dwelling buildings and structures similar in construction or function.	5	5 – 15	15 – 20	15
3	Structures that because of their particular sensitivity to vibrations do not fall into groups 1 and 2 and are essential for conservation (for inst. as cultural-historical monuments)	3	3 – 8	8 – 10	8



**Figure 1.** Graphic view of Standard DIN 4150; (1, 2 and 3 - types of structures)

◆ **Criteria according to Russian scale for mine facilities** - The level of rock mass deformation plays an important role in the protection of mine facilities constructed in a rock massif such as shafts, drifts, tunnels, rise headings, dip headings, chambers, stopes, sublevel posts, hydro-engineering tunnels, bench slopes, etc. Deformation characteristics of a rock massif have an essential impact while determining the threshold

of deformations for facilities constructed in the rock massif. On the basis of experimental measurements, there have been established oscillation velocities of the rock massif in varied mining-geological and mining-engineering conditions whose values (Russian standards) are presented in Table 3.

**Table 3.** Rock massif oscillation velocities in various mining and geological and mining and technical conditions

Description of occurrences in rock massif induced by seismic wave	Oscillation velocity, cm/s
There are no damages	< 20
The occurrence of insignificant development of fissures induced by previous blasting; locally, falling out of single pieces along previously weakened surfaces.	20 – 50
Intensive development of existing fissures followed by minor caving of rock pieces with the dimensions to 0.2x0.2x0.2 m; the occurrence of cracks in tectonically weaker material filled fissures; the caving of bench slopes along tectonic deformations.	50 – 100
The development of tectonic fissures and the caving of rock pieces with the dimensions 0.5x0.5x0.5 m.	100 – 150
Caving from sides and roof of underground chambers along tectonic fissures, the formation of new fissures in undamaged part of the rock mass, collapse of safety pillars and benches.	150 – 300
Complete damage of sides and roof of chambers followed by large blocks with dimensions of 1x1x1 and filling up to the half of constructed surface; caving of hard rock slopes	300 – 400
Complete demolition of rock mass, the caving of large blocks bigger than 1x1x1 m and covering up more than a half of the chamber.	> 400

#### DATA ON PERFORMED BLASTINGS

There were two blasting operations at the open pit Kijevo during limestone exploitation at E-130 [1]. Open pit facilities are measuring points on which measuring instruments MM-1 to MM-9 were placed, while MM-10 and MM-11 are residential buildings. Boreholes were arranged in a single row. The distance between boreholes was 2.0-2.2m. The distance between borehole and open-pit bench was 1.5-2.0m. The explosive Amonex-1 labeled 60/1000 was used for destruction of the rock mass. Review of blasting parameters i.e. number of boreholes  $N_b$ , total quantity of explosive  $Q_{uk}$ , quantity of explosive per deceleration interval  $Q_i$ , total depth of boreholes  $L_{uk}$ , stemming length  $L_c$  and inter-deck stemming length  $L_{m\check{c}}$  are given in Table 4.

**Table 4.** Review of blasting parameters at the open pit Kijevo

Blasting	$N_b$	$Q_{uk}$ [kg]	$Q_i$ [kg]	$L_{uk}$ [m]	$L_c$ [m]	$L_{m\check{c}}$ [m]
I	8	120,0	15,0	64,0	2,2	0,4
II	9	125,0	14,0	72,0	2,5	0,4

The values of the distance from blasting point to observation point  $r$ , total quantities of explosive  $Q_{uk}$ , registered values of soil oscillation velocities by components  $v_v, v_v, v_l$ , resulting oscillation velocities  $v_{rez}$ , actual oscillation velocities  $v_{st}$ , and frequencies by components  $f_v, f_v, f_l$ , for blasting operations I – II, for a total of eleven measuring points MM are given in the Table 5.

**Table 5.** Review of the results of measurements

Bl	MM	$r$ [m]	$Q_{uk}$ [kg]	$v_v$ [mm/s]	$v_t$ [mm/s]	$v_l$ [mm/s]	$v_{rez}$ [mm/s]	$v_{st}$ [mm/s]	$f_v$ [Hz]	$f_t$ [Hz]	$f_l$ [Hz]
I	MM-1	106,3	120,0	-	-	-	-	-	-	-	-
I	MM-2	99,7	120,0	4,537	5,726	2,095	<b>7,600</b>	<b>6,05</b>	48,5	32,7	36,3
I	MM-3	97,9	120,0	3,021	2,942	2,619	<b>4,964</b>	<b>4,12</b>	42,4	26,1	38,1
I	MM-4	100,3	120,0	5,103	4,230	3,985	<b>7,734</b>	<b>6,05</b>	47,5	45,8	35,7
I	MM-5	97,6	120,0	4,212	5,846	5,880	<b>9,300</b>	<b>8,28</b>	47,2	42,2	50,7
I	MM-6	104,4	120,0	3,410	6,545	3,061	<b>7,989</b>	<b>6,92</b>	42,5	36,1	37,7
I	MM-7	139,4	120,0	13,62	10,61	7,654	<b>18,884</b>	<b>16,55</b>	27,0	27,8	29,0
I	MM-8	128,9	120,0	3,528	3,512	3,026	<b>5,826</b>	<b>3,91</b>	37,9	36,2	24,1
I	MM-9	122,6	120,0	4,228	3,690	1,834	<b>5,904</b>	<b>4,88</b>	34,8	34,4	27,5
I	MM-10	132,9	120,0	4,635	2,262	2,160	<b>5,591</b>	<b>4,91</b>	23,6	13,2	13,8
I	MM-11	154,0	120,0	2,171	2,604	3,184	<b>4,651</b>	<b>3,23</b>	21,8	23,2	23,8
II	MM-1	124,3	125,0	1,873	3,699	3,080	<b>5,165</b>	<b>4,53</b>	66,8	36,0	62,0
II	MM-2	123,0	125,0	1,850	2,731	0,758	<b>3,385</b>	<b>2,96</b>	46,8	37,1	80,3
II	MM-3	123,8	125,0	1,477	1,703	1,276	<b>2,590</b>	<b>2,06</b>	29,2	23,3	57,5
II	MM-4	124,5	125,0	2,041	2,534	3,506	<b>4,783</b>	<b>3,89</b>	39,5	31,7	45,7
II	MM-5	118,3	125,0	1,853	2,338	3,006	<b>4,235</b>	<b>3,21</b>	40,8	20,9	74,0
II	MM-6	120,3	125,0	2,114	4,017	2,748	<b>5,306</b>	<b>4,03</b>	65,8	29,4	27,0
II	MM-7	164,9	125,0	9,255	6,136	4,048	<b>11,819</b>	<b>9,46</b>	27,8	27,3	29,6
II	MM-8	154,7	125,0	1,651	1,767	1,861	<b>3,051</b>	<b>2,20</b>	26,9	16,1	20,4
II	MM-9	144,3	125,0	3,719	2,587	1,790	<b>4,871</b>	<b>4,00</b>	33,0	25,5	23,4
II	MM-10	209,3	125,0	4,794	2,883	1,327	<b>5,749</b>	<b>5,40</b>	22,3	16,4	21,7
II	MM-11	216,3	125,0	3,618	2,450	1,996	<b>4,804</b>	<b>3,77</b>	21,0	41,8	27,0

Note: Record was not valid at MM-1

## ASSESSMENT OF MEASUREMENT RESULTS

The assessment of intensity of shocks incurred by blasting operations and their influence on building and mining facilities was performed based on the following criteria:

*Criterion according to the scale of the Institute of Physics of the Earth, Russian Academy of Sciences (III class structures are taken in accordance with the Table 1)*

- A – Satisfies, within the limits of permitted oscillation velocities,
- B – Does not satisfy, above the values of permitted oscillation velocity.

*Criterion according to DIN (II class structures are taken in accordance with the Table 2)*

- C – Satisfies, within the limits of permitted oscillation velocities,
- D – Does not satisfy, above the values of permitted oscillation velocity.

**Criterion according to Russian norms (I class structures are taken in accordance with the Table 3)**

- E – Satisfies, within the limits of permitted oscillation velocities,  
 F – Does not satisfy, above the values of permitted oscillation velocity.

Review of measurement results with the assessment of results of blasting performed at the open pit Kijevo is shown in the Table 6.

**Table 6.** Review of measurement results including the assessment of the results of blasting

Bl	MM	r [m]	Q <sub>uk</sub> [kg]	Q <sub>i</sub> [kg]	v <sub>rez</sub> [mm/s]	f <sub>v</sub> [Hz]	f <sub>i</sub> [Hz]	f <sub>l</sub> [Hz]	By IPE RAS	By DIN	Russian stan.
I	MM-1	106,3	120,0	15,0	-	-	-	-	-	-	-
I	MM-2	99,7	120,0	15,0	<b>7,600</b>	48,5	32,7	36,3	-	-	<b>E</b>
I	MM-3	97,9	120,0	15,0	<b>4,964</b>	42,4	26,1	38,1	-	-	<b>E</b>
I	MM-4	100,3	120,0	15,0	<b>7,734</b>	47,5	45,8	35,7	-	-	<b>E</b>
I	MM-5	97,6	120,0	15,0	<b>9,300</b>	47,2	42,2	50,7	-	-	<b>E</b>
I	MM-6	104,4	120,0	15,0	<b>7,989</b>	42,5	36,1	37,7	-	-	<b>E</b>
I	MM-7	139,4	120,0	15,0	<b>18,884</b>	27,0	27,8	29,0	-	-	<b>E</b>
I	MM-8	128,9	120,0	15,0	<b>5,826</b>	37,9	36,2	24,1	-	-	<b>E</b>
I	MM-9	122,6	120,0	15,0	<b>5,904</b>	34,8	34,4	27,5	-	-	<b>E</b>
I	MM-10	132,9	120,0	15,0	<b>5,591</b>	23,6	13,2	13,8	<b>A</b>	<b>C</b>	-
I	MM-11	154,0	120,0	15,0	<b>4,651</b>	21,8	23,2	23,8	<b>A</b>	<b>C</b>	-
II	MM-1	124,3	125,0	14,0	<b>5,165</b>	66,8	36,0	62,0	-	-	<b>E</b>
II	MM-2	123,0	125,0	14,0	<b>3,385</b>	46,8	37,1	80,3	-	-	<b>E</b>
II	MM-3	123,8	125,0	14,0	<b>2,590</b>	29,2	23,3	57,5	-	-	<b>E</b>
II	MM-4	124,5	125,0	14,0	<b>4,783</b>	39,5	31,7	45,7	-	-	<b>E</b>
II	MM-5	118,3	125,0	14,0	<b>4,235</b>	40,8	20,9	74,0	-	-	<b>E</b>
II	MM-6	120,3	125,0	14,0	<b>5,306</b>	65,8	29,4	27,0	-	-	<b>E</b>
II	MM-7	164,9	125,0	14,0	<b>11,819</b>	27,8	27,3	29,6	-	-	<b>E</b>
II	MM-8	154,7	125,0	14,0	<b>3,051</b>	26,9	16,1	20,4	-	-	<b>E</b>
II	MM-9	144,3	125,0	14,0	<b>4,871</b>	33,0	25,5	23,4	-	-	<b>E</b>
II	MM-10	209,3	125,0	14,0	<b>5,749</b>	22,3	16,4	21,7	<b>A</b>	<b>C</b>	-
II	MM-11	216,3	125,0	14,0	<b>4,804</b>	21,0	41,8	27,0	<b>A</b>	<b>C</b>	-

**CONCLUSION**

This paper presented the results of measurements of seismic impacts caused by blasting during exploitation of limestone at the open pit Kijevo near Belgrade. Two blasts were performed, whereby 21 result of soil oscillation velocity was instrumentally recorded at 11 measuring points. Based on the results of measurements of soil oscillation velocities we may provide the evaluation of seismic effects of blasting operations.

The registered values of soil oscillation velocity on the approach to open pit (MM-1 to MM-9), regarding the impact to the elements of pit are in the domain of acceptable values (Table 6), so they have no impact on pit structures.

The registered values of soil oscillation velocity in the vicinity of the open pit (MM-10 to MM-11), regarding the impact to the elements of pit are in the domain of acceptable values (Table 6), so they have no impact on building structures.

#### ***Acknowledgement***

*This paper has resulted from the Project No. 33025 and 33029 financed by the Ministry of Education of the Republic of Serbia realized by the Faculty of Mining and Geology in Belgrade.*

#### **REFERENCES**

1. Trajković, S., Lutovac, S., Ravilić M., Bajić S., Gaćina R., Paleka V., Ilić B.: *Studija seizmičkih uticaja na životnu sredinu, okolne građevinske i rudarske objekte usled miniranja na PK "Kijevo" – Beograd (Study of seismic impacts on the environment, adjacent building and mining facilities due to blasting operations at the open pit Kijevo– Belgrade)*, RGF Beograd, 2014., str.1-36.
2. Trajković, S., Slimak, Š., Lutovac, S.,: *Tehnika miniranja i potresi (Technique of blasting and shock waves)*, RGF Beograd, 2005., str. 169-172.
3. Savić, M.: *Miniranje na površinskim kopovima (Blasting at the Open Pits)*, Monografija, RTB Bor Institut za bakar Bor, Indok centar, Bor, 2000., str. 305-311.
4. Trajković, S., Lutovac,: *Zaštita od miniranja (Protection against the effects of blasting operations)*, RGF Beograd, 2014., str. 145-156.



## WASTE WATER FROM PRODUCTION OF GLASS

Violeta Cibulic\*, M. Trifunovic, N. Staletovic, V. Presburger Ulnikovic,  
S. Polavder, S. Mrazovac Kurilic

University "Union-Nikola Tesla" Faculty of Ecology and Environmental Protection,  
Belgrade, SERBIA

\*[vcibulic@gmail.com](mailto:vcibulic@gmail.com)

### ABSTRACT

The paper presents industrial waste water of Serbian glass factory, their quantity, quality and way of treatment. The technological process of glass production is described with special reference of wet production processes which occur in industrial waste water.

Industrial waste water in glass factory generally occur in different cooling devices used in the production process, from washing the finished product, in the preparation and use of suspensions with different abrasive used in the chemical and mechanical cutting, grinding and polishing of glass products, and of laundering drive and maintenance of working premises. The main characteristics of the waste water is high content of suspended and sediment matter, the high content of mineral oils, which are very oily water and the presence of lead. A central plant is described for pre-treatment of industrial waste water of glass factories which includes primary and secondary treatment. Mechanical treatment - sedimentation and physicochemical treatment - flocculation and coagulation are represented. Waste water is technological procedure purified to a level free to engage in city sewage. Even mineral oils are reduced to  $18\text{mg} / \text{dm}^3$ , which is a treatment effect of 82%.

**Key words:** Technological waste water, purification effect, oily water.

### INTRODUCTION

Serbian glass factory – SGF is producing glass for catering and consumer . The range of products is large, catering to the consumer by machines are made cups, mugs, plates, cups, etc. Then, bottles and glass packaging for food, pharmaceutical, chemical, cosmetics and so on. There's also a handmade high-quality products, such as crystal, iberfang and vacuum pads. There is a plant for the production of glass products for the defense industry and boro-silicate glass G-20<sup>th</sup>. This shop is the quarry "Plan" on the mountain Baba, near Paracin, which supplies the plant raw materials limestone and dolomite. The SGF used a large amount of process water for the process of grinding and polishing glass. Annual water consumption for technological process is close million and a half  $\text{m}^3$ , which tap water from their own wells or directly from the river water intake. [1,2]



## **GENERAL CONSIDERATIONS**

The glass factory is supplied with water for technological process - technological water from the municipal water supply, from wells, as well as from our own river water intake. Annual consumption is 1.314. 000m<sup>3</sup>, from the public network from 600 to 700m<sup>3</sup>/h and from its own resources 3,000m<sup>3</sup> for 24 hours.

Industrial waste water of SGF are mainly water of cooling compressor, suppressor, dryers, vacuum pumps, feeders, molds, accessories and a variety of other devices in the finishing stages of glass production. For more efficient cooling of the various additives are added in the form of oil, so that the oily waste water. There are also waste water from the washing operation and maintenance of working premises.[3,4]

Waste water from the grinding and polishing glass burdened by a high content of inorganic mainly sedimentary materials. These waste water is drained directly to the device for primary treatment, settle to remove all solids that formed during the process of grinding, engraving and polishing glass. After which they go to the central plant for waste water treatment plant. Waste water treated together with other waste water from the production of the washing operation and maintenance of premises, sanitary waste water goes directly into the city sewage system, there is a total of 15 waste water glass factory in the city sewage system in the whole factory.

### **Technology of glass production**

Glass is an amorphous inorganic material which after melting and cooling the mineral melt gets brittle mechanical properties of solid bodies. Depending on the basic components that make up the construction of the glass are different: silicate (SiO<sub>2</sub>), aluminosilicate (Al<sub>2</sub>O<sub>3</sub>), borosilicate (B<sub>2</sub>O<sub>3</sub>) and other glasses. The best application have silicate, aluminosilicate, borosilicate glass and boralumosilicate. The characteristics of glass next to the composition affected by the process of obtaining, processing, processing and finishing. Glass can be conditionally divided into two major groups:

- in construction, packaging and
- technical glass (optical, protective, high temperature, etc.).

The principal raw material for glass usually are: quartz sand, soda or sodium sulphate and limestone. The mixture is always added and glass waste (cullet). Cullet makes a large part (20-30%) and the role is to facilitate the process of obtaining a glass melting and to obtain a uniform product. The other raw materials are coloring agents, fining, blurring and bleaching. [2, 3,4]. A method of obtaining glass comprises two phases:

- Melting of fine, dry and mixed materials - glass stone with the addition of cullet at temperatures of 1200 - 1500°C so that the mixture becomes thick and the first movable and then losing viscosity, liquefies which enables its release of gases caused by chemical reactions. Melting ends at temperatures around 1450°C, and then get the slurry mass at this temperature;

- Cooling to a temperature of 900 - 1200°C where again increasing the viscosity of the glass mass, enables its further processing. The raw materials are melted in two types of furnaces: furnaces with pots and in cupped furnaces. Terms of melting and cooling affect the quality of the glass. If the cooling slowly and gradually glass product is elastic, slightly transparent. If the cooling fast glass is fragile, not resistant to breakage and changes in temperature, because then the first harden surface layers and inside there is the appearance of internal stresses. [2]

There are several basic methods of glass processing which molten mass obtained finished products or semi-finished products:

- DRAW This is the basic process for obtaining glass. It consists in the fact that the glass mass pulls immersion in molten glass mass plates or rings and their drawing. This extraction takes place between sets of rollers so that it can control the width and thickness of the glass ribbon while the glass cools to time.
- ROLLING is procedure for obtaining a flat glass, where the glass mass flows into the horizontal tables, and then it passes through the iron roller under whose pressure the glass is formed into panels of different thicknesses. If you use tables with embossed surfaces or used embossed rollers can get rough, ridged, etc. glass.
- BLOW MOLDING is the oldest procedure of glass processing. Blowing can be mouth or mechanized. The first is now used to create unique, craft and art objects and the other for all the hollow objects made of glass (bottles, light bulbs, etc.).

#### **Plant for treatment of waste water**

All technological waste water are collected together with the atmospheric water refers to an open concrete pool volume 3600m<sup>3</sup>. From this pool of waste water through the flow meter goes to the unit for treatment. Characteristics of waste water for SGF are shown in Table 1. In the case of higher rainfall enabled the dressing with the "apron" of excess storm water runoff, and retention- aggregation surface layer of oily water. [5,6,7] Capacity unit is 180m<sup>3</sup>/h and currently at the plant comes 120m<sup>3</sup>/h. It consists of a primary sedimentation tanks, lamellar separator, secondary sedimentation tanks, strip stripper oil. The task of the plant is the primary treatment, i.e. bringing the quality of the waste water to the level of freely engaging in the city sewer. Purification consists in the separation of mechanical impurities, sedimentation of suspended matter and sediment in the primary precipitator. This water go on chemical treatment of coagulation and flocculation. Automatic dosed as a coagulant and a polyelectrolyte flocculant, water is initially stirred vigorously and then more slowly to the resulting floc would not blown up in order to precipitate the lamellar sedimentation. At the same time, the automatic belt remover collecting grease and oil from the water surface. The collected oil is stored in the receiving metal containers to supply refineries, and purified water, after mixing with hot water, engages in city sewer where along the city plant for waste water treatment. The amount of waste water together with sewage water that discharges into the municipal sewage system is 2880m<sup>3</sup>/day.

## QUALITY OF TECHNOLOGICAL WASTE WATER

Testing the quality of waste water in the plant is done 4 times a year by an accredited laboratory for this kind of glorified. Water samples were taken before and after the purification unit, and test results are shown in Table 1. The water that reaches the plant is blurred with a lot of suspended solids, 81 mg/dm<sup>3</sup>. The reaction was slightly alkaline, the pH was 7,98 and the specific conductivity 632μS/cm, indicating a significant presence of mineral substances in the waste void.[8]

Oxygen content is significant, 10mg/dm<sup>3</sup>, which indicates that the content of substances that are oxidized by oxygen small, i.e. The content of organic matter is small, pollution in this waste void of visas in mineral form. Chemical Oxygen Demand-COD as a measure of organic matter is about 135mgO<sub>2</sub>/dm<sup>3</sup>, while the consumption of hydrogen peroxide only about 24mg/dm<sup>3</sup>, which indicates the presence of substances that shadows can oxidize permanganate already stronger oxidant kaliumbihromatom. These are probably different oils used to prepare the slurry, cutting and polishing glass.

Microbiological degradable is only about 15% of organic matter, BOD5 is 19,25mgO<sub>2</sub>/dm<sup>3</sup> which indicates the presence of hard - biodegradable materials, as confirmed by the large difference value of chemical oxygen demand and hydrogen peroxide. It is high in mineral oil, even 86mg/dm<sup>3</sup> as a result of its use in the production of grinding and polishing.

The water of this quality, after mechanical and physicochemical treatment significantly improves their quality and all tested parameters are at the free discharge into the city sewage system except for mineral oil, which is of 86mg /dm<sup>3</sup> reduce the 17,8mg /dm<sup>3</sup>, which is still quite a high concentration but the final purification is yet to come on the main plant, where should this concentration further decreases. The task for waste water at the factory - primary treatment, ie. bringing quality waste water for SGFon level for free to engage in city sewers. The required degree of purification is calculated according to the formula:

$$PSP\% = [(C_w - C_{ac})/C_w] \cdot 100\%$$

$C_w$  - concentration industrial waste water [mg/l]

$C_{ac}$  - allowable concentration [mg/l]

**Table 1.** Quality of waste water before and after pre-treatment plant at the Factory

The tested parameters Waste water	Waste water	
	Before	after
The temperature of the water / air (° C)	24,8/28,5	19,7/28,3
Appearance	Suspended matter	conferva
Turbidity (descriptive)	cloudy	clear
Turbidity (NTU)	112,0	28,0
The smell noticed	without	without
Color noticed	without	without
Specific conductivity (µS/cm)	632	433
Total dissolved solids (mg/dm <sup>3</sup> )	316,0	216,5
Dissolved oxygen (mg O <sub>2</sub> /L)	10,0	10,5
Oxygen saturation (%)	120,77	114,63
pH	7,98	8,30
Chemical oxygen demand (mg O <sub>2</sub> /L)	134,9	< 30,0
Demand KMnO <sub>4</sub> (mg /L)	28,4	8,2
Biological oxygen demand, BOD 5 (mg O <sub>2</sub> /L)	19,25	< 3 ( 1,8 )
Dry residue (mg/L)	498	402
Suspended solids (mg/L)	81,4	29,0
Sedimentary matter (ml/L)	< 0,1	< 0,1
Ammonium ion (mg N/L)	0,49	0,16
Nitrites (mg N/L)	0,098	0,016
Nitrate (mg N/L)	1,22	1,41
Sulphates (mg SO <sub>4</sub> <sup>2-</sup> /L)	17,8	8,3
Phosphates (mg P/L)	0,30	0,04
Mineral oil (mg/L)	85,8	17,8
Iron (mg/L)	0,56	0,13
Lead (mg/L)	0,1000	0,1490
Cadmium (mg/L)	0,0004	0,0009
Copper (mg/L)	0,080	2,800
The total aerobic mesophilic bacteria /1 ml	15000	100
Total coliform bacteria of fecal origin /100 ml	11000	40

According to the reported results of the waste water treatment plant for the pre-treatment in SGF Paracin is satisfactory, the quality is not the one parameter does not significantly affect the deterioration of water quality municipal sewage town of Paracin. [9,10]

After treatment of purified water are carried from the factory and flow into the city sewage system. The sewage network is mixed with municipal waste water, and together they go on a final treatment that is performed on the main unit. This solution enables a completely collection of waste water in this industry and their simple elimination from the factory, allowing river Crnica pollution releases that are coming from this industry.

## **CONCLUSION**

Based on the test results it can be concluded that the waste water is turbid glass factory with a lot of suspended solids, low alkaline, the pH was 7,98 and the specific conductivity 632( $\mu\text{S}/\text{cm}$ ), which indicates a significant presence of mineral substances in the waste void. The void is the high content of mineral oil, about  $18 \text{ mg}/\text{dm}^3$ , which represents about 18% of the start up of concentration. So that is applying the technology of purification removes 82% of floating oil matter. The amount of waste water that discharges SGF is  $2880\text{m}^3/\text{day}$ .

Industrial waste water of SGF mainly occur in different cooling devices used in the manufacturing process, then from washing finished products. Also waste water is generated and in the preparation and use of suspensions with different abrasive material used in the chemical and mechanical grinding and polishing of glass products, which are otherwise quite oily, and of washing operation and maintenance of working premises.

In the central plant for pre-treatment of industrial waste water glass factories is first deposited and then physic processed. Using coagulant aluminum sulphate and polyelectrolyte as a flocculant, water and procedures are purified to a level free to engage in municipal sewers.

The task unit for waste water treatment is called primary treatment, ie. bringing the quality of the water level for free to engage in the city sewer.

## **REFERENCES**

1. Glynn Henry, J., Heinke, G. W. (1989): Environmental Science and Engineering, Prentice Hall, Englewood Cliffs, New Jersey .
2. Dalmacia B., J. Agbaba, Klasnja M. (2009): Modern methods in the preparation of drinking water, Faculty of Sciences, Novi Sad.
3. RiSRJ br. 31/82.
4. Anastasijevic D., N. Lukic, Pocajt V. Peric-Grujic BA., Ristic M. (2011): Analysis of selected elements in water in plants for preparation of drinking water in Belgrade, Faculty of Technology, Belgrade.
5. Turcinovic J. (2013): Assessment and management of chemical risk in the water system Ruma, University "Union-Nikola Tesla ", Faculty of Ecology and Environmental Protection is, Belgrade, master work.
6. Ministry of Agriculture, Forestry and Water Management, Directorate for Water (2007): The National Strategy for Sustainable Use of Natural Resources of the Republic of Serbia.
7. Regulation on the national list of environmental indicators, Official Gazette of the Republic of Serbia, no. 37/2011.
8. Regulation on the parameters of the ecological and chemical status of surface waters and the parameters of the chemical and quantitative status of ground water, Fig. Gazette no. 74/2011
9. Regulation on the classification and categorization of water, Official Gazette of SFRY No.102 / 78
10. Ordinance on Hazardous Substances in Waters, Fig. Gazette FRY, no. 31/82.



## PROCESSING OF SAND-GRAVEL AGGREGATES IN POLAND

Aleksander Lutynski

Institute of Mining Technology,  
Pszczynska 37, 44-101 Gliwice, POLAND

### ABSTRACT

The article presents equipment for the removal of impurities from sand-gravel aggregates. It presents the amount of impurities in mineral deposits of aggregates in Poland.

**Key words:** aggregates, gravel, sand, removal of impurities.

### INTRODUCTION

The sand-gravel aggregate which is mined in a quarry is characterized by its variability. It usually has a broad range of grain sizes, different physico-chemical properties and different quality and amount of impurities in the aggregate.

The impurities in the aggregates, particularly the ones designated for concrete mixtures, lower the final quality of the products. They have an impact on the curing and hardening time of concrete and its technological properties. Due to that fact sand-gravel aggregates usually have high quality requirements reflected in standards and regulations. The proper quality of aggregate which meets the requirements of standards imposes intensification of classification and cleaning processes to remove impurities [2].

### SELECTED EQUIPMENT FOR CLEANING SAND-GRAVEL AGGREGATES

In general, the impurities in the sand-gravel aggregates can be divided into two groups:

- organic impurities i.e. roots, pieces of plants, peat, brown coal (lignite), hard coal and wood,
- mineral impurities (inorganic) i.e. chalk (lake, meadow), limestones, marl (lake, meadow), clay.

It is estimated that sand-gravel aggregates contain up to a few percent of impurities. The allowable content of impurities in sand-gravel aggregates for commercial purposes should not exceed 0,25% according to the Polish standard PN-86/B-06712 "Mineral aggregates for concrete".

Impurities from the aggregates can be removed thanks to their different size and density. The second feature allows removing the impurities in washing processes. For that purpose various types of jigs are used eg. belt jigs (aquamators) and air-pulse jigs.

The basic principle of an air-pulse jig is the separation of minerals in the pulsing stream of water based on the grain size and density of the raw material, see Table 1.

Years of experience in aggregates processing show that there are many factors impacting proper washing efficiency. The most important ones are as follows:

- type of impurity in the raw material,
- grain size distribution,
- fraction of sand grains in the raw material (sand point).

Difficulties in the processing of the material appear with increasing density and grain size of the impurities in comparison to the aggregate grain size [2].

Jigs for the aggregate washing are manufactured by the foreign companies such as ALLMINERAL or SIEBTECHNIK. Solutions provided by these companies differ mostly in the way the water pulsation is forced. In case of the ALLMINERAL company the water pulse is forced by compressed air delivered under the bed. The SIEBTECHNIK company uses the membrane driven by the eccentric mechanism. Sample solutions of the air-pulse jig by ALLMINERAL company [6] are presented in Figures 1 and 2. In Figure 1 the principle of operation of this device is shown and Fig. 2 presents view of the installation with pulse jig ALLJIG®-JIGGING installed in the quarry. These machines provide capacity of up to 700 Mg/h for the aggregates of up to 150 mm in diameter. Fig. 3 presents the principle of operation of SIEBTECHNIK jig and Fig. 4 schematic view of the jig.

**Table 1.** Apparent density of aggregates and their impurities [3], [4]

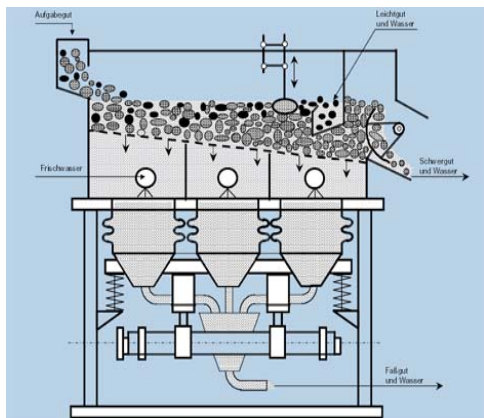
Material	Density, g/cm <sup>3</sup>
Wood	0,30 – 0,90
Charcoal	0,30 – 0,60
Lignite	1,10 – 1,25
Peat	0,90 – 1,80
Hard coal	1,20 – 1,40
Clay	1,50 – 2,60
Limestone	1,80 – 2,20
marl (lake, meadow)	1,80 – 2,20
chalk (lake, meadow)	1,80 – 2,20
Sand	2,57 – 2,78
Gravel	2,40 – 2,65



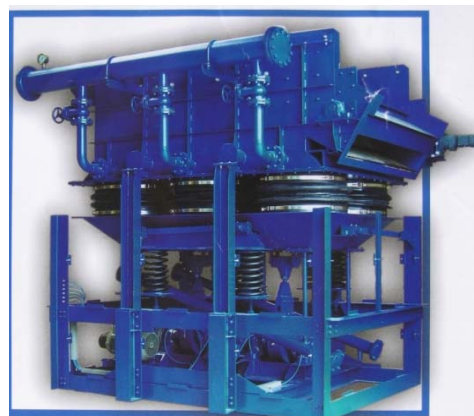
**Figure 1.** Principle of operation of ALLMINERAL pulse jig [6]



**Figure 2.** Technological circuit with installed ALLJIG<sup>®</sup> jig by ALLMINERAL company [6]



**Figure 3.** Principle of operation of SIEBTECHNIK pulse jig [8]



**Figure 4.** SIEBTECHNIK pulse jig [8]



Currently in Poland there are many solutions of water-pulse jigs designated for the coal and sand-gravel aggregate washing [5]. In the quarries where aggregates are produced polish jigs developed by KOMAG Institute of Mining Technology (called pulse classifiers) are used. The pulsation of water in KOMAG solutions is forced in the same manner as in the ALLMINERAL jigs. The example of such jig is presented in Fig. 5. This model is used for the separation of sand-gravel aggregate of 16(32)-2(0) in grain size diameter to obtain sand and gravel fraction. Organic and mineral impurities are efficiently washed away.



**Figure 5.** Pulse classifier developed by ITG KOMAG [7]

Pulse classifiers of ITG KOMAG development were implemented in the following aggregate processing plants [5]:

- Gravel quarry KSM Sp. z o.o. in Borzęcin, CEMEX Polska,
- ZPKiP PPMD KRUSZBET S.A. in Suwałki,
- PRInż. Surowce Sp. z o.o. in Januszkowice CEMEX Polska,
- ZP Betonów PUH M+ Sp. z o.o. in Kędzierzyn – Koźle,
- Gravel quarry CEMEX Polska in Bierawa,
- Gravel quarry Rokitno.

### **IMPURITIES IN AGGREGATE DEPOSITS**

Pulse classifiers have to be adjusted to the particular parameters of the material in the deposit therefore the first step is the assessment of the material properties such as quantity and quality analysis along with impurities type assessment. Results of

studies conducted in ITG KOMAG show that the quality of deposits differ significantly depending on the deposit.

For example:

- In the material of the quarry located near Kedzierzyn-Kozle which is acquired from the oxbow lake of Odra river, organic impurities such as hard coal and wood of density  $1,8 \text{ g/cm}^3$  were identified. The share of this material was 1,24% on average [3], [4].
- Material from Januszkowice (CEMEX Polska) quarry consisted of 0,14% of wooden impurities [3], [4].
- Trace impurities such as wood and roots were identified in Bierawa quarry (CEMEX Polska) [4].
- Material acquired from the mineral aggregates mine in Niemcy-Roktino contained mineral impurities which react in alkaline environment (eg. carbonates, chalk). The share of this impurities was 21,7% in 16-8 mm fraction and 8,9% in 8-2 mm fraction [3],[4].
- In the material acquired from the KRUSZBET S.A. Company mineral impurities were identified. The share of impurities was 6,18% in 32-16 mm fraction, 6,13% in 16-8 fraction whereas the finest fraction which was analyzed (8-2mm) contained 5,00% of these impurities [2].

Example of density analysis of the sand-gravel mix where organic impurities occur is presented in Table 2. In Table 3 density analysis of particular fraction of the feed where organic impurities occur was presented [2].

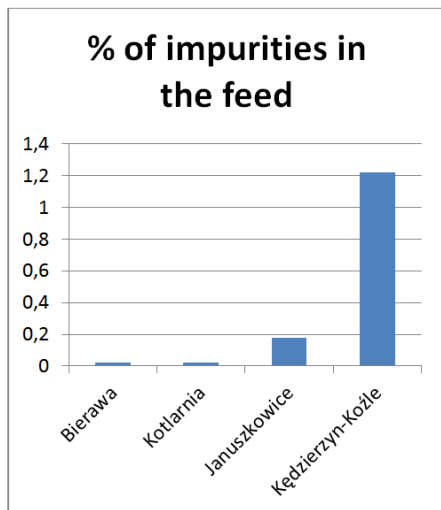
**Table 2.** Sample density analysis of sand-gravel mix where organic impurities occur [2]

Density, $\text{g/cm}^3$	Fraction, %			
	Sample 1	Sample 2	Sample 3	Average
< 1,5	1,09	0,85	1,02	0,99
1,5 – 1,8	1,00	0,65	0,22	0,62
> 1,8	97,91	98,50	98,76	98,39
Sum	100,00	100,00	100,00	100,00

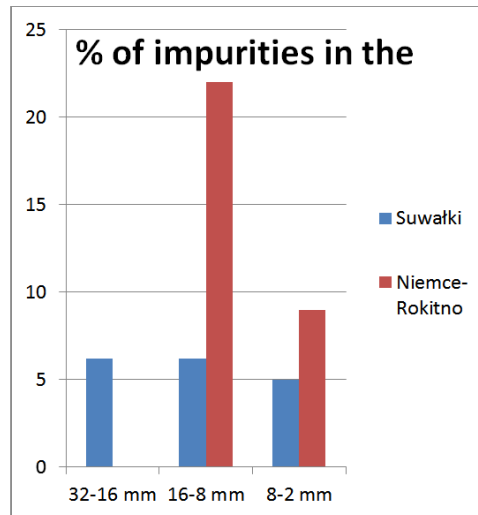
**Table 3.** Example of density analysis in particular fraction of the sand-gravel mix feed where organic impurities occur [2]

Density, g/cm <sup>3</sup>	Fraction, %		
	32 – 16 mm	16 – 8 mm	8 – 2 mm
< 2,0	2,30	1,57	0,39
2,0 – 2,2	1,37	0,46	0,39
2,2 – 2,4	2,51	4,10	4,22
> 2,4	93,82	93,87	95,00
Suma	100,00	100,00	100,00

In Figures 6 and 7, the percentage of organic and mineral impurities in the feed of various aggregate production plants is presented. In Fig. 6 the share of organic impurities in four plants is presented. In Fig. 7 the share of mineral impurities in particular fraction of feed from two power plants is presented. Worth noticing is the fact that the share of inorganic impurities is higher than that of organic impurities.



**Figure 6.** The share of organic impurities in four aggregate production plants [1], [2].



**Figure 7.** The share of mineral impurities in particular fraction of feed in two aggregate production plants [1],[2],[4]

## CONCLUSIONS

Current quality requirements related to the aggregate production force the producers to use equipment which will remove different impurities from the material which is sent to the market. Equipment and machines which allow to fulfill these requirements are available either abroad or in Poland by ITG KOMAG.

High efficiency of impurities removal from sand-gravel aggregates generates organic and mineral waste. Utilization of this waste as a raw material is a challenge for the aggregate producers.

## REFERENCES

1. Lutyński A., 2016: Usuwanie zanieczyszczeń z kruszywa żwirowo-piaskowych. *Kruszywa* nr 2/2016. Str.24-27
2. Lutyński A., Osoba M., 2007 : Wpływ charakterystyki pulsacji wody w wodnych osadzarkach pulsacyjnych na proces pozyskiwania wybranych produktów mineralnych. Monografia: Centrum Mechanizacji Górnictwa KOMAG, ISBN 83-6070-806-1. Gliwice
3. Łagódka M., Kowol D., 2009 : Wpływ uziarnienia nadaw żwirowych na skuteczność oddzielania zanieczyszczeń w procesie osadzarkowego wzbogacania kruszywa. *Maszyny Górnicze* nr 3, str. 27-32.
4. Matusiak P., Kowol D., 2013: Możliwości poprawy jakości kruszywa poprzez zastosowanie klasyfikatora pulsacyjnego typu KOMAG. *Prace Naukowe Instytutu Górnictwa Politechniki Wrocławskiej, Górnictwo i Geologia XIX*. Wrocław str 57-64
5. Osoba M., 2014: Polskie osadzarki wodne pulsacyjne do wzbogacania surowców mineralnych. „Inżynieria mineralna”, nr 2(34), Kraków, s. 287 – 294. PL ISSN 1640-4902.
6. <http://www.allmineral.com/>
7. <http://www.komag.eu/>
8. <http://www.siebtechnik.eu/>



XXIV International Conference

**"ECOLOGICAL TRUTH" ECO-IST'16**

12 – 15 June 2016, Hotel "BREZA", Vrnjacka Banja, SERBIA

## **BIODEGRADABLE POLYMERS AS MATRICES FOR ELECTROCONDUCTIVE COMPOSITES**

**Miroslav M. Pavlovic<sup>\*</sup>, M. Pantovic, V. Pavelkic,  
J. Stevanovic, M. G. Pavlovic**

University of Belgrade, ICTM-CEH, Njegoseva 12, Belgrade, SERBIA

*\*mpavlovic@tmf.bg.ac.rs*

### **ABSTRACT**

In this manuscript the results of experimental studies of the properties of composite materials based on lignocellulosic (LC) and poly(methylmetacrylate) matrices filled with electrolytic copper powder are presented. Volume fractions of metal fillers in composite materials and tested samples were varied in the range of 0.5-29.8% (v/v), and the samples were prepared by compression - cold pressing and molding. Characterization included examination of the influence of particle size and morphology on the conductivity and percolation threshold of the composites using a variety of testing techniques: SEM, TGA, AFM. Thermal analysis of the prepared composites showed the improvement of the thermal characteristics of the composites. This was due to the presence of the metallic fillers, which are very good thermal conductors, hence accumulating the heat emitted during TGA measurements primary to matrix, whether it was lignocellulosic or PMMA. Presence of three dimensional conductive pathways was confirmed.

**Key words:** thermal analysis, composite materials, lignocellulose, PMMA, AFM, TGA.

### **INTRODUCTION**

Composites are multiphase materials with a clear phase boundaries, in which two or more materials with different chemical composition (ceramics, polymers) and/or forms (granules, fibers, flakes, lamellas) form a single structure with clearly marked borders. Specific properties are achieved by combining the components in the composite (hardness, density, stiffness, thermal and electrical conductivity). Properties of composites depend on the properties of the components themselves, their chemical and constitutional composition. Basic constitutional components of the composite are: matrix and the additive (filler/ reinforcement), the material that achieves needed combination of properties in composite. Composites can be made of ceramic, polymer and metal matrix. In recent years, from the ecological aspect, special place has been occupied by biocomposites and green composites [1]. Green composites are fully made out from renewable natural materials (both matrix and reinforcement). Biocomposites are composites in which at least one segment, the matrix or reinforcement, is made out from renewable material, including wood, agricultural wastes, grasses and natural fibers consisting of carbohydrates (sugars and starches, cellulose and lignin), as well as

vegetable oils and proteins. Biocomposites can be made of: a) natural fibers (plant or animal origin) and biologically non-degradable polymers: thermosets (epoxy resins, phenolic resins) and elastomers (PE, PP, PVC, PS); b) synthetic fibers and biopolymers (incurred from plant processing) and c) from natural fibers and biopolymers, which are the most ecological composites and they are often called green composites. Biocomposites are essential for material world because they have unique properties that do not occur independently in nature. Also, their properties can be tailored in relation to the design of their composition and processing. This feature gives space for use of biocomposites in various sectors, like aviation industry and space exploration, automotive industry, construction, maritime, consumer products and electronic components [2].

In recent years, scientists and engineers have focused on reducing carbon dioxide emissions of all existing products, either by mixing bio-plastics and synthetic plastics and/or reinforcing it with synthetic fibers and fillers [3].

All biocomposites obtained from natural fibers and biodegradable plastics derived from natural origin (biopolymers and bioplastics) are highly environmentally [4]. These environmentally friendly green composites have the potential to become new materials XXI century and can be a partial solution to many global problems. Consequently, renewable polymer materials provide an answer to the question of sustainable development of economically and environmentally attractive and acceptable technology [4].

Lignocellulose is a term used to describe the three-dimensional polymer composite formed by plants as their structural material. It consists of a variable amount of cellulose, hemicellulose and lignin [5]. Lignocellulosic raw materials are mainly composed of carbohydrate polymers (cellulose and hemicellulose) and phenolic polymers (lignin). Minor concentrations of various other compounds, such as proteins, acids, salts and various minerals are also present.

Corn cob is a very important by-product of the production of corn grain. Every ton of corn grain yields 180-200 kg of corn cob. About 1.2-1.5 million tons of corn cob is produced every year in Serbia as secondary raw materials. In the world, traditional use of corn cob in agriculture, as heating material, material burnt for warming air in grain drying processes or coarse cellulosic food for feedstock, has been significantly expanded to the industry. An attempt has been made to produce acetic acid, methanol, charcoal, xylitol, furfural etc. out from corn cob [6, 7].

Research in the field of electro-conducting polymer composites filled with metal powders have experienced great development in the last two decades. Adding metal filler polymer matrix allows the preservation of the mechanical properties of polymers while, at the same time, exploiting the electric conductive properties of metal [8]. The conductivity of composites with conductive fillers depends on the nature of contacts between the conductive filler particles and filler volume fraction, which is well explained by the percolation theory [9-11].

In recent years, in literature, numerous information on the possibilities of application of polymers containing dispersed conductive fillers, as well as various methods for producing such materials, can be found [12-19]. The fine metal particles dispersed in polymer matrices have contributed to a number of industrial applications.

Composites with metal fillers have found application as electromagnetic protection of computers and electronic equipment, conductive adhesives for electronic equipment, cold solders, switches, materials for dissipation of static electricity in devices for protection against power surges [8, 20-23]. They also found numerous technological applications as self-regulating heaters, photothermal optical recorders, chemical sensors and electronic noses, chemical and electrochemical catalysts and adsorbents [24]. Electrically conductive polymer composites have several advantages over their constituents, which include lower cost and ease of production, high flexibility, reduced weight, greater ability to absorb mechanical shocks, corrosion resistance and conductivity control [8].

## EXPERIMENTAL PART

In the experimental part of the work, lignocellulose and poly(methylmethacrylate) (PMMA) were used as matrices. Lignocellulose was produced in *Maize Research Institute "Zemun Polje"* was used for synthesis of tested composites [7]. Celgran<sup>®</sup> C fraction was used, which was milled in a ball mill, and then dry sieved through mesh with openings of 45  $\mu\text{m}$ . PMMA used was commercial PMMA in form of beads, supplied by Sigma-Aldrich, having average molecular weight of  $M_w \sim 350000$ , with a density of  $1.20 \text{ g/cm}^3$  and the electrical conductivity of about  $10^{-12} \text{ S/cm}$ . Before use, the polymer was dried in a tunnel furnace at  $60 \text{ }^\circ\text{C}$  in a controlled nitrogen atmosphere.

The electrolytic copper powder used in this study was galvanostatically produced under following conditions: current density,  $j=3600 \text{ A/m}^2$ , time of powder growth  $\tau_f=15 \text{ min}$ , electrolyte flow  $Q=1$  change of the cell volume/h, temperature of the electrolyte  $t=(50\pm 2)^\circ\text{C}$ , concentration of copper  $C(\text{Cu}^{+2})=15 \text{ g/dm}^3$  and concentration of sulfuric acid  $C(\text{H}_2\text{SO}_4)=140 \text{ g/dm}^3$ . Wet powder was washed several times with a large amount of demineralized water until the powder was left without traces of acid at room temperature, because the acid promotes rapid oxidation of the powder during drying process. Obtained copper powder was subsequently washed with aqueous solution of sodium soap SAP G-30 to protect the powder from succeeding oxidation, which was prepared and used as explained by Pavlović et al. [25]. After drying in a tunnel furnace at  $110 - 120 \text{ }^\circ\text{C}$  in controlled nitrogen atmosphere, copper powder was sieved through mesh with openings of  $45 \mu\text{m}$ .

Polymer composites of lignocellulose filled with copper powder were prepared with the filler volume fraction from 2.0% (v/v) - 29.8% (v/v), while PMMA composites filled with same powder were prepared with the filler volume fraction ranging 0.5 % (v/v) - 8.8% (v/v). Pure lignocellulose, PMMA and copper samples were prepared as reference materials. All the samples were produced from thoroughly homogenized mixtures of powders, where lignocellulosic composites were cold pressed into tablets 16 mm in diameter at room temperature ( $T = 25 \text{ }^\circ\text{C}$ ) at pressures of 10, 20 and 27 MPa, and PMMA composites were molded while heated at  $t=180 \text{ }^\circ\text{C}$  for 30 min. After preparation of PMMA composites, samples were cooled at room temperature for about 30 min. In order to obtain flat surface for conductivity measurements, samples were polished with sandpaper.

EDS analysis of lignocellulose and PMMA composites was examined in more detail using scanning electron microscopy VEGA TS 5130MM microscope (Tescan).

For the illustration of thermal behavior (stability), thermogravimetric analysis was performed on all the samples. Thermogravimeter TA Instruments Q600 thermal analyzer with a heating rate of 20 °C/min in a dynamic nitrogen atmosphere was used.

Topography of obtained PMMA composites was examined by Atomic Forces Microscope, type "Nanoscope III" AFM "Multi Mode Scanning Probe Microscope", produced by "Digital Instruments".

## **RESULTS AND DISCUSSION**

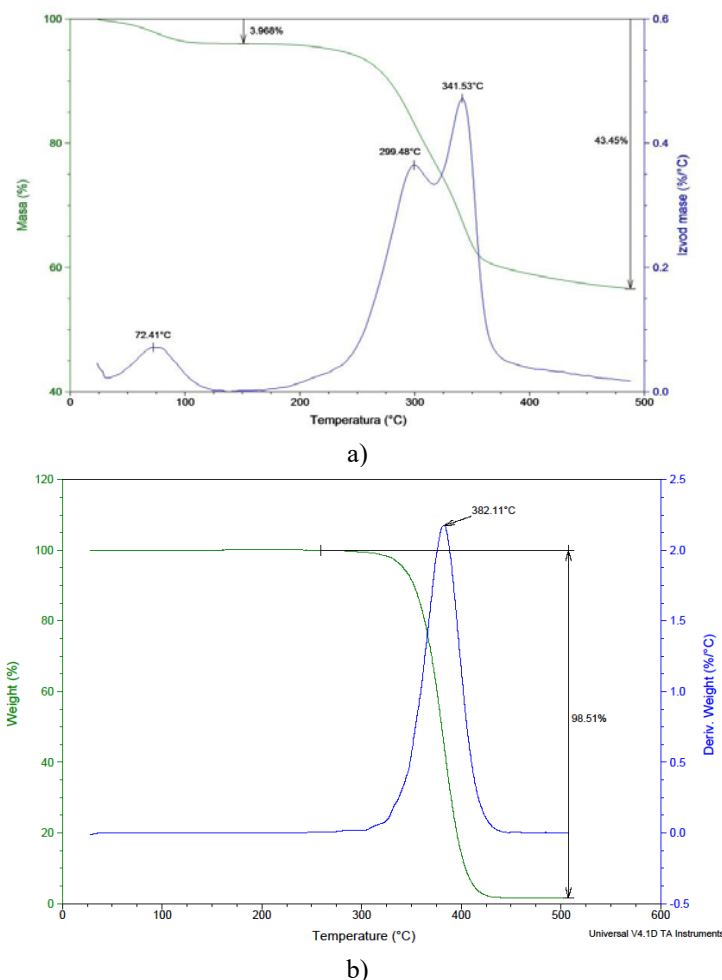
The conductivity of the conductive polymer composites is highly dependent on the nature of contacts between the conductive filler elements. In order to achieve better electrical conductivity of the conductive polymer composites with the same or similar characteristics, and hence saving in material, different types of fillers are used, particularly those with highly developed free surfaces. Theoretical and experimental considerations have shown that their use leads to the formation of conductive network through the entire volume of the sample at a much lower filler volume fraction [26]. However, the percolation threshold, the electrical conductivity and the electrical behavior of the composite systems with fillers with highly developed surface area, primarily thermal behavior of these materials, have not been fully explored. Therefore there is a need for more detailed study of real synergetic effects of different fillers dimensionality suitable for construction of conductive networks in conductive polymer composites.

TGA curves shown in Figure 1 illustrate the thermal behavior (stability) of lignocellulose composites and electrochemically deposited copper powder at percolation threshold. Characteristic temperatures of the observed thermal events in Figure 1a confirm presence of the main constituents (cellulose, hemicellulose and lignin) [7].

The mass loss increases with temperature gradually up to approximately 200 °C, while in the region between 200 and 400 °C more significant mass loss occurs. On the obtained TGA curve (Figure 1) two distinct peaks can be observed within this temperature interval, suggesting the existence of two separate thermal events. According to the literature data [27,28], the first event that occurs at 210-300 °C can be associated with the decomposition of hemicellulose and the slow degradation of lignin, while the second event (275-350 °C) can be attributed to the degradation of cellulose. Possible discrepancies between literature data and the TGA results may be associated with the amount of cellulose and lignin in the lignocellulose material, given that Shebani et al. [27] demonstrated that higher cellulose and lignin content in lignocellulosic materials leads to a greater thermal stability.

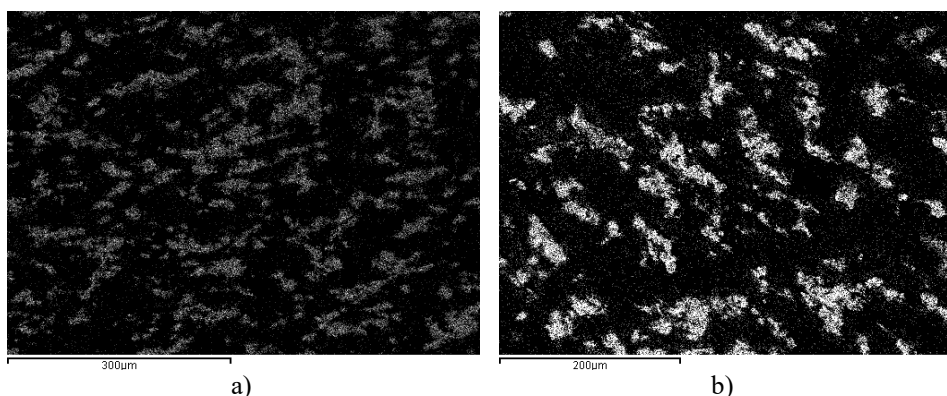
A characteristic peak that can be observed in Figure 1b corresponds to degradation of the matrix (an event that occurs at 279-382 °C). All presented results, on the other hand, showed slight improvement in the thermal characteristics of the composites due to the presence of copper powder, which is extremely good thermal conductor, so that the amount of heat emitted during the TGA measurements was originally accumulated in the copper powder particles, and only after this accumulation there is a change in matrices themselves.



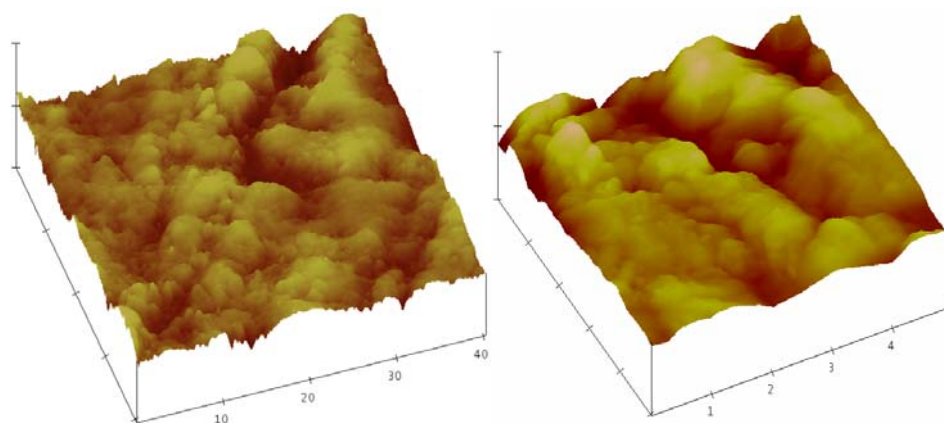


**Figure 1.** The results of thermogravimetric analysis of composites a) lignocellulose matrix filled with copper powder, treatment pressure of 20 MPa; b) PMMA matrix filled with copper powder

EDS measurements (Figure 2) show the existence of copper conductive pathways throughout the composites volumes. Due to the packaging effect and more pronounced interparticle contact with smaller, highly porous, highly dendritic particles with high values of specific area lead to “movement” of percolation threshold towards lower filler content. This feature can be observed on both on Figure 2 and Figure 3. Figure 3 presents AFM image of the PMMA composite surface after breaking. Conductive pathways were confirmed by EDS measurements, and the conductivity of the composite is obtained through conductive pathways of the filler that form in the composites. These pathways are formed in 3D in a pure random order.



**Figure 2.** EDS images of the composite sample prepared at percolation threshold. White dots represent Cu. a) LC-Cu composite and b) PMMA-Cu composite



**Figure 3.** 3D AFM images of the PMMA (left) and LC (right) composite filled with copper powder at percolation threshold

Greater roughness that can be seen on Figure 3 is assigned to copper powder, since it has greater hardness and greater free surface area than the matrix, which was confirmed by EDS measurements.

### CONCLUSIONS

The results showed that the shape and morphology of the copper powder, and filler at all, play a significant role in the phenomenon of electrical conductivity of the prepared samples and the appearance percolation threshold. The particles with highly developed free surface and dendritic and highly branched structure, such as

galvanostatically obtained copper powder particles can easier form interparticle contacts at lower filler volume fractions than particles with more regular surface.

The results of thermal analysis of prepared composites show a slight improvement thermal characteristics of the composites due to the presence of metal fillers which are outstanding thermal conductors, so that the amount of heat emitted during the TGA measurements is initially accumulated in the filler, and only then there is change in the matrix.

When two different matrices are compared, slight advantage can be given to PMMA since the percolation threshold is at lower value. Both matrices have improved thermal characteristics when filler is added. However, lignocellulose is biodegradable, green matrix, and it comes from abundant, sustainable resource, and it can be used for green composite production.

### **Acknowledgements**

*This work was supported in the framework of projects ON 172037 and ON 172046 financed by the Ministry of Education and Science of Republic of Serbia.*

### **REFERENCES**

1. D.Z. Marković, A. R. Zarubica, G. S. Nikolić, *Savremene tehnologije*, 3(2), 116, 2014
2. A. K. Mohanty, M. Misra, L. T. Drzal (Eds.), *Natural Fibers, Biopolymers, and Biocomposites*, Taylor and Francis Group, Florida, (2005).
3. L. Averous, F. L. Digabel, *Carbohydrate Polymers*, 66(4), 480, (2006).
4. S. Pilla (Ed.), *Handbook of Bioplastics and Biocomposites Engineering Applications*, John Wiley and Sons, New Jersey, (2011).
5. D. K. Lee, V. N. Owens, A. Boe, P. Jeranyama, *Composition of Herbaceous Biomass Feedstocks*, S. D. S. University, USA, (2007).
6. K. M. Foley, *Chemical Properties, Physical Properties and Uses of the Anderson's Corncob Products and Supplements*, Anderson's Cob Division Processing Group, Maumee, OH, USA, (1978).
7. I. Božović, M. Radosavljević, R. Jovanović, S. Žilić, V. Bekrić, D. Terzić, *Journal of Scientific Agricultural Research*, 63(3-4), 37, (2002).
8. V. H. Poblete, M. P. Alvarez, V. M. Fuenzalida, *Polymer Composites*, 30, 328, (2009).
9. D. S. McLachlan., M. Blaszkiewicz, R. E. Newnham, *Journal of the American Ceramic Society*, 73(8), 2187, (1990).
10. D. Stauffer, A. Aharony, *Introduction To Percolation Theory*, 2nd ed., Taylor and Francis, London, (1992).
11. L. J. Huijbregts, *Charge transport and morphology in nanofillers and polymer nanocomposites*, Doctoral Disertation, Technische Universiteit Eindhoven, Eindhoven, (2008).
12. V. Bojanić, *Hemijaska Industrija*, 64(6), 529, (2010).

13. G. Pinto, A. K. Maaroufi, *Journal of Applied Polymer Science*, 96, 2011, (2005).
14. M. Thakur, *Macromolecules*, 21, 661, (1988).
15. H. S. Son, H. J. Lee, Y. J. Park, J. H. Kim, *Polymer International*, 46, 308, (1998).
16. J. Bouchet, C. Carrot, J. Guillet, *Polymer Engineering and Science.*, 40, 36, (2000).
17. L. Flandin, A. Chang, S. Nazarenko, A. Hiltner, E. Baer, *Journal of Applied Polymer Science*, 76, 894, (2000).
18. S. Kamel, *Express Polymer Letters*, 1, 546, (2007).
19. E. A. Stefanescu, C. Daranga, C. Stefanescu, *Materials*, 2, 2095, (2009).
20. S. K. Bhattacharya (Ed.), *Metal Filled Polymers: Properties and Applications*, Marcel Dekker, New York, (1986).
21. L. Xiangcheng, D. D. L. Chung, *Composites Part B: Engineering*, 30, 227, (1999).
22. Y. Xu, D. D. L. Chung, C. Mroz, *Composites Part A: Applied Science and Manufacturing*, 32, 1749, (2001).
23. M.-L. Sham, J.-K. Kim, *Composites Part A: Applied Science and Manufacturing*, 35, 537, (2004).
24. J. Delmonte, *Metal/Polymer Composites*, Van Nostrand Reinhold, New York, (1990).
25. M. M. Pavlović, V. Ćosović, M. G. Pavlović, N. Talijan, V. Bojanić, *International Journal of Electrochemical Science*, 6, 3812, (2011).
26. M. M. Pavlović, *Sinteza i karakterizacija elektroprovodnih kompozitnih materijala na bazi biorazgradivih polimera i prahova metala*, Doktorska disertacija, Univerzitet u Beogradu, Tehnološko - metalurški fakultet, Beograd, (2015).
27. A. N. Shebani, A. J. v. Reenen, M. Meincken, *Thermochimica Acta*, 471, 43, (2008).
28. F. Yao, Q. Wu, Y. Lei, W. Guo, Y. Xu, *Polymer Degradation and Stability*, 93, 90, (2008).



XXIV International Conference

**"ECOLOGICAL TRUTH" ECO-IST'16**

12 – 15 June 2016, Hotel "BREZA", Vrnjacka Banja, SERBIA

## THERMAL PROPERTIES OF POLYURETHANES BASED ON RENEWABLE POLYOL COMPONENT

Jaroslava Budinski Simendic<sup>1</sup>, Z. Bjelovic<sup>2</sup>, Lj. Tanasic<sup>3</sup>, T. Erceg<sup>1</sup>,  
J. Pavlicevic<sup>1</sup>, V. Aleksic<sup>2</sup>, V. Micic<sup>2</sup>

<sup>1</sup>University of Novi Sad, Faculty of Technology, Bulevar cara Lazara 1,  
Novi Sad, SERBIA

<sup>2</sup>University of East Sarajevo, Faculty of Technology, Zvornik, Karakaj,  
Republic of Srpska, BOSNIA AND HERZEGOVINA

<sup>3</sup>High School of agricultures, Vojvode Putnika 56 Sabac, SERBIA

### ABSTRACT

The possibility to design polyurethanes (PU) based on either aliphatic or aromatic isocyanates have ensured widespread use in end products such as high-performance elastomers, electrical and electronic equipment, coatings, thermal insulation foams, etc. The materials based on isophorone diisocyanate due to its stable aliphatic structure makes them ideal for producing durable, non-yellowing elastomers that stand up to UV light exposure. The goal of this work was to investigate the thermal stability of environmentally friendly castor oil based polyurethane materials. The samples were prepared using several stoichiometric imbalances. The synthesis was carried out in bulk and without catalyst by a one-step reactive process. Simultaneous TG-DSC measurements were performed in nitrogen and air atmospheres using TA Instruments SDT Q600 equipment.

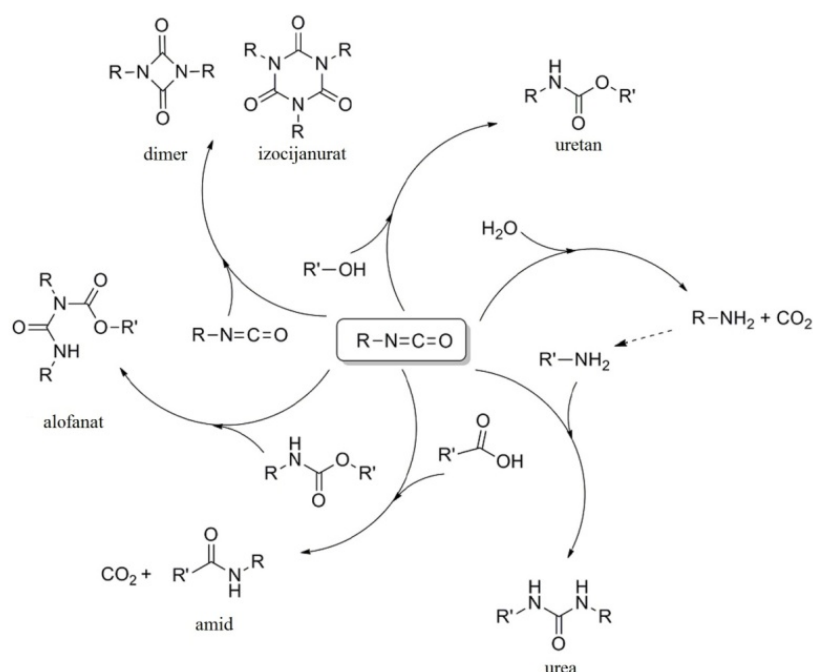
**Key words:** castor oil, isophorone diisocyanate, thermogravimetry, thermal stability, polyurethane.

### INTRODUCTION

The hope is that using renewable resources as feedstock for chemical processes will reduce the environmental footprint by reducing the demand on non-renewable fossil fuels currently used in the industry and reduce the overall formation of carbon dioxide, the most notable greenhouse gas. Different manufacturing procedures are possible for preparation of polymers based on renewable materials: (a) preparation of monomers which are already widely used, as obtained from fossil resources, (b) original materials with novel properties and applications, e.g. thermo-reversible polymers, (c) the synthesis of polymers which are intended to simulate the performance of existing counterparts from non-renewable resources, and (d) chemical or physical modification of natural polymers for improving and radically modifying their native properties, e.g. cellulose and chitosan grafting, and starch plasticization hydrophobization [1]. Due to their high abundance and annually renewable natural resources, low cost as well as the

biodegradability of the resultant polyurethane materials, vegetable oils as monomers are popular raw materials for polyurethane fabrication. Castor oil, CO, is a low-cost, abundantly available, renewable raw material and has attracting research effort because of its use in coatings, adhesives, paints, sealants, encapsulating compounds. As a vegetable oil with reactive hydroxyl functional groups, it can be used as a polyol to develop new and "green" macromolecular architectures. Polyurethanes based on CO with different diisocyanates seem to be interesting alternatives to non-renewable-based materials, in agreement with the concept of sustainable development [2,3]. Ricinoleic acid is an 18-carbon acid having a double bond between the 9-10<sup>th</sup> carbon atom position and a hydroxyl group on the 12<sup>th</sup> carbon atom. This combination of hydroxyl group and unsaturation occurs only in castor oil. Castor oil is increasingly finding application in the manufacture of polyurethane foams [4,5]. The polyurethane is produced from polyols based on castor oil. Due to the wide range of compositions possible, polyurethanes have found extensive use in different applications such as coatings, foams, adhesives, membranes, sealants, synthetic leathers, elastomers as well as in many biomedical applications. Although these materials contain repeating urethane groups, other moieties such as urea, ester, ether and aromatic may also be present in the structure. In the Figure 1 is given the scheme of the isocyanate group possible reaction during polyurethanes preparation. The methods of fabrication polyurethane products range from small, hand pour piece-part operations to high-volume bunstock and boardstock production lines. Regardless of the end-product, the manufacturing principle is the same: to meter the liquid isocyanate and reaction mixture with polyols catalyst, chain extenders at a specified stoichiometric ratio, mix them together until a homogeneous blend is obtained, dispense the reacting liquid into a mold or on to a surface, wait until polymer network with permanent or temporary crosslinked points is formed, then demold the finished part. The greatest dangers in polyurethanes fabrication appear during preparation of block in a continuous manner, during fabrication in closed rooms, and during foam spraying in coating production. Polyurethane coatings can enhance a product's appearance and lengthen its lifespan. Polyurethane adhesives can provide strong bonding advantages, while polyurethane sealants provide tighter seals. PU elastomers can be molded into almost any shape, are lighter than metal, offer superior stress recovery and can be resistant to many environmental influences [6]. Car bumpers, electrical housing panels and computer and telecommunication equipment enclosures are some of the parts produced with polyurethanes using reaction injection molding. Adding design flexibility, the RIM process produces parts that are usually not achievable using typical injection molding processes, such as thick- and thin-walled parts, encapsulated inners and foamed cores. In addition to high strength and low weight, polyurethane parts can exhibit heat resistance, thermal insulation, dimensional stability and a high level of dynamic properties. Automotive, construction, appliance, furniture and recreation and sporting goods are a few of the markets and applications using RIM technology. Waterborne polyurethane dispersions are coatings and adhesives that use water as the primary solvent. With increasing regulation on the amount of volatile organic compounds and hazardous air pollutants that can be emitted into the atmosphere, materials are being used in more industrial applications. Their primary areas of use are in the manufacturing of wood panels, rubber or elastomeric flooring

surfaces and sand casting for the foundry industry. Aliphatic isocyanates are used not in the production of PU foam, but in special applications, such as enamel coatings which are resistant to degradation from ultraviolet light. These properties are particularly desirable for the exterior paint applied to aircraft. The materials based on IPDI due to its stable aliphatic structure makes them ideal for producing durable, non-yellowing polyurethane elastomers that stand up to UV light exposure. Thermal degradation of polyurethane is affected by the structures of used polyols, urethane group concentration and crosslink density. The study of the decomposition of PUs is particularly difficult since they degrade with the formation of various gaseous products and a number of decomposition steps are typically observed using the thermogravimetry [7]. Some authors claim that the study of the thermo-degradation behavior of PUs at high temperatures provides a fingerprint of the material that has to do not only with the characteristics of the original material, but also with its processing and the final quality of the end use products [8]. Petrović et al. studied the thermal degradation of different polyurethanes based on different vegetable oil as polyols. Their study showed that many factors affect the thermal stability of the urethane groups such as type and structures of used polyols, urethane group concentration and crosslink density. They concluded that PU based on vegetable oils have a better oxidative thermal stability than PU based on poly(propylene glycol) [9].



**Figure 1.** The possible reaction of isocyanate group during polyurethane materials preparation

Thermal data on degradation allows the determination of optimum conditions for processing of materials. The thermal decomposition of PU is a complex heterogeneous process taking part through various decomposition reactions with more or less overlapped steps. The thermal stability of a material is defined by the specific temperature or temperature-time limit within which the material can be used without excessive loss of properties. In the commercial applications point of view the investigation of thermal stability has two important aspects. The first one concerns the stabilization of a polymer by changing the composition of the starting materials, in order to obtain novel materials with a desired level of thermal stability that will be able to fulfill the demands of contemporary materials engineering. The second one is to understand the decomposition processes of the materials as well as to obtain characteristic thermal decomposition data.

## EXPERIMENTAL PART

### Materials

Isophoronediiisocyanate (IPDI) (figure 2), Castor oil (CO) with hydroxyl number 170 mg KOH/g and acid value 1.27 mg KOH/g; all supplied from Sigma-Aldrich Company. Acetone was high-performance liquid chromatography grade of Merck Chemical Co. Prior synthesis the hydroxyl value of castor oil was determined according to the standard test method using a reaction with p-toluenesulfonyl isocyanate and potentiometric titration with tetrabutylammonium hydroxide.

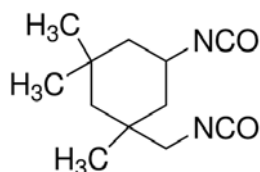


Figure 2 . The structure of izophorone diisocyanate (IPDI).

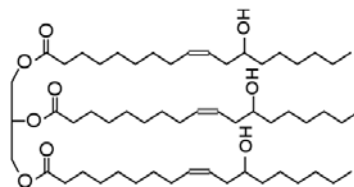


Figure 3 . The structure of castor oil.

### Sample preparation

The polyurethanes based on castor oil as a renewable resource were synthesized without catalyst. A weighted amount of castor oil in a three-neck, round-bottom flask was dried in the vacuum during 10 hours at 70 °C in water bath, prior the



use to prevent the reaction of isocyanate component with traces of water and bubbles formations. The reaction of the castor oil was carried out by addition of the diisocyanate under stirring at 70°C for 15 minutes in a nitrogen atmosphere. Then the mass was cast into preheated mold and kept in oven at 110 °C during 12 h to complete the polyurethane network formation.

### Characterization of samples

Simultaneous TG-DSC measurements were performed using TA Instruments SDT Q600 equipment, in nitrogen and air atmospheres (gas flow: 100 cm<sup>3</sup> min<sup>-1</sup>) in temperature range of 50 – 650 °C at a heating rate of 20 °C min<sup>-1</sup>. Sample mass: 3 – 4 mg.

## RESULTS AND DISCUSSION

Urethanes are relatively thermally unstable materials. The thermal decomposition of vegetable based polyurethanes is important phenomenon from fundamental and industrial point of views. The investigation of degradation processes allows determination of optimum conditions for PUs processing. Fundamental research has established that the thermal decomposition of PUs is a complex heterogeneous process and consists of several partial decomposition reactions [5]. The thermal stability of a material is defined by the specific temperature or temperature-time limit within which the material can be used without excessive loss of properties [6]. With respect to commercial applications, the investigation of thermal decomposition processes has two important aspects. The first concerns the stabilization of a polymer to obtain materials. Derivative TGA curves of the polyurethanes reveal actually three main degradation processes, (Figure 4). The first stage is due to the breaking of urethane links, which starts at 250 °C leading to the formation of CO<sub>2</sub>, alcohols, amines, aldehydes, CO, etc. Three mechanisms of decomposition of urethane bonds were proposed:

1. Dissociation to isocyanate and alcohol  
$$\text{RHNCOOR}' \leftrightarrow \text{RNCO} + \text{HOR}'$$
2. Formation of primary amine and olefin  
$$\text{RHNCOOCH}_2\text{CH}_2\text{R}' \leftrightarrow \text{RNH}_2 + \text{CO}_2 + \text{R}'\text{CH}=\text{CH}_2$$
3. Formation of secondary amine  
$$\text{RHNCOOR}' \leftrightarrow \text{RHNR}' + \text{CO}_2$$

The thermal decomposition of all polyurethane materials with castor oil, in order to get a better insight into the decomposition processes, is presented by their DTG curves. The decomposition of PU based on IPDI for  $r=1.0$  in air and nitrogen atmospheres are given in the Figure 5. The decomposition mechanism in air and nitrogen is different. In air the decomposition rate is slower therefore the processes are more separated, in spite of the fact that all decomposition steps are accompanied by high-exothermic effect. In nitrogen atmosphere the decomposition is endothermic. Above 400 °C the shape of the DTG curve resembles the decomposition of the pure castor oil. The decomposition in air is complete at 600 °C, while in nitrogen at temperature higher than 500 °C, with no residue. Samples prepared with excess of OH

groups ( $r = 0.92$  and  $0.80$  for IPDI series, have the lowest onset degradation temperature.

All three reactions may proceed simultaneously. The second stage could be a consequence of the polyol decomposition and starts after urethane bond break. Since polyol used in this study is castor oil, the formation of 10-undecanoic acid and heptanal is expected as is found in thermal degradation of ricinoleic acid, which is the main constituent of castor oil. The shape of the TG curves for all polyurethane samples are almost identical as is presented by TG curves of PU based on IPDI in Figure 6.

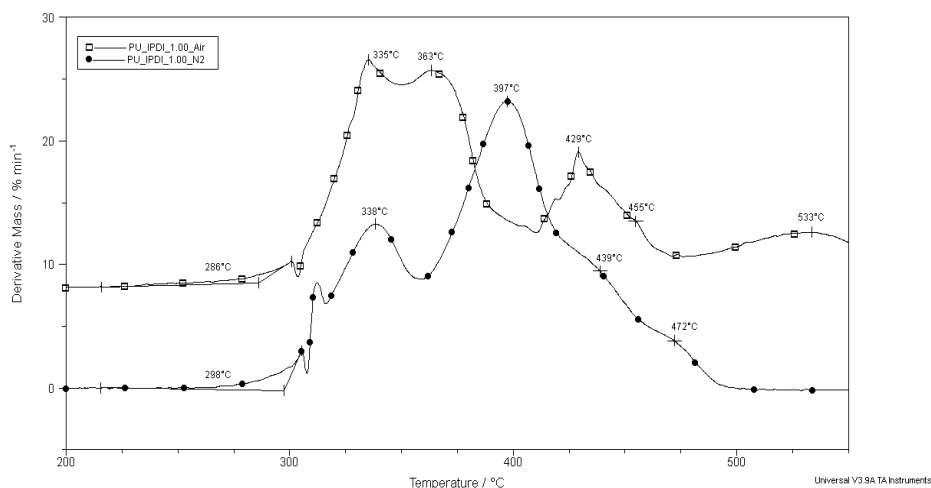


Figure 4. DTG curves for polyurethanes based on IPDI for  $r=1$  in air and nitrogen atmospheres.

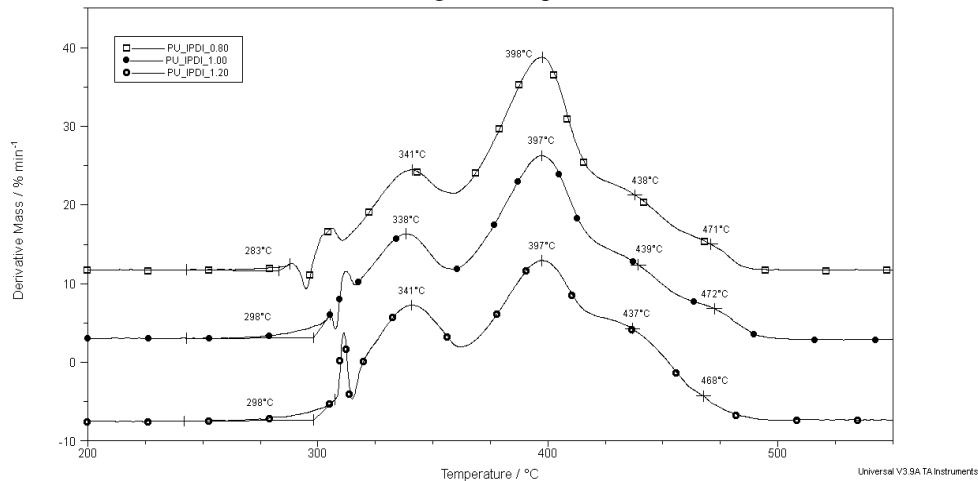
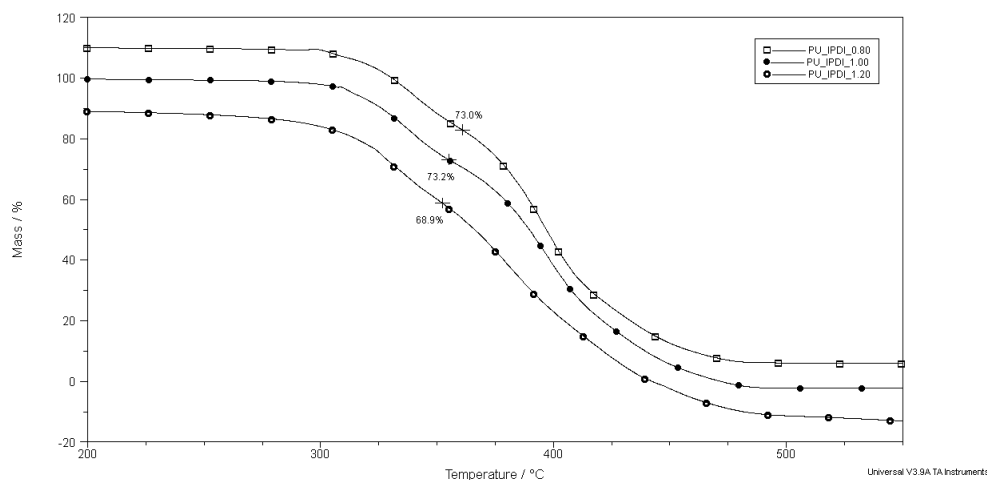


Figure 5. DTG curves for polyurethanes based on IPDI for different stoichiometric balance of reactive groups obtained in air atmosphere



**Figure 6.** TGA curves for polyurethanes based on IPDI for different stoichiometric balance of reactive groups obtained in air atmosphere

## CONCLUSIONS

This study was an attempt to prepare environmentally friendly material based on castor oil as a renewable resource and based on isophorone diisocyanate. Different elastomers were prepared using several stoichiometric imbalances. The thermal properties of the materials are discussed on the basis of simultaneous TG-DSC measurements results. The assessment of structure–property relationship showed that desired mechanical properties could be obtained via basic formulations variation. Samples prepared with excess of OH group have somewhat lower thermal stability.

### *Acknowledgments*

*Authors wish to express the gratitude to the Ministry of Education and Science of the Republic of Serbia (Projects No. III45022) for financial support.*

## REFERENCES

1. Y. Zhang, Z. Xia, H. Huang, H. Chen, Thermal degradation of polyurethane based on IPDI, *Journal of Analytical and Applied Pyrolysis*, 84(1) (2009)89–94.
2. E. Hablot, D. Zheng, M. Bouquey, L. Averous, Polyurethanes Based on Castor Oil: Kinetics, Chemical, Mechanical and Thermal Properties, *Macromolecular Materials and Engineering*, 293 (11) (2008) 922–929.
3. Alessandro Gandini, Talita M. Lacerda, From monomers to polymers from renewable resources: Recent advances, *Progress in Polymer Science*, 48 2015 1-39

4. L Wang, C., Zheng, Y., Xie, Y., Qiao, K., Sun, Y., Yue, L., Synthesis of bio-castor oil polyurethane flexible foams and the influence of biotic component on their performance, *Journal of Polymer Research*, 22(8) (2015) art. no. 145
5. Zieleniewska, M., Leszczyński, M., Kurańska, M., Prociak, A., Szczepkowski, L., Krzyzowska, M., Ryszkowska, J., Preparation and characterisation of rigid polyurethane foams using a rapeseed oil-based polyol, *Indust Crops and Products*, 74, (2015) 887-897
6. Rogulska, M., Kultys, A., Lubczak, J., New thermoplastic polyurethane elastomers based on aliphatic-aromatic chain extenders with different content of sulfur atoms, *Journal of Thermal Analysis and Calorimetry*, 121 (1) (2015) 397-410.
7. Askari, F., Barikani, M., Barmar, M., Shokrolahi, F., Vafayan, M., Study of thermal stability and degradation kinetics of polyurethane-ureas by thermogravimetry, *Iranian Polymer Journal*, 24 (9) (2015) 783-789.
8. R. Prime, J. Burns, M. Karmin, C. Moy, H. Tu, Applications of DMA and TGA to quality and process control in the manufacture of magnetic coatings, *J. Coat. Technol.*, 60, (2008) 55-60.
9. Z. Petrovic, Y. Xu, J. Milic, G. Glenn, A. Klamczynski, Polyurethanes from vegetable oils. *Polym Rev.* 48 (2008)109-55.
10. Scaiano J. C., *Laser photolysis in polymer chemistry. Degradation and stabilization of polymers*, vol. 2, Amsterdam: Elsevier, 1989, 1-39.
11. D. Chattopadhyay, D. Webster, Thermal stability and flame retardancy of polyurethanes, *Progress in Polymer Science* 34 (2009) 1068-1133.



## CEROVO COPPER MINES CONTROLLED BLASTING DESIGN

Sasa Stojadinovic\*, R. Pantovic, M. Zikic, M. Denic

University of Belgrade, Technical faculty in Bor, VJ 12, Bor, SERBIA

\*sstojadinovic@tf.bor.ac.rs

### ABSTRACT

Copper mine Cerovo operates under RBB Bor, a part of the RTB Bor – Group. At present moment only one pit, Cerovo 1 is active. However, with the design finished, intensive works are undertaken in order to prepare the terrain and infrastructure for the development and opening of the second pit, Cerovo 2, to the north of Cerovo 1. Since technology applied utilizes drilling and blasting operations there is a high probability that the existing structures in the close proximity of both pits could be affected by ground vibrations generated by the blasts. In order to protect the structures and prevent damage appearance it was necessary to design the blasting parameters in order to, through controlled blasting, minimize the probability of blast induced damage.

**Key words:** ground vibrations, PPV, controlled blasting, safety zone.

### INTRODUCTION

Cerovo copper mine is located in East Serbia, North of Bor and operates under RBB Bor as a part of RTB Bor – Group. Mining operations started in Cerovo – Cementacija 1 ore deposit back in 1993 and were seized in 2002. However, due to increased copper prices Cerovo 1 was reopened in 2011 and is active since. The ore is mined using drill and blast operations and truck hauled to the nearby milling facility. Milled ore is then transported to Veliki Krivelj flotation plant as a pulp via the pipeline.

Cerovo 2 ore deposit is located north of Cerovo 1 at a distance of several hundred meters. With mine design finished focus is shifted to infrastructure development and intensive preparations for mine opening.

In the proximity and to the E-SE of Cerovo 1 there are several inhabited households with residential structures. The closest residential structure is at a distance of merely 270 m from the final pit outline. To the west, at a distance of 780 m from the final pit outline, there is a railroad bridge with a 450 m span.

According to design the west slope of Cerovo 2 will be located at a distance of only 40 m from the Bor – Belgrade railroad and railroad tunnel and 300 m from the nearest residential structures located to the northwest.

Since mining technology for both Cerovo 1 and Cerovo 2 considers drilling and blasting operations there is a high probability that the structures closest to the pits could be affected by the ground vibrations. In order to protect the structures from damage

appearance it was necessary to revise the mine design from the aspect of negative effects of blasting. A thorough study was performed by Technical faculty in Bor (TFB) and Faculty for mining and geology Belgrade (RGF). The study was conducted in phases, first defining the intensity of ground vibrations and setting the propagation law. The second task was to perform initial investigation of the nearest buildings and record any existing damage in order to set the initial conditions and define the maximum allowed ground vibrations intensity. The next phase was to revise the blast design in order to calculate maximum explosive charge per delay upon the determined ground vibrations limits. Finally, a monitoring system was designed to monitor and collect data on ground vibrations once the mining operations start. All of these phases were finally presented through three different documents, Elaborate on seismic measurements during blasts at Cerovo 1 (RGF) [1], Elaborate on initial state of structures in the proximity of Cerovo copper mine (TFB) [2] and the Monitoring design for ground vibrations and their affect to humans and structures (TFB) [3]

This article will give the details on blast design revisions and reference to other phases of the Study.

### **DEFINITION OF MAXIMUM ALLOWED GROUND VIBRATION INTENSITY**

Investigation of the initial condition of residential and other structures was necessary in order to define the maximum allowed ground vibrations intensity. It is commonly adopted that the best descriptor of the ground vibrations intensity is peak particle velocity or short PPV.

Various studies were performed during the last several decades in order to correlate PPV and damage to structures and the results are well elaborated in various sources. In short, damage threshold is probable at PPV of 12,7 mm/s, limit damage level is set to 51 mm/s and PPV higher than 254 mm/s can cause damage in reinforced concrete.

Since Serbia does not have standard covering blast induced ground vibrations maximum allowed PPV was set in accordance with German DIN 4150. In accordance with DIN 4150 and PPV/damage correlation maximum allowed PPV was set to 10 mm/s for residential structures in the proximity of Cerovo 1 and Cerovo 2 and to 30 mm/s for railroad tunnel considering it being a robust, reinforced concrete structure.

### **DEFINITION OF THE PROPAGATION LAW**

In order to be able to predict the intensity of future ground vibrations it was necessary to define the propagation law. Propagation law is in fact a dependency of ground vibrations of the explosive charge per delay and distance from the blast. In order to define the propagation law it was necessary to perform test blasts and measure the intensity of generated ground vibrations. The measurements were performed by RGF and the results are presented in a form of Elaborate [1]. The final result of the measurements was the propagation law in the form

$$PPV = K \left( \frac{d}{\sqrt{Q}} \right)^{-n} = 248.4 \left( \frac{d}{\sqrt{Q}} \right)^{-1.24}, \text{ mm/s} \quad (1)$$

Where  $d$  is the distance to the blast and  $Q$  is explosive charge per delay.

### DEFINITION OF CONTROLLED BLASTING ZONES

According to the blast design from the mine design the blasting would be performed on the 15 m high benches, using 460 kg of ANFO or 550 kg of Slurry charged into 250 mm diameter blastholes. Based on these data and the propagation law it was possible to calculate the distance from the pit to which the structures will be affected by ground vibrations with PPV higher than 10 mm/s. The distance was calculated as

$$d = \sqrt{Q} \cdot \left( \frac{K}{PPV} \right)^{\frac{1}{n}}, \text{ m} \quad (2)$$

Once the appropriate values were introduced to equation (PPV=10 mm/s, Q=550 kg, K=248,4 and n=1,249) the affected distance was 312 m. With the closes house being at a distance of 270 m from the Cerovo 1 pit outline and it was necessary to redefine the blasting parameters.

In order to protect the residential structure from possible damage it is necessary to prevent PPV of ground vibrations to exceed the value of 10 mm/s. Having this in mind a safe zone limit of 10 m/s maximum PPV was set as shown in figure 1.

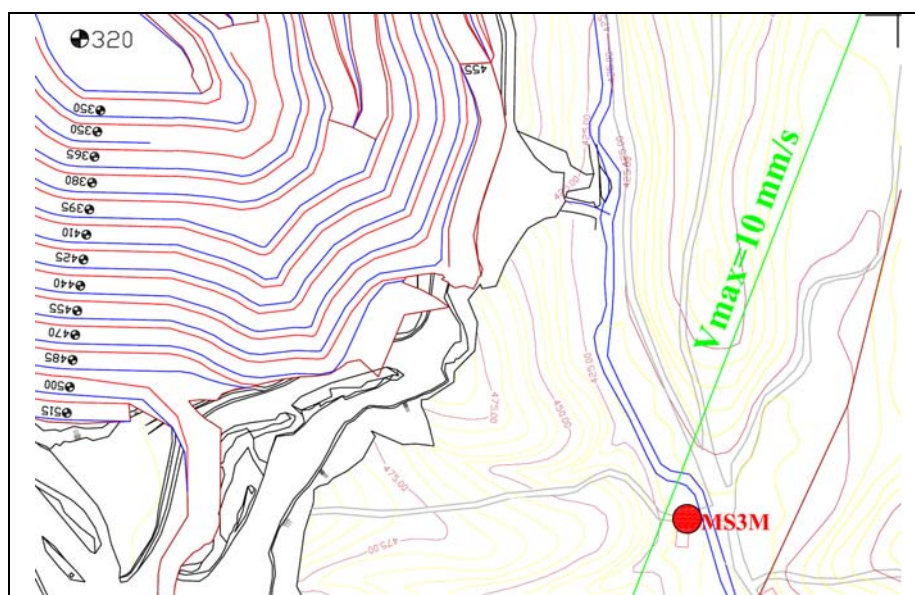


Figure 1. Safe zone limit at 10 mm/s max. PPV

In the similar manner, Cerovo 2 blasting operations had a limiting factor in the nearby railroad tunnel. Here, due to reinforced concrete structure having higher resistivity to vibrations a limit PPV was set to 30 mm/s.

Since the affected zone limit was fixed it was necessary to define controlled blasting, that is to calculate maximum explosive charge per delay in a way that generated ground vibrations do not exceed 10 mm/s for Cerovo 1 and 30 mm/s for Cerovo 2 beyond the affected zone limit.

Drilling equipment in use can drill blastholes with diameters 250, 130 and 85 mm and these diameters were considered in blast design revision. Besides the diameter reduction the controlled blasting design considered reduction of the charge per delay through the introduction of split column charges and possible variations of three possible diameters and a maximum of four split deck charges are given in table 1.

**Table 1.** Possible configuration of explosive charges

Diameter mm	Total charge length m	Explosive charge per 1 m kg	Charge weight per deck for decked charges kg			
			1	2	3	4
85	12	6	73	34	23	16
130	12	15	175	73	49	33
250	10	55	550	216	144	94

Based on the results from Tab. 1 it was concluded that decked charges would be necessary only at one narrow zone at Cerovo 1 and that in the rest of Cerovo 1 and at Cerovo 2 there will be no need for decked charges application and that blasts can be controlled through hole diameter reduction. Despite the common opinion (which authors share) that split charges have the best results in ground vibration control, the decision to use unpopular method of blasthole reduction in this particular situation is justified as:

- a) Splitting (decking) charges requires more time and effort;
- b) decked charges are more costly since each deck must be initiated by its own NONEL tube;
- c) there is higher probability of error during wiring.

Consequently, four configurations were accepted for further consideration: 250 mm single charge, 250 mm two decks, 130 mm single charge and 85 mm single charge (Tab.2)

**Table 2.** Accepted controlled blasting parameters

Diameter mm	Charge weight per deck for decked charges kg			
	1	2	3	4
85	73	-	-	-
130	175	-	-	-
250	550	223	-	-

Once the parameters of controlled blasting were defined it was necessary to define the zones within which these parameters will be used i.e. controlled blasting zones. The



calculations were performed utilizing Eq. 2 and the results are 3 zones of controlled blasting at both pits. Unusual situation, from the aspect of ground vibrations prevention, occurred at Cerovo 1 where it was possible to, in some areas of the pit, increase charge weight per delay without ground vibrations exceeding the safe limit. Calculations showed that it is possible to detonate two explosive charges i.e. 1 100 kg of Slurry simultaneously and PPV of ground vibrations at the location of the nearest structure will be below 10 mm/s.

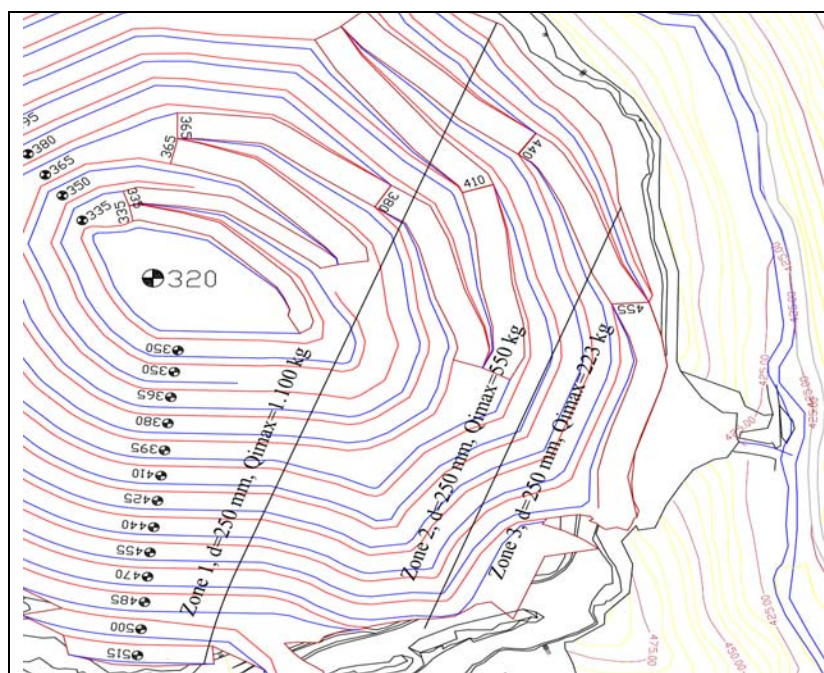
The distance of the specific zone from the pit outline is given in Tab. 3 and Tab 4. and the zones are presented in Fig. 2 and Fig 3.

**Table 3.** Controlled blasting zone distances at Cerovo 1

Zone	Charge weight kg	Distance from the pit outline m
3	223	0 – 75
2	550	75 – 200
1	1 100	Beyond 200

**Table 4.** Controlled blasting zone distances at Cerovo 2

Zone	Charge weight kg	Distance from the pit outline m
3	73	0 – 30
2	175	30 – 85
1	550	Beyond 85



**Figure 3.** Controlled blasting zones at Cerovo 1

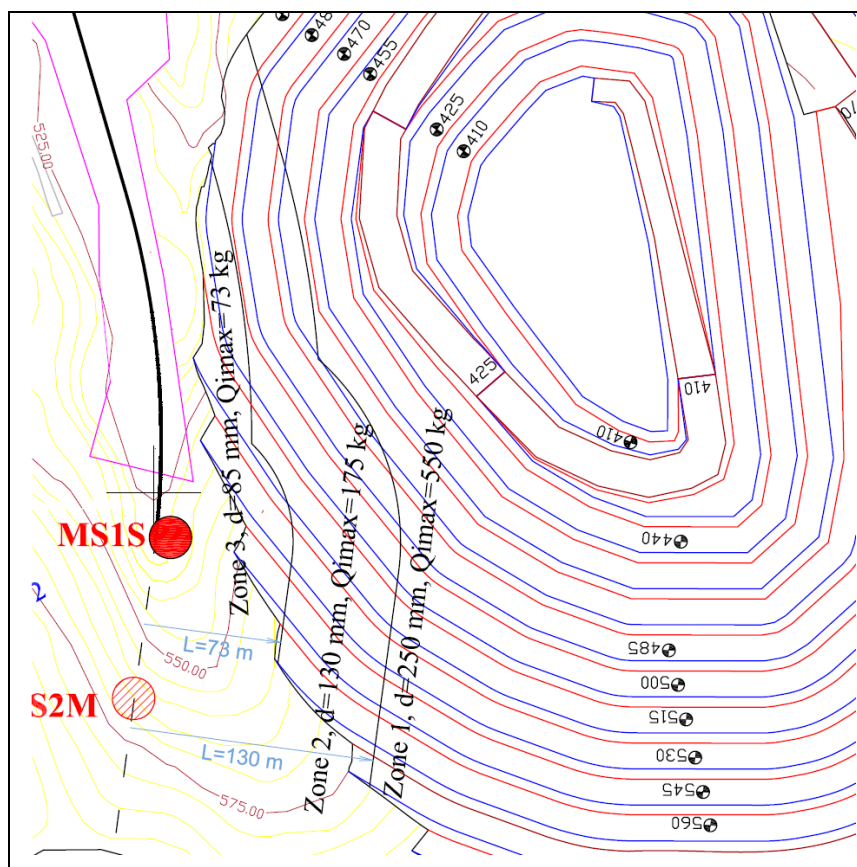


Figure 4. Controlled blasting zones at Cerovo 2

## CONCLUSION

Due to concerns that blasting generated ground vibrations could cause damage to the structures in the proximity of Cerovo pits it was necessary to revise the blast design and define controlled blasting parameters. After taking into consideration all of the influential factors, primarily the condition and the type of the affected structures seven zones with corresponding blasting parameters were defined. In addition, a monitoring system is designed in order to monitor the intensity of ground vibrations for further actions in terms of blasting parameters adjustments.

## REFERENCES

1. Faculty for mining and geology, Elaborate on seismic measurements during experimental blasts at Cerovo, (Original title in Serbian: Elaborat o merenjima

- seizmičkih potresa pri izvođenju eksperimentalnih miniranja na površinskom kopu „Cerovo“), Belgrade, 2014
2. Technical faculty in Bor, Elaborate on initial state of structures in the proximity of Cerovo 1 and 2 copper mines, (Original title in Serbian: Elaborat o „nultom“ stanju oštećenja objekata u zoni seizmičkog uticaja miniranja na površinskim kopovima Cerovo 1 i 2), Bor, 2014
  3. Technical faculty in Bor, Design of monitoring of blasting influences to structures within the affected zone of open pit mines Cerovo 1 and Cerovo 2s (Original title in Serbian: Projekat monitoringa uticaja miniranja na građevinske i stambene objekte u zoni uticaja miniranja na površinskim kopovima Cerovo 1 i Cerovo 2), Bor, 2014



## ANALYSIS OF AIR POLLUTION FROM POINT SOURCES ON THE EXAMPLE OF STEEL PLANT SMEDEREVO

Stevo Jacimovski<sup>1\*</sup>, J. Setrajcic<sup>2</sup>, R. Radovanovic<sup>1</sup>, S. Miladinovic<sup>1</sup>

<sup>1</sup>Academy for Criminalistic and Police Studies, SERBIA

<sup>2</sup>University of Novi Sad, Faculty of Science, Department for physics,  
Novi Sad, SERBIA

\* [stevo.jacimovski@kpa.edu.rs](mailto:stevo.jacimovski@kpa.edu.rs)

### ABSTRACT

Air pollution from point sources (boiler stacks, industrial plants...) is particularly important. It is surely of our interest to analyze the emission of pollutants from our only steel plant Smederevo. The aim of this work is to represent the obtained air pollution distribution results from most common gases (SO<sub>2</sub>, NO<sub>x</sub>, CO), at different distances from the steel plant. Gaussian model for assessment the dispersion of gaseous materials and suspended particles has been used in the analysis. The complex coefficient of air pollution has also been analyzed.

**Key words:** air pollution, steel plant Smederevo, Gaussian model, Screen 3.

### INTRODUCTION

Steel Plant Železara Smederevo is an industrial complex located 7 kilometers southeast of Smederevo on the area of 350 hectares. It represents the most significant segment of Smederevo's development (74% of total production and 97% of exports) in the field of ferrous metallurgy, production of cast iron and steel. Specific type, large amount and production methods create major environmental pressure on its surroundings, which contributed to the highest level of environmental hazard in this area. With the production of 2.2 million tons per year over 70 billion m<sup>3</sup> waste gases (about 32 000 m<sup>3</sup> per ton of produced and processed steel, or 8.2 million m<sup>3</sup> per hour) is emitted into the air. 89 emitters are registered in Smederevo Steel Plant: 34 in Sintering plant, 8 in Blast furnace 1 and 2, 32 in Steel plant, 4 in Hot rolling mill, 10 in Cold rolling mill, 1 in the Power plant (Group of authors 2007). Besides the above mentioned emitters, The Steel Plant has also got 5 ore and secondary raw materials landfills which belong to specific pollutants(contaminants), actually, ground-level emitters of great amounts of dust which pollute the air of nearby settlements. Until the year 2005 continual measurements had not been done, but only individual measurements on individual emitters. Measurements were conducted by the Institute „1st May“ from Nis. At the end

of year 2005, „U.S.Steel Serbia“ started the measurements in accordance with the Regulations on limit values of emissions, the method and terms of measurements and data recording. Measurements were carried out by the Department of Public Health „Pomoravlje“ from Cuprija.

Since 2007, three automatic air quality monitoring analysers have been installed, one in the city centre and two in the immediate surrounding of the Steel Plant (Radinac and Rajla). In this way a comprehensive study of environmental quality and its impact on the health of the population has begun. Besides with pollutants in waste gases there is 25 000 tons of Carbon monoxide (CO), 10 000 tons of Sulphur dioxide (SO<sub>2</sub>), and approximately 1500 tons of Nitrous oxide (NO<sub>x</sub>). The waste gas also contains dust whose amount depends on the quality of input raw materials and technological process.

It was calculated that the production and processing of one ton of iron, produces about 100-120 kg of dust, sludge and scale, which means that during the production of 2.2 million tons of iron, 200 000 tons of dust is released into the atmosphere every year. Not all emitters have multistage purification, because waste gases are not used, but released into the atmosphere (Group of authors, 2006).

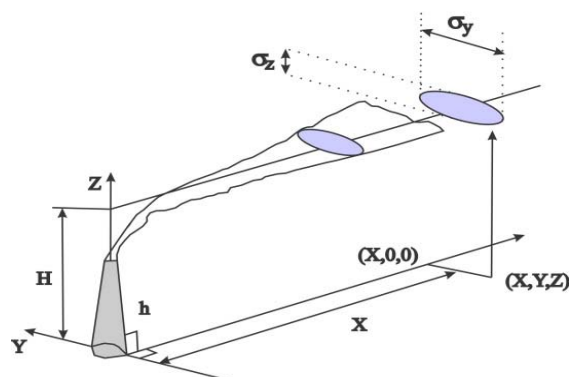
#### CALCULATION MODEL FOR MAXIMUM CONCENTRATION OF AIR POLLUTION

Determining the state of air pollution by applying mathematical model of air pollution distribution enables the simulation of spreading of harmful substances for different assumed emission intensities in known topological, urban and meteorological situation.

Gaussian statistical method for assessment of ground dispersion of gaseous substances, for certain values of gaseous substances emissions and parameters related to external environment. The basis of this model is the assumption that admixtures emitted by continuous point source form a smoke column where symmetrical distribution of the concentration of particles in relation to the axis of the smoke column is observed. The basic equation of statistical Gaussian model is made up of two probability functions of normal laws and have the form (Lazaridis 2011).

$$C(x, y, z) = \frac{Q}{2\pi\sigma_y(x)\sigma_z(x)\bar{u}} \exp\left(-\frac{y^2}{2\sigma_y^2(x)}\right) \left\{ \exp\left[-\frac{(z-H)^2}{2\sigma_z^2(x)}\right] + \exp\left[-\frac{(z+H)^2}{2\sigma_z^2(x)}\right] \right\} \quad (1)$$

where  $Q$  – is mass flow;  $C$ –concentration of admixtures in a space point;  $\sigma_y(x)$ ,  $\sigma_z(x)$  diffusion dispersion in the direction of appropriate axis, which depend on meteorological conditions and the distance which the substance carry out from the source to the point with the coordinate  $x$ , where the direction of the axis  $OX$  is assumed to match the direction of wind vector;  $\bar{u}$  - average wind velocity on the measuring level;  $H$  – effective source height



**Figure 1.** Graphical display of smoke column from the source (Jaćimovski, 2013)

In the equation (1)  $\sigma_y, \sigma_z$  are horizontal and vertical dispersion of admixture distribution. For determining these dispersions the following relations are used.

$$\sigma_y = \alpha x^a; \sigma_z = \beta x^b$$

where  $\alpha, a, \beta, b$  are coefficients which depend on atmosphere stability and the relief of the surface and are experimentally determined. (Lazaridis, 2011).

With analyses of influence of steel plant Smederevo on air quality (average hourly concentrations) software of American Environmental Protection Agency SCREENVIEW 3.5.0, license number E474AA382E2AE61A has been used. For calculation of sulphur oxide concentration the following input values have been used:

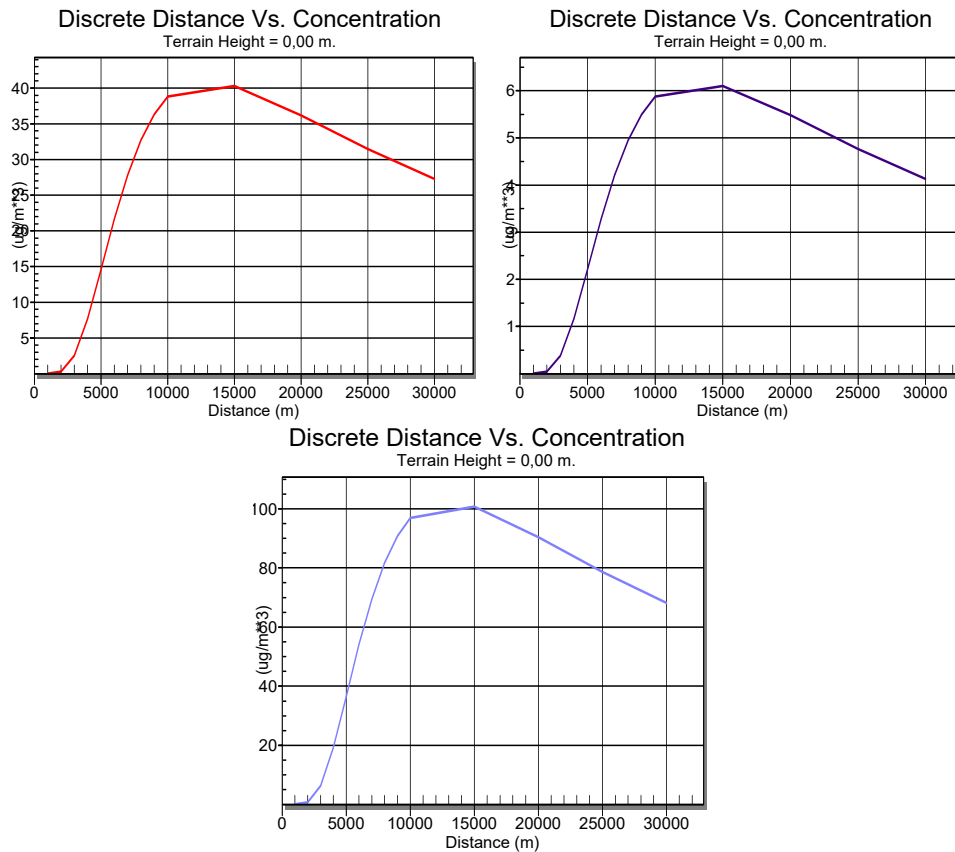
1. Stack height
2. Inner diameter of the stack
3. Mass flow and the speed of flue gases at the exit point
4. The temperature of flue gases at the exit point
5. Characteristics of the terrain around the steel plants (rural and urban areas, absolute height, topographical characteristics)
6. Atmosphere condition concerning the stability and speed of the wind

**Table1.** Adopted parameters for calculation of distribution of gases SO<sub>2</sub>, NO<sub>x</sub>,i CO

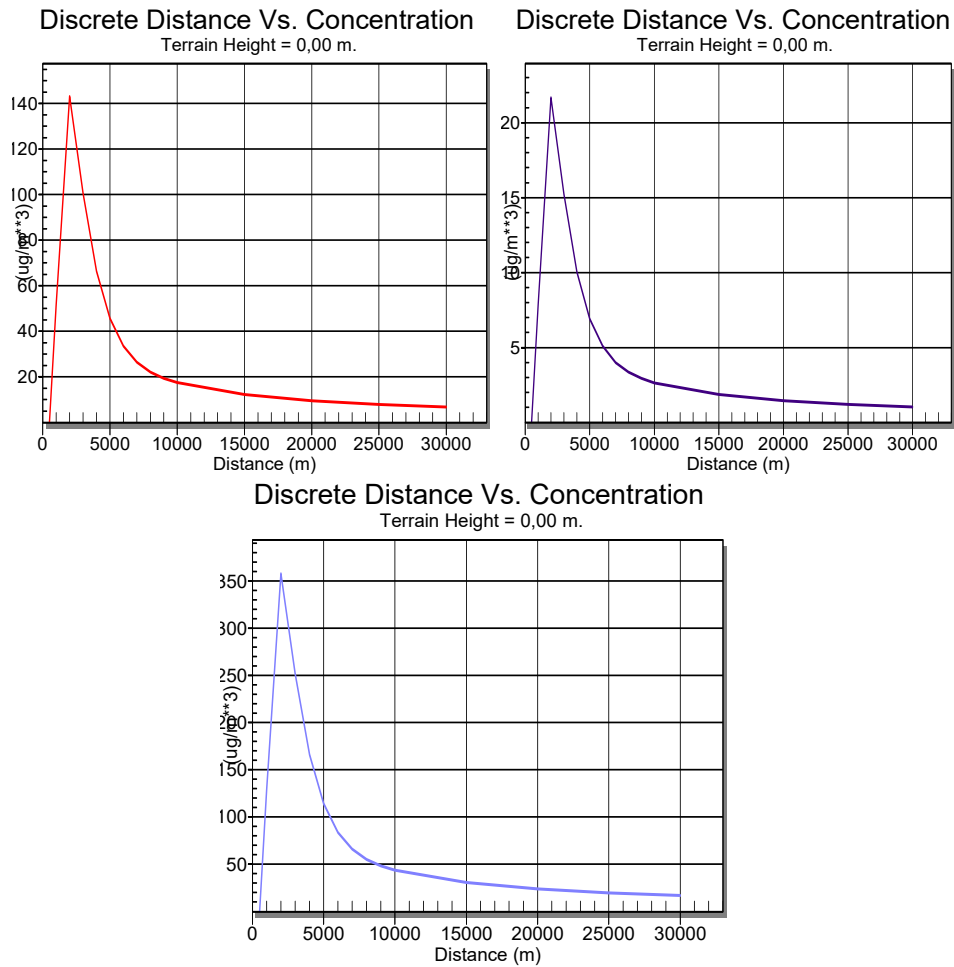
PARAMETER	STEEL PLANT SMEDEREVO
Stack height [m]	152
Inner diameter of the stack[m]	6,5
The temperature of flue gases at the exit [°K]	600
Mass flow SO <sub>2</sub> [g/s]	317
Mass flow NO <sub>x</sub> [g/s]	48
Mass flow CO[g/s]	793
Ambient temperature [°K]	293
The speed of gas at the exit of the stack [m/s]	2,6

According to the annual report of the Republic hydro-meteorological agency for the year 2015, in Smederevo stability class D and B prevailed. With calculations it has been adopted that the terrain is characterized by lowland and plain features. In this work it is also adopted that steel plant Smederevo is situated in rural area.

After the analysis for stated parameters the results are as follows

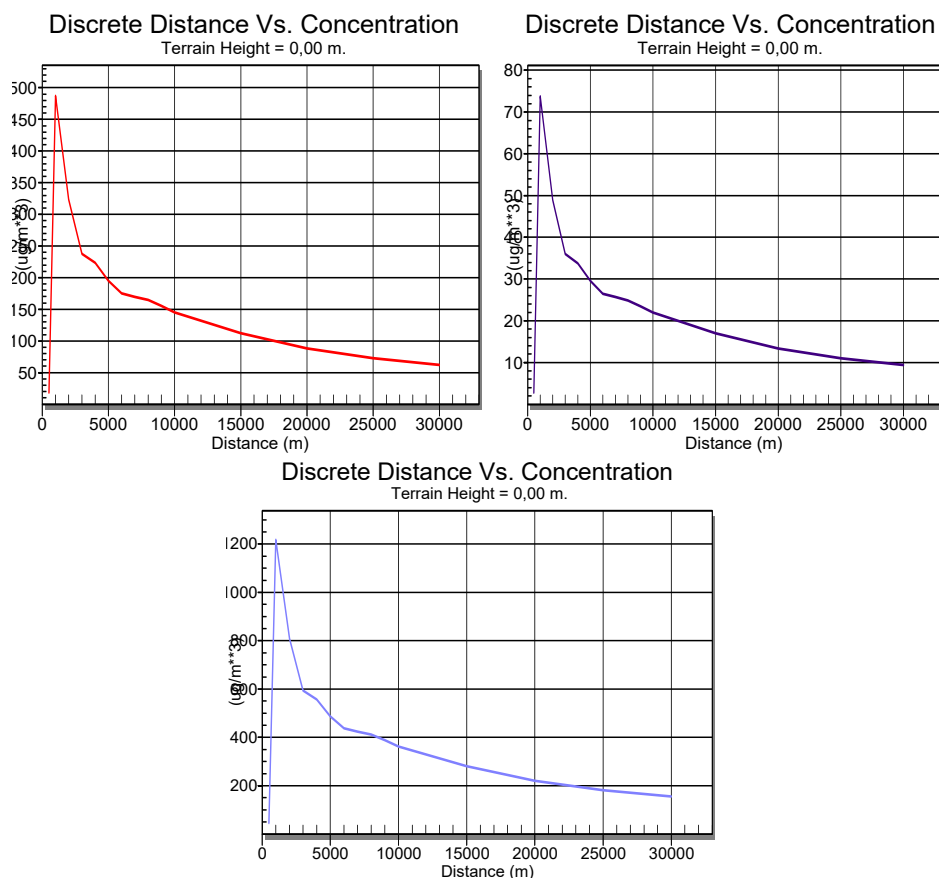


**Figure 2.** 24 – hour distribution of concentration of SO<sub>2</sub>(left), NO<sub>x</sub> (right) i CO (below) in the function of distance from the source for the stability class D and wind speed of 4 m/s



**Figure 3.** 24 – hour distribution of concentration of SO<sub>2</sub>(left), NO<sub>x</sub> (right) and CO (below) in the function of distance from the source for the stability class B (right) and wind speed of 4 m/s s





**Figure 4. 24** – hour distribution of concentration of SO<sub>2</sub>(left), NO<sub>x</sub> (right) and CO (below) in the function of the distance from the source for complex atmospheric conditions with wind speed of 4m/s

#### ANALYSIS OF THE RESULTS

In this work distribution of concentration of SO<sub>2</sub>, NO<sub>x</sub> and CO for two stability classes D and B, the same (prevailing) wind speed and the same temperature has been analyzed. In graph 2 distribution of concentration for stability class D (neutral), and wind speed of 4 m/s and 293 K is presented. Maximum concentration is at about 1500m from the source for all three types of gases and is around 40,29 µg/m<sup>3</sup>, 6,1 µg/m<sup>3</sup> i 100,7 µg/m<sup>3</sup>, respectively, which is considerably lower from permitted limit values. For stability class B (unstable), the same wind speed of 4 m/s, concentration of SO<sub>2</sub> has maximum at distance of 1000 m from the source and that maximum is approximately 143,2 µg/m<sup>3</sup>, concentration of NO<sub>x</sub> has maximum at distance of 2000 m and is 21,69 µg/m<sup>3</sup>, concentration of CO has maximum also at 2000m and is 357,8 µg/m<sup>3</sup> (Graph 3).

It can be seen that, in case of unstable meteorological conditions, maximum concentration moves away from the source and has higher values.

For complex case, when stability classes, wind speed as well as outside temperature change, distribution of concentration of SO<sub>2</sub>, NO<sub>x</sub> i CO is represented in picture 3. Maximum concentration of all three gases is at 1000 meters from the source and is 487µg/m<sup>3</sup> for SO<sub>2</sub>, for NO<sub>x</sub> maximum concentration is 73,74µg/m<sup>3</sup>, and for CO maximum concentration is 1217µg/m<sup>3</sup>. Therefore, maximum concentration are considerably higher than in previously analyzed cases and are reached at distance closer to the source (Graph 4).

Calculation of total concentration of air pollution, which comes from different sources and from more components, is a complex problem. Total concentration of homogenous substances which come from different sources is obtained by simple summation, which is in table 3, for different components, given as C<sub>1</sub>, C<sub>2</sub> and C<sub>3</sub>, then for all components reduced coefficients are found. (Vnukov A.K, 1992).

$$K_i = C_i / GV_i; i = 1, 2, 3$$

Here  $GV_i$  are limit values for appropriate components. The resulting pollution of atmosphere with simultaneous functioning of more components is determined by

complex coefficient 
$$P = \sqrt{\sum_{i=1}^3 K_i^2}$$

**Table 2.** 24 – hour distribution of concentration of different components dependant on the distance from the source

Distanc [km]	Concentrat. C <sub>1</sub> SO <sub>x</sub> [µg/m <sup>3</sup> ]	Concentrat. C <sub>2</sub> NO <sub>x</sub> [µg/m <sup>3</sup> ]	Concentrat. C <sub>3</sub> CO [µg/m <sup>3</sup> ]	K <sub>1</sub> =C <sub>1</sub> /GV <sub>1</sub>	K <sub>2</sub> =C <sub>2</sub> /GV <sub>2</sub>	K <sub>3</sub> =C <sub>3</sub> /GV <sub>3</sub>	P
1	487	73,4	1217	3,2467	0,8635	0,2434	10,5674
2	323,5	49	808,3	2,1567	0,5765	0,1617	4,6631
3	237,8	36,01	594,2	1,5853	0,4236	0,1188	2,5197
4	223,1	33,78	557,4	1,4873	0,3974	0,1115	2,2178
5	195	29,53	487,2	1,3000	0,3474	0,0974	1,6943
6	175	26,5	437,3	1,1667	0,3118	0,0875	1,3646
7	169,5	25,67	423,6	1,1300	0,3020	0,0847	1,2802
8	164,4	24,89	410,8	1,0960	0,2928	0,0822	1,2043
9	155,2	23,5	387,8	1,0347	0,2765	0,0776	1,0733
10	144,8	21,92	361,8	0,9653	0,2579	0,0724	0,9342
15	112,1	16,97	280	0,7473	0,1996	0,0560	0,5599
20	88,12	13,34	220,2	0,5875	0,1569	0,0440	0,3460
25	72,58	11	181,3	0,4839	0,1294	0,0363	0,2347
30	61,93	9,38	154,7	0,4129	0,1104	0,0309	0,1709

The dependence of complex coefficient  $P$  on number of pollutants and the level of pollution is known from literature (Vnukov A.K.,1992). The dependence is represented in Table 4.

**Table 3.** Values of complex coefficient  $P$  on number of pollutants and level of pollution

Level of atmosphere pollution	Broj zagađivača			
	2-3	4-9	10-20	Preko 20
<b>I permitted</b>	2	3	4	5
<b>II weak</b>	2,1-4	3,1-6	4,1-8	5,1-10
<b>III moderate</b>	4,1-8	6,1-12	8,1-16	10,1-20
<b>IV strong</b>	8,1-16	12,1-24	16,1-32	20,1-40
<b>V very strong</b>	>16	>24	>32	>40

For the analyzed case in the work we can see that the level of pollution is strong 2 km from the source, moderate at distance of 3 km, weak at distances to 5 km and permitted at greater distances. Total coefficient  $P$  is 5,5647 for the analyzed case, which indicates moderate air pollution.

### CONCLUSION

Smederevo is a settlement with highly polluted environment ( The assembly of Smederevo, 2012). Without taking certain measures significant improvements and enhancement of environmental quality cannot be expected. The main priority that would contribute to reducing air pollution by typical and polluting matters and their elimination from the air is setting of air polluters cadastres in the city of Smederevo. In this way an insight can be provided into the air quality condition at any time. This especially applies to Smederevo Steel Plant, which is a dominant source of air pollution. Based on the cadastre meteorological diffusive model of pollution for the entire city territory can be made, based on which the procedures in case of accidents and excessive pollution can be defined. Also, air protection from the harmful effects of pollutants is achieved through control over facilities and equipment which can contaminate the air, and emission limitation is included to the limits stipulated by the Regulations on limit values, the method and terms of measuring and recording data, taking technological and other necessary measures for emission reduction, as well as monitoring the impact of air pollution on human health and the environment (Group of authors, 2006). The city of Smederevo in its further development must rely on an ecological component and the general principle of sustainable development, because in this way it can be closer to European standards, which can create opportunities and access to the EU funds and development loans (Group of authors, 2007).

### *Acknowledgement*

*This work is done within the project TR 34019 of the Ministry of Education and Science of Republic of Serbia*

## **REFERENCES**

1. Group of authors: Local ecological action plan of Smederevo municipality, Directorate of Construction, Urban Planning and Construction Land Smederevo, (2007) pp. 25-83.
2. Group of authors: Spatial plan of the city of Smederevo 2020. Strategic assessment of the environmental impact – report, Directorate of Construction, Urban Planning and Construction Land Smederevo, Department of urban planning, Smederevo, (2006) pp. 46-115.
3. Lazaridis M.: First principles of Meteorology and Air Pollutant, Springer, New York, (2011) pp.201-232.
4. Jaćimovski S., Miladinović S. Radovanović R. Ilijazi V.: Distribution of the concentration of sulphur dioxide into the atmosphere from point source, International conference Ecology of urban areas 2013, Zrenjanin, University of Novi Sad, Technical Faculty Mihajlo Pupin, (2013) pp 50-58.
5. The Assembly of Smederevo: Report on environmental situation in the city of Smederevo, (2012).



**AIR POLLUTION ANALYSIS OF STEEL PLANT ZELEZARA  
SMEDEREVO AND THERMAL POWER PLANT KOSTOLAC AND  
ASSESSMENT OF ENVIRONMENTAL IMPACT ON SMEDEREVO-  
POZAREVAC DANUBE REGION**

**Slobodan Miladinovic\*, S. Jacimovski**

Academy of criminalistic and police studies, Belgrade, SERBIA

*\*slobodan.miladinovic@kpa.edu.rs*

**ABSTRACT**

Smederevo-Pozarevac Danube region covers an area of 968km<sup>2</sup>, with population of 200000 inhabitants. Negative microclimate alterations are the result of impact of Steel Plant "Zelezara Smederevo" and Kostolac Thermal Power plants. The Steel plant and power plants emit substantial amounts of SO<sub>2</sub>, NO<sub>x</sub>(NO<sub>2</sub>), Co, ash and dross into the air. Applying the Gaussian model to calculate ground concentration of air pollution, we have calculated total concentrations of air pollution and determined distances to which increased pollution stretches. While calculating pollution in Kostolac thermal energy basin we have also applied Pasquill-Gifford atmospheric stability classification and SCREEN3 model defined by EPA (US Environmental Protection Agency).

**Key words:** Steel plant "Zelezara Smederevo", Kostolac basin, air pollution, air quality, environment

**THE IMPACT OF "ZELEZARA SMEDEREVO" AND "TPP  
KOSTOLAC" ON THE STATE AND QUALITY OF THE  
ENVIRONMENT**

Steel Plant Železara Smederevo is an industrial complex located 7 kilometers southeast of Smederevo on the area of 350 hectares. It represents the most significant segment of Smederevo's development (74% of total production and 97% of exports) in the field of ferrous metallurgy, production of cast iron and steel. It is characterised by high techno-economic and spatial characteristics regarding water consumption, waste water discharges, electrical energy consumption, large-scale transport, with stressed productive link within intra-regional (Republic) and trans-regional spatial dimension. The steel plant emits over 70 billion m<sup>3</sup> waste gases (about 32 000 m<sup>3</sup> per ton of produced and processed steel, or 8.2 million m<sup>3</sup> per hour) into the air. 89 emitters are registered in Smederevo Steel Plant: 34 in Sintering plant, 8 in Blast furnace 1 and 2, 32 in Steel plant, 4 in Hot rolling mill, 10 in Cold rolling mill, 1 in the Power plant (group of authors(2007)). Besides the above mentioned emitters, The Steel Plant has also got 5 ore

and secondary raw materials landfills which belong to specific pollutants(contaminants), actually, ground-level emitters of great amounts of dust which pollute the air of nearby settlements. Along with pollutants in waste gases there is 25 000 tons of Carbon monoxide (CO), 10 000 tons of Sulphur dioxide (SO<sub>2</sub>), and approximately 1500 tons of Nitrous oxide (NO<sub>x</sub>). In the waste gas there is also dust whose amount depends on the quality of input raw materials and technological process. Since 2007, three automatic air quality monitoring analysers have been installed, one in the city centre and two in the immediate surrounding of the Steel Plant (Radinac and Rajja). In this way a comprehensive study of environmental quality and its impact on the health of the population has begun. The state of the atmosphere and the quality of the environment in the Kostolac basin are mainly the result of the impact of industrial facilities of the company Thermal Power Plants and Mines Kostolac. Major changes in environmental quality are caused by coal combustion in boilers of thermal power plants, the creation of dust from open pits, Drmno, Ćirikovac and Klenovik and disposal of slag and ash. About 9 million tons of coal is combusted and more than 2 million tons of ash is deposited annually in boilers of Kostolac Thermal Power Plants (Report of the Service for Environmental Management of the Thermal Power Plant and Open Pit Mines Kostolac, 2012).

The greatest changes have been caused by emission of flue gases, dust substances and by ashes and slag production. Thermal Power Plants Kostolac with their emission of pollutants, primarily flue gas and ash, represent dominant source of air pollution. Flue gas also contains solid substances which are the product of incomplete fuel combustion, such as soot and mineral components in the fuel (ash). The most common element in flue gas is sulphur dioxide with quantity of about 97%.

#### **ANALYSIS OF CALCULATION OF MAXIMUM CONCENTRATION OF AIR POLLUTION**

Determining the state of air pollution by applying mathematical model of air pollution distribution enables the simulation of spreading of harmful substances for different assumed emission intensities in known topological, urban and meteorological situation. The real picture of events related to pollutants dispersion is obtained by using the mathematical model, which can be used as a basis for assessing the potential risks and resolving technical protection system. Using the model, we have calculated at which distances from the stack of blast furnace in the Steel plant (there) is maximum concentration of SO<sub>2</sub> and how high it is. The procedure for finding ground concentration of harmful gaseous substances, listed in this section, is the part of the standards which are used in engineering practice during the plant designing with emissions of harmful substances. The aim of the standard is to assess how high the emission of harmful gases is for the appropriate installed power (and other source characteristics) and their accordance with legal regulations. The procedure has been performed in accordance with empirical and theoretic models which are used in the field of air pollution. (Vnukov A.K. 1992). The maximum value of ground-level concentration of harmful substances in (mg/m<sup>3</sup>) in case of exhaust of gaseous substances from a single point source with round

opening, in the event of adverse weather conditions, at the distance of  $x_M$  (m) from the source is:

$$c_M = \frac{AMFm\eta}{H^2 \sqrt[3]{V_1 \Delta T}}, \quad (1)$$

where  $A$  is the coefficient which depends on temperature stratification of the atmosphere;  $F$  is dimensionless coefficient which reflects the speed of deposition of harmful substances in the atmosphere;  $M$ (g/s) is the mass of ejected harmful substances into the atmosphere per time unit;  $m$  and  $n$  are coefficients which characterise the conditions of release of harmful substances from the openings of the source;  $H$ (m) is the height of sources of harmful substances above the earth's surface;  $\eta$  is dimensionless coefficient which characterises the impact of terrain on harmful substances spreading;  $\Delta T$ ( $^{\circ}C$ ) is the difference of temperatures of gas mixture coming from the sources and the temperature of ambient air;  $V_1$ ( $m^3/s$ ) gases expense which is determined by the formula

$$V_1 = \frac{\pi D^2}{4} w_0 \quad (2)$$

where  $D$ (m) is the diameter of source opening,  $w_0$ ( $m/s$ ) average speed discharge of harmful substances in gaseous state from opening at the source. The calculated concentration of gas refers to 24 hour time period after the emission from the stack. The height of the stack of Steel Plant Smederevo is 150.2 m, width of the stack at the top is 6.5m. Average height above the sea level of the city territory is 120.7 m, the lowest point has a height of 69m, and the highest has 273 m. Adopted values of the parameters required for the calculation of the maximum ground-level concentrations of  $SiO_2$  and the corresponding distances are:

$$A = 160; F = 1; H = 30.5 m; \Delta T = 150^{\circ}C; \eta = 1; w_0 = 2 m/s; M = 600 g/s$$

Using the formula we find that maximum ground concentration of  $SiO_2$   $c_M = 5.287 mg/m^3$  and that it is located at a distance  $x_M = 1102$  m from the source. Concerning the fact that the most frequent wind is south wind at the average speed of 2,6 m/s, we can say that a concentration of  $SiO_2$   $c_{Mu} = 0.284 mg/m^3$  and that it is realised at the distance of  $x_{Mu} = 3306.5$  m from the source.

According to the Regulation on limit values, immission measuring methods, criteria for establishing the monitoring points and data records (Official Gazette of the Republic of Serbia, No 54/92, 30/00, and 19/2006) permitted immission limit of sulphur dioxide is  $0.15 mg/m^3$ . Based on theoretical calculation of permitted immission limit of sulphur dioxide and permitted emission limit, we can conclude that Steel Plant with its emission of  $SO_2$  in normal weather conditions greatly exceeds emission limit values of sulphur dioxide.

**Table 1.** Annual statistics of hourly values of pollutants SO<sub>2</sub>, NO<sub>2</sub> and soot during the period 1.1.2015-31.12.2015 at measuring point High school Gimnazija (Environmental Agency)

Parameter	SO <sub>2</sub>	NO <sub>2</sub>	Soot
Annual statistics of daily values			
LV	125/m <sup>3</sup> /24h	85/m <sup>3</sup> /24h	50/m <sup>3</sup> /24h
TV	125/m <sup>3</sup> /24h	109/m <sup>3</sup> /24h	75/m <sup>3</sup> /24h
Number of measurements	364	364	364
Minimum	5	6	6
Maximum	222	150	110
Average values	44	49	18
Number of days>LV	12	28	26
Number of days>TV	12	10	9

According to air quality which depends on emissions of sulphur dioxide, nitrous oxides, carbon monoxide, soot, powder substances and others, Smederevo is one of the 10 most polluted cities in Serbia. However, fortunately for the inhabitants, favourable geographical position and atmospheric movements spread out the emitted gas and dust in much larger space, which significantly reduces the percentage of pollutants. By the Wind rose analysis we can conclude that south and southeast wind, known as Kosava, are predominant in Smederevo. Movements of air depression and anticyclons across Pannonia and northern parts of The Velika Morava, slightly reduce air pollution in Smederevo. Nevertheless, based on all that, we can say that air in Smederevo during 2015 belonged to the third category, excessively polluted air.

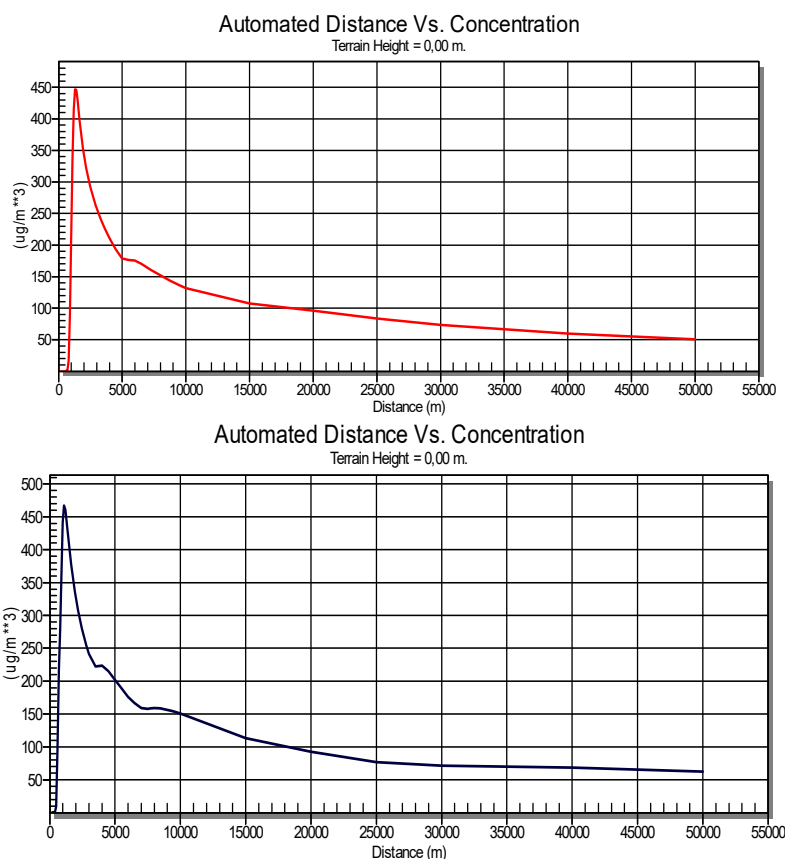
During the analysis of impact of Thermal power plants Kostolac A and Kostolac B on air quality (average hourly concentrations) software of US Environmental Agency SCREENVIEW 3.5.0, licence number E474AA382E2AE61A was used. For calculating concentrations of sulphur oxides and powder substances, the following values have been used: stack height, inner diameter of the stack, mass flow and the speed of flue gases at the exit point, the temperature of flue gases at the exit point, characteristics of the terrain around the power plants (rural and urban areas, absolute height, topographical characteristics) and atmosphere condition concerning the stability and speed of the wind. During modeling for calculating ground-level concentration of air pollution climate elements data for period 1990-2009 were used

**Table 2.** Parameters of production in Thermal power plants Kostolac in December 2008. (J.Djordjevic-Miloradovic 2012)

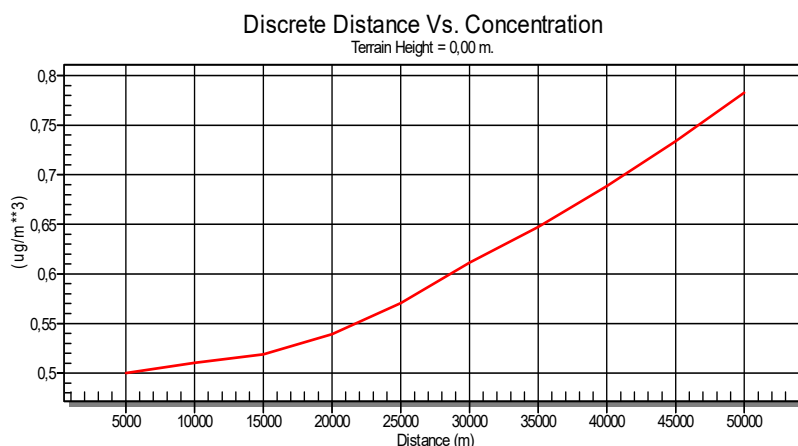
PARAMETER	KOSTOLAC A1	KOSTOLAC A2	KOSTOLAC B
Stack height [m]	105	110	250
Inner diameter of the stack at the exit [m]	5	6,02	9,5
Temperature of flue gases at the exit [°C]	190	200	170
Mass flow SO <sub>x</sub> [g/s]	24,4	403	1410,8
Mass flow NO <sub>x</sub> [g/s]	16,6	33,1	116
Mass flow PM [g/s]	24,4	48,8	170,8



According to monthly report of the republic hydro-meteorological agency, we have calculated that average monthly temperature in December 2008 in Kostolac basin was 3.3°C. In December, the same year, stability class D and class F prevailed. At distances larger than 20 km from the emission source there are no significant heights which would stop or lessen the speed of the pollutants. The researches have shown that physical obstacles can lead to higher concentrations of harmful substances, particularly in conditions of stable atmosphere (stability classes D, E and F). Concerning that the obtained data in this case are primarily determined by plain relief, which means that there are no significant impacts of the terrain. It has also been adopted that thermal power plants Kostolac are in rural area. According to the analysis (Jacimovski and others, 2014) the results for the stated parameters are as follows:



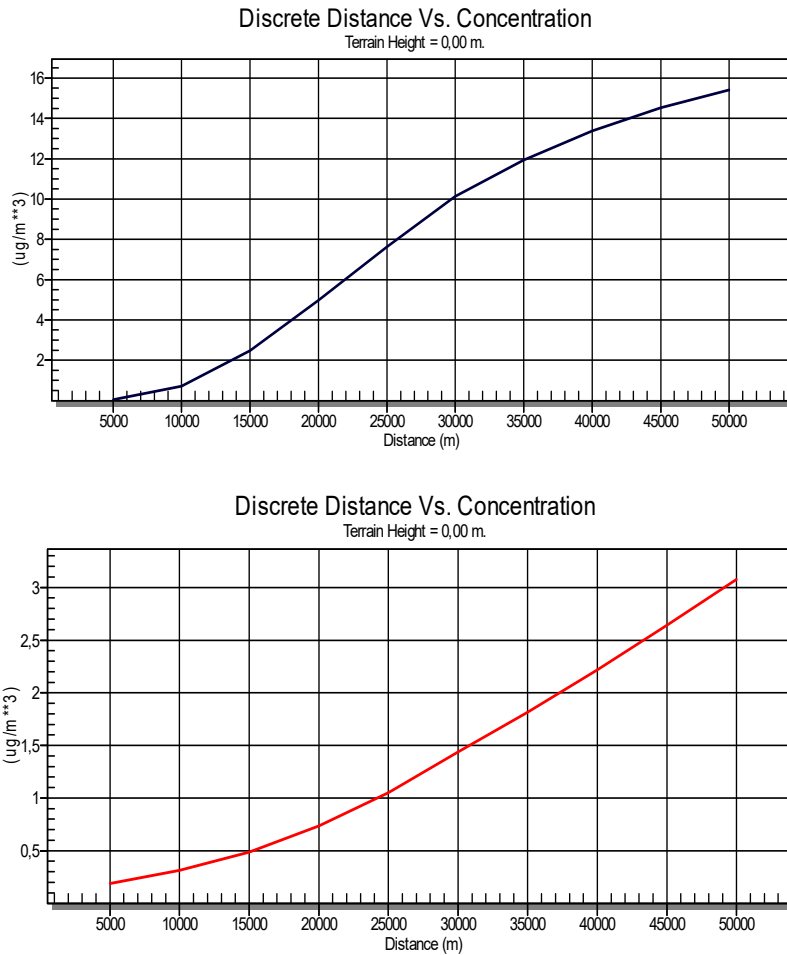
**Figure 1.** Concentration of SO<sub>x</sub> dependant on distances from the source with thermal power plants Kostolac A1 (left) and Kostolac A2 (right)



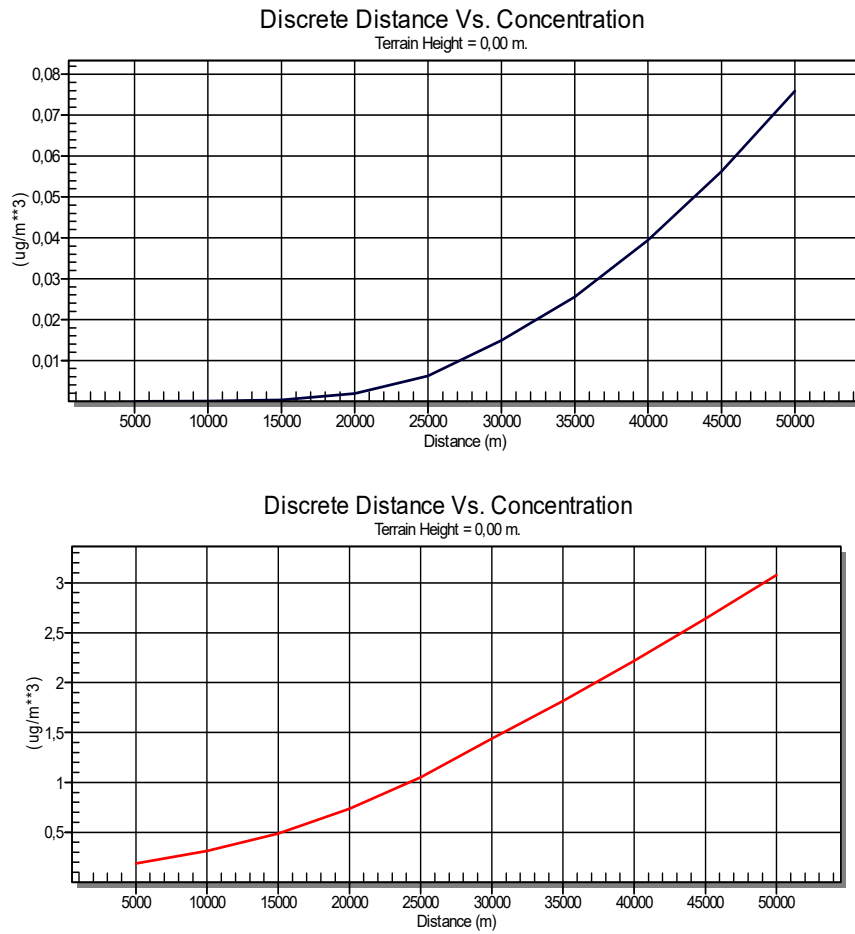
**Figure 2.** Concentration of  $\text{SO}_x$  dependant on distances from source with thermal power plants Kostolac B

From graph 1 it can be seen that with thermal power plant Kostolac A1, maximum concentration of polluting materials is  $85,39 \mu\text{g}/\text{m}^3$  at a distance of 906m from emission source, with thermal power plant A2 maximum concentration is  $467,5 \mu\text{g}/\text{m}^3$  at a distance of 1122m, while with Kostolac B, (graph 2) maximum concentration is  $410,2 \mu\text{g}/\text{m}^3$  at a distance of 1381m. In case of thermal power plant Kostolac A2, concentration of  $\text{SO}_x$  is above the allowed and is  $150 \mu\text{g}/\text{m}^3$  at a distance from 700m to 10000m, and with thermal power plant B at distances from 600m to 7500m. The highest pollution caused by sulphur dioxide emission is in the vicinity of TPP Kostolac A and B, at a distance of 7.5-10 kilometers from the source, in the direction of the dominant wind. The most frequent wind is from southeastern direction, the second most frequent is the wind from eastern direction. That means that these winds carry polluting materials far away into the west and northwest. In that way big cities such as Pozarevac, Smederevo and Pancevo, which normally have certain degree of pollution, particularly Smederevo and Pancevo, are endangered. By analyzing powder and suspended particles, it can be noticed that maximum concentration at thermal power plant Kostolac A1  $46,91 \mu\text{g}/\text{m}^3$  at a distance of 962m, thermal power plant Kostolac A2 emits maximum concentration of  $42,55 \mu\text{g}/\text{m}^3$  at a distance of 1102m, while at thermal power plant Kostolac B maximum concentration is  $49,69 \mu\text{g}/\text{m}^3$  at a distance of 1381m. The limited value for PM particles is  $50 \mu\text{g}/\text{m}^3$ . Single values do not exceed limited values. Total concentration of PM particles is less than allowed at distances greater than 7000m from emission source. High concentration, particularly of fine particles PM-2.5 can have negative influence on human health. Good air quality, with permitted quantity of suspended particles, according to our calculations covers space which is more than 7 kilometers away from the pollution source. Comparisons of influences which certain stability classes have on air quality have also been performed, for different wind velocity and different temperatures. The comparisons have been performed for sulfur oxides sine they account

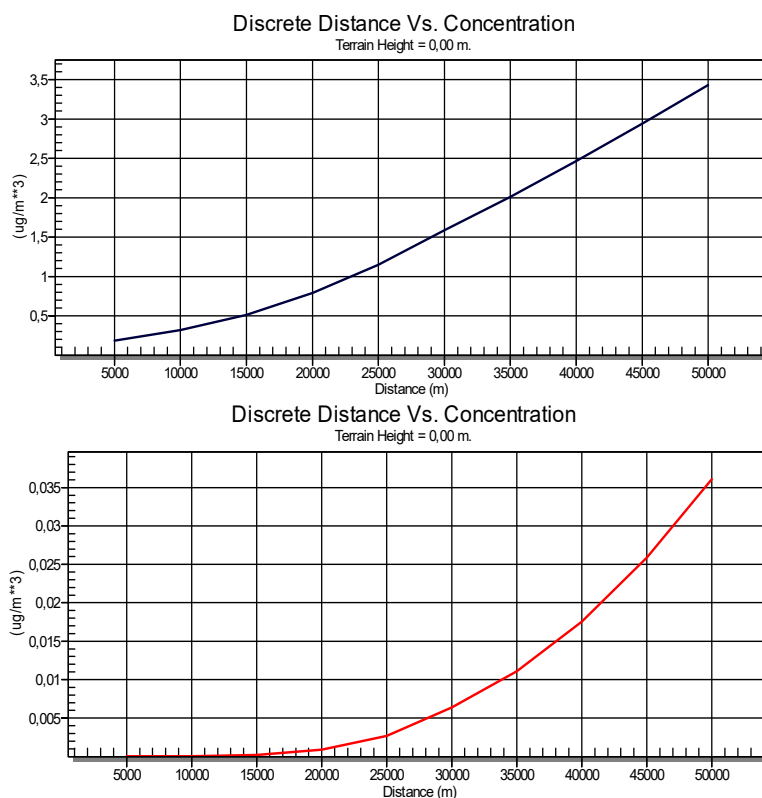
for the largest percentage in flue gas. In December 2008 class D and F of atmospheric stability were the most contained in percentage, so the comparisons have been done for these stability classes.



**Figure 3.** Distribution of  $SO_x$  concentration for stability class D at temperature of 3.3 °C and the wind speed of 1m/s (left) and wind speed of 5m/s (right)



**Figure 4.** Distribution of SO<sub>x</sub> concentration for stability class F at temperature of 3.3 °C



**Figure 5.** Distribution of SO<sub>x</sub> concentration for stability class D at temperature of 3.3 °C (left) and 11,26 °C (right)

In graphs 3 and 4 the increase in air temperature in the environment for the same stability class of atmosphere can be seen, it causes the increase of polluting materials concentration comparing to values at lower temperatures. The air quality decreases during warm weather due to high ozone concentration caused by photochemical effect. Vertical temperature distribution, represents a norm of temperature stability, that is one of the most significant elements which influence on admixture spreading. Although greater wind speed should lead to lower concentrations, the modeling results show the increase of concentration along with wind velocity increase for the same atmospheric stability class. During windy periods Aeolian erosion, rising and spreading of tiny ash fractions occur, which is inadequately deposited which causes the uncontrolled secondary emissions. The measurements have shown that exceeding of sedimentary particles emission is highest in Stari Kostolac and Kostolac, which are closest to the landfill. In case of thermal power plant Kostolac B, the greatest pollutants are surface sources of overburden, open limestone dumps, ash dumps and plaster dump.

Particles from the landfills mostly pollute immediate environment. In graphs 3 and 5 it can be seen that concentration of harmful substances under the same conditions is for stability atmospheric class D(neutral) higher than for class F(very stable).

## **CONCLUSION**

Based on the reported values of substances that make up the quality of the environment in the surroundings of Steel plant “Zelezara Smederevo”, we can conclude that the City of Smederevo is a settlement with highly polluted environment. The main priority that would contribute to reducing air pollution by typical and polluting matters and their elimination from the air, is setting of air polluters cadastres in the city of Smederevo. Also, air protection from the harmful effects of pollutants is achieved through control over facilities and equipment which can contaminate the air, and emission limitation is included to the limits stipulated by the Regulations on limit values, the method and terms of measuring and recording data, taking technological and other necessary measures for emission reduction, as well as monitoring the impact of air pollution on human health and the environment. In order to improve the quality of the environment, additional measures such as the implementation of project of gasification and central heating are needed. Existing boiler houses on liquid and solid fuels, should be, in the near future, converted in the boilers that use gas as a fuel. Renewal, maintenance of existing and growing of new green areas in the city and protection of low and medium green foliage of long growing period in the vicinity of major pollutants.

The problem of pollution from Thermal power plants Kostolac is also evident. It is obvious that that the highest pollution is caused by sulphur oxide components. Total pollution exceeds permitted limited values up to 15 km away from the source for the analysed case. The results are surely even more unfavourable when all the components which cause air pollution are considered, because the deposited substances of Kostolac basin are present in all coal and power production stages. Appearance of floating dust is connected to forming overburdens of open pit mines, grinding and combustion of coal, releasing of particles while coal combustion to the huge production of ash and its storage. One of the most important jobs is the adoption of policies and procedures for air protection by decreasing hazardous materials emission on the pollution source. If limit values of emissions of SO<sub>2</sub> in flue gas are considered, thermal power plants Kostolac, concerning the installed power, must decrease exit concentration of SO<sub>2</sub>, for more than 94%, in order to reach values lower than 400 mg/Nm<sup>3</sup>, under full charge of blocks and combustion of low quality coal. Spreading of sulfur oxide emission has the greatest influence on air pollution. According to current nitric oxide emission with currently permitted value of 400mg/Nm<sup>3</sup>, since January 1<sup>st</sup> 2016, according to new regulations of European Union, the values must be decreased to 200 mg/Nm<sup>3</sup>, and therefore, they must search for solutions to decrease their emission, since current projects for desulphurization of flue gases do not anticipate the decrease of nitric oxides(Study on estimation of impact on environment-Desulphurization of flue gases of thermal power plant Kostolac B, 2010). Besides modern technological solutions, possibility of plants to contribute to so called green technology by absorbing should not be neglected, which includes growing of forests near the pollutants and protection areas near settlements.

## REFERENCES

1. Environmental Agency : *Results of automatic monitoring of air quality in the area of Smederevo*, 2015.
2. Group of authors : *Local ecological action plan of Smederevo municipality*, Directorate of Construction, Urban Planning and Construction Land Smederevo, pp. 25-83, 2007.
3. Внуков А.К. , *Защита атмосферы от выбросов энергообъектов: Справочник*, Энергоатомиздат, Moscow, pp. 52-85, 1992.
4. Djordjevic-Miloradovic J., Miloradovic D., Savic N.: *Recultivation and greening of landfills, ash and tailing ponds in Kostolac RIO Kostolac* pp. 72-84
5. Report of the Department of Environmental Management of Business Association power plants and collieries Kostolac, 2012.
6. Jaćimovski S. Miladinović S. : *Microclimate changes basin in Kostolac as a consequence of negative influence of Kostolac thermal power plants* International scientific conference „Archibald Reiss Days“, Thematic conference proceedings of international significance, Academy of Criminalistic and Police Studies, Belgrade, pp 297-312, 2014.
7. Consortium: The Faculty of Machine Engineering and Faculty of Mining and Geology, University of Belgrade, Worley Parsons and Energoprojekt-entel: *Study on estimation of impact on environment-Desulphurization of flue gases of thermal power plant Kostolac B*, Belgrade, pp 15-42, 86-114, 2010.



## INDUSTRIAL WASTE IN HEATING PLANTS

Maja Trifunovic\*, V. Cibulic, N. Staletovic, S. Mrazovac Kurilic

University "Union-Nikola Tesla", Faculty of Ecology and Environmental Protection  
Belgrade, SERBIA

*\*maja0705@gmail.com*

### ABSTRACT

The paper is considered industrial waste in the heating plant "New Belgrade", covered by the dangerous and non-hazardous waste. There are shown the quantity and quality of waste. Unique system of management is considered of this waste which has been required knowledge of the process of formation, the procedure of handling, storage, transport, treatment and final disposal of the same. The management of this waste requires compliance with the legislation by applying the latest waste treatment.

**Key words:** industrial waste, waste management, waste separation.

### INTRODUCTION

Waste management in the context of environmental protection involves the creation, accumulation, storage, transport, treatment, recycling, utilization and disposal of waste materials. Efficient management system of non-hazardous and hazardous industrial waste, from the city of its origin to its final disposal, to protect workers and population in general of environmental pollution that this will incur.

The establishment of uniform system of waste management requires knowledge of the process of formation, the procedure of handling, storage, transport, treatment and final disposal of the same. The management of waste streams require monitoring of legislation, in particular, given the complexity of environmental issues, all the newer technologies of waste treatment.

In this paper, the management of waste treated in the case of heating NB, where the waste stream depends on several factors, but primarily on the work and activities on the basis of which it can be made for the solution of reducing, collection, recycling, transport and disposal.

### BASIC INFORMATION ON THE ORGANIZATION OF HEATING PLANT "NEW BELGRADE"

"Belgrade Power Plants" was established in 1965 by merging the companies in establishing a plant in New Belgrade and the old power plant on the Danube Promenade.



HP NB is located at the Sava embankment no. 11, and is engaged in the production of thermal energy is used for heating of residential and office space in New Belgrade, Zemun work and the work of the Old Town. From the beginning, the basic activity was combined production of electricity and heat and transfer thermal energy to the consumer. Total nominal production capacity HP NB is 2.832MW. The thermal energy is carried out from 59 thermal sources. Production and delivery of thermal energy for heating domestic hot water, is carried out throughout the year from 11 thermal sources. The hot water is supplied by around 30.000 apartments in Belgrade, where the delivery to customers is about 2,2 mil.m<sup>3</sup> hot water.

The total installed thermal power is 925MW. Within the heating there are three steam boiler where steam is produced exclusively for the technological needs of district heating, as well as three turbines that are out of use.

### **INDUSTRIAL WASTE IN HEATING PLANT "NEW BELGRADE"**

During the production process in the heating plant NB generated industrial (hazardous and non-hazardous), municipal and packaging waste [1]. Cities of waste are:

- Office Space - communal waste, commercial waste including separately collected fractions – paper,
- Production plants - waste, household waste and similar including separately collected fractions - paper wastes not otherwise specified in the list, wastes from oil and liquid fuels residues, capacitors, soot from burning coal and fuel oil, waste chemicals and propulsion of metal, wood, rubber and plastic wastes from shaping and physical and mechanical surface treatment of metals and plastics, packaging waste, absorbents, wiping cloths, filter materials and protective clothing not otherwise specified, construction waste;
- Cities of works - construction waste and demolition waste including dredging, waste from welding wastes from oil and liquid fuels residues, wastes from shaping and physical and mechanical surface treatment of metals and plastics, packaging waste, waste tires, batteries ; [2,3]
- Electronic and electrical waste.

### **Sorting waste**

Sorting waste is a simultaneous process of determining the type of waste according to origin, nature and type of waste. The origin of waste - a set of actions that are specified index number of waste, waste generator sets. Figure 1 shows the scheme of waste segregation HP NB.

Rules on categories, testing and classification of waste, are determined in the procedure of classifying waste according to the Waste Catalogue, which forms an integral part.

In HP NB determined space for sorting, storing and packaging, intended exclusively for the types of waste that are defined procedures and instructions as well as municipal waste, secondary raw material or industrial waste.

### ***Management of municipal and commercial wastes***

Waste management is a set of activities, decisions and measures aimed at achieving the prevention of waste, reducing the quantity and the total environmental performance.

Hazardous waste management must be implemented in a way that no danger to human health, environmental pollution, uncontrolled waste disposal and incineration, the formation of explosion or fire and disturbance of public peace and order.

Municipal and commercial waste is disposed of in containers intended for the collection of municipal waste, paper containers intended for disposal of paper, which takes "City Sanitation".

### ***The management of non-hazardous industrial waste***

Non-hazardous industrial waste is generated as a result of business processes in the public communal company BE, in accordance with a documented quality management system so that the waste management system is set at the level of the same company. After manufacturing facilities there are special boxes for disposal of municipal and industrial non-hazardous waste.

Industrial non-hazardous waste, which is generated at the work site immediately transported to an appropriate landfill.

Disposal of secondary raw materials, regulating their sale. If it is not possible to sell secondary raw materials, applying the Law on Public Procurement. [5]

Waste owner or operator is obliged to classify waste in a proper manner. [2] The procedure provides a description of all activities as well as responsibilities for all handling of hazardous waste in power stations and large boiler to a temporary central warehouse. Final disposal of hazardous waste is regulated by engaging organizations that have appropriate permission from the authorities which selected according to the Law on Public Procurement. [5]

Before final disposal of hazardous waste stored on temporary central warehouse HP NB.

In the framework of the procedure are defined records: Register of hazardous waste, Registration of newly generated waste, daily records of the waste producer, the Document on movement of hazardous waste, and Guidelines for hazardous waste disposal, QUP.50.P19.01.01.

### ***The management of non-hazardous industrial waste management and reporting***

Collection and handling of waste performed HP NB workers and subcontractor companies with which they concluded agreements on cooperation with the use of proper equipment. Waste is, depending on place of origin, type, properties and aggregation state prepared for transport by posting it on the palette, reinforces stretch wrap, possibly reloading to another packaging, and so prepared is transported to the scale or temporary central storage of hazardous waste in the HP NB. [6,7]

Unloading of waste is carried forklifts or manually if possible. The waste in drums, unless the rack is placed on them and provides. If the waste arrived in bulk transshipment or in barrels or in suitable containers, from 5- 7 m<sup>3</sup> according to the type of

waste, which is stored until final disposal. The waste is stored until collected large quantities that allow transport.

The coordinator for the management of hazardous waste in the form PART 1, keep daily records of waste.

Transport of waste carried out by operators who have integrated permit for the collection and transportation of hazardous waste, ADR certificate of roadworthiness of vehicles carrying dangerous goods specified index number for that type of hazardous waste. Every transport of hazardous waste, which is performed between the plant and the boiler room as well as the operator who disposes hazardous waste, wash Document on movement of waste, as well as authorization by the competent authority under the applicable legislation. [4]

Generator of hazardous waste is required to provide adequate storage to its acquisition by a third party with a view to permanent disposal or destruction.

The person responsible for keeping daily records, delivering information services for the development of quality systems and environmental protection, and Co-ordinator for the management of hazardous waste.

## **CONCLUSION**

Based on the foregoing, it can be concluded that the production cycle HP NB generates integrated waste which is an indicator of the efficiency of the cycle of production and utilization of resources.

The strategy is to establish a manufacturing enterprise integrated waste management, where attention is paid to the respect of legislation, prevention, minimization, identification, collection, classification, recording, storage, controlled movement within the plant, safe transport to the place of treatment, effective utilization and as a last resort safe disposal with as little harm to the environment and human health. An essential element of the waste management strategy is to develop awareness of employees and their continuous improvement, and constantly improve the system of waste management. Particular attention should be paid to the development of cooperation with state authorities and local communities and other stakeholders.

## **REFERENCES**

1. Waste Management Strategy for the period 2010-2019, the "Official Gazette of RS", No. 29/10.
2. Rules on categories, testing and classification of waste, "Sl. Gazette of RS ", no. 56/2010.
3. The Law on Waste Management, "Sl. Gazette of RS ", No. 36/09, 88/10
4. Reay and Span (1979), "Heat Recovery System".
5. The Law on Public Procurement, "Official. Gazette of RS ", No. 124/12 and 14/15.
6. Instructions for disposal of hazardous waste, QUP.50.P19.01.01.
7. Kothadaramar and Subramanyan (2010), "HMT Data Book", New Age International (P) Ltd.



## OPTICAL MICROSCOPY AND SEM/EDS ANALYSIS OF PHASES IN AGE HARDENABLE AND RECYCLABLE ALUMINUM ALLOYS FROM 6000 SERIES

Uros S. Stamenkovic\*, S. Ivanov, I. Markovic

University of Belgrade, Technical Faculty in Bor,  
Vojske Jugoslavije 12, 19210 Bor, SERBIA

\*ustamenkovic@tf.bor.ac.rs

### ABSTRACT

In this paper two aluminum alloys EN AW-6060 and EN AW-6082 have been artificially aged and investigated. After the heat treatments microscopic investigations were done, using optical microscopy and SEM followed by EDS analysis of the present phases. The difference between the alloys was apparent due to different chemical compositions. Microscopic investigations showed that the microstructure of EN AW-6082 alloy is richer and more robust compared to the EN AW-6060 alloy, due to the higher amount of alloying elements. SEM analysis followed by EDS showed that in the EN AW-6060 alloy phases based on Al, Fe, Mg and Si were present. In addition to these phases, in the EN AW-6082 alloy one other phase was discovered which was based on manganese, due to manganese concentration in these types of alloys.

**Key words:** aluminum alloys, 6082, 6060, artificial aging, SEM analysis, EDS analysis.

### INTRODUCTION

Excellent physical and chemical properties of the 6000 series of aluminum alloys puts them on top of the most requested materials for commercial use. The most extruded products in Western Europe are made of these types of alloys /1/. Alloys from the series 6000 are mainly hardened by the presence of magnesium and silicon. These two elements make stable and metastable phases throughout the aging sequence /2/. The accepted sequence in the literature is SSSS ( $\alpha$ ) – atomic clusters – GP zones –  $\beta''$  –  $\beta'/B'$  –  $\beta$  (stable) /3-5/. The  $\beta''$  phase is the primary cause of the hardening of these alloys with the Mg:Si ratio close to 1:1.74 respectively /2, 6/. Besides the  $Mg_2Si$  phase, some other phases are present in the structure depending on alloying elements. The occurrence of iron is necessary in these alloys, so the microstructure in both investigated alloys always contains phases based on Al, Fe and Si. Also, the presence of manganese in 6082 alloy increases the strength either in solid solution or in a form of finely distributed intermetallic. Besides that, manganese combines with Al, Si and Fe to form an intermetallic phase. During the annealing, some processes are taking place such as the transformation of  $\beta-Al_5FeSi$  into the  $\alpha_c - Al_{15}(FeMn)_3Si$  particles and the dissolution of the stable  $\beta-Mg_2Si$  phase /7-9/.

## MATERIALS AND EXPERIMENTAL

The investigations were done on commercial aluminum alloys, on EN AW-6060 and EN AW-6082. The chemical composition of both alloys was determined by using a portable optical emission spectrometer "Belec Compact Port" manufactured by Belec Spektrometrie Opto-Elektronik GmbH and it is presented in table 1. Both alloys were delivered in aged condition (T6 temper). The samples were annealed at 550 °C for 6 hours in an electric resistance furnace, after that, the samples were air-cooled. After this annealing, samples were annealed again. Temperature of this solution heat treatment was 550 °C. After solution treatment, all samples were quenched in ice water in order to obtain a super saturated solid solution ( $\alpha_{SSSS}$ ). Immediately after obtaining  $\alpha_{SSSS}$ , the samples were subjected to artificial aging at 200 °C for 7 hours.

The metallographic investigations were performed on artificially aged samples. Microstructures of characteristic phases in examined alloys were observed using an optical microscope Carl Zeiss Jena Epytip 2 followed by more thorough investigation using a scanning electron microscope Tescan Vega 3 LMU with installed EDS detector. Samples were mechanically wet grinded, polished and etched with Dix-Keller or 1% NaOH solution in order to reveal relevant phases.

**Table 1.** Chemical composition of investigated alloys

		EN AW-6060	EN AW-6082
Chemical composition in weight percent (%wt.)	Si	0.49	0.807
	Fe	0.182	0.354
	Cu	0.012	0.042
	Mn	0.006	0.453
	Mg	0.594	0.696
	Cr	<0.003	<0.012
	Ni	0.028	0.012
	Zn	0.01	0.115
	Ti	0.005	0.025
	Pb	<0.003	0.01
	V	0.014	<0.003
	Co	<0.003	0.006
	Sn	<0.003	<0.003
	Zr	<0.003	<0.003
Al	98.62	97.45	

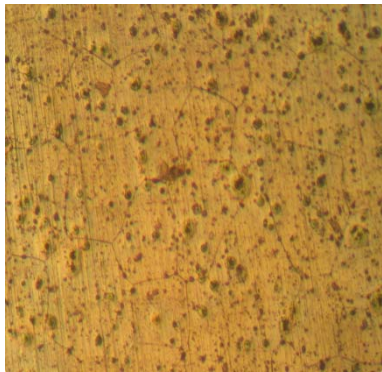
## RESULTS AND DISCUSSION

By observing the data in table 1, it can be concluded that the EN AW-6082 alloy has more alloying elements than the EN AW-6060 alloy, particularly manganese which is only found in traces in the EN AW-6060 alloy. Based on the chemical composition and other literature data [2], it can be concluded that the EN AW-6082 alloy would have more phases present in its microstructure, especially due to higher Mg:Si ratio. This difference between the alloys can be seen in obtained microstructures in

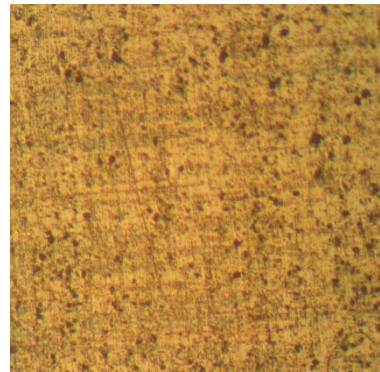
figures 1 and 2, with magnification 200x. Microscopic investigations showed that the microstructure of EN AW-6082 alloy is richer and more robust than the microstructure of the EN AW-6060 alloy.

Etching solution revealed grain boundaries in the EN AW-6060 alloy and finely precipitated phase based on Mg and Si. Further investigation using optical microscopy and larger magnification revealed a couple of different phases in the microstructure, presented on figures 3 and 4 (mag. 500x).

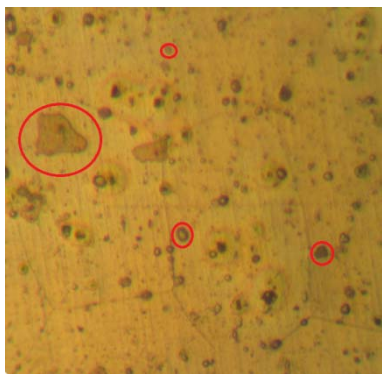
It is rather difficult to distinguish intermetallic phases using optical microscopy. Even if the difference is apparent the precise and detailed identification is only possible by using more than one method. Further investigation of present phases in the microstructure was done using SEM with EDS.



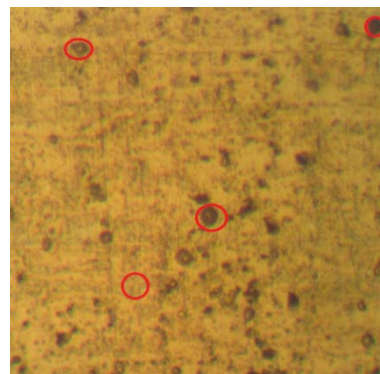
**Figure 1.** Microstructure of EN AW-6060 sample aged at 200 °C for 7 hours (magnification 200x)



**Figure 2.** Microstructure of EN AW-6082 sample aged at 200 °C for 7 hours (magnification 200x)

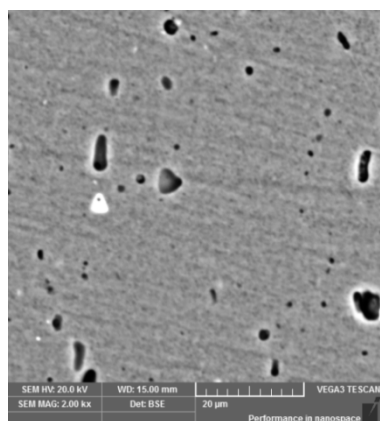


**Figure 3.** Microstructure of EN AW-6060 sample aged at 200 °C for 7 hours (magnification 500x)

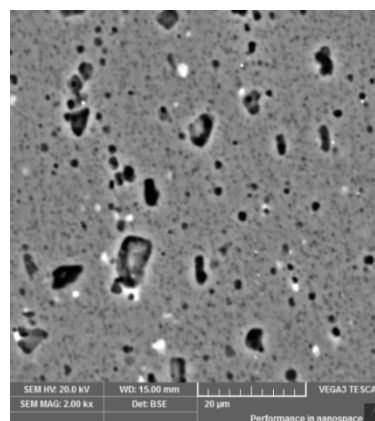


**Figure 4.** Microstructure of EN AW-6082 sample aged at 200 °C for 7 hours (magnification 500x)

In figures 5 and 6, the SEM images can be seen. These images are much clearer than the optical ones. The phases are very easy to distinguish on these magnifications (mag. 2000x), as they are often very different in shape and form as well as in contrast.



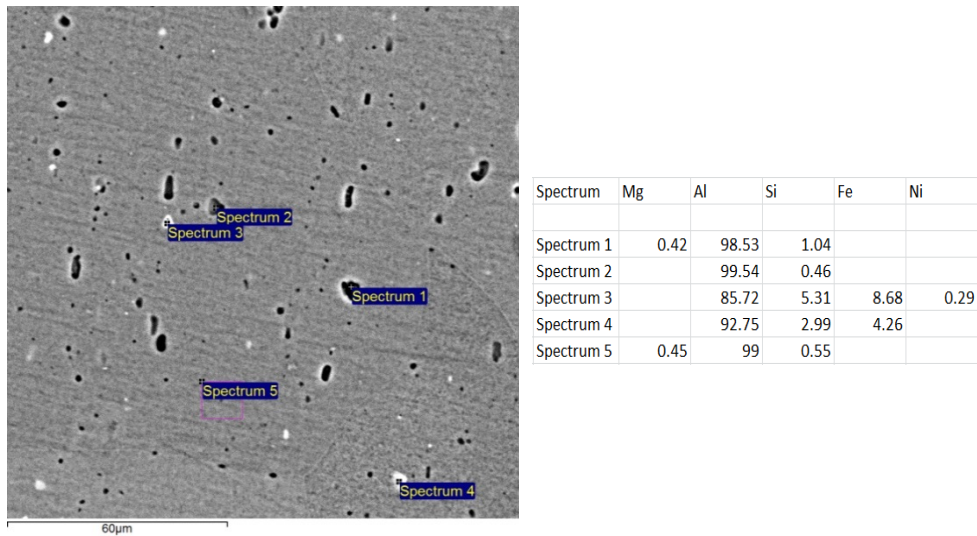
**Figure 5.** SEM image of EN AW-6060 sample aged at 200 °C for 7 hours



**Figure 6.** SEM image of EN AW-6082 sample aged at 200 °C for 7 hours

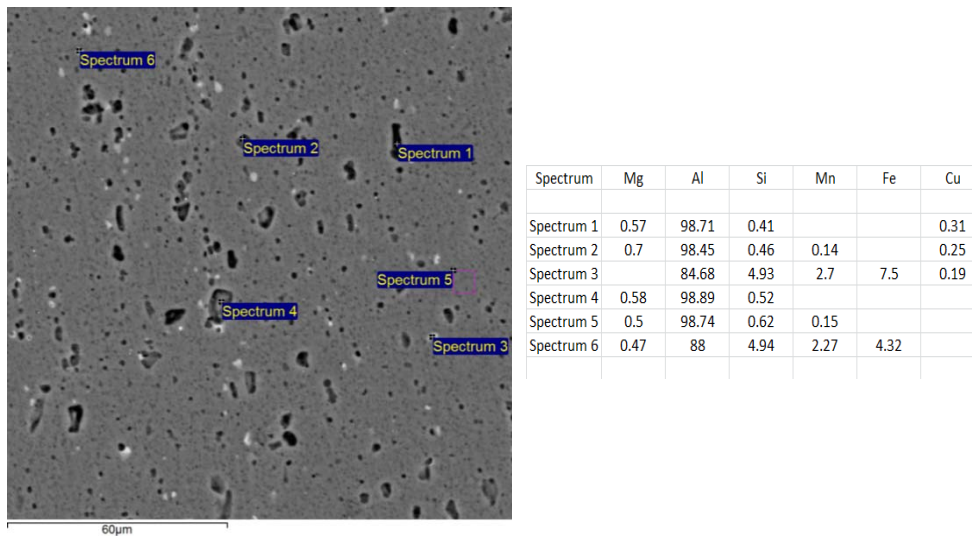
Even though the SEM images provide information about different phases, it is still not possible to completely define what types of phases there are in the structure and their chemical composition. On the SEM images, the differences between the alloys are more apparent, specifically the difference in chemical composition. Due to contrasted images, finely dispersed phases based on Mg and Si are more visible on micrographs made by optical microscopy (figures 3 and 4).

EDS analyses of the samples can be seen in figures 7 and 8. The analysis of EN AW-6060 indicates that after aging at 200 °C for 7 hours there are a couple of different phases present in the structure. The phase which is mostly present is the  $\beta''$  phase (spectrum 5) with the Mg:Si ratio close to 1:1 also found by some other authors [6, 10, 11]. Additionally, some other phases are present in the microstructure but in very small quantities, AlSi (spectrum 2),  $\beta$ -AlFeSi (spectrum 4) and one new AlFeSiNi phase which contains a small quantity of nickel (spectrum 3). As seen in figure 7, AlFeSiNi particle is not very different from AlFeSi particles, so it can be concluded that it is probably the same phase but the nickel precipitated from the solid solution in this way due to its affinity for silicon and iron.



**Figure 7.** EDS analysis of EN AW-6060 sample aged at 200 °C for 7 hours

Figure 8 shows the EDS analysis of the EN AW-6082 sample aged at 200 °C for 7 hours. Similarly to the previous sample, a couple of phases are present in this one as well.  $\beta''$  phase is also the most dominant in the microstructure (spectrum 1, 2, 4, 5). One new phase appeared in this sample, the first one is the previously mentioned AlFeMnSi which appears white on the SEM images (spectrum 3), as documented by another author /12/.



**Figure 8.** EDS analysis of EN AW-6082 sample aged at 200 °C for 7 hours



Because manganese is present in this alloy, it is expected to be in microstructure with Mg and Si. Manganese is present in almost all phases due to the high percent ratio in the chemical composition.

## CONCLUSIONS

This paper provided an experimental investigation of two artificially aged aluminum alloys EN AW-6060 and EN AW-6082. Three different methods were used to distinguish the types of phases present in aged samples depending on chemical composition. Right from the start, by looking at obtained optical micrographs, differences between the alloys are apparent. However, the usage of optical microscopy doesn't provide full understanding of the phases that are present and information about their morphology. SEM images improve the understanding of different types of phases. The high degrees of magnification available on the scanning electron microscope provide information regarding size, morphology, appearance of the different phases present in both alloys. EDS in combination with SEM provides the most complete analysis of the microstructures of aluminum alloys. Due to SEM/EDS analyses it is possible to find out what is the chemical composition of present phases and in what way they appear in the microstructure. These analyses provided information about phase composition and their appearance in the microstructure, which is in agreement with other available research.

## REFERENCES

1. Marioara C. D., Andersen S. J., Jansen J., Zandbergen H. W., Atomic model for GP-zones in a 6082 Al–Mg–Si system, *Acta Materialia* 51 (2003), 789–796.
2. Gupta A.K., Lloyd D.J., Court S.A., Precipitation hardening in Al–Mg–Si alloys with and without excess Si, *Materials Science and Engineering A* 316 (2001), 11–17.
3. Edwards G. A., Stiller K., Dunlop G. L., Couper M. J., The precipitation sequence in Al–Mg–Si alloys, *Acta Materialia* 46 (11) (1998), 3893–3904.
4. Zhen L., Fei W. D., Kang S. B., Kim H. W. Precipitation behavior of Al–Mg–Si alloys with high silicon content, *Journal of Materials Science* 32 (1997), 1895 - 1902.
5. Murayama M., Hono K., Saga M., Kikuchi M., Atom probe studies on the early stages of precipitation in Al–Mg–Si alloys, *Materials Science and Engineering A* 250 (1998), 127–132.
6. Maruyama N., Uemori R., Hashimoto N., Saga M., Kikuchi M., Effect of silicon addition on the composition and structure of fine-scale precipitates in Al–Mg–Si alloys, *Scripta Materialia* 36(1) (1997), 89–93.
7. Morowka-Nowotnik G., Sieniawski J., Nowotnik A., Intermetallic phase identification of the cast and heat treated 6082 aluminum alloy, *Archives of Metallurgy and Materials* 21 (4) (2008), 599-603.

8. Samuel F. H., Samuel A. M., Doty H. W., Valtierra S., Decomposition of Fe-intermetallics in Sr-modified cast 6XXX type aluminum alloys for automotive skin, *Metallurgical and Materials Transactions A* 32(8) (2001), 2061-2075.
9. Liu Y.L., Kang S.B., Kim H.W., The complex microstructures in an as-cast Al–Mg–Si alloy, *Materials Letters* 41 (6) (1999), 267–272.
10. Lynch J.P., Brown L.M., Jacobs M.H., Microanalysis of age-hardening precipitates in aluminium alloys, *Acta Metallurgica* 30 (7) (1982), 1389-1395.
11. Barczy P., Trante F., *Scandinavian Journal of Metallurgy* 4 (1975), 284.
12. Birol Y., The effect of processing and Mn content on the T5 and T6 properties of AA6082 profiles, *Journal of Materials Processing Technology* 173 (2006), 84–91.



## APPLICATION OF ELOVICH EQUATION IN ANALYSIS OF ADSORPTION KINETICS IN Cu-LCW SYSTEM

Zorica Lopicic\*, M. Stojanovic, J. Milojkovic,  
M. Petrovic, M. Mihajlovic, T. Sostaric, J. Petrovic

Institute for Technology of Nuclear and Other Mineral Raw Materials,  
Belgrade, SERBIA

\*z.lopicic@itnms.ac.rs

### ABSTRACT

The Elovich equation is widely used in describing adsorption kinetics for different systems. It relates to chemical adsorption mechanism characteristic for systems with heterogeneous surfaces. In this paper we have used peach stone particles (PS) obtained by mechanical activation of peach stone, an agricultural lignocellulosic waste material as copper sorbent. The statistical parameters obtained from comparison of three common kinetic equations applied, revealed that Elovich equation was the most suitable one. For evaluation of characteristic adsorption kinetic curves under different initial Cu(II) concentrations, the approaching equilibrium parameter of Elovich equation ( $R_E$ ) was used.

**Key words:** biosorption, peach stone, kinetic model, Elovich.

### INTRODUCTION

For the last few decades, increased concern worldwide has been the problem solving of water resources polluted by heavy metals. Among the other metals found in nature, copper and its compounds are ubiquitous, spread out to the environment by different natural phenomena as well as human activities. Among the other techniques used for copper removal, biosorption have proved to be an eco-friendly alternative, potentially low cost effective technology that removes pollutants from water solutions, using dead or alive, but mostly waste biomass as adsorbent-biosorbent [1].

In order to evaluate the kinetic mechanism that controls the biosorption process, different kinetic models based either on chemical reaction or diffusion might be used. Most common reaction models used are the pseudo-first-order, pseudo-second-order and Elovich equation. The Elovich equation, originally presented in 1939, is satisfied in chemical adsorption processes and is suitable for systems with heterogeneous adsorbing surfaces [2]. This equation have been widely applied in the adsorption different heavy metals such as  $\text{Co}^{2+}$ ,  $\text{Ni}^{2+}$ ,  $\text{Cu}^{2+}$ ,  $\text{Cd}^{2+}$ ,  $\text{Zn}^{2+}$ ,  $\text{Pb}^{2+}$  [3, 5], dyes, humic acid and phenols [6, 7].

Peach stones are agricultural waste biomass, containing biopolymers with free active groups that suitable for the adsorption of different pollutants. Although the

adsorption process involving peach stones is chemical in nature [8, 9], the Elovich equation has scarcely been used to analyze its adsorption kinetics. In this work, the characteristic curves of adsorption kinetics by Elovich equation were studied by means of its approaching equilibrium parameter ( $R_E$ ). In the same time, kinetic data were modelled with two other common reaction models, compared and evaluated.

## EXPERIMENTAL

Raw peach stones were obtained from Juice Factory “Vino Župa” Company, Aleksandrovac, Serbia, where they have been disposed as by-product waste at an open landfill in the factory area. After sampling, the peach stones were first separated from soft fruit residues, washed in tap water, dried at room temperature for several days, and kept in polypropylene bottles for further treatment. Reducing the size of peach stones was gained by vibratory disc mill “Siebtechnik - TS250” (Siebtechnik GmbH, Germany). Vibratory disc mill operates discontinuously in the batch conditions, applying the pressure, impact and friction action. During the milling process, temperature inside the cylindrical vessel can rise, so the operating time was adjusted to 5 minutes. During this time, both grinded and coarse materials are continuously exposed to vibratory mill action.

After milling, particles were screened through the wire sieves with different aperture sizes. For most biosorption kinetic experiments presented in this paper, peach stone particle of size less than 100  $\mu\text{m}$  were collected. In order to eliminate surface impurities, the samples were first washed several times in 0.001M HCl and then in distilled water until negative reactions with chloride ions. The samples were dried at 60  $^{\circ}\text{C}$  until the constant mass and kept in desiccator before use.

Copper solutions was prepared by dissolving  $\text{CuSO}_4 \cdot 5\text{H}_2\text{O}$  (analytical grade) in distilled water using standard flasks. The initial metal concentration varied from 10 to 250  $\text{mg l}^{-1}$ , while the solution pH was adjusted to 5.0, according to our previous investigations [8], and kept constant all the time during the experiment. The pH measuring was performed using pH meter SensION+, model MM340 (Hach Lange).

The adsorption kinetics was carried out in closed flasks each containing 1.00 g of each PS sample and 100.0 ml of Cu(II) solutions. The total metal concentration in solution was determined with atomic absorption spectrophotometer (Perkin Elmer AAS Analyst 300).

The amount of Cu(II) ions adsorbed by the biosorbent,  $q$  ( $\text{mg g}^{-1}$ ), is obtained by the following equation:

$$q = \frac{(C_i - C_e)V}{M} \quad (1)$$

where  $C_i$  and  $C_e$  ( $\text{mg l}^{-1}$ ) are the initial and the equilibrium metal ion concentration, respectively,  $M$  (g) is the mass of biosorbent and  $V$  (l) is the volume of the copper solution.

In this study, all the experiments were carried out in duplicate and the average values are presented.

The selection of the best-fit model was based on linear regression correlation coefficient ( $R^2$ ), model calculated  $q_m$  values and the minimum value of some statistical indicator. For this purpose reduced chi squared ( $\chi^2$ ) was employed as error function according to the following equation:

$$\chi^2 = \sum_{i=1}^p \frac{(q_m - q_e)^2}{q_e} \quad (2)$$

where  $q_m$  is the value of biosorption capacity predicted by the fitted model ( $\text{mg g}^{-1}$ ) and  $q_e$  is the biosorption capacity at equilibrium obtained experimentally ( $\text{mg g}^{-1}$ ) while  $p$  is the number of experiments performed.

## RESULTS AND DISCUSSION

Ho [10] had proposed general guideline which suggests that the sorption process is usually reaction controlled if the changes in pH have a greater effect on the sorption of solutes and if the equilibrium is achieved within three hours. If the equilibrium is appointed above twenty four hours, it is usually diffusion controlled. In period from three to twenty four hour period, either or both reaction and diffusion processes may be rate controlling. According to our previous investigation, pH of solution has significant impact on sorption process, while the equilibrium is attained in less than three hours in investigated concentration range [8, 9]. This indicated that reaction process might control the kinetic of Cu biosorption, thus following reaction models were tested: the pseudo-first, pseudo-second and Elovich models. Obtained values served to interpret the experimental data and explain the adsorption mechanism of the metal ion on the peach stone particles.

The pseudo-first order Lagergren rate equation is based on solid capacity. Its linear form is given by the following equation [11]:

$$\ln(q_e - q_t) = \ln q_e - k_1 t \quad (3)$$

where  $k_1$  ( $\text{min}^{-1}$ ) is the pseudo-first rate constant,  $q_t$  ( $\text{mg g}^{-1}$ ) is the biosorption capacity at time  $t$  (min), and  $q_e$  ( $\text{mg g}^{-1}$ ) is the value of biosorption capacity at equilibrium.

The linear form of pseudo-second-order equation [12] is expressed by Eq. (3):

$$\frac{t}{q_t} = \frac{1}{k_2 q_e^2} + \frac{1}{q_e} t \quad (4)$$

where  $k_2$  ( $\text{g mg}^{-1} \text{min}^{-1}$ ) is the second-order rate constant,  $q_t$  ( $\text{mg g}^{-1}$ ) and  $q_e$  ( $\text{mg g}^{-1}$ ) are the biosorption capacities at any time  $t$  and at equilibrium, respectively.

In order to elucidate the possible chemisorption process for systems with heterogeneous adsorbing surface, the following simplified form of Elovich equation [13] was used:

$$q_t = \frac{1}{b} \ln(ab) + \frac{1}{b} \ln t \quad (5)$$

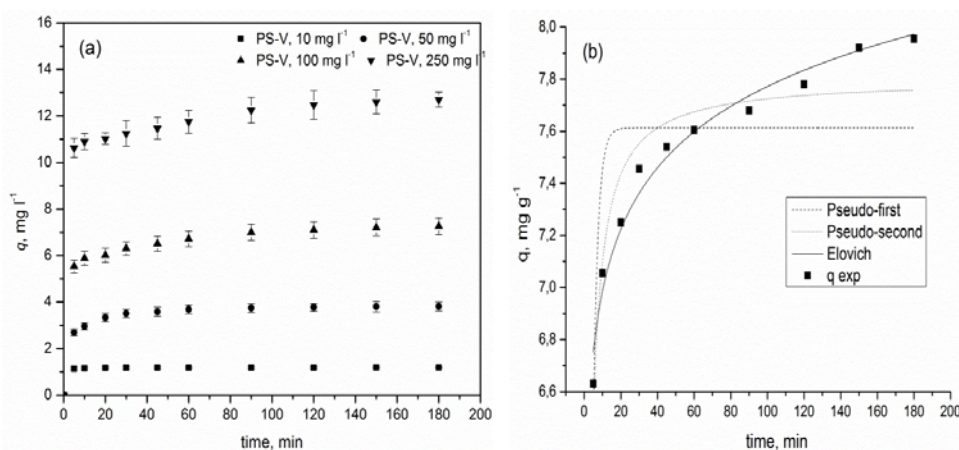
where  $q_t$  ( $\text{mg g}^{-1}$ ) represents the biosorption capacity at any time  $t$ ,  $a$  is initial copper biosorption rate ( $\text{mg g}^{-1} \text{min}^{-1}$ ), while  $b$  is related to the extent of surface coverage and activation energy for chemisorption ( $\text{g mg}^{-1}$ ).

An approaching equilibrium factor  $R_E$  obtained from dimensionless Elovich equation [14] is defined as:

$$R_E = \frac{1}{q_{ref} \cdot t_{ref}} \quad (6)$$

where  $q_{ref}$  is the solid phase concentration at time  $t_{ref}$  which is the longest time in adsorption process.

According to classification of characteristic curves based on  $R_E$  derived from the Elovich equation [14], there are four type of characteristic curves, depending on  $R_E$  value: if  $R_E > 0.3$ , then the curve rises slowly; if  $R_E$  is between 0.1 and 0.3, the curve rises mildly (mild adsorption); the value of  $R_E$  between 0.02 and 0.1 indicate rapid adsorption and when  $R_E < 0.02$ , the curve instantly approaches equilibrium.



**Figure 1.** (a) Amount of Cu(II) uptake by PS-V vs. time at different Cu(II) concentrations ( $C_i = 10$ - $250$  mg l<sup>-1</sup>,  $M/V = 10$  g l<sup>-1</sup>, stirring speed = 250 rpm, pH = 5, T=25 °C); (b) Regression analysis of Cu(II) uptake kinetic at  $C_i = 100$  mg l<sup>-1</sup>

Figure 1 shows the kinetics of the biosorption of ions of Cu(II) by PS under different initial Cu concentrations. The availability of active sites on biosorbents surface caused an initial rapid metal uptake, especially for Cu(II) concentration of 10 mg l<sup>-1</sup> where the equilibrium was reached in less than 10 min. Increasing the driving force in the form of initial Cu(II) concentration lead to the increase in biosorption uptake: for initial Cu(II) concentration of 50 mg l<sup>-1</sup> biosorption capacities was 3.81 mg g<sup>-1</sup>, while initial Cu(II) concentration of 100 and 250 mg l<sup>-1</sup> resulted in capacity 7.26 and 12.70 mg g<sup>-1</sup>, respectively.

The kinetic parameters for biosorption of Cu(II) under different initial Cu concentration are given in Table 1. Based on the obtained correlation coefficients, Elovich equation was the model that provides the best fit for the experimental kinetic data, evidencing chemical sorption as rate-limiting step of biosorption mechanism. The experimental  $q_e$  values are in good agreement with the calculated ones, which do not

happen with the pseudo-first-order kinetic equation. The other statistical parameter also confirms that this equation best fits the experimental data.

**Table 1.** Kinetic parameters calculated for Cu biosorption by PS particles and initial Cu concentration 100 mg l<sup>-1</sup>

Kinetic model	Experimental value	
	$q_e$ (mg g <sup>-1</sup> )	7.30
Pseudo-first-order	$q_m$ (mg g <sup>-1</sup> )	7.03
	$k_1$ min <sup>-1</sup>	0.3865
	$R^2$	0.5748
	$\chi^2$	0.07203
Pseudo-second-order	$q_m$ (mg g <sup>-1</sup> )	7.15
	$k_2$ (g mg <sup>-1</sup> min <sup>-1</sup> )	0.1299
	$R^2$	0.8945
	$\chi^2$	0.01784
Elovich	$q_m$ (mg g <sup>-1</sup> )	7.268
	$a$ (mg g <sup>-1</sup> min <sup>-1</sup> )	5.10E+5
	$b$ (g mg <sup>-1</sup> )	2.9325
	$R_E$	0.0695
	$R^2$	0.9729
	$\chi^2$	0.0046

The quantity  $a$  in the Elovich equation is equivalent to the initial gradient which varied different  $C_i$  values and different PS masses. Results presented in Table 1 show a very good compliance with the Elovich model, resulting in high correlation coefficients and low error functions for all concentration range [9]. It can also be observed that the increase in initial Cu(II) concentration leads to the increase in constant  $a$  and to the decrease of constant  $b$ , which is in accordance with the assumption that  $a$  is a constant related to the rate of chemisorption and  $b$  is the constant related to the surface coverage. Also, it was noticed that values of approaching equilibrium factor,  $R_E$ , fall in the region of fast adsorption for whole concentration range, except for initial Cu(II) concentration of 10 mg l<sup>-1</sup> when an instantaneous adsorption occurred.

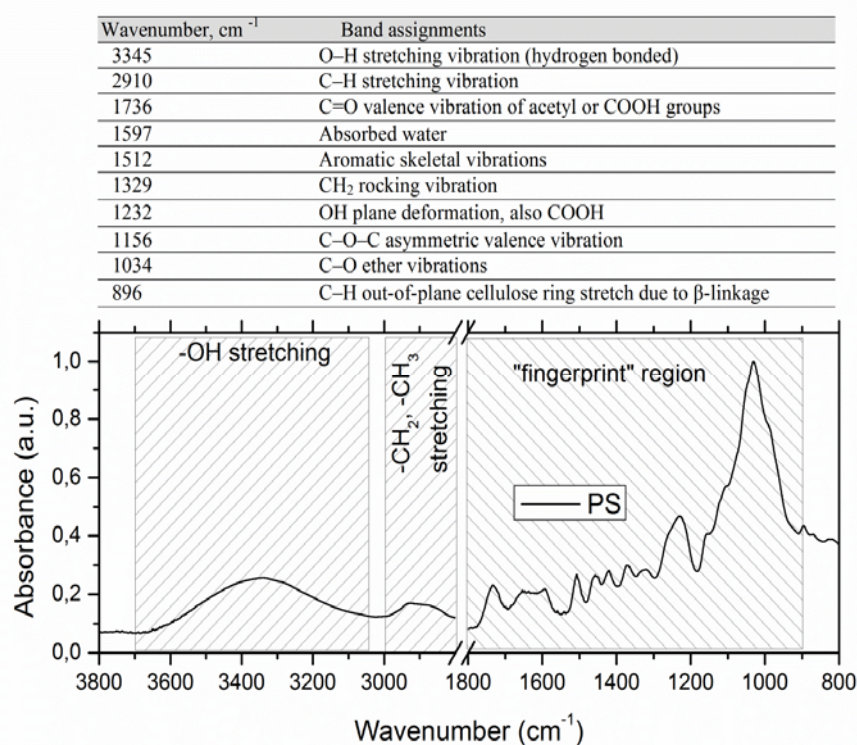
**Table 2.** Parameters obtained from the analysis of adsorption kinetics by Elovich equation

Elovich parameter	10 mg l <sup>-1</sup>	50 mg l <sup>-1</sup>	100 mg l <sup>-1</sup>	250 mg l <sup>-1</sup>
$a$ (mg g <sup>-1</sup> min <sup>-1</sup> )	7.39E+37	4.76E+2	5.10E+5	2.45E+6
$b$ (g mg <sup>-1</sup> )	81.30	3.181	2.932	1.622
$R_E$	0.0104	0.0823	0.0695	0.0486

Summarizing presented data it can be concluded that kinetic of Cu biosorption can be well represented by Elovich equation which is applicable on heterogeneous systems. The complex structure of PS is confirmed by the FTIR analysis. Generally, the FTIR spectra of most lignocellulosic materials can be divided in two regions: first one relates to -OH and -CH stretching vibrations (4000-2600 cm<sup>-1</sup>) region, and the



“fingerprint” region assigned to stretching of different functional groups present in the samples (1800 - 800  $\text{cm}^{-1}$ ). The most representative bands in the first region are those assigned to  $\text{-OH}$  intramolecular and intermolecular stretching modes (3600-3000  $\text{cm}^{-1}$ ) and to symmetric and asymmetric methyl and methylene groups (3000-2800  $\text{cm}^{-1}$ ) [15]. A consistent strong and sharp peak typical to intramolecular hydrogen bond of cellulose I, was observed in PS sample at 3345  $\text{cm}^{-1}$ . Also, it should be noted that the peak at 1235  $\text{cm}^{-1}$  is used to indicate the presence of structural carbohydrate such as cellulose, while the absorptions situated at 1510 and 1600  $\text{cm}^{-1}$  (aromatic skeletal vibrations) are caused by lignin; the absorption located at 1730  $\text{cm}^{-1}$  is caused by holocellulose-combination of cellulose and hemicellulose [16].



**Figure 2.** FTIR Analyses of PS sample



## CONCLUSION

The complex mechanism of biosorption depends on the physical and chemical characteristics of the biosorbents. Regarding this, adsorption can be either physical or chemical, governed by diffusion or chemical reaction, respectively. Although the Elovich equation does not provide any mechanistic evidence, it has proved suitable for highly heterogeneous systems of which the adsorption of Cu(II) on to PS is a case. The heterogeneity of this system is confirmed by FTIR analysis which provided evidence of presence of different active groups responsible for metal binding.

### *Acknowledgment*

*The authors are grateful to the Serbian Ministry of Education, Science and Technological Development for the financial support of this investigation included in the project TR 31003.*

## REFERENCES

1. Wang, J., and Chen, C., Biosorbents for heavy metals removal and their future, *Biotechnology Advances*, 27, p. 195–226, 2009
2. Aharoni, C., Tompkins, F.C., Kinetics of adsorption and desorption and the Elovich equation, in: D.D. Eley, H. Pines, P.B. Weisz (Eds.), *Advances in Catalysis and Related Subjects*, vol. 21, Academic Press, New York, p. 1–49, 1970
3. Juang, R.S., Chen, M.L., Application of the Elovich equation to the kinetics of metal sorption with solvent-impregnated resins, *Ind. Eng. Chem. Res.* 36, p. 813–820, 1997
4. Wu, F.C., Tseng, R.L., Juang, R.S., Characteristics of Elovich equation used for the analysis of adsorption kinetics in dye–chitosan systems, *Chem. Eng. J.* 150, p. 366–373, 2009; 813–820.
5. Pérez-Marín, A.B., Zapata, V.M., Ortuno, J.F., Aguilar, M., Sáez, L., Llorens, M., Removal of cadmium from aqueous solutions by adsorption onto orange waste, *J. Hazard. Mater.* 139, p. 122–131, 2007
6. Wu, F.C., Tseng, R.L., Juang, R.S., Adsorption of dyes and humic acid from water using chitosan encapsulated activated carbon, *J. Chem. Technol. Biotechnol.* 77, p. 1269–1279, 2002
7. Tseng, R.L., Wu, F.C., Juang, R.S., Liquid-phase adsorption of dyes and phenols using pinewood-based activated carbons, *Carbon* 41 (2003) 487–495.
8. Lopičić, Z., Milojković, J., Šoštarić, T., Petrović, M., Mihajlović, M., Lačnjevac, Č., Stojanović, M., Uticaj pH vrednosti na biosorpciju jona bakra otpadnom lignoceluloznom masom koštice breskve, *Hem. Ind.* 67, p. 1007–1015, 2013
9. Lopičić, Z., Stojanović, M., Marković, S., Milojković, J., Mihajlović, M., Kaluđerović Radoičić, T., Kijevčanin, M., Effects of different mechanical treatments on structural changes of lignocellulosic waste biomass and subsequent Cu(II) removal kinetics, *Arabian Journal of Chemistry*, 2016, doi: 10.1016/j.arabjc.2016.04.00

10. Ho, Y.S., Ng, J.C.Y., McKay, G., Kinetics of pollutants sorption by biosorbents: review, *Separation Purif. Methods*, 29, p. 189–232, 2000
11. Lagergren, S. and Sven, K., *Vetenskapsakad, Handl.*, 24, p.1–39, 1898
12. Ho, Y.S., Adsorption of heavy metals from waste streams by peat. Ph.D. thesis, University of Birmingham, Birmingham, UK, 1995.
13. M.J.D. Low, Kinetics of Chemisorption of Gases on Solids, *Chem. Rev.* 60, p.267–312, 1960
14. Wu, F.C., Tseng, R.L., Juang, R.S., Characteristics of Elovich Equation Used for the Analysis of Adsorption Kinetics in Dye–Chitosan Systems, *Chem. Eng. J.* 150, p.366–373, 2009
15. Adel, A.M., Abd El-Wahab, Z.H., Ibrahim, A.A., Al-Shemy, M.T., Characterization of microcrystalline cellulose prepared from lignocellulosic materials. Part II: physicochemical properties, *Carbohydr. Polym.* 83, p.676-687, 2011
16. Bodirlau R., Teacas, C.A., Fourier transform infrared spectroscopy and thermal analysis of lignocellulose fillers treated with organic anhydride, *Rom. J. Phys.* 54, p.93–104, 2009



## THE INFLUENCE OF PH VALUE ON THE INHIBITION EFFICIENCY OF MIXED SYSTEM OF AZOLES AND GELATIN IN SULFURIC ACID MEDIUM

Zaklina Z. Tasic\*, M. B. Petrovic Mihajlovic, A. T. Simonovic,  
M. B. Radovanovic, S. M. Milic, M. M. Antonijevic

University of Belgrade, Technical Faculty in Bor, Bor, SERBIA

\*ztasic@tf.bor.ac.rs

### ABSTRACT

The influence of pH value on the anti-corrosion ability of binary inhibitor system of azoles and gelatin in 0.01 M H<sub>2</sub>SO<sub>4</sub> solution was studied. The experiments were carried out at different pH values, from 2.0 up to 4.0. Electrochemical methods were used in this investigation. Results refer that mixed system of azoles (1H-benzotriazole, 5-methyl-1H-benzotriazole) and gelatin acts as mixed type inhibitor. As solution pH value increases, the effectiveness of investigated system also increases. The obtained results by cyclic voltammetric measurements confirmed good inhibitory properties of binary inhibitor system at different pH values.

**Key words:** azoles, gelatin, copper, corrosion, sulfate solution.

### INTRODUCTION

Copper and its alloys have wide application in industry and in daily life, so the corrosion of them is an important issue [1]. Due to the use of acids in industrial processes, such as pickling, cleaning, descaling copper can undergo corrosion process [2]. The application of inhibitors is one of the most practical methods to protect metals against acid attack. According to the literature, the most effective inhibitors have an atom such as nitrogen, oxygen or sulfur in their molecular structures [3-5]. Also, compounds with high molecular mass have proved to be effective inhibitors [6]. Organic compounds reduce corrosion through adsorption on the metal surface and complex formation with metal ions [7]. The efficiency of 1H-benzotriazole and its derivatives as copper corrosion inhibitors in different media is well known [8]. Also, it has been found that gelatin has ability to protect copper against corrosion [9]. The main components of gelatin are amino acids: glycine, proline, hydroxyproline, alanine and glutamic acid. The structure of gelatin molecule is the cause of its ability to be adsorbed on the metal surface.

### MATERIALS AND METHODS

For the electrochemical measurements a three electrode cell system was used at room temperature. Copper electrode with area of 0.49 cm<sup>2</sup> was used for the

electrochemical measurements as working electrode. Saturated calomel electrode (SCE) was used as reference electrode while platinum was used as counter electrode. Experiments were conducted in 0.01 M H<sub>2</sub>SO<sub>4</sub> at different pH values, without and with the addition of binary inhibitor system. 1H-benzotriazole (BTAH) and 5-methyl-1H-benzotriazole (MBTAH) were added into the solution in concentration of 8.4·10<sup>-3</sup> M, while gelatin was added in concentration of 1% (wt.%). The pH value of solution was adjusted using diluted NaOH solution.

Electrochemical methods including open circuit potential (OCP) measurement, linear potentiodynamic and cyclic voltammetric measurements were used for investigation. The OCP was determined for 10 minutes before starting the potentiodynamic polarization measurement. Linear voltammograms were recorded over the range of OCP ± 0.25 V vs. SCE in the cathode and anode direction. Scan rate was 1 mVs<sup>-1</sup>. Cyclic voltammograms were recorded from -1.0 V to 1.0 V (vs. SCE), at a scan rate of 10 mVs<sup>-1</sup>.

## RESULTS AND DISCUSSION

### The open circuit potential measurements of copper

The open circuit potential of copper in 0.01 M H<sub>2</sub>SO<sub>4</sub> solution without and with the addition of mixed inhibitors containing azoles (BTAH, MBTAH) and gelatin is measured during 10 minutes. The measurements were carried out at different pH values from pH 2 up to pH 4. The recorded OCP values are summarized in Table 1. According to the presented results, the OCP values are shifted into positive direction in the presence of mixed inhibitor system in comparison to bare sulfate solution. This behavior indicates the adsorption of organic compounds on the copper surface [10].

### Cyclic voltammetry measurements of copper

According to the literature data, anodic dissolution of copper in an acidic medium can be presented by the following reactions [11]:



The cathode reaction represents the reduction of dissolved oxygen according to the reaction (3) [12]:



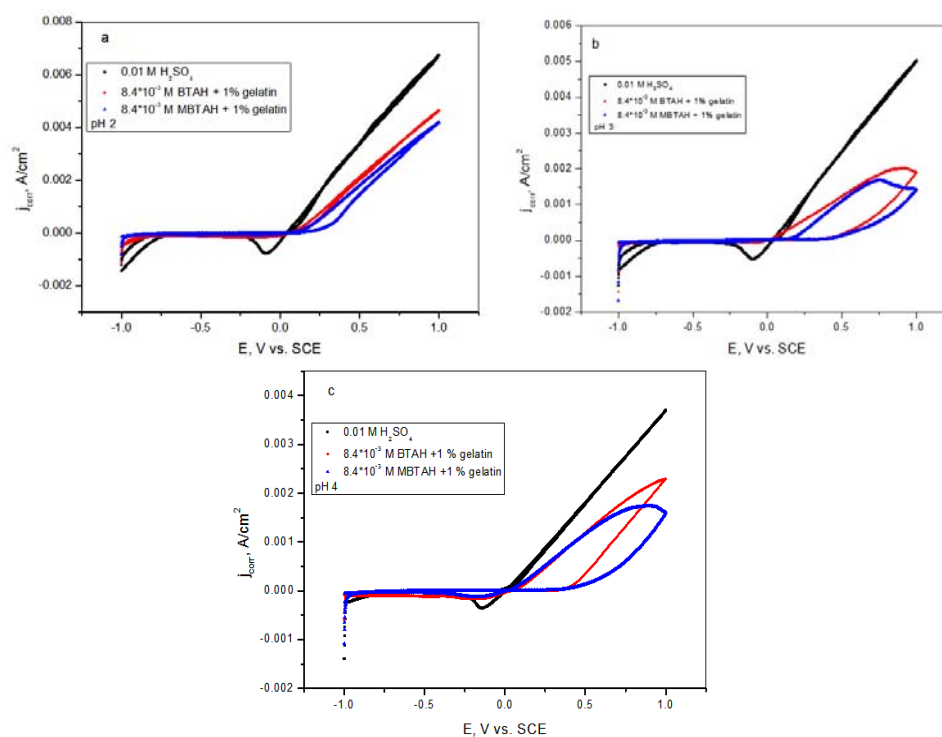
The cyclic voltammograms of Cu in 0.01 M H<sub>2</sub>SO<sub>4</sub>, at various pH values, without and with the addition of inhibitors in the potential range from -1.0 to +1.0 V versus SCE are shown in Figure 1 (a, b, c). Cyclic voltammetry curve for copper in naturally aerated sulfate solution indicates that Cu undergoes oxidation to Cu<sup>+</sup> ions [13]. In the reverse scan, the cathodic peak represents the reduction of copper ions.

Further, cyclic voltammetric measurements were performed in the presence of azoles (BTAH, MBTAH) and gelatin in sulfate solution at different pH values. The

obtained CV curves (Figures 1a, b and c) confirmed that applied binary inhibitor system had a protective effect against corrosion. According to the Figure 1a, the anodic peak was not observed until the potential reached the value of  $\sim 0.3$  V (vs. SCE). Further, with increasing the potential value in the anodic direction (above 0.3 V), the current density also increased. This fact maybe indicates that protective layer is destroyed so the dissolution of copper is continued. It is noticed that with pH increase from 2.0 up to 4.0, protection degree of copper increases (Figures 1b and 1c). It is assumed that there is an interaction between gelatin and azoles which leads to the formation of more compact layer on the copper surface. As it is known, BTAH is weak acid and the extent of its ionization depends on pH value. Ionization of BTAH takes place by the reactions (4) and (5) [8].



So, with increasing solution pH the concentration of  $BTA^-$  species increase which contributes to higher protection degree of copper in the investigated medium [14].



**Figure 1.** Cyclic voltammetric curves of copper in 0.01 M  $H_2SO_4$  in the presence of mixed inhibitor of azoles (BTAH, MBTAH) and gelatin at pH 2 (a), at pH 3 (b) and at pH 4 (c)

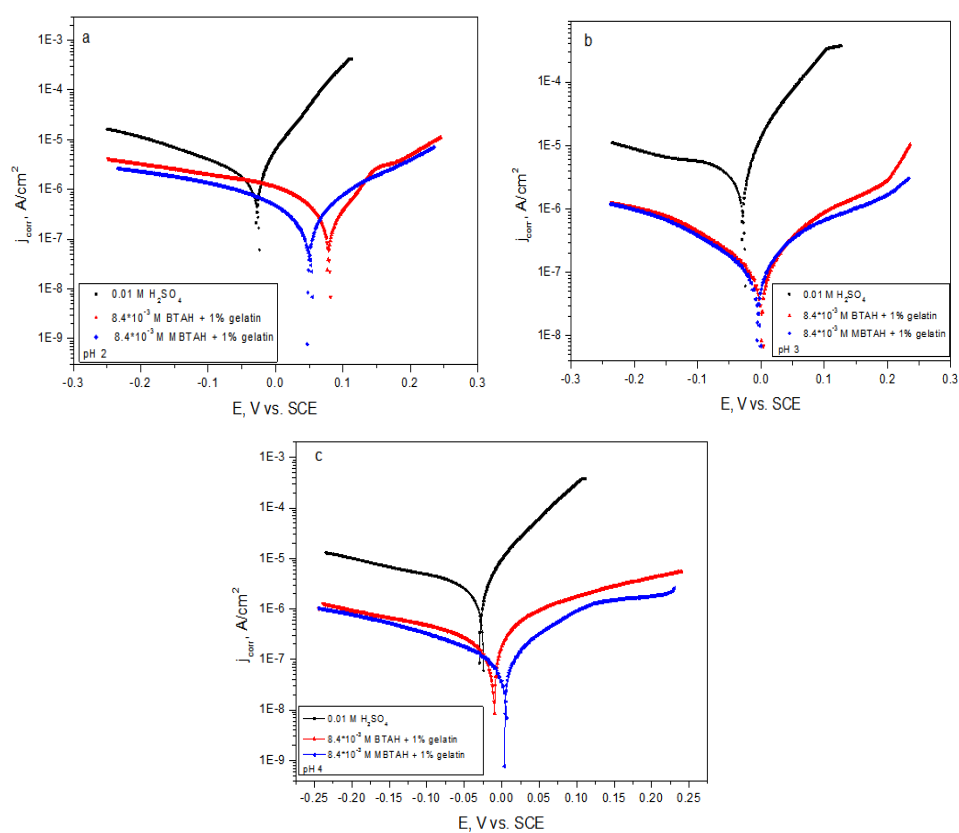
### Potentiodynamic polarization measurements of copper

Corrosion parameters of copper such as corrosion potential ( $E_{\text{corr}}$ ), corrosion current density ( $j_{\text{corr}}$ ), anodic and cathodic Tafel slopes ( $b_a$  i  $b_c$ ) were calculated based on the polarization curves (Figures 2a, b, c) and summarized in Table 1.

The inhibition efficiency is calculated according to the equation (6) [15]:

$$\%IE = \frac{j_{\text{corr}} - j_{\text{corr(inh)}}}{j_{\text{corr}}} \times 100 \quad (6)$$

Where  $j_{\text{corr}}$  and  $j_{\text{corr(inh)}}$  are the corrosion current densities in the absence and presence of investigated binary inhibitors.



**Figure 2.** Potentiodynamic polarization curves of copper in 0.01 M  $\text{H}_2\text{SO}_4$  in the presence of mixed inhibitor of azoles (BTAH, MBTAH) and gelatin at pH 2 (a), at pH 3 (b) and at pH 4 (c)

**Table 1.** Electrochemical parameters of copper corrosion in 0.01 M H<sub>2</sub>SO<sub>4</sub> in the presence of binary mixed inhibitors (8.4·10<sup>-3</sup> M BTAH with 1% gelatin as well as 8.4·10<sup>-3</sup> M MBTAH with 1% gelatin) at different pH values

Medium	pH	E <sub>OCP</sub> , V vs SCE	E <sub>corr</sub> , V vs SCE	j <sub>corr</sub> , μA/cm <sup>2</sup>	b <sub>a</sub> , V	-b <sub>c</sub> , V	%IE
0.01 M H <sub>2</sub> SO <sub>4</sub>	2	-0.026	-0.03	1.84	0.045	0.136	/
0.01 M H <sub>2</sub> SO <sub>4</sub>	3	-0.028	-0.03	1.47	0.026	0.066	/
0.01 M H <sub>2</sub> SO <sub>4</sub>	4	-0.031	-0.029	1.24	0.038	0.117	/
BTAH + gelatin	2	0.079	0.077	0.109	0.039	0.039	94.1
MBTAH + gelatin	2	0.0502	0.050	0.0833	0.038	0.057	95.5
BTAH + gelatin	3	0.0065	-0.0017	0.0492	0.049	0.063	96.6
MBTAH + gelatin	3	0.021	-0.0049	0.0427	0.030	0.064	97.1
BTAH + gelatin	4	-0.0017	-0.011	0.0449	0.020	0.033	96.4
MBTAH + gelatin	4	0.0037	0.0053	0.0376	0.038	0.079	97.0

Potentiodynamic polarization measurements were performed in sulfate solution with the addition of mixed inhibitors (azoles with gelatin) in a pH range from 2.0 up to 4.0. According to the data in Table 1, binary inhibitor system offer high inhibition efficiency at all investigated pH values. The change of E<sub>corr</sub> in sulfate solution with the addition of BTAH/MBTAH and gelatin is less than 85 mV. This suggests that binary inhibitor system acts as mixed type inhibitor at different pH values [16]. The values of both anodic and cathodic Tafel slopes are changed in the presence of inhibitors which indicate the adsorption of organic compounds on the copper surface. However, as the pH value increases the inhibition efficiency of investigated inhibitors slightly increase. pK<sub>a</sub> of gelatin is around 4.7 and as the pH of the solution become closer to this value, the gelatin molecule becomes less charged and thus less soluble in the aqueous solution. So, it is proposed that bonds between molecules of inhibitors become weaker and as a consequence, the protective film is less stable and less adsorbed on the metal surface. Due to these facts, the inhibition efficiency of mixed inhibitor at pH 3 and pH 4 is almost equal.

It should be noted that with increasing the pH value of inhibitor-free medium, the corrosion current density decreases. This could be related to decrease in the aggressiveness of sulfate solution.

The obtained results refer that the higher protection degree of copper in aggressive medium is achieved in the presence of MBTAH and gelatin in comparison with BTAH and gelatin. The presence of methyl group in MBTAH which has positive inductive effect makes the lone electron all the time on nitrogen atom and provides a good chance for coordination bond with copper surface [17].

## CONCLUSION

Binary inhibitor system containing azoles (BTAH, MBTAH) and gelatin can be considered as effective corrosion inhibitor for copper in 0.01 M H<sub>2</sub>SO<sub>4</sub> solution at different pH values. The open circuit potential of copper, in the presence of investigated compounds at different pH values, is shifted toward noble values compared to the inhibitor-free solution. According to the results obtained by potentiodynamic polarization measurements binary inhibitor system acts as mixed-type inhibitor. Cyclic voltammetric measurements confirmed that these compounds efficiently protect copper surface against aggressive solutions.

## Acknowledgement

*The authors gratefully acknowledge the financial support of the Ministry of Education, Science and Technological Development of Republic of Serbia through the Project No 172031.*

## REFERENCES

1. Wang, Y-H, He, J-B, Corrosion inhibition of copper by sodium phytate in NaOH solution: Cyclic voltabsorptometry for in situ monitoring of soluble corrosion products, *Electrochimica Acta* 66, 45-51, 2012
2. Cubillos, M, Sancy, M, Pavez, J, Vargas, E, Urzua, R, Henriquez-Roman, J, Tribollet B., Zagal J. H., Paez M. A., Influence of 8-aminoquinoline on the corrosion behaviour of copper in 0.1 M NaCl, *Electrochimica Acta* 55, 2782-2792, 2010
3. Maayta, A, Al-Rawashdeh, N, Inhibition of acidic corrosion of pure aluminum by some organic compounds, *Corrosion Science* 46, 1129-1140, 2004
4. Dermaj, A, Hajjaji, N, Joiret, S, Rahmouni, K, Srhiri, A, Takenouti, H, Vivier, V, Electrochemical and spectroscopic evidences of corrosion inhibition of bronze by a triazole derivative, *Electrochimica Acta* 52, 4654-4662, 2007
5. Petrovic, M, Simonovic, A, Radovanovic, M, Milic, S, Antonijevic, M, Influence of purine on copper behavior in neutral and alkaline sulfate solutions, *Chemical Papers* 66, 664-676, 2012
6. Ridhwan, A, Rahim, A, Shah, A, Synergistic effect of halide ions on the corrosion inhibition of mild steel hydrochloric acid using mangrove tannin, *International Journal of Electrochemical Science* 7, 8091-8104, 2012
7. Milosev, I, Pavlinac, J, Hodošček, M, Lesar, A, Amino acids as corrosion inhibitors for copper in acidic medium: Experimental and theoretical study, *Journal of the Serbian Chemical Society* 78, 2069-2086, 2013
8. Finsgar, M, Milosev, I, Inhibition of copper corrosion by 1,2,3-benzotriazole: A review, *Corrosion Science* 52, 2737-2749, 2010
9. Meudre, C, Ricq, L, Hihn, J-Y, Moutarlier, V, Monnin, A, Heintz, O, Adsorption of gelatin during electrodeposition of copper and tin-copper alloys from acid sulfate electrolyte, *Surface and Coatings Technology* 252, 93-101, 2014



10. Antonijevic, M, Milic, S, Dimitrijevic, M, Petrovic, M, Radovanovic, M, Stamenkovic, A, The influence of pH and chlorides on electrochemical behavior of copper in the presence of benzotriazole, *International Journal of Electrochemical Science* 4, 962-979, 2009
11. Moretti, G, Guidi, F, Tryptophan as copper corrosion inhibitor in 0.5 M aerated sulfuric acid, *Corrosion Science* 44, 1995-2011, 2002
12. Khaled, K, Guanidine derivative as a new corrosion inhibitor for copper in 3% NaCl solution, *Materials Chemistry and Physics* 112, 104-111, 2008
13. Badawy, W, Ismail, K, Fathi, A, The influence of the copper/nickel ratio on the electrochemical behavior of Cu-Ni alloys in acidic sulfate solutions, *Journal of Alloys and Compounds* 484, 365-370, 2009
14. Metikos-Hukovic, M, Babic, R, Paic, I, Copper corrosion at various pH values with and without the inhibitor, *Journal of Applied Electrochemistry* 30, 617-624, 2000
15. Musa, A, Kadhun, A, Mohamed, A, Takriff, M, Experimental and theoretical study on the inhibition performance of triazole compounds for mild steel corrosion, *Corrosion Science* 52, 3331-3340, 2011
16. Oguzie, E, Li, Y, Wang, F, Effect of 2-amino-3-mercaptopropanoic acid (cysteine) on the corrosion behavior of low carbon steel in sulphuric acid, *Electrochimica Acta* 53, 909-914, 2007
17. Al Kharafi, F, M, El-Shamy, A, Ateya, B, Comparative effects of tolytriazole and benzotriazole against sulfide attack on copper, *International Journal of Electrochemical Science* 4, 1351-1364, 2009



## CHARACTERIZATION OF PCBs OF COMPUTER AND MOBILE PHONE, RECYCLING AND SEPARATION OF GOLD AND SILVER

Irma Dervisevic<sup>1\*</sup>, A. Dervisevic<sup>2</sup>

<sup>1</sup>University of Prishtina, Faculty of Technical Sciences, Kosovska Mitrovica, SERBIA

<sup>2</sup>State University of New Pazar, Department of Chemical and Technological Science,  
New Pazar, SERBIA

\**irma.dervisevic@pr.ac.rs*

### ABSTRACT

Striving to own the latest model information and telecommunication devices, leading to their rapid technological obsolescence, and production of larger quantities of different electronic waste. Recent data show that the world generates in a year of 40-70 million tones of this waste, while the percentage of recycling is very small. Around 267.3 tons of gold and 7275 tons of silver annually consumed in the production of mobile telephones, personal and notebook computers, and other electronic devices. The paper presents the characterization of printed circuit boards of computers and mobile phones. Qualitative and quantitative composition of samples of printed circuit boards were determined using the method: X-ray fluorescence X-ray fluorescence spectrometry (XRF), optical emission spectrometry with inductively coupled plasma (ICP-OES) and scanning electron microscopy (SEM) with energy dispersive spectrometry (EDS). Based on the results is presented the modified procedure of recycling printed circuit boards of computers and mobile phones and separation and recycling of gold and silver.

**Key words:** characterization, PCBs, separation, recycling, gold, silver.

### INTRODUCTION

A wide range of obsolete electrical and electronic devices makes EE - waste. He is growing globally at a rate of 3 to 5% per year, making it the fastest growing waste on the planet. Old data of UNEP [1] estimate that 20-50 million tons of e-waste is discarded worldwide every year. That's an average of 35 million tons or 4,000 tones per hour. According to the data of [2] quantities of electronic waste in the world are significantly larger and amount to 40 - 70 million tons annually. However, the problem is not only in quantity but also the toxicity of the waste constituents that pose a grave danger to the environment and human health. One of the priorities of the European Union is to protect the environment and improve the process of recycling electronic waste, with particular reference to the hierarchical approach to waste management in general, which is reflected in waste prevention – reduce,, reuse and recycling of electronic waste [3]. The concentration of metals in discarded EE-waste is greater than the minimum concentration of these metals in ores [4], so that materials intended for recycling are an

important source of valuable raw materials and make the recycling process economically justified [5]. At present, we are far from a closed system of material cycles, recycling or the possible benefit enormously [6]. Waste electrical and electronic equipment includes a particularly complex waste stream in terms of diversity, because it contains inorganic and organic substances (metals, plastics, glass and other components), thereby, in the processing of EE waste, a substance may be hazardous [7]. The process of recycling and utilization of materials is very complex [8-10] and is often accompanied by emission of harmful substances into the environment and the working environment [11]. From e-waste, less than 15% metals are being recuperated world over [12]. Recycling electronic waste is a complex process, because in most electronic devices there are a number of different components (materials) in a relatively small area [13], which depends on the type and method of treatment, to a greater or lesser extent, affect human health and the life in both programs. The degree of danger, and the impact on human health, especially the workers directly involved in the recycling process and the indirect impact on the environment varies greatly, depending on the specifics of individual recycling process [7]. The rapid development of recycling technology is based in ecological and economic justification of disposal of such waste. This was helped by knowing how the final stocks of non-renewable raw materials and the need for their rational use, as well as on environmental protection. Rich and developed countries were the first to realize the disposal of electronic waste, and therefore the forefront in the development and implementation of recycling [14]. Separation materials for recycled provides the reducing the amount of waste material for disposal, saving natural resources, more efficient use of the potential of EE waste, achieved economic benefits, saving money and energy, which is necessary to invest in the extraction and production of these materials, reduces the adverse impact on the environment middle, both directly and indirectly, through the emission of gases (in the processing and production of mineral resources) that cause greenhouse effect. The aim of this study is characterization of potentially polluting, and valuable material in electronic waste and improving recycling process this waste, primarily stem printed circuit boards of computers, laptops and mobile phones.

The concentration of gold in ores is an average of 0.5 to 15 g per ton of ore, while its concentration in the PCBs about 10 times higher (about 150 g / t) [15], or how the [16] stand out: „ in only one ton of discarded computers have more gold than can be extracted from 17 tons of ore”. Precious metals make up more than 80% of the total economic value of PCBs, even when their concentration is less than 1% by weight, recycling of these metals from PCBs is economically feasible [16 and 17].

Separation of recycled, provide conditions for: reducing the amount of waste material for deposit, saving natural resources, more efficient use of the potential of EE waste, achieved economic benefits, saving money and energy, which is necessary to invest in the extraction and production of these materials, reduces the adverse impact on the environment middle, both directly and indirectly, through the emission of gases (in the processing and production of mineral resources) that cause greenhouse effect. The aim of this study is characterization of potentially polluting, and valuable material in electronic waste and improving recycling process this waste, primarily stem printed circuit boards (PCBs) of computers, laptops and mobile phones.

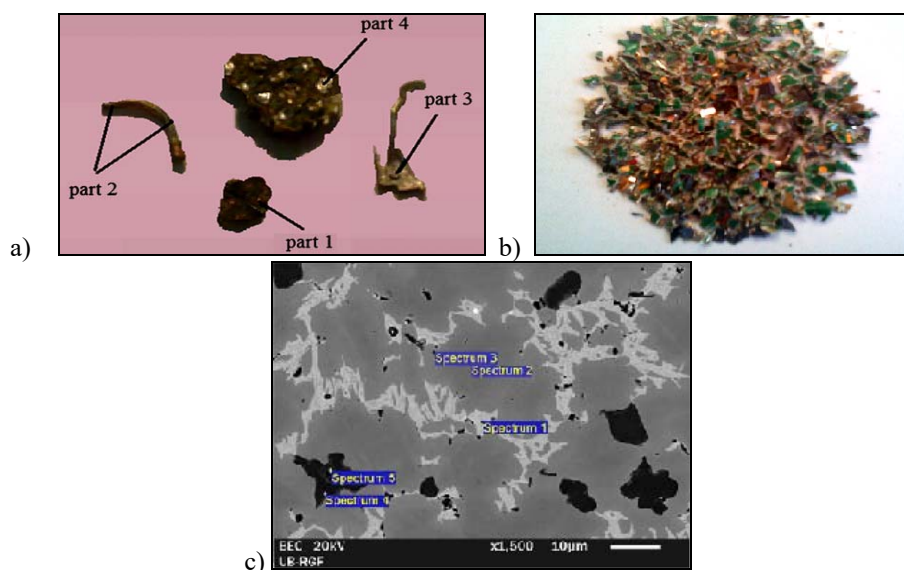
## EXPERIMENT

### Materials and methods

In the experimental part of the investigation are two different types of PCBs, in order to determine whether PCBs of computers and mobile phones contain hazardous and harmful metals such as lead, arsenic, cadmium and others. The goal of the experiment was to determine in which parts of PCBs are concentrated individual metals, because the be separation certain metal parts prior to the melting process, could provide better selectivity and thus better revitalization of some precious metals.

For investigation and characterization of waste and the PCBs computers and mobile phones were used the following methods: separated mechanical parts typical of waste PCBs computers are directly analyzed by X-ray fluorescence spectrometry (XRF), which was used for noninvasive, speed tests and because it does not require prior preparation and melting samples. Testing was performed on: EDXRF spectrometer with CANBERRA Si (Li) detector and  $^{241}\text{Am}$ ,  $^{55}\text{Fe}$ , and  $^{109}\text{Cd}$  excitation sources. Scanning electron microscopy with energy dispersive spectroscopy (SEM-EDS) was used for quantitative and qualitative analysis of mechanically separated and melted parts of printed circuit boards and methods of optical emission spectrometry with inductively coupled plasma (ICP-OES) is used as a very accurate analytical method for determination of trace elements in different patterns, which provides speciation isotopes.

Samples PCBs of computer and a mobile phone were formed from mechanically separated parts: granulated and composite parts, contact solders (Figure 1) Metal parts of PCBs are separated,, pulling " with pliers, breaking and cutting.



**Figure 1.** Parts of PCBs: a) characteristic parts of computer like contacts, solders[18], and composites were analyzed by XRF spectrometry; b) chopped parts PCBs mobile phone; c) melted metal parts PCBs mobile phone for SEM-EDS analysis[18]

To analyze the composition of PCBs mobile phone, samples were formed from mechanically separated parts of the PCBs, chopped to granules of maximum size up to 3.0 mm, tightly sealed in quartz tubes and melted in an induction furnace (gradual heating up to 1200 °C).

## RESULT AND DISCUSSION

In many studies that dealt with determining the content of precious metal in the PCBs from different categories of EE waste, it was pointed out that the highest content of precious metals located on PCBs computers and mobile phones [19-22]. In addition to silver, which is primarily used for switches and contacts, and the PCBs are represented with 0.1% [15], gold is economically the most valuable component is used for wires in integrated circuits, as a coating for connectors or solder in integrated circuits, in the alloy with tin [15], are also used palladium, platinum, rhodium and iridium.

The results of quantitative and qualitative analysis of samples PCBs investigated in this paper, with different methods, are shown in Table 1.

**Table 1.** The results of quantitative and qualitative analysis of samples PCBs investigated in this paper, with different methods, are shown in Table 1

Chemical composition of PCBs	The methods used for quantitative and qualitative analysis										
	SEM-EDS Y <sub>1</sub> (mas.%) Mob.tel.*					ICP (mas.%)	XRF (mas.%) PC*				
	Spec. 1	Spec. 2	Spec. 3	Spec. 4	Spec. 5	Mob.tel.	1 deo	2 deo	2 deo	3 deo	4 deo
Ag	1,76	1,48	2,57	-	-	0,39	-	7,149	13,976	4,374	5,696
Al	0,46	0,54	0,51	-	1,95	0,05	-	-	-	-	-
Au	0,99	0,12	0,34	-	-	0,018	-	18,892	44,123	-	-
Ba	-	-	-	-	-	0,48	-	-	-	-	-
Ca	-	-	-	-	-	0,07	-	-	-	-	-
Co	-	-	-	-	-	0,10	-	-	-	-	-
Cr	-	-	-	0,61	1,98	1,08	-	-	-	-	-
Cu	60,52	75,06	71,75	7,09	5,45	62,81	61,735	71,438	32,019	62,939	43,677
Fe	-	0,68	0,53	38,64	32,98	9,09	-	-	-	-	-
Mg	-	-	-	-	-	0,01	-	-	-	-	-
Mo	-	-	-	-	-	0,01	-	-	-	-	-
Mn	-	-	-	-	-	0,05	-	-	-	-	-
Ni	1,06	1,57	1,25	23,24	25,77	3,37	11,635	-	-	-	-
Pb	11,32	3,16	3,89	-	-	8,96	-	-	-	15,442	19,820
Pd	1,12	2,98	3,13	-	-	0,01	4,970	-	-	-	-
Pt	-	-	-	-	-	3,0E-7	-	-	1,893	-	-
Rh	-	-	-	-	-	0,002	-	2,521	7,989	-	-
Si	0,71	2,18	2,50	28,11	31,87	0,03	-	-	-	-	-
Sn	15,09	1,02	3,49	-	-	5,47	14,251	-	-	11,769	24,586
Sr	-	-	-	-	-	0,09	-	-	-	-	-
Ti	-	-	-	-	-	0,2	-	-	-	-	-
V	-	-	-	-	-	0,004	-	-	-	-	-
Y	-	-	-	-	-	0,002	-	-	-	-	-
Zr	-	-	-	-	-	0,02	-	-	-	-	-
Zn	4,46	9,49	9,11	2,31	-	7,75	7,391	-	-	5,476	6,221

Based on the analysis results shown in Table 1, it can be concluded that the content of precious metals, Ag, Au, Pd, Pt and Rh, is much higher in a special separate parts PCBs computer, such as contacts and composite parts, but in mobile phones and metal content varies from sample to sample and highly depends on the location of the analysis. Gold has the most in a separate composite Part 2, in which in addition to Cu, present Ag, Pt and Rh. Silver is also present in parts 3 and 4, and the presence of Pd was detected in part 1. These characteristic parts of the PCBs computer is necessary, if possible, set aside in the phase of dismantling and pre smelting process and treat them in a special recycling process, in order to achieve better efficiency in the revitalization of metal. Extracting these parts slows down the process of recycling, but provides better selectivity and easier recovery of valuable metals.

To extract gold and silver from used electronic devices submitted a modified procedure of dissolving the recycling of [18] metal parts PCBs in razbleženoj nitric acid (eg. 100 ml of dilute HNO<sub>3</sub> is obtained from 70 ml of distilled water and 30 ml 68% HNO<sub>3</sub>). The solution was heated to a temperature of 60-85 °C; gold and platinum are deposited in the form of a fine precipitate, and other metals, such as Ag, Pd, Ni, Zn, Pb, Cu pass into solution. After careful decanting and filtering, the solution remain, in addition to other metals worth of silver and palladium. Silver from the solution may be precipitated in the solution by inserting the rod of pure copper, in which remain in solution until the solution appeared in the air bubbles, and can be up to 24 h. The precipitate was (and in the case of the deposited gold) potrbno carefully decant and rinse with warm water 3-5 times, while the decanted water is completely clear and clean. The pellet is then carefully dried, and melted. At the end of the melting add a little borax, to molten gold and silver get a nice glow.

## CONCLUSION

In order to increase the efficiency of recyclable components from electronic waste, and establishing optimal recycling process, which should provide an effective and affordable methods of recycling, primarily rejected the PCBs, in the paper is analyzed, separated metal parts of computer, as well as complete PCBs of mobile phones, from which removed are mounted components, such as capacitors and resistors. The results of quantitative and qualitative analysis of samples PCBs with different methods, are presented in this paper. Also in work is proposed modified technological process the recycling, which correspond to requirements and technological solutions developed world.

## *Acknowledgments*

*This research is conducted as a part of project No. III 43007 Global Climate Change Impact the Environment: Adaptation, Mitigation; and no. TR 37016 Lead and zinc production impact on the Environment. This study is supported by the Ministry of Education, Science and Technological development of the Republic of Serbia.*

## REFERENCES

1. United Nations Environment Program (UNEP), Division of Technology, Industry, and Economics, International Environmental Technology Center, E-waste volume I: inventory assessment manual. 2007. Available at: [http://www.unep.org/ietc/Portals/136/Publications/Waste%20Management/EWasteManual\\_Vol1.pdf/2014/okt/](http://www.unep.org/ietc/Portals/136/Publications/Waste%20Management/EWasteManual_Vol1.pdf/2014/okt/)
2. Rajya Sabha Secretariat Incipient Delhi: 'E-waste in India' Research Unit [LAARDIS] (2011).
3. European Union Directive 2002/96/EC of the European Parliament and of the Council of 27 January 2003 on Waste Electrical and Electronic Equipment (WEEE) Brussels: Office for Official Publications of the European Communities; 2002.
4. Johnson J., Harper E.M., Lifset R., Graedel T.E.: Dining at the periodic table: Metals concentrations as they relate to recycling, *Environmental Science and Technology*, 41 (5) pp. 1759–1765 (2007).
5. Dahmus J.B., Gutowski T.G.: What gets recycled: An information theory based model for product recycling, *Environmental Science and Technology*, 41 (21) pp. 7543–7550 (2007).
6. Reck B.K., Graedel T.E.: Challenges in metal recycling, *Science*, 337 (6095) pp. 690–695 (2012).
7. Tsydenova O., Bengtsson M.: Chemical hazards associated with treatment of waste electrical and electronic equipment, *Waste Management*, 31 (1) pp. 45–58 (2011).
8. Wu J., Li J., Xu Z.: Electrostatic separation for recovering metals and nonmetals from waste printed circuit board: Problems and improvements, *Environmental Science and Technology*, 42 (14) pp. 5272–5276 (2008).
9. Barbieri L., Giovanardi R., Lancellotti I., Michelazzi M.: A new environmentally friendly process for the recovery of gold from electronic waste, *Environmental Chemistry Letters*, 8 (2) pp. 171–178 (2010).
10. Hou, S., Wu, J., Qin, Y., Xu, Z.: Electrostatic separation for recycling waste printed circuit board: A study on external factor and a robust design for optimization, *Environmental Science and Technology*, 44 (13) pp. 5177–5181 (2010).
11. Sepúlveda A., Schluep M., Renaud F.G., Streicher M., Kuehr R., Hagelüken C., Gerecke A.C.: A review of the environmental fate and effects of hazardous substances released from electrical and electronic equipments during recycling: examples from China and India, *Environmental Impact Assessment Review*, 30 (1) pp. 28–41(2010).
12. United Nations University, 2009. Set World Standards for Electronics Recycling, Reuse to Curb E-waste Exports to Developing Countries, Experts Urge. *Science Daily*.  
<<http://www.sciencedaily.com/releases/2009/09/090915140919.htm>>(last accessed on 25.12.15

13. Ijomah W.L., Chiodo J.D.: Application of active disassembly to extend profitable remanufacturing in small electrical and electronic products, *International Journal of Sustainable Engineering*, 3 (4) pp. 246–257 (2010).
14. Robinson B.H.: E-waste: An assessment of global production and environmental impacts, *Science of the Total Environment*, 408 (2) pp. 183–191 (2009).
15. Jiuyong G., Jie G., Zhenming X.: Recycling of non-metallic fractions from waste printed circuit boards: A review, *Journal of Hazardous Materials*, 168 (2–3) pp. 567–590 (2009).
16. Park Y.J., Fray D.J.: Recovery of high purity precious metals from printed circuit boards, *Journal of Hazardous Materials*, 164 (2–3) pp. 1152–1158 (2009).
17. Eswaraiyah C., Kavitha T., Vidyasagar S., Narayanan S.S.: Classification of metals and plastics from printed circuit boards (PCB) using air classifier, *Chemical Engineering and Processing: Process Intensification*, 47, (4), 565–576 (2008).
18. Dervišević I., Minić D., Kamberović Ž., Čosović V., Ristić M.: Characterization of PCBs from computers and mobile phones, and the proposal of newly developed materials for substitution of gold, lead and arsenic, *Environ. Sci. Pollut. Res.*, 20, 4278–4292, (2013).
19. Zhou, Y., Qiu, K.: A new technology for recycling materials from waste printed circuit boards, *Journal of Hazardous Materials*, 175, (1–3), 823–828 (2010).
20. Lee J., Kim Y., Lee J.-C.: Disassembly and physical separation of electric/electronic components layered in printed circuit boards (PCB), *Journal of Hazardous Materials*, 241–242, pp. 387–394 (2012)..
21. Yang J., Xiang D., Wang J., Duan G., Zhang H.-c.: Removal force models for component disassembly from waste printed circuit board Resources, *Conservation and Recycling*, 53 (8) pp. 448–454 (2009).
22. Xiu F.-R., Zhang F.-S.: Materials recovery from waste printed circuit boards by supercritical methanol, *Journal of Hazardous Materials*, 178, (1–3), pp. 628–634 (2010)





## USABILITY OF TOBACCO WASTE IN RECONSTITUTED TOBACCO PRODUCTION

Gordana Kulic<sup>1\*</sup>, V. Radojicic<sup>1</sup>, S. Alagic<sup>2</sup>, M. Malnar<sup>1</sup>, N. Mandic<sup>1</sup>

<sup>1</sup>University of Belgrade, Faculty of Agriculture, Belgrade, SERBIA

<sup>2</sup>University of Belgrade, Technical faculty, Bor, SERBIA

\**gkulic@agrif.bg.ac.rs*

### ABSTRACT

Cigarette manufacturers, mainly because of various claims about the dangers of smoking to human health and the environment, strive to use modern technological methods of producing cigarettes with a lower health risk. Trends of modern production include the development of a new generation of products, so-called global cigarette. Global cigarette involves producing a new type of reconstituted tobacco (RECON), with particular physical and chemical properties, which would be the only filler for cigarettes. All cigarettes would produce the same smoke, and the character of the individual brands or the variation in the quality and characteristics of smoking, would be secured with a special kind of flavor.

The goal of this work is to determine the value of tobacco reuse from industrial plants in the Republic of Serbia, in the manufacturing of reconstituted tobacco.

**Key words:** reconstituted tobacco (RECON), tobacco scrap, tobacco dust, midrib, use value.

### INTRODUCTION

All components of mixtures for making cigarettes are different, in their physical and chemical composition. Therefore, the selection of tobacco and the determination of their share in the mixture are made on the basis of the understanding of how the actions of all factors unified within the so-called they use value (1). The use value is determined by the role of the individual in a mixture of tobacco, and consequently, the amount of which will be represented in it on the basis of three groups of factors: the economy in the making, chemical quality and smoking quality (2). In the domestic and world market dominate blend cigarettes (so-called American blend). This type of cigarette contains three main tobacco types: SC (oriental tobacco), AC (Burley) and FC (Virginia). In addition to these three types of tobacco, modern technological manufacturing techniques blend cigarettes, also include the use of expanded midrib and reconstituted tobacco.

During the manipulation and fermentation, tobacco, due to different mechanical treatments, breaks and crumbles, so it remains a certain amount of waste resulting from tobacco lamina or midribs. Also, during the production of cigarettes, in the fabrication, appears a certain amount of tobacco scraps and dust. The above-mentioned waste can be

used as raw material for the production of nicotine, tobacco by-products and reconstituted tobacco.

Tobacco foil (reconstituted tobacco or RECON) is a tobacco-based product which should correspond to the tobacco leaf, according to physical and chemical characteristics (Picture 1). It is made from tobacco scrap, tobacco dust, cellulose and related connective material (1). In the cigarette manufacturing, RECON is added before blending, so it cuts together with the tobacco. Its application is a primarily solution for the reduction of losses in production, by re-using waste generated in the process of threshing, scraps from processing and preparation storages, scrap from tobacco cigarettes and from tobacco with bad properties. Optimum results in terms of taste properties are obtained when using 25-30% of RECON in a mixture of cigarette (3).

Reconstituted tobacco was first used in the original Winston mixture in 1954, and until 1960 it has been used by all US companies. Initially, the main purpose of its use has been to save the money. From the aspect of economy important fact is that the price of making a reconstituted tobacco is less from the price of purchase the same quantity of tobacco leaf (3). Since 1965, the application of the RECON has become much more important, due to published results of the reduced activity of its smoke compared to natural tobacco smoke (4). On the other hand, publishing the results on the relationship between smoke and physical properties of the RECON (5) opened the opportunities for the development of new and improvement existing processes for its production.



**Figure 1.** Reconstituted tobacco (6)

Reconstituted tobacco in addition to economic benefits has technological advantages too. Technologically speaking, the RECON is a suitable material for use, as it is easier and more evenly dosed into the mixture. RECON thickness is determined by the amount of pulp applied to the conveyor, and after the drying process should not exceed the value of 0,2 mm. It is considered satisfactory if the value of the thickness ranges is between 0,140 to 0,155 mm. Tearing resistance after cutting should be at more than 700 mm VS. The moisture content should be 12 - 14%. Lower values are not suitable because the RECON slowly absorbs moisture, and less is retained. In addition, lower moisture content affects the production of large amounts of dust during cutting. Given that reconstituted tobacco has good filling power (from 2 cm<sup>3</sup>/g, when RECON has a normal density, to 11 cm<sup>3</sup>/g, with reduced density), the main purpose is to reduce the

required mass of material in a cigarette, and thus affect the reduction in total production of smoke. According to the research (7), the companies that produce the cigarettes using the RECON, have reduced the required amount of tobacco by 27%, in the period 1960-1999.

The use of reconstituted tobacco in a mixture of cigarettes primarily affects the increase of filling power. Reducing the amount of material which is burned in cigarette automatically decreases the amount of formed smoke. The main objective of the use of RECON in the mixture is to change smoke characteristic with compliancy to legislation related to the maximum permissible content of harmful substances in tobacco smoke (2).

## **MATERIALS AND METHODS**

For the purposes of the experiment we used tobacco waste from industrial plants in the Republic of Serbia, according to the following classification:

1. Waste from the processing of tobacco - scrap from manipulation, tobacco purchase and processing.
2. Waste from cigarette manufacture – generated during handling in the fabrication, the tobacco dust which is separated by cyclones in the preparation, and the tobacco dust which is separated on the cigarette machine filters.
3. Tobacco midribs - parts of tobacco leaf which are separated in the process of threshing, and that are classified as waste, because it does not meet the criteria related to length.

In the experiment was used tobacco waste in which, according to the basic requirements of quality of waste, there weren't pebbles and sand granulation through 0,1 mm, and other foreign objects that reduce use value or completely exclude the use of such material.

Within the analysis of the chemical composition of the starting raw materials, and manufactured reconstituted tobacco was performed to determine the pH, nicotine, ash, total proteins and protein nitrogen, total nitrogen, soluble sugars and total reduction. All analyzes were performed according to SRPS -ISO methods.

Specific weight and the equilibrium moisture content of samples were performed within the analysis of physical properties of the starting raw material. Physical properties of manufactured reconstituted tobacco, such as tearing resistance, thickness, specific weight and filling power, were determined by CORESTA methods.

Chemical properties of cigarette smoke that is made from pure RECON were determined, after smoking a cigarette on the smoking machine, according to SRPS ISO methods. Sensory properties of cigarette smoke were done according to Sozonović-tasting key (8).

## **RESULTS AND DISCUSSION**

### **Physical properties of tobacco waste**

Given the importance of these qualities in the production of cigarettes, specific weight and equilibrium moisture content have been examined. Other physical properties

have not been tested because tobacco waste is non-unique part of tobacco leaves, different shapes and sizes.

**Table 1.** Physical properties of tobacco waste

Sample	Specific weight (g/cm <sup>3</sup> )	Equilibrium moisture content (%)
Scrap	1,491	15,38
Midribs	1,509	24,82
Waste from fabrication	1,521	18,79

Specific weight of tobacco affects all processes during fabrication and it is important for the physical characteristics of cigarettes (weight) and chemical and sensory characteristics of smoke (the amount of products depends on the amounts of precursor). Specific weight of tobacco waste has a direct impact on the amounts that will be used in the production of reconstituted tobacco. This value depends on the chemical composition of tobacco, especially by the specific content of heavier materials such as lignin and ash. In process of making reconstituted tobacco it is allowed approximately 10 % of mineral dust. This dust is difficult to remove during the process of waste preparation, but they have a significant effect on the specific weight of RECON. Based on the data presented in Table 1, tobacco waste are in the category of specifically heavier tobacco.

Equilibrium moisture content is of great importance to the material's resistance to physical treatments during the processing of tobacco, and for the correct formation of a cheese (compacted tobacco in hopper before slicing) for cutting tobacco. Equilibrium moisture content of tobacco waste is different (Table 1), which is quite understandable because we used different parts of tobacco leaf in the experiment. These parts vary significantly in their chemical composition, in particular by the content of colloid and crystalloid substances, and thus by its physical structure (9). From Table 1 it is evident that the maximum equilibrium moisture content is highest in tobacco midribs, followed by waste from fabrication of cigarettes, and at the end, minimum in scrap.

#### Chemical properties of tobacco waste

**Table 2.** Chemical properties of tobacco waste (%)

Tobacco waste	Moisture	Ash	pH	Nicotine	N-total	N-protein	Total proteins	Soluble sugars	Total reduction
Scrap	9,65	18,80	6,1	0,70	2,53	1,40	8,75	2,42	5,32
Midribs	13,75	18,67	5,5	0,34	2,00	0,90	5,62	3,93	9,38
Waste from fabrication	10,80	20,40	5,5	0,89	2,56	1,45	9,06	5,41	10,90

\*pH is given in units

Chemical properties of the waste are shown in Table 2. It is evident that the waste is a mixture of different tobacco varieties and different parts of the leaf. Results represented in Table 2, show that the content of mineral substances in scrap has increased by 0,13 % compared to their content in tobacco midribs, and lowered by 1,6 % compared to the content of the waste from the fabrication of cigarettes. It is the same

thing with the protein content. A little content of soluble sugars (2,42 %) and the total reduction (5,32 %) is noticeable. Scrap has low acidity and almost approaches the reaction of the base environment.

The tobacco midribs show a slightly higher acidity of 5,5, the lowest nicotine content (0,34%), protein nitrogen (0,90%) and total proteins (5,62%) but a higher percentage of soluble sugars (3,93%). These properties of tobacco midribs are quite understandable given the fact that in the midribs prevails structure of conductive body (10).

Waste from the fabrication of cigarettes show an inharmonious relationship of chemical substances, which is particularly evident from the ratio of the total proteins and the total reduction. The pH value is in an acidic medium (5,5), but the largest nicotine (0,89%) and soluble sugars (5,41%) content are noticeable.

### Physical properties of RECON

After preparing the waste on a particular recipe, reconstituted tobacco was made, on which were determined physical parameters qualities (Table 3).

**Table 3.** Physical properties of RECON

Tearing resistance (mm VS)	RECON thickness (mm)	Specific weight (g/cm <sup>3</sup> )	Filling power (cm <sup>3</sup> /g)
1284	0,114	1,039	4,80

Testing results of physical parameters indicate that the produced RECON has a thickness of 0,114 mm and a tearing resistance of 1,284 mmVS, which is consistent with the literature data (2). It could be concluded that experimental RECON has a small specific weight and a good filling power.

### Chemical properties of RECON

The content of each component individually and all together is dependent on the quantity and relationships of the basic raw materials. In any case the chemical composition of the reconstituted tobacco should be within the limits of the content of components that are characteristic of tobacco as raw material in general. The differences in the chemical composition of initial materials (Table 2) and the RECON (Table 4) are obvious.

During the development of the RECON, the contents of some components may be changed, particularly those that break down under the influence of high temperatures (such as nicotine). In the RECON making process, larger amount of carbohydrates dehydrates. It is similar with the total reduction. It reduces the amount of polyphenols, essential oils and resins (2).

**Table 4.** Chemical properties of RECON (%)

Ash	pH	Nicotine	N-total	N- protein	Total proteins	Soluble sugars	Total reduction
19,29	5,30	1,00	3,07	2,00	12,50	4,99	6,39

pH is given in units

Comparing the values of the content of chemical components we can conclude: preparing the RECON, especially in the drying phase, leads to the evaporation of gases and vapors, primarily ammonia, free nicotine and other volatile acids and bases. As a result, there has been a decrease in pH value of RECON. While preparing the RECON, the amount of total nitrogen increased to 3,07 %, nitrogen protein on 2,00 % and total proteins on 12,50 %. This can be explained by the reduction of dry matter on the one hand and the relative increase of nitrogen complexes on the other. Soluble sugars and in particular the total reduction follows a major change, because part of the components in the preparation dehydrates, which is in accordance with literature data (11). Significant changes in mineral content were not found. Nicotine content is also in the limits shown in the literature (12).

### **Chemical properties of RECON smoke**

At the end of the experiment we made cigarettes from pure RECON. Characteristics of cigarette and smoke (the mean value) are shown in Table 5.

**Table 5.** Characteristics of cigarettes and smoke from RECON

Length of cigarettes (mm)	83
Length of filter (mm)	20
Length of cigarette butt (mm)	25
Weight of cigarettes (g)	0,8325
Draw resistance (mmVS)	71
Draw resistance of filter (mmVS)	42
Moisture (%)	12,11
Number of indentation	9,1
Nicotine in smoke (mg/cig)	0,43
TAR (mg/cig)	11,15

The results represented in Table 5 show that the RECON made of tobacco waste is suitable for cigarette making. The most important part of the results is related to the content of TAR and nicotine in cigarette smoke. Analyses show that cigarette made from pure RECON has a TAR content little above 10 mg/cig, which is the value prescribed by the Tobacco Act of the Republic of Serbia (13). However, further reduction of TAR can be achieved by technological solutions in the production of cigarettes, primarily perforation cigarette paper, filter wrap and tipping paper. Nicotine content of 0,43 % is far below the permissible limit of 1 mg/cig, which is also the value prescribed by the Tobacco Act of the Republic of Serbia.

### **Sensory properties of RECON and cigarette smoke**

Experimental foil which is made in this experiment is elastic, dark and brown. Tasting has established that cigarette smoke made of RECON have moderate physiological strength, without special aroma, and less bitter taste. During smoking it has appeared mild irritation in terms of smoke deposition on the basis of tongue and mild irritation of the throat. Combustion is very good; the ash is compact, white-grey color.

## CONCLUSIONS

According to the results of this experiment we can conclude:

On the basis of all three groups of parameters that define the use value of the components in the mixture, waste from the manipulation, processing and fabrication of tobacco can be used for the production of reconstituted tobacco.

The obtained RECON has good filling power (4,80 cm<sup>3</sup>/g) which meets the economic aspect of use value. Reducing the amount of material that fills the cigarette also reduces the amount of burning material, and thus the quantity of total cigarette smoke.

The chemical composition of the RECON was also satisfying, which is directly reflected on the sensory characteristics of smoke. Mild irritation and lack of aroma can be overcome by adjusting the percentage of individual categories of tobacco waste, as well as the addition of suitable additives.

Nicotine content in smoke (0,43 %) is far below the permissible limit of 1 mg/cig, which is the value prescribed by the Tobacco Act of the Republic of Serbia. The content of the TAR is above 10 mg/cig, but further reduction can be achieved by technological solutions in the manufacture of cigarettes, especially perforation of cigarette paper, filter wrap and tipping paper.

The participation of high-quality reconstituted tobacco in cigarette blends is growing, and bearing in mind the large amounts of waste and contemporary trends in production, it acquires great importance in correcting the physical, chemical and sensory characteristics of smoke.

## REFERENCES

1. Nikolić, M.: Tehnologija prerade duvana. Beograd, 2004.
2. Đulančić, N.: Obrada i prerada duvana, Udžbenik. Univerzitet u Sarajevu, Poljoprivredno – prehrambeni fakultet, 2014.
3. Radojičić, V., Nikolić, M.: Konceptija "sigurne" cigarete. Bilten za hmelj, sirak i lekovito bilje 35/36 (76-77), 21-30, 2003/2004.
4. Wynder, L.E., Hoffman, D.: Reduction of technorigenicity of cigarette smoke. JAMA. 192, 88-94, 1965.
5. Moshy, R.J.: Smoke and physical structure: A new dimension in tobacco technology. Tobacco 162, No 1, p 22, 1966.
6. Alić-Đemidžić, N., Beljo, J., Đemidžić, M.: Tehnologija obrade i prerade duvana. Fabrika duvana Sarajevo, 1999.
7. Capehart, T.: USDA Economic Research Service, Tobacco Situation and Outlook, 2000.
8. Radojičić V.: Modifikovanje sastava duvanskog dima procesima katalitičkog krekinga. Doktorska disertacija, Univerzitet u Beogradu, Poljoprivredni fakultet, Beograd, 2006.
9. Vladimir, I., Bauman I., Đaković, Z.: Utjecaj položaja lista na stabiljici i kemijskog sastava na vododržnu sposobnost. Radovi Poljoprivredno-prehrambenog fakulteta, Univerziteta u Sarajevu, 59/1, 157-166, 2008.

10. Uzunoski, M.: Proizvodnja duvana. Fond duvana i duvanskih prerađevina-Beograd, Niš (1987).
11. Đulančić, N.: Uticaj rekonstituisanog duhana na sastav dima. Radovi Poljoprivrednog fakulteta, 55/1, 149-155, 2005.
12. Radojičić, V.: Kontrola kvaliteta duvana. Praktikum iz tehnologije obrade duvana. Univerzitet u Beogradu, Poljoprivredni fakultet, Beograd, 2011.
13. Zakon o duvanu ("Službeni glasnik RS", broj 101/2005, 5/2016-usklađeni izn.).





## TREATMENT OF USED TIRES WITHIN THE RTB BOR-GROUP

Miodrag Zikic<sup>1\*</sup>, S. Stojadinovic<sup>1</sup>, R. Pantovic<sup>1</sup>, M. Zivkovic<sup>2</sup>, D. Tanikic<sup>1</sup>

<sup>1</sup>University of Belgrade, Technical faculty in Bor, Vojske Jugoslavije 12,  
19 210 Bor, SERBIA

<sup>2</sup>RBB Bor DOO, Kestenova 8, 19 210 Bor, SERBIA

\*[mzikic@tf.bor.ac.rs](mailto:mzikic@tf.bor.ac.rs)

### ABSTRACT

Problems arising from the large amount of used tires are best resolved by recycling. The biggest recycling challenge is the primary treatment or simple and feasible separation of steel and rubber components of a tire. Once completed, the primary treatment is followed by secondary which considers rubber recycling and steel melting. This article presents primary treatment method which is successfully applied within the RTB Bor Group. A significant amount of used tires is accumulated in RTB Bor group during the years of mining production and new amounts are constantly disposed.

**Key words:** Used tires, recycling.

### INTRODUCTION

The constant increase in haulage needs, at all levels, demands adequate equipment for loading and hauling, which, due to mobility demands, is equipped with rubber tires. As a result, the amount of used tires withdrawn from the use because of decreased reliability and safety issues constantly rises. Rubber tires cannot spontaneously decompose and as a result, on a global level, a large amount of waste tires became a major environmental issue.

Two main aspects of environmental tire problem are occupation of vast land areas for tire disposal and constant danger of fire which cannot be safely and effectively extinguished. Recent event from Spain from May 2016 is a reminder of fire danger. Namely, the largest European tire waste located in Seseña, near Toledo partially caught fire. The waste consumes 100 ha of land and contains over 100 000 t of rubber tires. The battle with fire lasted for 30 h and 9 000 people were evacuated. Actually, it was not possible to efficiently extinguish the fire so the tires which were not under flame were moved and the firefighters just waited for the fire to go out by itself.

RTB Bor was resolving the problem of used tires by burying them under the mine waste dumps. However, during the last several years, the tires are being collected since efficient recycling methods have been developed.

## ON TIRES, IN GENERAL

The structure of standard (radial) haul truck tire and its basic components is given in figure 1.

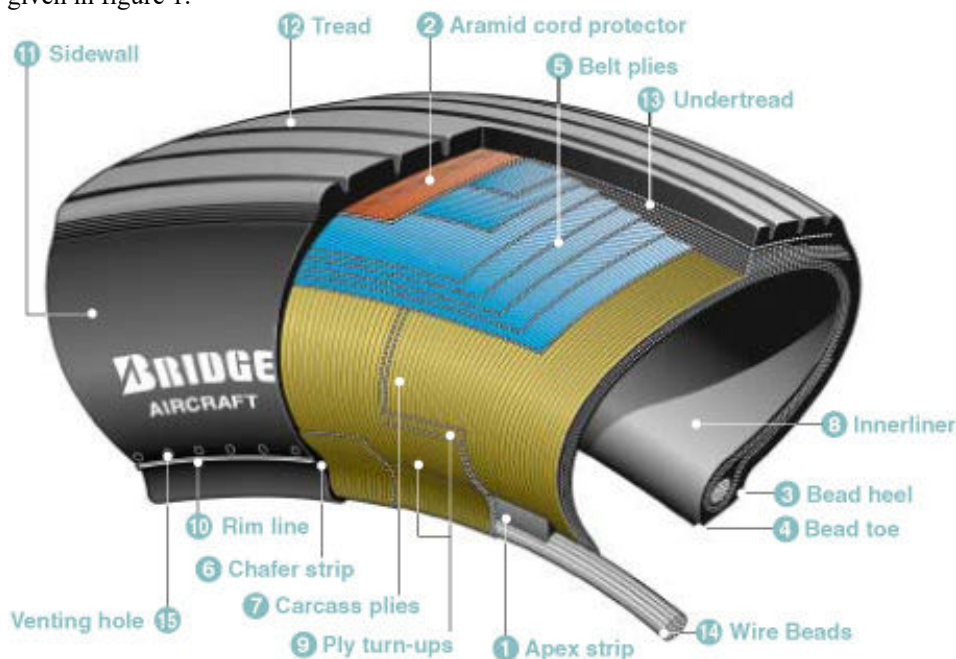


Figure 1. Tire structure

The basic material contained in a tire are steel wire rims (Wire Beads) and rubber (natural and/or synthetic) with addition of other materials (textile plies, carbon, silica...)

## RUBBER TIRES WITHIN THE RTB BOR – GROUP

RTB Bor – Group engages quite a number of equipment with rubber tires, mainly haultrucks at open pit mines Veliki Krivelj and Cerovo and North and South pits Majdanpek. Rubber tires with 33, 36 and 40” diameters are mainly in use and they weigh 5, 5.5 and 8 t (for Bridgestone tires). Having in mind that truck haulage was intensified during 1960-ties a large amount of tires was withdrawn from use during the period of the last 50 years. The precise number of tires is not known and the fact is that the tires were disposed without particular order or plan.

The services of Veliki Krivelj open pit mine have been keeping record on the number of truck tires used at the mine and the results, over the period 20 months from

August 2013 to April 2015, are 111 tires size 40", 69 size 36" and 3 tires size 33" yielding in 1 300 t in truck tires only.

To resolve a problem of waste tires a business and technical cooperation was established with companies dealing with tire recycling. The cooperation resulted in installation of primary treatment facility at the plateau of General overhaul workshop at open pit Bor. The workshop became a center for primary treatment during which steel rims are removed from the tires and remaining rubber is cut into pieces of 500X500 mm approx. size.

Since primary tire treatment in Bor is in final stage the complete facility will be relocated to Majdanpek. It is estimated that more than 4 000 large size tires (33, 36 and 40" size) and more than 500 of small size tires are disposed in Majdanpek. This amount of waste tires will take several years to process and once all of these waste tires are treated the balance between the rate of tire withdraw from the use and the rate of primary treatment will be established. This will eliminate the problem of used tires and all the dangers related to it.

### **TREATMENT OF USED TIRES WITHIN THE RTB BOR – GROUP**

At Veliki Krivelj, the primary treatment of a used tire starts at the very moment when an inspection showed that the tire is not reliable anymore and not safe for further use. At that moment, the wheel bearing a tire is removed from the truck and temporarily disposed at the plateau of the equipment maintenance workshop. Once the necessary conditions are met (i.e. sufficient number of wheels is gathered) the forklift loads the wheels onto a low bed truck trailer to be transported to the General overhaul workshop.

Once at the overhaul workshop the tires are first removed from the wheel rim and disposed at the used tires depot where it waits for further primary treatment.

The primary treatment of used tires runs through several phases and each phase uses specific machines specially designed for that procedure. The phases of treatment are:

- Cutting of the rubber lining of the bead toe
- Removal of steel wire rims
- Cutting of rubber into pieces
- Disposal of cut pieces onto a depot

All machines used during the process are hydraulic, powered by electric motors. The capacity of the machines and the whole facility is 2.5 h per tire or 170 tires per month in three shifts per day operation.

The cutting of rubber lining is performed in order to make access to steel wire rims. The toe is cut in as many positions as many rims are in it (Fig.2). The cut is made along the inner side of the toe in the following manner. The tire is rested horizontally so that cutting machine can be placed in the center. The cutting machine has four hydraulic cylinders (in pairs of two facing opposite directions for balance and support). Hydraulic cylinders carry blades which are pressed into the rubber toe. The cylinders and blades are adjustable in order to ensure use with various tire sizes. Once fully pressed, the cylinders (and the blades) retract and the machine is manually rotated for an angle

allowing partial overlap of new cut with the previous. Once the toe has been cut along the whole circumference the tire is turned to allow access to the second toe.

The second phase is the removal of steel wire rims. Vertically positioned tire is leaned against the shield of the machine used for this phase. The steel wire rims are hooked to the machine and the rims are pulled out by hydraulic cylinders pulling the hooks. First the rims from the inner side are pulled out and then the tire is turned around so the rims from the other side can be hooked and pulled. The result of this operation is the tire without steel (fig.2) which can now be easily cut into pieces. In some cases, the steel wire rim can break during procedure and that tire is then subjected to a bit different treatment.

The third phase of primary tire treatment is rubber cutting. For this purpose, the tire is placed horizontally onto cutting machine. Machine has a hydraulic blade which makes vertical cuts and is coupled with two stationary vertical blades. The tire is cut in the radial direction, and manually rotated after each cut for an angle that will result in a 500 mm long tire section. Each section, as it is too large for further treatment, is additionally cut longitudinally into three pieces roughly 500 x 500 mm in size. These pieces are further manually manipulated.

The tires for which it was not possible to remove the steel wire rims are also cut on the same cutting machine. To allow this, the cutting blades are designed and sharpened in a manner that allows cutting through steel without damage to the blade.



**Figure 2.** A cut through tire presenting the location of the steel wire rims (removed) and the cuts in the tire toe (arrow marked)

The tire with remaining steel is cut in the same way as previously explained with the difference in two additional cuts. These two cuts are performed along the rim line to remove the whole tire bead containing the steel wires.

Once separated and cut steel and rubber components of tire are transported to corresponding depots. The transport is done by a belt conveyor with material feeding being manual.

The disposal of tire components at the rubber depot and steel depot is the final phase of primary used tires treatment. The secondary treatment of the steel parts considers the melting and further reuse. The rubber component, during secondary treatment, is loaded, hauled, grinded, heated with various additives and reused in different forms.

## **CONCLUSION**

Used tires are permanent danger to the environment due to potential of fire which cannot be effectively extinguished but only controlled. The risk of fire resulted in tires being buried as prevention. However, nowadays feasible tire recycling methods are developed and resolved the primary problem of steel/rubber separation. One of the mechanical separation methods, the one being successfully applied within the RTB Bor – Group, is presented here. The method is simple, and utilizes hydraulic powered machinery. However, the method still incorporates high amount of manual labor thus increased probability of injury. Because of that, the means of further automation of the processes must be developed in order to increase safety, economy and capacity.

## **REFERENCES**

1. Technical reports from the Sector for planning and production analysis of RBB DOO
2. Technical reports from the Sector for planning and production analysis of RBM DOO.
3. G. Danon, M. Petrović and B. Vasić, PNEUMATICI (karakteristike-izbor-eksploatacija), Institut za istraživanja i projektovanje u privredi, Beograd, 2004.
4. [www.michelin.com](http://www.michelin.com)
5. [www.bridgestone.com](http://www.bridgestone.com)
6. [www.goodyear.com](http://www.goodyear.com)
7. [www.belshina.com](http://www.belshina.com)



## MEDIATED OXIDATION OF SUCROSE BY FERRATE(VI) ELECTROCHEMICALLY GENERATED IN THE TREATMENT REACTOR

Milan Cekerevac\*, M. Zdravkovic, Lj. Nikolic Bujanovic, M. Tomic

IHIS Techno-Experts d.o.o., Batajnicki put 23, 11080 Belgrade, SERBIA

\*[milan.cekerevac@ihis.co.rs](mailto:milan.cekerevac@ihis.co.rs)

### ABSTRACT

The process of mediated oxidation of synthetic alkalized sucrose wastewater, by ferrate(VI) electrochemically generated in the reactor, was explored and compared with respect to such wastewater electrochemical oxidation at the stainless steel anode, where generation of ferrate(VI) was not noticed. The results showed that oxidation of sucrose by the *in situ* generated ferrate (VI) could be an efficient and feasible method for engineering of the treatment plant for wastewater from a sucrose refinery.

**Key words:** ferrate(VI), sucrose wastewater, treatment, mediated electrooxidation.

### INTRODUCTION

Biological oxidation is certainly the cheapest treatment process of effluents polluted with organic compounds, but the presence of toxic or bio refractory molecules may hinder this approach. For this reason, physical-chemical methods (filtration, coagulation, adsorption, and flocculation), chemical oxidation (use of chlorine, ozone, hydrogen peroxide, wet air oxidation), and advanced oxidation processes (AOP) (Fenton's reaction, ozone + UV radiation, photochemistry) are currently used to treat these wastewaters. However, all these methods have some major drawbacks; filtration and adsorption are not always sufficient to achieve the discharge limits; coagulation and flotation generate large amounts of sludge; chemical oxidations have low capacity rates and need transportation and storage of dangerous reactants; and advanced oxidation processes require high investment costs. [1-4]

In this context, oxidative electrochemical technologies offer an alternative solution to many environmental problems in the process industry, because electrons provide a versatile, efficient, cost-effective, easily automatable, and clean reagent. The electrochemical treatments of organic compounds founded a wide range of applications recently, because of their relative technological versatility and ease of process control with respect to the processes of chemical treatments by strong oxidants. [1-7]

The electrolytic treatment of sucrose has already attracted interest in various technological fields, particularly in the processes of chemical oxygen demand (COD)

reduction of the wastewater from sugar refineries and in the electrical power generation in microbial fuel cells. [1 - 4]

In electrooxidation, pollutants can be removed by (i) direct electrolysis, where pollutants exchange electrons directly with the anode surface without involvement of other substances, or (ii) indirect electrolysis, where organic pollutants do not exchange electrons directly with the anode surface but rather through the mediation of some electroactive species regenerated there, which act as intermediaries for electrons shuttling between the electrode and the organic compounds. [1-8]

In this paper the process of mediated oxidation of artificial sugar refinery wastewater by *in situ* generated ferrate(VI), in the process of transpassive oxidation of silicon containing electrosteel, is demonstrated in a laboratory reactor and compared with the process of electrochemical oxidation at stainless steel anode where generation of ferrate(vi) is not recorded.

## EXPERIMENTAL

Mediated electrochemical oxidation of sucrose was performed in the reactor with anolyte and catholyte separated by a Naphion-PTFE membrane. In the anolyte ferrate(VI), as an oxidation mediator, was generated by transpassive oxidation of silicon electro-steel [9, 10] in the first set of experiment; in the second set of experiments, sugar was oxidized by oxygen and other oxidative species generated by water oxidation at the stainless steel anode. The cathode was of high purity nickel mesh.

It was necessary to alkalinize synthetic wastewater before electrolysis to reduce electrode potential of ferrate generation and increase its stability. [9, 10]

All purchased chemicals were of p.a. grade. Ferrate(VI) was electrochemically synthesized in the reactor NaOH solution using electrical steel (3.5% Si) as anode material. Solutions were freshly prepared using distilled water. Sucrose was bought as pure consumable white sugar (purity  $\geq 99\%$ ).

For quantitative determination of organic compounds in water (in our case it is sucrose only) COD value is used as the most appropriate method. Chemical oxygen demand (COD value) was measured according to standard chromite open reflux method described in ISO 6060:1989. [11]

All measurements were carried out at room temperature ( $25 \pm 1^\circ\text{C}$ ).

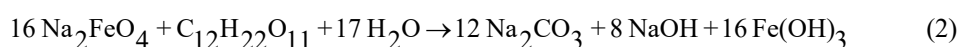
Concentration of sucrose in samples was chosen according to COD value that can be found in these types of effluents.

## RESULTS AND DISCUSSION

### Mediated sucrose oxidation by *in situ* electrochemically generated ferrate(VI)

Mediated oxidation of sucrose in synthetic wastewater was based on the electrochemical generation of ferrate(VI) in a sodium hydroxide solution, Eq. (1), and immediate reaction of the produced disodium ferrate with sucrose Eq. (2).

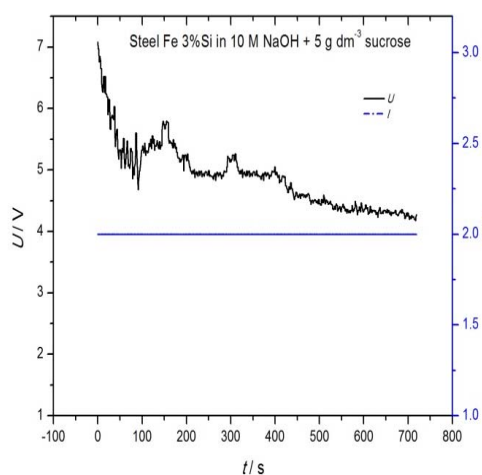




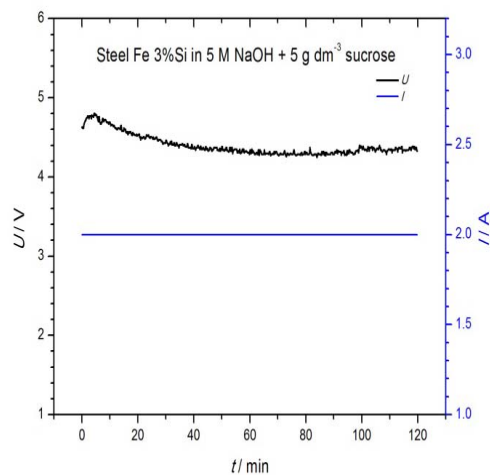
Equation (2) shows that oxidation of 1 mole of sucrose requires 16 moles of ferrate(VI) for complete carbonization, or 7.75 g of ferrate(VI) per 1 g of sucrose.

Voltage–time and current intensity–time diagrams for constant current mediated oxidation of sucrose from synthetic wastewater by electrochemically produced ferrate(VI) obtained in different sodium hydroxide concentration solutions are presented in Figs. 1–3. For all voltage–time dependences decrease of voltage with time of electrolysis is evident, which is the result of the anode surface developing and change of the electrode surface physicochemical characteristics [9, 10].

Concentration of sucrose in the wastewater was measured before and after oxidation by determination of COD [11], because the sucrose and its products were the only oxidizable components of the treated solution.

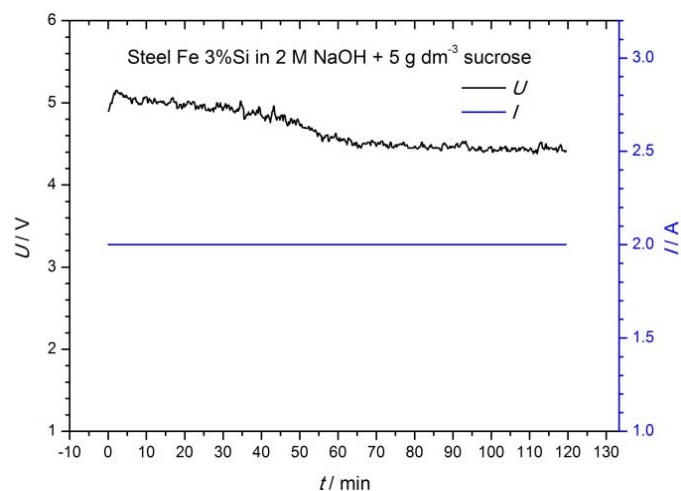


**Figure 1.** Time dependences of voltage and current for electrolysis of 10 M NaOH sucrose solution.



**Figure 2.** Time dependences of voltage and current for electrolysis of 5 M NaOH sucrose solution.





**Figure 3.** Time dependences of voltage and current for electrolysis of 2 M NaOH sucrose solution.

Results of the analysis of experimental data are summarized in Table 1. It follows from Table 1 that in all solutions remarkable reduction of organic matter has been achieved after two hours of electrolysis. Evidently, notable quantities of organic matter has been carbonized, between 26% and 39%, and that efficiency of ferrate increases with reduction of alkalinity from 0.54 in 10 M NaOH to 0.80 in 2 M NaOH.

This behaviour can be explained regarding increased activity of ferrate(VI) in the less alkaline environment because of the ferrate reduction potential increase with decrease of solution pH value.

**Table 1.** Electrochemical oxidation of sucrose solution ( $C = 5 \text{ g/dm}^3$ ) on silicon steel,  $Q = 4\text{Ah}$ .

$C_{\text{NaOH}}$ mol/dm <sup>3</sup>	$COD_{in}$ , gO <sub>2</sub> /dm <sup>3</sup>	$COD_{fin}$ , gO <sub>2</sub> /dm <sup>3</sup>	$\Delta COD$ , gO <sub>2</sub> /dm <sup>3</sup>	$C_{\text{SCfin}}$ , g/dm <sup>3</sup>	$\Delta C_{\text{scEF}}$ , g/dm <sup>3</sup>	$\Delta C_{\text{scT}_2}$ , g/dm <sup>3</sup>	$\Delta C_{\text{scEF}}$ /g ferr	$\Delta C_{\text{scEF}}$ /Ah
10M	5.62	4.15	1.47	3.70	1.30	1.55	0.54	0.32
5M	5.69	3.84	1.85	3.43	1.57	1.55	0.66	0.39
2M	5.69	3.46	2.23	3.09	1.91	1.55	0.80	0.48

$C$  – concentration;  $COD$  – chemical oxygen demand;  $\Delta COD = COD_{in} - COD_{fin}$ ;  $\Delta C = C_{in} - C_{fin}$ .

– The suffix “in” denotes initial values; the suffix “fin” denotes final values; the suffix “SCEF” denotes sucrose effective values; the suffix “SCT” denotes sucrose theoretical values.

### Mediated sucrose oxidation by *in situ* electrochemically generated oxygen and oxygen containing oxidative species

A set of experiments on mediated and straight electrochemical oxidation of sucrose at the stainless steel anode in alkalized wastewater were conducted to find net effect of mediated sucrose oxidation by the *in situ* generated ferrate(VI). Stainless steel has been chosen because its transpassive oxidation to ferrate(VI) was not possible in the given conditions. Reactions given in Eqs. (3) and (4) describe two possible cases of electrocatalytic carbonization of sucrose, the first one present straight anodic oxidation, the second one mediated oxidation by oxygen electrochemically produced.

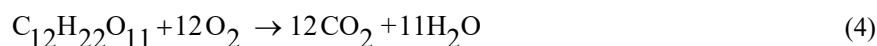
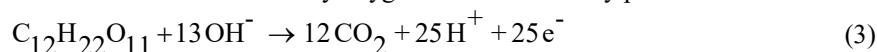


Table 2 presents results of exploration of influence of the artificial wastewater alkalinity on the kinetics of electrochemical oxidation of sucrose at a stainless steel electrode.

From the equations (3) and (4) one can see that 1 g of sucrose spends 1.12 g of dissolved oxygen or current capacity of 1.96 Ah. 1.49 g O<sub>2</sub> dm<sup>-3</sup> produced in the electrolytic reactor theoretically could oxidize 1.33 g of sucrose, and those data were used for calculation given in Table 2.

**Table 2.** Electrochemical oxidation of sucrose solution (C = 5 g/dm<sup>3</sup>) on stainless steel. Q = 4 Ah.

$C_{\text{NaOH}}$ , mol/dm <sup>3</sup>	$COD_{\text{in}}$ , gO <sub>2</sub> /dm <sup>3</sup>	$COD_{\text{fin}}$ , gO <sub>2</sub> /dm <sup>3</sup>	$\Delta COD$ , gO <sub>2</sub> /dm <sup>3</sup>	$\Delta C_{\text{scEF}}$ , g/dm <sup>3</sup>	$\eta_{\text{Oxygen}}$	$U_{\text{sr}}/V$	$\Delta C_{\text{scEF}}$ /Ah
10M	5.62	4.45	1.17	1.04	0.78	5.48	0.26
5M	5.69	4.73	0.96	0.85	0.63	4.95	0.21
2M	5.69	4.83	0.86	0.76	0.57	4.52	0.19

From Table 2 evidently follows that efficiency of electrochemical oxidation of sucrose drops slightly with a decrease of alkali concentration, from 21% in 10 M NaOH to 15% in 2 M NaOH.

Two factors may be causes of such behaviour, one is increase of the overpotentials of reactions given in Table 3 with a drop in sodium hydroxide concentration, and the other would be slowing of the kinetics of reaction (3) with a decrease in alkali concentration.

**Table 3.** Possible electrode reactions at high anodic potentials in the alkaline solutions [5, 12]

Reaction	<i>E</i> vs. NHE / V
$\text{OH}^\bullet + \text{H}^+ + \text{e}^- \rightleftharpoons \text{H}_2\text{O}$	2.80
$\text{O}_3(\text{g}) + 2\text{H}^+ + 2\text{e}^- \rightleftharpoons \text{O}_2(\text{g}) + \text{H}_2\text{O}$	2.075
$\text{H}_2\text{O}_2 + 2\text{H}^+ + 2\text{e}^- \rightleftharpoons 2\text{H}_2\text{O}$	1.763
$\text{HO}_2^\bullet + 3\text{H}^+ + 3\text{e}^- \rightleftharpoons 2\text{H}_2\text{O}$	1.65
$\text{O}_2 + 4\text{H}^+ + 4\text{e}^- \rightleftharpoons 2\text{H}_2\text{O}$	1.229

It is obvious, from the presented experimental results that the process of mediated sucrose oxidation by the *in situ* generated ferrate(VI) increases efficiency of the electrochemical oxidation of the sucrose in respect to the process of sucrose oxidation by oxygen or its oxidative species generated at the stainless steel anode, while the mean electrolysis voltages in both sets of experiments are very close, between 4 V and 5 V. Obviously, *in situ* generated ferrate(VI) shows, in given experimental conditions, more oxidative strength than oxygen and oxygen compounds generated in the processes of water anodic oxidation.

### CONCLUSION

Presented experimental results on the alkalized synthetic sucrose wastewater mediated oxidation by the ferrate(VI), *in situ* generated by a transpassive oxidation of the silicon steel show efficiency of such wastewater treatment process. These results, in respect to the results obtained by electrochemical oxidation of the equivalent wastewater at the stainless steel anode, when ferrate formation was not noticed, obviously confirmed prevalence of ferrate(VI) oxidative strength in relation to the oxygen and oxygen compounds. Current efficiency of the sucrose wastewater oxidation by the *in situ* generated ferrate(VI) shows that such method of decontamination appears promising possibility in the engineering of the plants for treatment of sucrose refineries wastewater.

### Acknowledgement

*This work was financially supported by the Ministry of Education, Science and Technological development of the Republic of Serbia, within projects: TR 34025 and TR 31080.*

### REFERENCES

1. Cekerevac M., Nikolic Bujanovic Lj., Zdravkovic M., Tomic M., Treatment of simulated sugar refinery wastewater by ferrate(vi), Eco-Ist'13, Ecological Truth, 4-7 June 2013. Hotel "Jezero", Bor Lake, Bor, Serbia, pp. 96 – 101.
2. Güven G., Perendeci A., Tanyolaç A., Electrochemical treatment of simulated beet sugar factory wastewater, Chem. Eng. J., 151 (2009) 149-159.

3. Gombos E., Barkács K., Felföldi T., Vértes C., Makó M., Palkó G., Zárny G., Removal of organic matters in wastewater treatment by ferrate (VI)-technology, *Microchem. J.*, 107 (2013) 115-120.
4. Kapałka A., Fóti G., Comninellis C., Basic Principles of the Electrochemical Mineralization of Organic Pollutants for Wastewater Treatment. In C. Comninellis, & G. Chen (Eds.), *Electrochemistry for the environment* (pp. 1 – 25). New York: Springer (2010).
5. Panizza M., Cerisola G., Direct and mediated anodic oxidation of organic pollutants. *Chem. Rev.*, 109 (2009) 6541–6569.
6. Parpot P., Kokoh K. B., Beden B., Lamy C., Electrocatalytic oxidation of saccharose in alkaline medium. *Electrochim. Acta*, 38 (1993) 1679–1683.
7. Parpot, P., Kokoh, K. B., Belgsir, E. M., Léger, J.-M., Beden, B., Lamy, C., Electrocatalytic oxidation of sucrose: Analysis of the reaction products. *J. App. Electrochem.*, 27 (1997) 25–33.
8. Parpot, P., Muiuane, V. P., Defontaine, V., Bettencourt, A. P., Electrocatalytic oxidation of readily available disaccharides in alkaline medium at gold electrode. *Electrochim. Acta*, 55 (2010) 3157–3163.
9. Čekerevac M. I., Nikolić – Bujanović Lj. N., Simičić M. V., Investigation of electrochemical synthesis of ferrate Part I: Electrochemical behavior of iron and its several alloys in concentrated alkaline solutions, *Hem. ind.* 63 (5) (2009) 387–395
10. Čekerevac M.I., Nikolić-Bujanović Lj.N., Jokić A.B., Simičić M.V., Investigation of electrochemical synthesis of ferrate: Prt II Optimization of process parameters and methods of process analytical control , *Hem. Ind.*, 64 (2010) 111-119.
11. ISO 6060:1989, Water quality -- Determination of the chemical oxygen demand (1989).
12. Kraft A., Doped diamond: A compact review on a new, versatile electrode material. *Int. J. Electrochem. Sci.*, 2 (2007) 355–385.



## MINERALGICAL CHARACTER OF THE MIXER SLAG

Snezana Devic<sup>1\*</sup>, M. Cocic<sup>2</sup>

<sup>1</sup>Institute IMS, Bulevar vojvode Misica 43, 11000 Belgrade, SERBIA

<sup>2</sup>University of Belgrade, Technical faculty in Bor, V. J 12, 19210 Bor, SERBIA

\*snezana.devic@institutims.rs

### ABSTRACT

The goal of this paper was the determination of mineralogical nature of mixer slag. It is within the group of metallurgical slags representing a part of secondary raw materials that originated in the processes of iron and steel metallurgy. In order to determine the mineralogical nature of mixer slag, several methods were used for testing, such as the optical microscopy in transmitted and reflected light, XRD method, XRF method and electronic microscopy. The results have shown that mixer slag is essentially a calcium-magnesium-alumo-silicate glass. In the glassy base appears the mineral melilite, representing an isomorphous mixture of minerals Akermanite and Gehlenite, then Fayalite – Tephroite from the Olivine group and Fe inclusion. These results represent a supplement to previous research and knowledge acquired in the area of secondary raw materials that originated in the metallurgical processes of iron and steel production.

### INTRODUCTION

Iron homogenization is performed in the mixer. Hot metal with defined weight and chemical composition, from the Blast Furnace, is transported in ladles to the desulphurization facility. Depending on sulphur content in hot metal, necessary degree of desulphurization, as well as the required quantity of additive - desulphurant, have been determined. Desulphurized hot metal, after slag skimming, is poured into a 600-ton and 1300-ton mixer, most often with a highly-baked magnesite material lining. Mixer is a complex metallurgical unit in which hot metal homogenization is performed according to chemical composition and temperature. Mixer slag is formed during the homogenization process. Mixer slag is most often glassy, and its basicity ranges from 0,9 to 1.0[1,2]. Crystal phases, belonging to silicates containing Fe, Mn, Mg or Ca, appear in it too.

### EXPERIMENTAL

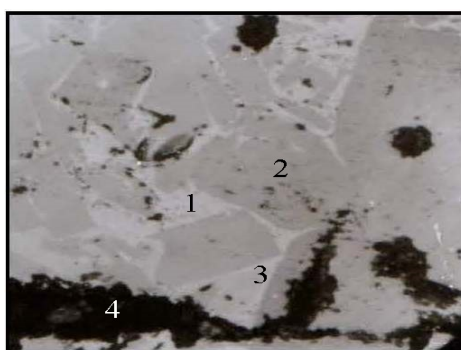
Optical testing of mixer slag has been carried out on the Neophot-32 reflected light polarization microscope and Jena-pol transmitted light polarization microscope. The chemical composition of mixer slag has been determined by the XRF method on the X-ray fluorescent spectrometer ARL 9800 IX – P. Testing of mixer slag by the X-ray powder diffraction method has been carried out on the X-ray diffractometer Kristaloslex 810.

Obtained data of diffraction peak positions ( $2\theta$ ), interplanar spacings  $d$  (Å) and intensities are compared with literature data and JCPDS. Mixer slag has been tested on the electronic microscope (SEM-EDS analyses) type JEOL JSM-6610 LV with INCA Energy 350.

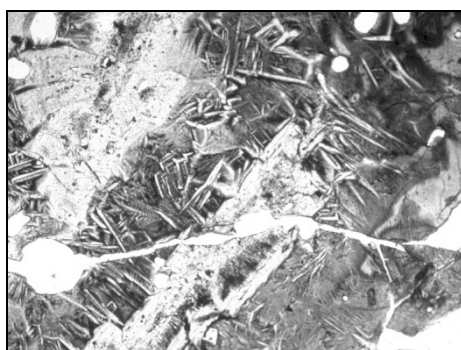
## RESULTS AND DISCUSSION

The micrographical presentation of mixer slag is shown in Fig. 1. As it can be seen, mixer slag is basically formed from glass, in which there are also crystal phases of minerals of the Olivine group and the Melilite group. Fig. 2 shows a micrographical presentation of mixer slag obtained by testing of mixer slag in the transmitted light microscope.

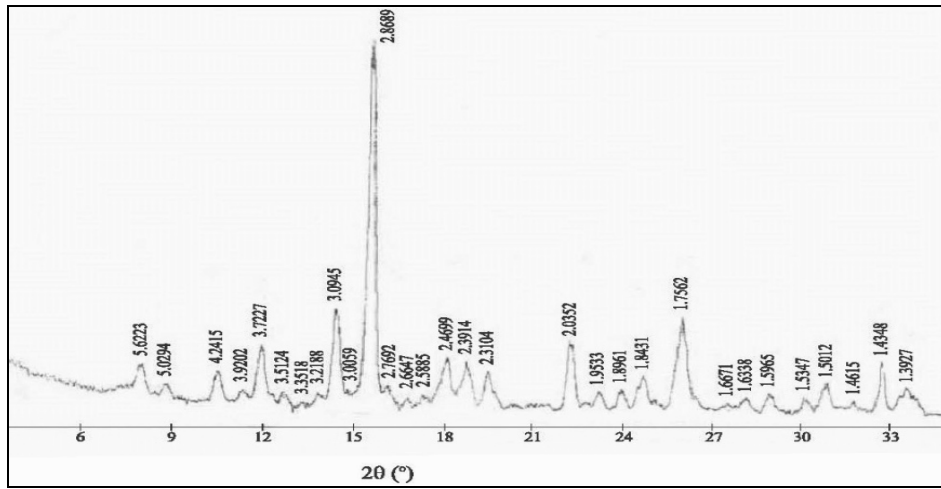
The presence of glassy base and crystal phase, that belong to Olivine, can be also seen in it. X-Ray diffractogram of mixer slag is shown in Fig. 3. Diffractions, corresponding to crystal phases, present in the silicate glassy base of mixer slag, can be clearly seen on it. The diffraction values 3.72, 2.85, 2.03, 1.75 and 1.50 Å correspond to minerals of group olivine (Fayalite-Tephroite).



**Figure 1.** Micrograph of the Mixer slag, Reflected light, magnification x250;  
(1- silikate glass, 2- minerals of the group Olivine, 3- minerals of the group Melilite, 4- holes in microscopic preparation)

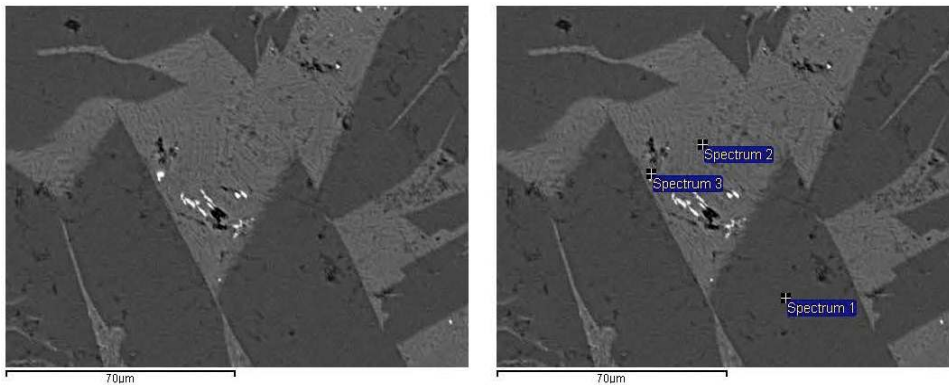


**Figure 2.** Micrograph of the Mixer slag, transmitted light (objektiv x5, paralell nicols)

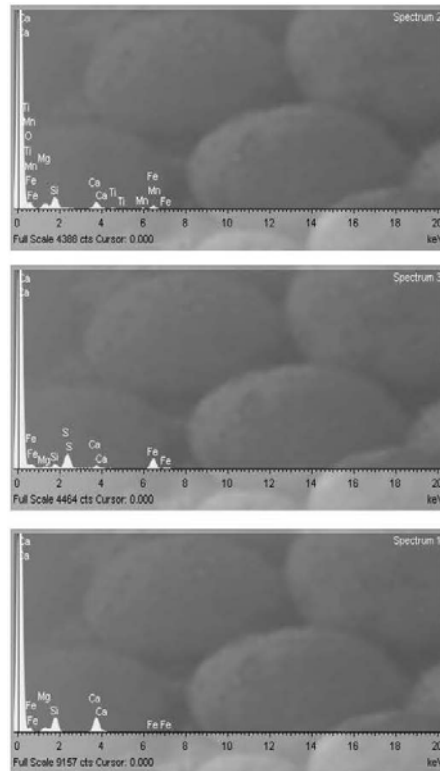


**Figure 3.** X-Ray diffractogram of the Mixer slag

SEM image of the Mixer slag 1 Interest 1 (Fig.4) shows the presence of tabular and elongated prismatic forms which belong to Mellilite group. Interspaces of the glassy matrix contain olivine group minerals. The chemical composition of the selected points is shown in Table 1 and EDX spectrums in Figure 5.



**Figure 4.** SEM image of the Mixer slag 1, (selected points)- Interest 1



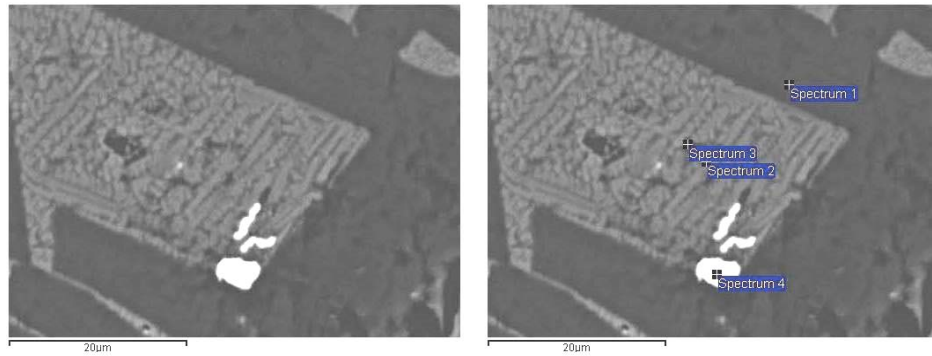
**Figure 5.** EDX spectrums of the Mixer slag 1, (selected points)- Interest1

**Table 1.** Chemical analyses of the mixer slag 1 - Interest 1 (wt-%)

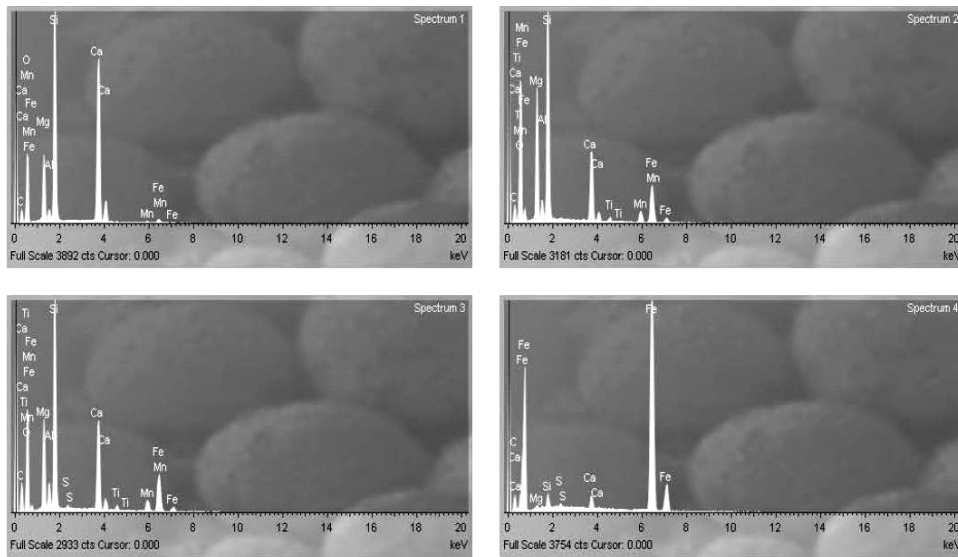
	Mg	Si	S	Ca	Ti	Mn	Fe	Total
Spec. 1	<u>11.07</u>	<u>44.75</u>	-	<u>42.16</u>	-	-	2.02	100.00
Spec. 2	<u>14.56</u>	<u>38.67</u>	-	<u>18.65</u>	2.54	<u>4.94</u>	<u>20.64</u>	100.00
Spec. 3	<u>2.97</u>	<u>8.65</u>	<u>37.90</u>	<u>4.89</u>	-	-	<u>45.60</u>	100.00

SEM images of the Mixer slag 1 Interest 2 (Fig. 6) shows eutectic exsolution of olivine group minerals in the glassy matrix. The chemical composition of the selected points is shown in Table 2 and EDX spectrums in Figure 7.





**Figure 6 . SEM image of the Mixer slag 1, (selected points) - Interest 2**

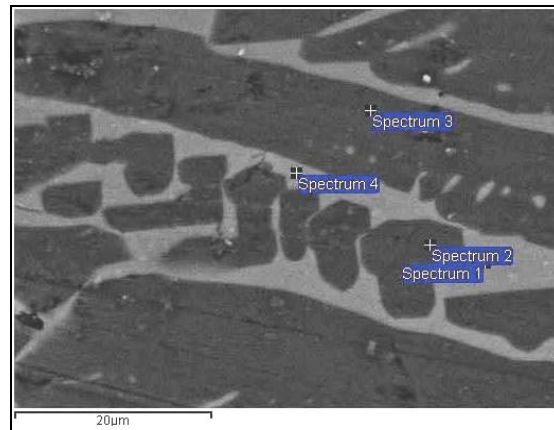


**Figure 7. EDX spectrums of the mixer Slag 1- Interest 2**

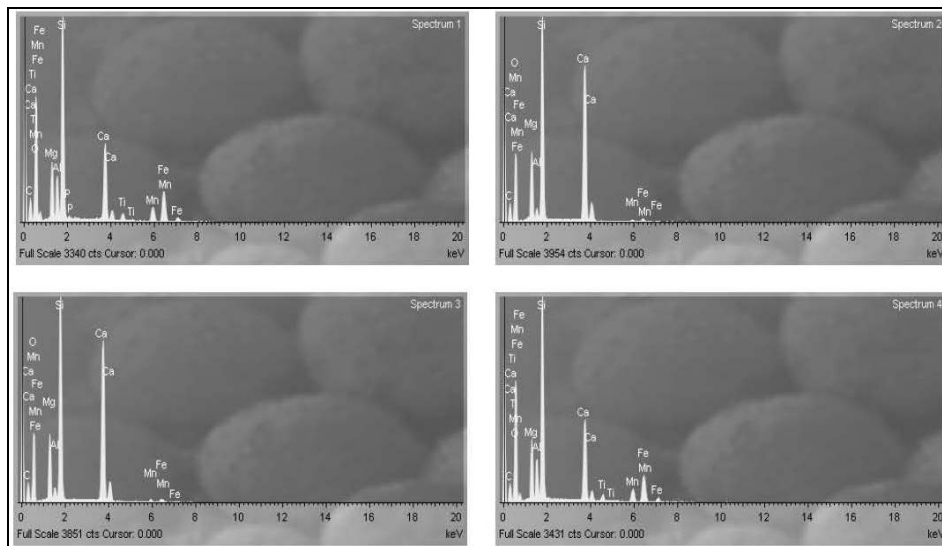
**Table 2. Chemical analyses of the mixer Slag 1- Interest 2 (wt-%)**

	Mg	Al	Si	S	Ca	Ti	Mn	Fe	Total
Spec. 1	<u>12.03</u>	1.68	<u>44.80</u>	-	<u>38.37</u>	-	0.50	2.62	100.00
Spec. 2	<u>20.68</u>	2.95	<u>39.25</u>	-	<u>12.62</u>	1.39	<u>4.41</u>	<u>18.69</u>	100.00
Spec. 3	<u>14.74</u>	4.05	<u>39.12</u>	0.91	<u>16.42</u>	1.48	<u>4.40</u>	<u>18.88</u>	100.00
Spec. 4	0.55	-	2.35	0.6	1.95	-	-	<u>94.49</u>	100.00

SEM image of the mixer Slag 1, Interest 3 (Fig.8) shows elongated forms of Mellilite group minerals in the glassy matrix. The chemical composition of the selected points is shown in Table 3 and EDX spectrums in Figure 9.



**Figure 8.** SEM image of the mixer Slag 1 Interest 3



**Figure 9.** EDX spectrums of the Mixers slag 1- Interest 3

**Table 3.** Chemical analyses of the Mixers Slag 1- Interest 3 (wt-%)

	Mg	Al	Si	P	Ca	Ti	Mn	Fe	Total
Spec. 1	10.15	7.22	40.94	0.86	16.60	2.27	6.29	<u>16.67</u>	100.00
Spec. 2	<u>12.84</u>	1.62	45.12	-	<u>38.18</u>	-	0.76	1.57	100.00
Spec. 3	<u>12.38</u>	1.89	44.46	-	<u>38.43</u>	-	0.99	1.85	100.00
Spec. 4	10.80	6.85	42.23	-	16.68	2.37	5.81	<u>15.27</u>	100.00

Testing of mixer slag on the electronic microscope has been shown on all three Interest that mixer slag is basically glassy and that there are crystal mineral phases in it, representing isomorphous mixtures of minerals of the Olivine and the Melilite group. Those are minerals Fayalite ( $\text{Fe}_2\text{SiO}_4$ ) and Tefroite ( $\text{Mn}_2\text{SiO}_4$ ) of the Olivine group, from one side, as well as minerals Akermanite ( $2\text{MgCa}_2\text{Si}_2\text{O}_7$ ) and Gehlenite ( $\text{Ca}_2\text{Al}(\text{AlSi})\text{O}_7$ ), representing an isomorphous mixture of the Melilite group. EDX spectrums in the Figures 5,7 and 9, chemical analyses in the Tables 1, 2 and 3 confirm this.

### CONCLUSION

Based on the presented testing results a conclusion can be drawn:

Mixer slag is basically glassy. This glass is, by chemical composition, aluminosilicate glass. In addition to glassy base, slightly crystallized minerals, characteristic for isomorphous mixtures of the Olivine and the Melilite group, are also present. These minerals are silicates that often appear in metallurgical processes in the iron and steel production.

### REFERENCES

1. Dević S. : Mineralogical – Chemical characteristics and slag minerals morphology in the SARTID's Steel plant, 11<sup>th</sup> International metallurgy & materials congress, Istanbul, Turkey, 46. 2002.
2. Dević S. : Occurrence and appearance of macrofaunal fragments from several clay deposits in Voevodina, Serbia, International Congress "Engineering, Materials and Management in the Processing Industry ", Jahorina, Republic of Srpska, Proceedings, 90-93, 2009.
3. Kerr P.: Optical mineralogy, MC Graw Hill Book Comp. INC, New York, 1959.
4. Fray K., The Encyclopedia of mineralogy, Hutchin.Ross Publi.Comp., Stroudsburg, Pennsylvania, 1981.



## FLOTATION RECOVERY OF COPPER MINERALS BY DIFFERENT KIND OF COLLECTORS AND FEED FINES

Gracijan Strainovic<sup>1\*</sup>, Z. Markovic<sup>2</sup>, Z. Stirbanovic<sup>2</sup>

<sup>1</sup>RBB, RTB Bor – Flotation “Veliki Krivelj”, Kestenova 8. 19210 Bor, SERBIA

<sup>2</sup>University of Belgrade - Technical faculty in Bor, Vojske Jugoslavije  
12, 19210 Bor, SERBIA

\*[gracijan@gmail.com](mailto:gracijan@gmail.com)

### ABSTRACT

Copper ore from the Veliki Krivelj (RTB Bor, Serbia) is a porphyry type, main mineral of copper is chalcopyrite. The most important accompanying mineral is pyrite, content in the ore is about 10%.

In a sample of ore from the mine Veliki Krivelj it was carried out research with the aim to determine the optimal reagent regime. Experiments were carried out with the available flotation reagents, the goal is to determine the influence of each collector on copper recovery and to determine the optimal combination of collectors also the optimum dose of the collector. Reagents applied in the study are IPETC, PEX, SIPX, MBT (Isopropyl ethyl thionocarbamate, Potassium ethyl xanthate, Sodium isopropyl xanthate, Mercaptobenzothiazole). In the following studies were carried out experiments to determine the effect of fineness of grind on the recovery of copper.

The results indicate that is the biggest copper recovery using a combination IPETS and PEX also the results show that the copper recovery directly proportional to grinding fineness.

**Key words:** copper ore flotation, flotation collectors, minerals grain size.

### INTRODUCTION

Veliki Krivelj operates within the RTB Bor Group; witch annually produces 10.6 million tons of ore. Ore exploitation started on 1982. After thirty years of operation, flotation plant is reconstructed for capacity of 10.6 million tons per year. After many years of open pit began to develop in breadth which means that the excavated ore is mined from different levels. An Ore deposit from the Veliki Krivelj is porphyry type, with four zones of mineralization: the oxidation zone, sedimentary zone, a zone of secondary sulphides enrichment and primary sulphide zone. This structure represents a challenge for ore flotation process and constantly adapting to the characteristics of the ore in order to achieve maximum results.

The composite ore that is transported from the mine is often different in its composition, so it is often necessary to examine the optimal mix of collectors and their dozes in order to achieve maximum copper recovery. On the other hand, the fineness of grinding is of great importance due to changes granulation of copper mineral in the ore which leads to the need for finer grinds the ore in order to achieve optimal results.

## EXPERIMENTAL PART

The ore required for experiments was sampled from open pit mine Veliki Krivelj. Samples were prepared in the laboratory of flotation Veliki Krivelj. The samples were crushed and sieved on a sieve of 3 mm. Further samples are ground in a laboratory ball mill, determining the grinding kinetics. The fines ground should be most closely matches to the fineness of grinding that is achieved under operating conditions.

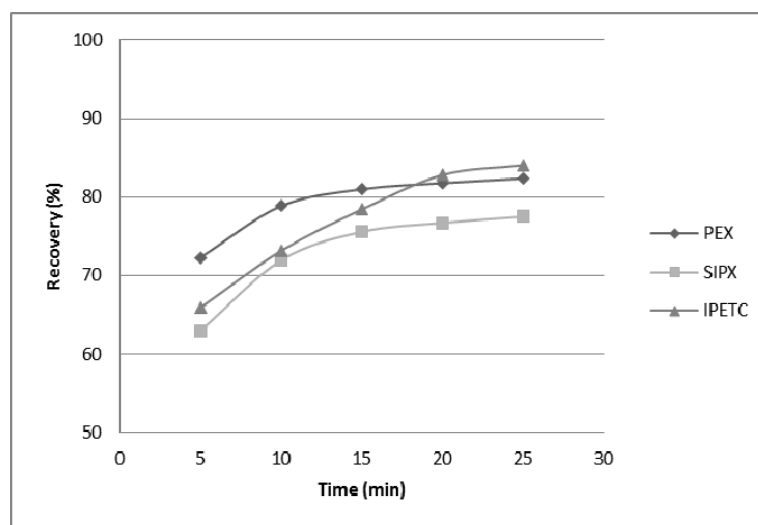
Flotation concentration tests were conducted on laboratory flotation machine from manufacturer Metso minerals.

The applied reagents were:

- IPETS - isopropyl ethyl thionocarbamate
- PEX - potassium ethyl xanthate
- SIPX - Sodium isopropyl xanthate
- MBT - mercaptobenzothiazole

## RESULTS AND DISCUSSION

The first series of experiments conducted on samples of ore, using the following collector PEX, IPETC, SIPX. Flotation tests are carried out 25min to yield after each five minutes of flotation, a new dose of collectors was given. The total dose collector is as follows: IPETC 35g/t, PEX 35g/t, SIPX 30g/t. the goal is to determine the maximum required dose collector and the collector that provides the highest recovery of copper. The results are shown in Figure1.

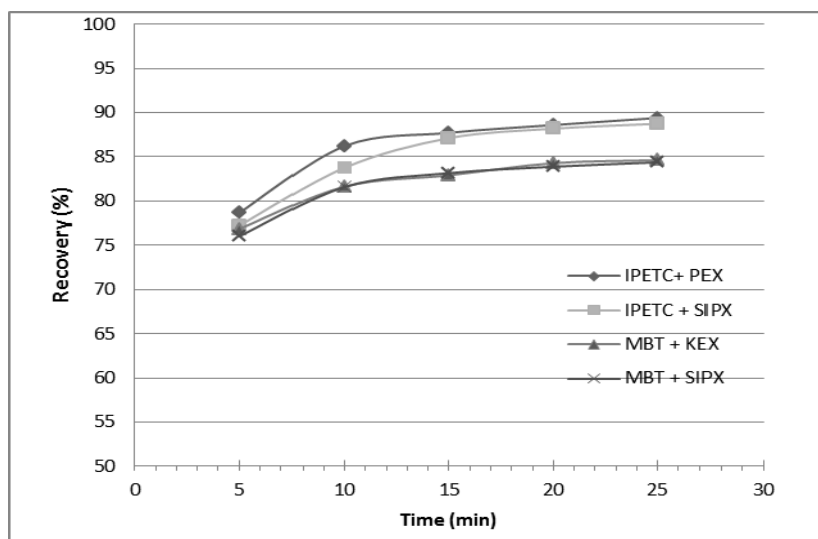


**Figure 1.** The copper recovery depending on the time of flotation by using three collectors (PEX - Potassium ethyl xanthate, SPEX - Sodium isopropyl xanthate, IPETC - Isopropyl ethyl thionocarbamate)

Figure 1 shows that the application of two xanthate, the higher recovery was obtained by using PEX in relation to the SIPX. Applying IPETS kinetics is slower but is obtained in higher final copper recovery.

The next series of experiments conducted by a combination of the two collectors. The conditioning was added to the first collector, after five minutes of flotation is added to the second collector and then after every five minutes of flotation adds another collector.

As the primary collector were applied IPETC I MBT, as secondary collector were applied xanthates PEX And SIPEX. In Figure 2 are shown the obtained results.

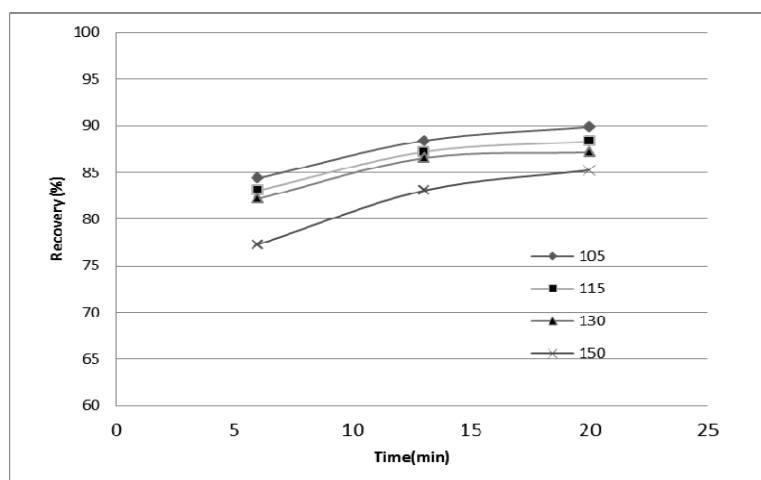


**Figure 2.** The copper recovery depending on the time of flotation by using multiple combinations of collectors (IPETC + PEX, IPETC + SIPX, MBT + PEX, MBT + SIPX).

The figure shows that the highest copper recovery obtained by using a combination of collectors IPETC and PEX (89.4%), and IPETC SIPX (88.7%) after 25min flotation. The combination of collectors with PEX MBT and SIPX leads to less recovery of copper (84.4% and 84.6%) also 25min after the flotation.

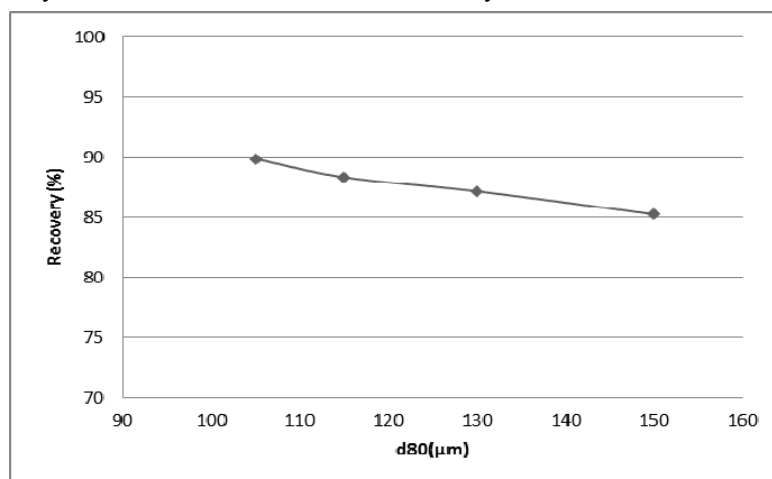
Further research is applied to a combination of collectors IPETC and PEX.

In the next series of experiments the influence grind fines on copper recovery were done. Or that the fineness of grinding enough to liberate the copper minerals. Flotation time was 20min. The first dose of the collector (IPETC) was added at the conditioning, the other two doses of the secondary collector (PEX) were added after seven minutes (70%), after flotation of the fourteenth minutes (30%). In Figure 3 and 4 are shown the obtained results.



**Figure 3.** Dependence of copper recovery on flotation of time for different grind (105 $\mu\text{m}$ , 115 $\mu\text{m}$ , 130 $\mu\text{m}$  and 150 $\mu\text{m}$ ).

The figure shows that the fineness of grinding of direct relevance to copper recovery, with an increase of sample fines the copper recovery grind increase. Copper recovery is significantly higher in the first seven minutes of flotation, and then until the twentieth minute is constantly growing. The largest of copper recovery of 89.9% was obtained with the fineness of grinding of  $d_{80} = 105\mu\text{m}$  and time of 20minutes flotation. In Figure 4 the value of copper recovery for different values of  $d_{80}$  milling products. The figure shows that with increasing values  $d_{80}$  value the copper milling product declines. On the biggest grinding to size by the largest  $d_{80}$  150 microns per observes significantly slower kinetics and a minimum recovery in the first seven minutes.



**Figure 4.** The copper depending on the value  $d_{80}$  milling products

## **CONCLUSION**

The value of copper recovery is the largest application of IPETC as the primary collector and PEX as a secondary collector. By applying these two collectors produces a maximum yield of 89.4%. Tests were made to the flotation grinding fineness which approximates to that which is obtained under operating conditions. In the second part of the test, the influence grind on copper recovery, with the grinding rising copper recovery. The highest copper recovery was obtained in the grinding fineness which is  $d_{80} = 105\mu\text{m}$  from 89.9% at the time of flotation, which is less than the time of flotation in the first series of the experiment.

## **REFERENCES**

1. PK Ackerman, G. H. Harris, R. R. Klimpel and F.F. Aplan, Evaluation of Flotation Collectors for Copper and sulfides Pyrite, I. Common sulfhydryl Collectors (1985), *IProcessing*, 21 (1987) 105-127 Elsevier Science Publishers B.V., Amsterdam Printed in The Netherlands.
2. M.S.Sheridan, D.R.Nagaraj, D.Fornasiero, J.Ralston; The use of a factorial experimental design to study collector properties of N-allyl-O-alkyl THIONOCARBAMATE collector in the flotation of a copper ore (2002), *Minerals Engineering* 15 (2002) 333-340.
3. Liu Guangyi, Hong Zhong, Dai Tagen, Liuyin Xia; Investigation of the effect of N-Substituents on performance of thionocarbamates as selective collectors for copper sulfides by ab initio calculations (2008), *Minerals Engineering* 21 (2008) 1050-1054.
4. G.Bhaskar Raju and P.R.Khangaonkar, Electroflotation of chalcopyrite fines with sodium diethyldithiocarbamate as collector (1982), *International Journal of Mineral Processing*, 13 (1984) 211-221, Elsevier Science Publishers B.V., Amsterdam, The Netherlands Printed in.





## RECONSTRUCTED SMELTING SLAG PROCESSING PLANT. PART 1 - FLOTATION CONCENTRATION

Srdjana Magdalinovic<sup>1</sup>, Z. Markovic<sup>2\*</sup>, I. Jovanovic<sup>1</sup>, R. Pantovic<sup>2</sup>, S. Petrovic<sup>1</sup>,  
D. Milanovic<sup>1</sup>, Z. Stirbanovic<sup>2</sup>

<sup>1</sup>Mining and Metallurgy Institute Bor, 35 Zeleni bulevar, 19210 Bor, SERBIA

<sup>2</sup>University of Belgrade, Technical Faculty in Bor, 12 Vojske Jugoslavije, Bor, SERBIA

\*[zmarkovic@tf.bor.ac.rs](mailto:zmarkovic@tf.bor.ac.rs)

### ABSTRACT

As part of the reconstruction projects in RTB Bor Smelter and construction of a new sulphuric acid plant, it was necessary to develop and project of reconstruction of facilities for the processing of smelting slag. It was decided to utilize available resources flotation plant Bor, which are processed underground ore and smelting slag technogenic deposits Depo slag 1, for the construction of technological line for processing new smelting slag. This line consists of new flotation machines, conditioners, slurry pumps, blowers and equipment for the control and regulation of processes and equipment for the preparation and dispensing of reagents.

Plant for flotation concentration of the slag will be placed in the new part of the Flotation Plant in Bor.

This paper presents a description of the slag flotation process. Hydrocyclone overflow go to the conditioning and the rougher flotation. Rougher tails go on scavenger flotation. Scavenger tails connects with the flotation tailings underground ore and sent to the thickening tailing dump. Rougher concentrate go on the conditioner before the first cleaning. Scavenger concentrate go into the conditioner before the first cleaner. First cleaning concentrate go to second cleaning, the second cleaner concentrate go to the third cleaner. Tails of the third cleaner go to second cleaning. Tails of the second cleaner go to the first cleaner. The first cleaner tails go in the conditioner before the rougher flotation. The third cleaner concentrate is copper concentrate and it go to thickening and filtering.

**Key words:** Copper slag, flotation concentration.

### INTRODUCTION

When it comes to RTB Bor, the first recorded testing of copper valorization by flotation of smelting slag dating back to 1970. The testing was carried out on samples of differently cooled converter slag. It was then found that at various modes of slag cooling, a quality copper concentrate could be obtained. Regarding the granulated slag, concentrate grade was between 20 and 25% Cu, with recovery of 90–92%. The results on non-granulated slag were slightly worse. Corresponding tests on slag from blast furnace didn't give positive results.

In mid-1972 a detailed research of the possibilities for industrial valorization of copper from the converter slag was performed. On that occasion, total amount of 5913 tons of slag was processed (average copper content in slag was 4.80%). The final

flotation concentrate contained 38.97% Cu with recovery of 83.83%. Tailings grade was 0.86%. However, despite the satisfactory results, industrial slag processing line was not established.

In the following period until 1990, there was no detailed research regarding the slags from Bor Copper Smelter. After that, a series of testing related to the possibility of copper flotation from smelting slag were conducted in the nineties. Finally, on the 01.06.2001 the first industrial processing of blast furnace slag was started in Bor flotation plant. Table 1 shows the achieved results in the period of 2001–2005 [1].

Slag processing in the Bor flotation plant lasts until today. However, the Project of the Smelter reconstruction and the construction of the Sulfuric Acid Factory have imposed the need for a new reconstruction of the flotation plant. Namely, for more effective processing of smelting slag from the new Smelter, one of the existing technological lines in Bor flotation (grinding section "B") have been employed. Section "B" have been revitalized and equipped to work with new raw material, so that the requirements for high grade concentrate can be achieved (copper content in concentrate above 30%) [2].

**Table 1.** The results of smelting slag processing in period 2000 – 2001 [1].

Year	Slag production [t/year]	Cu content in slag [%]	Cu content in concentrate [%]	Cu recovery in concentrate [%]
2001.	14 617	0.747	15.16	75.06
2002.	159 717	0.644	12.76	63.47
2003.	333 438	0.565	10.16	57.04
2004.	271 624	0.529	12.56	51.27
2005.	138 963	0.729	12.76	36.57

The total annual production of smelting slag from new Smelter is planned to be 340 000 tons per year, with an average copper content of about 2%. Thereof, one quantity of smelter slag will be obtained from Flash smelting process, while the other quantity will be obtained from PS-converter.

#### THE PROCEDURE OF SLAG GENERATION AND PROCESSING

Slag from the flash furnace and PS-converter of new Smelter (temperature of 1200 – 1300°C) will be poured into the slag pots and transported to the slag cooling place by special vehicles for slag pots transportation. The cooling of slag will be combined: firstly slow at the air and after that rapid by water. This procedure enables appropriate crystallization of copper grains, which results in a better flotation recovery as well as lower costs of comminution. Average chemical composition of smelting slag is presented in Table 2.

**Table 2.** Chemical composition of smelting slag.

Origin of slag	Cu, %	Fe,%	S,%	Pb,%	Zn,%	SiO <sub>2</sub> ,%	As,%	Sb,%
Flash furnace	1.4	42.5	1.2	0.07	0.5	29.0	0.04	0.01
PS-converter	6.0	48.6	1.0	0.62	0.8	24.0	0.07	0.01

The whole cooling process will last about three days. This process is slightly shorter in winter, compared to summer conditions.

The cooled slag will be discharged from pots and stored in a pile. On this pile, slags from the flash furnace and PS-converter will be mixed in order to form the appropriate composite for transport to the flotation plant.

Thereafter, the slag will be transported by trucks to the receiving bunker, from where the further processing of slag will be performed, in order to obtain the final product – copper concentrate. This process includes the following technological lines: two-stage crushing and screening, three-stage grinding with two-stage classifying, rough flotation and scavenger with three-stage cleaning of copper concentrate, joining of final concentrates from slag and underground ore processing, thickening and filtration of collective final concentrate.

Collective final tailings (consisting of tailings from slag processing and tailings from underground ore processing) will be disposed, after thickening, on the existing RTH flotation tailings dump.

The process water supply of flotation plant will be from the pool located near the plant. The main electric power supply will be from the new substation, the construction of which is predicted as part of the flotation plant reconstruction and which will be located in the industrial complex MSC Bor. Drinking water is provided from the municipal water system.

## FLOTATION CONCENTRATION PROCESS

The cyclone overflow pumps will transfer slurry to the rougher conditioning tank to begin flotation. Doses of Dowfroth 250 and SIPX will be added to the rougher conditioning tank. The conditioning tank overflow will feed 3 RCS 40 rougher cells by gravity. The rougher concentrate will flow by gravity through froth launders to the rougher concentrate pump tank. The rougher concentrate pumps will transport the full slurry stream to the Thermo Scientific Multi Stream Analyser for real time elemental analysis and metallurgical accounting. Rougher concentrate will then flow by gravity to feed cleaner 1 conditioning tank.

Rougher tailings will flow directly to 2 new RCS 40 scavenger cells. The scavenger concentrate will flow by gravity through froth launder to the scavenger concentrate pump tank. The scavenger concentrate pumps will transport the full slurry stream to a Thermo Scientific SamStat-30CF to achieve a representative sub split stream. The split stream will be feed to the Multi Stream Analyser by gravity for real time elemental analysis and metallurgical accounting. The main stream from the SamStat will flow to the rougher conditioning tank by gravity, and the sub stream from the Multi

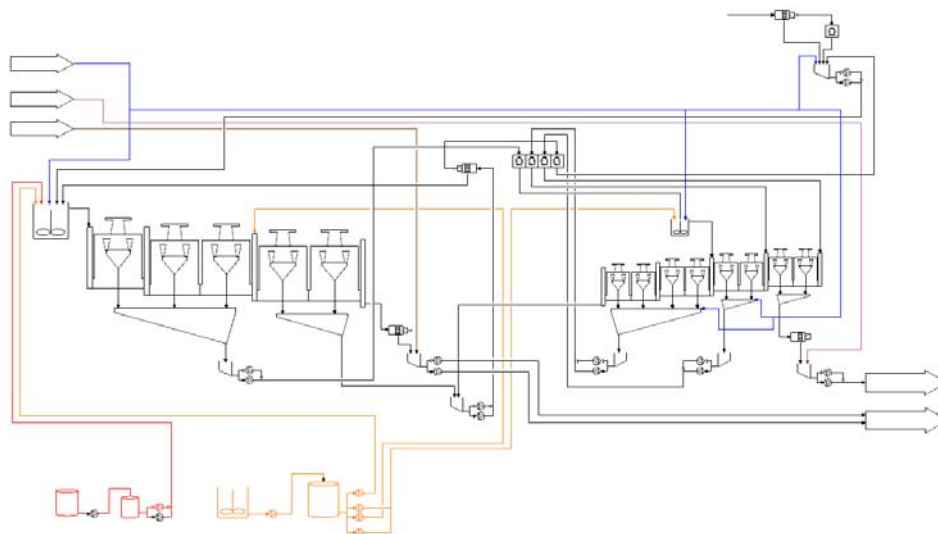
Stream Analyser will flow by gravity to the cyclone overflow pump tank. The scavenger tailings will flow by gravity to a new Thermo Scientific AnStat-230 for elemental analysis and metallurgical accounting. The scavenger tailings slurry will then flow by gravity to the final tailings pump tank. Tailings slurry from the underground ore enrichment process (Jama) will also flow to the final tailing pump tank. The final tailings pumps will transfer of final tailings slurry to dewatering equipment.

A dose of SIPX will be added to the cleaner 1 conditioning tank. The conditioning tank overflow will feed 4 RCS 5 cleaner 1 cells by gravity. The cleaner 1 concentrate will flow by gravity through froth launders to the cleaner 1 concentrate pump tank. Process water will be added to the froth launder to prevent blockage. The cleaner 1 concentrate pumps will transport the full slurry stream to the Multi Stream Analyser for elemental analysis and metallurgical accounting. The cleaner 1 concentrate will then flows by gravity to feed cleaner 2. Cleaner 1 tailings will flow by gravity to the scavenger concentrate pump tank. Cleaner 1 concentrate will feed 2 RCS 5 cleaner 2 cells by gravity from the Multi Stream Analyser. The cleaner 2 concentrate will flow by gravity through froth launder to the cleaner 2 concentrate pump tank. Process water will be added to the froth launder to prevent blockage. The cleaner concentrate pump will transport the full slurry stream to the Multi Stream Analyser for elemental analysis and metallurgical accounting. The cleaner 2 concentrate will then flows by gravity to feed cleaner 3. Cleaner 2 tailings will flow directly to cleaner 1. Cleaner 2 concentrate will feed 2 RCS 5 cleaner 3 cells by gravity from the Multi Stream Analyser. The cleaner 3 concentrate will flow by gravity through froth launder to a Thermo Scientific AnStat-230 for elemental analysis and metallurgical accounting. The Cleaner 3 concentrate will then flows by gravity to cleaner 3 concentrate pump tank. Concentrate slurry from the underground ore enrichment process will also flow to the cleaner 3 concentrate pump tank. The cleaner 3 concentrate pumps will transfer final concentrate to dewatering equipment. The cleaner 3 tailings will flow directly to cleaner 2.

The frother Dowfroth 250 will be utilized to promote a stable froth layer at the top of the flotation cells. There will be a dedicated station for the storage and dosing of the frother. The frother will be added at 100% solution as dilution is unnecessary. Dosing pump will add frother to the rougher conditioning tank.

The collector sodium isopropyl xanthate (SIPX) will be utilized to increase the separability of the hydrophobic and hydrophilic particles. There will be a dedicated station for SIPX mixing and storage. Big bags of solid SIPX will be added to a mixing tank with water to achieve the required reagent solution rate of 10% by weight. Dosing pump will add SIPX to the rougher conditioning tank. Dosing pump will add SIPX to the flotation intermediate box that feeds the scavenger line. Dosing pump will add SIPX to the cleaner 1 conditioning tank.

Figure 1 shows the technological scheme of flotation concentration of new smelting slag.



**Figure 1.** The technological scheme of flotation concentration of new smelting slag

## CONCLUSION

Reconstruction of the flotation concentration of new smelting slag is to replace the entire new equipment such as: conditioners, flotation machines, slurry pumps, a device for determining particle size in the hydrocyclone overflow, analyzers of copper to six flotation products, thirteen cameras that monitor the foam each of the thirteen flotation machine, PLC control system, control system, complete equipment for preparation and dosing of reagents.

It is expected that the new line of flotation processing, which is fully adapted to the new slag, to enable the processing of 324 700 t of slag, which, on average, should contain 2.072 % copper and will concentrate obtained a 31.2 % copper with a yield of 84 %.

## Acknowledgement

*This paper is the result of Project TR 33023: "Development of flotation processes in aim to increase technology results on copper and precious metals ore" funded by the Ministry of Education, Science and Technological Development of the Republic of Serbia.*

## REFERENCES

1. Zvonko Mitrović, Rodoljub Jovanović: Sto godina borskog rudarstva 1903 - 2003; Sedamdeset pet godina basenskih flotacija 1929-2003., Rudarsko-topioničarski basen Bor, Megatrend univerzitet Beograd, Bor, 2007. (in Serbian)
2. Dopunski rudarski projekat rekonstrukcije postrojenja za preradu topioničke šljake u flotaciji Bor; Knjiga 1. - Konceptijsko rešenje; Sveska 1.3. - Flotacijska prerada topioničke šljake, IRM Bor, 2015. (in Serbian)



## ALKYD RESINS BASED ON WASTE PET

Aleksandra Bozic<sup>1\*</sup>, J. Rusmirovic<sup>2</sup>, M. Stamenovic<sup>1</sup>, V. Alivojvodic<sup>1</sup>,  
N. Bukumiric<sup>1</sup>, S. Putic<sup>2</sup>

<sup>1</sup>College of Vocational Studies, Belgrade Polytechnic, Belgrade, SERBIA

<sup>2</sup>University of Belgrade, Faculty of Technology and Metallurgy, Belgrade, SERBIA

\*[abozic@politehnika.edu.rs](mailto:abozic@politehnika.edu.rs)

### ABSTRACT

Three different short chain waste PET-based alkyd resins were prepared by reacting hydrolysis products of waste PET with trimethylolethane, pentaerythritol, trimethylolpropane, phthalic anhydride, and linseed oil fatty acids. The reactions were followed with acid values (AV) and also by determination of volume of removed water during the reaction of polyesterification. The structures of resins were confirmed by FTIR, <sup>1</sup>H and <sup>13</sup>C NMR spectral data. By testing mechanical properties it was shown that synthesized alkyd resins showed satisfactory homogeneity, viscosity and transparency. All of resin films showed good results on impact resistance test.

**Key words:** alkyd resins, PET waste, recycling.

### INTRODUCTION

As one of the most used synthetic polymer, especially for food, water and soft drink packaging, poly(ethylene terephthalate) (PET) causes serious environmental problems because of large amount of disposal arising from aggravated decomposition of PET [1, 2]. Waste PET recycling, as one of the most successful polymers recycling method prevents pollution of environment and saves energy. One of the most investigated chemical ways for PET recycling, but still with great potential for research, is glycolytic depolymerization (glycolysis) [3]. This process involves the solvolytic cleavage of PET chains by using diverse glycols to give the so called glycolyzates consisted of monomers for the repolymerization of PET (bis (hydroxyalkyl) terephthalate) and/or oligomers. Ethylene glycol (EG) is the most usually used solvent in PET glycolysis [4-6], but also diethylene glycol (DEG) [7], triethylene glycol (TEG) [8], propylene glycol (PG) [9] or dipropylene glycol (DPG) [10].

In this work multifunctional glycolyzates were used to prepare alkyd resins with improved applicative properties. For that purpose waste PET was glycolyzed using

three multifunctional alcohols: trimethylolethane (TME), pentaerythritol (PE) and trimethylolpropane (TMP).

The applied process was further justified because two important environmental issues were resolved: (1) the use of waste material promoted the reduction of the amount of waste PET disposed to landfills or just dumped and (2) the replacement of a certain amount of alcohols with the derived PET glycolyzates also reduced the amount of phthalic anhydride in the feed composition, because PET glycolyzate also introduced an aromatic ring.

## EXPERIMENTAL PART

### Glycolysis of PET

First step is to produce glycolysis product of waste PET. In a three-necked glass reactor equipped with a Dean–Stark separator, contact thermometer, and mechanical stirrer system 150 g PET flakes, and 187.4 g trimethylolethane (TME) were poured. Initial temperature was 115°C and after 30 minutes, a catalyst was added and temperature was set on 220°C for 5 h. Eurocat 9555 was used as catalyst. The mole ratio of trimethylolethane with respect to PET was 3 : 1. The same ratio of moles was used and in the glycolysis with PE and TMP.

### Synthesis of Alkyd Resins

To prepare alkyd resins based on waste PET material, glycolysis products of PET flakes were reacted with, phthalic anhydride, trimethylolpropane and linseed oil fatty acids. The combinations of reactants and their used masses in a synthesis of alkyd resins are shown in Table 1. Given amounts of reactants were placed in a four-necked glass reactor equipped with a Dean–Stark separator, nitrogen inlet tube, contact thermometer, and mechanical stirrer system. The temperature of the reaction was maintained constant at 220-250°C. Xylene [10% (w/w) of total ingredients charged] was used as the azeotropic solvent. The reactions were followed by determining the acid value (AV). Condensation reaction was allowed to proceed until the AV of the resin was approximately 20 mg KOH/g. The acid values were determined by titration of samples dissolved in ethanol–toluene with 0.1 M KOH solution. The alkyd samples were dissolved in white spirit to produce 60% (w/w) solution.

**Table 1.** The combinations of reactants and their used masses in a synthesis of alkyd resins

Alkyd resin	Hydrolysis products of waste PET (g)	PA <sup>a</sup> (g)	TMP <sup>b</sup> (g)	LFA <sup>c</sup> (g)
AR-TME	10	18	8	63
AR-PE	18	21	7	48
AR-TMP	20	23	8	45

<sup>a</sup>phthalic anhydride; <sup>b</sup>trimethylolpropane; <sup>c</sup>linseed oil fatty acids

### Analysis

The hydroxyl and the acid values of the synthesized alkyd resins were determined by standard methods [11,12]. Thin films of alkyd resins were deposited on KBr discs and Fourier-transform infrared (FTIR) spectra were recorded using a FTIR BOMEM MB 100 instrument. The  $^1\text{H}$  and  $^{13}\text{C}$  NMR spectral measurements of the alkyd resins were performed on a Varian Gemini 2000 (200 MHz). The spectra were recorded at room temperature in deuterated chloroform ( $\text{CDCl}_3$ ). The chemical shifts were expressed in ppm values referenced to tetramethylsilane (TMS).

### Results and Discussion

Characterization of the Synthesized Alkyd Resins. Three alkyd resins with different moieties of hydrolysis products of waste PET and different combinations of other reactants (Table 1) were synthesized.

Achieved yields, acid and hydroxyl values and the mass of removed water during the reaction of polyesterification for all synthesized alkyd are presented in Table 2.

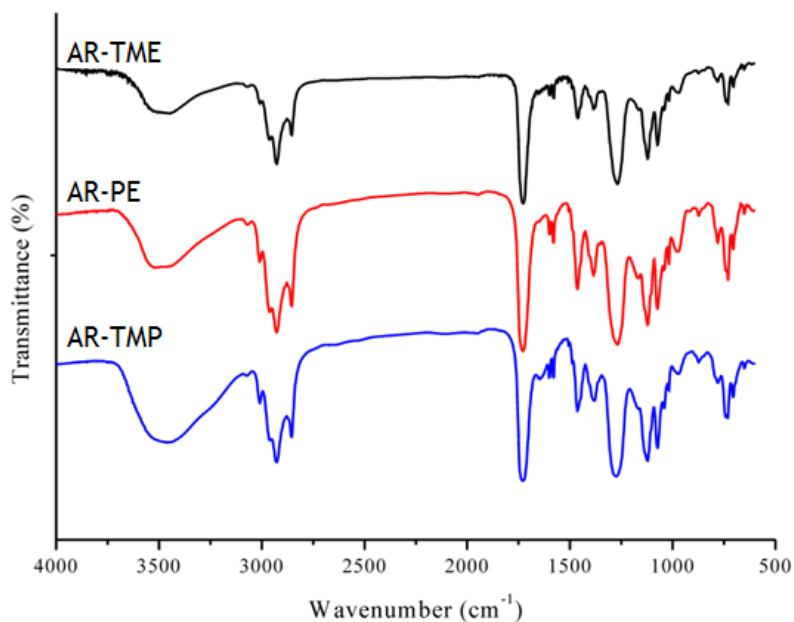
**Table 2.** Yields and acid values for alkyd resins and volumes of removed water during the reaction of polyesterification

Alkyd resin	AV (mgKOH/g)	HV (mgKOH/g)	Removed water (g)	Yield (%)
AR-TME	8	27	2.18	87.20
AR-PE	8	50.1	2.55	98.46
AR-TMP	8	77	2.80	99.20

It can be seen from the Table 2 that acid values are less than 20. This implies that reaction lasted long enough what is important for obtaining the resin with good mechanical properties.

The obtained alkyd resins were further characterized by FTIR and NMR spectroscopy. FTIR spectra are shown in Fig. 1. Characteristic broad band in the range from 3447 to 3520  $\text{cm}^{-1}$ , was attributed to the stretching vibration of OH group, while the aromatic and vinyl C-H stretching vibration could be observed as a shoulder at 3007 for AR-TME and 3009  $\text{cm}^{-1}$  for AR-PE and AR-TMP. Overlapping stretching vibrations of the  $\text{CH}_3$  and  $\text{CH}_2$  groups, asymmetric and symmetric, were located at 2961, 2927 and 2855  $\text{cm}^{-1}$ , respectively, and the corresponding bending vibrations appeared at 1463 and 1385  $\text{cm}^{-1}$ , respectively. The stretching vibration of the ester carbonyl group appeared at 1727 for AR-TME, AR-PE and AR-TMP. Also very strong band that appear in the range from 1268 to 1274  $\text{cm}^{-1}$  arise from the stretching vibrations of C-O in ester group. In the FTIR spectrum of the alkyd resins, the band that occurs from 970 to 976  $\text{cm}^{-1}$  corresponded to the C=C stretching (skeletal) vibration of the benzene ring. The two sharp and moderate bands observed around 740 and 730  $\text{cm}^{-1}$  were assigned to the skeletal deformation,  $\gamma(\text{CH})$ , vibration of the benzene ring.





**Figure 1.** FTIR spectra of alkyd resin

Structure of synthesized alkyd resin was also analyzed with NMR spectroscopy. NMR spectra of three obtained resin showed very similar and the results of  $^1\text{H}$  and  $^{13}\text{C}$  NMR analysis of AR-TME, as representative sample, are as follow:

$^1\text{H}$  NMR: (200 MHz,  $\text{CDCl}_3$ ):  $\delta = 0,76-1,05$  (m, 9H,  $\text{CH}_3$ ), 1,12-1,44 (s, 23H,  $\text{CH}_2$ ), 1,46-1,78 (s, 5H,  $\text{CH}_2$ ), 1,82-2,15 (m, 6H,  $=\text{CHCH}_2$ ), 2,20-2,40 (m, 4H,  $\text{CH}_2\text{COOCH}_2$ ), 2,72-2,88 (d, 4H,  $=\text{CHCH}_2\text{CH}=\text{}$ ), 3,40-3,76 (m, 2H,  $\text{PACOOCH}_2$  i  $\text{alkilCOOCH}_2$ ), 4,01-4,68 (m, 9H,  $\text{TPACOOCH}_2$ ), 5,22-5,48 (d, 7H,  $-\text{CH}=\text{CH}-$ ), 7,40-7,82 (d, 4H,  $\text{PAH}$ ), 7,96-8,14 (d, 1H,  $\text{TPAH}$ ) ppm;

$^{13}\text{C}$  NMR: (125 MHz,  $\text{CDCl}_3$ ):  $\delta = 7,321$ ; 13,748; 14,039; 14,203; 15,532; 15,552; 19,647; 20,466; 20,867; 21,249; 22,487; 22,597; 23,143; 24,800; 25,455; 25,456; 27,112; 29,042; 29,242; 29,515; 29,625; 30,355; 31,455; 31,828; 32,429; 34,104; 40,804; 42,443; 42,716; 62,143; 63,745; 65,402; 70,464; 73,741; 125,268-132,459; 134,626; 137,739; 165,396; 167,308; 173,480.

#### Testing of the mechanical properties of the coating.

Dry films of the synthesized resins are shown in Fig. 2. It can be seen that all of them have adequate transparency so they can be used as lacquers and stains. It was concluded, by detailed visual inspection, that AR-TMP has the best aesthetic characteristics.



**Figure 2.** Dry films of the AR-TMP on metal plate

Due to mechanical properties of coatings depend of the thickness of dry films, they were measured prior to testing and the data are given in the Table 3, along with the data of mechanical properties.

**Table 3.** Thickness and mechanical properties of the dry films

Alkyd resin	Thickness, $\mu\text{m}$	Hardness, sec	Elasticity, mm	Flexibility $\varnothing$ 6 mm	Stickiness 0-good 4-bad
AR-TME	20	60	10	OK	0
AR-TMP	33	13	10	OK	0
AR-DPG	35	89	10	OK	0

Thickness of dry film is in the range from 35 to 20  $\mu\text{m}$  depending on the dry matter content of the synthesized resins. Hardness varied between 13 and 89 sec, whereby AR-DPG resin showed significantly higher hardness than commercial resins.

## CONCLUSIONS

The main purpose of this work is to investigate possibility of waste-PET glycolizates using in alkyd resin production. Therefore, waste PET-based alkyd resins were prepared by reacting hydrolysis products of waste PET with trimethylolethane, pentaerythritol, trimethylolpropane, phthalic anhydride and linseed oil fatty acids. Mechanical properties testing results provided improved mechanical properties compared to the reported alkyds from difunctional glycolyzates and also conventional general purpose resins.

## REFERENCES

1. P.G. Karayannidis, S.D. Achilias, D.I. Sideridou, N.D. Bikiaris (2005) Alkyd resins derived from glycolized waste poly(ethylene terephthalate), *European Polymer Journal*, 41, 201–210.
2. G. Güçlü, M.Orbay (2009) Alkyd resins synthesized from postconsumer PET bottles, *Progress in Organic Coatings*, 65, 362–365.
3. L. Bartolome, M. Imran, B. G. Cho, W. A. Al-Masry, D. H. Kim, Recent developments in the chemical recycling of PET. *Mat. Recyc.–Tr. and Perspec.* (2012) 65-84.
4. A. M. Al-Sabagh, F. Z. Yehia, A.-M. M. F. Eissa, M. E. Moustafa, G. Eshaq, A.-R. M. Rabie, A. E. ElMetwally, Glycolysis of Poly(ethylene terephthalate) Catalyzed by the Lewis Base Ionic Liquid [Bmim][OAc]. *Ind. and Eng. Chem. Res.* 53 (2014) 18443-18451.
5. L. Bartolome, M. Imran, K. G. Lee, A. Sangalang, J. K. Ahn, D. H. Kim, Superparamagnetic  $\gamma$ -Fe<sub>2</sub>O<sub>3</sub> nanoparticles as an easily recoverable catalyst for the chemical recycling of PET. *Green Chem.* 16 (2014) 279-286.
6. Q. Wang, X. Yao, Y. Geng, Q. Zhou, X. Lu, S. Zhang, Deep eutectic solvents as highly active catalysts for the fast and mild glycolysis of poly(ethylene terephthalate)(PET). *Green Chem.* 17 (2015) 2473-2479.
7. F. Pardal, G. Tersac, Kinetics of poly(ethylene terephthalate) glycolysis by diethylene glycol. Part II: Effect of temperature, catalyst and polymer morphology. *Polym. Deg and Stab.* 92 (2007) 611-616.
8. S. M. Cakić, I. S. Ristić, M. M. Cincović, N. Č. Nikolić, O. Z. Ilić, D. T. Stojiljković J. K. B-Simendić, Glycolyzed products from PET waste and their application in synthesis of polyurethane dispersions. *Prog. in Org. Coat.* 74 (2012) 115-124.
9. A. Torlakoğlu, G. Güçlü, Alkyd–amino resins based on waste PET for coating applications. *Waste Manag.* 29 (2009) 350-354.
10. F. Pardal, G. Tersac, Comparative reactivity of glycols in PET glycolysis. *Polym. Deg. and Stab.* 91 (2006) 2567-2578.
11. ISO 4326:1992: Non-ionic surface active agents - Polyethoxylated derivatives - Determination of hydroxyl value - Acetic anhydride method.
12. ASTM D3644: Standard Test Method for Acid Number of Styrene-Maleic Anhydride Resins, 2012.



## THE CONCEPT OF SUSTAINABLE LANDFILLS

Vesna Alivojvodic, N. Bukumiric, A. Bozic, M. Stamenovic, S. Djarmati

College of Vocational Studies , Belgrade Polytechnic, SERBIA

### ABSTRACT

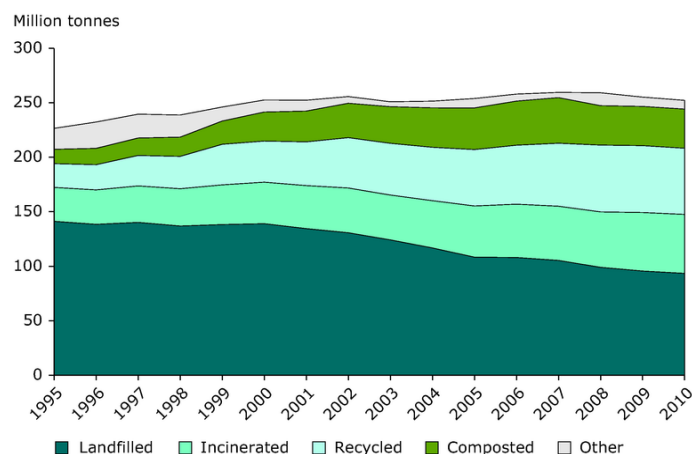
Many countries have made efforts to reduce the amount of waste going to landfills, through waste reduction, recycling, composting and incineration. But no matter how much prevention, reuse and recycling a society manages to realize, there will always be a role for landfills in an integrated waste management. The important goal for any society would be to adopt sustainable methods of desposing waste in order to minimize the negative effects on the environment, and the economy of the involved area.

### INTRODUCTION

The sustainability is an ideology interlinking social, economic and environmental pillars, with the goal of reducing climate change and improving the health of people and the planet [1]. The terms "landfill" and "sustainability", may suggest a contradiction, as landfills sites, set aside for the final disposal, appear to be the opposite of sustainable practice [2]. Development of technologies that allow landfills to be operated in a more sustainable manner is the goal of sustainability. In the developed world, modern landfills are constructed and operated to meet some sustainability objectives by providing protection of human health and the environment in a cost-effective fashion [3]. For a landfill to be sustainable it must be designed to minimize its impact during its operative life.

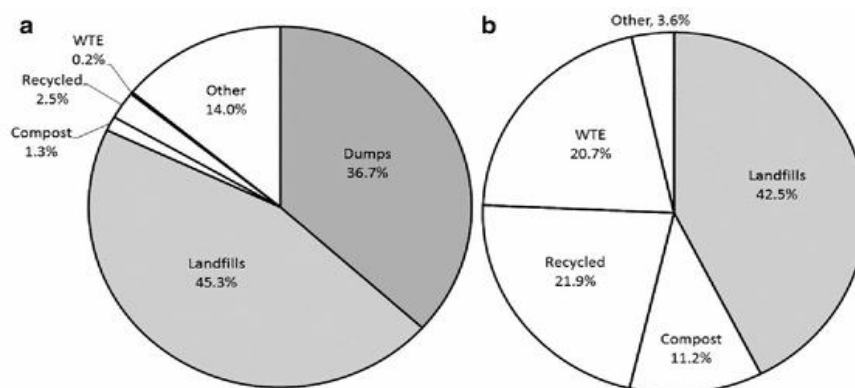
### TOWARDS SUSTAINABILITY

As landfills remain a major component of most integrated waste management systems around the world it would be important to be recognize by the society as a valuable and essential element of a waste management system (Fig. 1).



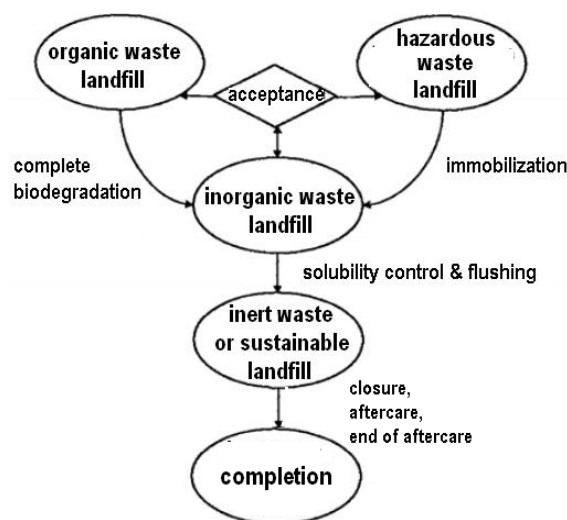
**Figure 1.** Development of municipal waste management in the EU-27, 1995–2010 (published: Jun 2012, EEA)

We have to have in mind that municipal generation and composition varies by country and region, depending on factors such as income per capita, dominant industries, and cultural practises (Fig. 2) [3].



**Figure 2.** Estimated MSW management in (a) middle and low income countries, and (b) high income countries [3]

Throughout the world various methods are proposed to stimulate landfill processes in order to accelerate achievement of a stabilised landfill. In the end the goal is the same: to achieve completion of the landfill. For all types of waste on the road to completion it seems inevitable to ‘pass through’ a stage that is comparable to an inorganic waste landfill (Fig.3).



**Figure 3.** Waste types and processes to achieve a stabilised sustainable landfill [2]

One of the main research issues for the scientific community active on landfilling, is finding the way to put in practice everything this principle represents. Main questions are [4]:

- Which technologies and tools may be applied for reaching sustainability?
- How to set targets for the final residual landfill quality
- Which legal and financial liability should be provided and by which means?
- Which changes/integration in the existing regulations are necessary in order to implement the sustainable landfill concept?

### PRINCIPLE OF MASS BALANCE

One of useful tools for approaching the sustainable landfill concept and for organising the information needed for supporting policy is the mass balance model [2]. It usually considers the fate of substances entering and leaving a system in various ways (eq.1).

$$\text{Accumulation } (dm/dt) = \text{Inlet} - \text{Outlet} - \text{Degradation} \quad (\text{eq.1})$$

This model (Fig.4) allows to determine the effects of different alternatives for waste and landfill management, on the reductions of the emissions within a given time frame.

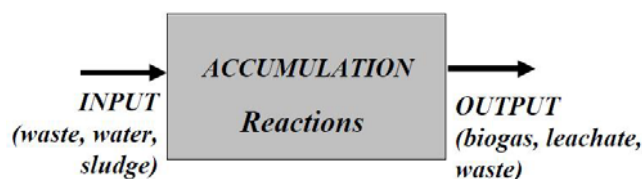


Figure 4. The landfill mass flow scheme [4,5 ]

This should be the reference criteria for evaluating any technology, or combination of technologies, which could be applied for reaching this target [4]. Pre-treatment, in situ treatment, and post-treatment in the aftercare phase should be considered in an integrated way looking for the performance of the system, at the same time having in mind the final result: reach of the sustainable targets. Several treatment methods are presented as well as their influence to the landfill, especially to the environmental impacts mainly caused by the organic load in Table 1.

Table 1. How we can affect mass balance [5].

	Treatment	Decomposition duration	Landfill volume	Income Organic load	Leachate organic load	Biogas organic load	Disposed Solid waste quality
Treatment prior to landfilling	Mechanical/Biological Treatment (MBT)	-	-	--	--	--	Acceptable
	Thermal Treatment	---	---	---	---	---	Acceptable
	Waste minimisation	--	-		+	+	Non acceptable
	Bailing	+	-		--	--	Non acceptable
In-situ treatment	Leachate recirculation				+	+	
	In situ aeration	-	-		-	-	Acceptable
	Anaerobic degradation		-		+	++	Non acceptable

Cross (+): parameter increase  
Dash (-): parameter decrease

This table shows that an acceptable quality of the disposed solid waste, that will not consist a threat for the environment at the end of the aftercare phase, can be achieved only by solid waste treatment prior to landfilling.

## CONCLUSION

Prevention, reuse and recycling should be favoured over disposal, unfortunately, the landfills still remain an important and indispensable technology for our society, so it is important to adopt sustainable methods of desposing waste. Sustainable landfills are a realistic and promising technique for the future and they do not necessarily have to pose a threat to the environment or to human health. The mass balance is a useful tool for approaching the sustainable landfill. Basic condition for the

implementation of an integrated solid waste management system, with respect to the environment is sustainable landfill, for accomplishing this, solid waste treatment prior to landfilling is a precondition.

#### **REFERENCES**

1. Millward, K.: Landfill vs incineration: Part 1, Sustainable Business Toolkit 2012.
2. Scharff Heijo, The Role Of Sustainable Landfill In Future Waste Management Systems, NV Afvalzorg Holding,
3. Townsend, T.G.at all: Sustainable Practices for Landfill Design and Operation, Springer, 2015.
4. Cossu, R.: THE SUSTAINABLE LANDFILLING CONCEPT, Tenth International Waste Management and Landfill Symposium, Proceedings Sardinia 2005
5. Mavropoulos, A., Kamariotakis H.: The concept of sustainable landfills, Master Class on Sustainable Landfills, ISWA 2009 Conference.



**MECHANICAL PROPERTIES OF RIGID POLYURETHANE FOAMS  
 WITH ADDITION OF RECYCLED POLYURETHANES**

**Ivan Ristic<sup>1\*</sup>, T. Erceg<sup>1</sup>, I. Krakovsky<sup>2</sup>, R. Radicevic<sup>1</sup>, B. Pilic<sup>1</sup>,  
 A. Miletic<sup>1</sup>, D. Manjencic<sup>1</sup>**

<sup>1</sup>University of Novi Sad, Faculty of Technology, Bulevar cara Lazara 1,  
 Novi Sad, SERBIA

<sup>2</sup>Charles University, Faculty of Mathematics and Physics,  
 Ke Karlovu 3, Prague, CZECH REPUBLIC

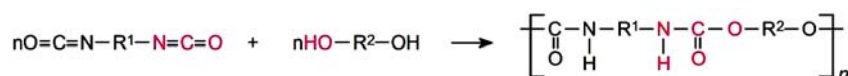
\*ivan.ristic@uns.ac.rs

**ABSTRACT**

Polymer foams are made up of a solid and gas phase forming polymer matrix with either air bubbles or air tunnels incorporated in it, which is known as either closed-cell or open-cell structure. They make up the largest part of global polyurethane production. A large part of polyurethane foams can be re-used after certain modifications. Different technologies for recycling PU foams and waste from their production have developed such as chemical recycling, pyrolysis and the re-use of materials through the use of minced granules and energy recovery. The aim of this work is synthesis of rigid polyurethane foams using a recycled foam as a feedstock. Rise and gel time as well as mechanical properties of synthesized foams were investigated and compared to properties of pure rigid foams, synthesized without addition of recycled one.

**INTRODUCTION**

The polymeric materials, known as polyurethane, form a family of polymers which are different from most other plastics. It is a huge family of polymers different composition and properties, where the monomers are linked by urethane bond. Polyurethanes are made by the exothermic reaction between diols or polyols that have two or more reactive hydroxyl (-OH) groups per molecule (diols, triols, polyols) and isocyanates that have more than one reactive isocyanate group (-NCO) per molecule (diisocyanates, polyisocyanates). Urethane bond is formed by addition of hydroxyl group on the isocyanate group (*Figure 1*).



**Figure 1.** Forming of urethane bond by the reaction between diisocyanate and diol

Chemical structure and physical properties of polyurethane materials depend on reactive component structure. Aromatic diisocyanates exhibit a greater reactivity compared to aliphatic or cycloaliphatic isocyanates. Thus, for example, the use of aromatic isocyanate polyurethane gives considerably more rigid polyurethane materials in comparison to aliphatic, but with reduced oxidative and UV stability. The type and structure of the isocyanate, and the position of isocyanate groups affect the reactivity with nucleophilic reagents, as well as the properties of the polyurethane. The polyols used in polyurethane production are polyalcohols, hydroxy-polyethers and hydroxy-polyesters. Recently, in order to obtaining ecologically acceptable materials, the natural oils such as castrol oil are used as polyol component for polyurethane synthesis. The size of polyol molecule, number of reactive hydroxyl groups per molecule and flexibility of molecular structure control the degree of cross-linking between molecules. It has significant effect on mechanical properties of polyurethanes. Beside monomers (isocyanates and polyols), different kinds of additives are employed in production of polyurethanes, such as catalysts, chain extenders and cross-linking agents, blowing agents and surfactants, plasticisers, fillers, flame retardants, antibacterial and antistatic agents, stabilizers and colorants.

Type of additives depends on desirable properties of obtaining material and its application. Polyurethanes can be produced in different forms including elastomers, thermoplastic elastomers, coatings, adhesives, thermoreactive polyurethanes, foams. Cross-linking agents such as polyisocyanate or polyol with more functional groups are used in order to obtain foams, elastomer and thermoreactive materials. Blowing agents and surfactants are components of polyurethane foams. Plasticisers reduce the hardness of the products and fillers improve stiffness and reduce the cost of final product. Stabilizers are added to protect polymer from light, heat, atmospheric contaminants. To protect material against light degradation UV screener such as hydroxybenzotriazole are used. Protection from oxidative degradation are provided by adding of antioxidants. Commonly used antioxidants are monomeric and polymeric hindered phenols. Compounds with tertiary amine functionality can interact with the oxides of nitrogen in air pollution and inhibit discoloration. Colorants can be added to change aesthetic appearance of formed polymer. Polyurethane foams make up the largest part of global polyurethane production. They are divided into two families – rigid foams and flexible foams. Rigid foams are primarily used as thermal insulation in refrigerators, building panels and other similar insulating applications. Flexible foams are used most for mattresses, cushions and car seats, also for packaging materials and floor coverings.

### **Polyurethane foams**

Polymer foams are made up of a solid and gas phase forming polymer matrix with either air bubbles or air tunnels incorporated in it, which is known as either closed-cell or open-cell structure. Closed-cell foams are generally more rigid, while open-cell foams are usually flexible. The difference between making polyurethane and polyurethane foam is that a gas has to be incorporated in the final product, by reaction between isocyanate group and water forming an carbamine acid in first step, that is being decomposed into amine and CO<sub>2</sub> gas in the second step (*Figure 2*) [1]. Gas expands the



polyurethane material [3]. Table 1 shows the different recycling technologies of polyurethane foams.

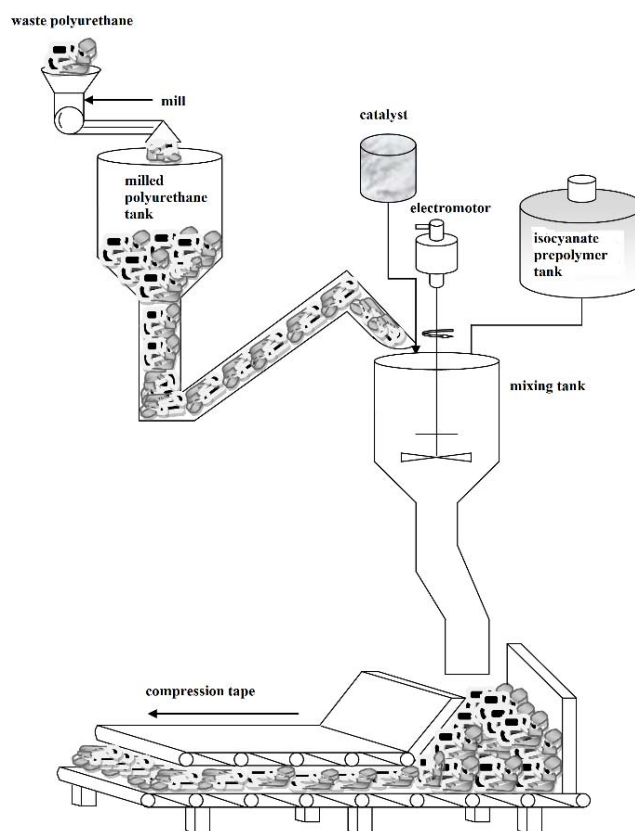
**Table 1.** Technologies of PU foam recycling

Technology	Process
Physical recycling	Chopping
	Fine grinding
Chemical recycling	Hydrolysis
	Glicolysis
	Pirolisis
Energy recovery	Gasification at high temperatures
	Combustion in rotary kilns

### *Physical recycling of polyurethane foams*

Polyurethane foams in car seats will become probably the most important plastic resins for recycling [4]. The reasons lie in the many benefits of foam at critical steps in the recycling process. First of all, PU foams can be easily separated from the other materials in the seat. They have low price for processing into a product (by chopping) that can be sold and there is a huge market for recycled materials (substrates for carpets). A critical issue that can prevent high degree of recycling is the high cost of removing foam from the vehicle. In the preparation of soft polyurethane foam for cushioning 8-12% of waste foam is used, depending on the form of foam blocks, and the complexity of the cut parts. Granulate PU foam in combination with some other waste material is used in the manufacture of carpets. The first step towards the re-use of polyurethane foam is the separation of foam from wire, fabric and other debris. The foam is then chopped into pieces of appropriate size and sealed in a binder. The generally used binder is isocyanate prepolymer prepared from toluene diisocyanate (TDI) or diphenylmethane diisocyanate (MDI) with a lower stechiometric ratio of the polyether polyol. This type of prepolymer contains an excess of isocyanate which reacts with vapour in the curing process. The amount of binder used in process is about 10-20% per foam weight. After addition of the catalyst and stirring, the mixture of foam and binder are placed in a mold, compressed and cured, by heating using a vapour [5].

This process can be carried out in various degrees of compression (*Figure 2*), that results in production of foams in the desired density range of 40-100 kg m<sup>-3</sup>.



**Figure 2.** The procedure for obtaining the polyurethane foam from foam waste

New flexible foams also can be obtained by re-using of ground or powdered PU materials. The mixture polyol/ground foam can be processed by conventional equipment to obtain molded foam. Optimization of the catalyst and the isocyanate can be influenced by the properties of the obtained foam [3].

#### *Chemical recycling of polyurethane foams*

Chemical recycling methods include hydrolysis, pyrolysis and glycolysis. Flexible polyurethane foams can be hydrolysed by high pressure vapour to give polyamine, polyol, and carbon dioxide. Diamines are distilled and separated from the vapour stream, and polyol was obtained by separating of the hydrolyses residues. Obtained polyol can be used for the preparation of new foam with amount of 5% (relative to pure polyol), with excellent results [6]. Reaction of glycolysis between polyurethane and glycol gives a mixture of polyhydroxy compounds which can be used

directly, without further separation [7]. Polyols obtained by this method have a fairly low equivalent weight ( $95 \pm 5$ ) and they are best suited for rigid foam. In the process of obtaining PU foam recycled polyol can replace up to 70% pure polyol [8]. Conditions for pyrolysis of polyurethane materials are temperature range of 250-1200 °C, and the oxidizing or inert atmosphere [9]. The isocyanate and hydroxide are formed by random cleavage of urethane linkages during the process of pyrolysis polyurethane based on polypropylene glycol (PPG) and toluene diisocyanate (TDI) in an inert atmosphere at 200-250 °C [10].

## EXPERIMENTAL PART

In this paper mechanical properties as well as rise and gel time of rigid polyurethane foams have been investigated before and after addition of different amounts of recycled PU foams. Recycling of PU foams were done by physical method. Mechanical characterisation included tensile tests.

### Materials and methods

Polyurethane foams were synthesized using a polymer 4,4'-methylenediphenyl diisocyanate or polymethylene polyphenyl isocyanate (PMDI) as isocyanate component (IsoPMDI 92140, manufacturer BASF) with average functionality 2.7 (Figure 3). Polyol component was polyether (Elastopor H 1622, manufacturer BASF) and castrol oil, with hydroxy number 170 mg KOH g<sup>-1</sup> and acid value 1.27 mg KOH g<sup>-1</sup>, (producer Merck Chemical Co). As filler was used cement (manufacturer Lafarge, Beočin, Serbia).

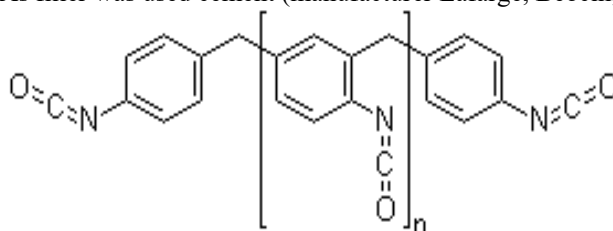


Figure 3. Structure of PMDI

Synthesis of polyurethane foams was carried out by mixing of polyol and isocyanate component for 10 s, and pouring in the mold after that heated to 45 °C. Synthesis were performed in fume hood with all the necessary protective measures. Tensile tests were performed by using an universal testing machine Instron 1122, monitoring of force during the stretching of the sample. Samples of rigid PU foams were prepared by varying the amounts of polyol isocyanate. After stirring for 10 s, rise and gel time of preparing samples were determined, as well as tensile strength and elongation at break after different stirring time. Another series of samples were prepared by addition of different amounts of recycled PU foams, and the same measurements have been done for them.

## RESULTS AND DISCUSSION

The obtained results showed that rise time of samples increases with increasing of amount of recycled PU foams, as reported in *Table 3*. In values of gel time were observed fluctuations.

**Table 2.** Rise and gel time of rigid polyurethane foam stirred for 10 s

Polyol:isocyanate	Rise time [s]	Gel time [s]
<b>1:1</b>	243	380
<b>1:1,05</b>	336	449
<b>1:1,1</b>	327	495
<b>1:1,2</b>	337	572
<b>0,9:1</b>	404	545

**Table 3.** Rise and gel time of rigid polyurethane foam with the addition of recycled PU foam in different amounts

Amount of recycled PU foam [wt %]	Mass of recycled PU foam [g]	Rise time [s]	Gel time [s]
0,25	0,0187	225	594
0,5	0,0375	243	483
1	0,0750	251	500
2	0,1500	279	475
5	0,3750	343	632
10	0,7500	491	807
20	1,5000	531	890

With increasing of stirring time, compressive strenght first increase then decrease for pure PU samples (without addition of recycled PU foams), as reported in *Table 4*. Plastic deformation of PU foam after 100 % of compression has fluctuations in values. Compressive strenght of samples with addition of recycled foams alternately rise and wane with increasing the amount of recycled PU foam.

**Table 4.** Mechanical properties of rigid polyurethane foams without the addition of recycled PU foams

Polyol:isocyanate	Stirring time [s]	F [N]	Plastic deformation, %
<b>1:1,05</b>	5	320	0,938
<b>1:1,05</b>	10	403	0,831
<b>1:1,05</b>	15	400	0,939
<b>1:1,05</b>	20	340	0,919
<b>0,9:1</b>	10	405	0,916
<b>1:1</b>	10	390	0,832
<b>1:1,1</b>	10	402	0,913
<b>1:1,2</b>	10	460	0,898

**Table 5.** Mechanical properties of rigid polyurethane foam with the addition of recycled PU foam

Amount of recycled PU foam [wt %]	F [N]	Plastic deformation, %
0,25	460	0,879
0,5	430	0,907
1	497	0,9
2	429	0,888
5	473	0,89
10	432	0,905
20	712	0,912
50	535	0,878

## CONCLUSIONS

Polyurethane foams were synthesized using a polymer 4,4'-methylenediphenyl diisocyanate or polymethylene polyphenyl isocyanate (PMDI), polyether and castrol oil. Samples of rigid PU foams were prepared by varying the amounts of polyol an isocyanate. Rise and gel time of prepaing samples were determined, as well as compressive strenght and plastic deformation after different stirring time. Another series of samples were prepared by addition of different amounts of recycled PU foams, and the same measurements have been done for them. Obtained results have showed that using a recycled foam as feedstock in synthesis of rigid polyurethane foams does not deteriorate structure and mechanical properties of synthesized foams.

## Acknowledgment

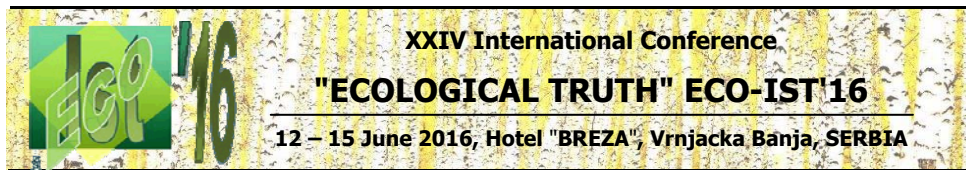
*Authors wish to express the gratitude to the Ministry of Education, Science and Technological Development Republic of Serbia, Project No. III 45022 and project 19/6-030/3-2-37-1/15 founded by Ministry of science and technology of the Republic of Srpska.*

## REFERENCES

1. Ashida, K. «Polyurethane and Related Foams», Taylor and Francis, 2007.
2. Kapps, M., The production of rigid polyurethane foam, Business Development – Insulation, Bayer MaterialScience AG, D-51368 Leverkusen, 2004.
3. Ristić I., Strukturiranje poliuretanskih materijala, monografija, Tehnološki fakultet Novi Sad (2015), ISBN 978-86-6253-041-7.
4. M. Z. Khalid, H. N. Bhatti, I. A. Bhatti, Methods for polyurethane and polyurethane composites, recycling and recovery: A review, React Funct Polym, 2007, 67, 675-692
5. M. Roegler, Slabstock Foams; In Polyurethane Handbook; Oertel, G., Ed.; Hanser: Munich, 1985, 176-177.
6. G. A. Campbell, W. C. Meluch, Polyurethane Foam Recycling, Environ Sci Tech, 1976, 10, 182-185.



7. H. Ulrich, A. Odinak, B. Tucker, A. A. R. Sayigh, Recycling of Polyurethane and Polyisocyanurate Foam, *Polym Eng Sci*, 1978, 18, 844-848.
8. E. Simioni, M. Modesti, C. A. Brambilla, Polyester Polyols from Microcellular Elastomer Scrap for Rigid Polyurethane and Polyisocyanurate Foam Production, *Cell Polym*, 1989, 8, 387-400.
9. P. Maya, B.C. Levin, Review of the Literature on the Gaseous Products and Toxicity Generated from the Pyrolysis and Combustion of Rigid Polyurethane Foams, *Fire Mater*, 1987, 11, 1-29.
10. W.D. Wooley, Nitrogen-Containing Products from the Thermal Decomposition of Flexible Polyurethane Foams, *Br Polym J*, 1972, 4, 27-43.



## RECONSTRUCTED SMELTING SLAG PROCESSING PLANT. PART 3 – DEWATERING OF TAILINGS

Ivana Jovanovic<sup>1\*</sup>, S. Petrovic<sup>1</sup>, S. Magdalinovic<sup>1</sup>, R. Pantovic<sup>2</sup>, D. Milanovic<sup>1</sup>,  
I. Andjelovic<sup>3</sup>, M. Mikić<sup>1</sup>

<sup>1</sup>Mining and Metallurgy Institute Bor, 35 Zeleni bulevar St, 19210 Bor, SERBIA

<sup>2</sup>University of Belgrade, Technical Faculty in Bor, 12 V.J. St. Bor, SERBIA

<sup>3</sup>RTB Bor Group – Mining and Smelting Complex Bor,  
29 Djordja Vajferta St, 19210 Bor, SERBIA

\*[ivajo7@gmail.com](mailto:ivajo7@gmail.com)

### ABSTRACT

Reconstruction of Bor Copper Smelter and construction of the new Sulfuric Acid Factory demand new technological line for smelting slag processing with the aim of achieving maximal metallurgical recovery of copper. Consequently, reconstruction of the existing and installation of new equipment in the Bor flotation plant is required.

This paper contains a textual and graphical representation of technological scheme of final tailings dewatering as a part of slag processing plant. Final tailings is a mixture of tailings from slag and underground ore flotation processes. In addition, paper contains the description of characteristic technical solutions of final tailings thickening and recycling water transport back to the flotation process.

**Key words:** smelting slag, copper, flotation tailings, dewatering.

### INTRODUCTION

When it comes to RTB Bor, the first recorded testing of copper valorization by flotation of smelting slag dating back to 1970. The testing was carried out on samples of differently cooled converter slag. It was then found that at various modes of slag cooling, a quality copper concentrate could be obtained. Regarding the granulated slag, concentrate grade was between 20 and 25% Cu, with recovery of 90–92%. The results on non-granulated slag were slightly worse. Corresponding tests on slag from blast furnace didn't give positive results.

In mid-1972 a detailed research of the possibilities for industrial valorization of copper from the converter slag was performed. On that occasion, total amount of 5913 tonnes of slag was processed (average copper content in slag was 4.80%). The final flotation concentrate contained 38.97% Cu with recovery of 83.83%. Tailings grade was 0.86%. However, despite the satisfactory results, industrial slag processing line was not established.

In the following period until 1990, there was no detailed research regarding the slags from Bor Copper Smelter. After that, a series of testings related to the possibility of copper flotation from smelting slag were conducted in the nineties. Finally, on the 01.06.2001 the first industrial processing of blast furnace slag was started in Bor flotation plant. Table 1 shows the achieved results in the period of 2001–2005 [1].

Slag processing in the Bor flotation plant lasts until today. However, the Project of the Smelter reconstruction and the construction of the Sulfuric Acid Factory have imposed the need for a new reconstruction of the flotation plant. Namely, for more effective processing of smelting slag from the new Smelter, one of the existing technological lines in Bor flotation (grinding section "B") have been employed. Section "B" have been revitalized and equipped to work with new raw material, so that the requirements for high grade concentrate can be achieved (copper content in concentrate above 30%) [2].

**Table 1.** The results of smelting slag processing in period 2000 – 2001 [1].

Year	Slag production [t/year]	Cu content in slag [%]	Cu content in concentrate [%]	Cu recovery in concentrate [%]
2001.	14 617	0.747	15.16	75.06
2002.	159 717	0.644	12.76	63.47
2003.	333 438	0.565	10.16	57.04
2004.	271 624	0.529	12.56	51.27
2005.	138 963	0.729	12.76	36.57

The total annual production of smelting slag from new Smelter is planned to be 340000 tonnes per year, with an average copper content of about 2%. Thereof, one quantity of smelter slag will be obtained from Flash smelting process, while the other quantity will be obtained from PS-converter.

### THE PROCEDURE OF SLAG GENERATION AND PROCESSING

Slag from the flash furnace and PS-converter of new Smelter (temperature of 1200 – 1300°C) will be poured into the slag pots and transported to the slag cooling place by special vehicles for slag pots transportation. The cooling of slag will be combined: firstly slow at the air and after that rapid by water. This procedure enables appropriate crystallization of copper grains, which results in a better flotation recovery as well as lower costs of comminution. Average chemical composition of smelting slag is presented in Table 2.

**Table 2.** Chemical composition of smelting slag.

Origin of slag	Cu, %	Fe,%	S,%	Pb,%	Zn,%	SiO <sub>2</sub> ,%	As,%	Sb,%
Flash furnace	1.4	42.5	1.2	0.07	0.5	29.0	0.04	0.01
PS-converter	6.0	48.6	1.0	0.62	0.8	24.0	0.07	0.01

The whole cooling process will last about three days. In winter, this process is slightly shorter compared to summer conditions.

The cooled slag will be discharged from pots and stored in a pile. On this pile, slags from the flash furnace and PS-converter will be mixed in order to form the appropriate composite for transport to the flotation plant.

Thereafter, the slag will be transported by trucks to the receiving bunker, from where the further processing of slag will be performed, in order to obtain the final product – copper concentrate. This process includes the following technological lines: two-stage crushing and screening, three-stage grinding with two-stage classifying, rough flotation and scavenger with three-stage cleaning of copper concentrate, joining of final concentrates from slag and underground ore processing, thickening and filtration of collective final concentrate.

Collective final tailings (consisting of tailings from slag processing and tailings from underground ore processing) will be disposed, after thickening, on the existing RTH flotation tailings dump.

The process water supply of flotation plant will be from the pool located near the plant. The main electric power supply will be from the new substation, the construction of which is predicted as part of the flotation plant reconstruction and which will be located in the industrial complex MSC Bor. Drinking water is provided from the municipal water system.

#### **THE CHARACTERISTIC TECHNICAL SOLUTIONS WITHIN THE REVITALIZATION OF TAILINGS DEWATERING PLANT**

Within the reconstruction of the Bor flotation plant, it is planned to use the existing main equipment in the process of final tailings dewatering. That is the equipment at the disposal of plant, and it only needs to be overhauled, because the calculations showed that it satisfies the new processing conditions.

In order to provide undisturbed collective tailings thickening, the existing thickeners will be in use (Fig. 1 – positions 2 and 3), with a diameter of 60 m both, and the rake engine powers of 7.5 and 4 kW. Recycling water will be transported by the existing pumps (manufactured by Jastrebac – Niš, with engine power of 90 kW each), located in the pumping station PS5. However, it is planned to replace the existing piping systems for transporting the recycling water from the thickener to the process water pool.

Transport of thickened tailings to the tailings dump will continue to be done using centrifugal slurry pumps HPHZ 10"× 8", manufactured by FOD Bor, with engine power of 90 kW each.

For the equipment maintenance at the pumping station PS5 the existing crane (manufactured by Vulkan – Rijeka) will be in use. This crane has a load capacity of 2 t.



**Figure 1.** Thickeners for final tailings (taken from maps.google.com)

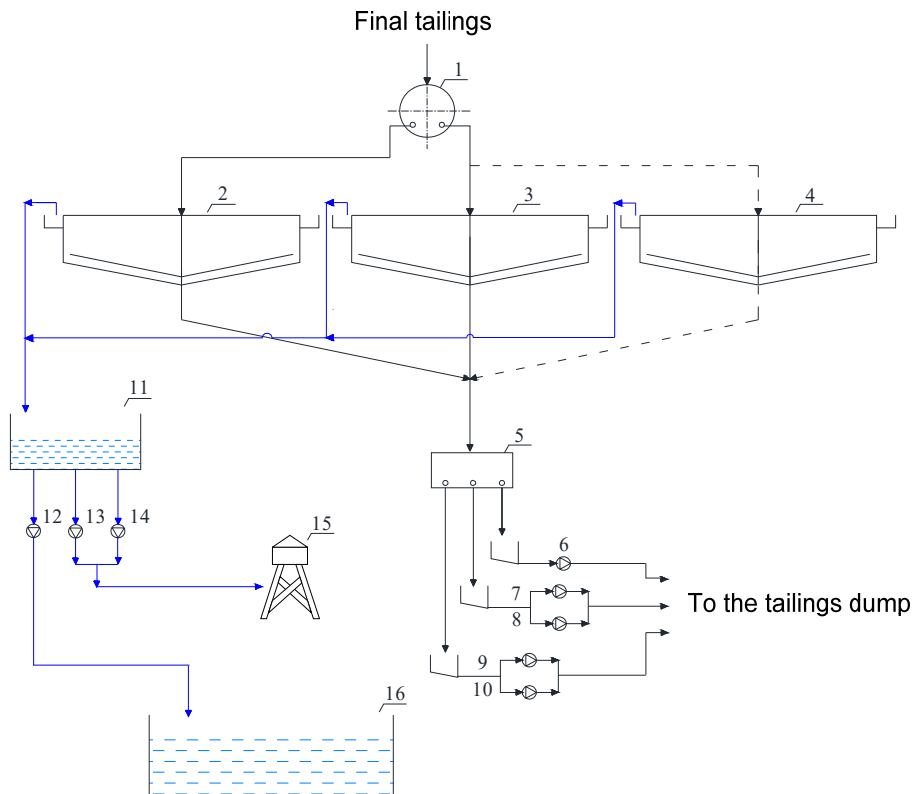
#### **DESCRIPTION OF THE TECHNOLOGICAL SCHEME OF THE FINAL TAILINGS DEWATERING IN THE RECONSTRUCTED PLANT FOR SMELTING SLAG PROCESSING**

Technological scheme of dewatering process of final tailings (consisting of tailings from slag processing and tailings from underground ore processing) is presented in the Fig. 2.

The final tailings will be transported through the existing pipeline system to the divider (pos. 1), and from there by canals to the thickeners (pos. 2, 3 and 4, two in work and one in reserve). Thickened tailings will be further gravitationally transported to the divider (pos. 5) in pumping station PS5, and then to the tanks of pumps (pos. 6, 7, 8, 9 and 10). Centrifugal slurry pumps at these positions send thickened tailings to RTH flotation tailings dump.

Overflow from thickeners (pos. 2, 3 and 4) represents the recycling water, that is transported by canals to the receiving pool (pos. 11) in the pumping station PS5. From the receiving pool at this position, recycling water is directed to three identical pumps (pos. 12, 13 and 14). Pumps at positions 13 and 14 are connected to a single pipeline with a diameter of 300 mm, which directs water to the water tower (pos. 15). The pump

at position 12 has its own pipeline with a diameter of 250 mm, which directs water to the process water pool (pos. 16).



**Figure 2.** Technological scheme of the final tailings dewatering in reconstructed plant

### CONCLUSION

The planned reconstruction of slag processing plant in Bor involves a series of new steps that include: revitalization of the existing equipment, replacement of existing equipment with new, setting of a new accompanying installations, setting of a new control and monitoring system, etc. When it comes to tailings dewatering plant, it was found that all the existing devices in the plant satisfy the new conditions in terms of processing capacity. Therefore, the plan is only to overhaul the devices as part of routine maintenance of the plant.

***Acknowledgement***

*This paper is the result of Project TR 34006 funded by the Ministry of Education, Science and Technological Development of the Republic of Serbia.*

**REFERENCES**

1. Mitrović, Z., Jovanović, R., 2007. Sto godina borskog rudarstva 1903-2003, sedamdeset pet godina basenskih flotacija 1929-2003, RTB Bor i Megatrend Univerzitet Beograd, 536 str. (In Serbian)
2. Dopunski rudarski projekat rekonstrukcije postrojenja za preradu topioničke šljake u flotaciji Bor, IRM Bor, 2015. (In Serbian)



**RECONSTRUCTED SMELTING SLAG PROCESING PLANT.  
PART 2 - DEWATERING OF DEFINITIVE COPPER CONCENTRATE**

**Sanja Petrovic<sup>1</sup>, I. Jovanovic<sup>1</sup>, S. Magdalinovic<sup>1</sup>, D. Petrovic<sup>2\*</sup>,  
D. Milanovic<sup>1</sup>, M. Mikic<sup>1</sup>**

<sup>1</sup>Mining and Metallurgy Institute Bor, 35 Zeleni bulevar St, 19210 Bor, SERBIA

<sup>2</sup>University of Belgrade, Technical Faculty in Bor, 12 V.J. St, 19210 Bor, SERBIA

\**dpetrovic@tf.bor.ac.rs*

**ABSTRACT**

A new project for the reconstruction of the Smelter plant and the construction of a new Sulfuric Acid plant provides the new technological line for processing of smelting slag, in order to achieve maximum metallurgical recovery of copper. This paper presents basic information about the plant design for dewatering of final copper concentrate in the reconstructed Flotation Plant Bor. The paper contains the technological scheme of the process of thickening and filtering the copper concentrate (final copper concentrate includes concentrates from smelting slag and underground ore flotation processes) as well as the characteristic technical solutions envisaged for this part of the flotation plant Bor

**Key words:** flotation, smelting slag, thickening, filtering.

**INTRODUCTION**

Smelting slag presents waste raw material with considerable content of copper. To produce every ton of copper, approximately 2.2–3.0 tons of copper slag is generated as a by-product material [1]. Smelter slag, a by-product of metallurgical processes, was made and dumped for over 100 years of ore exploitation in Bor Copper Mine.

In the RTB Bor, the first recorded testing of copper valorization by flotation of smelting slag dating back to 1970. The testing was carried out on samples of differently cooled converter slag. It was then found that at various modes of slag cooling, a quality copper concentrate could be obtained. Regarding the granulated slag, concentrate grade was between 20 and 25% Cu, with recovery of 90–92%. The results on non-granulated slag were slightly worse. Corresponding tests on slag from blast furnace didn't give positive results.

In mid-1972 a detailed research of the possibilities for industrial valorization of copper from the converter slag was performed. On that occasion, total amount of 5913 tones of slag was processed (average copper content in slag was 4.80%). The final flotation concentrate contained 38.97% Cu with recovery of 83.83%. Tailings grade was 0.86%. However, despite the satisfactory results, industrial slag processing line was not established.



In the following period until 1990, there was no detailed research regarding the slags from Bor Copper Smelter. After that, a series of testings related to the possibility of copper flotation from smelting slag were conducted in the nineties. Finally, on the 01.06.2001 the first industrial processing of blast furnace slag was started in Bor flotation plant. Table 1 shows the achieved results in the period of 2001–2005 [1].

Slag processing in the Bor flotation plant lasts until today. However, the Project of the Smelter reconstruction and the construction of the Sulfuric Acid Factory have imposed the need for a new reconstruction of the flotation plant. Namely, for more effective processing of smelting slag from the new Smelter, one of the existing technological lines in Bor flotation (grinding section "B") have been employed. Section "B" have been revitalized and equipped to work with new raw material, so that the requirements for high grade concentrate can be achieved (copper content in concentrate above 30%) [2].

**Table 1.** The results of smelting slag treating in the period 2001 - 2005 [2]

Year	Slag production [t/year]	Cu content in slag [%]	Cu content in concentrate [%]	Cu recovery in concentrate [%]
2001.	14 617	0.747	15.16	75.06
2002.	159 717	0.644	12.76	63.47
2003.	333 438	0.565	10.16	57.04
2004.	271 624	0.529	12.56	51.27
2005.	138 963	0.729	12.76	36.57

The total annual production of smelting slag from new Smelter is planned to be 340 000 tones per year, with an average copper content of about 2%. Thereof, one quantity of smelter slag will be obtained from Flash smelting process, while the other quantity will be obtained from PS-Converter.

#### SLAG FROM THE FLASH FURNACE AND PS CONVERTER

Slag from the flash furnace and PS-converter of new Smelter (temperature of 1200 – 1300°C) will be poured into the slag pots and transported to the slag cooling place by special vehicles for slag pots transportation. The cooling of slag will be combined: firstly slow at the air and after that rapid by water. This procedure enables appropriate crystallization of copper grains, which results in a better flotation recovery as well as lower costs of comminution. In Table 2 average chemical composition of smelting slag is presented.

**Table 2.** Chemical composition of smelting slag

Origin of slag	Cu, %	Fe,%	S,%	Pb,%	Zn,%	SiO <sub>2</sub> ,%	As,%	Sb,%
Flash furnace	1,4	42,5	1,2	0,07	0,5	29,0	0,04	0,01
PS-converter	6,0	48,6	1,0	0,62	0,8	24,0	0,07	0,01

The whole cooling process will last about three days. This process is slightly shorter in the winter, compared to summer conditions.

The cooled slag will be discharged from pots and stored in a pile. On this pile, slags from the flash furnace and PS-converter will be mixed in order to form the appropriate composite for transport to the flotation plant.

Thereafter, the slag will be transported by trucks to the receiving bunker, from where the further processing of slag will be performed, in order to obtain the final product – copper concentrate. This process includes the following technological lines: two-stage crushing and screening, three-stage grinding with two-stage classifying, rough flotation and scavenger with three-stage cleaning of copper concentrate, joining of final concentrates from slag and underground ore processing, thickening and filtration of collective final concentrate.

Collective final tailings (consisting of tailings from slag processing and tailings from underground ore processing) will be disposed, after thickening, on the existing RTH flotation tailings dump.

The process water supply of flotation plant will be from the pool located near the plant. The main electric power supply will be from the new substation, the construction of which is predicted as part of the flotation plant reconstruction and which will be located within the industrial complex MSC Bor<sup>1</sup>. Drinking water is provided from the municipal water system.

#### **THE CHARACTERISTIC TECHNICAL SOLUTIONS IN THE REVITALIZATION OF DEWATERING PLANT OF COPPER CONCENTRATE**

In the process of dewatering of definitive copper concentrate, as part of the reconstruction project, it is planned that the existing equipment keeps and repaired.

In the part of the filtering of copper concentrate, there are four disk vacuum filters with disk diameter of 2.8 m and engine power of 2.5 kW (manufacturer Denver) and four vacuum pumps with engine power of 75 kW (manufacturer NASH). It was provided that one disk vacuum filter (Figure 1 - position 3) with associated pumping unit (position PU3) will be repaired.

For compressed air system supply it will be use two existing air blowers (engine power 22 kW each) and the both blowers will be repaired.

At a later stage, it is proposing that all disk vacuum filters repairing, as well as all the associated vacuum pumps. In addition, in the troughs of filter should be installed mixers, to prevent the precipitation of material on the bottom of the trough. For the installation of equipment and subsequent maintenance of the same the existing cranes will be used, with load capacity of 5t and 3t (manufacturer MIN Niš).

---

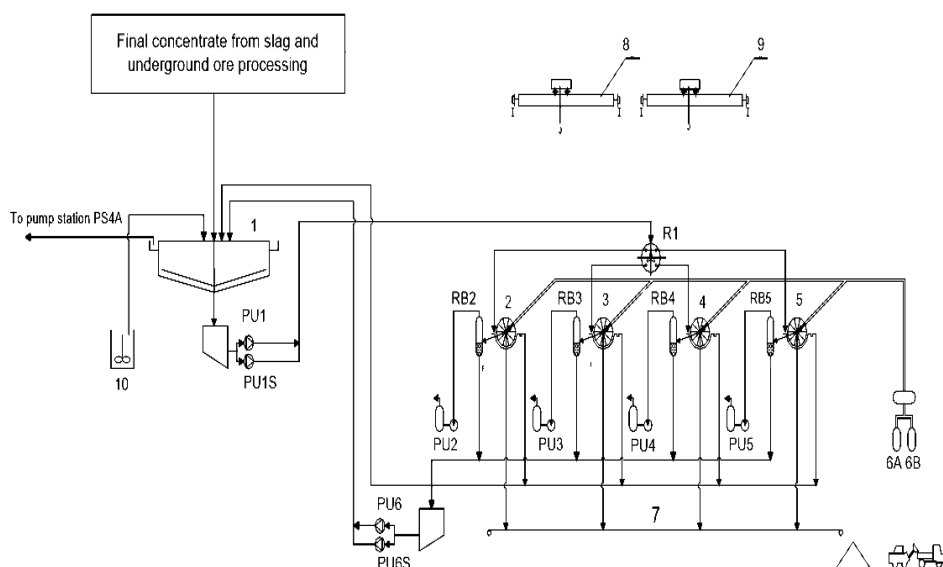
<sup>1</sup> Only plant for dewatering of copper concentrate will be supplied with electrical power from a exiting substation, which is powered directly from the station "Bor 3".

## DESCRIPTION OF THE TECHNOLOGICAL SCHEME OF THE FINAL COPPER CONCENTRATE DEWATERING IN THE RECONSTRUCTED PLANT FOR SMELTING SLAG PROCESSING

Technological scheme of dewatering process of final copper concentrate (consisting of copper concentrate from slag processing and copper concentrate from underground ore processing) is shown in Figure 1.

The final copper concentrate will be transported by existing pipeline system to the thickener (pos. 1). The thickened product, which contains about 58% solids, is transported by a centrifugal slurry pumps (pos. PU1 and PU1S, one in work and one in reserve) to the pulp divider (pos. R1). From the pulp divider (position R1) the thickened product is introduced into the filters (pos. 2, 3, 4 and 5) in order to perform the second phase of dewatering of copper concentrate. Thickener overflow is gravitationally transported by pipeline system to the pumping station PS 4A.

In the filtration plant 4 disk vacuum filters (pos. 2, 3, 4 and 5) are installed. Each filter has 5 discs and each disc has 10 segments on which the process of copper concentrate filtering is carried out (currently in operation are 3 disc vacuum filters (pos. 2, 4 and 5), while the disc vacuum filter (pos. 3) together with a vacuum pump (pos. PU3) after reparation will be reused in the process). The filtration plant also includes four vacuum pumps (pos. PU2, PU3, PU4, PU5) providing a vacuum to operate the filter. For supplying the disk vacuum filters by compressed air two blowers will be used (position 6A and 6B, one in work and one standby).



**Figure 1.** Technological scheme of dewatering process of final copper concentrate

Excess pulp from the troughs of filters (position 2, 3, 4 and 5) gravitationally returns to the thickener (pos. 1) by existing pipeline. The filtrate is gravitationally emptied over receiver (pos. RB2, RB3, RB4 and RB5) and then by the filtrate pumps (pos. PU6 and PU6S, one in work, one standby) returns to the thickener (pos. 1). In the process of thickening of copper concentrate, a certain amount of flocculant (Superfloc A-100, producer Kemira, Finland) is added to the thickener to provide easier precipitation of particles.

Filtered copper concentrate containing about 10% moisture gravitationally falls on the reversible belt conveyor (pos. 7) and disposed on open pile from where is then transported by truck to the Smelter plant.

Crane with load capacity of 5t is located in the plant where they are the disc filters, while the 3t load capacity crane is located in the plant where they are vacuum pump.

Flocculant Superfloc A-100 is delivered to a plant for copper concentrate dewatering in bags of 25 kg weight, while the preparation of flocculant is carried out in the tank with mixer (pos. 10). After preparation, the flocculant in the form of 0.4% solution is added to the thickener (pos. 1).

## CONCLUSION

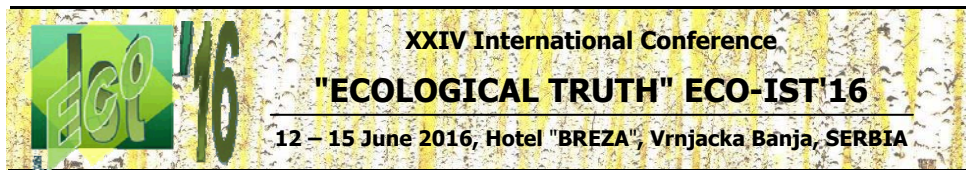
Revitalization of equipment in the part of dewatering of definitive copper concentrate in Bor flotation plant creates conditions for the realization of the projected processing capacity of the new smelter slag and also uninterrupted operation of this part of the plant. In addition to the continuous and stable production, it is also created the conditions for a safe work of employees.

## *Acknowledgment*

*This paper is the result of Project TR 34025 funded by the Ministry of Education, Science and Technological Development of the Republic of Serbia.*

## REFERENCES

1. Chavan, R.R, Kulkarni, D.B, 2013. Performance of Copper Slag on Strength properties as Partial Replace of Fine Aggregate in Concrete Mix Design. International Journal of Advanced Engineering Research and Studies /II/IV/ July-Sept. 95-98.
2. Mitrović, Z., Jovanović, R., 2007. Sto godina borskog rudarstva 1903-2003, sedamdeset pet godina basenskih flotacija 1929-2003, RTB Bor i Megatrend Univerzitet Beograd, 536 p. In Serbian.
3. Dopunski rudarski projekat rekonstrukcije postrojenja za preradu topioničke šljake u flotaciji Bor, IRM Bor, 2015. (In Serbian)



## POTENTIAL TOXIC EFFECTS OF COPPER IN METAL INDUSTRY

Vesna Lazarevic<sup>1\*</sup>, I. Krstic<sup>2</sup>, M. Stanisavljevic<sup>3</sup>

<sup>1</sup>Military hospital in Nis, SERBIA

<sup>2</sup>University of Nis, Faculty of Occupational Safety, Nis, SERBIA

<sup>3</sup>High Technical School of Professional Studies, Pozarevac, SERBIA

\**vesna.toxicology@gmail.com*

### ABSTRACT

Technological procedures in metal industry which are major sources of copper exposure are: casting, welding, smelting, rolling and electrolysis of copper, its alloys and compounds, which enables simultaneous exposure to other metals (lead, nickel, manganese etc.) have the task to study its potential toxic effects.

We used data from the annual reports of social medicine services and medical statistics, medical records of primary and specific health care of employees and expert findings of the Public Health Institute in Nis. The concentration of copper in biological samples was determined by spectrophotometric methods. Statistical analysis was performed using software packages Excel, Matlab and SPSS19.0.

The research has shown that chronic exposure to copper results in an increase of its concentration in biological material, but there is no negative impact on the health of the exposed population, as determined on the basis of the identified symptoms.

**Key words:** copper, chronic exposure, potential toxicity, metal industry.

### INTRODUCTION

The essential metals have three levels of biological activity: low concentrations (in traces), which are necessary for the growth and development, homeostatic level, which is located in depots and toxic levels [1].

In the process of electrolytic deposition, copper shows a significant trait that it adheres well to the surface of another metal, and on the other hand, it can be easily ironed to high gloss, so coatings of copper are used as an intermediate layer, or substrate for the application of other coatings.

Copper, as an essential trace element, is essential in the metabolism of enzymes [2], the synthesis of hemoglobin, bone formation, iron [3,4]. and maintenance of myelin in the neural tissue [5].

Toxic effects of copper can be expressed in endogenous intoxication in which the increased amount of copper in the body is the result of metabolic disorders (primary biliary cirrhosis, intrahepatic and extrahepatic cholestasis) [6], disorders at the level of

the gene (Wilson's and Menkens's disease, as a result of mutations in the genes and ATP7B ATP7A, respectively) [7], as well as neurodegenerative diseases (Alzheimer's disease) [8].

Poisoning by exogenous copper occurs in cases of occupational exposure, accidental, suicidal, and iatrogenic ingestion of copper.

Copper and its compounds act locally causing irritation of the mucous membranes of the upper respiratory tract and digestive tract.

Chronic inhalation causes lung fibrosis and acute renal failure. Also, occupational exposure to copper leads to cataracts.

Excessive amount of copper often causes connective tissue problems, interfering with the disulfide bonds in connective tissue causing arthritis and osteoporosis [9].

Industrial exposure to copper fumes, dusts or mists may result in metal fume fever with atrophic changes in nasal mucous membranes [10].

Studies of the health effects of subchronic or chronic exposure of inhaled copper compounds were not located in the available literature.

Copper is an essential metal that can be toxic in high doses of exposure.

Copper toxicity is uncommon and occurs only at very high exposure levels. The association between copper and cancer incidence rates is unclear. The heavy metals copper, cadmium, zinc, and lead (Cu, Cd, Zn, and Pb) are known to be associated with prostate cancer, but their functions are unclear [11].

Determination of the concentration of copper in biological samples (whole blood, plasma, serum, urine) serves as a biological monitoring in assessing the risk of being exposed to copper. In exposed workers concentrations were significantly higher, but there isn't a correlation between the concentration that indicates increased exposure and those that occur during intoxication.

The given research indicates the importance of the potential toxic effects of copper on the exposed population and suggests establishing statistical correlations of copper concentrations, age and length of service.

## **MATERIALS AND METHODS**

Biomonitoring is based on the determination of the concentration of copper in biological samples (serum and urine) in exposed and control groups of patients. The applied analytical method is the retrospective epidemiological cohort study type, covering the period from 2001 until 2010. The exposed cohort consisted of the male respondents employed in "NISSAL", average age 45.4 years, who had worked for at least one year in the metalworking processes during the observed period. The control cohort consisted of the respondents of reference technology systems, male, average age 44.1 years, who were employed in the administration during the observed period.

We used data from the annual reports of social medicine services and medical statistics, medical records of the professional primary and specific health care of employees and expert findings of the Public Health Institute in Nis. The analyses of biological material in exposed and control groups were analyzed in the Public Health Institute in Nis and the Military Medical Academy in Belgrade. The analysis of the

concentration of copper in serum of the exposed and control groups of patients was performed using the method of flame atomic absorption spectrophotometry. The analysis of the concentration of copper in urine was performed using the method of graphite furnace atomic absorption spectrophotometry.

The results of copper concentrations in biological samples were analyzed using standard statistical methods: descriptive statistics technique (mean and standard deviation, frequency, percentage) to determine the severity of basic research variables, correlation techniques to determine the direction and degree of correlation between the variables, the Student's t statistics for major independent samples and the chi-square test for differences in frequency.

Statistical analysis and the presentation of the results was performed by software packages Excel, Matlab, SPSS19.0 (Statistical Package for the Social Sciences).

## RESULTS

In the statistical analysis of biological material, we started from the analysis of the expression of copper in exposed and control groups, as shown in Table 1.

**Table 1** The level of copper in biological material in exposed and control groups

The measured parameter	Group	Min	Max	AS	SD	Mod	DNV
Copper (serum), $\mu\text{mol}/\text{dm}^3$	Exposed	9.12	32.77	17.75	3.63	20.90	12.56-23.55
	Control	2.09	3.29	2.53	0.27	2.34	
Copper (urine), $\mu\text{mol}/\text{dm}^3$	Exposed	0.23	4.17	2.12	0.79	2.54	3,92
	Control	0.13	4.82	0.74	0.86	0.36	

**Min** - minimum value; **Max** - maximum value; **AS** - mean; **SD** - standard deviation; **Mode** - the most frequent value; **DNV** - allowed normal value

The average concentration of copper in serum is  $17.75 \mu\text{mol}/\text{dm}^3$ , and is slightly lower than the most frequent value of  $20.90 \mu\text{mol}/\text{dm}^3$ , while the maximum value of  $32.77 \mu\text{mol}/\text{dm}^3$ , which was present in 27 patients, is above the concentration limit ( $12.56$  to  $23.55 \mu\text{mol}/\text{dm}^3$ ). The average concentration of copper in urine is  $2.12 \mu\text{mol}/\text{dm}^3$ , while the most frequent value is  $2.54 \mu\text{mol}/\text{dm}^3$ , which is a higher level of presence. The value of the maximum concentration of  $4.82 \mu\text{mol}/\text{dm}^3$ , present in 7 patients, was above the maximum allowed concentration ( $3.92 \mu\text{mol}/\text{dm}^3$ ), which indicates high statistical significance.

Pearson's correlation coefficient estimated the correlation between the age structure and length of service of the exposed and control groups, and copper concentrations in biological samples. Based on the results, it was determined that there is a statistically significant correlation between the concentration of copper in biological material and the age and length of service. These correlations are positive and indicate that the concentration of copper in biological material increases with the increasing age and length of service, as a result of many years of exposure. The value of the correlation

coefficient is above 0.60, which indicates the high correlation between age and copper concentrations in biological samples, with statistical significance at the 0.01 level.

The correlation between the age structure and the length of service in the exposed group and copper concentrations in biological samples is shown in Table 2.

**Table 2.** The correlation between the age and length of service of the exposed group and copper concentrations

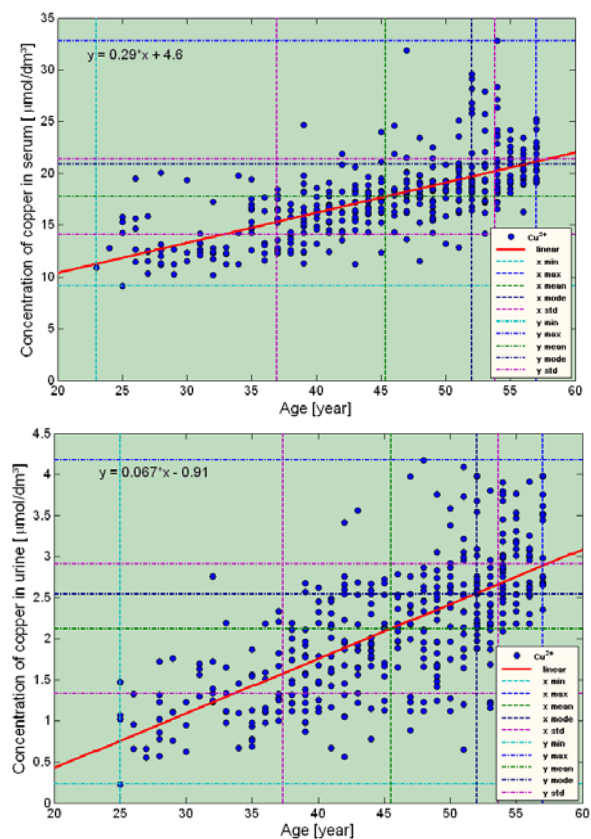
Copper (serum), $\mu\text{mol}/\text{dm}^3$	Age	r	0.673**
		p	<b>0.000</b>
		N	419
	Length of service	r	0.771**
		p	<b>0.000</b>
		N	380
Copper (urine), $\mu\text{mol}/\text{dm}^3$	Age	r	0.687**
		p	<b>0.000</b>
		N	416
	Length of service	r	0.903**
		p	<b>0.000</b>
		N	368

r - correlation coefficient, p - statistical significance, N - sample size.

\*\* Statistical significance at the 0.01 level

The dependence of the concentration of copper in biological materials on the age in the factory Nissal was performed in MATLAB and is shown in Figure 1.

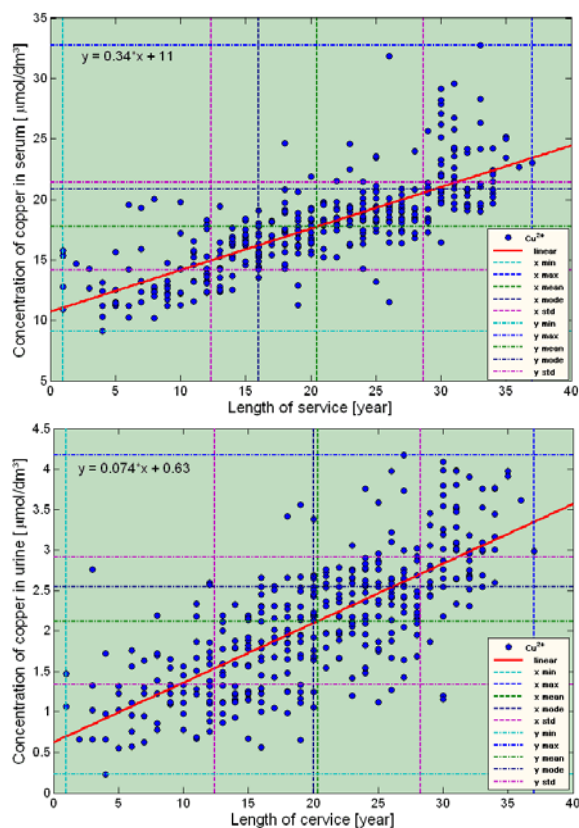




**Figure 1.** Dependence of the concentration of copper in serum and urine on age

Linear dependence of the concentration of copper in serum and urine on the age in the exposed group shown in Figure 1 are of the form:  $Y = 0,29 \cdot X + 4,6$  and  $Y = 0,067 \cdot X - 0,91$ , which means that with the increase in the age limit for one year, concentrations increase, on average by 0.29 and 0.067 mol/dm<sup>3</sup>, respectively.

The dependence of the concentration of copper in biological material on the years of exposed work was performed in MATLAB and is shown in Figure 2.



**Figure 2.** Dependence of the concentration of copper in serum and urine on length of service

Approximate linear dependence of the concentration of copper in serum and urine on the exposed length of service in exposed groups of patients is shown in Figure 2 in the linear form:  $Y = 0,34 \cdot X + 11$  and  $Y = 0,074 \cdot X + 0,63$ . It was found that with the increase in the exposed length of service for one year, concentrations increase on average 0,34 and 0,074  $\mu\text{mol}/\text{dm}^3$ , respectively.

## DISCUSSION

The average concentration of copper in serum is 17.75  $\mu\text{mol}/\text{dm}^3$ , and is slightly lower than the most frequent value of 20.90  $\mu\text{mol}/\text{dm}^3$ , while the maximum value of 32.77  $\mu\text{mol}/\text{dm}^3$ , which was present in 27 patients, is above the concentration limit (12.56 to 23.55  $\mu\text{mol}/\text{dm}^3$ ). The average concentration of copper in urine is 2.12  $\mu\text{mol}/\text{dm}^3$ , while the most frequent value was 2.54  $\mu\text{mol}/\text{dm}^3$ , which is a higher level of

presence. The value of the maximum concentration of  $4.82 \mu\text{mol}/\text{dm}^3$ , present in 7 patients, was above the maximum allowed concentration ( $3.92 \mu\text{mol}/\text{dm}^3$ ), which indicates high statistical significance.

Based on the identified symptoms in this research, copper intoxication was not determined, which is in accordance with the available data of other authors. Also, based on the given and the existing data of many authors, the determined concentrations of copper in serum and urine, although increased, do not cause harmful effects on the health of occupationally-exposed people. Toxic effects of copper exposure appear rarely and are difficult to identify because they do not only depend on the quantity but also on the interaction with other microelements such as zinc, iron and calcium, and toxic metals present in metal processes. Lethal dose of copper is up to 3.5 g, and also imbalance in the ratio of copper and zinc can be a significant factor in copper toxicosis [12].

The level of copper in serum and urine of exposed groups during the study period was positively correlated with the age ( $r=0.673$ ,  $p<0,01$  and  $r=0.771$ ,  $p<0,01$  respectively). The correlation is high and positive, which indicates the significance of the connection.

The high correlation between the concentration of copper in serum and urine and the exposed length of service in exposed subjects during the time of study was also determined, ( $r=0.687$ ,  $p<0,01$  and  $r=0.903$ ,  $p<0,01$ , respectively).

## CONCLUSION

A retrospective cohort epidemiological study showed that the systematic effects of copper exposure result in an increase of its concentration in biological material, but copper intoxication has not been established within this research. The level of copper in serum and urine of the exposed group during the study period was positively correlated with the age, and the exposed length of service. These data confirm the connection between the occupational exposure to copper as well as the age and length of exposed service.

## REFERENCES

1. Goyer RA, Clarkson TM (2001). Toxic effects of metals. In: Klaassen CD, editor. Casarett and Doull's toxicology. New York: McGraw-Hill; p. 811-68.
2. Rossi L, Lombardo MF, Ciriolo MV, Rotillio G (2004). Mitochondrial dysfunction in neurodegenerative diseases associated with copper imbalance. *Neurochem Res* 29(3):493-504.
3. Arredondo M, Nunez MT (2005). Iron and copper metabolism. *Molecular Aspects of Medicine* 26:(4-5)313-327.
4. Collins JF, Prohaska JR, Knutson MD (2010). Metabolic crossroads of iron and copper. *Nutr Rev* 68(3):133-47.
5. Skjorringe T, Moller LB, Moos T (2012). Impairment of interrelated iron and copper homeostatic mechanisms in brain contributes to the pathogenesis of neurodegenerative disorders. *Front Pharmacol* 3:169.
6. Fuentealba C, Aburto EM (2003). Animal models of copper-associated liver disease. *Comparative Hepatology* 2:5.

7. Cox DW, Moore SD (2002). Copper transporting P-type ATPases and human disease. *J Bioenerg Biomembr* 34(5):333-8.
8. Rossi L, Arciello M, Capo C, Rotilio G (2006). Copper imbalance and oxidative stress in neurodegeneration. *Ital J Biochem* 55(3-4):212-21.
9. Ashish B, Neeti K and Himanshu K (2013). Copper Toxicity: A Comprehensive Study. *Res.J.Recent.Sci. Vol. 2 (ISC-2012)*, 58-67.
10. Osredkar J and Sustar N (2011). Copper and Zinc, Biological Role and Significance of Copper/Zinc Imbalance. *J Clinic Toxicol. S:3*
11. Yari H, Mohseni M, Vardi R, Alizadeh AM and Mazloomzadeh S (2015). Copper, Lead, Zinc and Cadmium levels in serum of prostate cancer patients by polarography in Iran. *Journal of Chemical and Pharmaceutical Research*, 7(2):403-408.
12. Tasić N, Radak Đ, Cvetković Z, Petković B, Ilijevski N i Đorđević-Denić G (2004). Uloga i značaj oligoelemenata u patogenezi ateroskleroze. *Vojnosanitetski pregled* 61:667-73.



## POSSIBILITIES FOR REUSING FLOTATION TAILINGS FROM SMELTER SLAG FLOTATION

Zoran Stirbanovic<sup>1\*</sup>, J. Sokolovic<sup>1</sup>, Z. Markovic<sup>1</sup>, R. Stanojlovic<sup>1</sup>, R. Pantovic<sup>1</sup>,  
V. Gardic<sup>2</sup>, D. Milanovic<sup>2</sup>, G. Strajinovic<sup>3</sup>

<sup>1</sup>University of Belgrade, Technical faculty in Bor, Vojske Jugoslavije 12,  
19210 Bor, SERBIA

<sup>2</sup>Mining and Metallurgy Institute Bor, Zeleni bulevar 35, 19210 Bor, SERBIA

<sup>3</sup>Mining and Smelting Combine Bor, Copper Mines Bor, Kestenova 8,  
19210 Bor, SERBIA

\**zstirbanovic@ff.bor.ac.rs*

### ABSTRACT

Smelter slag contains large amounts of metals that have economic value but also can cause environmental pollution, so it is often being processed in terms of extracting valuable metals. One of the most commonly used methods for slag processing is flotation. As a by-product of flotation process, large quantities of flotation tailings are being generated. Flotation tailings from smelter slag flotation is usually being deposited in flotation tailings dumps, which represent serious environmental hazard concerning the fact that there are still some heavy metals in tailings but also flotation collectors. Also numerous ecological accidents occurred in the past when dams of flotation tailings dumps broke down and tons of tailings polluted waterways and surrounding land.

In order to prevent these accidents to happen in the future but also to extract all valuable components from flotation tailings, some possibilities for reprocessing this "waste" material are presented in this paper.

**Key words:** smelter slag, flotation tailings, environment, metals, extraction.

### INTRODUCTION

Smelter slag is a by-product of pyrometallurgical processing of concentrates. As such it contains large amounts of metals, as well as other valuable components, so it can represent a raw material for production of some metals and components [1] but also can be a potential hazardous material [2].

In order to recover metals, smelter slag can be processed by various technologies such as: leaching [3-5], roasting [6] and the most commonly used flotation [7-10]. In the flotation process, minerals are being separated depending on their hydrophobicity, i.e. hydrophobic minerals are separated from hydrophilic. Because the mass recovery in flotation process is 10 – 15%, large amounts of flotation tailings are being generated as a by-product of flotation process. Therefore flotation tailings is being deposited in for that purpose specially determined place, flotation tailings dump.

Flotation tailings dumps represent a potential threat to the environment, because flotation tailings contains flotation reagents and heavy metals that may pollute water due to the effects of atmospheric precipitation, and also because of the fact that this material is comminuted it can pollute air and the surrounding land by wind [11-14]. Also there are risks of dam rupture and spilling polluting materials into the waterways [16-19]. Because flotation process is not 100% efficient flotation tailings still contains some metals, as well as other useful components that can be additionally recovered. This way, amounts of flotation tailings that are being deposited on flotation tailings dumps are being reduced and additional financial benefit is being created.

### **FLOTATION TAILINGS AS A POTENTIAL HAZARD**

Flotation tailings is a product of flotation process with significantly reduced content of useful minerals in relation to their content in the feed. Despite this, the flotation tailings still contains significant amounts of metals and other components that can represent hazard to the environment. Also tailings contain flotation reagents that can be toxic and can induce health problems and pollution of environment [15].

Also, in the past years numerous environmental accidents occurred due to flotation tailings dump dam breaking. One of the biggest ecological disasters in Serbia happened when water collector under the old flotation tailings dump in Bor broke and large amounts of flotation tailings were spilled in Bor River and then into the Veliki Timok River and the Danube [16] causing their pollution. As a result, Bor River is still polluted to the extent that there are no living organisms in its water and the land in its basin can no longer be used for agricultural production. Also, the ecological disaster of global proportions was breaking of flotation tailings dump dam at gold mine in Baia Mare in Romania when 120 tonnes of material contaminated with cyanide and heavy metals arrived in the Tisza River and Danube [17]. In April 1998 Aznalcollar dam, in southern Spain, slid forward and released a flow of acid-saturated tailings into the Agrio and Guadiamar valleys [18,19].

### **POSSIBILITIES FOR RECOVERING METALS FROM FLOTATION TAILINGS**

After the flotation of smelter slag, flotation tailings contains significant amounts of metals such as: Cu, Zn, Fe, Ni, Co, etc. that could be additionally recovered [20-26]. These metals can cause serious environmental pollution if they get into waterways due to atmospheric precipitation so it is important to find a way for their extraction from tailings. Thus, it is very important to find a best method for extracting heavy metals from tailings and minimise their possible hazardous influence on environment.

In order to determine method for reprocessing flotation tailings and for additional recovery of metals it is necessary to preform detailed characterization. Depending on chemical and mineralogical compositions of flotation tailings, one of the possible methods for its processing could be flotation [20-23]. Considering the fact that

tailings is already fine grained its additional treatment by flotation could be economically justified, despite lower contents of valuable metals.

Also, one of the methods that could be applied for recovery of metals from flotation tailings is [24-26].

Roasting can be considered as a possible method for reprocessing flotation tailings and extracting valuable metals from it [27].

### **POSSIBILITIES FOR USING FLOTATION TAILINGS IN CEMENT, CONSTRUCTION AND BUILDING INDUSTRY**

When content of metals in flotation tailings is not high enough application of above mentioned methods for metal extraction from tailings may not be technologically possible or economically profitable. In that case, some alternative solution for using flotation tailings should be considered.

Many researches have been investigating application of smelter slag in cement and concrete industry [28-31].

On the other hand, only few researches have been investigating possibility for application flotation tailings as additive to cements and concretes [32-34].

One of the possibilities for using flotation tailings is as cement paste backfill in underground mines [35-37].

Using flotation tailings in these purposes can significantly reduce amounts of tailings that are being deposited in flotation tailings dumps, thus contributing environmental protection along with certain economic benefits.

### **CONCLUSION**

Pyrometallurgical processing of concentrates is generating large quantities of smelter slag. Considering that smelter slag contains large amounts of metals and other valuable components, it can represent a raw material for some metals and components but also can be a potential hazardous material.

In terms of extracting valuable components from slag, flotation of slag can be applied. As a by-product of flotation process, flotation tailings is being generated and deposited in flotation tailing dumps. Since, flotation tailings still contains some amounts of heavy metals, as well as flotation collectors it can represent potential environmental hazard. Also, ecological accidents occurred in the past when dams of some flotation tailings dumps broke and polluting material ended up in surrounding rivers and their coasts.

Flotation, as well as leaching and roasting can be applied as methods for reprocessing and re-extracting metals from flotation tailings.

Also flotation tailings can be used as additive in cements and concretes, and as cement paste backfill in underground mines.

In this way, quantities of tailings can be reduced and economic profit can be achieved, with significant contribution to environmental protection.

### **Acknowledgements**

*This paper presents results from the project TR 33023 supported by fund of the Ministry of Education, Science and Technical Development of the Republic of Serbia. The authors gratefully acknowledge the mentioned Ministry.*

### **REFERENCES**

1. Shen H., Forssberg E., 2003. An overview of recovery of metals from slags, *Waste Manage.* 23, 933–949.
2. Michael Manz L. Javier Castro, The environmental hazard caused by smelter slags from the sta. Maria de la paz mining district in mexico, *Environmental Pollution*, Vol. 98, No. 1, pp. 7-13, 1997
3. Banza A.N., Gock E., Kongolo K., 2002. Base metals recovery from copper smelter slag by oxidizing leaching and solvent extraction, *Hydrometallurgy* 67, 63–69.
4. Herreros O., Quiroz R., Manzano E., Bou C., Vinals J., 1998. Copper extraction from reverberatory and flash furnace slags by chlorine leaching, *Hydrometallurgy* 49, 87–101.
5. Li Y., Perederiyi I., Papangelakis V., 2008. Cleaning of waste smelter slag and recovery of valuable metals by pressure oxidative leaching. *J. Hazard. Mater.* 152, 607–615.
6. mAltundogan H.S., Tumen F., 1997. Metal recovery from copper converter slag by roasting with ferric sulphate, *Hydrometallurgy* 44, 261–267.
7. Sarrafi A., Rahmati B., Hassani H.R., Shirazi H.H.A., 2004. Recovery of copper from reverberatory furnace slag by flotation, *Miner. Eng.* 17, 457–459.
8. Bruckard W.J., Somerville M., Hao, F., 2004, The recovery of copper, by flotation, from calcium-ferrite-based slags made in continuous pilot plant smelting trials, *Miner. Eng.* 17, 495–504.
9. Stirbanovic Z.M., Markovic Z.S., 2011. The effect of copper bearing particles liberation on copper recovery from smelter slag by flotation, *Sep. Sci. Technol.* 46 (16), 2496-2500.
10. Karimi N., Vaghar R., Tavakoli Mohammadi M.R., Hashemi S.A., 2013. Recovery of copper from the slag of Khatoonabad flash smelting furnace by flotation method, *J. Inst. Eng. India Ser. D*, 94 (1), 43-50.
11. B. Golomeov, M. Golomeova, B. Krstev, A. Krstev, Some hazardous appearances in flotation tailings dumps in domestic mines, *Perspect. Innov. Econom. Busin.* 7(1) (2011) 80-83
12. M. Benvenuti, I. Mascaro, F. Corsini, P. Lattanzi, P. Parrini, G. Tanelli, Mine waste dumps and heavy metal pollution in abandoned mining district of Boccheggiano (Southern Tuscany, Italy), *Environ. Geol.* 30 (3/4) (1997) 238-243
13. K. Komnitsas, A. Kontopoulos, I. Lazar, M. Cambridge, Risk assessment and proposed remedial actions in coastal tailings disposal sites in Romania, *Miner. Eng.* 11(12) (1998) 1179–1190



14. D. Panias, Consequences of environmental issues on sustainability of metal industries in Europe: The case study of Bor, *J. Metall.* 12(4) (2006) 239-250
15. C. Williams, Y. Peng, R. Dunne, Eucalyptus oils as green collectors in gold flotation, *Minerals Engineering*, Volume 42, 2013, Pages 62–67
16. T. Marjanovic, M. Trumic, Lj. Markovic, Local Environmental Action Plan Municipality Bor, Citizens Forum, Bor, 2003.
17. F. Wehland, C. Panaiotu, E. Appel, V. Hoffmann, D. Jordanova, N. Jordanova, I. Denut, The dam breakage of Baia Mare—a pilot study of magnetic screening, *Phys. Chem. Earth* 27 (2002) 1371–1376
18. N. Eriksson, P. Adamek, The tailings pond failure at the Aznalcóllar mine, Spain, In: R. Singhal, A. Mehrotra (Eds.) *Environmental Issues and Management of Waste in Energy and Mineral Production*, Balkema, Rotterdam, 2000, pp. 109-116
19. E. Alonso, A. Gens, Aznalcollar dam failure. Part 1: Field observations and material properties, *Geotechnique* 56(3) (2006) 165–183
20. Fu Jiangang, Chen Kaida, Wang Hui, Guo Chao, Liang Wei, Recovering molybdenite from ultrafine waste tailings by oil agglomerate flotation, *Minerals Engineering* Volume 39, December 2012, Pages 133–139
21. Xiuli Yang, Xiong Huang, Tingsheng Qiu, Recovery of zinc from cyanide tailings by flotation, *Minerals Engineering* 84 (2015) 100–105
22. Michel Shengo Lutandulaa, Banza Maloba, Recovery of cobalt and copper through reprocessing of tailings from flotation of oxidised ores, *Journal of Environmental Chemical Engineering* 1 (2013) 1085–1090
23. Shaoxian Song, Xinwang Zhang, Bingqiao Yang, Antonio Lopez-Mendoza, Flotation of molybdenite fines as hydrophobic agglomerates
24. F. Carranza, N. Iglesias, A. Mazuelos, R. Romero, O. Forcat, Ferric leaching of copper slag flotation tailings, *Minerals Engineering* 22 (2009) 107–110
25. Maxim I. Muravyov, Natalya V. Fomchenko, Alexey V. Usoltsev, Evgeniy A. Vasilyev, Tamara F. Kondrat'eva, Leaching of copper and zinc from copper converter slag flotation tailings using  $H_2SO_4$  and biologically generated  $Fe_2(SO_4)_3$ ,
26. Daniela Urosevic, Mile Dimitrijevic, Zoran Jankovic, Dejan Antic, Recovery of copper from copper slag and copper slag flotation tailings by oxidative leaching, *Physicochem. Probl. Miner. Process.* 51(1), 2015, 73–82
27. Liu Bailong, Zhang Zhaohui, Li Linbo, Wang Yujie, Recovery of Gold and Iron from the Cyanide Tailings by Magnetic Roasting, *Rare Metal Materials and Engineering*, Volume 42, Issue 9, 2013, pp. 1805–180
28. Caijun Shi, Christian Meyer, Ali Behnood, Utilization of copper slag in cement and concrete, *Resources, Conservation and Recycling* 52 (2008) 1115–1120
29. K.S. Al-Jabri, R.A. Taha, A. Al-Hashmi, A.S. Al-Harthy, Effect of copper slag and cement by-pass dust addition on mechanical properties of concrete, *Construction and Building Materials* 20 (2006) 322–331
30. M. Najimi, J. Sobhani, A.R. Pourkhorshidi, Durability of copper slag contained concrete exposed to sulfate attack, *Construction and Building Materials* 25 (2011) 1895–1905

31. Khalifa S. Al-Jabri, Makoto Hisada, Salem K. Al-Oraimi, Abdullah H. Al-Saidy, Copper slag as sand replacement for high performance concrete, *Cement & Concrete Composites* 31 (2009) 483–488
32. Zheng Guo, Qiming Feng, Weiqing Wang, Yang Huang, Jie Deng, Zhonghui Xu, Study on flotation tailings of Kaolinite-type pyrite when used as cement admixture and concrete admixture, *Procedia Environmental Sciences* 31 ( 2016 ) 644 – 652
33. Obinna Onuaguluchi, Özgür Eren, Recycling of copper tailings as an additive in cement mortars, *Construction and Building Materials* 37 (2012) 723–727
34. B.K.C. Chan, S. Bouzalakos, A.W.L. Dudeney, Cemented products containing waste from mineral processing and bioleaching, *Minerals Engineering* 22 (2009) 1326–1333
35. M. Fall, M. Benzaazoua, S. Ouellet, Experimental characterization of the influence of tailings fineness and density on the quality of cemented paste backfill, *Minerals Engineering* 18 (2005) 41–44
36. Mostafa Benzaazoua, Bruno Bussiere, Isabelle Demers, Michel Aubertin, Eliane Fried, Annie Blier, Experimental characterization of the influence of tailings fineness and density on the quality of cemented paste backfill, *Minerals Engineering* 21 (2008) 330–340
37. Blessen Skariah Thomas, Alok Damare, R.C. Gupta, Strength and durability characteristics of copper tailing concrete, *Construction and Building Materials* 48 (2013) 894–900



## RECYCLING OF PLATINUM FROM CRUCIBLES FOR MELTING AND CASTING

Silvana B. Dimitrijevic<sup>1\*</sup>, A. T. Ivanovic<sup>1</sup>, S. R. Magdalinovic<sup>1</sup>,  
S. Z. Ivanovic<sup>1</sup>, S. Krstic<sup>1</sup>, B. T. Trumic<sup>1</sup>, S. S. Dragulovic<sup>1</sup>, K. R. Pantovic<sup>2</sup>

<sup>1</sup>Mining and Metallurgy Institute Bor, Zeleni bulevar 35, 19210, Bor, SERBIA

<sup>2</sup>University of Belgrade, Faculty of Chemistry, Studentski trg 16,  
11 000 Belgrade, SERBIA

\**silvana.dimitrijevic@irmbor.co.rs*

### ABSTRACT

The aim of this study was the recycling of platinum from crucibles for melting and casting. This paper has considered the possibility of direct melting of crucibles as well as the possibility of processing the crucibles by PMS methods (shaking table and flotation concentration). Laboratory studies have shown that leaching of ground crucibles in sulfuric acid has achieved the leaching degree of magnesium oxide of 99.98% thus providing a material suitable for melting.

**Key words:** platinum, recycling, flotation, leaching.

### INTRODUCTION

Platinum group metals (PGMs) play a key role in the modern society, as they specific importance for clean technologies and other high-tech equipment. Important applications beyond the well-known areas of chemical process catalysis and automotive emissions control include information technology [1-2]. Precious metals, especially platinum, are important catalytic materials for many chemical reactions. For example, platinum is used in some fuel cells; however, a broad commercialization of such fuel-cell technology is hampered by the fact that platinum is rare and thus far too expensive [3].

Development of modern industry is inconceivable without the use of products of platinum and platinum-based alloys. The use of platinum dating from the ancient times, and platinum in Europe was brought by Vood in 1735, and Brownrig Vatsoh were the first who described its characteristics. Platina del Pinto from Čoka (Colombia) attracted the attention of Antonio de Utloae in 1748, and Slalieer from Leiden even more in 1558 mentioned some non-melting metal, which was considered to be platinum [1]. Due to its color, unique physical-chemical properties, the demand for platinum is growing in the chemical industry, automotive industry, medicine, jewelry production, etc. [2, 4]. Also, platinum is irreplaceable material in making corrosion-resistant and fire-resistant chemical apparatus and vessels of various purposes.

Such a wide range of application the platinum and platinum based alloy leads to increased demand in the world for this metal. One way to ensure the adequate amounts of platinum is to increase the exploitation of ore deposits [5]. This however, does not lead to the sustainable development, and the efforts are directed towards increasing the degree of recycling the secondary raw materials (waste electrical and electronic parts, jewelry, consumable dental and orthopedic materials, used catalysts, etc. [6-9].)

Recycling platinum is a difficult, complicated process. The first step is the dissolution of the used platinum in highly corrosive aqua regia, a mixture of nitric and hydrochloric acids, or a highly oxidizing mixture of sulfuric acid and hydrogen peroxide, known as piranha [3].

In the Mining and Metallurgy Institute Bor, the Profit Center Processing of platinum metals as the secondary raw materials, the ceramic melting crucibles of melting (MgO) and casting nozzles (Al<sub>2</sub>O<sub>3</sub>) appear from own production. These crucibles contain in their composition Pt, MgO and Al<sub>2</sub>O<sub>3</sub>. The aim of research was to develop the technology for processing the crucibles that are used for melting and casting of platinum in order to obtain the platinum purity of 99.99.

## **EXPERIMENTAL PART**

### **Chemicals**

Amylopectin (starch), collectors of potassium amyl-xanthate (Župa Kruševac), Aero 3302 promoter (Cytec) and frothers Dowfroth 250 (Dow) and Aerofroth 65 (Cytec) were used in laboratory research. Sulfuric and nitric acid p.a. quality (Zorka Šabac) were used for leaching of crucibles.

### **Methods and Apparatus**

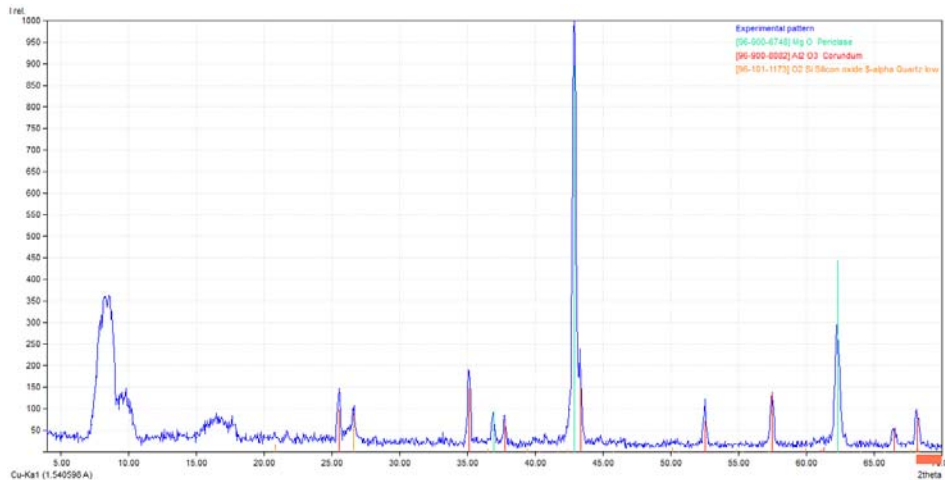
To determine the chemical composition of electrolyte and control the concentration of Pt, Mg, Al and impurities was used (ICP-AAS Manufacturer: Spectro, Model: Ciris Visio, detection limit < 0.0001 g/dm<sup>3</sup>).

To record the X-ray diffractogram was used the model: EXPLORER, manufacturer: GNR Analytical Instruments Group, Novara, Italy.

### **Physico-chemical characterization of material**

In order to determine the optimal way of processing in experimental work, a detailed physico-chemical characterization of crucibles was carried out.

The chemical analysis results obtained by the instrumental analytical chemistry are shown in Table 1, and the X-ray diffractogram is shown in Figure 1.



**Figure 1.** X-ray diffractogram of ground crucibles

X-ray diffractogram (Figure 1) shows two intensive peaks corresponding to periclase (MgO) and corundum ( $\text{Al}_2\text{O}_3$ ). Besides these two minerals, the presence of quartz can be seen on diffractogram. Since that this method can not detect the low levels of impurities, the samples were analyzed by AAS method ( $\text{Al}_2\text{O}_3$ , MgO, Ca i Fe), G ( $\text{SiO}_2$ ) and ICP AAS (Pt).

**Table 1.** Chemical composition of milled crucibles

	$\text{SiO}_2$ G	$\text{Al}_2\text{O}_3$ AAS	MgO AAS	Ca AAS	Fe AAS	Pt ICP-AES
%	8.28	36.55	45.36	1.52	0.99	0.28

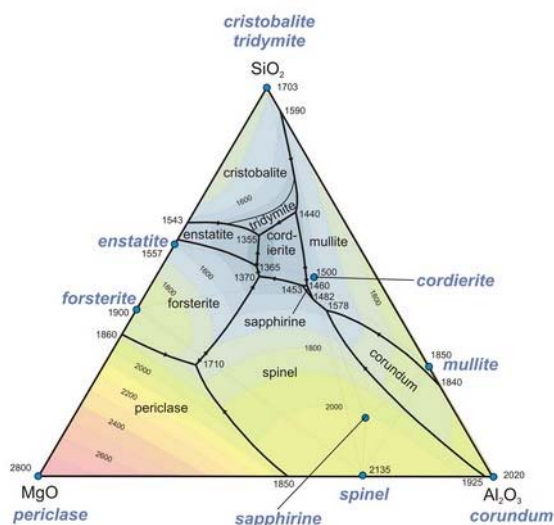
It can be seen from Table 1 that the main component in a sample are MgO and  $\text{Al}_2\text{O}_3$ .

## RESULTS AND DISCUSSION

### Theoretical Considerations of Direct Melting of Crucibles

Milled crucibles and casting nozzles, (chemical composition shown in Table 1), are very difficult to process using the pyrometallurgical processes. The melting temperature of this mixture (45.36 %MgO, 36.55 %  $\text{Al}_2\text{O}_3$  and 8.28 %  $\text{SiO}_2$ ) is about 2300°C (Figure 2).

The main reason for this is the impossibility of forming the mixtures with a low melting of slag, which would provide a flowable slag and good layering with the metal collector (which allow minimum losses of collector and precious metals with slag) and simultaneous heating of collector metal to the casting temperature without oxidation. Components of material for processing have extremely high melting temperature MgO-2800 °C,  $\text{Al}_2\text{O}_3$ -2020°C,  $\text{SiO}_2$ -1723 °C as well as the flux and addition in pellets at CaO-2570 °C [10]. The phase diagram of the system MgO- $\text{Al}_2\text{O}_3$ - $\text{SiO}_2$  is shown in Figure 2.



**Figure 2.** Phase diagram for the system MgO-Al<sub>2</sub>O<sub>3</sub>-SiO<sub>2</sub> [10]

Melting temperature of material slag is mainly over 1600 °C, with very narrow intervals where the temperature is slightly lower and that are highly sensitive to the slightest change in chemical composition. With change of some batch component from 1 to 1.5%, the melting temperature may rise for 250-300 °C, what leads to "freeing" the bath surface. On the other side, the brick of furnace (Birlac furnace) can withstand the bath temperature of max. 1550 °C. Also, the collector metal will at such high temperatures "burn out" (oxidized) and as such cannot be processed by electrolytic refining. In addition, to achieve high temperatures in the furnace, the electricity consumption is significantly higher.

Due to this reason, it is necessary, before to melting, to process the material by hydrometallurgical method in the aim to reduce MgO content below 5% and in this way to ensure the batch with eutecticum in the temperature range of 1330 to 1350 °C. In doing so, the care must be taken that variation in chemical composition of batch of a few percentages can lead to occurrence of peritectum points with high melting temperature above 1567 °C. So, in terms of pyrometallurgy, it is necessary that MgO content in mixture is below 5%.

#### **Possibility of Preparation the crucibles for Melting by the Mineral Processing Methods**

Sample of used crucibles for platinum melting was homogenized. From sample, the excluded smaller samples were tested on a shaking table and by the method of flotation concentration to obtain material that would be suitable for further metallurgical treatment. The aim of this testing was to concentrate platinum or to reduce MgO below 5% from the product with platinum.

### Testing the Possibility of Concentration on a Shaking Table

Sample for concentration experiment on a shaking table, in the amount of 1 kg was crushed by impact crusher to the grain size - 1.40 mm. Four products according to the density of particles were separated in a thin layer of water current. Visually, there was no the satisfactory separation. It was expected for platinum to go in the heaviest product of a shaking table, the so-called concentrate. Since this is a sample that is not only polymineral but is composed of mineral grains of a wide range of sizes, the heaviest grains, i.e. coarse, large and small, went to the heaviest product. Due to this reason, the heavy product was sieved into three size classes and then each one was observed under a microscope.

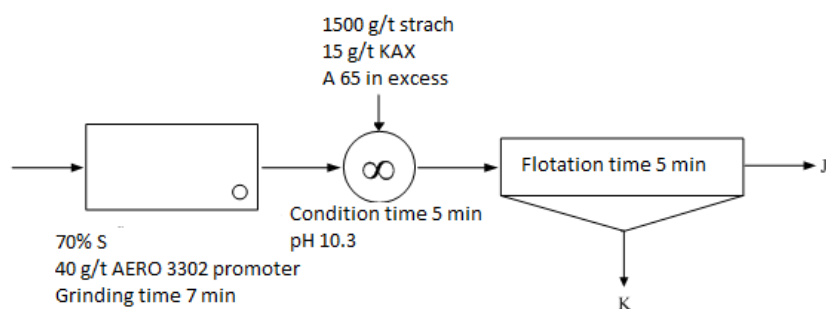
Based on a visual assessment concentration process and microscopic observations of the heaviest fraction, it was concluded that the shaking table cannot provide samples with less than 5% MgO.

### Testing the Possibility of Flotation Concentration

Samples of 500 g were excluded from the starting sample. One of these samples was ground by the wet process in a ball mill in the presence of collector. Figure 3 shows the scheme according to which the experiment of flotation concentration was carried out. Amylopectin (starch) was added in order to deprivation MgO, and due to very bad foam with frother Dowfroth 250, the frother Aerofroth 65 was added until the appearance of foam. From collectors, the Aero 33023 promoter was used that was added at the stage of grinding and the KAX that was added in the conditioning phase. Balances of platinum and MgO are shown in Table 2.

**Table 2.** Balance of platinum concentration from sample "crucibles"

Product	m, %	Pt, %	Distribution Pt, %	MgO, %	Distribution MgO, %
Total	100.00	0.2857	100.00	56.67	100.00
Concentrate	1.57	1.9	10.43	40.14	1.11
Tailings	98.43	0.26	89.57	56.93	98.89



**Figure 3.** Technological scheme of flotation concentration the sample "crucibles"

Experiment of flotation concentration did not give the results because there was no satisfactory concentration of platinum as well as lowering the MgO content. Grinding time was chosen on the basis of experience while the reagent regime was selected from literature data relating to the natural mineral raw materials and not on artificially obtained materials [11,12].

### Leaching

In order to reduce MgO content below 5%, the samples of crucibles were leached in sulfuric acid (the cheapest and most suitable for further melting) at different conditions. Leaching conditions were chosen on the basis of previous experiences and reviews of literature [2]. Leaching was carried out in two stages.

**I stage:** Testing of the effect of acid on leaching degree of magnesium oxide.

The samples were leached in sulfuric acid at 60 °C with the ratio of S:L = 1: 20 for a period of 6 h with stirring (400 min<sup>-1</sup>):

**I<sub>1</sub>:** leaching with 15% sulfuric acid

**I<sub>2</sub>:** leaching with 20% sulfuric acid

**I<sub>3</sub>:** leaching with 30% sulfuric acid

The first stage of research showed that the highest leaching was achieved by 20% sulfuric acid.

**II stage:** Two experiments were carried out in this stage of research:

**II<sub>1</sub>:** leaching with 20% sulfuric acid without stirring and additional heating,

**II<sub>2</sub>:** leaching with 20% sulfuric acid with stirring, heating and addition of nitric acid.

Table 3 shows the testing results for both stages.

**Table 3.** Leaching degree of magnesium (content of Mg was determined by AAS method)

	Leaching conditions	% leaching MgO
<b>I<sub>1</sub></b>	15% H <sub>2</sub> SO <sub>4</sub> ; t=60°C	98.35
<b>I<sub>2</sub></b>	20% H <sub>2</sub> SO <sub>4</sub> ; t=60°C	99.60
<b>I<sub>3</sub></b>	30% H <sub>2</sub> SO <sub>4</sub> ; t=60°C	97.20
<b>II<sub>1</sub></b>	20% H <sub>2</sub> SO <sub>4</sub> ; t=25°C	96.55
<b>II<sub>2</sub></b>	20% H <sub>2</sub> SO <sub>4</sub> ; t=25°C +10%HNO <sub>3</sub>	95.32

### CONCLUSION

After a detailed physico-chemical characterization of sample, as well as the theoretical considerations of direct melting the crucibles for melting and casting of platinum, it can be concluded that this mixture cannot be directly melt due to the high temperature of eutecticum. It is possible to melt this mixture only if MgO content is reduced to below 5%. Research the possibilities of processing the crucibles using the mineral processing methods (shaking table and method of flotation concentration) did not give the satisfactory results. Leaching in sulfuric acid has achieved MgO leaching



from 95.32 to 98.35%, which provided MgO content of less than 5% and therefore the conditions for this mixture melting.

### **Acknowledgments**

*This work is the result of the Projects Nos. TR 34024 and TR 34029, funded by the Ministry of Education, Science and Technological Development of the Republic of Serbia.*

### **REFERENCES**

1. B.Trumić, L. Gomidželović, D. Stanković, *Platinum<sub>na</sub> and Platinum<sub>a</sub> Based Alloys*, Mining and Metallurgy Institute Bor, 2015 (in Serbian);
2. Hagelūken, C. Recycling the Platinum Group Metals. A European Perspective *Platinum Metals Review* 2012, 56(1), 29–35;
3. J. F. Huang, H.Y. Chen, Heat-Assisted Electrodeposition of Platinum in an Ionic Liquid, *Angew. Chem. Int. Ed.* 2012;
4. A. Dubiella-Jackowska, Ź. Polkowska, J. Namieśnik, Platinum Group Elements: A Challenge for Environmental Analytics – Review. *Polish Journal of Environmental Studies*, 2007, 16 (3), 329–345;
5. M. D. Dimitrijević, S. M. Milić, S. Č. Alagić, A. A. Radojević, Revalorization of Platinum Group Metals (Pgm) from Worn Auto Catalysts. Part I: Primary and Secondary Sources of PGM and their Use, Recycling and Sustainable Development 7 (2014) 9-21(in Serbian);
6. V. Trujić, S. Dragulović, S. Dimitrijević, Z. Ljubomirović, D. Simonović, Electrochemical Deposition of Cu, Pt, Pd and Rh from Waste Sulphur Acidic Solution Obtained in Anode Slime Decoperisation, *Metalurgia International*, No.2, (2012), pp. 11-15;
7. S. B. Dimitrijević, V. K. Trujić, B. T. Trumić, M. B. Mirić, V. T. Conić, A. T. Ivanović, S. P. Dimitrijević, Recovery of Metals from Electronic Waste by Pyrometallurgical Processing – A Review Part I, 44<sup>th</sup> International October Conference on Mining and Metallurgy, Bor, Serbia 1 – 3 October 2012, pp. 269-272;
8. S. S. Dragulović, V. K. Trujić, Z. Stanojević-Šimšić, V. B. Cvetkovski, Z. S. Ljubomirović, S. B. Dimitrijević, D. B. Simonović, Platinum Solvent Extraction from Rhodium-Acid Solution, 14<sup>th</sup> International Research/Expert Conference "Trends in the Development of Machinery and Associated Technology" TMT 2010, Proceedings, 11.-18/09/2010, Mediterian Cruise, pp. 169-171;
9. S. B. Dimitrijević, A. T. Ivanović, D. B. Simonović, Ź. J. Kamberović, M. S. Korać, Electrodeposition of Copper and Precious Metals from Waste Sulfuric Acid Solution, 15<sup>th</sup> International Research TMT 2011, Prague, Czech Republic, 12-18.09.2011, pp. 689-692;
10. [http://serc.carleton.edu/research\\_education/equilibria/ternary\\_diagrams.html](http://serc.carleton.edu/research_education/equilibria/ternary_diagrams.html)
11. Mining Chemicals Handbook, 2010 Edition, Cytec Industries Inc., West Paterson;
12. D. Salatić, Flotation Reagents, Belgrade, 1985 (in Serbian).



## PROCESS FOR CONCENTRATION OF COPPER FROM MINE TAILING BY FLOTATION

Ljiljana Avramovic<sup>1\*</sup>, R. Jonovic<sup>1</sup>, D. Urosevic<sup>1</sup>, A. Shibayama<sup>2</sup>,  
K. Haga<sup>2</sup>, H. Baisui<sup>2</sup>, Z. Stevanovic<sup>1</sup>, J. Petrovic<sup>1</sup>, R. Pantovic<sup>3</sup>

<sup>1</sup>Mining and Metallurgy Institute Bor, SERBIA

<sup>2</sup>Akita University, JAPAN

<sup>3</sup>University of Belgrade, Technical Faculty Bor, Bor, SERBIA

\**rafinacija@irm.bor*

### ABSTRACT

This work presents the results of flotation tailings sampled from the Old Flotation Tailing Dump of the Copper Mines in Bor. The aim of experimental tests is to find the optimal parameters of flotation for copper valorization from the flotation tailings. Copper content in a composite sample of flotation tailings was 0.35%. The following parameters of flotation tailings process were tested: the impacts of collector concentration, solid content in the pulp, regulators the pH value, flotation time, concentration of sulphurizing reagent and pH value of the pulp. The achieved copper recovery was 79.74% in the following flotation conditions of tailings: pH 4.7; frother MIBC=200 g/t; solid content in the pulp to 25%; flotation time 15 min; collector PAX-100 g/t and sulphurizing reagent NaHS-200 g/t.

**Key words:** flotation tailing, flotation process, copper.

### INTRODUCTION

In the Mining and Smelting Basin Bor, in the flotation process of copper ore, in the flotation concentration plants, Veliki Krivelj and Bor flotation, the flotation tailings is generated as a waste product. It is estimated that in Bor and the surrounding area there are about 1,000 million tons of mining waste, out of which over 200 million tones is the flotation tailings. From the moment of disposal and onwards, the flotation tailings under the influence of atmospheric conditions represents a permanent source of acidic water that carry the dissolved heavy metals and contaminate the surrounding soil, surface watercourses and groundwater. Disposed flotation tailings, apart from representing the ecological problem, also represent the mineral resource containing a significant amount of copper and precious metals for achievement the economic benefit by valorization. Taking into account that a larger part of oxide copper minerals, as well as a smaller part of non-flotationed sulphide minerals, are present in tailings, the experiments of the flotation process were carried out on a sample of tailings with sulphidization of oxide surfaces of copper minerals applying the sulphidizator NaHS. In Akita University in

Japan, testing the copper concentrations from tailings of the Old Flotation Tailing Dump in Bor [1,2] the achieved technological recovery on copper was 60%, with the quality of concentrate of 0.81% Cu. The process of flotation tailings on Mine Musselwhite Mine in Ontario, [3,4] confirmed that the flotation is effective for reducing the content of sulphides present in the tailings. The conducted tests [5] of the flotation process of oxide copper ore in the site Katanga were focused on copper and cobalt valorization from tailings. This work presents the experimental study the flotation concentration process of copper from the composite tailings sample from the Old Flotation Tailing Dump. The effect of the following parameters was tested: the pH value of the pulp, concentration of copper collector, concentration of sulphurizing agent, flotation time and pulp density on degree of copper extraction.

## EXPERIMENTAL

### Sample characterisation

A composite sample of flotation tailings from drill hole from depth of 36 m from the Field 1 of the Old Flotation Tailing Dump was used for all experimental investigations of flotation process.

Based on the results of grain size analysis, the determined particle size was 71% -75  $\mu\text{m}$ . Density of the composite tailings sample was 2.965  $\text{g/cm}^3$ .

Analysis of a sample of flotation tailings was done on the instrument XRF Rigaku Super Mini 200. The results of XRF analysis are shown in Table 1.

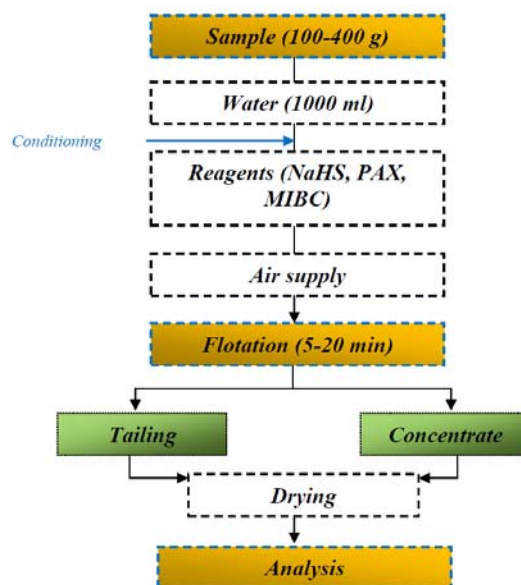
**Table 1.** XRF analysis of composite sample of flotation tailings

COMPONENT	CONTENT, mas %	COMPONENT	CONTENT, mas %
Na <sub>2</sub> O	0.863	CaO	1.58
MgO	0.542	TiO <sub>2</sub>	0.396
Al <sub>2</sub> O <sub>3</sub>	14.98	Mn	0.0246
SiO <sub>2</sub>	61.35	Fe <sub>2</sub> O <sub>3</sub>	9.93
P <sub>2</sub> O <sub>5</sub>	0.0793	<b>Cu</b>	<b>0.35</b>
S	6.66	As	0.188
K <sub>2</sub> O	0.723	Sr	0.0548
		Ba	0.185

The results of quantitative XRD analysis (instrument XRD Rigaku Mini Fleks 600) showed that the main minerals, included in the composition of tailings, are: quartz (84%), pyrite (13,2%), clinoptilolite (2,28%), albite (0,30%), copper oxide (0,07%) and chalcopyrite (0,02%).

### Experimental procedure of the flotation process of tailings

Experimental testing the re-flotation process of tailings in MMI Bor were carried out by the procedure shown in Figure 1.



**Figure 1.** Experimental procedure of the flotation process of tailings

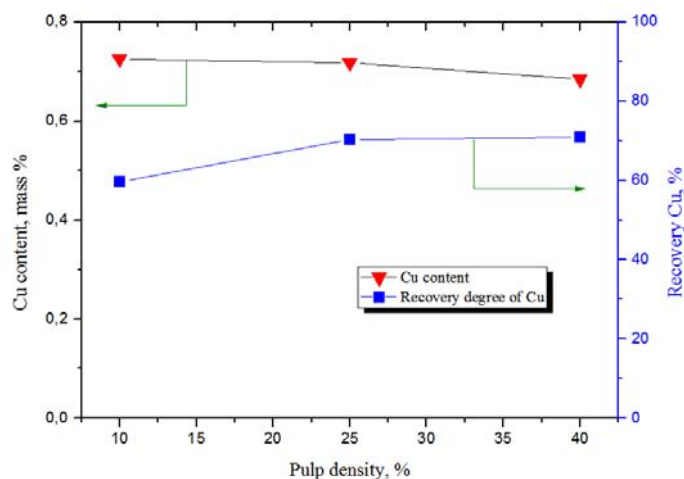
A flotation machine, type DENVER with the flotation cell volume of 1.2 L, was used for the experiments of tailings flotation. Flotation of tailings was carried out in the following conditions:

- pH value of flotation: 4,7-12
- Regulator of pH value:  $\text{Ca}(\text{OH})_2$  i NaOH
- Agent for sulphidization of oxide surfaces of copper mineral: Sodium hydrosulphide, NaHS (0-1000 g/t ore)
- Collector for sulphide copper minerals: Potassium amyl xanthate, PAX (0-100g/t ore)
- Conditioning time: 5 min
- Flotation time: 5-20 min
- Frother: methyl isobutyl carbinol, MIBC (200 g/t ore)
- Pulp density: 10-40 %.

## RESULTS AND DISCUSSION

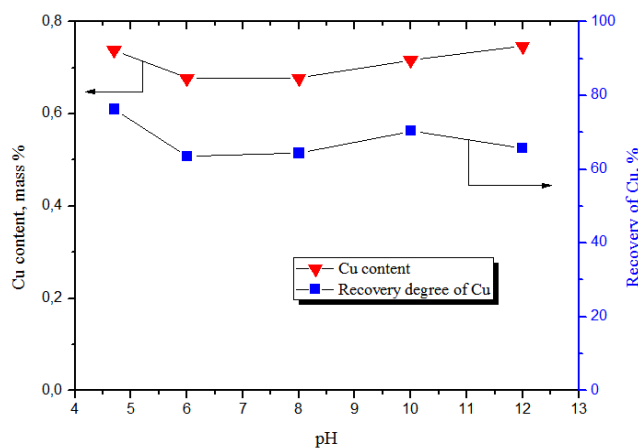
The influence of the pH regulator: sodium hydroxide and lime on copper recovery in concentrate is tested of the following conditions: pulp density - 25%, 100g/t PAX, 200g/t NaHS, 200g/t MIBC, time - 15 min, pH = 10 i 12. The highest degree of copper recovery from 70.31% achieved by the application of lime as pH regulator at pH 10, while using sodium hydroxide achieved degree of copper recovery from 67.74%. Figure 2 shows the percentage of copper recovery and copper content in concentrate, depending on the pulp density. Based on the copper analysis by the AAS method, it can

be concluded that the same degree of recovery is achieved on copper of 70% in the value of pulp density of 25 % and 40%. Taking into account that the copper content in concentrate is higher at the pulp density of 25%, this pulp density was taken as the optimal parameter for further testing.



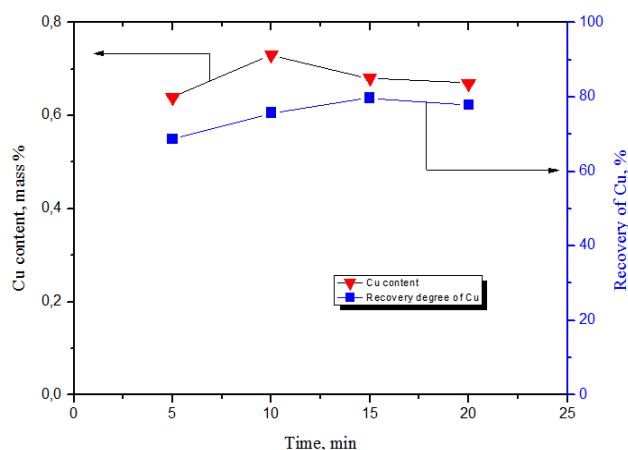
**Figure 2.** The impact of pulp density on copper recovery and copper content in concentrate (pulp density 10-40%, pH 10, 100g/t PAX, 200g/t NaHS, 200 g/t MIBC, time 15 min)

The effect of pH on the degree of copper recovery was tested. The highest degree of copper recovery of 76% was achieved at the pH value of the pulp of 4.7 without the addition of pH regulator (Figure 3) so that further laboratory tests were done without the addition of a pH regulator.



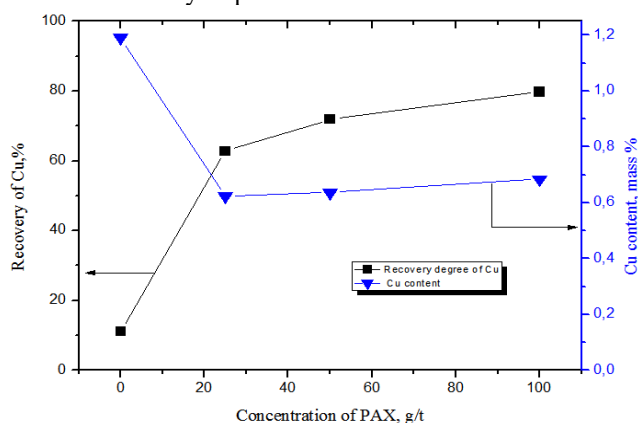
**Figure 3.** The impact of pH on copper recovery and copper content in concentrate (pH: 4,7-12, pulp density 25%, 100g/t PAX, 200g/t NaHS, 200 g/t MIBC, time 15 min)

Tested influence of flotation time of 5, 10, 15 and 20 min on the efficiency of the flotation process are given in Figure 4. The best technological recovery on copper of 79.74% was achieved with a flotation time of 15 min, while the lowest degree of efficiency was achieved in flotation time of 5 min, which indicates that it takes a long time for formed aggregate mineral grain – air bubble to float on the pulp surface.



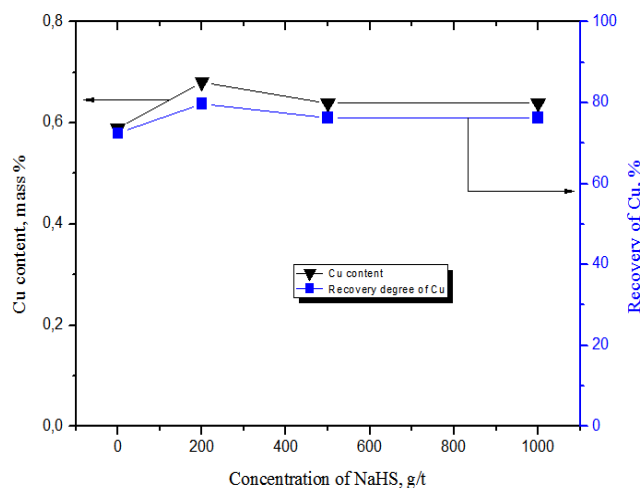
**Figure 4.** Influence of flotation time on the efficiency of the flotation process (time 5-20min, pH 4,7, pulp density 25%, 100g/t PAX, 200g/t NaHS, 200 g/t MIBC,)

In the experiments of testing the impact of PAX concentration on a recovery degree of copper in concentrate with 0, 50, 75 i 100 g/t PAX (Figure 5) it can be concluded that the highest achieved technological recovery is on copper and concentrate of 79.33% at concentration of 100 g/t, which consequently leads to the conclusion that the addition of PAX realizes a hydrophobization of mineral surfaces.



**Figure 5.** The impact of PAX concentration on copper recovery and copper content in concentrate (0-100g/t PAX, pulp density 25%, pH 4,7, 200g/t NaHS, 200g/t MIBC, time 15min)

The impact NaHS concentration on efficiency flotation process is tested (Figure 6). Slightly higher technological recovery on copper in concentrate was achieved by addition of NaHS in concentration of 200 g/t (79,74 %). The lowest recovery of 72.44% was realized without its addition, which suggests that the present oxide copper minerals in the flotation tailings require the addition of sulphidizator the surfaces of mineral grains.



**Figure 6.** The impact of NaHS concentration on copper recovery and copper content in concentrate (0-1000g/t NaHS, pulp density 25%, pH 4,7, 100g/t PAX, 200g/t MIBC, time 15min)

## CONCLUSION

Based on the experimental test parameters for the process of flotation tailings from the old flotation tailings with the copper content of 0.348%, achieved maximum copper recovery of 79.74% and the content of copper in concentrate of 0.684%. We used the following reagent regime: pH of 4.7; MIBC frother of 200 g / t; solid content in the pulp 25%; flotation time 15 min; PAX collector of 100 g / t and sulfurizing reagent NaHS of 200 g / t.

## Acknowledgement

*This paper is result of project TR 37001 funded by Ministry of Education and Science ("The Impact of Mine Waste from RTB Bor to the Pollution of Waterways with a Proposal of measures and Actions to Reduce the Harmful Effects on the Environment") and result of the Japan - Serbia Mutual JICA Project in the SATREPS Program ("The Project for the Research on the Integration System for Spatial Environment Analysis") funded from donation of the Japanese Government, with the participation of Serbian funding.*

## REFERENCES

1. B.Han, B.Altansukh, K.Haga, Z.Stevanović, J.Radojka, R.Marković, Lj.Avramović, Lj.Obradović, Y.Takasaki, N.Masuda, D.Ishiyama, A.Shibayama, Copper Upgrading and Recovery Process from Mine Tailing of Bor Region Serbia Using Flotation, *Int. J. Soc. Mater.Eng. Resour.* Vol. 20, No.2, October 2014, Pages 225-229
2. B.Han, B.Altansukh, K.Haga, Z.Stevanović, D.Urošević, R.Marković, Lj.Avramović, Y.Takasaki, N.Masuda, D.Ishiyama, A.Shibayama, Copper recovery from mine tailings of the Bor mine by the beaker and pressure oxidation leaching, 47<sup>th</sup> International October Conference of Mining and Metallurgy, October 2015, Bor Lake, Serbia, Proceedings, pp. 117-121, ISBN 978-86-7827-047-5
3. Raquibul Alam, Julie Q. Shang, Effect of operating parameters on desulphurization of mine tailings by froth flotation, *Journal of Environmental Management*, Volume 97, 30 April 2012, Pages 122-130
4. Li P.Wang, J. Ponou, S. Matsuo, K. Okaya, Gj. Dodbiba, T. Nazuka, T. Fujita, Integrating sulfidization with neutralization treatment for selective recovery of copper and zinc over iron from acid mine drainage, *Minerals engineering* volume 45, may 2013, pages 100–107
5. Michel Shengo Lutandula, Banza Maloba, Recovery of cobalt and copper through reprocessing of tailings from flotation of oxidised ores, *Journal of Environmental Chemical Engineering*, Volume 1, Issue 4, December 2013, Pages 1085–1090





## SORPTION AND PHOTODEGRADATION OF NEONICOTINOID INSECTICIDES IN SOIL

Helena Prosen\*, M. Starc, S. Ognjanovic

University of Ljubljana, Faculty of Chemistry and Chemical Technology,  
Vecna pot 113, Ljubljana, SLOVENIA

\*[helena.prosen@fkkt.uni-lj.si](mailto:helena.prosen@fkkt.uni-lj.si)

### ABSTRACT

An HPLC-DAD method was developed to determine four neonicotinoids in surface water and soil samples. UAE with acetone/0.5% HCOOH was developed for soil; extract was purified by SPE developed for surface water. Recoveries for surface water were 99.6-107.1% and for soil 63.6-93.4%. LOQs were in the low ppb range. Method was applied to study neonicotinoid sorption on soil, which was up to 50% in 5 days, indicating high leaching potential. Photodegradation under UV light was also monitored: it was very fast in water, but negligible on the soil surface. Under solar light, neonicotinoids on soil surface degraded with half-lives 68-104 days.

**Key words:** neonicotinoids, extraction, sorption, photodegradation, soil.

### INTRODUCTION

Neonicotinoids are a group of synthetic insecticides with a chemical structure derived from the natural alkaloid nicotine. Their systematic action against a range of harmful insects has since their introduction in 1991 earned them a market share of 25% global insecticide sales.<sup>1</sup> High application rates and possible toxicity have raised concerns regarding the risks for human health and effects on other living organisms. They are thought to have low acute toxicity for vertebrates, but there is a connection between the introduction of neonicotinoids and decrease in honeybee population.<sup>2</sup> Due to the possible link to colony collapse disorder (CCD) affecting honeybees, European Union in 2013 introduced a temporary moratorium on the use of thiamethoxam, clothianidin and imidacloprid. Besides honeybees, neonicotinoid residues in the environment affect other insects, disrupting ecological equilibria<sup>2,3</sup> and have been shown to also affect earthworms.<sup>4</sup> Some target species have developed resistance.<sup>1</sup>

**Table 1.** Some physico-chemical properties of selected neonicotinoids.<sup>5</sup>

Insecticide	Molecular mass [g/mol]	Water solubility [mg/L]	Partitioning coefficient (log $K_{OW}$ )	Degradation half-time in water samples [days]
Thiamethoxam (THM)	291.7	4100	-0.13	30.6
Clothianidin (CLO)	249.7	340	0.91	40.3
Imidacloprid (IMI)	255.7	610	0.57	30.0
Acetamiprid (ACE)	222.7	2950	0.8	4.7

Neonicotinoids belong to the class of systemic insecticides. They distribute throughout the plant and enable the protection against insects during a longer period of time.<sup>2</sup> They are non-volatile and polar compounds with high water solubility (Table 1)<sup>5</sup> and are not ionized at environmental pH values. These properties make them highly mobile in soil and increase their potential to leach into ground and surface waters.<sup>5</sup> Mobility in the soil depends on its composition and on the partitioning coefficient ( $K_{OW}$ ) for neonicotinoids (Table 1). Their stability in the environment depends on the environmental conditions. Main degradation processes are photolysis, photoinduced<sup>6</sup> and biotic degradation.<sup>7</sup> More stable neonicotinoids have a half-time of 30-40 days in environmental waters: IMI, THM, CLO (Table 1). Acetamiprid is less stable.<sup>5</sup> In soils, dissipation times (DT<sub>50</sub>) vary widely from 1 month to >10 years,<sup>2,8</sup> depending on the compound and soil type.

The method of choice for their determination is high-performance liquid chromatography (HPLC) with UV or diode-array detection<sup>9,10</sup> or coupled to mass spectrometry.<sup>5,11,12</sup> Prior to HPLC, they are extracted from environmental samples by solvent extraction or solid-phase extraction (SPE). Suitable solvents for their extraction are dichloromethane, methanol, acetonitrile and acetone.<sup>13</sup> For extraction from soil, pressurized liquid extraction, microwave-assisted or ultrasound-assisted extraction (UAE) can be used. Extracts are further purified by SPE<sup>9,11,14</sup> or by QuEChERS.<sup>12</sup>

In the present study, a SPE-HPLC-DAD method for the determination of selected neonicotinoids in environmental waters has been developed and then extended to soil samples by including ultrasound-assisted extraction (UAE). The developed methods have been applied to study neonicotinoid photolytic degradation in water and on the soil surface, as well as neonicotinoid sorption on soil.

## EXPERIMENTAL

**Materials.** The following standard substances were used: acetamiprid (ACE), clothianidin (CLO), imidacloprid (IMI) and thiamethoxam (THM), purchased from Sigma-Aldrich, Germany (Pestanal quality). Solvent acetonitrile was of chromatographic grade quality and acetone was >99.8%, both from Sigma-Aldrich. Formic acid >85% was from Panreac, Spain; acetic acid >99.8% was from Sigma-Aldrich. Purified water was prepared by Milli-Q system (Millipore, USA). For SPE, Supelclean LC-18, 1 g, 6 mL cartridges from Supelco (Germany) were used. Pesticide-free soil samples were homogenised, sifted and air-dried for 48 h before the use.

**Extraction from water samples.** Before extraction, SPE cartridge was conditioned by passing through 5 mL of acetonitrile and 5 mL of Milli-Q water. A suitable volume of aqueous sample was passed through the cartridge by applying vacuum with Supelco Visiprep™ manifold from Supelco (Germany) and water pump. The cartridge was then rinsed with 8 mL of Milli-Q water and dried for 5 min under vacuum. Analytes were eluted with 5 mL of acetonitrile. Before the analysis, extract was dried under a stream of nitrogen gas and reconstituted in 1.0 mL of acetonitrile/0.5% HCOOH (1:9).

**Extraction from soil samples.** Soil samples or spiked soil samples (10 µg/g) were weighted (5.0 g) into a glass container, 15 mL of solvent (acetone/0.5% HCOOH in Milli-Q water, 1:2) was added and the suspensions were placed into a ultrasound bath for 30 min. Suspension was then centrifuged for 10 min at 3000 rpm (Heraeus Megafuge 1.0, DJB Labcare, UK). Organic phase from the supernatant was evaporated in vacuum concentrator (RVC 2-12, Martin Christ, Germany). The remaining aqueous phase was subjected to SPE extraction.

**HPLC method.** Liquid chromatograph with diode-array detector Agilent 1100 Series (Hewlett Packard, USA) was used. Column was Kromasil Eternity C18, 100x4.6 mm, 5 µm particles (Sigma-Aldrich). Mobile phase A was acetonitrile and mobile phase B was 0.5% (v/v) HCOOH in Milli-Q water. The following gradient program was used: 0-3 min 10% A, 3-10 min to 25% A, 10-15 min to 40% A. Mobile phase flow was 0.8 mL/min and the injected volume was 20 µL. UV spectra were recorded in the 200-400 nm range and the wavelength for quantification was 254 nm.

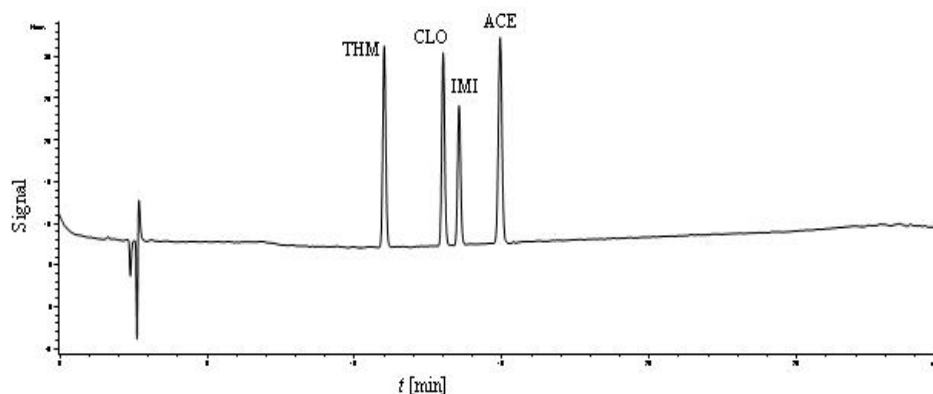
**Sorption experiments.** Aqueous solutions of neonicotinoids (10 mg/L, 100 mL) were measured into glass containers and 5 g of dried soil was added. The containers were sealed and placed on a mechanical shaker (Thys 2, MLW, Germany) for 1-120 h. The suspension was centrifuged for 10 min at 3000 rpm. Supernatant was extracted by the SPE method for aqueous samples.

**Photodegradation experiments.** 100 g of soil spiked with neonicotinoids (10 µg/g) was thinly spread over glass surface and covered with UV/Vis-transparent plastic foil. Soil was irradiated with UV light (254 nm) from Hg lamp (500 W, Heraeus, Germany). 5.0 g of soil was removed every 2 h up to 8 h and subjected to extraction and SPE clean-up. In the experiments with natural (solar) light, identically prepared soil was exposed outdoors to solar light for up to 21 days. Every few days, 5.0 g samples of soil were taken and subjected to extraction. The experiment was conducted in the month of May in sunny weather.

## RESULTS AND DISCUSSION

**Development of SPE-HPLC-DAD method for neonicotinoids in water samples.** HPLC separation of four neonicotinoids was achieved by using a gradient of acetonitrile and 0.5% formic acid in water (Figure 1). We noticed a severe distortion of analytes' peaks when injecting standard solutions prepared in acetonitrile. Therefore, all standard solutions and also sample extracts were prepared in acetonitrile/0.5% HCOOH (1:9). For solid-phase extraction of neonicotinoids from aqueous samples, several

parameters were optimized: type of sorbent (C18 or C8), elution solvent (acetonitrile or methanol) and its volume, addition of neutral salt (NaCl) and volume of sample. Optimal conditions are listed under Experimental. Breakthrough volume was established at 300 mL of aqueous sample, higher volumes resulted in lower recoveries. NaCl addition (3%) only slightly improved the recoveries. Parameters of SPE-HPLC-DAD method for spiked pesticide-free surface water are listed in Table 2.



**Figure 1.** Chromatogram of SPE extract of four neonicotinoids from aqueous sample, final concentration 2 mg/L.

**Table 2.** Parameters of SPE-HPLC-DAD method for neonicotinoids in surface water.

	$t_R$ [min]	lin. range [ $\mu\text{g/L}$ ]	$R$	LOQ <sup>a</sup> [ $\mu\text{g/L}$ ]	extraction recovery [%]	RSD <sup>b</sup> [%]	accuracy <sup>c</sup>
ACE	12,7	5 – 500	0.9999	5	107.1	0.8	+ 0.9%
CLO	10,8	5 – 500	0.9996	5	105.1	0.8	+ 0.9%
IMI	11,4	5 – 500	1.00	5	99.6	1.0	+ 4.9%
THM	8,9	5 – 500	0.9996	5	101.6	1.2	+ 4.5%

<sup>a</sup> at  $S/N = 10$ ; <sup>b</sup> for  $n = 4$ ; <sup>c</sup> average of 2 levels (8  $\mu\text{g/L}$  and 30  $\mu\text{g/L}$ )

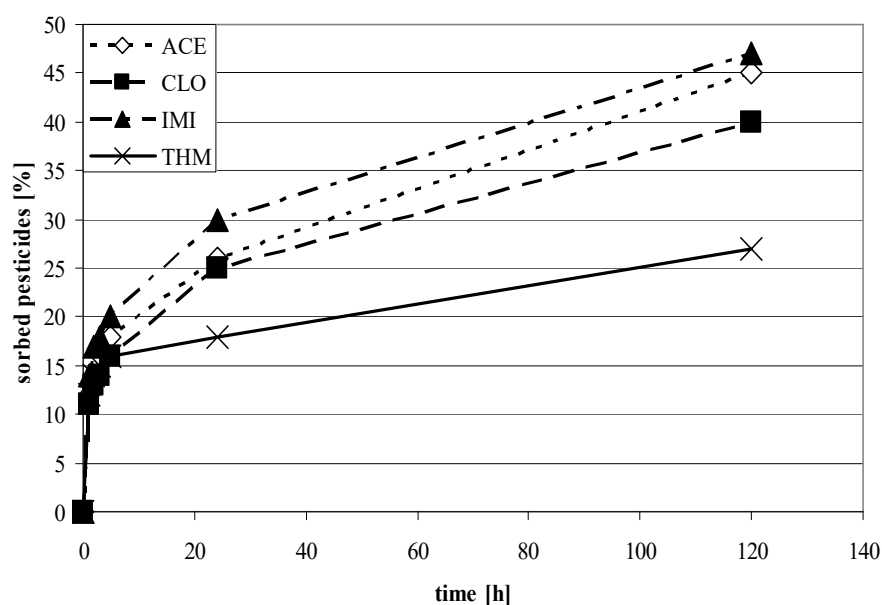
**Development of extraction method for neonicotinoids in soil.** Several solvents or combinations of solvents (acetone, methanol, Milli-Q water, 0.5% formic acid) were assessed for their ability to extract four neonicotinoids from spiked pesticide-free soil. Suspensions of soil and different solvents were immersed into ultrasound bath to assist desorption of pesticides from soil. Suspensions were then centrifuged and the supernatant was subjected to SPE extraction method. In cases when extraction solvent contained also organic solvent, the latter was evaporated before SPE. Best recoveries (Table 3) were obtained by using a combination of 5 mL acetone and 10 mL 0.5% HCOOH in Milli-Q water. Parameters of the method for determination of neonicotinoids in soil are listed in Table 3. Higher limit of quantitation for acetamiprid was a consequence of a matrix interference eluting at almost the same retention time.

**Table 3.** Parameters of UAE-SPE-HPLC-DAD method for neonicotinoids in soil.

	lin. range <sup>a</sup> [mg/kg]	LOQ <sup>b</sup> [mg/kg]	extraction recovery [%]	RSD <sup>c</sup> [%]
ACE	0.08 – 1.00	0.08	63.6	8.2
CLO	0.01 – 1.00	0.006	86.4	12.1
IMI	0.01 – 1.00	0.006	93.4	8.8
THM	0.01 – 1.00	0.006	65.9	13.8

<sup>a</sup>  $R > 0.99$ ; <sup>b</sup> at  $S/N = 10$ ; <sup>c</sup> for  $n = 6$

**Sorption of neonicotinoids on soil.** In the sorption experiments, aqueous solution of neonicotinoids was mixed with dry, pesticide-free soil and shaken on a mechanical shaker for different length of time. Suspension was then centrifuged and the supernatant extracted by SPE. The amount of adsorbed neonicotinoids was calculated from the remaining concentration in water (Figure 2).

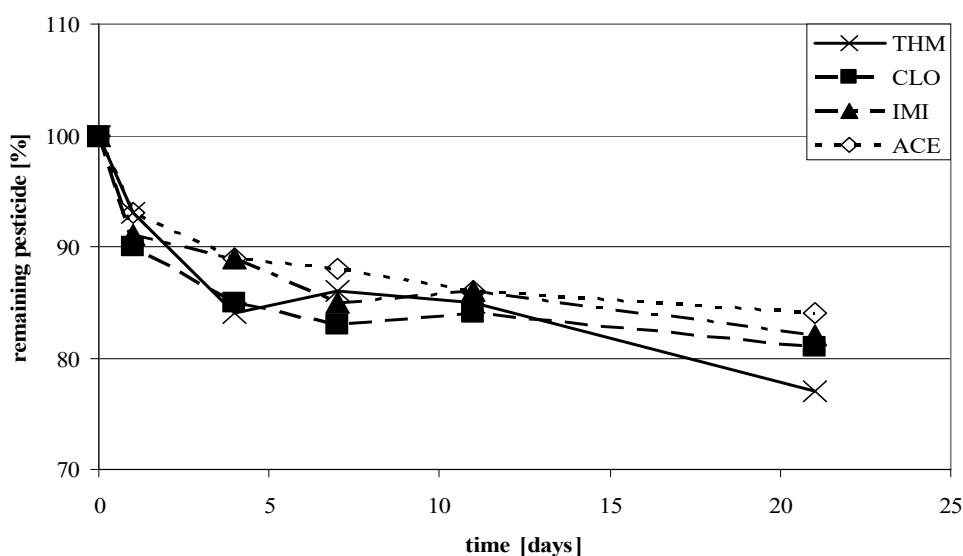


**Figure 2.** Percent of sorbed neonicotinoids on soil from aqueous solution during different time of exposure.

Thiamethoxam has shown the weakest sorption as more than 70% remained in the aqueous solution after 5 days which is not surprising regarding its water solubility and polarity (Table 1). The remaining three neonicotinoids sorbed to a comparable extent between 40 and 50% in 5 days. Thus, these four neonicotinoids have a high leaching potential, which is in agreement with other studies.<sup>8</sup>

**Photodegradation of neonicotinoids.** Photodegradation was first tested under UV light (Hg lamp) at 254 nm, which is a wavelength of strong absorption for all four compounds. In aqueous solution (10 mg/L), the concentration of all compounds fell below LOD already after 1 h of irradiation, indicating fast photodegradation under these conditions. However, the experiment with irradiation of thin layer of spiked soil with UV lamp gave quite different results: concentrations in the soil remained at the initial values  $\pm$  RSD even after 8 h. The results of this experiment can be explained by the shielding properties of the soil components, especially organic matter, which prevents absorption of UV light by target pesticides. This effect has already been observed for other types of pesticides.<sup>15</sup>

Photodegradation under solar light was conducted for neonicotinoids in a thin layer of soil covered with a transparent foil to prevent any evaporative losses. Samples were exposed to natural solar light (month of May, average temperature 14 °C) for up to 21 days. Results are shown in Figure 3. Assuming the 1<sup>st</sup> order of reaction, average degradation half-times were calculated: ACE 104 days, CLO 94 days, IMI 95 days and THM 68 days. The degradation of neonicotinoids in this experiment could be attributed to at least two processes: photosensitized reactions catalysed by organic matter<sup>15</sup> or minerals in the soil, or direct chemical degradation. No leaching was possible under the applied experimental conditions. Reported average dissipation times for the compounds in this study vary widely from 28 to 6931 days,<sup>2,8,16</sup> but they are not directly comparable to our results since in these studies, disappearance of compounds from the bulk soil which is not exposed to sunlight was monitored.



**Figure 3.** Percent of remaining neonicotinoids (parent compounds) in soil after different time of exposure to solar light.

## CONCLUSIONS

The results of the sorption and photodegradation study for the four neonicotinoids indicate their high leaching potential and high photodegradability under natural solar light at environmental conditions. Further research is planned to reveal the main mechanisms of photodegradation and the transformation products.

## REFERENCES

1. Bass C., Denholm I., Williamson M.S., Nauen R. The global status of insect resistance to neonicotinoid insecticides. *Pesticide Biochem. Physiol.* **2015**, 121: 78–87.
2. Goulson D. An overview of the environmental risks posed by neonicotinoid insecticides. *J. Appl. Ecol.* **2013**, 50: 977–987.
3. Pisa L.W., Amaral-Rogers V., Belzunces L.P. et al. Effects of neonicotinoids and fipronil on non-target invertebrates. *Environ. Sci. Pollut. Res.* **2015**, 22: 68–102.
4. Wang K., Pang S., Mu X. et al. Biological response of earthworm, *Eisenia fetida*, to five neonicotinoid insecticides. *Chemosphere* **2015**, 132: 120–126.
5. Hladik M.L., Calhoun D.L. Analysis of the herbicide diuron, three diuron degradates, and six neonicotinoid insecticides in water—Method details and application to two Georgia streams. *U.S. Geological Survey Scientific Investigations Report* **2012-5206**.
6. Abramović B.F., Banić N.D., Šojić D.V. Degradation of thiacloprid in aqueous solution by UV and UV/H<sub>2</sub>O<sub>2</sub> treatments, *Chemosphere* **2010**, 81: 114–119.
7. Zhou G., Wang Y., Zhai S. et al. Biodegradation of the neonicotinoid insecticide thiamethoxam by the nitrogen-fixing and plant-growth-promoting rhizobacterium *Ensifer adhaerens* strain TMX-23. *Appl. Microbiol. Biotech.* **2013**, 97: 4065–4074.
8. Leiva J.A., Nkedi-Kizza P., Morgan K.T., Qureshi J.A. Imidacloprid sorption kinetics, equilibria, and degradation in sandy soils of Florida. *J. Agric. Food Chem.* **2015**, 63: 4915–4921.
9. Wu M., Cai J., Yai J., Dai B., Lu Y. Study of imidacloprid residues in cabbage and soil by HPLC with UV detection. *Bull. Environ. Contam. Toxicol.* **2010**, 84: 289–293.
10. Obana H., Okihashi M., Akutsu K., Kitagawa Y., Hori S. Determination of acetamiprid, imidacloprid, and nitenpyram residues in vegetables and fruits by high-performance liquid chromatography with diode-array detection. *J. Agric. Food Chem.* **2002**, 50: 4464–4467.
11. Hao C., Morse D., Zhao X., Sui L. Liquid chromatography/tandem mass spectrometry analysis of neonicotinoids in environmental water. *Rapid Commun. Mass Spectrom.* **2015**, 2225–2232. DOI: 10.1002/rcm.7381
12. Dankyi E., Gordon C., Carboo D., Fomsgaard I.S. Quantification of neonicotinoid insecticide residues in soils from cocoa plantations using a QuEChERS extraction procedure and LC-MS/MS. *Sci. Total Environ.* **2014**, 499: 276–283.

13. Ahmed E. F. Analyses of pesticides and their metabolites in foods and drinks. *TrAC* **2001**, 20: 649–661.
14. Campbell S., Chen L., Yu J., Li Q.X. Adsorption and analysis of the insecticides thiamethoxam and indoxacarb in Hawaiian soils. *J. Agric. Food Chem.* **2005**, 53: 5373-5376.
15. Prosen H., Zupančič-Kralj L. Evaluation of photolysis and hydrolysis of atrazine and its first degradation products in the presence of humic acids. *Environ. Poll.* **2005**, 133: 517–529.
16. Schaafsma A., Limay-Rios V., Xue Y., Smith J., Baute T. Field-scale examination of neonicotinoid insecticide persistence in soil as a result of seed treatment use in commercial maize (corn) fields in Southwestern Ontario. *Environ. Toxicol. Chem.* **2016**, 35: 295–302.





## EXTRACTION AND SEPARATION OF SPARINGLY LANTHANUM AND CERIUM COMPOUNDS FROM AQUEOUS SOLUTIONS USING ELECTROCHEMICAL METHODS

Artem V. Kolesnikov, E. N. Gaidukov\*, V. A. Kolesnikov

D. Mendeleev University of Chemical Technology of Russia, RUSSIA

\*engaydukov@gmail.com

### ABSTRACT

The basic dependence of cerium and lanthanum extraction and separation from aqueous systems has been investigated. The optimum parameters of the process for individually extracting of each component with extraction degree up to 99% were identified. Electrochemical oxidation selected as a promising method for the oxidation of trivalent cerium in the tetravalent form; further using electroflotation extraction at pH=4.5 for cerium (IV) and using electroflotation extraction at pH=10 for lanthanum.

**Key words:** electrochemical oxidation, electroflotation, cerium, lanthanum.

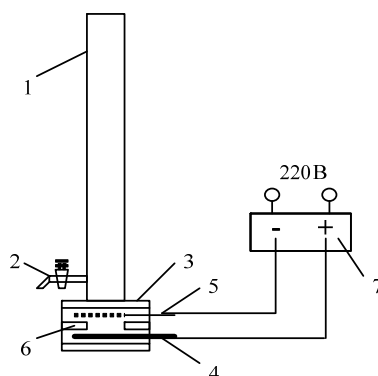
### INTRODUCTION

The successful development of many branches of modern technology - aviation, space exploration, nuclear industry, semiconductor and quantum electronics, new materials technology is significantly due to the extensive use of rare earth elements (REE). Currently, industry produces in a given amount of almost all REE and the need for their production is continuously increasing. In this regard, an actual problem is the development of effective methods of processing rare earth containing mineral raw material and industrial wastes, which contain REE considering environmental requirements and reduce the economic costs [1, 2].

A distinctive characteristic of the rare earth elements is the similarity of their chemical properties that significantly impairs their separation and preparation in pure form [1, 3]. In addition, mineral raw materials and industrial waste of REE are present in a mixture with other compounds and elements; also in the process of leaching the solution richly saturated with various third-party anions. In the broad range of rare earth ore the most common in the mass shares of REE are lanthanum and cerium. This article provides an experimental material for selective separation and extraction of the aqueous solutions containing the cerium (III), cerium (IV) and lanthanum using electrochemical oxidation and multiple stage of electroflotation processing.

## EQUIPMENT AND EXPERIMENTAL RESULTS

For carrying out experiments of electroflotation extraction of cerium and lanthanum used method for general recovery of heavy and non-ferrous metals, described in details in [4]. Electroflotation extraction studies were carried out at room temperature ( $20 \pm 2$  °C) in a non-flowing electroflotator volume of 500 ml with the cross-sectional area of  $10 \text{ cm}^2$  device; used anode - ORTA (oxide ruthenium-titanium anode), cathode – wire mesh of stainless steel. Scheme of laboratory electroflotation system shown in Figure 1.



**Figure 1.** Scheme of batch-action laboratory electroflotation system: 1 – electroflotator column; 2 – valve; 3 – electrode unit; 4 – anode; 5 – cathode; 6 – rubber gasket; 7 – DC power source.

For determining the concentration of lanthanum and cerium used inductively coupled plasma mass spectrometry Thermo Scientific XSeriesII. The recovery rate of the individual element  $\alpha$  calculated using the formula:

$$\alpha = \frac{C_{\text{start}} - C_{\text{finish}}}{C_{\text{start}}} \cdot 100\%$$

$C_{\text{start}}$  and  $C_{\text{finish}}$  – concentrations of cerium and lanthanum before and after treatment, mg/l.

Preliminary experiments showed that the presence in solution mainly trivalent cerium, despite the difference in optimum pH of the formation of hydroxides between cerium and lanthanum in several pieces doesn't occur the selective separation when using electroflotation technology. Assumed that works the sorption mechanism of sparingly soluble particles of lanthanum on the surface of the particles of trivalent cerium. For this reason, cerium (III) and lanthanum extracted together in a pH range of 7 to 10 degrees with recovery rate from 82 to 95%.

Accordingly, the first stage of the experimental part was transfer trivalent cerium in the tetravalent form. There are several methods for the oxidation of cerium (III) – hydrogen peroxide treatment, ozone treatment, air oxidation, oxidation with

halogens, etc. The authors choose another promising method – electrochemical oxidation.

The electrochemical oxidation of cerium chloride and sulphate solutions complicated by several disadvantages associated with the release of chlorine, the resulting instability of cerium (IV), and others. Therefore, in practice, mainly use a method of electrochemical oxidation nitrate solutions. The most effective anode material being platinum and platinized titanium, the cathode material – graphite or titanium [5]. It has been studied electrooxidation of cerium (III) in nitric acid solutions of REE. In the cell areas with unshared electrode as anode used a platinum mesh cylindrical shape with a surface area of 0.1 dm<sup>2</sup>, as cathode – coaxial disposed titanium rod with varying surface area. The concentration of cerium (IV) in solution determined by titration with a solution of Mohr's salt in the presence of DAS indicator; according to the analysis was calculated oxidation state from cerium (III) to cerium (IV).

As a result of experiments were obtained the optimal conditions for the process cerium electrooxidation: current density of 1.5-2.0 A/dm<sup>2</sup>, the concentration of cerium (III) 100-150 g/l, temperature 20 °C, concentration of nitric acid at least 10-15 g/l [6]. Under these conditions of the process, 100% of cerium (III) contained in the solution changes from trivalent to the tetravalent state.

After the electrolysis in the aqueous solution stayed only cerium (IV) and lanthanum. There have been studies showing that using electroflotation can share these rare-earth elements with a high degree of efficiency. We can obtain high selectivity ratio with selectivity coefficient  $K(\text{Ce}^{+4}/\text{La}^{+3}) = 40$  in these optimal conditions: pH about 4, volume current  $i_v = 0,4$  A/l,  $\tau$ (processing time) = 10 min.

The recovery rate of cerium (IV) without additions may be up to 95% when initial concentrations up to 100 mg/l, but when the concentration increases, recovery rate becomes lower. Some kinds of flocculants and surfactants have positive impact for electroflotation extraction of cerium (IV) at high initial concentrations. Data on the effect of additives on the recovery of cerium shown in Table 1. Was applied the following additives: cationic flocculant C-496, anionic flocculant A-137, nonionic flocculant N-300 (all – Superfloc series), cationic surfactant Catinol, anionic surfactant NaDBS, nonionic surfactant PEO-1500. The concentrations of additives – 1-10 mg/l.

**Table 1.** Effect of flocculants and surfactants cationic, anionic and nonionic types on the recovery rate of sparingly soluble compounds of cerium (IV).

Type of additive	$\alpha (\text{Ce}^{+4})$ in $\tau$ , min			
	2	5	10	15
Without additives	2	15	30	30
C-496	95	99	99	99
A-137	10	67	98	98
N-300	2	9	9	9
Catinol	49	53	53	53
NaDBS	51	55	58	58
PEO-1500	1	1	2	13

$C_{\text{start}}(\text{Ce}^{+4}) = 400$  mg/l,  $c_{\text{additive}} = 1-10$  mg/l,  $i_v = 0,4$  A/l

As can be seen from Table 1, the flocculant C-496 is highly effective - in 5 minutes of electroflotation treatment recovery rate reaches 99%; also effective flocculant A-137 ( $\alpha$  up to 98% after 10 minutes of treatment). Other types of additives adversely affect the electroflotation process of sparingly soluble compounds of cerium (IV), or increase its efficacy not significantly.

The next step after removal of cerium (IV) from a solution is increase pH up to 10 with concentrated alkali and secondary electroflotation treatment for extracting sparingly soluble lanthanum compounds. Experimental data of electroflotation extraction of lanthanum shown in Table 2.

**Table 2.** Recovery rate ( $\alpha$ , %) of sparingly soluble compounds of lanthanum, depending on the solution composition.

$\tau$ , min	Background electrolyte			
	NaCl	NaNO <sub>3</sub>	Na <sub>2</sub> SO <sub>4</sub>	Na <sub>2</sub> CO <sub>3</sub>
5	51	55	79	11
10	80	58	68	11
20	56	22	33	13

pH = 10,  $i_V = 0,4$  A/l, C (La<sup>3+</sup>) = 30-100 mg/l.

As seen from Table 2, the recovery rate of electroflotation extraction of lanthanum compounds aren't so high as cerium, however, the process is quite effective, allowing to extract 80% of the lanthanum in the foam layer. For increased the efficiency of the process is possible to use various surfactants and flocculants. Separately, it is worth noting that in the carbonates background electroflotation process is very difficult.

Based on experimental data, with the prevalence of nitrate ions in solution are effective surfactant additives: Septapav (cationic), NaDDS (anionic), PEO-1500 (nonionic) and flocculants: cationic C-496, anionic A-137 and non-ionic N-300; in all cases the recovery rate is increased up to 95-98%. In the case of sulphate background very effective Septapav and NaDDS ( $\alpha$  up to 97%) and C-496 flocculant ( $\alpha = 96\%$ ). In the chloride background NaDDS and PEO-1500 increase the recovery rate (98 and 95% respectively). In the carbonates background additives wasn't effective, but nonionic flocculant increase the recovery rate up to 93%. The concentrations of surfactants and flocculants were set in the range of 1-5 mg/l.

## CONCLUSIONS

Sequence of processes for the separation and extraction of cerium and lanthanum from the aqueous solutions using electrochemical oxidation and electroflotation treatment has been developed.

The first stage – transferring trivalent cerium in the tetravalent form using oxidation in electrochemical cell under the following optimal parameters: 1.5-2.0 A/dm<sup>2</sup> of current density, concentration of cerium-ions (III) 100-150 g/l, temperature – 20 °C, concentration of nitric acid least 10-15 g/l.

The second stage – electroflotation method of extracting sparingly soluble compounds of cerium (IV) under the following optimum conditions: pH = 4.5, C (Ce<sup>+4</sup>) up to 1.5 g/l, C<sub>additives</sub> = 1 mg/l, i<sub>v</sub> = 0.4 A/l, as additive use a cationic flocculant C-496.

Third stage – electroflotation method of extracting sparingly soluble compounds of lanthanum under the following optimum conditions: pH = 10, C (La<sup>+3</sup>) up to 100 mg/l, C<sub>additives</sub> = 1-5 mg/l, i<sub>v</sub> = 0.4 A/l, as additives use surfactants Septapav or NaDDS, or cationic flocculant C-496.

The described sequence of processes carried out under optimal conditions, allows for the selective extraction of cerium (IV) and lanthanum at the level of 95-99%.

#### **Acknowledgements**

*This work was supported by the Russian Science Foundation (project no. 14-29-00194).*

#### **REFERENCES**

1. Bolshakov K. 1976. Chemistry and technology of rare earth metals. V.2. 360 p. High School, Moscow.
2. Korovin S., Zimina G., Reznik A. 1996. Rare earth elements. Chemistry and chemical technology. V.1. 376 p. MISiS, Moscow.
3. Iring L. 1970. Advances in the chemistry and technology of rare earth elements. 488 p. Metallurgy, Moscow.
4. Kolesnikov V., Ilyin V., Kapustin Y. 2007. Electroflotation technology of wastewater treatment of industrial enterprises. 307 p. Chemistry, Moscow.
5. Mikhailichenko A., Mihlin E., Patrikeev Y. 1987. Rare earth metals. 231 p. Metallurgy, Moscow.
6. Pozdeev S., Kondratyeva E., Gubin A., Kolesnikov V. 2014. Advances in chemistry and chemical technology. pp 98-100. V. XXVIII, № 5.
7. Gaydukova A. 2016. Ph. D. in Technical Science. 155 p. MUCTR, Moscow.



## FLOATING LANDFILLS IN ACCUMULATIONS OF 'DRINSKO-LIMSKE HYDROPOWER PLANTS'

Marijana Saric\*, M. Domazet, S. Leovac, N. Vranic, S. Andric

JP 'Electric Power Industry of Serbia',  
'Drinsko-Limske hydropower plants' division, SERBIA

\**marijana.saric@dlhe.rs*

### ABSTRACT

In this paper, the origin of the floating landfills in accumulation of 'Drinsko-Limske hydropower plants' is analyzed. In addition, the procedure for their removing from the accumulations is proposed.

### INTRODUCTION

'Drinsko-Limske hydropower plants' division for the electric energy production (with total nine (9) hydropower plants) uses the water from the following rivers: Drina, Zapadna Morava, Lim, Uvac and Bistrica. One of the most significant issues with these hydropower plants is the floating landfills, which retains on the dams and the hydropower plant buildings. The floating landfills typically have the same structure on all accumulations. The floating landfills are mostly composed from plastic bottles, plastic bags, trees and other small waste. Percentage parts are as follows: 70% of pet packaging (plastic bottles), 20% of wood, and the last 10% is referred as the other wastes.

Waste composition suggest us about its anthropogenic origin.

### NATURE AND ANTHROPOGENIC GENESIS FACTORS OF THE FLOATING LANDFILLS

Floating landfills are composed from the all kind of materials, which water flows carry, with them until they come up on nature or manmade obstacles where they gather. It occurs due to both nature and anthropogenic actions.

The people have the dominant impact on the quantity and the composition of that waste.

Coasts of rivers Drina and Lim are contaminated with large amounts of these wastes, which are located on both unorganized landfills and illegal dumping grounds.

Unfortunately, over the years, the disposing waste along the river coasts became people's bad habit and typical routine. When the rain starts to fall, or the water level raises, the large amount of waste slip downward from river coasts, get into the river watercourse and lead into the forming 'swimming islands' made out of junk, which river has collected from its coast (Fig. 1).

It is established that all landfills in studied river flows are unhygienic and insanitary dumps and that every municipality has at least one landfill for municipality based waste, where it brings the own waste. Presence of nylon bags and pet packaging are established on river coasts, and it is located even on trees due to high water flows.



**Figure 1.** Coast of river Lim

Waste from river coasts during the large amount of rains and high water flow gets into those rivers and is being transported along the coast and hydropower plants dams.

Public carelessness and unresolved questions in the waste managing on the municipality and government levels contributes that the all types of waste cover this area, that is very rich on the natural resources. It influences to degradation of the entire eco system and disruption of natural landscape. Nature potentials of these areas are significantly reduced, because of floating waste issues and garbage of all types. Rivers Drina and Lim are often mentioned as the main sources of the flowing landfills, because in these waters large amounts of pet packaging are floating and are stopped by hydropower plant dams. Cleaning cost is very high, and when waste is taken out from accumulations there comes a question of sharing this waste.

Origin of this waste that reaches hydropower plants is from unorganized and wild landfills, which are located right next to river coasts and individuals that throw garbage on river coast or directly in river flows.

Last years in our countries hard work is done for finding solutions for landfill problem, legalization is being made, but we should take a look at consequences and damages on our environment that are made from already existing landfills.

It is "easier" for population to throw garbage in rivers, because you know that river carries it all.

### **SISTEMATIC SOLVING OF THE FLOATING LANDFILLS PROBLEM IN 'DRINSKO-LIMSKE HYDROPOWER PLANTS'**

Floating waste (or landfills) that reaches to hydropower plant dam is collected and being taken out with various manual techniques.

Security measures that are changed so far and refer to eliminating the coats from lake's surface and above or from gratings, with use of boats or divers.

In 'Bajina Basta hydropower plant' the lake's surface cleaner is purchased, and for the first time it has been used for the waste cleaning at the beginning of 2005. year only in Perucac lake.

The boat that has been used for eliminating the floating debris and floating landfills did not meet qualifications for this service. Equipment and capacity of this boat did not meet requirements for the amount and kind of waste that was collected on the dam. On bar basket of mentioned boat wood waste would be stuck, making the pet packaging harder to collect (Fig. 2).

Since, the floating waste is being collected manually from little boats. Financing of waste collection is made with support from the management of 'Bajina Basta power plant', National park and municipality (Fig. 3).



**Figure 2.** The boat used for collecting floating waste on Perucac accumulation





**Figure 3.** Collecting waste from Perucac accumulation

In 'Zvornik hydropower plant' sprockets were planted close to dam on which waste is collected so that it can be taken out manually. Also, the primary waste selection is being made. Plateau where the press for compacting the plastic waste is located is shown in Fig. 4, but the largest pieces of floating debris are taken out by grapples (Fig. 5).

In 'Lim hydropower plant', the problem of the floating debris and floating landfills is resolved by the leakage with the assistance of the gradient to 'Bajina Basta hydropower plant'. The floating debris is collected by grapples that are installed on the dam (Fig. 6), and also by recruiting professional divers (Fig. 7).



**Figure 4.** Plateau with the press for compacting of the plastic waste



**Figure 5.** The largest pieces of floating debris are taken out by grapples (the example from 'Zvornik hydropower plant')



**Figure 6.** The floating debris collected by the grapples (the example from 'Bajina Basta hydropower plant')



**Figure 7.** Recruiting professional divers (the example from 'Bajina Basta hydropower plant')

## **MAKING CADASTER OF LANDFILLS NEXT TO WATER FLOWS, UPSTREAM TO THE ACCUMULATIONS**

In order to comprehend the floating landfills issues, cadaster of landfills was made upstream of the accumulations of 'Drinsko-Limske power plants'.

For making the landfill cadaster in flows of Drina, Lim and Zapadna Morava land studies were made and the all landfill locations are recorded. The landfills are officially used for every days waste storage of communal waste and are organized by the utility services or companies who collect and transport the waste.

Large number of these municipality waste landfills are unhygienic, also known as *wild landfills*. Unauthorized individuals with their own transport and without any regulation and control make unloading this waste.

Every landfill is described with many details and these data are collected:

- 1) municipality where landfill is located;
- 2) type of landfill (wild, communal or sanitary);
- 3) name of landfill;
- 4) coordinates of the landfills;
- 5) landfill status (active or inactive), when landfill was made, their capacity, landfills surface area (how close it is to river flow);
- 6) characteristic of waste (dangerous, safe or mixed), type of waste being collected (communal, construction, electronic, animals or other);
- 7) presence of smoke on landfill, covering with inert materials and other.

Next to Drina water flow, there are problems with collecting the firm materials, lack of penalty policies and others.

For making the landfill cadaster in Lima water flows that is going through several municipalities there were registered many active communal landfills and many wild ones.

Active landfills beyond river Lim were registered, where mixed, dangerous and safe waste is collected. On the river Zapadna Morava, only the landfills for safe waste were registered and one landfill for mixed and safe waste.

Waste recorded in Drina, Lim and Zapadna Morava river flows (Figs. 8, 9 and 10, respectively).

## **PROPOSAL FOR INTEGRATED APPROACH IN RESOLVING THE FLOATING LANDFILLS ISSUES**

When defining the proposal for integrated approach we should observe next important notes:

1. International and regional character of the problem.
2. Low living standard of the population in this area.
3. Low level of awareness of the significance of the problem in this area

Propositions for the problem resolving should be divided into two categories: 1) short-term steps, and 2) long term steps.





**Figure 8.** Landfill in river flow (the example from river Drina)



**Figure 9.** Landfill in river flow (the example from river Lim)



**Figure10.** Landfill in river flow (the example from river Zapadna Morava)

Short-term steps should include: 1) establishing good and effective system for waste collecting in all hydropower plants, 2) establishing the monitoring systems, and 3) establishing a web page for informing the public in already made and planed activities.

Long-term steps should include: 1) continue the monitoring of these systems, 2) establishing the foundation for protecting rivers with floating debris and landfills issues, 3) raising the public awareness, 4) creating cooperating between municipalities in areas where floating waste is managed according with national strategy in managing these wastes, and 5) managing these activities in success and implementation of law.

### **CONCLUSION**

The problem of floating debris and floating landfills is verified in all accumulations of 'Drina-Lim hydropower plants'. This problem would be solved if sanitary landfills would be built out of blue zones and closing of existing landfills, wild landfills and communal landfills in river areas. In addition, then the massive usage of pet packaging would be reduced, the problem of floating debris would be minimized, but not fully eliminated.

### **REFERENCES**

1. Study "Tehno-ekonomska analiza upravljanja plivajucim otpadom u PD Drinsko-Limske hidroelektrane", 2015 year.



## UNDERGROUND AND SURFACE WATER PROTECTION OF HEATING FACILITY VREOCI POLLUTANTS, BY USING HDPE GEOMEMBRANES

Novica Momcilovic\*, J. Vukasinovic

RB "Kolubara" Lazarevac, SERBIA

\**novica.momcilovic@rbkolubara.rs*

### ABSTRACT

By combustion of coal dust in the boilers of the heating plant ash and slag remains as by-products. There is a need for their everyday disposal on locations where the environment will not be affected, i.e. where the pollution of soil, surface and ground water will be prevented.

For this purpose, and according to the legislative regulation in force, special cassettes, lined with watertight geomembranes are built. They allow re-enter of clarified water into the technological process of the hydraulic ash transport.

**Key words:** Combusting, ash, slug, geomembranes.

### INTRODUCTION

Coal is the basic energy resource in Serbia. Electric Power Industry of Serbia produces about 70% of electricity in its thermal plants with two coal basins, Kolubara and Kostolac.

According to EPS, in the year 2014 it has been excavated about 29 million tons of lignite for production of electricity, what means over 20,500 GWh.

RB: "Kolubara" is located 60 km southwest of Belgrade and covers an area of nearly 600 square kilometers. The opening of the I. open pit field "A" - 1952 begins mass surface exploitation of the Kolubara lignite.

RB. "Kolubara" is organized as a host utility which consists of five branches: "Direkcija/Headquarters", "Površinski kopovi/Open pits", "Prerada/Processing", "Projekt/Project" and "Metal".

The Branch „Prerada/Processing“ consists of the three operational units: Dry Separation, Railway Transport, and Coal Refinement. Within the operational unit Coal Refinement there are OU Drying Plant, Wet Separation, Heating Plant, and Maintenance. Heating Plant is obliged to produce enough quantity of heating energy for production of dry coal, aerated concrete, district heating of the town Lazarevac and industrial area of RB. „Kolubara“.

## TECHNOLOGICAL DESCRIPTION OF THE HEATING PLANT

The Plant "Toplana" (Heating Plant) is a heating plant designed for the production of thermal energy and it was built in 1980 with two boiler units of power of 2 x 60 KW of heating energy.

In the process of heating energy production, 22,000 tons of coal are combusted, thereby producing about 29, 000 tons of ash and slag.

Coal from the OPMs Field "D" and Field "B" is delivered by belt conveyors to the operational unit Dry Separation plant and further on to the Heating Plant. For the needs of the Heating Plant, coal of the grade "Cube" (- 60 + 30 )mm, and calorific value of about 9 000 KJ is delivered.

The capacity of steam generators (boilers) is 70 t/h and they are stoked a lignite coal dust. Preparation of coal (grinding) is performed for each boiler by fan mills. Superheated steam pressure is 59 bar and the temperature 450°C. Boiler feedwater is transported from the chemical water treatment plant.

Slag remains in the boilers after coal combustion, and after the passing of flue gases through the electrofilter plant, ash retains on the electro filters.

Operational unit Heating Plant consists of three interconnected production units:

- a) CWT – chemical water treatment,
- b) Steam generators – boilers,
- c) HPT – Hydro-pneumatic transport

### a) CWT – Chemical water treatment

– performs the boiler feedwater treatment (demineralised water) as well as cooling water treatment (decarbonized water).

### b) Boiler plant (steam generators)

It consists of two boilers with capacity of 2 x 70 t/h superheated steam of pressure  $p = 59$  bars and temperature  $t = 450^\circ\text{C}$ .

### c) HPT – Hydro-pneumatic transport

Mixture of crushed slag, ash and water is discharge by pumps  $Q = 2 \times 60 \text{ m}^3/\text{h}$ , into the pipeline to the dump site in Medoševac.

Clarified water from the dump site goes back to the technological process ( tank) for the purpose of making a mixture of ash and slag and retransportation to the dump site.

## CHARACTERISTICS OF ELECTROFILTER ASH

Electrofilter ash is produced by the combustion of coal dust in boilers and then removed by dry method (electrofilters) from the flue gas.

Combustion results in: ash - 19%, slag and sand -13%

Ash is removed using the dry method, purification of flue gases of 96% by using electrostatic electrodes into the settling basins - containers for collecting dust.

## CONSTRUCTION AND LINING OF ASH AND SLAG DUMP SITE

First dump site for ash and slag disposal from the Heating Plant was built in 1977. Since 2008 a new dump site in Medoševac has been used for ash and slag disposal which was built for two-year disposal with the possibility of clarified water refill and discharge after filling. In order to dispose 29,000 tons of ash and slag, it is necessary to provide about 41,000 m<sup>3</sup> of storage area protected by waterproof foil.

Dump site is 4 meters deep and includes 3 meters of embankment. Perimeter embankment is 3 meters high with the lateral slope 1:1,5 and the width of the embankment crown of 4m. The depth of the excavation is 4m with the internal slope inclination 1: 1.

It was excavated approximately 50,000 m<sup>3</sup> of earth, and it was used for the construction of the embankment. The embankment was constructed in layers of 30cm by rolling by means of a toothed roller. After the completion of rough earthworks, the finish of the interior sides was done as well as the dump site bottom levelling and the preparation for putting the geomembrane.

The size of dumpsite is 240 x 60 x 7 m , the lining is **HDPE** geomembrane of high density, 2mm thick, UV and abrasion resistant.

Crucial for the selection of geomembranes were the characteristics and references of the offered products. According to our needs, we have chosen **HDPE** geomembranes, 2mm thick, made by German company “**NAUE**”.

The chosen geomembranes showed extraordinary features in exploitation of dumpsite as well as in dumpsite reclaiming later on.



**Figure 1.** Setting up of the geomembrane in the large settling basin



## **TECHNOLOGICAL PROCEDURE OF ASH AND SLAG DISPOSAL ONTO THE DUMP SITE**

The main concept of hydraulic transport of ash and slag from the excavator pit in the Heating plant to the dump site in Junkovac has been established back in 1977. Since 2008, a new dump site in Medoševac has been used for the ash and slag disposal. Next to the dump site there are three pipelines set up. One of them is a discharge pipeline for the mixture of ash and slag and the other one is used for clear water coming from the dump site and the third one serves as a backup pipeline.

Combustion products in the boilers – are being sent to the tank (200m<sup>3</sup>) where the ash and slag mixture is being mixed with water in 1:8 ratio, and as such pumped into the 2km pipeline by means of the excavator pump.

Ash and slag disposal system has been designed so that the output point is set in the small settling basin. Between small and large-scale settling basin there is a tank installed serving as a primary settling of large size particles of ash and slag.



**Figure 2.** Ash and slag settling basin in Medoševac – primary settling in the small settling basin.

Partly purified water without large particles is spilling over into a bigger settling basin where additional purging is taking place by removing fine particles.

Purged out water from the large settling basin flows free via the overflow collector to the tank in the pump station and is further pumped into the return pipeline until it reaches the tank in the Heating plant.

Closed cycle of the transport of ash and slag mixture contributes to lesser consumption of water, and thus lesser costs of fresh technical water supply.



**Figure 3.** Large-scale settling basin – overflow collector of purged water

Since average quantity of ash and slag transported annually amounts to 29,000 tons, in order to make the mass ratio 1:8 of hydro mixtures, it is required to have cca. 230 560 m<sup>3</sup> of technological water a year. It is estimated that cca. 90 % (207 504 m<sup>3</sup> annually) of used water can be returned from the dump site in Medoševac after fine particles had settled.

The remaining quantity of water necessary for hydro mixture (10%) needs to be complemented by fresh water (23 056 m<sup>3</sup> annually). The water from the Kolubara River water collector is used as a supplement of fresh water, and it is added directly into the water basins located right next to the Heating plant in Vreoci.

### CONCLUSION

Ash and slag dump site in Medoševac is located in the close vicinity of the open pit mine Kolubara Field “D”. The existing state of the environment at the very location is conditioned by the coal exploitation in the open pit mine. The ground and residential buildings near the dump site are bought off. The dump site is situated in the industrial circle of the OPM Field D and with impermeable HDPE foil lining resistant to climate changes, so that the impact on the environment is minimized. The dumped material inside the dumpsite is moist thus preventing flying of the ash and slag in windy conditions and the transfer thereof into the environment.

Legal regulations prescribe the continuous monitoring of the ground water level around the dump site. With regards to that fact, seven piezometer boreholes were drilled around the dumpsite. Piezometers were installed in all 7 boreholes.

First quality testing results of the water sampled from the monitoring wells built-in on dumpsite are taken as zero data. The dynamics of water quality monitoring is conducted four times per year (2 times during the winter and 2 times during the summer), and if necessary more often if the situation on the ground requires it.

The results obtained in the course of the exploitation should be compared with zero data and the prescribed boundary data. If there is a change of the quality, it is a sign that there has been damage to the foil and it is necessary to take measures for the rehabilitation of the damaged foil on the dumpsite.

Industrial water (water that is pumped back into the technological process of re-forming hydro-mixture in the tank) from the accumulation pond of the dumpsite and at the immediate entrance of the tank will be sampled at the same time as the water from the built-in piezometers.

As the industrial water used for forming hydro mixtures contains increased pH values (above the accepted limit) as well as certain pollutants, it cannot be discharged into the surrounding recipients. This means that increased attention should be paid to the system used for pumping industrial water from the dumpsite in Medosevac to the Vreoci plant.

Soil and air contamination around the ash and slag dumpsite in Medosevac is not expected, and the consequences for the environment are minimal or not present at all, because the entire landfill lies under water mirror (wet process).

In order to bring the land to its original condition after the exploitation is finished, it needs to be reclaimed, restoring its original purpose. The first phase of reclamation is technical reclamation, applying a layer of soil of around 0.5m across the ash and slag area, which is the basis for the next reclamation phase – biological. Construction of ash and slag disposal dumpsite in cassette lined with waterproof geomembrane (HDPE) keeping the water mirror during exploitation gives complete safety from the possible harmful environmental impact.

#### **REFERENCES**

1. A simplified mining project of route relocation of part of the pipeline for the transport of ash and slag in Vreoci, Volume III, Issue 1-3 - Temporary ash and slag dumpsite technical solutions, Projmetal Belgrade, 2007
2. Personal experience with a photo collection from the period of object construction



## PURIFICATION WASTE WATER AND POLLUTED AIR GALVANIC-CHEMICAL PROCESSES

Bozidarka Arsenovic<sup>1</sup>, B. Ivanovic<sup>2</sup>, S. Stanisic<sup>2</sup>

<sup>1</sup>International University Travnik; Faculty of Ecology Studies,  
BOSNIA I HERZEGOVINA

<sup>2</sup>„Orao“ a.d. manufacturing and repair, Bijeljina, Republic of Srpska;  
BOSNIA I HERZEGOVINA

*bokijevmejl@gmail.com*

### ABSTRACT

The process of galvanic-chemical protection according to the qualitative and quantitative characteristics, is one of the most complex wastewater pollutants. Also, from the surfaces of industrial solutions, as well as the protected parts of the stages of care, there are significant fumes, which pollute the surrounding air, which is to be treated prior to discharge into the environment. Depending the way they emerged, wastewater contains: the free acids and bases; specific contaminants: cyanide, chromium and nitrate and dissolved heavy metals: Fe, Cd, Ni, Cu, Zn, Ag, etc. Polluted air is full with mixed vapors of acids and bases, as well as the specific chromium and cyanide vapors. The paper shows the procedures, as well as, mechanisms of treatment of wastewater and polluted air generated in the process of galvanic-chemical protection in the collective of "Orao" a. d. Bijeljina.

The results obtained were compared with the values prescribed by regulations in the Republic of Srpska in the field of waste water and emissions of air pollutants.

**Key words:** waster water, air is polluted, galvanic-chemical protection.

### INTRODUCTION

The technological process of galvanic-chemical protection, according to the qualitative and quantitative characteristics, is one of the most complex pollutant wastewater [2]. This process requires successively dumping cases in more solutions where they perform processes of chemical and electrochemical nature. Because his geometric shape and adhesion phenomena, when coming out of each solution, objects entail the amount of fluid that can not be ignored. That is why objects, before moving to the next stage of processing, must rinse well [1,2]. This leaching causes the creation of waste water containing: free acids and bases; specific contaminants: cyanide, chromium and nitrates and dissolved heavy metals: Fe, Cd, Ni, Cu, Zn, Ag, etc. Also, due to evaporation from the surface of industrial solutions and protected parts in stages of protection, resulting polluted air that, which is before discharge into the environment, must be treated [1,4].

The paper shows how the procedures, mechanisms and processes of wastewater treatment incurred in the process of galvanic-chemical protection. The paper presents a brief overview of the ecological aspect of the treatment of waste water generated in the process of galvanic-chemical protection of metal parts, as a result of compliance with the prescribed regulations in the Republic of Srpska in the field of waste water and emissions of air pollutants.

### SOURCES OF INDUSTRIAL WASTE WATER GALVANIC - CHEMICAL PROCESSES

Inflicting of metal coating is usually perform in acidic electrolytes whose composition is essential in terms of the composition of waste water, because after inflicting metallic coatings perform mandatory flushing [4,5]. The basis of acidic electrolyte is hydrated metal salt which is inflict to increase the conductivity of the electrolyte used acid to the sulfuric copper and chromium for a nickel and cadmium boric acid. The composition of the electrolyte in and surface-active substances that enhance the quality of the finished product. Table 1 shows the installed lines of metal surface protection and character of wastewater in individual cases.

**Table 1.** Lines of surface protection and nature wastewater

Line	Procedures	Industrial solutions	Waste water
1	Anodization and chromotisation	NaOH; sf <sup>1)</sup> ; fdw <sup>2)</sup> ; sf; HNO <sub>3</sub> ; Anodna ox in H <sub>2</sub> SO <sub>4</sub> ; Anodic ox in CrO <sub>3</sub> ; sf; fdw; K <sub>2</sub> Cr <sub>2</sub> O <sub>7</sub> ; silage in H <sub>2</sub> O; Preparation Mg; sf; fdw; Chromotisation Mg i Chromotisation Al.	Alkaline and acidic Acidic Chromic
2	Zinc plating and cadmium plating	E-deg <sup>3)</sup> ; sf; fdw; sf; HCl; Acid-chloride Zn; sf; fdw; Passivation: blue; (fdw); Cd; SMB (fdw) and black passivation. <i><sup>1)</sup>-savings flushing; <sup>2)</sup>-flushing demi water; <sup>3)</sup>-electrochemical degreasing</i>	Alkaline and acidic Acidic Alkaline Chromic Cyanide
3	Nickel plating	E-deg; sf; fdw; sf; H <sub>2</sub> SO <sub>4</sub> ; Film Ni; Nickel plating (Wattsov tipe); sf; fdw; sf.	Alkaline and acidic Acidic
4	Hard chromium plating	sf; fdw; Hard chromium plating; Sulfochromic acid; Removing Cr fdw.	Chromic Acidic
5	Silver plating and copper plating	E-deg; sf; fdw; sf; HCl; Film Ag; Silver plating; sf; fdw; Na <sub>2</sub> Cr <sub>2</sub> O <sub>7</sub> ; fdw; Cyanide copper plating; sf; fdw; Removing Ni.	Cyanide Acidic Alkaline and acidic Chromic
6	Hand lines for different procedures	NaOH; fdw; Zinc plating; fdw; KCN; HNO <sub>3</sub> ; HNO <sub>3</sub> -passivation; fdw; Ni- sulphate nickel plating; sf; fdw.	Cyanide Acidic Alkaline Chromic
7	Burnishing and phosphating	E-deg; sf; fdw; sf; H <sub>2</sub> SO <sub>4</sub> ; Phosphating; sf; fdw Burnishing; sf; fdw; Oiling; KMnO <sub>4</sub> ; sf; fdw.	Acidic Alkaline NO <sub>2</sub> / Alkaline

Figure 1 provides an overview of the drive electroplating and chemical protection in „ORAO“ a.d. Bijeljina.



**Figure 1.** Drive electroplating and chemical protection in „ORAO“ a.d. Bijeljina (July 2012 image N.Bratić)

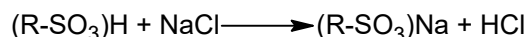
#### **PROCEDURES WASTEWATER TREATMENT GALVANIC-CHEMICAL PROCESSES**

Plant for waste water from the line of surface protection (Table 1) consists of:

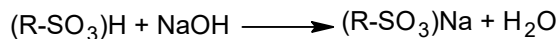
- cylindrical facilities with ion exchangers for flush water without  $\text{CN}^-$  (line anodizing and chromium plating, galvanizing and cadmiumization; nickel; burnishing and phosphating)
- cylindrical plant with ion exchangers for  $\text{CN}^-$  - flush water (lines silvering and copper plating, hand lines for different procedures)
- collectors concentrate
- Batch processing waste water
- filtering sludge
- Selective cleaning Cd,
- Selective cleaning without Cd;
- Final neutralization and
- Final pH control.

After galvanic processes, flushing water (after lushing with demi  $\text{H}_2\text{O}$ ) free fall touch in collector circular water from there, through the filter cartridge transferred to the column with ion exchangers.

The cation exchanger in the water present cations are replaced with  $\text{H}^+$  ions in whereby, as a result of this change resulting free acid corresponding to the salt content in flushing water, ie.

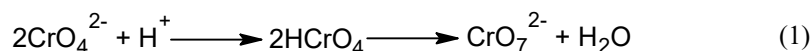


The anion exchanger can replace the anions  $OH^-$  ions, ie.

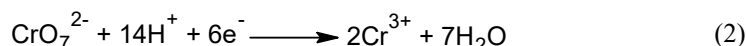


Regeneration of cation exchanger is performed with HCl and anions with NaOH. Purified water at the exit of the ion exchange, the quality corresponds to distilled water and, as such, is back *in the tub to flushing*. The waste concentrates from the line and regenerates ion exchange is collected in *tanks concentrate*. Because of the great diversity of processing operations, concentrates are collected individually. So we have: a tank of acid concentrate, base, tank  $NO_2$  concentrate Ni concentrate, acid concentrate of Cd concentrate, Cr concentrate, the tank of CN concentrate and tank CN concentrate Cd. From tanks concentrates are transferred to the appropriate *bath batch processing*, where on the basis of the composition of the concentrate, performs its processing: reduction of chromate ( $Cr^{6+}$  u  $Cr^{3+}$ ), nitrite oxidation, oxidation cyanide and neutralization and felling heavy metals.

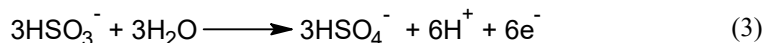
**The reduction of chromate ( $Cr^{6+}$  u  $Cr^{3+}$ ):** Chromic waste water containing a neutral and alkaline range  $Cr^{6+}$  in the form  $CrO_4^{2-}$  and in acidic range  $Cr_2O_7^{2-}$ . Chromate in an acid range passes over a transitional form of hydro-chromate and dichromate in water:



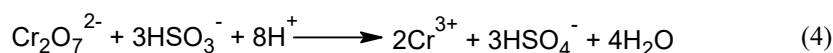
$Cr^{6+}$  reduction is achieved by adding an appropriate reducing agent, sodium bisulfite,  $NaHSO_3$ . For each gramata  $Cr^{6+}$  takes 3 electron-equivalents ie.



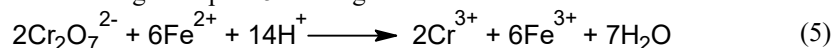
To obtain 6 electron-equivalents, it is necessary to add 3 electron-equivalents  $NaHSO_3$ , ie.



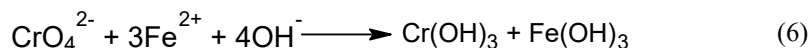
Summing equations 1 and 2 we get:



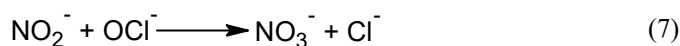
Reaction time is 15-20 minutes. As a reducing agent, often used and ferrous sulphate,  $FeSO_4$ . In the acidic range at a pH <5 running the reaction:



while in the base area at a pH value of 8.5 - 12 running the reaction:



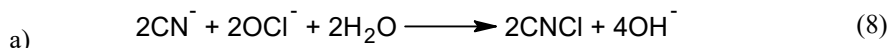
**Oxidation nitrite,  $NO_2^-$ :** Decontamination  $NO_2$  is achieved by a solution of  $NaOCl$  (*with 13 – 15% active Cl*).



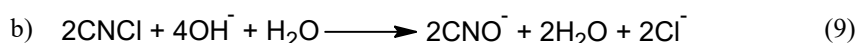
The reaction was run at pH 3-4, the reaction time is about 10 min.

**Oxidation of cyanide, CN<sup>-</sup>:** Cyanide waste water containing free and complex related cyanides.

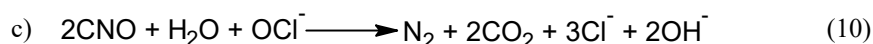
Decontamination CN achieve with solution NaOCl (13-18% active Cl). The reaction mechanism takes place in three steps:



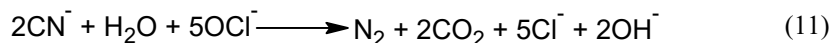
(the reaction is very fast and flowing at all pH values. The resulting Chlorinecyan is extremely toxic, therefore the next step in translating the cyanate):



(hydrolysis reaction is slow and exothermic, reaction rate depends on the pH and the fastest at pH 10.5 - 12). The required pH is achieved by addition of NaOH or Ca(OH)<sub>2</sub>. The time required for the I and II step is 40 - 60 minutes.



In the third step, the cyanate is converted into N<sub>2</sub> and CO<sub>2</sub>. The general equation (general course) oxidation CN:



Decontamination of CN - metal complexes is highly dependent on their ability dissociation (in reaction involved only dissociated CN).



(For decontamination of metal complexes such as Zn, Cd or Cu has no special problem, while a longer reaction time and a higher content of the oxidizing agent from the complexes of Fe and Ni).

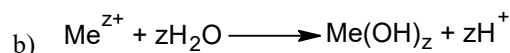
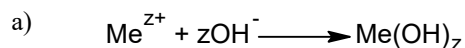
Time is 90 minutes or more, whereby it takes up 100% of oxidizing agent, ie. NaOCl.

**Neutralization and felling of heavy metals:** Acid and alkaline waste water have an aggressive character. Their partial neutralization is perform by mixing them together and complete neutralization with the addition of neutralizing agent. Next to the free acids and bases of the waste water containing the heavy metal ions.

The neutralization of the free acids and bases running by the reaction:



Next to the neutralization is carried out and precipitation of heavy metals (Fe, Zn, and Cr) in the form of metal hydroxides or metal alkaline salt.





(for felling metal at a pH above 7 corresponds to the equations a) and below pH 7, equation b). Best pH value for the quantitative felling is between 7.5 - 9.5 with an optimum at pH 9.2.

The precipitated  $\text{Fe}(\text{OH})_3$  serves simultaneously as a flocculant for other impurities. Each Me-ion having a specific pH-value at which the best secreted as MeOH and precipitated in the form of sludge.. Thus, Fe (III) bring down already in the acidic range, Cr (III) at pH <8, Zn (II) at pH> 8.5 and Ni at pH> 9.5. The optimum pH value is 9.2. The reaction takes place with intensive stirring. After the treatment is performed in the *filter sludge on filter presses*. The clear filtrate was sent to the corresponding *selective cleaning tank* and the resulting sludge was packed in filter bags and disposed appropriately. In the column with the selective exchange resin (has a high affinity for heavy metals) on the resin present heavy metals is replaced with the metal  $\text{Na}^+$  - ions. When the resin is saturated need of regeneration. Regeneration is perform using HCl and NaOH.

Treated water from *selective cleaning* flowing into the bath of final neutralization where perform correction of pH before being discharged into the drain. Maintained the pH value between 7 - 9 and is regulated with HCl and NaOH. The water from final neutralization flowing into the *final control of pH*. In case of deviation pH value, the alarm goes and turn off the pump selective cleaning. In this way is prevented that improperly treated waste water flows into the drain.

### MOIST AIR FILTERS WITH EXCRETOR DROP

Dimensioned facility for air purification achieves the required level of allocations at different loads of sources with the highest concentrations of polluting components [1,3]. Installed facility for moist cleaning of polluted air galvanic-chemical processes being composed of three filters (absorption column): acid-alkaline, chromium and cyanide.

From surface area of industrial solutions, depending on the type and composition of polluted air, perform his extraction in the installed purifiers.

Figure 2 provides an overview of the moist air filters with excretor drop, DV 270 [1].

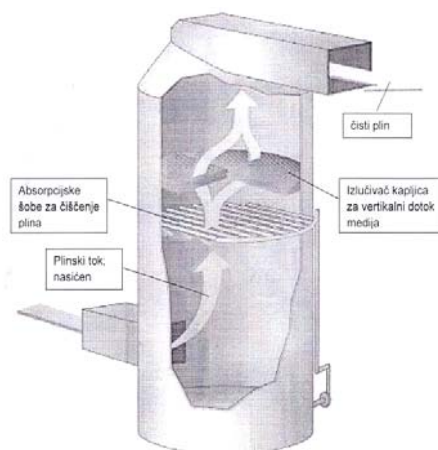


Figure 2. Moist air filters with excretor drop, DV 270

The basis of the process of removing gaseous pollutants from exhaust gases make the absorption process in which the first bonding performs gaseous components of the absorption means. Surface necessary to modify the matter is formed on the film of fluid which leaking on the surface charging downward (transition impurities in the liquid phase).

In the filter in which clean acid - alkaline gases pH correction depends on the content of acid or alkaline gases (pH of 9.5 to 11.5). Acidic output gases are neutralized by adding solution NaOH and basic, with adding solution H<sub>2</sub>SO<sub>4</sub>. In purifiers Cr and CN-gases add solution of NaOH.

### EXPERIMENTAL PART

After the above described treatment of waste water produced in the lines galvanic-chemical protection, from a *buffer reservoir*, in which the water is stored before discharge, the water sample was taken. Water analysis is perform in laboratories authorized by the Ministry of agriculture, forestry and water management of the Republic of Srpska, "Institute for Water" doo Bijeljina. The paper presents the results of the analysis of two quarters of the previous year, a water analysis from this facility is done four times a year.

Measurements and analysis of emissions of air pollution have been perform in laboratories authorized by the Ministry of physical planning, civil engineering and ecology of the Republic of Srpska "Master" doo. PJ. "Master Institute" Banja Luka. The results of measurements of air pollution emissions (one-day measurement pollutants with mobile ecological station, MES) in three measuring points (the roof galvanic-chemical protection) are shown in Table 3. The mobile laboratory during the measurement was placed in the area of electroplating. The readings of air pollution were processed and analyzed in accordance with the Regulations on limit values of air quality (Official Gazette of the Republic of Srpska, number 39/2005). During the measurement of the prevailing cold and cloudy weather. Daily air temperature during the measurements ranged from 15.10 °C to 15.30 °C at 68% humidity. Wind is conditioned by the seasons and the configuration of the terrain and geographical location of the measurement area. The wind was moving from the southwest at an average speed 1.2 m / s.

### RESULTS AND DISCUSSION

Results of the analysis of purified water are shown in Table 2.

**Table 2.** Results of the analysis of water after treatment at the facility galvanic-chemical protection

Test parameter	Test method	Unit of measure	Result		Allowed values of parameters
			I measuring	II measuring	
1.	2.	3.	4.	5.	6.
pH	BAS ISO 10523:2002	-	7.49	7.07	6.5-9.0
HPK (O <sub>2</sub> bichrom.)	Standard methods 5220-D (APHA-AWWWA-WEF) 2005.	g/m <sup>3</sup>	<5.0	<5.0	125
BPK <sub>5</sub> (diluting and dispersal)	BAS EN 1899-1:2002	g/m <sup>3</sup>	1	0.59	25
Total susp. matter	BAS ISO 11923:2002	g/m <sup>3</sup>	<1.0	<1.0	25
NH <sub>3</sub> -N	BAS ISO 7150-1:2002	g/m <sup>3</sup>	0.05	0.06	10
NO <sub>3</sub> -N	BAS EN 10304-1:2002	g/m <sup>3</sup>	3.93	5.14	10
NO <sub>2</sub> -N	BAS EN 26777:2002	g/m <sup>3</sup>	<0.002	<0.002	1
Total N by Kjeldahl	BAS EN 25663:2000	g/m <sup>3</sup>	1.64	<0.5	-
Total N	Calculating the content of ammonium nitrate nitrogen by Kjeldahl	g/m <sup>3</sup>	5.57	5.64	15
Precipitation	Stand. methods 5220D (APHA-AWWWA-WEF) 2005.	ml/l	<0.5	<0.5	5
Total P	BAS ISO 6878:2002	g/m <sup>3</sup>	-	0.01	3
Fluorides	BAS EN ISO 10304-1:2002	g/m <sup>3</sup>	0.78	0.83	2
Sulphates	BAS EN ISO 10304-1:2002	mg/m <sup>3</sup>	24.14	27.46	200
Chlorides	BAS EN ISO 10304-1:2002	mg/m <sup>3</sup>	33.7	34.3	250
Iron	Standard methods 3111-B- (APHA-AWWWA-WEF) 2005.	g/m <sup>3</sup>	<0.03	<0.03	2
Silver	Standard methods 3113-B-APHA-AWWWA-WEF 2005.	mg/m <sup>3</sup>	0.33	1.91	50
Total chrome	BAS ISO 9174:2002	mg/m <sup>3</sup>	2.3	5.09	100
Copper	Standard methods 3113-B-APHA-AWWWA-WEF 2005.	mg/m <sup>3</sup>	2.32	3.39	300
Nickel	Standard methods 3111-B- (APHA-AWWWA-WEF) 2005.	mg/m <sup>3</sup>	7.73	0.55	10
Zinc	Standard methods 3111-B- (APHA-AWWWA-WEF) 2005.	mg/m <sup>3</sup>	29.32	-	1000
Cadmium	Standard methods 3111-B- (APHA-AWWWA-WEF) 2005.	mg/m <sup>3</sup>	<0.03	0.15	10
Precipitation	Standard methods 3111-B- (APHA-AWWWA-WEF) 2005.	ml/l	<0.5	<0.5	
1.	2.	3.	4.	5.	6.
Hexavalent chromium	Standard methods 3111-B- (APHA-AWWWA-WEF) 2005.	mg/m <sup>3</sup>	1.98	4.91	100
Cyanides	Spectrofotometer PC spectroll Lovibond-Piridin-barbiturna kisel. 156	g/m <sup>3</sup>	<0.01	<0.01	0.1
Sulfites	Spectrofotometer PC spectroll Lovibond 368	g/m <sup>3</sup>	<0.05	<0.05	1

According to the test results shown in table 2, were obtained parameter values below the limit values shown in the Regulations on the conditions for discharging wastewater into surface waters (Official journal of the Republic of Srpska No 44/2001).

**Table 3.** Results of measurements of air pollution

Test parameter	Test method	Unit of measure	Result			References value
			Measuring point 1	Measuring point 2	Measuring point 3	
SO <sub>2</sub>	SMEWW 19 <sup>th</sup> 4501-SO <sub>x</sub> B	µg/m <sup>3</sup>	46	43	41	90
NO <sub>2</sub>	SMEWW 19 <sup>th</sup> 4501-NO <sub>x</sub> B	µg/m <sup>3</sup>	29	23	28	85
Chlorine	BAS ISO 92973:2003	µg/m <sup>3</sup>	<1	<1	<1	50
Chrome	SMEWW 19 <sup>th</sup> 4501-Cr <sub>x</sub> A	µg/m <sup>3</sup>	41	28	41	100
Cadmium	UMH 039	µg/m <sup>3</sup>	6	19	7	20
Cyanides	SMEWW 19 <sup>th</sup> 4500-B	µg/m <sup>3</sup>	9	11	39	50

The results of the measurements emissions of air pollution, table 3 (one-day measurement pollutants with mobile ecological station, MES), are in accordance with the values prescribed in the Regulations on limit values of air quality (Official journal of the Republic of Srpska, No. 39/2005).

### CONCLUSION

From the ecological engineering aspects, a suitable combination shown chemical and physico-chemical processes of wastewater treatment and based on received results of water which has gone through the shown described treatment, obtained satisfactory quality of treated water, which are, according to current legislation in the Republic of Serbian in the Republic of Srpska, can be discharged, in the public sewage system, also in surface water. According to the results of measurements of air pollution at three measuring points of the object galvanic-chemical protection obtained significantly lower values compared to the prescribed legal regulations.

In this way, the shown aspect of our responsibility towards the environment is filled.

### REFERENCES

1. "Plaming" Project documentation: "Electroplating and wastewater treatment" Instructions for operation and maintenance, P 1129; Map 1/5, 2012.

2. I. Krstić, M. Stanisavljević, V. Lazarević, L.J. Takić: Redesigning wastewater treatment technological process of galvanization, (II) Engineering, ecology and materials in process industry, Jahorina, 2011.
3. M. Pavlović: Ecological Engineering (II): Technical Faculty "Mihajlo Pupin", Zrenjanin, 2011.
4. B. Arsenović: Industrial waste water treatment with a special aspect on waste water galvanic chemical process: Independent University of Banja Luka, Faculty of Ecology, 2013
5. B. Arsenović: Some question of the treatment waste water and air pollution procedures galvanic-chemical protection: III International Congress: Engineering, Materials and Ecology in the process industry, Jahorina 2013.
6. B. Arsenović: Program verification testing of in the drive galvanic-chemical protection; OP-26-00-005 SLIM/P „ORAO“ a.d. Bijeljina, 2011.
7. B. Arsenović: „Report on the verification testing in the drive galvanic-chemical protection OP-26-00-008; SLIM/P „ORAO“ a.d. Bijeljina, 2013.
8. B. Arsenović: „Work with harmful and dangerous materials“: 052/88-LQ-96, SLIM/P, "ORAO", a.d. Bijeljina, 2012.
9. Official journal the Republic of Srpska No. 44, 2001.
10. Official journal the Republic of Srpska No. 39, 2005.
11. B. Arsenović: Instructions for controlling the composition of the solution galvanic chemical protection and solutions in laundry: 052/LQ-44, SLIM/P, "ORAO", a.d. Bijeljina, 2008.
12. „ORAO“ a.d. Bijeljina: „The decision on the appointment of Supervisory Authority (appointed B. Arsenović) for supervision of works on installation of equipment for galvanic chemical protection and waste water treatment in the facility for repair parts in „Orao“ a.d. Bijeljina; N<sup>o</sup> 042/57-18 from 16.05.2012.
13. B. Arsenović: "Some questions morphology and structure of electrochemically sedimented metal coating "; Doctoral dissertation; december 2008.



## WATER QUALITY AND ECOLOGICAL STATUS OF THE TRIBUTARIES OF WESTERN MORAVA IN THE ČAČAK AND KRALJEVO REGION

Vesna Djurovic<sup>1</sup>, S. Tanaskovic<sup>1\*</sup>, D. Djukic<sup>1</sup>, L. Mandic<sup>1</sup>,  
S. Gvozdenac<sup>2</sup>, D. Knezevic<sup>3</sup>

<sup>1</sup>University of Kragujevac, Faculty of Agronomy, Cara Dušana 34, Čacak, SERBIA

<sup>2</sup>University in Novi Sad, Faculty of Agriculture, D. Obradovića 8,  
21 000 Novi Sad, SERBIA

<sup>3</sup>University of Pristina, Faculty of Agriculture, Kosovska Mitrovica-Lesak,  
Kopaonicka bb, Kosovo and Metohija, SERBIA

\*[stanasko@kg.ac.rs](mailto:stanasko@kg.ac.rs)

### ABSTRACT

Surface water quality and ecological status assessment of the tributaries of the Western Morava was evaluated. It includes analysis of microbiological and physico-chemical parameters. Analyzed samples were taken at locations Musina River in the village of Adrani, Lađevačka River in the village Lađevci and Bresnička River in the village Mrčajevci, Serbia. The obtained microbiological parameters show that the highest number of all investigated parameters was determined in surface water of Bresnička River and the smallest of Musina River. Based on the physico-chemical parameters and values of ammonium ions ( $\text{mg NL}^{-1}$ ) all three rivers had moderate ecological status and belonged to class III according to national regulations.

**Key words:** water quality, physico-chemical, microbiological parameters.

### INTRODUCTION

Water is the source of life and a resource that will mark the twenty-first century, in a manner as it was the case with oil in the twentieth century. The increase of human population on Earth and the growing need for water, suggests that the Earth is approaching a water deficit [1].

The oldest known wells originate from Mesopotamia (around 4000 years BC) and the first water supply system was built in Jerusalem during the rule of king Solomon, 1000 years BC. That water is a key element in the survival of civilization which was recognized by ancient Egyptians and people of Mesopotamia, which is the reason why they settled near water bodies [2].

Rational utilization of water resources is one of the most important issues of contemporary society. Surface water, water sources or depth layers of hydrogeological systems are used for water supply [3]. The quality of drinking water or food production depends on the origin and quality of raw water, the quality of water sources as well as the number of consumers. Chemical and oil industry, metallurgy, and power industry are

large consumers of water, but also the large amounts of water are spent on irrigation and livestock maintain complex [4]. The development of techniques and technology, industrialization and urbanization have contributed to the quality of life but also a large degradation of nature through the contamination of water, air, soil, destruction of biocenosis and the ozone layer [5]. Contamination of natural waters can be a chemical (heavy metals, pesticides, oil, mineral salts, and detergents), biological (pathogenic microorganisms and viruses), physical (solid waste, noise, and vibration), visual contamination (concreting river banks) and radioactive (nuclear tests, accidents) [6]. Since the industrial revolution, until today the increase of water pollution and contaminants is recorded. Recovery and purification of natural water resources are needed for decades [1]. When we talk about the importance of water for the human consumption, first we think of it physiological, hygienic, eco-biological, toxicological and epidemiological significance [7, 8]. Getting hygienic water becomes a real challenge for a human race. The goal of this work is to show by analysing obtained results for tested parameters, whether the tested water can be used for irrigation.

## MATERIAL AND METHOD

Tributaries of the Western Morava i.e. Musina, Lađevačka, and Bresnička River are used for status determination of surface water quality and ecological status assessment. It includes analysis of microbiological and physico-chemical parameters. Microbiological parameters comprehend number of total coliforms, fecal coliforms number-*E.coli*, and the number of fecal enterococci. Physico-chemical parameters include T, pH value, dissolved oxygen, biochemical oxygen demand (BOD<sub>5</sub>), total organic oxygen, ammonium ion, nitrate, orthophosphate, total phosphorus and chloride. Water samples were collected at locations Musina River in the village of Adrani (L1), Lađevačka River in the village Lađevci (L2), and Bresnička River in the village Mrčajevci (L3).

Samples were taken in April 2016. The tested parameters were determined by standard methods. The analysis was conducted by Institute for Public Health in Čačak.

Assessment of surface water quality was carried out on the basis of national regulations [9, 10, 11]. National regulation allows the use of water from I to IV classes for irrigation [9].

## RESULTS AND DISCUSSION

Microbiological characteristics of water are an important indicator of water quality. Most microorganisms, especially certain types of bacterial and protozoa are essential for biological treatment. However the presence of pathogenic bacteria, some protozoa and viruses is undesirable because they are harmful to human and animal health [12, 13].

**Table 1.** Results of microbiological analysis

Microbiological parameters for assessment of ecological status	Unit of measure	Obtained value		
		L1	L2	L3
Number of total coliform bacteria	MPN/100 mL	6050	12800	26050
Number of fecal coliform bacteria- <i>E.coli</i>	MPN/100 mL	<500	500	2600
Number of fecal enterococci	MPN/100 mL	<40	40	476

MPN-the Most Probable Number

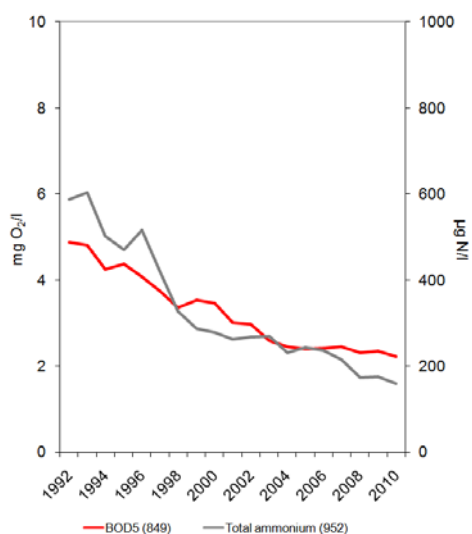
&lt; - the absence of microorganisms in units

Based on the obtained microbiological parameters (Table 1) it can be concluded that the largest number of total coliform bacteria, the number of fecal coliforms and fecal enterococci was determined in surface water - L3 and the smallest number in surface water L1. Based on the results of physico-chemical analysis (Table 2) and the value of the ammonium ions expressed in  $\text{mg N L}^{-1}$  all three rivers had moderate ecological status and belonged to the class III of water quality (limit values for Class III: Ammonium ions =  $0.6 \text{ mg N L}^{-1}$ ) [9]. Special attention was given to the indicator BOD<sub>5</sub> in surface waters - the indicator monitors the concentrations of biochemical oxygen demand (BOD<sub>5</sub>) in rivers and provides a measure of the status of surface water in terms of biodegradable organic load. Obtained levels of BOD<sub>5</sub> are expressed in  $\text{mg O}_2\text{L}^{-1}$  and were: 3 at the location (L1) and 2 on locations (L2 and L3). On the basis of the test BOD<sub>5</sub> water belong to the class II ecological status. The limit value for Class II: BOD<sub>5</sub> =  $4.5 \text{ mg O}_2 \text{ L}^{-1}$ [9]. The obtained results: ammonium ion (class III), and BOD<sub>5</sub> (II), the total phosphorus and orthophosphates (I-class II), nitrate (I-II) and I chlorides (I) are in accordance with the [14].

**Table 2.** Results of physico-chemical analysis

No	Parameters of analysis	Unit of measure	Obtained value			Class of ecological status				
			L1	L2	L3	I	II	III	IV	V
1.	Temperature	°C	13.7	14.1	13.9					
2.	pH value 20.8°C	/	8.4	8.4	8.4	6.5-8.5				<6.5; < 8.5
3.	Dissolved oxygen		12.6	10.7	11	8.5	7.0	5	4	<4
4.	Biochemical oxygen demand (after 5 days)	$\text{mg O}_2\text{L}^{-1}$	3	2	2	1.8	4.5	7	25	>25
5.	Total organic carbon	$\text{mg L}^{-1}$	5.6	8.5	1.1	2.0	5.0	15	50	>50
6.	Ammonium ion	$\text{mg N L}^{-1}$	0.2	0.2	0.2	0.05	0.1	0.6	1.5	>1.5
7.	Nitrates		<1	1.5	<1	1.5	3.0	6	15	>15
8.	Orthophosphates	$\text{mg P L}^{-1}$	0.06	0.15	0.1	0.02	0.1	0.2	0.5	>0.5
9.	Total phosphorus	$\text{mg L}^{-1}$	0.07	0.2	0.2	0.05	0.20	0.4	1	>1
10.	Chlorides		12.8	12.4	16.2	50	100	150	250	>250

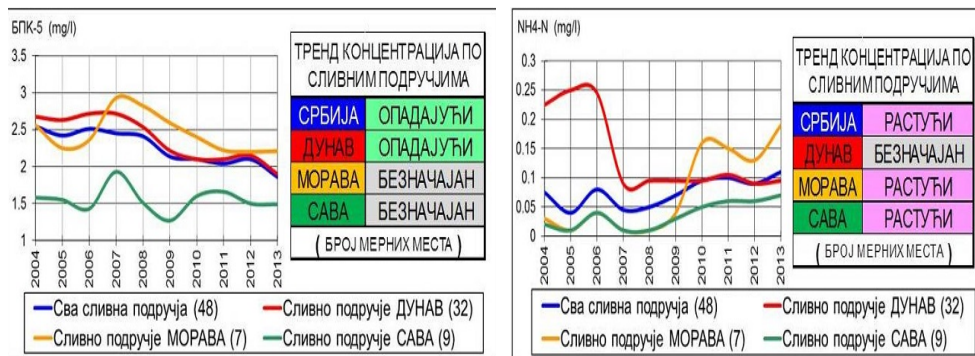




**Chart 1.** Biochemical Oxygen Demand (BOD<sub>5</sub>) and total ammonium concentrations in rivers between 1992 and 2010 (European Environmental Agency) [15]

In European rivers, the oxygen demanding substances measured as BOD and total ammonium have decreased by 55 % (from 4.9 mg L<sup>-1</sup> to 2.2 mg O<sub>2</sub> L<sup>-1</sup>) and 73% (from 587 to 159 µg N L<sup>-1</sup>), respectively, from 1992 to 2010 (Chart 1) [15].

Comparing the data of the European Environmental Agency on the quality of European rivers and data of the Agency for environmental protection of the quality of our rivers date on the basis of parameters BOD<sub>5</sub> (Serbia 2.5 mg L<sup>-1</sup>, Western European rivers 1.5 mg L<sup>-1</sup>, Eastern European rivers 3 mg L<sup>-1</sup>) indicate that the quality of our rivers is better than the Eastern European rivers [16].



**Chart 2.** Median concentrations of BOD<sub>5</sub> and ammonium in rivers catchment areas of the Republic of Serbia [16]

The obtained results show that the analyzed water samples can be used for irrigation in order to reduce the effects of drought, and thus achieve high and stable yields and appropriate quality in agriculture. Investigated area represents the region where the grain crops are grown. Also in this area vegetable crops are intensively cultivated. So these data allow the safe use of water from small rivers for irrigation during the summer months because the water becomes necessary. This is especially important because most of farmers use the sprinkler irrigation system, they don't have the drip irrigation system.

#### **Acknowledgement**

*We express gratitude to Company „Putevi” Čačak for the provided data.  
This work is part of Project TR 31092 financed by Ministry of education, science and technological development.*

#### **REFERENCES**

1. Todd, D.K.: The Water Encyclopedia, Water Information Center, Port Washington, New York. 597 pag. (1970).
2. Voda-izvor održivog razvoja, inženjeri zaštite životne sredine 2011-Novi Sad, ISBN: 978-86-87145-07-8192 str. (2011).
3. Marjanović, T.: Karakteristike vode za piće sa aspekta zdravstvenog rizika objekta za centralno vodosnabdevanje u Požarevcu za period 2005-2009., Medicinski fakultet, Beograd (2010). (in Serbian).
4. Đukić, A.D., Ristanović M. V.: Hemija i mikrobiologija voda, Stylos, Novi Sad, 447 str. (2005). ISBN-13: 978-86-7473-205-2, ISBN: 86-7473-205-4.
5. Gavrilović, Lj., Lješević, M.: Voda kao uslov života i prirodni resurs, Zbornik radova sa Konferencije, Voda za XXI vek”, Udruženje za tehnologiju vode i sanitarno inženjerstvo, Beograd (1999). (in Serbian).
6. Milojković, S. Fizičko-hemijska i mikrobiološka ispravnost vode za piće u seoskim naseljima na teritoriji grada Požarevca, Specijalistički rad, Poljoprivredni fakultet, Univerzitet u Beogradu, 169 str. (2014).
7. Panić, I.: Ispitivanje opštih fizičko-hemijskih i radiohemijskih osobina voda Mataruške, Selters i Vrnjačke banje, Diplomski rad, Fakultet za fizičku hemiju, Beograd. (2009). (in Serbian).
8. Rajković, M.B.: Hemijske metode analize, autorizovana skripta, samostalno izdanje (M. B. Rajković), Zemun. (2010). (in Serbian).
9. Uredba o graničnim vrednostima zagađujućih materija u površinskim i podzemnim vodama i sedimentu i rokovima za njihovo dostizanje (Sl. glasnik RS 50/12). (in Serbian).
10. Pravilnik o parametrima ekološkog i hemijskog statusa površinskih voda i parametrima hemijskog i kvantitativnog statusa podzemnih voda, (Sl. glasnik RS 74/11); (in Serbian).

11. Pravilnik o nacionalnoj listi indikatora zaštite životne sredine (Sl. glasnik RS 37/11). (in Serbian).
12. Mašala A.: Bakteriološke osobine vode jezera na području Tuzlanskog kantona Veterinaria 58 (3-4), 219-228, Sarajevo (2009).
13. Nikolić S., Mojović Lj., Nikolić B., Sekulić Lj., Milovanović D.: Zagađivači i kvalitet vode reka Veliki lug i Kubršnica na teritoriji opštine Smederevska palanka, UDK: 551.482.213/214.Vodoprivreda 0350-0519, 43, 252-254 p. 259-265 (2011) .
14. Rezultati ispitivanja kvaliteta površinskih i podzemnih voda za 2013. godinu: Agencija za zaštitu životne sredine, Beograd, 408 str. (2014).
15. <http://www.eea.europa.eu/data-and-maps/indicators/oxygen-consuming-substances-in-rivers/oxygen-consuming-substances-in-rivers-5>
16. <http://indicator.sepa.gov.rs>



## CALCULATION OF THE SEDIMENT YIELD OF THE COLOVICA BROOK CATCHMENT, WESTERN SERBIA

Gordana Sekularac<sup>1\*</sup>, R. Ristic<sup>2</sup>, D. Markovic<sup>1</sup>

<sup>1</sup>University of Kragujevac, Faculty of Agronomy, Cacak, SERBIA

<sup>2</sup>University of Belgrade, Faculty of Forestry, Belgrade, SERBIA

\*[gordasek@kg.ac.rs](mailto:gordasek@kg.ac.rs)

### ABSTRACT

This study involves the evaluation of soil erosion within in small catchment within the Kamenica catchment, part of the Zapadna Morava catchment.

As regards the initiation of the wearing away of soil particles from the catchment slope, standard methods were used to quantify soil erosion. The aim of this study was to evaluate erosion factors in the catchment area of the Čolovića brook, classified as a dry valleys and small flash flood. The annual erosion intensity is 95.18 m<sup>3</sup> km<sup>-2</sup> of soil. Based on natural and anthropogenic factors, the Čolovića brook catchment area belongs to erosion category IV, weak intensity, deep type, with the erosion coefficient of 0.35.

**Key words:** sediment yield, catchment, erosion intensity, dry valleys and small flash flood.

### INTRODUCTION

Land degradation and soil loss are global events. Human induced pressures on natural ecosystems are still in progress, along with conservation efforts [1]. The main factor causing soil degradation worldwide is water erosion, which threatens 56% of the world's arable land [2].

Over 90% of the total land area in the Republic of Serbia suffers from different types and intensities of erosion [3]. The erosion process can have both direct and indirect impacts, inducing permanent soil disappearance. The calculated value of the total annual sediment yield suggests that some 16.0 cm of soil are annually eroded off the 21,000 ha of land in Serbia [4]. In the Republic of Serbia (Central Serbia), there are 1.221 million ha of eroded soil, and 36,000 ha are in a steady state, now [5].

Erosion has mostly affected strongly sloping, deforested or cultivated shallow soils on slopes, formed on impermeable geological substrates, due to the effects of intense rainfall and fluctuating air temperatures [4].

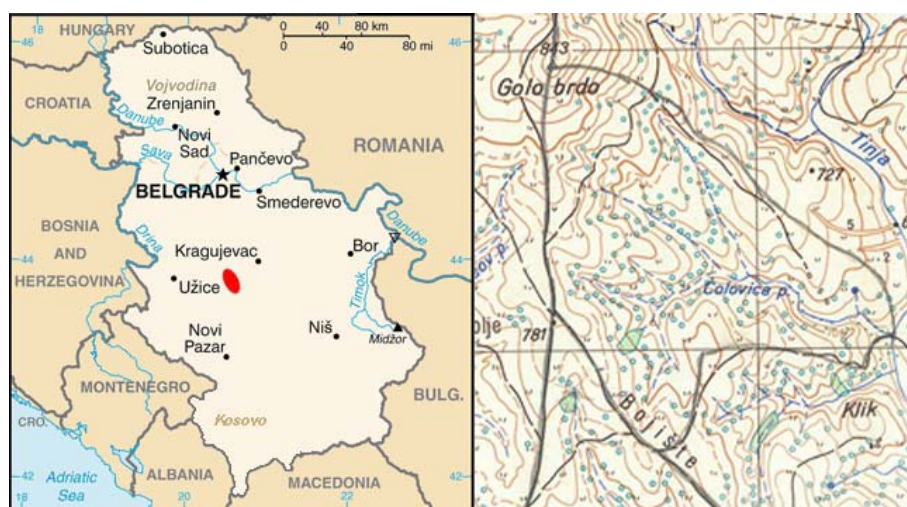
The tendency of air temperature to increase and of rainfall to decrease is quite evident in the region of Čačak [6]. Climate change leads to degraded soil physical properties, increases soil erodibility and reduces the protective role of vegetation.

The above factors cause intensification of both surface and deep-cutting processes of erosion.

Given the above, the objectives of this study are quantitative assessment of soil erosion induced by a range of factors and estimation of sediment yield in one part of the catchment area of the Kamenica River (part of the Zapadna Morava catchment), i.e. its subbasin the Tinja, including its second order left-hand tributary the Čolovića brook.

## MATERIALS AND METHODS

The Čolovića brook is located near Čačak ( $43^{\circ} 53' N$ ;  $20^{\circ} 21' E$ ), Western Serbia, and belongs to the catchment of the Zapadna Morava river.



**Figure 1.** The Čolovića brook catchment

Natural characteristics of the Čolovića brook basin were studied using map data (hydrography, relief, geological substrate and soil), literature data (elements of climate: rainfall and air temperature) and data obtained through an immediate reconnaissance survey of the area (vegetation).

Maps of the studied area have the following scale: topographic map (1:25,000 Figure 1; 1:50,000) [7], geological map (1:500,000) [8] and pedological map (1:50,000) [9].

Meteorological parameters for the catchment area were calculated using the method of interpolation of rainfall data [10] by the rainfall gradient [11], and air temperature [12] calculations for any altitude [13].

Erosion-induced soil losses can be predicted by various analytical models.

However, according to the experience of a number of researchers, the Erosion Potential Method – EPM [14] is the most suitable on catchment level for watershed management purposes in this Region and is used in: Bosnia & Herzegovina, Bulgaria, Croatia, the Czech Republic, Italy, Iran, Montenegro, Macedonia, Serbia and Slovenia

[15; 16; 17]. This is why quantitative indicators of soil erosion in this research were calculated using the Erosion Potential Method - EPM.

The basic analytical equation (1) for the calculation of erosion-induced soil losses, as developed [14], is as follows:

$$G_{yr \times sp^{-1}} = T \times H_{yr} \times \pi \sqrt{Z^3} \times R_u \quad (1)$$

where:

$G_{yr \ sp^{-1}}$  – specific annual total erosion-induced sediment yield reaching the confluence,  $m^3 \ yr^{-1} \ km^{-2}$

T – temperature coefficient of the catchment

$H_{yr}$  – amount of rainfall, mm

$\pi$  – 3.14

Z – coefficient of erosion

$R_u$  – coefficient of retention of soil in the catchment.

## RESULTS AND DISCUSSION

The size, length, circumference and shape (perimeter) of a catchment area are among major catchment elements of importance for soil erosion. The Čolovića brook catchment is 0.83  $km^2$  in area (F), 4.10 km in length (L), and 1.07 km in circumference (C).

The major physical and geographical elements of the Čolovića brook catchment, relief characteristics, geological substrate features, soil type and soil utilisation method, are quantitative parameters or soil erosion in the catchment.

**Table 1.** The basic parameters of the Čolovića brook catchment relief

Catchment name: The Čolovića brook	
The lowest point of the main watercourse and catchment (B), m	673
The highest point of the main watercourse (C), m	761
The highest point of the catchment (E), m	843
Average slope of the main watercourse in the catchment ( $I_a$ ), %	7.0
Mean catchment altitude ( $A_m$ ), m	743.26
Mean catchment altitudinal difference (D), m	70.26
Mean catchment slope ( $I_m$ ), %	15.3
Coefficient of catchment relief erosion energy ( $E_r$ ), $m \ km^{-1/2}$	56.67

Table 1 presents the Čolovića brook relief which plays a primary role in the occurrence of soil erosion. The mean altitude ( $A_m$ ) of the Čolovića brook is 743.26 m and the mean altitudinal difference (D) is 70.26 m. The mean slope ( $I_m$ ) is 15.3%. Relief of a region can also be determined by the coefficient of relief erosion energy ( $E_r$ ), the value thereof for the Čolovića brook catchment being 56.67  $m \ km^{-1/2}$ . An increase in relief parameter values results in increasing intensity of soil erosion in the catchment.

Geological substrates contribute significantly to the erosion process within the Čolovića brook catchment area (Table 2). Erosion resistance of geological substrates is directly related to water permeability. The geological substrate of the Čolovića brook

catchment is serpentine (100.00% of the total catchment area) and is with poor permeability. The water permeability coefficient of the serpentine geological substrate ( $S_1$ ) is 1.00, suggesting non-resistance of the geological substrate to the erosion process (Table 2).

**Table 2.** Geological substrate of the Čolovića brook catchment, coefficient of water permeability ( $S_1$ ) and erosion resistance

Catchment name: The Čolovića brook		
F <sub>ppr</sub> -Poorly permeable rocks		
• Serpentine	km <sup>2</sup>	0.83
	%	100.00
Coefficient of geological substrate water permeability ( $S_1$ )		1.00
Resistance of geological substrate to erosion		Non-resistant

As an erosion agent, soil and its properties contribute, to a lesser or greater degree, to the erosion process. Due to the effect of pedogenetic factors, the soil type covering the Čolovića brook catchment area is humus-siliceous soil on serpentine rock. It is classified as shallow soil. The profile of the humus-siliceous soil on serpentine is of A<sub>h</sub>-C type. A strong degree of erodibility is found in the humus-siliceous soil on serpentine [18].

**Table 3.** The structure of the Čolovića brook catchment according to type of land use and vegetative cover coefficient ( $S_2$ )

Catchment name: Čolovića brook			
F <sub>f</sub>	Forests and coppice of good spacing	km <sup>2</sup>	0.00
		%	0.00
	Orchards	km <sup>2</sup>	0.00
		%	0.00
F <sub>g</sub>	Meadows	km <sup>2</sup>	0.04
		%	4.82
	Pastures and devastated forests and coppices	km <sup>2</sup>	0.78
		%	93.98
Σf <sub>g</sub>		km <sup>2</sup>	0.82
		%	98.80
F <sub>b</sub>	Arable land	km <sup>2</sup>	0.01
		%	1.20
	Infertile soil	km <sup>2</sup>	0.00
		%	0.00
Σf <sub>b</sub>		km <sup>2</sup>	0.01
		%	1.20
Vegetation cover coefficient ( $S_2$ )		0.80	

The most aggressive climate elements inducing and contributing to soil erosion include rainfall, air temperature, and soil temperature (indirectly, through air temperatures). This region has a temperate continental climate. The mean annual rainfall

total (R) for the Čolovića brook catchment is 808.2 mm, and the mean annual air temperature (T) is 7.9°C. The data on rainfall reaching the catchment surface indicate an important role of rainfall as a climate element in soil erosion in the catchment area observed.

The contribution of the other soil erosion agents i.e. vegetation, both autochthonous and anthropogenic, and vegetative cover coefficient ( $S_2$ ) is given in Table 3. The most of the land – 0.82 km<sup>2</sup> (98.80%) is under grass vegetation ( $\sum F_g$ ) i.e. pastures and devastated forests and coppices 0.78 km<sup>2</sup> (93.98%), and 0.01 km<sup>2</sup> (1.20%) of the arable land, which is under bare soil ( $\sum f_b$ ). These forms of land-use facilitate the protection of the studied area against erosion (vegetative cover coefficient,  $S_2 = 0.80$ ).

The devastating potential of the watercourse can be determined from the hydrographic and hydrologic traits of the region analysed. The traits pertaining to the family of the Čolovića brook ( $F_c$ ) are as follows:  $F_c$ : D; IV;  $Z=0.35$ , meaning that the Čolovića brook is a dry valleys and small flash flood (D) classified as class IV of erosion category (weak intensity of erosion) and having an erosion coefficient (Z) of 0.35 (deep type of erosion).

The above traits of the erosion factors in the Čolovića brook catchment result in sediment production and soil erosion of particular intensity.

The scale of erosion of the Čolovića brook catchment is manifested through the mean annual erosion-induced sediment yield,  $W_{yr}$  of 415.79 m<sup>3</sup> yr<sup>-1</sup>.

The mean annual volume of the total sediment yield ( $G_{yr}$ ) reaching the Čolovića brook confluence is 79.00 m<sup>3</sup> yr<sup>-1</sup>, whereas the specific annual total erosion-induced sediment yield reaching the confluence with the Kamenica River ( $G_{yr\ sp^{-1}}$ ) is 95.18 m<sup>3</sup> km<sup>-2</sup> yr<sup>-1</sup>. This finding regarding the weak erosion intensity is comparable to that on the low-intensity erosion of the Grliška River region (Eastern Serbia) of ( $G_{yr\ sp^{-1}}$ ) 209.12 m<sup>3</sup> km<sup>-2</sup> yr<sup>-1</sup> [19]. Using the method of EPM, in research of the Djuricka river basin (North of Montenegro), predicted that the soil losses were 645 m<sup>3</sup> km<sup>-2</sup> per year [20].

The erosion intensity on the Čolovića brook catchment is manifested through the relief erosion energy coefficient of 56.67 m km<sup>-1/2</sup>, the erosion coefficient (Z) of 0.35, mean annual rainfall of 808.2 mm and average annual air temperature of 7.9°C, with about 98.80% of land area under grass vegetation ( $\sum F_g$ ), and the dominating humus-siliceous soil on serpentine rock.

The above data show that, in view of the annual sediment yield, about 0.21 ha of soil up to 20 cm depth are eroded of the Čolovića brook catchment area i.e. about 0.31 t ha<sup>-1</sup> of soil are lost annually. The amount of the eroded soil material can be categorised as class I (0-1 t ha<sup>-1</sup> yr<sup>-1</sup>) of permissible or tolerable erosion [1].

This model can be integrated with GIS technology for prediction of soil erosion and its spatial distribution [21].

## CONCLUSION

The Čolovića brook is classified as a ravine. The value of Z coefficient of 0.35 indicates that the river basin belongs to destruction category IV. The strength of the erosion process is weak, and deep erosion dominates in the studied area.



These and the other soil erosion agents analysed in the catchment area have resulted in the mean annual erosion-induced sediment yield of  $415.79 \text{ m}^3 \text{ yr}^{-1}$ , and erosion intensity of  $95.18 \text{ m}^3 \text{ km}^{-2} \text{ yr}^{-1}$ . The erosion observed in this region is of weak intensity, and the anthropogenic factor is the key agent in the process governing soil utilisation, soil conservation and protection from further erosion-induced degradation.

### ***Acknowledgement***

*This paper was prepared within the project T. D. 31054 funded by the Ministry of Science and Technological Development of the Republic of Serbia.*

### **REFERERENCES**

1. Hacısalihogly S., Mert A., Negiz Güvenç M., Muys B.: Soil loss prediction using universal soil loss equation (USLE) simulation model in a mountainous area in Ağlasun district, Turkey. *African Journal of Biotechnology*, 9(24), 3589-3594, 2010.
2. Oldeman L. R., Hakkeling R. T. A., Sombroek W. G.: World map of the status of human-induced soil degradation: an explanatory note. Second Edition, ISRIC Wageningen and UNEP, The Netherland, 1990.
3. Djorović M., Kadović R.: Prospects for Development of conservation lands and waters. Proceedings of the Ninth Congress of the Yugoslav Association for the Study of land "Development, use and conservation of land," Hadzic V. (ed.), Yugoslav Society of Soil Science, 665-677, Novi Sad, Serbia, 1997. (In Serbian)
4. Spalević B.: Erosion of Soil in the Federal Republic of Yugoslavia. Conservation of soil and water. Jakovljevic M. (ed.), Faculty of Agriculture, Belgrade-Zemun, Belgrade, Serbia, 1997. (In Serbian)
5. Statistical Yearbook: Data on eroded areas of soil. Republic Institute for Statistics, Belgrade, Serbia, 2008. (In Serbian)
6. Šekularac G.: The Tendency of Climatic Elements and Water Balance in the Soil of the Area of Cacak. *Acta Agriculturae Serbica*, VIII(14), 39-44, 2002.
7. Military Geographical Institute: Topographic Maps (1:25,000; 1:50,000). Belgrade, Serbia, 1971. (In Serbian)
8. Institute of Soil Science: Geological map of the western and north-western Serbia (1:500,000). Belgrade-Topcider, Serbia, 1966. (In Serbian)
9. Institute of Soil Science: Soil map of the territory of the county of Kraljevo (1:50,000). Belgrade-Topcider, Serbia, 1964. (In Serbian)
10. Republic Hydrometeorological Bureau: Data on rainfall. Belgrade, Serbia, 1930-1961. (In Serbian)
11. Bonacci O.: Meteorological and hydrological data. Manual for Land Reclamation. I st, book 2, Tomic F. (ed.), Society for drainage and irrigation of Croatia, Zagreb, Croatia. 1984. (In Croatian)
12. Centre for Research in Agriculture: Data on air temperature. Čačak, Serbia. 1949-1995 (In Serbian)

13. Dukić D.: Physical and geographical factors of the river regime. Hydrology mainland. Joković D. (ed.), Science Book, Belgrade, Serbia, 1984. (In Serbian)
14. Gavrilović S.: Engineering of torrential flows and erosion. "Building", Special Issue, Belgrade, Serbia, 1984. (In Serbian)
15. Behzadfar M., Tazioli A., Vukelic-Shutoska M., Simunic I., Spalevic V.: Calculation of sediment yield in the S1-1 Watershed, Shirindareh Watershed, Iran. *Agriculture and Forestry*, 60(4), 207-216, 2014.
16. Spalevic V., Radanovic D., Behzadfar M., Djekovic V., Andjelkovic A., Milosevic N.: Calculation of the sediment yield of the Trebacka Rijeka, Polimlje, Montenegro. *Agriculture and Forestry*, 60(1), 259-272, 2014.
17. Kostadinov S., Zlatic M., Dragicevic S., Novkovic I., Kosanin O., Borisavljevic A., Lakicevic M., Mlađan D.: Anthropogenic influence on erosion intensity changes in the Rasina River watershed - Central Serbia. *Fresenius Environmental Bulletin* 01/2014; 23(1a), 254-263, 2014.
18. Šekularac G.: The ratio of the intensity of erosion and degree erodibility of soil of the Kamenica River. Doctoral dissertation. University of Kragujevac, Faculty of Agronomy in Čačak, Čačak, Serbia, 2000. (In Serbian)
19. Stefanović T., Bilibajkić S., Braunović S., Nikić Z.: State of erosion in the catchment Grliška River before and after the formation of the reservoir "Grlište". *Water management*, 39(5-6), 408-413, 2007. (In Serbian)
20. Spalevic V., Djurovic N., Mijovic S., Vukelic-Sutoska M., Curovic M.: Soil Erosion Intensity and Runoff on the Djuricka River Basin (North of Montenegro). *Malaysian Journal of Soil Science*, 17, 49-68, 2013.
21. Tang Q., Xu Y., Bennett S.J., Li Y.: Assessment of soil erosion using RUSLE and GIS: a case study of the Yangou watershed in the Loess Plateau, China. *Environmental Earth Sciences*, 73, 1715-1724, 2015.



**NATURAL AND ANTROPOGENIC INFLUENCE ON THE SOIL  
EROSION INTENSITY IN THE KARAUJSKI BROOK  
CATCHMENT – WESTERN SERBIA**

**Gordana Sekularac<sup>1\*</sup>, R. Ristic<sup>2</sup>, M. Djuric<sup>1</sup>, M. Aksic<sup>3</sup>, D. Markovic<sup>1</sup>,  
N. Gudzic<sup>3</sup>, B. Pejic<sup>4</sup>**

<sup>1</sup>University of Kragujevac, Faculty of Agronomy, Cacak, SERBIA

<sup>2</sup>University of Belgrade, Faculty of Forestry, Belgrade, SERBIA

<sup>3</sup>University of Pristina-Kosovska Mitrovica, Faculty of Agriculture, Lesak, SERBIA

<sup>4</sup>University of Novi Sad, Faculty of Agriculture, Novi Sad, SERBIA

*\*gordasek@kg.ac.rs*

**ABSTRACT**

This paper considers the natural and anthropogenic characteristics of influence on the soil erosion intensity in the Karaulski brook catchment – Western Serbia.

The Karaulski brook is classified as a ravine. The annual erosion intensity is 125.16 m<sup>3</sup> km<sup>-2</sup> of soil. Based on natural and anthropogenic factors, the Karaulski brook catchment area belongs to erosion category III, of average intensity, surface type, with the erosion coefficient of 0.41. This analysis enables adequate soil and water protective measures to be taken for the purpose of agricultural production in the area studied.

**Key words:** natural factors, antropogenic factor, catchment, soil erosion intensity.

**INTRODUCTION**

Land degradation and soil loss are global events. Human induced pressures on natural ecosystems are still in progress, along with conservation efforts [1]. The main factor causing soil degradation worldwide is water erosion, which threatens 56% of the world's arable land [2].

Over 90% of the total land area in the Republic of Serbia suffers from different types and intensities of erosion [3]. The erosion process can have both direct and indirect impacts, inducing permanent soil disappearance. The calculated value of the total annual sediment yield suggests that some 16.0 cm of soil are annually eroded off the 21,000 ha of land in Serbia [4]. In the Republic of Serbia (Central Serbia), there are 1.221 million ha of eroded soil, and 36,000 ha are in a steady state, now [5].

Erosion has mostly affected strongly sloping, deforested or cultivated shallow soils on slopes, formed on impermeable geological substrates, due to the effects of intense rainfall and fluctuating air temperatures [4].

The tendency of air temperature to increase and of rainfall to decrease is quite evident in the region of Čačak [6]. Climate change leads to degraded soil physical properties, increases soil erodibility and reduces the protective role of vegetation.

The above factors cause intensification of both surface and deep-cutting processes of erosion.

Given the above, the objectives of this study are quantitative assessment of soil erosion induced by a range of factors and estimation of sediment yield in one part of the catchment area of the Kamenica River (part of the Zapadna Morava catchment) i.e. its subbasin the Tinja, including its second order left-hand tributary the Karaulski brook.

## MATERIALS AND METHODS

The Karaulski brook is located near Čačak ( $43^{\circ} 53' N$ ;  $20^{\circ} 21' E$ ), Western Serbia, and belongs to the catchment of the Zapadna Morava river.



**Figure 1.** The Karaulski brook catchment

Natural characteristics of the Karaulski brook basin were studied using map data (hydrography, relief, geological substrate and soil), literature data (elements of climate: rainfall and air temperature) and data obtained through an immediate reconnaissance survey of the area (vegetation).

Maps of the studied area have the following scale: topographic map (1:25,000 Figure 1; 1:50,000) [7], geological map (1:500,000) [8] and pedological map (1:50,000) [9].

Meteorological parameters for the catchment area were calculated using the method of interpolation of rainfall data [10] by the rainfall gradient [11], and air temperature [12] calculations for any altitude [13].

Erosion-induced soil losses can be predicted by various analytical models.

However, according to the experience of a number of researchers, the Erosion Potential Method – EPM [14] is the most suitable on catchment level for watershed management purposes in this Region and is used in: Bosnia & Herzegovina, Bulgaria,

Croatia, the Czech Republic, Italy, Iran, Montenegro, Macedonia, Serbia and Slovenia [15; 16; 17]. This is why quantitative indicators of soil erosion in this research were calculated using the Erosion Potential Method - EPM.

The basic analytical equation (1) for the calculation of erosion-induced soil losses, as developed [14], is as follows:

$$G_{yr \times sp^{-1}} = T \times H_{yr} \times \pi \sqrt{Z^3} \times R_u \quad (1)$$

where:

$G_{yr \times sp^{-1}}$  – specific annual total erosion-induced sediment yield reaching the confluence,  $m^3 yr^{-1} km^{-2}$

T – temperature coefficient of the catchment

$H_{yr}$  – amount of rainfall, mm

$\pi$  – 3.14

Z – coefficient of erosion

$R_u$  – coefficient of retention of soil in the catchment.

## RESULTS AND DISCUSSION

The size, length, circumference and shape (perimeter) of a catchment area are among major catchment elements of importance for soil erosion. The Karaulski brook catchment is 0.82  $km^2$  in area (F), 4.55 km in length (L), and 1.37 km in circumference (C).

The major physical and geographical elements of the Karaulski brook catchment, relief characteristics, geological substrate features, soil type and soil utilisation method, are quantitative parameters or soil erosion in the catchment.

**Table 1.** The basic parameters of the Karaulski brook catchment relief

Catchment name: The Karaulski brook	
The lowest point of the main watercourse and catchment (B), m	628
The highest point of the main watercourse (C), m	718
The highest point of the catchment (E), m	751
Average slope of the main watercourse in the catchment ( $I_a$ ), %	5.6
Mean catchment altitude ( $A_m$ ), m	698.55
Mean catchment altitudinal difference (D), m	70.55
Mean catchment slope ( $I_m$ ), %	23.8
Coefficient of catchment relief erosion energy ( $E_r$ ), $m km^{-1/2}$	41.00

Table 1 presents the Karaulski brook relief which plays a primary role in the occurrence of soil erosion. The mean altitude ( $A_m$ ) of the Karaulski brook is 698.55 m and the mean altitudinal difference (D) is 70.55 m. The mean slope ( $I_m$ ) is 23.8%. Relief of a region can also be determined by the coefficient of relief erosion energy ( $E_r$ ), the value thereof for the Karaulski brook catchment being 41.00  $m km^{-1/2}$ . An increase in relief parameter values results in increasing intensity of soil erosion in the catchment.

Geological substrates contribute significantly to the erosion process within the Karaulski brook catchment area (Table 2). Erosion resistance of geological substrates is directly related to water permeability. The geological substrate of the Karaulski brook catchment is serpentine (100.00% of the total catchment area) and is with poor permeability.

The water permeability coefficient of the serpentine geological substrate ( $S_1$ ) is 1.00, suggesting non-resistance of the geological substrate to the erosion process (Table 2).

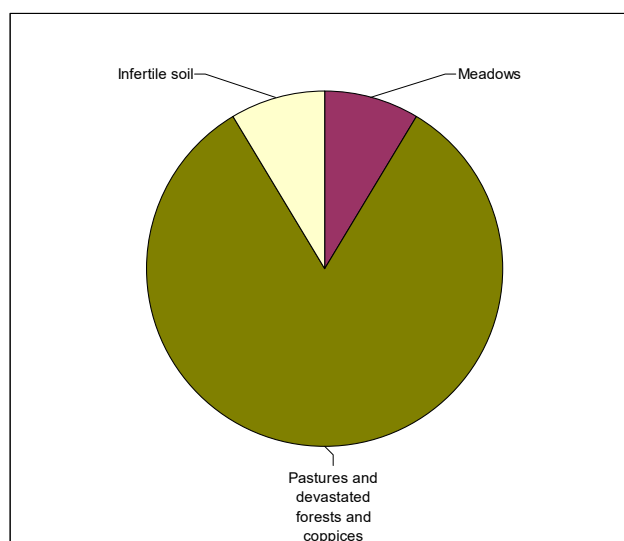
**Table 2.** Geological substrate of the Karaulski brook catchment, coefficient of water permeability ( $S_1$ ) and erosion resistance

Catchment name: The Karaulski brook		
F <sub>ppr</sub> -Poorly permeable rocks		
• Serpentine	km <sup>2</sup>	0.82
	%	100.00
Coefficient of geological substrate water permeability ( $S_1$ )		1.00
Resistance of geological substrate to erosion		Non-resistant

As an erosion agent, soil and its properties contribute, to a lesser or greater degree, to the erosion process. Due to the effect of pedogenetic factors, the soil type covering the brook Karaulski catchment area is humus-siliceous soil on serpentine rock. It is classified as shallow soil. The profile of the humus-siliceous soil on serpentine is of A<sub>h</sub>-C type. A strong degree of erodibility is found in the humus-siliceous soil on serpentine [18].

The most aggressive climate elements inducing and contributing to soil erosion include rainfall, air temperature, and soil temperature (indirectly, through air temperatures). This region has a temperate continental climate. The mean annual rainfall total (R) for the Karaulski brook catchment is 798.5 mm, and the mean annual air temperature (T) is 8.2<sup>0</sup>C. The data on rainfall reaching the catchment surface indicate an important role of rainfall as a climate element in soil erosion in the catchment area observed.

The contribution of the other soil erosion agents i.e. vegetation, both autochthonous and anthropogenic is given in Figure 2



**Figure 2.** The structure of the Karaulski brook catchment according to type of land use

The most of the land – 0.75 km<sup>2</sup> (91.46%) is under grass vegetation ( $\sum F_g$ ) i. e. meadows 0.07 km<sup>2</sup> (8.54%) and pastures and devastated forests and coppices 0.68 km<sup>2</sup> (82.92%), and 0.07 km<sup>2</sup> (8.54%) of the infertile soil, which is under bare soil ( $\sum f_b$ ). These forms of land-use facilitate the nonprotection of the studied area against erosion (vegetative cover coefficient,  $S_2 = 0.82$ ).

The devastating potential of the watercourse can be determined from the hydrographic and hydrologic traits of the region analysed. The traits pertaining to the family of the Karaulski brook ( $F_c$ ) are as follows:  $F_c$ : E; III;  $Z=0.41$ , meaning that the Karaulski brook is a ravine (E) classified as class III of erosion category (average intensity of erosion) and having an erosion coefficient ( $Z$ ) of 0.41 (surface type of erosion).

The above traits of the erosion factors in the Karaulski brook catchment result in sediment production and soil erosion of particular intensity.

The scale of erosion of the Karaulski brook catchment is manifested through the mean annual erosion-induced sediment yield,  $W_{yr}$  of 513.17 m<sup>3</sup> yr<sup>-1</sup>.

The mean annual volume of the total sediment yield ( $G_{yr}$ ) reaching the Karaulski brook confluence is 102.63 m<sup>3</sup> yr<sup>-1</sup>, whereas the specific annual total erosion-induced sediment yield reaching the confluence with the Kamenica River ( $G_{yr\ sp^{-1}}$ ) is 125.16 m<sup>3</sup> km<sup>-2</sup> yr<sup>-1</sup>. This finding regarding the weak erosion intensity is comparable to that on the low-intensity erosion of the Grliška River region (Eastern Serbia) of ( $G_{yr\ sp^{-1}}$ ) 209.12 m<sup>3</sup> km<sup>-2</sup> yr<sup>-1</sup> [19]. Using the method of EPM, in research of the Djuricka river basin (North of Montenegro), predicted that the soil losses were 645 m<sup>3</sup> km<sup>-2</sup> per year [20].

The erosion intensity on the Karaulski brook catchment is manifested through the relief erosion energy coefficient of 41.00 m km<sup>-1/2</sup>, the erosion coefficient ( $Z$ ) of 0.41, mean annual rainfall of 798.5 mm and average annual air temperature of 8.2°C, with about 91.46% of land area under grass vegetation ( $\sum F_g$ ), and the dominating humus-siliceous soil on serpentine rock.

The above data show that, in view of the annual sediment yield, about 0.26 ha of soil up to 20 cm depth are eroded of the Karaulski brook catchment area i.e. about 0.39 t ha<sup>-1</sup> of soil are lost annually. The amount of the eroded soil material can be categorised as class I (0-1 t ha<sup>-1</sup> yr<sup>-1</sup>) of permissible or tolerable erosion [1].

This model can be integrated with GIS technology for prediction of soil erosion and its spatial distribution [21].

## CONCLUSION

The Karaulski brook is classified as a ravine. The value of  $Z$  coefficient of 0.41 indicates that the river basin belongs to destruction category III. The strength of the erosion process is average, and surface erosion dominates in the studied area.

These and the other soil erosion agents analysed in the catchment area have resulted in the mean annual erosion-induced sediment yield of 513.17 m<sup>3</sup> yr<sup>-1</sup>, and erosion intensity of 125.16 m<sup>3</sup> km<sup>-2</sup> yr<sup>-1</sup>. The erosion observed in this region is of average intensity, and the anthropogenic factor is the key agent in the process governing soil utilisation, soil conservation and protection from further erosion-induced degradation.

### **Acknowledgement**

*This paper was prepared within the project T. D. 31054 funded by the Ministry of Science and Technological Development of the Republic of Serbia.*

### **REFERENCES**

22. Hacısalıhoğlu S., Mert A., Negiz Güvenç M., Muys B.: Soil loss prediction using universal soil loss equation (USLE) simulation model in a mountainous area in Ağlasun district, Turkey. *African Journal of Biotechnology*, 9(24), 3589-3594, 2010.
23. Oldeman L. R., Hakkeling R. T. A., Sombroek W. G.: *World map of the status of human-induced soil degradation: an explanatory note*. Second Edition, ISRIC Wageningen and UNEP, The Netherlands, 1990.
24. Djorović M., Kadović R.: Prospects for Development of conservation lands and waters. Proceedings of the Ninth Congress of the Yugoslav Association for the Study of land "Development, use and conservation of land," Hadzic V. (ed.), Yugoslav Society of Soil Science, 665-677, Novi Sad, Serbia, 1997. (In Serbian)
25. Spalević B.: Erosion of Soil in the Federal Republic of Yugoslavia. Conservation of soil and water. Jakovljević M. (ed.), Faculty of Agriculture, Belgrade-Zemun, Belgrade, Serbia, 1997. (In Serbian)
26. Statistical Yearbook: Data on eroded areas of soil. Republic Institute for Statistics, Belgrade, Serbia, 2008. (In Serbian)
27. Šekularac G.: The Tendency of Climatic Elements and Water Balance in the Soil of the Area of Čačak. *Acta Agriculturae Serbica*, VIII(14), 39-44, 2002.
28. Military Geographical Institute: Topographic Maps (1:25,000; 1:50,000). Belgrade, Serbia, 1971. (In Serbian)
29. Institute of Soil Science: Geological map of the western and north-western Serbia (1:500,000). Belgrade-Topcider, Serbia, 1966. (In Serbian)
30. Institute of Soil Science: Soil map of the territory of the county of Kraljevo (1:50,000). Belgrade-Topcider, Serbia, 1964. (In Serbian)
31. Republic Hydrometeorological Bureau: Data on rainfall. Belgrade, Serbia, 1930-1961. (In Serbian)
32. Bonacci O.: Meteorological and hydrological data. Manual for Land Reclamation. I st, book 2, Tomic F. (ed.), Society for drainage and irrigation of Croatia, Zagreb, Croatia. 1984. (In Croatian)
33. Centre for Research in Agriculture: Data on air temperature. Čačak, Serbia. 1949-1995 (In Serbian)
34. Đukić D.: Physical and geographical factors of the river regime. Hydrology mainland. Joković D. (ed.), Science Book, Belgrade, Serbia, 1984. (In Serbian)
35. Gavrilović S.: Engineering of torrential flows and erosion. "Building", Special Issue, Belgrade, Serbia, 1984. (In Serbian)



36. Behzadfar M., Tazioli A., Vukelic-Shutoska M., Simunic I., Spalevic V.: Calculation of sediment yield in the S1-1 Watershed, Shirindareh Watershed, Iran. *Agriculture and Forestry*, 60(4), 207-216, 2014.
37. Spalevic V., Radanovic D., Behzadfar M., Djekovic V., Andjelkovic A., Milosevic N.: Calculation of the sediment yield of the Trebacka Rijeka, Polimlje, Montenegro. *Agriculture and Forestry*, 60(1), 259-272, 2014.
38. Kostadinov S., Zlatic M., Dragicevic S., Novkovic I., Kosanin O., Borisavljevic A., Lakicevic M., Mladan D.: Anthropogenic influence on erosion intensity changes in the Rasina River watershed - Central Serbia. *Fresenius Environmental Bulletin* 01/2014; 23(1a), 254-263, 2014.
39. Šekularac G.: The ratio of the intensity of erosion and degree erodibility of soil of the Kamenica River. Doctoral dissertation. University of Kragujevac, Faculty of Agronomy in Čačak, Čačak, Serbia, 2000. (In Serbian)
40. Stefanović T., Bilibajkić S., Braunović S., Nikić Z.: State of erosion in the catchment Grliška River before and after the formation of the reservoir "Grlišhte". *Water management*, 39(5-6), 408-413, 2007. (In Serbian)
41. Spalevic V., Djurovic N., Mijovic S., Vukelic-Sutoska M., Curovic M.: Soil Erosion Intensity and Runoff on the Djuricka River Basin (North of Montenegro). *Malaysian Journal of Soil Science*, 17, 49-68, 2013.
42. Tang Q., Xu Y., Bennett S.J., Li Y.: Assessment of soil erosion using RUSLE and GIS: a case study of the Yangou watershed in the Loess Plateau, China. *Environmental Earth Sciences*, 73, 1715-1724, 2015.



## TREATMENT OF WASTEWATER CONTAINING CYANIDES IN A FLOW ELECTROCHEMICAL REACTOR

Borislav N. Malinovic<sup>1\*</sup>, T. Malinovic<sup>1</sup>, S. Bunic<sup>2</sup>

<sup>1</sup>University of Banja Luka, Faculty of Technology, Banja Luka,  
BOSNIA AND HERZEGOVINA

<sup>2</sup>Tem-inzenjering, Banja Luka, BOSNIA AND HERZEGOVINA

\*borislav.malinovic@unibl.rs

### ABSTRACT

The flow electrochemical reactor with a ratio electrode surface area and the volume of the reactor,  $16 \text{ m}^2/\text{m}^3$ , was used for treatment wastewater containing cyanide by electrocoagulation process with iron electrodes. It was investigated the effect of current density, supporting electrolyte, and the reaction time to cyanide removal ( $\gamma_{\text{CN}^-}=200 \text{ mg/L}$ ) with the hydraulic retention time  $\text{HRT}=2,67 \text{ min}$ . In the presence of  $1 \text{ g/L}$  NaCl for 60 minutes of treatment, the removal efficiency achieved,  $\text{Eu} = 98,30\%$ .

**Key words:** electrocoagulation, cyanide, current density.

### INTRODUCTION

Wastewater containing cyanides are among the most toxic wastewater. Cyanides are common name which include inorganic compounds, respectively cyanide salts containing cyanide anion  $[\text{C}\equiv\text{N}]^-$  and organic compounds (organic cyanides) that have a functional group  $-\text{C}\equiv\text{N}$ . Soluble cyanides are partially hydrolyzed in moist air and transformed into hydrocyanic acid which is one of the most toxic substances [1,2]. Cyanide is a highly reactive toxic compound, which in the wet and acidic conditions form deadly gas (HCN). Cyanides, hydrocyanic acid salts and all compounds containing  $\text{CN}^-$  ion are far less toxic. The lethal dose is 150-200 mg KCN [2]. The total quantity of cyanide wastewater that is discharged during the year is estimated at more than kg/year [3]. Since cyanide is very reactive, it readily binds metals such strong ligand and form complexes of different stability and toxicity [4]. There are several possible methods for treating wastewater containing cyanides. The most commonly used treatment is alkaline chlorination, and lately degradation with hydrogen peroxide, ozone,  $\text{SO}_2/\text{air}$  (INCO process), photocatalytic oxidation, cyanide biodegradation, electrodialysis, reverse osmosis and electrochemical treatment [5-11].

Electrochemical technology of wastewater treatment use electricity through appropriate electrodes in the electrochemical reactor and presents an alternative to traditional chemical oxidation. For removing free cyanide was successfully used several

different electrode materials (Pt, Ti / Pt, PbO<sub>2</sub>, Fe, Al, stainless steel) [5,10,12]. Depending on the electrode material applied can be carried various electrochemical processes, such as electrodeposition, anodic oxidation, electrocoagulation and electroflotation.

Electrocoagulation is more present wastewater treatment in which there is a charge neutralization of pollutants under the influence of an external source of electricity. Electrochemical technology also offer an alternative the use of metal salts, polymers and polyelectrolytes in the destruction of stable suspensions and emulsions [13]. The basic parameters of electrochemical treatment are: electrode material, electrochemical reactor design, current density, pH value of wastewater, electrolyte conductivity, temperature [14,15].

Compared to conventional chemical coagulation, electrocoagulation basic advantages are a smaller amount needed coagulate ions, the greater pollutants removal efficiency, there is no use of chemicals thus reducing the possibility of secondary pollution and reduces the quantity of sludge, less reaction time and consequently less, simple and easy handling equipment. In addition, the hydrogen generated at the cathode, causing stirring the suspension in a reactor which promotes flocculation, and hence the overall efficiency of the process. These properties make the electrocoagulation process technically and economically more efficient than conventional chemical coagulation [10].

The aim of this study was to investigate the effect of current density, supporting electrolyte and reaction time to remove cyanide from simulated wastewater by electrocoagulation process with iron electrodes. The flow electrochemical reactor is characterized by continuous reaction, continues temperature, concentration and other values during electrolysis. Therefore, the control and the maintenance of the electrolysis is simple.

Literature concerning cyanide removal by electrocoagulation process is rare and limited to the work undertaken by Moussavi *et al.*, Koby *et al.*, Hassani *et al.* and Senturk [10, 16-18].

Of these studies, only Moussavi *et al.* in addition to batch, carry out research on flow electrochemical reactor. In case of batch reactors the best results are achieved with Fe-Al (anode-cathode) electrode arrangement. Increasing current density from 2 to 15 mA/cm<sup>2</sup> increases cyanide removal efficiency from 43 to 91% for 20 minutes for reaction without aeration and 45-98% with aeration. In flow electrochemical reactor with different hydraulic retention times (HRT) increase cyanide removal efficiency of 57% (HRT=15 min) to complete efficiency (HRT=140 min) [10]. Koby *et al.* have conducted research in the purification of rinse galvanic wastewater containing cadmium cyanide and nickel cyanide at a batch electrochemical reactor with iron electrodes. Removal efficiency and operational costs at optimal conditions (30 A/m<sup>2</sup>, 30 min. and pH=8-10 for cadmium; 60 A/m<sup>2</sup>, 80 min. and pH=8-10 for nickel) amounted to 99,4% and 1,05 €/m<sup>3</sup> for cadmium and 99,1% and 2,45 €/m<sup>3</sup> for nickel and >99,7% for cyanides, respectively [16]. The effect of voltage, initial concentration of cyanide and reaction time in reactor with iron electrodes are presented in the work Hassani *et al.* wherein was achieved a cyanide removal efficiency of 97% [17]. Senturk studied the influence of the electrode material, current density, reaction time, initial pH and electrode arrangement occurs

optimal parameters, 20 A/m<sup>2</sup>, 60 min for maximum removal efficiency of 85 and 99% for Fe and 64 to 33% for Al electrode, for cyanides and zinc, respectively [18].

## MATERIALS AND METHODS

For the purpose of experimental researches, we used commercially available 95% sodium cyanide (NaCN), Acros Organics, Belgium, 99,5% sodium chloride (NaCl) and 98 % sodium hydroxide (NaOH), Lachner, Czech Republic. All the listed chemicals are of p.a. purity. In order to prepare synthetic cyanide wastewater of the particular concentration we used 0.01 M sodium hydroxide solution (NaOH), and stainless steel as electrode material (EN 1.4301/AISI 304; max. 0.08% C, max. 0.12% Cr, max. 0.45% Mn, max. 0.60% Si). Flow electrochemical reactor is made of polyester with eight electrodes (Figure 1). Distance between the electrodes is 1 cm, and the total area of the anode is 356 cm<sup>2</sup>. The flow of waste water is provided via peristaltic pump with the possibility of changing the flow rate (Figure 2).

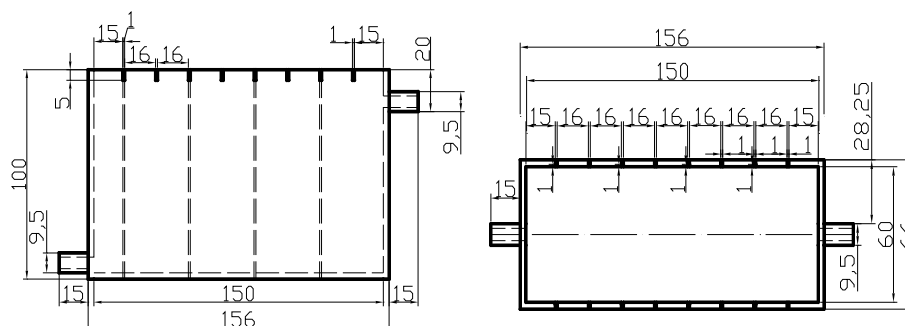
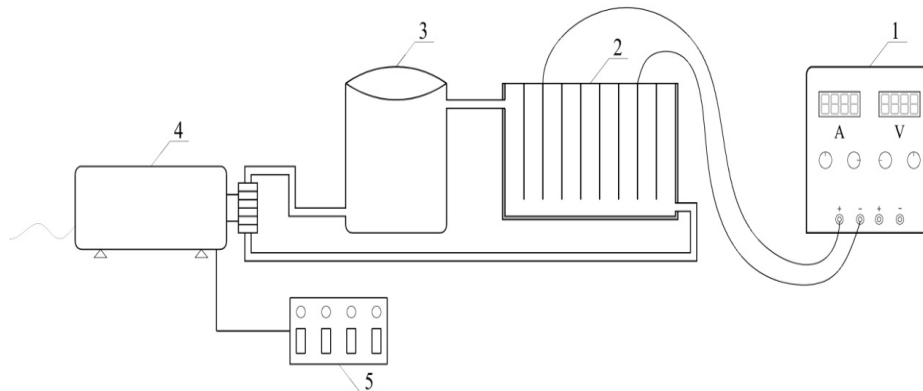


Figure 1. Flow electrochemical reactor

Flow velocity of wastewater through the flow reactor was 294 mL/min, respectively, the hydraulic retention time (*HRT*) was 2,67 minutes. Prior research, attention was paid to the choice of appropriate relations electrode surface area and volume of the reactor. Mousavi *et al.* researched removal of cyanide using ratio of electrode surface area and the volume of the reactor (16 m<sup>2</sup>/m<sup>3</sup>) and therefore used volume of wastewater adapted this proportion and it was  $V=0,786 \text{ dm}^3$  [10].



**Figure 2.** Scheme of pilot plant (1- electricity source, 2-reactor, 3-container for collecting the solution, 4 pump, 5-control unit)

All experiments were performed at the starting temperature of sample 20° C. Current density was at for desirable value before each treatment. Electrodes were mechanically cleaned and washed with detergent and acetone before each treatment in order to remove surface grease and electrode surfaces were cleaned by emerging (5 min.) in diluted (1:1) solution of HCl after which the electrodes are washed with distilled water. Prepared sample synthetic wastewater before and after treatment analyzed the content of free cyanide in accordance with standard methods [19].

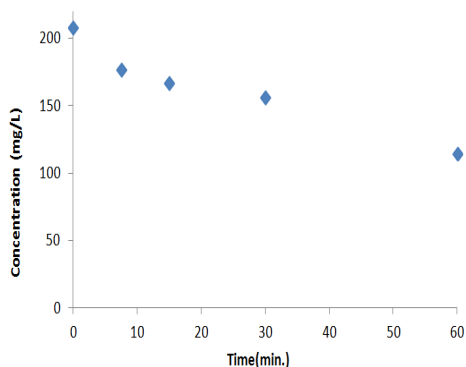
## RESULTS AND DISCUSSION

For experimental research electrochemical removal of cyanide we used 0,01 M NaOH with a cyanide content of the initial mass concentration  $\gamma_{CN}=200$  mg/L. Results of the electrochemical removal are shown through cyanide removal efficiency,  $E_u$  (%), whose ratio could be described by following equation:

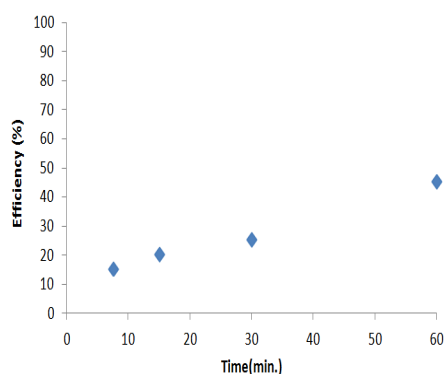
$$E_u = \frac{\gamma_i - \gamma_f}{\gamma_i} \cdot 100 [\%] \quad (1),$$

where is  $\gamma_i$  and  $\gamma_f$  initial and final cyanide concentration (mg/L).

The effect of electrolysis duration (15, 30, 60 min) to decrease cyanide concentration in wastewater ( $\gamma_0=200$  mg/L) at different current densities ( $j=5-20$  mA/cm<sup>2</sup>) is shown in Figures 3, 5, and 7.

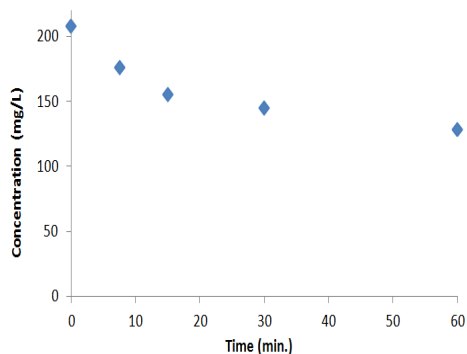


**Figure 3.** Reducing cyanide concentration in depend of electrolysis duration ( $j=5 \text{ mA/cm}^2$ ,  $t=60 \text{ min.}$ )

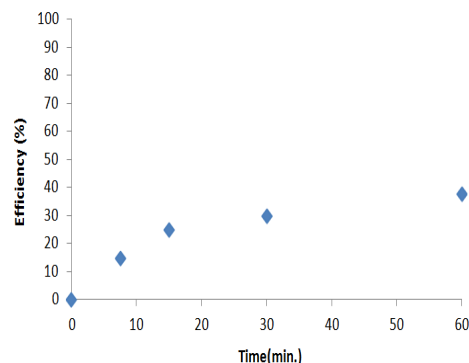


**Figure 4.** Effect of electrolysis duration on cyanide removal efficiency ( $j=5 \text{ mA/cm}^2$ ,  $t=60 \text{ min.}$ )

The effect of electrolysis duration (15, 30, 60 min) to cyanide removal efficiency in wastewater ( $\gamma_0=200 \text{ mg/L}$ ) at different current densities ( $j=5-20 \text{ mA/cm}^2$ ) is shown in Figures 4, 6, and 8. It is obvious that a change in current density significantly affects the efficiency of reduction cyanide concentration. The greatest efficiency has been reached with  $j=5 \text{ mA/cm}^2$ ,  $Eu = 45,00\%$ , for 60 minutes of treatment. At a current density of 10 to  $20 \text{ mA/cm}^2$ , achieved efficiency is  $Eu=38,01\%$  and  $Eu=36,45\%$ , respectively.



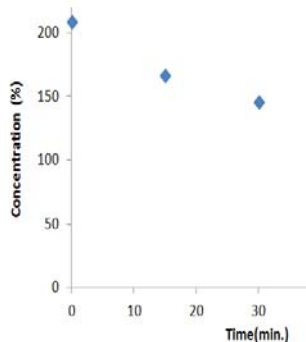
**Figure 5.** Reducing cyanide concentration in depend of electrolysis duration ( $j=10 \text{ mA/cm}^2$ ,  $t=60 \text{ min.}$ )



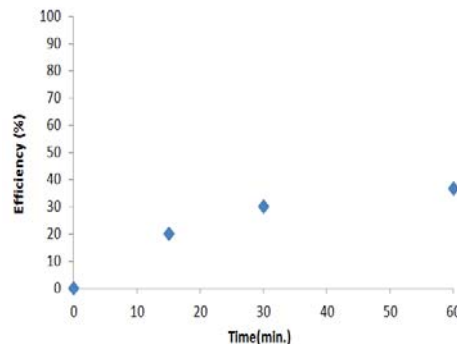
**Figure 6.** Effect of electrolysis duration on cyanide removal efficiency ( $j=10 \text{ mA/cm}^2$ ,  $t=60 \text{ min.}$ )

To increase the conductivity of the solution, and therefore cyanide removal efficiency, further research has been used NaCl as supporting electrolyte. Figure 9 shows effect of NaCl concentration on cyanide removal efficiency. Duration of electrolysis for all concentrations of supporting electrolyte is,  $t=30 \text{ min}$ , and the current density,  $j=10$

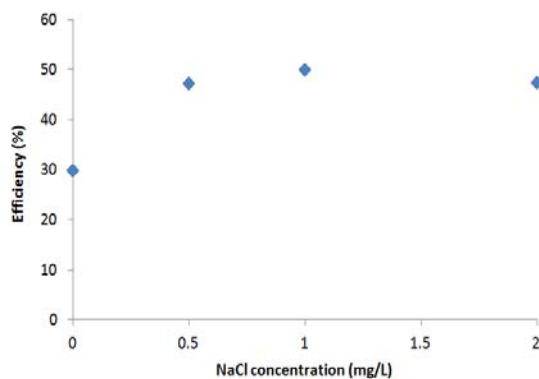
$\text{mA/cm}^2$  ( $\gamma_0=200 \text{ mg/L}$ ). Efficiency is the highest at  $\gamma_{\text{NaCl}}=1 \text{ g/L}$  ( $Eu=50,01\%$ ), and the lowest at  $\gamma_{\text{NaCl}}=0,5 \text{ g/L}$  ( $Eu=47,38\%$ ).



**Figure 7.** Reducing cyanide concentration in depend of electrolysis duration ( $j=20 \text{ mA/cm}^2$ ,  $t=60 \text{ min.}$ )



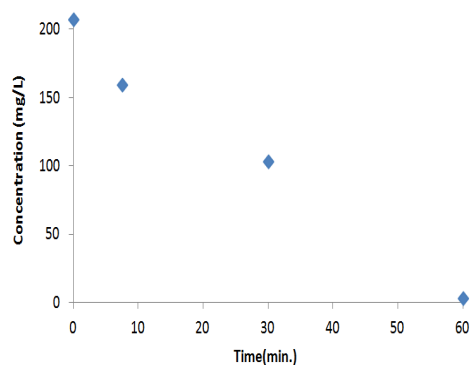
**Figure 8.** Effect of electrolysis duration on cyanide removal efficiency ( $j=20 \text{ mA/cm}^2$ ,  $t=60 \text{ min.}$ )



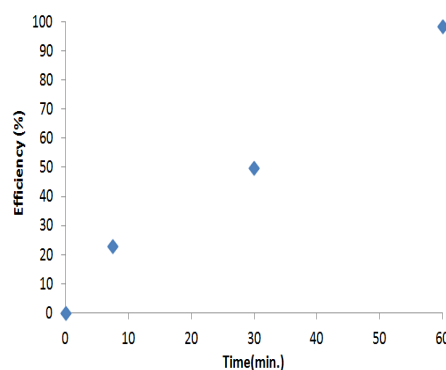
**Figure 9.** Effect of NaCl concentration on cyanide removal efficiency

The effect of electrolysis duration to reduce cyanide concentration in the presence of supporting electrolyte, NaCl, ( $\gamma_{\text{NaCl}}=1 \text{ g/L}$ ) is shown in Figure 10 ( $j=10 \text{ mA/cm}^2$ ,  $\gamma_0=200 \text{ mg/L}$ ), and effect of electrolysis duration on cyanide removal efficiency for identical conditions is shown in Figure 11.

At concentration of supporting electrolyte,  $\gamma_{\text{NaCl}}=1 \text{ g/L}$ , treatment time,  $t=60 \text{ min}$ , is achieved cyanide removal efficiency,  $Eu=98.30\%$ .

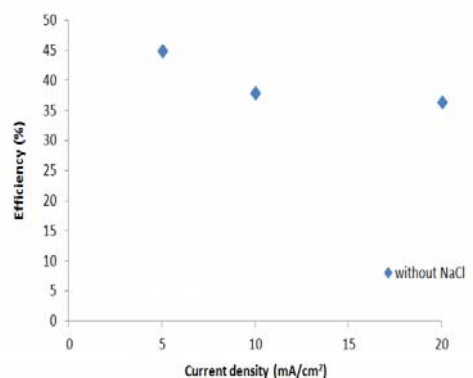


**Figure 10.** Reducing cyanide concentration in depend of electrolysis duration ( $\gamma_{(\text{NaCl})}=1 \text{ g/L}$ ,  $t=60 \text{ min.}$ )

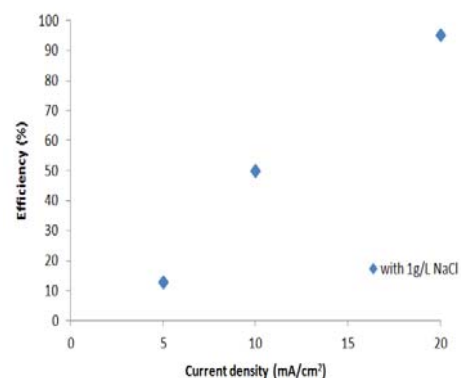


**Figure 11.** Effect of electrolysis duration on cyanide removal ( $\gamma_{(\text{NaCl})}=1 \text{ g/L}$ ,  $t=60 \text{ min.}$ )

Applied current density ( $j=5\text{-}20 \text{ mA/cm}^2$ ) differently affects on cyanide removal efficiency, depending on the presence and concentration of supporting electrolyte. Effect of current density on cyanide removal efficiency in a flow electrochemical reactor with electrodes of iron, without the presence of NaCl, during electrolysis,  $t=60 \text{ min.}$  is shown in Figure 12. Figure 13 shows impact of current density at different concentrations of supporting electrolyte during electrolysis,  $t=30 \text{ min.}$



**Figure 12.** Effect of current density on cyanide removal efficiency without NaCl ( $\gamma_0=200 \text{ mg/L}$ ,  $t=60 \text{ min.}$ )



**Figure 13.** Effect of current density on cyanide removal efficiency with NaCl ( $\gamma_0=200 \text{ mg/L}$ ,  $\gamma_{(\text{NaCl})}=1 \text{ g/L}$ ,  $t=30 \text{ min.}$ )

Increase in current density above  $5 \text{ mA/cm}^2$  without the presence of NaCl negatively affects the efficiency of the process, while in the presence of  $1 \text{ g/L NaCl}$  increase in current density has a positive impact on efficiency and has almost linearly dependent. That makes it possible for,  $j=20 \text{ mA/cm}^2$  and  $t=30 \text{ min.}$ , almost completely remove cyanides from wastewater ( $E_u=95,10\%$ ).



## CONCLUSION

Results of this study show that the process of electrocoagulation in flow electrochemical reactor with iron electrodes can successfully completely remove cyanide. The presence of NaCl as supporting electrolyte increases cyanide removal efficiency and enables operation at higher current densities where the efficiency increases significantly for shorter reaction time.

## Acknowledgements

*This work was supported in part by the Ministry of Science and Technology of the Republic of Srpska under Project 19/6-020/961-171/14.*

## REFERENCES

1. D. R. Lide, *CRC Handbook of Chemistry and Physics*, 87th ed. Boca Raton, FL, CRC Press, 2006.
2. S. Budavari, *The Merck Index: An Encyclopedia of Chemicals, Drugs, and Biologicals*, 13th ed. Merck Publishing., 2001.
3. S. Ebbs, "Biological degradation of cyanide compounds", *Current opinion in Biotechnology*, 2004, Vol. 15, pp 1-6.
4. J. S. Avalos, M. G. Richmond, O. Nagappan, D. A. Kunz, "Degradation of the Metal-Cyano Complex Tetracyanonickelate (II) by Cyanide-Utilizing Bacterial Isolates", *Applied and Environmental Microbiology*, pp. 3664-3670, 1990.
5. G. Chen, "Electrochemical technologies in wastewater treatment", *Separation and Purification technology*, no. 38, pp 11-41, 2004.
6. R.R. Dash, C. Balomajumder, A. Kumar, "An Overview of Removal Methods of Cyanide from Industrial Wastewater", *7th International Congress on Civil Engineering*, 2005.
7. K. Saarela, T. Kuokkanen, "Alternative disposal methods for wastewater containing cyanide: Analytical studies on new electrolysis technology developed for total treatment of waste water containing gold or silver cyanide", *Waste Minimization and Resources Use Optimization Conference*, Univerzitet Oulu, Finska, 10. jun 2004.
8. I.A. Ibrahim, A.A. Ismail, R.M. Mohamed, "Degradation of free cyanide by photocatalytic oxidation", *European Journal of Mineral Processing and Environmental Protection*, Vol.3, No.3, pp. 281-290, 2003.
9. F. Nava, A. Uribe, R. Pérez, "Use of ozone in the treatment of cyanide containing effluents", *European Journal of Mineral Processing and Environmental Protection*, Vol.3, No.3, pp. 316-323, 2003.
10. G. Moussavi, F. Majidi, M. Farzadkia, "The influence of operational parameters on elimination of cyanide from wastewater using the electrocoagulation process", *Desalination*, 280, pp 127-133, 2011.

11. J.B. Mosher, L. Figueroa, "Biological oxidation of cyanide: A viable treatment option for the minerals processing industry", *Mineral Engineering*, vol. 9, no. 5, pp.573-581, 1996.
12. L. Szpyrkowicz, S.N. Kaul, E. Molga, M. DeFaveri, " Comparison of the performance of a reactor equipped with a TiPt and SS anode for simultaneous cyanide removal and copper recovery", *Electrochimica Acta*, vol. 46, pp. 381–387, 2000.
13. B. Malinović, J. Mandić, M. G. Pavlović, M. Tomić, "Smanjenje HPK-vrijednosti otpadnih voda anodnom oksidacijom u industriji poludisperzija i disperzija", *Zaštita materijala*, vol. 53, no. 1, pp 31-36, 2013.
14. B. Malinović, M. G. Pavlović, N. Gorgi, "Uticaj gustine struje na elektrolitičku degradaciju cijanidnih otpadnih voda", *Yucorr XV*, Tara, Srbija, 17-20.9.2013. god.
15. B. Malinović, M. G. Pavlović, "Uticaj različitih anjona i njihove koncentracije na elektrolitičku degradaciju cijanidnih otpadnih voda", *Yucorr XV*, Tara, Srbija, 17-20.9.2013. god.
16. M. Kobya, E. Demirbas, N. U. Parlak, S. Yigit, "Treatment of cadmium and nickel electroplating rinse water by electrocoagulation", *Environmental Technology*, 31, pp 1471–1481, 2010.
17. G. Hassani, S. Nasser, H. Gharibi, "Removal of Cyanide by Electrocoagulation Process". *Anal. Bioanal. Electrochem.*, vol. 3, no. 6, pp 625-634, 2011.
18. E. Senturk, " Removal of zinc-cyanide from rinse water by electrocoagulation", *Water Science & Technology*", vol. 10, no. 68, pp 2220-2227, 2013.
19. Standard Methods for the Examination of Water and Wastewater. APHA, EPA, *American public health association*, New York, 1999.



## INFLUENCE OF SURFACE ACTIVE SUBSTANCES ON 4A ZEOLITE CHARACTERISTICS

Zora Levi, J. Penavin-Skundric, S. Sladojevic\*, D. Bodroza

University in Banja Luka, Faculty of Technology, Banja Luka, RS, B&H

\**slavica.bl@gmail.com*

### ABSTRACT

The study observed adsorption of  $\text{NH}_3$ ,  $\text{CH}_3\text{COOH}$  and  $\text{C}_{17}\text{H}_{33}\text{COOH}$  on 4A synthetic zeolite and its modified form. The characteristics of catalysts, which are important for adsorption, are related to the surface condition, and those are: chemical composition, structure, development and energy relief of surface, size, form and distribution of pores on which inner surface adsorption also takes place. Exactly for that reason, it was interesting to observe the behavior of pure 4A zeolite and its modified form with cation surface active substance – pröpagen in contact with solutions of  $\text{NH}_3$ ,  $\text{CH}_3\text{COOH}$  and  $\text{C}_{17}\text{H}_{33}\text{COOH}$ . Since zeolites do not have stoichiometric composition, it is possible that isomorphic substitutions of Si and Al, as well as of cations and sorbates, take place in them. Adsorptions are presented by isotherms of Freundlich type. The objective of this study was an attempt to transfer the surface of zeolite from primary hydrophilic to hydrophobic one, which would enable a stronger interaction with mentioned adsorbates. The conclusion is that it was a success, because modified 4A zeolite gave a lot better results than unmodified one, particularly in case of adsorption of  $\text{CH}_3\text{COOH}$ . Most probably, modified organo-zeolite got organophilic surface, due to which it proved to have extraordinary adsorption characteristics towards acetic acid and poorer ones towards oleic acid because of the size of this acid molecules.

**Key words:** adsorption, 4A zeolite, ammonia, acetic acid, oleic acid, surface active matters.

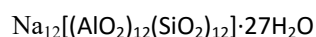
### INTRODUCTION

The study examined adsorption characteristics of synthetic 4A zeolite (producer COPO-2, "MIRA" Italy) and its cation modified form (K-PAM). Modification was performed with surfactant – pröpagen (triethanol-amine-di- ester-methyl-sulfate). Adsorbates used were alcohol solution of  $\text{C}_{17}\text{H}_{33}\text{COOH}$ , aqueous solution of  $\text{CH}_3\text{COOH}$  and solution of  $\text{NH}_3$ . Concentrations of solutions before and after adsorption were observed volumetrically. Since the substitution of cations in zeolite has a consequence of changing the whole series of characteristics of basic zeolite, the study attempted to influence the behavior of 4A zeolite by introducing cation active surface substance. The process of modification with organic (PAM) resulted in a partial neutralization of negative charge (on the surface of zeolite) and the obtained organominerals had a bigger efficiency of adsorption of harmful components from water and air (1-3). Acid and base

adsorbates were a challenge in this study, conducted as a system model, because in nature we most frequently encounter acid and base pollution.

## EXPERIMENTAL PART

Zeolite 4A (NaA) belongs to the third group of zeolites with the secondary unit – double four-member ring. The composition of unit cell of NaA (4A) zeolite, according to Linden (4):



The surfactant used was pröpagen, which is cation PAM, and according to its composition it is triethanol-amine-di- estermethyl-sulfate. It is mostly composed of  $\text{C}_{16}/\text{C}_{18}$  saturated and unsaturated fatty acids. The modification of 4A sample was performed with pröpagen, mass concentration of  $0.1 \text{ g/dm}^3$ . Modification was conducted from aqueous suspension and calculated quantity of active substance in order to satisfy the capacity of ion exchange. The adsorbates used were:

- alcohol solution of oleic acid,  $c = 0.01\text{-}0.1 \text{ mol/dm}^3$ ,
- aqueous solution of acetic acid,  $c = 0.02\text{-}0.15 \text{ mol/dm}^3$ ,
- aqueous solution of ammonia,  $c = 0.05\text{-}0.2 \text{ mol/dm}^3$ .

The best conditions for reaching adsorption balance were achieved after 3 hours and adsorption temperature of 278K. Adsorbent mass was 1.00 g and the volume of adsorbate solution was  $50 \text{ cm}^3$ .

## RESULTS AND DISCUSSION

The results of adsorption on original and modified samples are presented on diagrams from 1 to 7 and in table 1.

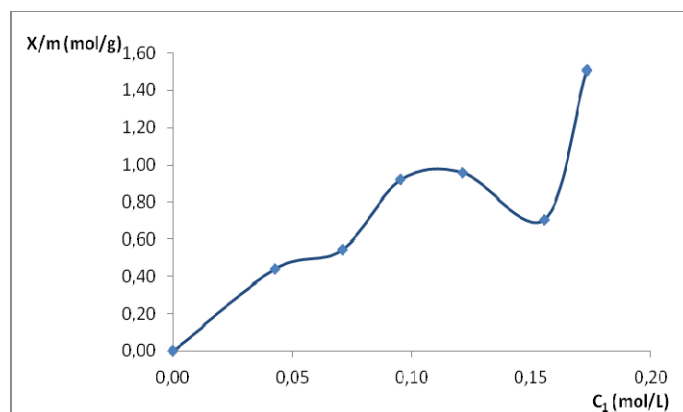
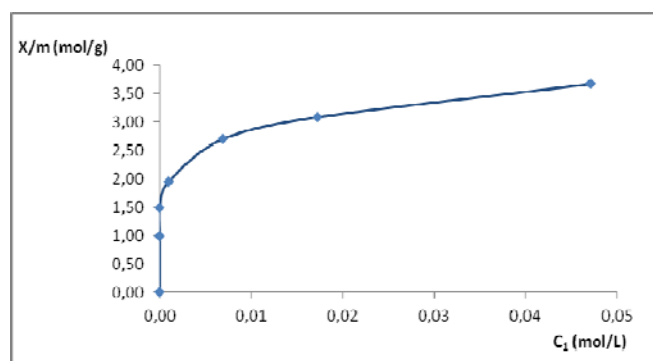
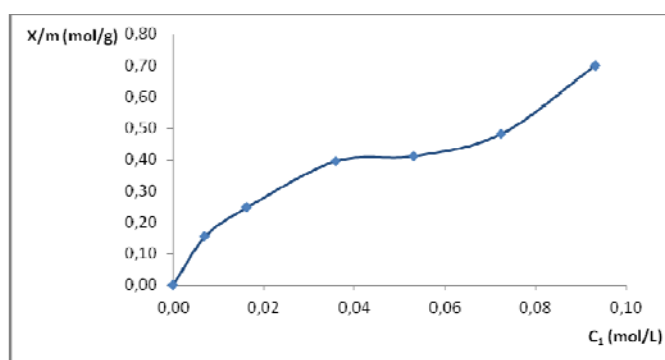


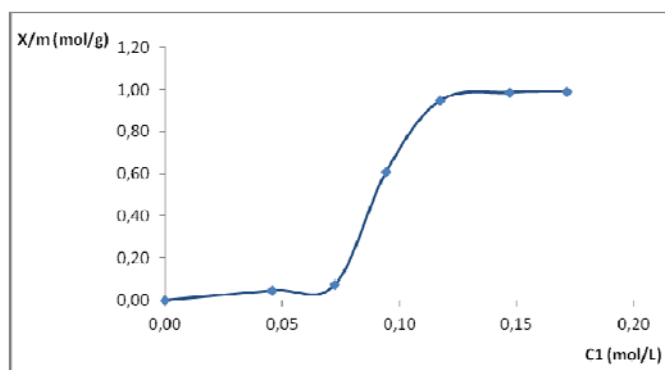
Figure 1. Freundlich adsorption isotherm for system  $\text{NH}_3$ -4A zeolite,  $T = 278\text{K}$



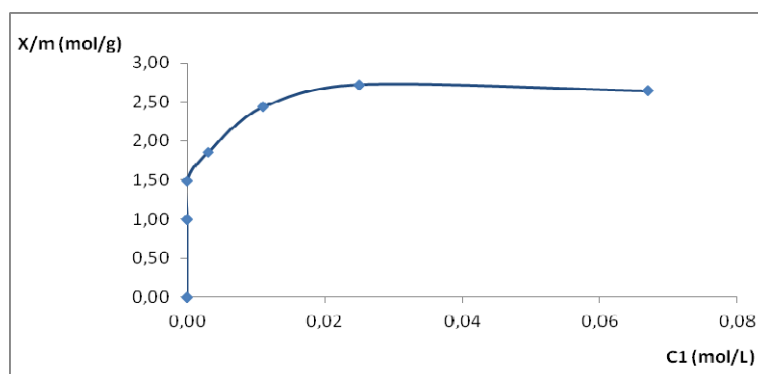
**Figure 2.** Freundlich adsorption isotherm for system  $\text{CH}_3\text{COOH}$ -4A zeolit,  $T= 278\text{K}$



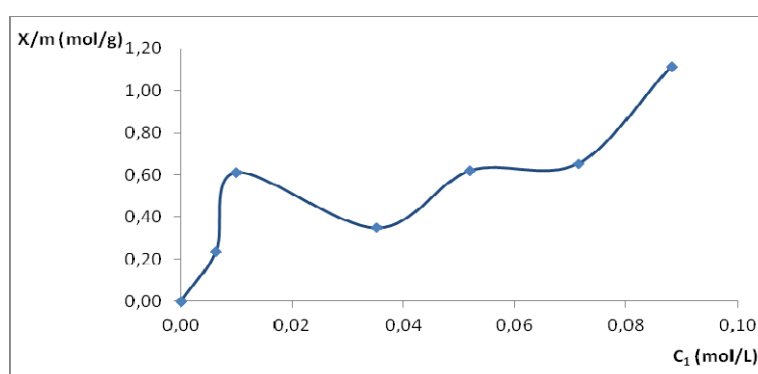
**Figure 3.** Freundlich adsorption isotherm for system  $\text{C}_{17}\text{H}_{33}\text{COOH}$ -4A zeolit,  $T= 278\text{K}$



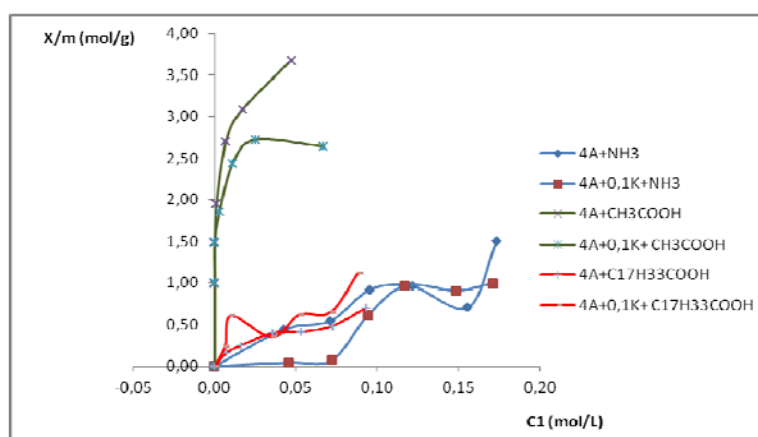
**Figure 4.** Freundlich adsorption isotherm for system  $\text{NH}_3$ -4A+0,1K-PAM,  $T= 278\text{K}$



**Figure 5.** Freundlich adsorption isotherm for system  $\text{CH}_3\text{COOH-4A+0,1K-PAM}$ ,  $T= 278\text{K}$



**Figure 6.** Freundlich adsorption isotherm for system  $\text{C}_{17}\text{H}_{33}\text{COOH-4A+0,1K-PAM}$ ,  $T=278\text{K}$



**Figure 7.** Adsorption isotherms for system of adsorption of base and acid adsorbents on original and modified form of 4A zeolite

**Table 1.** Summary survey of adsorption parameters of base and acid adsorbates on original and modified form of 4A zeolite

ADSORBENT	ADSORBATE	T <sub>ads.</sub> (K)	n	k·10 <sup>5</sup>	Δ <sub>ads</sub> H (J/mol)	x/m · 10 <sup>3</sup> (mol/g)	No · 10 <sup>-20</sup>
4A	NH <sub>3</sub>	278	1,44	0,283	-3328	I=0,55 II=0,96	9,06
	CH <sub>3</sub> COOH		6,12	0,77	-14143	I=1,49 II=2,70	25,24
	C <sub>17</sub> H <sub>33</sub> COOH		1,87	0,074	-4322	I=0,4	2,41
4A+0,1K -PAM	NH <sub>3</sub>	278	1,44	0,22	-3328	I=0,04 II=1,00	6,26
	CH <sub>3</sub> COOH		8,35	0,289	-19299	I=2,72	32,76
	C <sub>17</sub> H <sub>33</sub> COOH		2,80	0,052	-6472	I=0,65	3,91

By analyzing obtained results we can see that 4A modified zeolite proved to have best results, particularly at the adsorption of CH<sub>3</sub>COOH. The released heat of adsorption is - 19299 Jmol<sup>-1</sup>, and number of adsorbed molecules of CH<sub>3</sub>COOH by a gram of sample is 32,76·10<sup>20</sup>. Somewhat worse results are given by unmodified 4A sample with the same acid (Δ<sub>ads</sub>H = - 14143 Jmol<sup>-1</sup>, and number of adsorbed molecules 25,24·10<sup>20</sup>). According to the heat of adsorption, which has the value for modified and unmodified 4A: Δ<sub>ads</sub>H = -6472 Jmol<sup>-1</sup> and Δ<sub>ads</sub>H = -4322 Jmol<sup>-1</sup>, respectively, C<sub>17</sub>H<sub>33</sub>COOH gives worse results than CH<sub>3</sub>COOH. Also, values of parameter *n* speak in favor of the claim that modified zeolite is a good adsorbent for C<sub>17</sub>H<sub>33</sub>COOH, and even better for CH<sub>3</sub>COOH (table 1). By further analysis of diagrams and adsorption parameters one may conclude that zeolite 4A (modified and unmodified) was a worse adsorbent for ammonia. With NH<sub>3</sub> we even get same adsorption heat (Δ<sub>ads</sub>H = - 3328Jmol<sup>-1</sup>) on both samples, but it should be noticed that unmodified sample has a bigger number of adsorbed molecules by a gram of sample (9.06·10<sup>20</sup>) than modified 4A (6.26·10<sup>20</sup>). Why did modified sample prove as a better adsorbent for acid adsorbates than for base ones?

The catalytic active centers of zeolites are net hydroxyl groups that act as Brönsted acids or Brönsted bases, Lewis acid centers inside the net, such as tricoordinated Al, i.e. (AlO)<sup>+</sup> species and cations in zeolite net. According to that, the surface charge on the surface of aluminosilicates originates from three sources (5):

- protonation and deprotonation from hydroxyl on the surface,
- isomorphic substitutions of alumina for silicon in the aluminosilicate skeleton,
- sorption of charged species.

For all said, zeolite 4A proved to be a good adsorbent for acid and base adsorbates. By modifying the sample with surface active substance, by the reaction of ion exchange, zeolite cations are substituted by organic cations of PAM, which surface characteristics of zeolite changed from hydrophilic to organophilic ones. This kind of

surface is a very efficient sorbent of nonpolar organic pollutants in water, and because of that modified sample is a better adsorbent for acid than ammonia. Namely, as we know, ammonia in aqueous solution can exist in a nonionic form ( $\text{NH}_3$ ) and in an ionic form ( $\text{NH}_4^+$ ) (6). Since ammonia gets better tied in  $\text{NH}_4^+$  - form, it is most probable that modification of the sample did not affect that and it got equally well tied by Van der Waals forces to the surface of modified and unmodified sample (7). In both cases isotherms register two „plateaus“ each, areas where a layer gets formed of tied particles from aqueous environment on the surface of adsorbent with somewhat bigger number of adsorbed molecules ( $9,06 \cdot 10^{20}$ ) on 4A than on modified 4A ( $6,26 \cdot 10^{20}$ ). Here one cannot exclude the possibility that the applied PAM affected adsorption of ammonia in the way of transferring chemisorptions into physical adsorption.

Application of PAM, whose pH = 2.5-3.5, could produce a change of the surface charge of aluminosilicate, i.e. protonation and deprotonation of hydroxyl groups of its surface, i.e. hydroxyl groups can get or lose protons (8,9):  $\text{=OH} + \text{H}^+ \leftrightarrow \text{OH}_2^+$ , by which surface becomes cationic or positively charged. Such surface obviously suited better the adsorption of  $\text{CH}_3\text{COOH}$  and  $\text{C}_{17}\text{H}_{33}\text{COOH}$ . When we take a look at the surface of molecule  $\text{CH}_3\text{COOH}$  ( $0.0359 \text{ nm}^2$ ) and molecule  $\text{C}_{17}\text{H}_{33}\text{COOH}$  ( $0.68 \text{ nm}^2$ ), it becomes clear why  $\text{CH}_3\text{COOH}$  gets better adsorbed than  $\text{C}_{17}\text{H}_{33}\text{COOH}$ . It was more difficult for a bigger molecule of oleic acid to get adsorbed in the interior of zeolite pore, because of which its adsorption could be performed only on the outer part. That is why the adsorption of oleic acid is a little poorer than adsorption of acetic acid.

## CONCLUSION

- The influence was examined of modification of synthetic zeolite, faujasite 4A class, by cation active matter of präpagen.
- Modified sample gives a lot better results at adsorption of acids, while adsorption of bases was the same on modified and unmodified zeolite.

## REFERENCES

1. Jaynes, W.F., G.F. Vance, Btex sorption by organo-clays: cosorptive enhancement and equivalence of interlayer complexes, *Soil.Sci. Soc. Am. J.*, **60**(8), 1742-9 (1996)
2. Summers, R.S., P.V. Roberts, Activated carbon adsorption of humic substances II, *J. Colloid Interface, Sci.*, **122**(2), 382-97 (1988)
3. Karanfil T., Kilduff A., Role of granular activated carbon surface chemistry on the adsorption of organic compounds, *Environ. Sci. Technol.*, **33**(18), 3217-24 (1999)
4. Breck D.W., *Zeolite Molecular Sieves*, Wiley Inc., New York (1974)
5. Schwarzenbach, R.P., Gschwend P.M., Imboden D.M., *A surface phenomenon which may be either absorption or adsorption*, *Environmental Organic Geochemistry*, Sons, Inc., 235 (1990)



6. Bodroža D., „Hemija na površini nekih MFI, FAU i BEA zeolita“, Magistarski rad, Tehnološki fakultet, Banja Luka (2015)
7. Bodroža D., S. Sladojević, J. Penavin Skundrić, D. Lazić, Lj. Vasiljević, B. Skundrić, Study of BETA Zeolite Physical-chemical Characteristics by Observing Adsorption of Some Acid and Base Components from Aqueous Solutions, Proceedings of XXIII International Conference “ Ecological Truth”, Kopaonik, Serbia, 128-136 (2015)
8. Levi Z., Ponašanje nekih alumosilikata i njihovih katjon modifikovanih formi pri adsorpciji fenola iz vodene sredine, Doktorska disertacija, Tehnološki fakultet Univerziteta u Banjaluci, (2010)
9. Levi Z., J. Penavin, S. Sladojević, J. B. Škundrić, D. Bodroža, B. Škundrić, *Study of Phenol Adsorption from the Aqueous Environment on the Modified Alumina*, The Second Scientific International Conference, Water and Nanomedicine, Book of Abstracts, Banja Luka, 48, (2011)



## THE POSITIVE EFFECTS OF THE NEW TECHNOLOGY TO THE AIR POLLUTION CAUSED BY SO<sub>2</sub> IN BOR AND ITS SURROUNDINGS

Dusanka Miljkovic\*, G. Lazic, B. Todorovic, M. Popovic

RTB Bor, TIR DOO, Djordja Vajferta 20, 19210 Bor, SERBIA

\*[tirekologija@gmail.com](mailto:tirekologija@gmail.com)

### ABSTRACT

The technology choice for the Smelter and Sulfuric acid plant was based in accordance with the best available techniques for this kind of production. The basic criteria for this are the necessity to conserve energy and the necessity to improve environmental protection. The assessment of the successfulness of the new technologies is best described with the evaluation of the air quality in the impacted area. In this study, SO<sub>2</sub> concentration and the number of days with increased concentration compared to the GVI are provided, depending on the quantity of the processed concentrate, as well as the quantities of the produced sulfuric acid. The comparisons are conducted for the winter period (November 2014 – February 2015) when the old technology was in operation compared to the same period (November 2015 – February 2016) when the concentrate processing and sulfuric acid production were done by means of the new technologies, for the measuring spots City Park, the Faculty and Slatina.

**Key words:** Sulfur dioxide, FSF.

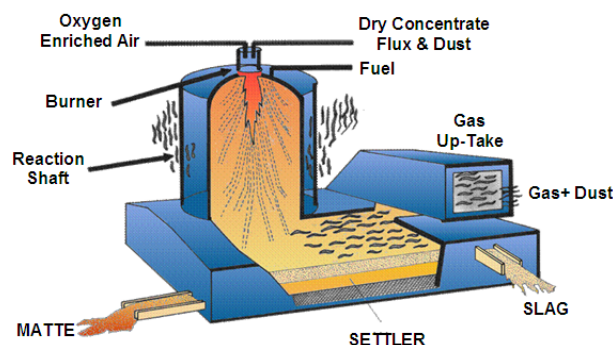
### INTRODUCTIONS

The existing copper Smelter and refinery plant in Bor was started in 1961, as the cutting-edge at that time. During the period of the largest expansion of the RTB Bor, during the 1980s, copper production reached more than 100 thousand tons per year, and large amounts of SO<sub>2</sub> and suspended particles containing heavy metals were emitted into the air. For the purpose of environmental pollution reduction and in order to cut production expenses, the smelter and sulfuric acid plant were reconstructed. The new flash smelting technology was adopted, which provides better copper return, and the designed capacity of the furnace is 80 thousand tons of cathode copper per year. The choice of the technology was made in accordance with the best available techniques for this kind of production. The capacity of the sulfuric acid Plant was also increased, from 100 to 400 thousand tones per year. In this way, the pollution in Bor, which surpassed the allowed limit value up to one hundred times, will be reduced to a minimum.

## MATERIAL AND METHODS

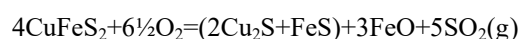
One of the basic criteria for evaluation of the successfulness of the metallurgy process is the opportunity to use sulfur and to bind sulfur dioxide. This directly influences the air quality in the impacted zones. The autogenic processes of the copper concentrate smelting provide binding of more than 95% of sulfur from the smelting feed mixture.

The Outokumpu (FSF) process belongs to the autogenic processes of the sulfide concentrate smelting in the levitating state. The dried feed is injected through the burner, placed at the vault of the reaction manhole, together with the previously heated air enriched with oxygen. In the gas chamber of the manhole the oxidation reactions occur. The heat of the exothermal reactions is sufficient to smelt the feed components and to maintain the heat balance of the furnace. The smelted feed from the manhole falls onto the lower part of the furnace, where the extraction and layering of the slag and copper matte occurs [1].



The smelting products are the copper matte, slag and gas. The dry mixture feed together with the oxygen enriched with the process air, forms an even suspension which reacts in the reaction manhole. The suspension is heated, ignited and burns quickly in order to form copper matte and slag in the settling basin.

The chief reaction in the manhole can be presented in the following way:



The process takes place mostly with the considerably large oxygen enrichment in order to provide adequate feed ignition in the reaction manhole.

The removal of the dust from the remaining effluent process gases from the FSF is conducted by means of the dry electrostatic precipitator (ESP) [1].

The smelter Plant in Bor has got two horizontal Pierce Smith type converters. The liquid copper matte is transported by means of cranes in the pots whose volume capacity is 6 m<sup>3</sup> to the PS converters. The converting process is not continuous, and is autogenic and based upon the oxidation reactions of the metallic sulfides that are present in the copper matte. Those are the iron and copper sulfides.

The process itself is divided into two periods:

- the first period or the slag blow phase is mostly not continuous and during it, above all, iron is removed and copper concentration in the converter foam is conducted, until the so called white matte is finally formed (the pure copper sulfide).
- the second period or the copper blow phase is a continuous process, and is interrupted only when the dosing of the pure copper input is being done, which is necessary in order to regulate the temperature process;

The cooling and removal of various impurities from the effluent gasses is conducted in the scrubbing (rinsing) gas system. The gas first enters the primary scrubber where it is watered and rinsed by means of the weak acid spraying in the direction opposite to the flow through the spraying nozzles with a large opening. After the cooling tower with the filling, the gas flows through the secondary reversible spray located in the input pot for the final scrubber with the reversible spray. This is where the additional dust removal process will occur before the gas enters wet electrostatic precipitators [2].

The sulfuric acid Plant is supplied with gas from the two sources (Flash smelting furnace and Pierce Smith converters). The gases coming out of the flash furnace and converters contain dust, metallic smoke, halogen compounds, and various other mixtures that need to be precipitated. The precipitation and cooling of the gas is conducted in the Venturi scrubber and cooling tower separately for the flash furnace flow line, and separately for the gas that is coming from the Pierce Smith converters (each to its own Venturi scrubber and cooling tower). The scrubber for gas precipitation can have many different physical configurations, but all of them have a common goal, which is to forward the gas to the primary contact with the scrubber solution which simultaneously cools and washes the gas. The suspended particles in the gaseous phase, as well as some of the smoke condensates during the gas cooling stage will be captured. Also, SO<sub>3</sub> from the gas will appear in the solution and thereby increase the solution acidity. After the gas has passed through the Venturi scrubber, it enters the cooling tower. The cooling tower is a cylindrical pot in which the gas enters from the bottom and goes through the filling in the direction opposite to the weak acid.

After passing through the Venturi scrubber and cooling tower, the gas from the flash furnace and converters flow line merges, and merged in this way goes into the final cleansing stage in the wet electrostatic precipitator (WESP).

They represent the final stage of the gas precipitation for the purpose of removal the remaining impurities from the input gas and to provide the "optically clean" gas for the drying tower, double conversion and double layered absorption of the SO<sub>2</sub> gas [2].

## **RESULTS AND DISCUSSION**

The SO<sub>2</sub> concentration and the number of days with the concentration higher than GVI [3], depending on the quantity of the processed concentrate, as well as the quantities of the produced sulfuric acid, are presented for the measuring spots City Park, the Institute, the Faculty and Slatina [4].



**Figure 1.** The distribution of the representative measuring spots of the SO<sub>2</sub> immission

The measuring spot City Park is located 850 m away in the southwest direction of the smelter chimney. The City Park is located in the downtown, in the vicinity of the administrative, commercial and business objects, several elementary schools, kindergartens, the city marketplace, the Faculty and the hospital. In this area the east wind is predominant, which belongs to the group of the most frequent winds during a year.

The measuring spot the Institute is located around 1900 m away from the smelter complex. The measuring of the sulfur dioxide in this location is significant due to the highest population density in this part of the city. The measuring spot the Faculty is located 1300 m in the WNW direction compared to the pollution source in the urban-industrial city zone, located next to the city hospital.

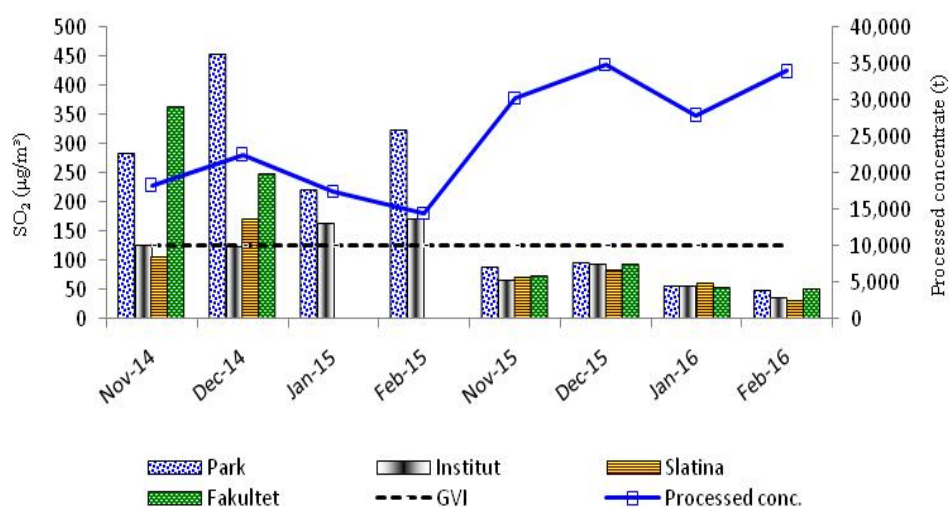
The measuring spot Slatina is a rural suburbia, located around 6000 m away from the impacted zone, in the direction of the predominantly north east wind. The comparisons are conducted for the winter period (November 2014 – February 2015) when the old technology was in operation compared to the same period (November 2015 – February 2016).

Figure 2 shows the average monthly SO<sub>2</sub> concentration compared to the quantity of the processed concentrate, for the given period.

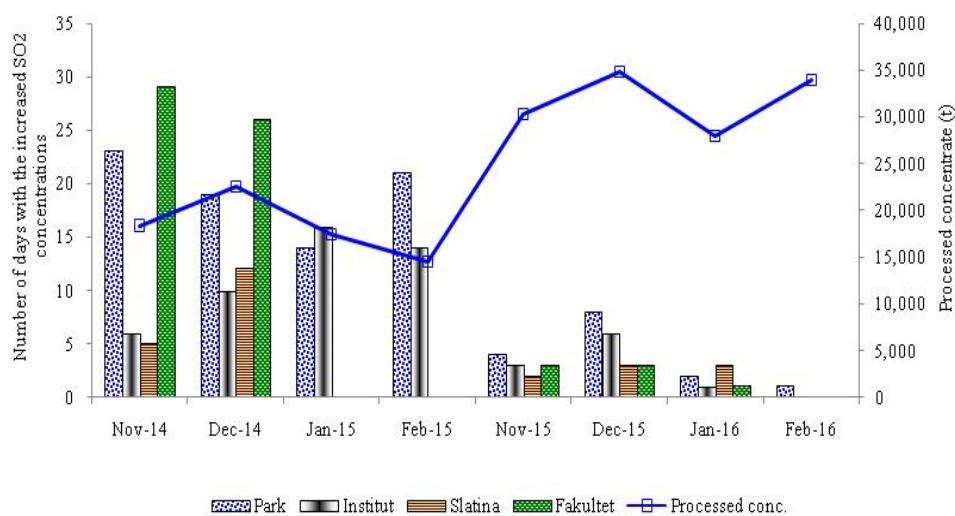
Figure 3 shows the number of days with the increased SO<sub>2</sub> concentrations with regard to the GVI, and compared to the quantity of the processed concentrate for the given period.

Figure 4 shows the average monthly SO<sub>2</sub> concentration compared to the quantity of the produced sulfuric acid, for the given period.

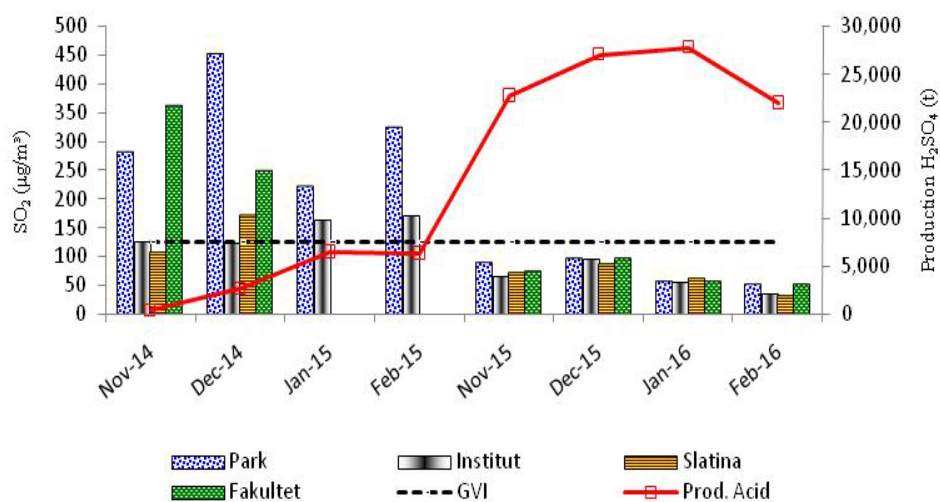
Figure 5 shows the number of days with the increased SO<sub>2</sub> concentrations with regard to the GVI, and compared to the quantity of the processed sulfuric acid for the given period.



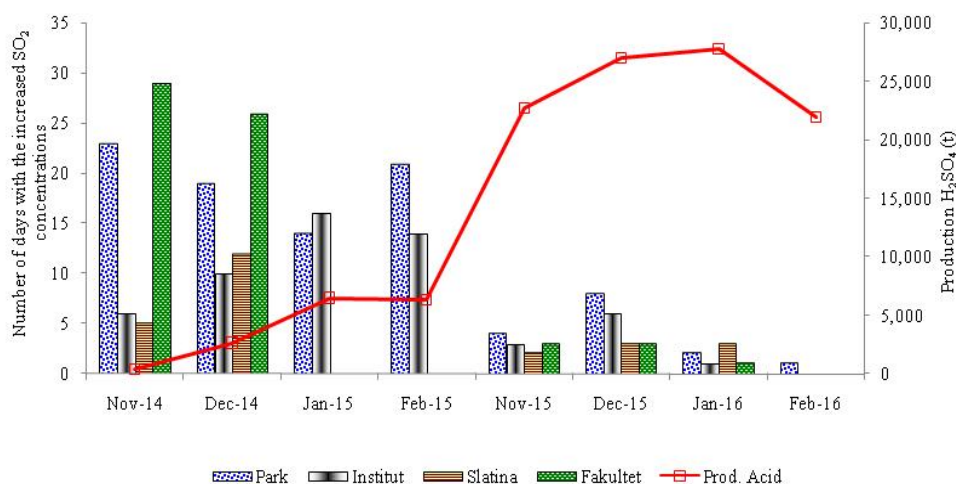
**Figure 2.** Average monthly SO<sub>2</sub> concentration compared to the quantity of the processed concentrate



**Figure 3.** Number of days with the increased SO<sub>2</sub> concentrations with regard to the GVI, and compared to the quantity of the processed concentrate



**Figure 4.** Average monthly SO<sub>2</sub> concentration compared to the quantity of the produced sulfuric acid



**Figure 5.** Number of days with the increased SO<sub>2</sub> concentrations with regard to the GVI, and compared to the quantity of the processed sulfuric acid

By comparing average monthly SO<sub>2</sub> concentrations during the period when the old technology was in operation to the same period when the concentrate processing and sulfuric acid production was taking place with the new technologies, for the mentioned measuring spots, it can be concluded that during the period when new technologies were in operation, a significantly larger amount of the concentrate was processed and a much

larger amount of sulfuric acid was produced, and at the same time, the average monthly concentration was significantly reduced.

By comparing the number of days with the increased SO<sub>2</sub> concentrations with regard to the GVI, during the periods of operation of the old and new technologies, and with regard to the concentrate processing and sulfuric acid production for the mentioned measuring spots, it can be concluded that during the period when the new technologies were in operation a much larger amount of the concentrate was processed and a much larger amount of sulfuric acid was produced, and the number of days with the increased SO<sub>2</sub> concentrations with regard to the GVI was reduced to a minimum.

### **CONCLUSION**

For the purpose of reducing environmental pollution and cutting production costs, the smelter and sulfuric acid plant were reconstructed. The new flash smelting technology was adopted which provides better copper return. The sulfuric acid plant was designed in such a way as to be able to process all of the technological gases from the flash furnace and PS converters and to convert sulfur dioxide to sulfuric acid. The successfulness assessment of the new technologies is presented with the air quality evaluation with regard to the average monthly SO<sub>2</sub> concentrations and the number of days with the increased SO<sub>2</sub> concentrations with regard to the GVI in the impact areas.

The positive effects of the Smelter and sulfuric acid Plant to the SO<sub>2</sub> air pollution in Bor and surroundings are highly beneficial which can be seen from the attached diagrams.

During the period when the copper concentrate processing and sulfuric acid production were taking place according to the new technologies, the average monthly SO<sub>2</sub> air concentration was significantly reduced, the number of days with the increased SO<sub>2</sub> concentrations with regard to the GVE was reduced to a minimum, along with much greater amounts of processed concentrate and produced sulfuric acid, compared to the period when the old technologies were in operation.

### **REFERENCES**

1. Assessment of environmental impact of the project " Reconstruction of the copper smelter and the construction of a factory for the production of sulfuric acid", May 2011.
2. IC TMF, Chief Technology upgrade project of sulfuric acid plant,, University of Belgrade, Belgrade, 2014
3. Decree on conditions and requirements for monitoring air quality ("Official Gazette of RS", No.11 / 2010)
4. The Institute for Mining and Metallurgy Bor, reports on testing air quality in Bor; 2014, 2015, 2016.





## MONITORING OF SURFACE WATER

Violeta Cibulic\*, M. Trifunovic, V. Presburger Ulnikovic, N. Staletovic, S. Polavder

University "Union-Nikola Tesla", Faculty of Ecology and Environmental Protection  
Belgrade, SERBIA

\*[vcibulic@gmail.com](mailto:vcibulic@gmail.com)

### ABSTRACT

The monitoring strategy of surface water is committed to the national environmental policy, with particular emphasis on the development dynamics of national institutions specialized in testing and study of water quality, their financial, personnel and instrument security, with a plan of continuous improvement and innovation of the same. Monitoring of surface water in the catchment level is an integral part of regional and national system of control over the state line.

Water monitoring represents a continuous monitoring of hydrological, quantitative and qualitative characteristics of surface waters: physicochemical, radiological, hydro-biological and microbiological properties of the river ecosystem, including water, sediment, suspended sediment and using standard testing methods.

The strategic goal is monitoring, in addition to protection and control of water supply sources, and the function of constant control of the water course ecological value in terms of protection of their ecological status and natural values.

**Key words:** monitoring of surface water quality indicators, ecological status.

### INTRODUCTION

Monitoring of surface water is a long-term implementation of standardized measurement and observation of water in order to define the status and changes in water quality. Systematic tests allow confirmation and decision-making related of water quality, such as the use of water for water supply, recreation, or agricultural use, in a production process, or just providing special protection and conservation of water resources and their ecological status.

Permanent monitoring and ensuring the quality of water is a prerequisite for the formation of a successful system of water management and planning incentives to prevent the spillage of contaminated water and hazardous substances into natural water ways. The aim of the application of modern production technology, the introduction of anhydrous recirculation and technology, and pollution treatment at the source in a manufacturing process, known as "black spots". The basis for the sustainable use of water courses and water resources is the effectiveness of the implemented measures and activities to verify the data, results and evaluations of the actual state of tested water courses.

## **GENERAL CONSIDERATIONS**

The strategy of monitoring for the quality of surface water has to be commitment in the national environmental policy at the state level, with special emphasis on the dynamics of the development of national institutions specialized in testing and study of water quality, their financial, personnel and instrument security with a plan of continuous improvement and innovation of the same. Monitoring of surface water quality in the catchment level is an integral part of regional and national system of control over the state line, and is formed towards the material and human capabilities, with help, suggestions and controls.

The basic unit of the model organizations of monitoring for the natural hydrological river should be accompanied by the establishment of administrative and political organizational forms of water quality monitoring.

Monitoring system of water quality must be continually modernized and rationalized. In this context it is necessary to work constantly on network measuring stations, testing, automation testing process, the selection of tested quality indicators, as well as the number of test locations places- tests.[1]

Water monitoring represents continuous monitoring of hydrological, quantitative and qualitative characteristics of surface waters: physicochemical, radiological, hydro-biological and microbiological properties of the river ecosystem, including water, sediment, suspended sediment and bioindicators. In all these cases the quality control is using standard test methods, one of the main goals of the mass balance of pollution in the local and regional context or a load of water in the entire catchment area. In this sense, carry out continuous review and editing of the list of indicators and frequency of their investigation in accordance with the expected pollution sources identified and possible migration paths. Implementation of monitoring program, when all prescribed conditions are met, equal confides that public service and private specialized organizations. The strategic goal is monitoring, in addition to protection and control sources of water supply, with the function of constant control of the ecological water course value in terms of protection of their ecological status and natural values. It is also very important for active public participation in the process of information and consultation on the situation and the causes and assessments of water quality.[2,3]

## **MONITORING PLANNING OF SURFACE WATER**

The monitoring strategy should be adjusted over time to the needs and knowledge of man, as well as increasing demands for information. At the same time, one should not neglect the necessary continuity tests, but take into account the results of previous measurements and observations. Here special attention should be paid to potential sources, permanent and the other from which contamination due to water courses in the event of a disaster or accident.

### **Potential sources of pollution**

The strategic commitment to the future system for monitoring surface waters should provide ambiguous information and functions that relate to the quality of surface

water, early warning of accidental spills and emergency conditions or the development of targeted testing and migration of pollutants in the water. Planning parameters, frequency and location tests in the implementation monitoring must be consistent with the possible occurrence of pollution from real, potential pollutants up stream. Concluded pollution in permanent, temporary or accidental concentrations, the key - output profiles examined basins, forms the basis for dimensioning monitoring program for this water.

The basis for sizing monitoring program for water, the key - output profiles examined basins, it concluded pollution in permanent, temporary or accidental concentrations of these waters. The strategic goal is to be the key to most of these profiles with the major basins and sub-basins, depending on an assessment of risk or harm, dimensioned constantly - daily testing of water quality and the establishment of automatic stations - monitor.

Accidental spill - pollution contribute to high pollution of surface waters abundant outpouring of the content of toxic substances. Damage that this may occur on a larger territory, migration and distribution of these substances into the aquatic environment, imposes the need to introduce high-risk because of the continuing oversight in the down stream area from potential sources of accidental substances. Cells water quality, which assume this function will take precedence instrumental furnishing, communications, monitoring and automation support personnel, in order to alarm and prevent the consequences in case of accidents. This primarily refers to the position of the monitor stations at border profiles, and certainly the cells downstream from large industrial complexes at high risk.

If the risk analysis on a particular sector of the water course states the possibility of contamination specific hazardous substances to such a plan in expected pollution parameter water monitoring programs, high frequency control. So, the analysis of the risk assessment must be used in assessing the priorities for inclusion of specific parameters pollution monitoring program recipients, especially in the work of respective physical, chemical and toxicological indicators. Dependence of biological indicators and chemical pollution may be useful for monitoring the quality of selective accumulation of pollution or to identify hazardous substances in the relationship between dosage and induced effects, ie exposure and risk characteristics of the consequences.[4]

### **Ecological character**

Good quality water catchment areas in the ecological sense obliged to spills from coastal areas have large adverse effects on the ecosystem. Organic defining in each case must be taken into account as a factor, along with chemical assessment of the situation, for the total water quality classification. For authoritative assessment of the ecological status it is necessary to separate ecoregions and differences that suggest a peculiar scale to identify the type of water course, or differences that are important for the gradation of ecological status.

Basic elements for the ecological assessment of the situation of the catchment area or water course is certainly the view of biodiversity and the recognition and description of the reference quality. In this regard it is important to consider the phenomena of migration of aquatic organisms and species, which is a disturbing factor of basic ecological characteristics. Certain types of organisms spread outside their natural range

and this is one of the most aggressive negative effects on the environment and aquatic ecosystems.

The changes that these introduced species can cause in aquatic ecosystems are important and that is why monitoring the development and distribution of these species and the effects on the environment should be systematically monitored.[4,5]

### **Information system and water modeling**

The ultimate purpose of monitoring is to obtain reliable information - reliable data on the state of water quality in a given moment. The collected data is processed to be used in the easiest way right now and in the future. The scope of the required information and the need for it should be a reflection of the current policies and strategies to manage this resource. Disclosure of information is the final stage of data management, and their publication is carried out according to pre-established protocols on data analysis. The frequency and level of delivery of processed data depends on the user. Data should be mandatorily statistically processed and presented as summary information in an acceptable manner, for example tabular, graphical display with the geographical location of the test.

The numerical, analytical or statistical models have a special role in the design and monitoring of surface water assessment of their condition, whether they are used for the estimation of the expected occurrence of pollution, optimize network monitor cell or in assessing the effectiveness of conducted tests and to determine the effect of pollution on surface water. Computer models water courses or drainage area associated with georelevant databases allow analysis of impacts and proposed mitigation measures of pollution, especially in terms of system simulation flow and transport of pollutants substances.

## **WATER MONITORING**

### **General aspects of monitoring program**

In the process of the formation of monitoring program for this cycle should involve all stakeholders in a river basin. The monitoring network shall be designed depending on the required information. The monitoring program and plan its implementation - functioning, covers many aspects, such as field measurements, sampling (sample collection, preparation, methods of storage and transport of samples), chemical and microbiological analysis and data collection. Therefore, in the process of monitoring programs equal attention should be given to all these elements. Planning monitoring program includes the selection of indicators of water quality, location, frequency of testing, field determination, measurement and laboratory analysis. The basic rules for a successful program of monitoring and analysis of water quality are:

- Monitoring program and the necessary information to define and adjust the level foreseen and secured financial resources and equipment;
- Consider the type and characteristics of the water course (usually preliminary research), with coverage of the whole hydrological year;
- Define component tests (matrix) of water systems (water, suspended and / or sedimentary matter, biological indicators).

- Depending on the purpose of monitoring tests to determine the parameter, the type of samples, frequency of testing and station locations must be carefully selected in accordance with the required information. Mobile, field equipment and laboratory facilities shall be elected in accordance with the specificity required data, the accuracy and sensitivity of the assay, and not vice versa;
  - Monitoring of surface water quality should be monitored necessary hydrological measurements and analyzes;
  - Organize full operational review and processing of data by internal and external control. The laboratory must be accredited institutions engaged in this type of study;
  - The data and findings should be offered to decision makers not only in the form of tabular measured values already in the form of analysis and assessment of situation and expertise with relevant recommendations, solutions and administrative measures;
  - The monitoring program should be periodically evaluated from perspective of needs and experiences, especially if they are part of basin changed conditions and demonstrated the extraordinary effects, either natural or induced effects.
- The program must be flexible in order to be applied on the whole and at the confluence of its individual parts. Collecting data monitoring is done centrally so that it can be used for general and overall assessment of change of water quality. In the first place it is necessary to determine the place where they are monitor for quality of water, then set the parameters for testing at each of the sites, determine the method of sampling, transport and storage of samples, sampling frequency (collective, proportional composite sample), methods of laboratory testing.[5]

#### **The frequency of water quality testing**

The water course of proper quality cyclical changes can take place in different time intervals (days, weeks and years), but the frequency of testing should be aligned with the quality of the water regime and testing (sampling) performed in the same interval. Tests water course should be performed systematically, taking care to cover the entire hydrological years - all seasons and different weather conditions. Current samples that are sufficiently representative, can be taken in normal conditions for a period of small and medium-sized water, while in the case of extraordinary hydrological conditions - high water leads to rapid fluctuations in the quantitative and qualitative characteristics of the water course. These fluctuations are particularly pronounced in intense precipitation. Therefore, in such circumstances, taking the necessary two-hour and eight-hour composite samples, which indicates better water quality in extraordinary hydrological conditions. The frequency of testing is determined to provide an acceptable level of confidence and precision. On other streams water quality will be controlled by 12 times a year - once a month, while the sediments examined twice a year.[6,7,8]

#### **Determination of ecological status of surface waters**

The quality elements for surface water testing and classification of their ecological status, using typical biological parameters, chemical and physico-chemical elements supporting the biological elements, morphological conditions, the hydrological

regime of oxygen regime, salinity, acidity, concentration of nutrients, specific pollutants, substances - pollutants identified in examined water course, as well as other substances discharged in significant concentrations. [8,9]

To assess the adverse effects of pollutants present on the quality of river ecosystems, examine the following parameters as indicators of pollution:

- Dissolved oxygen, BOD5, total organic carbon (TOC), nutrients, pH, temperature conditions, chlorophyll;
- Dangerous substances - identified in water and sediment;
- Plankton community structure, larger animal species bottom, fish, vegetation, sessile algae;
- Reference types;
- Diseases and deformities organisms;
- Physical and hydro-morphological factors (flow, ratio of depth-to-width, adjustable sinks, sediment structure, state coast, land use and density of flooded areas in the river valley.

### **Sampling and laboratory testing**

Sample collection can be continuously in the case of a stationary monitoring stations that continuously automatically record certain quality parameters, then it is a long-term monitoring. If this sample collection going continuously, then it is called environmental monitoring. In this way, describes the state of water quality in wider areas and over a longer period of time.

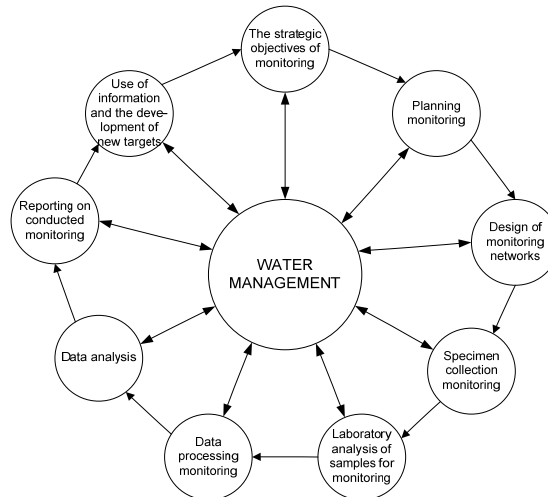
Monitoring to be carried out during a short period of time is usually for a study, project or tied to a specific problem with the aim of defining and finding solutions, and is referred to as short-term monitoring. Sampling of water should be well prepared here, because it is carried out continuously. First, determine the sampling site, clean and take care approach, to prepare the sampling equipment, containers for collecting samples which should be marked, the record of sampling to be filled on the spot and in which are recorded all the data measured on site and any comments that are observed. On the scope of tests to determine the amount of sample required and the manner of their labeling. Also, samples should be adequately preserved if they can not be immediately transported to the laboratory, which is also entered in the record.

During the laboratory analysis it is necessary to do a preliminary study plan, which will include the number of parameters to be tested, movement of sample through the laboratory to establish a system for storing test results and pre-checked equipment. Analyses should be required to work with standard test methods were verified in a given laboratory, or if it is at home methods, they must be validated. It is best to test water samples carried out in accredited laboratories by JUS ISO 17025 standard for this type of testing.[6,7]

### **WATER QUALITY MANAGEMENT**

Following the publication of the report follows the use of information obtained. To analyze the data using an appropriate software packages, which today has a lot on the market. Reports are made periodically or monitoring plan provides for when the report

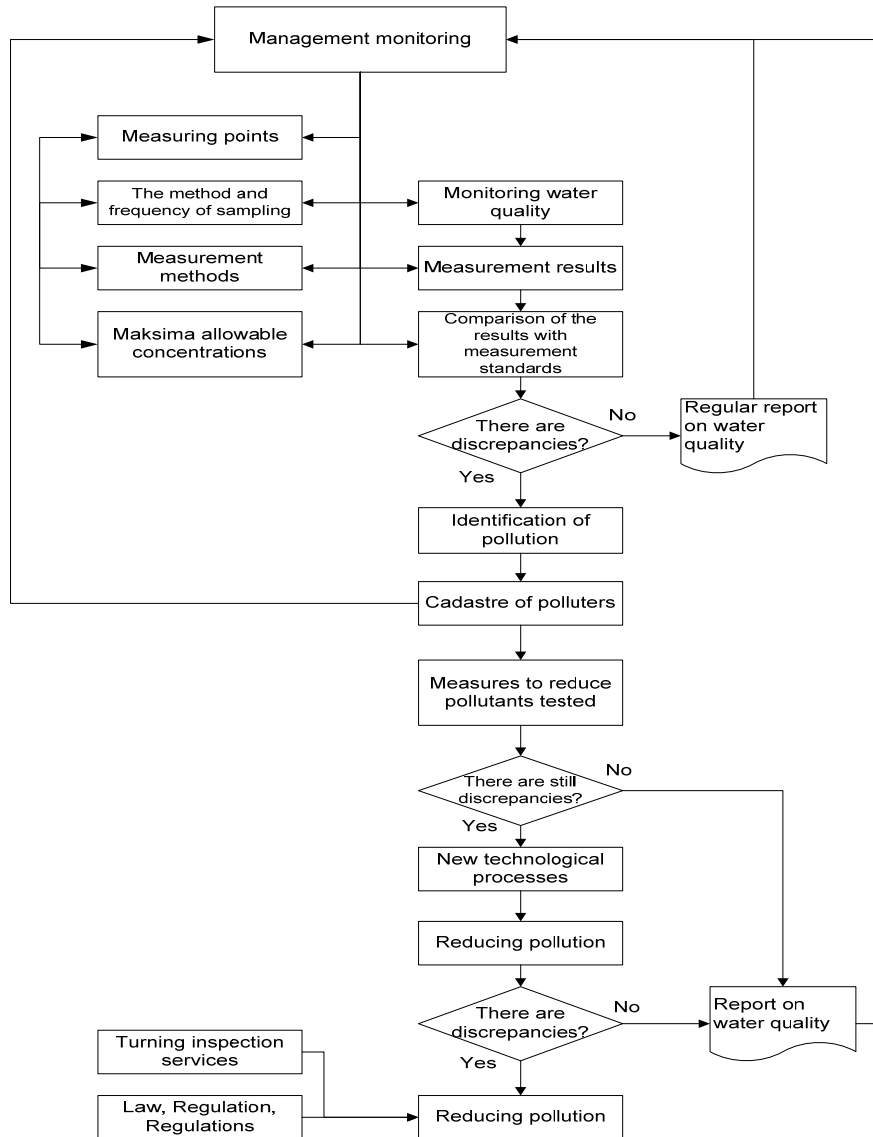
says, how often, predicted format distribution. It is recommended with more graphic presentations. The ultimate goal of monitoring is to collect and transfer the obtained information to a user in order to inspect the status of water quality. Water monitoring and water quality management is seen as a necessary set of interrelated activities that begin by defining the necessary information and end up using the obtained data as information for the management of water quality, image 1 and 2. [8]



**Figure 1.** Cycle water surface monitoring

In the process of formation of monitoring program for this cycle should involve all stakeholders in a river basin. The monitoring network shall be designed depending on the required information. All of these parameters depend on whether the data necessary for environment monitoring, early warning of an accidental situation, or for monitoring surface and waste water.

**Early warning** - An important component of a well-designed monitoring early warning, which consists in the fact that on the basis of monitoring data on weather alert users of water quality changes in the case of accidental situation or any other situation where there is a substantial change in water quality. This early warning is particular interest for down stream users, primarily those who use it as a source of water supply, ie for the preparation of drinking water or for example, irrigation, or other human activities that directly affect people [5]. So, early warning should be alert to protect resources and to point out an error in production or waste water treatment as soon as possible, or in any other source of pollution. Reference is made to the appropriate authorities, defines the need for water sampling and testing, define test parameters, detects source of pollution, and launches initiatives for the prevention and control measures.[8]



**Figure 2.** Management procedures monitoring of surface waters

In order to establish an early warning system reliably, it is necessary to design a continuous monitoring or measuring stations with establishing something abnormal, as well as to provide for automatic sampling and testing of precision -identification pollutants using modern measuring equipment in accredited laboratories.



## **CONCLUSION**

Based on all the above work can be concluded that the process of formation monitoring program should involve all stakeholders in a river basin. The monitoring network shall be designed depending on the required information.

The monitoring program and plan its implementation - functioning, covers many aspects, such as field measurements, sampling (sample collection, preparation, methods of storage and transport of samples), chemical and microbiological analysis and data collection.

The objectives of monitoring water quality, objectivity and quality standards are set in order to assess the quality of water resources, characterization of the ecological status and the establishment conditions for the appropriate use of water and water quality management. Laboratory data define when these conditions will be acquired when the water is acceptable quality for specific purposes. If laboratory results indicate a violation of the standards of quality, it is necessary to implement action to control and determine the source of pollution.

Sample collection can be continuously automatically record certain quality parameters in the case of a stationary monitoring stations , then it is a long-term monitoring. If this sample collection going continuously, then it is called. environmental monitoring. In this way, describes the state of water quality in wider areas and over an extended period of time.

Monitoring to be carried out during a short period of time is usually for a study, project or tied to a specific problem with the aim of defining and finding solutions, and is referred to as short-term monitoring.

The ultimate goal of monitoring is to collect and transfer the obtained information to a user in order to inspect the state of water quality.

## **REFERENCES**

1. Standard methods for the Examination of Water and Waste water, American Public Health Association Washington, 19th Edition 1995., book 1,2;
2. EPA Methods for the Determination of Organic Compounds in Drinking Water, Office of Research and Development Washington DC 20460, 1988;
3. Scott Brennan, Jay Withgott Essential Environment, San Francisco, 2005;
4. Ramon Lorez-Roldan: Integration of advanced off-line and on-line systems for the monitoring of surface and drinking water quality, Universitat Politecnica de Catalunya- Barcelona Tech, Barcelona, 2015.
5. Mijovic S.,Palmar B. Water Quality Monitoring Automation of Rivers in Serbia, Facta Universitatis working and Living Environmental Protection.9 (1),1,2012
6. Burgeois W.,Romain A.C.,Nikolas J, Stuetz R.M.: The use of sensor arrays for environmental monitoring: Interests and limitations., journal of environmental monitoring 5, 852,2003.
7. Rules on the parameters of the ecological and chemical status of surface waters and parameters of the chemical and quantitative status of groundwater, Sl. Gl. RS, br.74/11.
8. Rules on the national list of environmental indicators, Sl. Gl. RS.br. 37/2011



## APPLICATION OF TETRA-OXY Fe(VI) SALTS IN SOLID STATE IN THE OXIDATIVE DEGRADATION OF PESTICIDE CLOMAZONE IN WATER

Ljiljana Nikolic Bujanovic\*, M. Cekerevac, M. Tomic, M. Zdravkovic

IHIS Techno-experts, Research and Development Center,  
Batajnicket put 23, Belgrade, SERBIA

\*[ljiljanan.bujanovic@ihis.co.rs](mailto:ljiljanan.bujanovic@ihis.co.rs)

### ABSTRACT

Investigated was the possibility of degradation of pesticide Clomazone in water using tetra oxy-Fe(VI) salts in solid state, environmentally friendly oxidants and coagulants. The herbicide Clomazone (2-[(2-chlorophenyl)methyl]-4,4-dimethyl-3-isoxazolidinone) is particularly widely used against species of annual broadleaf weeds and grass. The paper presents results of decrease in Clomazone concentration in the water with time in dependence of concentration of added ferrate(VI). It has been shown that the removal of Clomazone from water by ferrate(VI) salts in solid state could be up to 90%, which simplifies and cheapens water treatment process in comparison to the treatment by ferrate(VI) in a solution of concentrated hydroxide.

**Key words:** Clomazone, ferrate(VI), spectrophotometry, degradation.

### INTRODUCTION

Pesticides are biologically active compounds produced for usage in agricultural production in order to prevent or limit harmful effects of biological agents, such as insects, rodents, causal agents of plant diseases, undesirable plant species (weeds) and others. However, application of pesticides is often accompanied by the risk of adverse consequences for environment. Pesticides can contaminate surface and ground water, have harmful effects on cultivated plants, beneficial organisms in the soil and small mammals and birds, be found as residues in food and cause resistance of biological agents.

The frequent occurrence of pesticides in waste water together with other pollutants has led to increased concern for human health, due to their high toxicity, bioaccumulation, carcinogenicity, mutagenicity and endocrine-disrupting effects [1]. Pesticides have a negative impact on the ecosystem because of its toxicity, possible accumulation in the food chain and the fact that their decomposition under natural conditions takes several years.

Soil and water pollution by pesticides may be a direct consequence of their use, subsequent evaporation and deposition, leaching of crops, swelling from the soil surface by atmospheric precipitation and/or leaching through the soil layers to watercourses [2].

Since the application of pesticides can directly or indirectly affect environment, in recent decades, increasing attention is being paid to the study of the presence of pesticides in surface and ground waters, as well as drinking water [3,4].

According to European Union Directive 98/83/EC (1998) maximum allowable concentration for the pesticide present in drinking water is  $0.10 \text{ mg/dm}^3$ , while the total concentration of pesticides should not be greater than  $0.50 \text{ g/dm}^3$ .

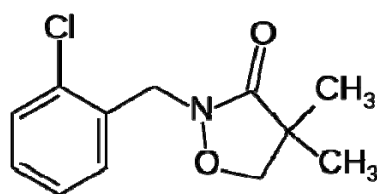
The herbicide Clomazone (2-[(2-chlorophenyl)methyl]-4,4-dimethyl-3-isoxazolidinone) is particularly widely used against species of annual broadleaf weeds and grass. It is highly effective in weed control in the cultivation of soybeans, cotton, rice, sugar cane, corn, tobacco, and a variety of other vegetable crops [5]. However, due to its high water solubility ( $1100 \text{ mg/l}$ ) and long half-life dissipation, averaging from 28 to 84 days, it can cause groundwater contamination [6].

The relative stability of pesticides in the environment, as well as their slow decomposition by photolysis or transformation to toxic products, has led to the need to develop new technologies for purification of water polluted by pesticides. Biodegradation and photodegradation are used as the main techniques in wastewater treatment [7,8]. Biodegradation involves the degradation of pollutants in natural waters and soil in the presence of microorganisms such as bacteria and fungi. However, the above method does not have wide application in industry, mainly because of the long process of purification and low efficiency when the concentration of pollutants is small [9]. Likewise, wastewater containing pesticides can not be effectively treated by biological methods, due to their toxicity to micro-organisms and because their biodegradability is not possible [10]. The development of oxidative decomposition processes results in new treatment processes in the field of chemical water treatment, known as advanced oxidation processes (AOPs) [11]. Degradation of organic compounds using these processes is based on oxidative degradation and removal of organic pollutants under the influence of free radicals, in particular hydroxyl radicals ( $\bullet\text{OH}$ ). The advantage of AOPs over other water treatment processes is that in most cases there is a complete mineralization of pollutants [12]. AOPs methods, commonly used in the treatment of natural waters, can be divided into two main groups: photochemical and chemical processes of oxidation.

Application of oxy-Fe(VI) salts in the treatment of water of various origins showed high efficiency and cost-effectiveness compared to conventional methods. It has been shown [13] that ferrate(VI) as an environmentally safe compounds could be used as oxidizing agents in various processes of chemical synthesis, strong disinfectants which destroy pathogenic organisms, means for coagulation and flocculation, agents for toxins decontamination of chemical and biological origin, agents for heavy metals removal from water and waste water and agents for removal of radioactive elements from radioactive wastewater. Recent research [14] showed that phenols as a frequent pollutant in sewage and river water can be removed 99% to 100% by ferrate(VI) solution of concentration from  $0.1$  to  $2.0 \text{ mg/dm}^3$  in a period of 30 minutes, at  $\text{pH} > 8$  and at temperatures of  $+25^\circ \text{C}$ . Maximum efficiency of oxidation is achieved when molar ratio of ferrate(VI) to the organic impurities was from  $3 : 1$  to  $15 : 1$ . Also, shown was the ability of pesticides removal by ferrate(VI) up to 90% [15].

## EXPERIMENTAL

For examination the possibility of removing pesticide Clomazone, figure 1, from water, an initial solution of Clomazone was prepared at a concentration of 40 mg/L in distilled water. The solutions for calibration curve were obtained by diluting 20 mg/l and 10 mg/l of Clomazone. The pesticide Clomazone, purity of 98%, was purchased from Galenika, Beograd, Serbia. As an agent for investigating the possibility of Clomazone degradation in water  $K_2FeO_4$  in solid state was used. Applied tetra oxy-ferrate(VI) salt was synthesized by electrolysis in a solution of 10 M KOH according to the pre-defined procedure [16]. Crystallization was conducted in ice bath for 24 hours, and then the precipitate was separated by decantation, washed with 20 ml of anhydrous methanol, and vacuum dried for 2 hours at a temperature of 60° C. The purity of  $K_2FeO_4$  salt was determined by chromite analytical method and it was 80%.

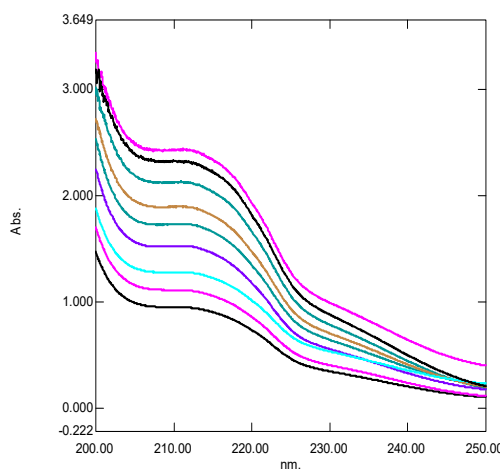


**Figure 1.** The structural formula of Clomazone, 2-(2-chlorophenyl)-methyl-4,4-dimethyl-3-isoxazolidinon

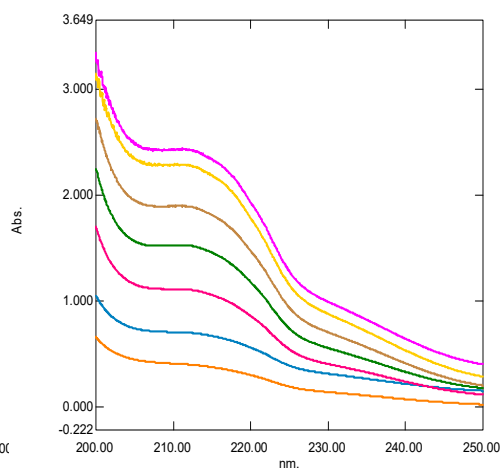
The sample solutions of Clomazone of 150 ml and a concentration of 40 mg/l were treated with 6, 15, and 20 mM/l  $K_2FeO_4$  at pH = 6.5 and a temperature of 23° C, whereby the change in the concentration of Clomazone with time was monitored by UV/Vis spectrophotometer 1800 Shimadzu, Japan. The treatment of Clomazone samples was carried out using a jar test with a four-stirrer unit (Velp JLT4). Based on the obtained calibration curve, the concentration of Clomazone during the treatment was determined.

## RESULTS AND DISCUSSION

The process of pesticide Clomazone removal from water by  $K_2FeO_4$  was monitored with time and it was recorded for different concentrations of  $K_2FeO_4$  using a spectrophotometer, figures 2, 3 and 4. Based on these results and calculated concentrations it could be observed that with a time of 10 to 80 minutes Clomazone concentration decreases. By increasing the concentration of applied ferrate(VI) percentage of Clomazone removal from the solution for the same time is far greater, figure 5.

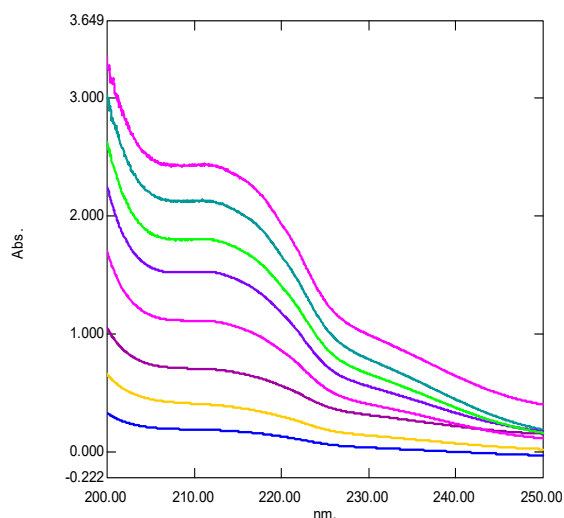


**Figure 2.** Changes of Abs in UV-vis spectrum of Clomazone (initial  $c = 40 \text{ mg/l}$ ) with time and adding of  $6 \text{ mM/l K}_2\text{FeO}_4$

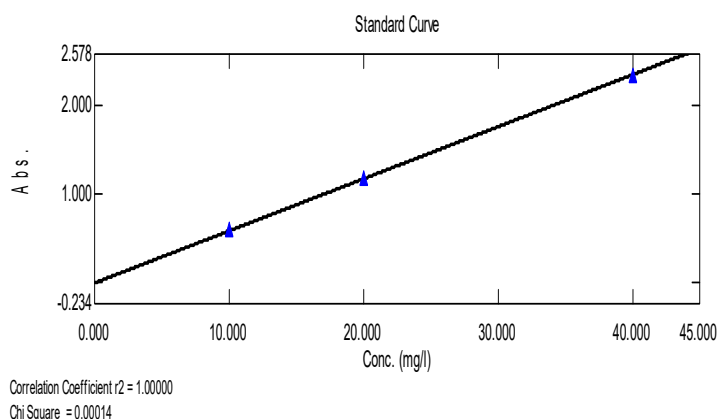


**Figure 3.** Changes of Abs in UV-vis spectrum of Clomazone (initial  $c = 40 \text{ mg/l}$ ) with time and adding of  $15 \text{ mM/l K}_2\text{FeO}_4$

It could be observed that for the applied concentration of ferrate(VI) of  $6 \text{ mM/l}$  the percentage of Clomazone removal is  $53\%$  for a period of  $80 \text{ minutes}$ , while for the applied concentration of ferrate(VI) of  $15 \text{ mM/l}$  and  $20 \text{ mM/l}$  the removal efficiency is  $70\%$  and  $90\%$ , respectively, for the same reaction time. After  $80 \text{ minutes}$  the efficiency of ferrate(VI) is reduced due to its reduction in water which results in weaker effect on Clomazone.

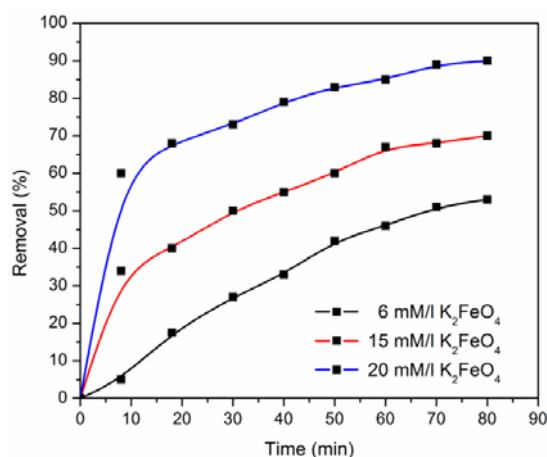


**Figure 4.** Changes of Abs in UV-vis spectrum of Clomazone (initial  $c = 40 \text{ mg/l}$ ) with time and adding of  $20 \text{ mM/l K}_2\text{FeO}_4$



**Figure 5.** Calibration curve of Clomazone at 210 nm for concentration determination

It was demonstrated that the ability of Clomazone removal by ferrate(VI) is more than 90%. The treatment of Clomazone by ferrate(VI) was conducted in distilled water which can be taken only as an indication of the efficiency of Clomazone removal by ferrate(VI). The assumption is that in real terms the effect is different due to the partial consumption of ferrate(VI) on the oxidation of dissolved organic matter and other ions present in the water.



**Figure 6.** The effect of ferrate(VI) in the process of Clomazone removal (initial  $c = 40$  mg/l) at  $pH = 6.5$  with a reaction time

Due to the presence of chlorine and nitrogen atoms in the molecule of Clomazone, complete mineralization of Clomazone results in the production of  $NH_4^+$ ,  $NO_3^-$ ,  $NO_2^-$  and  $Cl^-$ . Based on the obtained results [17] it was found that after 45 minutes of degradation (as needed for a complete degradation of Clomazone) about 100% of

chlorine is converted to chloride, while 45.5% of the total nitrogen is converted to  $\text{NH}_4^+$  (32.6%),  $\text{NO}_3^-$  (12.3%) and  $\text{NO}_2^-$  (1.2%).

Changes in the concentration of intermediates, formate and acetate, was also examined [17]. It has been found that at the beginning of decomposition the concentrations of formate and acetate increase, and then begin to decline after 25 and 30 minutes, respectively.

## CONCLUSION

The possibility of efficient removal of pesticide Clomazone from water by  $\text{K}_2\text{FeO}_4$  obtained by crystallization from the solution of electrochemically synthesized  $\text{K}_2\text{FeO}_4$  was demonstrated. The experiment proved very successful removal of Clomazone from the water, even more than 90%. Due to the harmful effects of Clomazone in underground and river water the experiment which shows Clomazone degradation to  $\text{NH}_4^+$ ,  $\text{NO}_3^-$ ,  $\text{NO}_2^-$  and  $\text{Cl}^-$  makes a reasonable and significant the treatment results of Clomazone by ferrate(VI). Since the experiment was conducted in distilled water further research should be aimed at optimizing the treatment of natural waters with presence of pesticides such as Clomazone by ferrate(VI).

## Acknowledgement

*The work was financially supported by The Ministry of Education, Science and Technological Development, Republic of Serbia, within Projects TRp 34025 and TRp 31080.*

## REFERENCES

1. Eriksson, E., Baun, A., Mikkelsen, P. S., Ledin, A, Risk assessment of xenobiotics in stormwater discharged to Harrestrup Å, Denmark, *Desalination*, 215 (2007) 187-197.
2. Carter, A., How pesticides get into water - and proposed reduction measures, *Water*, 11, (2000) 149-156.
3. Moore, M. T., Lizotte Jr., R. E., Knight, S. S., Smith Jr., S., Cooper, C. M., Assessment of pesticide contamination in three Mississippi Delta oxbow lakes using *Hyaella azteca* *Chemosphere*, 67 (2007) 2184 -2191.
4. Šunjka, D. B, Ostaci atrazina i njegovih degradacionih produkata u podzemnim vodama Srbije, *Doktorska disertacija*, Poljoprivredni fakultet, Univerzitet u Novom Sadu (2012).
5. Zanella, R., Primel, E. G., Gonçalves, F. F., Martins, M. L., Adaime, M. B., Marchesan, E., Machado, S. L. O., Study of the degradation of the herbicide clomazone in distilled and in irrigated rice field waters using HPLC\_DAD and GC-MS, *Journal of Brazilian Chemical Society*, 19 (2008) 987-995.

6. Mervosh, T. L., Sims, G. K., Stollert, E. W., Clomazone fate in soil as affected by microbial activity, temperature, and soil moisture, *Journal of Agricultural and Food Chemistry*, 43 (1995) 537-543.
7. Oller, I., Malato, S., Sánchez-Pérez J. A., Combination of Advanced Oxidation Processes and biological treatments for wastewater decontamination - A review, *Science of the Total Environment*, 409 (2011) 4141-4166.
8. Despotović V., Fotolitička i fotokatalitička razgradnja odabranih herbicida u vodenoj sredini, Doktorska disertacija, PMF, Univerzitet u Novom Sadu (2014)
9. Jing, J., Liu, M., Colvin, V. L., Li, W., Yu, W. W., Photocatalytic degradation of nitrogen-containing organic compounds over TiO<sub>2</sub>, *Journal of Molecular Catalysis A: Chemical*, 351 (2011) 17-28.
10. Hincapie, M., Maldonado, M. I., Oller, I., Gernjak, W., Sanchez-Perez, J. A., Ballesteros, M. M. and Malato, S., Solar photocatalytic degradation and detoxification of EU priority substances, *Catalysis Today*, 101 (2005) 203-210.
11. Chiron, S., Fernandez-Alba, A., Rodriguez, A., Garcia-Calvo, E., Pesticide chemical oxidation: state-of-the-art, *Water Research*, 34 (2000) 366-377.
12. Malato, S., Blanco, J., Vidal, A., Alarcón, D., Maldonado, M. I., Cáceres, J., Gernjak, W., Applied studies in solar photocatalytic detoxification: an overview, *Solar Energy*, 75 (2003) 329-336.
13. Čekerevac M., Nikolić-Bujanović Lj., Mirković M., Jokić A., Flow electrolyser for production an aqueous solution of ferrate(VI) suitable for processing water of various origins, Technical solution: No. 22/1, 01.03.2011., PMF Kosovska Mitrovica
14. Waite T.D., Gray K.A., Oxidation and Coagulation of wastewater effluent utilizing ferrate(VI) ion, *Studies in Environmental Science* 23 (1984) 407-420.
15. Zajícček P., Kolář M., Pruček R., Ranc V., Bednár P., Varma S.R. , Sharma K.V., Zbořil R., Oxidative degradation of triazine- and sulfonyleurea-based herbicides using Fe(VI): The case study of atrazine and iodosulfuron with kinetics and degradation products, *Separation and Purification Technology*, 156 (2015) 1041-1046.
16. Čekerevac M. I., Nikolić-Bujanović Lj. N., Mirković M. B., Popović N. H., Application of electrochemically synthesized ferrate(VI) in the purification of wastewater from coal separation plant, *Hemjska Industrija*, 64 (2010) 423-430.
17. Abramović, B. F., Despotović, V. N., Šojić, D. V., Orčić, D. Z., Csanádi, J. J., Četojević-Simin, D. D., Photocatalytic degradation of the herbicide clomazone in natural water using TiO<sub>2</sub>: Kinetics, mechanism, and toxicity of degradation products, *Chemosphere*, 93 (2013) 166-171.





## CORN COB AND CORN SILK AS BIOSORBENT FOR METAL IONS REMOVAL FROM AQUEOUS SOLUTION: COMPARATIVE ANALYSIS

Marija Petrovic\*, T. Sostaric, M. Stojanovic, J. Petrovic,  
M. Mihajlovic, J. Milojkovic, Z. Lopovic

<sup>1</sup>Institute for Technology of Nuclear and Other Mineral Raw Materials,  
86 Franchet d'Esperey St Belgrade, SERBIA

\**m.petrovic@itnms.ac.rs*

### ABSTRACT

In this work, corn cob and corn silk were used as biosorbent for removal of Pb<sup>2+</sup>, Cu<sup>2+</sup> and Zn<sup>2+</sup> ions from aqueous solutions. Adsorption experiments were performed in batch mode. Corn cob and corn silk were characterized by scanning electron microscopy (SEM). The maximum biosorption capacities of corn cob was found to be 0.049, 0.053 and 0.021 mmol L<sup>-1</sup> for Pb<sup>2+</sup>, Cu<sup>2+</sup> and Zn<sup>2+</sup> ions, respectively. At the other hand, higher values of maximum biosorption capacities: 0.40, 0.22 and 0.19 mmol L<sup>-1</sup> for Pb<sup>2+</sup>, Cu<sup>2+</sup> and Zn<sup>2+</sup> ions, respectively, indicates that corn silk has better adsorption characteristics in comparison to corn cob.

**Key words:** corn cob, corn silk, heavy metals, biosorption, SEM.

### INTRODUCTION

Heavy metals contamination of the environment has become an important issue. Waste water from different industries or mining activities was discharged in to environment and the most frequent heavy metals found in wastewaters are lead, chromium, nickel, zinc, cadmium and copper [1,2]. Even though some of these metal ions are essential for human metabolic system, higher concentration can cause health damage [3]. Due to, very important issue is to protect water from heavy metals pollution. The conventional method such as chemical precipitation, ion exchange, membrane filtration, adsorption on activated carbon and electrolytic process were used for removing heavy metals from wastewaters [4]. High operation cost, low efficiency and insufficient for meeting the environmental requirements are main disadvantages of conventional methods [5]. There is a need for investigation and development of new adsorbent materials which are eco-friendly, inexpensive, and possess high adsorption efficiency for heavy metals removal.

In general, the development of new adsorbent materials has been focused on agricultural by-products. These lignocellulosic materials which are produced in large quantity present very serious disposal problems. At the other hand cellulose structure has a large amount of reactive functional groups and can be used for the adsorption of heavy

metals ions. Through the past decades low cost materials such as: peanut hull, sawdust, bark, rice husk [6–9] and others have been widely investigated as adsorbent for heavy metals removal.

Corn waste, are most abundant in agricultural residues, but most of them are disposed of by direct burning in the field, which causes environmental pollution [3]. The purpose of this study was to investigate the potential use of corn waste biomass (corn cob and corn silk) for  $Pb^{2+}$ ,  $Cu^{2+}$  and  $Zn^{2+}$  ion removal from aqueous solutions.

## MATERIALS AND METHODS OF WORK

Corn silk (KS) and corn cob (OK) was collected from the local fields near Mladenovac (Serbia). KS and OK were washed and dried. Then, collected biomaterials were milled, sieved and storage for further experiments.

Lead, copper and zinc solutions were prepared by dissolving of salts:  $Pb(NO_3)_2 \cdot 3H_2O$ ,  $Cu(NO_3)_2 \cdot 6H_2O$  and  $ZnSO_4 \cdot 7H_2O$  (p.a. grade), respectively, in deionized water. Initial pH values of solutions were adjusted by adding  $HNO_3$  and  $KOH$  solutions (0.1 M) at pH 5.0.

Morphological characteristics of KS and OK were investigated by scanning electron microscopy (SEM). The SEM micrographs are obtained using a JEOL JSM–6610LV SEM model.

Adsorption experiments were performed in batch system. In Erlenmeyer flasks were added 50 mL of metal solution and 0.05 g of KS and 0.3 g of OK. Suspensions were shaken at mechanical shaker during 120 min. At the end of time suspensions were filtered and concentrations of metal ions remaining in filtrate were measured by Atomic Adsorption Spectrophotometer (Perkin Elmer, AAnalyst 300).

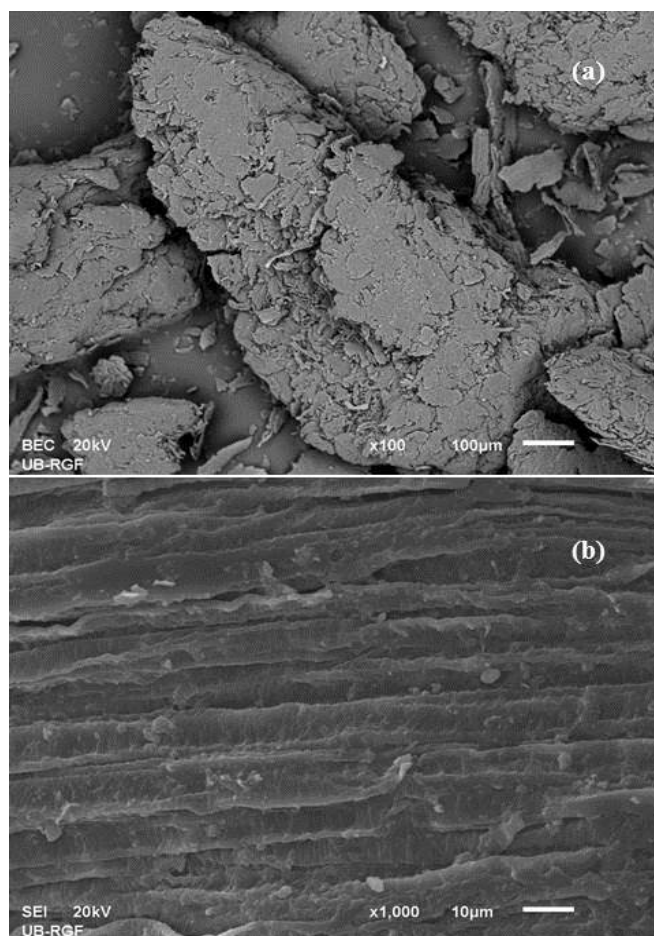
The biosorption capacity of the KS and OK was calculated by following equation (1):

$$q = \frac{(C_i - C_{eq}) \cdot V}{m} \quad (1)$$

where:  $q$  – biosorption capacity ( $mmol L^{-1}$ ),  $C_i$  – initial metal concentration in solution ( $mmol L^{-1}$ ),  $C_{eq}$  – final metal concentration in solution ( $mmol L^{-1}$ ),  $V$  – volume of metal solution (mL) and  $m$  – mass of the biosorbent (g).

## RESULT AND DISCUSSION OF RESULTS

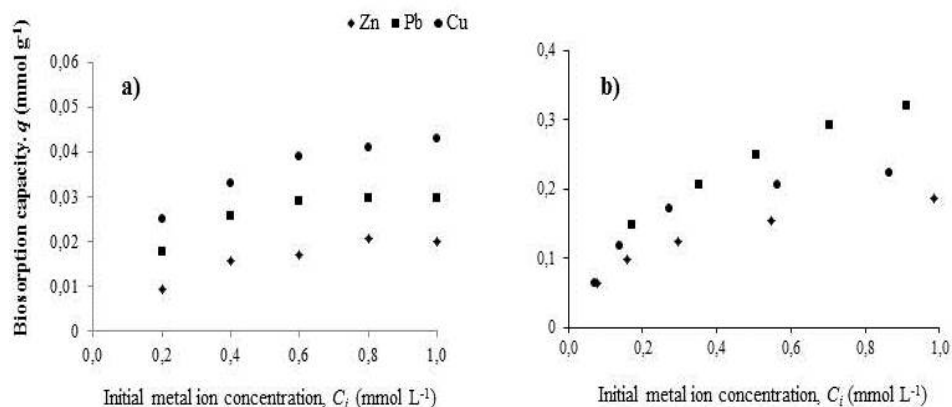
In order to analyse surface morphology, OK and KS were characterized by SEM analysis. SEM micrographs are shown at the Figure 1.



**Figure 1.** SEM micrographs of (a) OK and (b) KS.

As can be seen (Fig. 1 (a)) the OK has low porosity. At the OK surface are visible only micro channels. Leyva – Ramos et al., have also showed that natural corn cob is nonporous material [10]. At the other hand, KS has coarse surface (Fig. 2(b)) with a lot of channels, which might provide a better diffusion of solution through KS. These characteristic of the KS are favorable for the metal ion adsorption.

The effect of initial  $Pb^{2+}$ ,  $Cu^{2+}$  and  $Zn^{2+}$  concentration on the biosorption by the KS and OK was investigated at different metal ion concentration ( $0.2$  to  $1.0$   $mmol L^{-1}$ ) (Fig. 2).

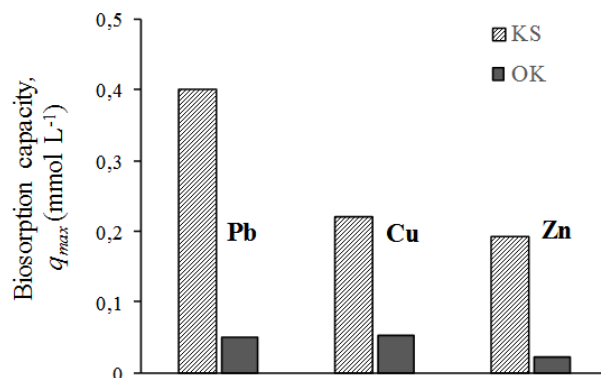


**Figure 2.** Biosorption capacity of  $Pb^{2+}$ ,  $Cu^{2+}$  and  $Zn^{2+}$  ion on OK (a) and KS (b) as a function of initial metal ions concentration.

Isotherm studies provide information about maximum biosorption capacity of sorbent. In this study the experimental results have been correlated with Langmuir isotherm model [11] (eq. 2) and the value of maximum biosorption capacity are given at figure 3.

$$q = \frac{q_{max} K_L C_{eq}}{1 + K_L C_{eq}} \quad (2)$$

where:  $q_{max}$  – the maximum amount of metal ion adsorbed on the corn cob ( $mmol\ g^{-1}$ ) and  $K_L$  - Langmuir constant ( $L\ mmol^{-1}$ ).



**Figure 3.** The biosorption capacities of KS and OK for  $Pb^{2+}$ ,  $Cu^{2+}$  and  $Zn^{2+}$  ions removal from aqueous solutions.

As can be seen from figure 2, the values of biosorption capacities of KS for  $Pb^{2+}$ ,  $Cu^{2+}$  and  $Zn^{2+}$  ions removal from aqueous solutions are higher than biosorption capacities of KS.

## CONCLUSION

In this work the biosorption of  $Pb^{2+}$ ,  $Cu^{2+}$  and  $Zn^{2+}$  ions on KS and OK was investigated. The results indicate that the corn waste materials are suitable for the investigated metal ions from aqueous solutions. The values of maximum biosorption capacities of KS for  $Pb^{2+}$ ,  $Cu^{2+}$  and  $Zn^{2+}$  ions removal are higher than values of maximum biosorption capacities of OK. This indicates that KS has better adsorptive characteristics for heavy metals removal from aqueous solutions.

## Acknowledgement

*This study is part of the project TR 31003, "Development of technologies and products based on mineral raw materials and waste biomass for protection of natural resources for safe food production", supported by the Serbian Ministry of Science and Technological Development of Republic of Serbia.*

## REFERENCES

1. Reddad, Z, Gerente, C, Andres, Y, Ralet, MC, Thibault, JF, Cloirec, PL, Ni (II) and Cu (II) binding properties of native and modified sugar beet pulp. *Carbohydrate polymers*, 23–31, 2002.
2. Johns, MM, Marshall, WE, Toles, CA, Agricultural by-products as granular activated carbons for adsorbing dissolved metals and organics. *Journal of Chemical Technology and Biotechnology*, 131–140, 1998.
3. Chen, S, Yue, Q, Gao, B, Li, Q, Xu, X, Removal of Cr(VI) from aqueous solution using modified corn stalks: Characteristic, equilibrium, kinetic and thermodynamic study. *Chemical Engineering Journal*, 909–917, 2011.
4. Reddad, Z, Gerente, C, Andres, Y, Le Cloirec, P, Adsorption of several metal ions onto a low-cost biosorbent: kinetic and equilibrium studies. *Environmental Science and Technol*, p. 2067-2073, 2002.
5. Leyva-Ramos, R, Bernal-Jacome, LA, Acosta-Rodriguez, I, Adsorption of cadmium(II) from aqueous solution on natural and oxidized corncob. *Separation and Purification Technology*, 41–49, 2005.
6. Johnson, PD, Watson, MA, Brown, J, Jefcoat, IA, Peanut hull pellets as a single use sorbent for the capture of Cu(II) from wastewater. *Waste Management*, 471–480, 2002.
7. Ajmal, M, Khan, AH, Ahmad, S, Ahmad, A, Role of sawdust in the removal of copper(II) from industrial wastes. *Water Resource*, 3085–3091, 1998.
8. Al-Asheh, S, Duvnjak Z, Sorption of cadmium and other heavy metals by pine bark. *Journal of Hazardous Materials*, 35–51, 1997.
9. Kumar, U, Bandyopadhyay M, Sorption of cadmium from aqueous solution using pretreated rice husk. *Bioresourc Technology*, 104–109, 2006.
10. Leyva - Ramos, R, Landin - Rodriguez, LE, Leyva - Ramos, S, Medellin-Castillo, NA, Modification of corncob with citric acid to enhance its capacity for adsorbing cadmium(II) from water solution. *Chemical Engineering Journal*, 113–120, 2012.
11. Langmur, L, The adsorption of gases on plane surfaces of glass, mica and platinum. *JAmChemSoc*, 1361–1368.



## KINETIC STUDY OF $\text{Co}^{2+}$ SORPTION BY DIFFERENT SOIL TYPES

Marija Sljivic Ivanovic<sup>1</sup>, I. Smiciklas<sup>1\*</sup>, M. Jovic<sup>1</sup>, S. Dimovic<sup>1</sup>, I. Jelic<sup>2</sup>

<sup>1</sup>University of Belgrade, Vinca Institute of Nuclear Sciences, Belgrade, SERBIA

<sup>2</sup>Singidunum University, Faculty of Applied Ecology - Futura, Belgrade, SERBIA

\*ivanat@vin.bg.ac.rs

### ABSTRACT

The risks related to radioactive contamination of the soil significantly depend on the sorption behavior of a particular radionuclide and the soil type. In this paper, the kinetic aspects of  $\text{Co}^{2+}$  ions sorption by various soil types were considered. The equilibrium times and the sorbed amounts were dependent on soil properties. Generally, sorption equilibrium was reached faster on acidic soils. Under applied experimental conditions, amounts of  $\text{Co}^{2+}$  sorbed at equilibrium ( $q_e$ ) varied between 2.62 and 5.46 mg/g. Experimental results were well described by the pseudo-second order kinetic model. Statistically significant correlation between soil pH and  $q_e$  was observed.

**Key words:**  $\text{Co}^{2+}$ , contamination, soil types, sorption, kinetics.

### INTRODUCTION

The pollution of the environment with radioactive elements is dominantly caused by human activities such as exploitation of nuclear energy, treatment and disposal of nuclear waste, use of radioactive isotopes in the industry and medicine, nuclear weapons tests, etc. When released into the environment, radionuclides are being accumulated in soil and sediments, and the contaminated sites, such as the ones in Chalk River Nuclear Laboratories in Canada [1], Hanford Site, USA [2,3], Oak Ridge National Laboratory (ORNL), USA [4], etc., have been detected.

One of the important radionuclides, which fate in the soil deserves particular attention, is  $^{60}\text{Co}$ . It is  $\gamma$ -emitting activation product of stable isotope  $^{59}\text{Co}$ , which is a common impurity present in the construction components of the nuclear reactors [5]. Regardless of its relatively short half-life of 5.3 years,  $^{60}\text{Co}$  is the isotope of primary significance to waste disposal and site remediation. The extent and the nature of radionuclides sorption by soils have to be considered, given that the soil represents a natural barrier around radioactive waste treatment and disposal facilities.

Since the results of the investigations of radionuclide sorption onto soils and soil components are important in terms of understanding the chemical behavior, transport and fate of pollutant, as well as for the selection of remediation strategies, the sorption of cobalt has been studied on a variety of minerals, sediments, soils, and crushed rock

materials [6-13]. The major aim of the present study was to explore the kinetic aspects of  $\text{Co}^{2+}$  ions sorption by soil, and to establish the correlations between kinetic parameters and soil physico-chemical properties.

## MATERIALS AND METODS

Nine different soil samples were collected from various localities in the Republic of Serbia. The detailed sampling and characterization procedures were previously reported [14,15]. According to the World reference base for soil resources [16], the chosen soils are representatives of different soil types, with the wide range of physico-chemical properties (Table 1): carbonate content (0–11.7 %), pH(KCl) (from acidic to neutral, 3.4–7.0), CEC (medium to very high, 22.5 - 47.8 cmol/kg), TOC (0.82–4.75 %), content of available P and K (low to high, 0.01–30.00 mg  $\text{P}_2\text{O}_5$  and 8.8–43.00 mg  $\text{K}_2\text{O}$ , respectively, per 100 g of soil).

**Table 1.** Physico-chemical properties of different soil types [14,15]

Sample	$\text{CaCO}_3$ (%)	pH (KCl) 1:2.5	CEC cmol/kg	TOC (%)	$\text{P}_2\text{O}_5$ mg/100g	$\text{K}_2\text{O}$ mg/100g
S1	0.41	3.8	36.87	3.24	30.00	43.00
S2	11.07	6.9	22.50	1.18	15.80	21.07
S3	/	4.7	34.37	1.50	0.14	17.01
S4	/	6.1	23.75	2.14	5.52	38.42
S5	/	3.6	23.42	1.69	13.15	31.61
S6	/	5.3	35.00	4.75	0.01	8.80
S7	/	3.4	32.50	0.82	2.11	35.18
S8	11.70	6.9	47.80	2.93	10.77	30.44
S9	5.40	7.0	13	2.10	7.40	12.00

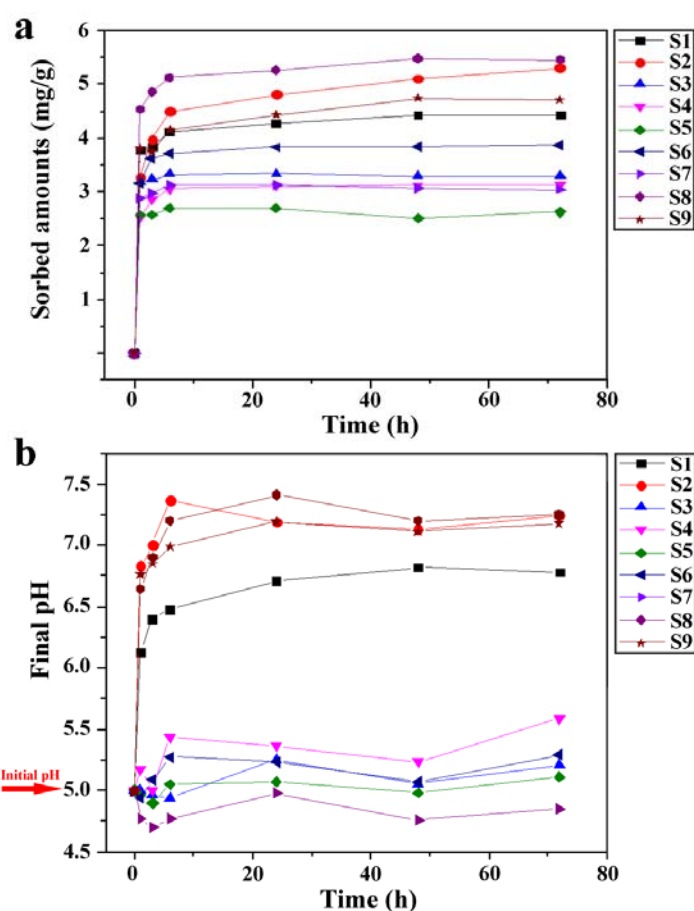
Sorption experiments were conducted in batch conditions. Cobalt(II)-nitrate ( $\text{Co}(\text{NO}_3)_2 \times 6\text{H}_2\text{O}$ , p.a., Merck) was dissolved in deionized water, to obtain solution of initial concentration  $5 \times 10^{-4}$  mol/L. Initial pH value of the solution was adjusted to 5.0, by a few drops of 0.01 mol/L  $\text{HNO}_3$ . All experiments were conducted in 50 mL centrifuge tubes, by equilibrating 0.2 g of various soil samples with 40.00 mL of Co-containing solution (solid/solution ratio 1:200), at room temperature ( $21 \pm 1$  °C). Suspensions were equilibrated using overhead laboratory shaker (Reax, Heidolph Instruments GmbH, Germany), at a constant speed (10 rpm). Contact time was varied between 0-72 h. After specified time periods, aqueous phases were separated from solid by centrifugation at 10000 rpm for 10 minutes, and subsequent filtration through blue band filter paper. Measurements of final pH values were conducted using pH meter (InoLab WTW GmbH, Germany). The initial and residual concentrations of  $\text{Co}^{2+}$  ions were measured by Atomic Absorption Spectrometer, (AAS Perkin Elmer 3100, USA).

## RESULTS AND DISCUSSION

The amounts of  $\text{Co}^{2+}$  sorbed onto soil as a function of contact time are given in Fig. 1a.  $\text{Co}^{2+}$  accumulation was particularly fast at the beginning of the process, whereas

subsequent changes were moderate. Sorption curves commonly exhibited continuous increase in the first 3 hours. The time required for the establishment of the equilibrium was a function of applied soil type. Thus, in the case of acidic soils (S3, S5 and S7) the equilibrium conditions were reached after 4 h of contact, 24 h was sufficient for S1, S4, S6 and S8, 48 h for S9, whereas  $\text{Co}^{2+}$  sorption process onto S2 did not achieve equilibrium during the course of the experiment. These data are in the good agreement with the literature, since  $\text{Co}^{2+}$  sorption by different soil samples [17,18] and soil components such as hematite, magnetite [19], montmorillonite [11], and kaolinite [20] was reported to be fast.

$\text{Co}^{2+}$  sorption capacity was also a function of soil properties. Experimentally determined capacities ranged from minimum 2.62 mg/g for S5 to maximum 5.46 mg/g for S8 (Fig. 1a).



**Figure 1.** The kinetics of  $\text{Co}^{2+}$  sorption onto different soils: (a) sorbed amounts of  $\text{Co}^{2+}$ , and (b) final pH values, as a function of time



Solution pH is an important parameter for cation sorption by soils, as it governs the dissolution/precipitation reactions, the charge of the soil surface, as well as the distribution of the sorbate ionic species in the solution. Accordingly, during the sorption process, final pH values were monitored (Fig. 1b). In respect to the initial solution pH value (5.0), variations in final pH occurred immediately, by instant decrease or increase, depending on the soil pH. The immersion of alkaline soils (S1, S2, S8 and S9) provoked instant, sharp increase of the solution pH. Moreover, final pH values have remained high, during the entire period of equilibration. This behavior can be attributed to the carbonate phase, which exhibits the highest buffering potential in the soils with neutral to weak alkaline reactions [21]. Higher pH values are strongly connected with the higher sorption capacities of calcareous soils. In addition to the inner-sphere complexes formation, which was a  $\text{Co}^{2+}$  sorption mechanism detected for various soil minerals, the partial precipitation of  $\text{Co}^{2+}$  ions by carbonate phase is possible [22,23]. Unlike  $\text{Co}^{2+}$ , the curves of  $\text{Sr}^{2+}$  sorption by the same soil samples (S1, S2, S8 and S9) have declined towards the x-axis, during the time. This phenomenon was attributed to the marked  $\text{Sr}^{2+}$  desorption caused by the increased carbonate dissolution and increased amounts of coexisting  $\text{Ca}^{2+}$  ions in the solution [14,23].  $\text{Co}^{2+}$  sorption was obviously unaffected by concurrent  $\text{Ca}^{2+}$  ions, which signifies establishment of the strong (chemical) bonds between soil components and  $\text{Co}^{2+}$  ions.

The slight increase of pH, in respect to the initial pH, was detected in the solutions following the contact with S4 and S6, whereas the most acidic soils (S3, S5 and S7) exhibited lowest buffering capacity and the pHs after  $\text{Co}^{2+}$  sorption were in the vicinity or even lower than the initial value (Fig. 1b). In general, these soils also showed the lowest sorption affinities toward  $\text{Co}^{2+}$  ions.

The experimentally obtained kinetic data were fitted using pseudo-second order kinetic model proposed by Ho and McKay [24], which linear form is:

$$\frac{t}{q_t} - \frac{1}{k_2 \times q_e^2} + \frac{t}{q_e}$$

where  $t$  (h) is the contact time,  $q_t$  and  $q_e$  (mg/g) are sorbed amounts at time  $t$  and at equilibrium, respectively, while  $k_2$  (g/mg h) is the pseudo-second order rate constant. From linear dependences  $t/q_t$  vs.  $t$ , the values for  $q_e$  and  $k_2$  were calculated. Also, the initial sorption rate  $h$  (mg/g h) can be defined as:

$$h = k_2 \times q_e^2$$

The calculated values of kinetic parameters and correlation coefficients ( $R^2$ ) are given in Table 2. Extremely high  $R^2$  values suggested an excellent agreement between the experimental data and the model. Also, the model accurately predicted the amounts of  $\text{Co}^{2+}$  sorbed at equilibrium ( $q_e$  vs.  $q_{e,\text{exp}}$ ).

The highest  $h$  and  $k_2$  values were obtained for the systems containing S3, S5 and S7, which is in the accordance with their fast equilibration. Quite the opposite, lowest  $h$  and  $k_2$  values were characteristic for S2.

**Table 2.** Pseudo-second order kinetic parameters calculated for  $\text{Co}^{2+}$  sorption onto different soil types

	$q_{e,exp}$ (mg/g)	$q_e$ (mg/g)	$k_2$ (g/mg h)	$h$ mg/g h	$R^2$
S1	4.42	4.44	0.464	9.16	0.999
S2	5.29	5.32	0.144	4.08	0.999
S3	3.30	3.41	1.51	17.5	0.997
S4	3.14	3.15	1.11	11.0	0.999
S5	2.62	2.72	2.43	17.9	0.994
S6	3.80	3.88	0.888	13.4	0.998
S7	3.13	3.17	1.80	18.1	0.990
S8	5.48	5.49	0.406	12.2	0.999
S9	4.74	4.77	0.253	5.76	0.999

The possible correlations between soil physico-chemical properties and  $\text{Co}^{2+}$  sorption kinetics were explored using the data for soil pH(KCl), CEC, and TOC (Table 1) and calculated kinetics parameters (Table 2). Statistically significant relationship was obtained only between  $q_e$  values and soil pH(KCl), with Pearson coefficient  $r = 0.903$  ( $p < 0.001$ ). According to this, soil pH is the most important factor affecting  $\text{Co}^{2+}$  sorption capacity of the investigated soils.

## CONCLUSION

The aim of the present study was to evaluate and compare the sorption kinetics of  $\text{Co}^{2+}$  ions onto different soil types.  $\text{Co}^{2+}$  retention by soil was generally a fast process, which equilibrium was achieved within a few days of contact regardless of the soil type. Sorption onto acidic soils was faster than sorption onto calcareous samples, but with the lower capacities gained at equilibrium. Kinetic data were in the excellent agreement with pseudo-second-order kinetic model. Statistically significant correlation between  $\text{Co}^{2+}$  sorption capacity and pH(KCl) of the investigated soil samples signifies that calcareous soils will retain more  $\text{Co}^{2+}$  ions than the acidic ones, regardless of other soil properties such as CEC and TOC.

## Acknowledgement

*This work was supported by the Ministry of Education, Science and Technological Development of the Republic of Serbia (Project III43009).*

## REFERENCES

1. Killey R. W.D., McHugh J.O., Champ D.R., Cooper E.L., Young J.L., Subsurface Cobalt-60 Migration from a Low-Level Waste Disposal Site, 146-157, *Env. Sci. Technol.* 18, 1984
2. Fruchter J.S., Cowan C.E., Robertson D.E., Girvin D.C., Jenne E.A., Toste A.P., Abel K.H., Radionuclide Migration in Groundwater. Final Report. NUREG/CR-4030 (PNL-5299), U.S. Nuclear Regulatory Commission, Washington, D.C.1985

3. Jones T.L., Serne R.J., Toste A.P., Special Waste-Form Lysimeters-Arid: Three-Year Monitoring Report. PNL-6400, Pacific Northwest Laboratory, Richland, Washington 1988
4. Means J.L., Crerar D.A., Duguid J.O., Chemical Mechanisms of  $^{60}\text{Co}$  Transport in Ground Water from Intermediate-Level Liquid Waste Trench 7: Progress Report for Period Ending June 30, ORNL/TM-5348, Oak Ridge National Laboratory, Oak Ridge, Tennessee, 1976
5. IAEA, Radiological Characterization of Shut Down Nuclear Reactors for Decommissioning Purposes, Radiological characterization of shut down nuclear reactors for decommissioning purposes. — Vienna: International Atomic Energy Agency, 1998
6. Drndarski N. and Golobočanin D., Radionuclide Partitioning Coefficients in the Sava River Ecosystem, 21-26, J. Radioanal. Nucl. Chem. Letter. 199, 1995
7. Fujikawa Y. and Fukui M. Radionuclide Sorption to Rocks and Minerals: Effects of pH and Inorganic Anions. Part 1. Sorption of Cesium, Cobalt, Strontium, and Manganese, 153-162, Radiochim. Acta 76, 1997
8. Barrow N. J. and Whelan B. R. Comparing the Effects of pH on the Sorption of Metals by Soil and By Goethite, and On Uptake by Plants, 683-692, Europ. J. Soil Sci. 49, 1998
9. Carroll J., Boisson F., Teyssie J.-L., King S.E., Krosshavn M., Carroll M.L., Fowler S.W., Povinec P.P., Baxter M.S., Distribution Coefficients ( $K_d$ 's) for Use in Risk Assessment Models of the Kara Sea, 121-129, Appl. Radiat. Isot. 51, 1999
10. El-Sofany E.A., Zaki A.A., Mekhammer H.S., Kinetics and thermodynamics studies for the removal of  $\text{Co}^{2+}$  and  $\text{Cs}^+$  from aqueous solution by sand and clay soils, 23-32, Radiochem. Acta 97, 2009
11. Chen L., Lu S., Sorption and desorption of radiocobalt on montmorillonite-effects of pH, ionic strength and fulvic acid, 288-296, Appl. Radiat. Isot. 66, 2008
12. Shahwan Y., Erten H.N., Unugur S., A characterization study of some aspects of the adsorption of aqueous  $\text{Co}^{2+}$  ions on a natural bentonite clay, 447-452, J. Colloid. Interface Sci. 300, 2006
13. Smičiklas I., Dimović S., Plečaš I., Removal of  $\text{Cs}^+$ ,  $\text{Sr}^{2+}$  and  $\text{Co}^{2+}$  from aqueous solutions by adsorption on natural clinoptilolite, 139-144, Appl. Clay Sci. 35, 2007
14. Smičiklas I., Jović M., Šljivić-Ivanović M., Mrvić V., Čakmak D., Dimović S., Correlation of  $\text{Sr}^{2+}$  retention and distribution with properties of different soil types, 21-29, Geoderma 253–254, 2015
15. Dimović S., Smičiklas I., Šljivić Ivanović M., Dojčinović B., Speciation of  $^{90}\text{Sr}$  and other metal cations in artificially contaminated soils: the influence of bone sorbent addition, 383-393, J. Soils Sedim. 13, 2013
16. World reference base for soil resources, Food and Agriculture organization of the United Nations, Rome, 2015
17. Chon J.K., Lee K.-J., Yun J.-I., Sorption of cobalt(II) on soil: effects of birnessite and humic acid, 511-517, J. Radioanal. Nucl. Chem. 293, 2012

18. Bangash A., Hanif J., Ali Khan M., Sorption behavior of cobalt on illitic soil, 29-38, *Waste Manage.* 12, 1992
19. Todorović M., Milonjić S.K., Čomor J., Gal I.J., Adsorption of Radioactive Ions  $^{137}\text{Cs}^+$ ,  $^{85}\text{Sr}^{2+}$ , and  $^{60}\text{Co}^{2+}$  on Natural Magnetite and Hematite, 671-679, *Sep. Sci. Technol.* 27, 1992
20. Yavuz Ö., Altunkaynak Y., Güzel F., Removal of copper, nickel, cobalt and manganese from aqueous solution by kaolinite, 948-952, *Water Res.* 37, 2003
21. Sparks D. L., *Environmental Soil Chemistry*. Academic Press, London, 2003
22. Brown G.E., Parks G.A., Sorption of trace elements on mineral surfaces: modern perspectives from spectroscopic studies and comments on sorption in the marine environment, 963-1074, *Int. Geol. Rev.* 43, 2001
23. Smičiklas I., Dimović S., Jović M., Milenković A., Šljivić-Ivanović M., Evaluation study of cobalt(II) and strontium(II) sorption–desorption behavior for selection of soil remediation technology, 3853-3862, *Int. J. Environ. Sci. Technol.* 12, 2015
24. Ho Y.S., McKay G., Pseudo-second order model for sorption processes, 451-465, *Process. Biochem.* 34, 1999



## PHYTOREMEDIATION - GREEN TECHNOLOGY FOR SUSTAINABLE SOIL DEVELOPMENT

Miroslava Maric<sup>1\*</sup>, M. Antonijevic<sup>2</sup>, A. Cvetkovic<sup>1</sup>

<sup>1</sup>John Naisbitt University, Faculty of Management, Zajecar, SERBIA

<sup>2</sup>University of Belgrade, Technical faculty in Bor, Bor, SERBIA

\*[miroslava.maric@fmz.edu.rs](mailto:miroslava.maric@fmz.edu.rs)

### ABSTRACT

Rapid technological development has led to an increasing need for the use of fossil fuels and the irrational exploitation of natural resources. Increasing pollution and exploitation of land and water, resulting in the need of using new technologies. The aim of this paper is to highlight the importance of phytoremediation as a completely new environmental technologies to soil remediation damaged by heavy metals. This paper describes the application of phytoremediation, the conditions for its development as well as limiting factors to the implementation of green technologies. Fundamental and applied research are unequivocally showed that some species possess the genetic potential to remove, dissolution, or blocking the launch of a wide range of pollutants and harmful elements

**Key words:** soil, phytoremediation, microorganisms, environmental protection.

### INTRODUCTION

Intensive use of soil in crop production often leads to an imbalance of factors involved in the creation and maintenance of soil fertility, with its man activity has the greatest impact on these processes. The development of industry in addition to the positive effects brought with it a number of problems. One of the biggest is the storage of by-products, waste generated in the production and processing of metals, chemical industry, agriculture, etc. Particularly hazardous waste from industry, as metals can through the soil to reach drinking water sources.

On the other hand the growing need for a variety of inorganic materials, primarily metals and nonferrous metals, leading to the potential danger of technology used for mining and mineral processing out of control and lead to disruption of the ecological balance in nature. Huge masses of ore material mined and processed, but only a small part of this material exploits. All others accumulates in the form of waste (tailings, ash, slag, etc.), and is a source of environmental pollution.

Secondary products incurred in the exploitation and processing of mineral raw materials are generally deposited on the surrounding land. The deposited waste materials contain toxic substances, heavy metal ions originating from the same raw materials and

residual toxic flotation reagents that pollute the water, air and land. All of these pollutants have a negative impact on the physical, chemical and biological properties of the soil. They bind to soil particles and is located in an easily soluble form, and thus become available as present vegetation indirectly entering the human food chain and thus lead to a reduction in the current and future potential of land as the most important and irreplaceable resources of plant production.

For the purpose of remediation of land damaged heavy metals in recent times is increasingly used phytoremediation - a new technology in which plants are used to clean polluted soil. Fundamental and applied research have clearly shown that some plant species have the genetic potential to remove, dissolution, or to block the launch of a wide range of pollutants, and harmful elements.

Phytoremediation is yet to become a commercial technology. Progress in this field is limited by insufficient knowledge of basic plant corrective mechanisms. In addition, the impact of agricultural practices on these mechanisms is poorly understood. Other limitations are reflected in the biological nature of this new approach. Potential for phytoremediation depends on the interaction between the soil of harmful substances, microorganisms and plants. This complex interaction is influenced by numerous factors, such as climatic conditions, soil properties, hydrogeological properties, is opposed by the generalization in favor of specific fotoremedijacione practice.

Research conducted in this area will contribute to a better understanding of the basic mechanisms of plant and efektata agricultural practices on plant / soil / harmful substances interact and enable practitioners to optimize phytoremediation process of adapting to specific conditions.

## PHYTOREMEDIATION

One way to remove heavy metals from the soil where it is the biological recultivation - growing plants on such soils.

Special attention is paid to finding plants that accumulate certain heavy metals and thus they stood from soil. The biomass of these plants is not used for human consumption, but it is dried, incinerated and disposed in designated places.

Removal of heavy metals from the soil can be measured by microorganisms, which perform their mobilization from minerals (eg from sulfides:  $\text{FeS}_2 = \text{Fe}^{2+} + \text{SO}_4^{2-}$ ), after which they can be easier to eliminate the root zone of the system flushing.

Reducing the harmful effects of heavy metals to plants (phytotoxicity) shall be adequate processes immobilization of soluble forms of the appropriate ameliorative measures in biological recultivation (neutralization, humification, etc.). This way other than reduction of greater accumulation of heavy metals in plants is not achieved and the constant decontamination, but a "blockade".

In today's conditions, in many ecosystems, which are under the influence of man degraded, many microorganisms, primarily bacteria, purchased its new ecological role. Specifically, certain heterotrophic bacteria have the ability to decompose a variety of synthetic materials, pesticides, fertilizers and other harmful substances into the soil [1]. Here is a biotechnology known as bioremediation. Bioremediation is defined as the management of the environment, which is being implemented with the aim to encourage

the decomposition of organic contamination by microorganisms [2]. Although it is widely used in the world for remediation of organic pollutants in the environment, it is not a solution for all pollution. As with other technologies, and it is limited by the type of pollution that can be rehabilitated, environmental conditions and the time necessary for its development.

Bioremediation is extremely helpful in treating pollution originating from hydrocarbon oil, while virtually powerless in cases of heavy metal pollution. The presence of heavy metal salts and is a limiting factor, because in these conditions leads to inhibition of the growth of microorganisms and prevent or significantly slowing down bioremediation [3]. Bioremediation is unable to catalyze the decomposition of heavy metals, but it can transform them to change their mobility or to be concentrated in such a way that it can easily be isolated from the contaminated environment [4]. A large number of papers in the literature which suggests that some higher plants have a natural potential to land and water remove toxic heavy metals. This is their natural feature is the basis for biotechnology known as phytoremediation.

Thus, the second is the application of biotechnology plants, which extract heavy metals from the soil, stimulating the degradation of organic pollutants or stabilize [5, 6]. There is increasing evidence that clearly point to the huge natural potential and strength that plants have to eliminate different types of pollutants from nature.

The term " phytoremediation " is a combination of two words: *phyto* (Greek), which means the plant and *remedium* (Latin), meaning to correct or eliminate the evil. Green plants have a tremendous ability to detoxify pollutants from the environment by various mechanisms.

Phytoremediation is a relatively new technology with research conducted mainly during the last two decades (1990 onwards). This is a technology that is still developing, although many data and results are already present in the literature. It can be successfully combined with other biotechnologies, especially when it comes to contaminated sites with complex issues.

The US Agency for Environmental Protection (EPA) has defined as phytoremediation technology that uses plants and their rhizospheric microorganisms to remove, degrade or retain harmful chemical substances that are found in soil, groundwater and surface water and the atmosphere [7].

Intensive research started in the last decade of the last century in the United States [7], although in 1885 by Baumann [8] identified some plant species that have been able to accumulate in their tissues unusually large amounts zinc. After that, the same author states, Byers in 1935 announced a similar phenomenon, but this time related to the metal selenium and codes *Astragalus* spp. To a decade later, in 1948, and Minguzzi and Vergnano, identified plant species that have been able to to accumulate up to 1% nickel in their offshoots. This of course, were the beginnings of research plants that have the ability hyperaccumulating certain heavy metals in their tissues.

Although numerous studies have already been done or are in the course of a lot of effort and progress needs to be invested to natural potential of plants and used for commercial purposes [6]. The same author believes that progress in terms of the commercialization of biotechnology slowed by insufficient knowledge of the complex

relationship that exists between the rhizosphere and mechanisms that are based on the ability of plants to adopt and translocate metals from polluted environment.

Phytoremediation concept (as phytoextraction) proposed by Chaney [9]. The idea was well received, because it is suitable for use on large areas of the field where the other remediation methods are not cost-effective or feasible [10]. Phytoremediation has low initial and maintenance costs compared to other remediation options [11]. As for the cost, phytoremediation can cost up to 5% less than asking a second alternative method of cleaning soil [12]. The establishment of vegetation on contaminated soil also prevents soil erosion [13].

From an economic point of view, the benefits of phytoremediation of contaminated soils can be a triple [14]:

- (1) reduction of risk (phytostabilisation);
- (2) metals which are extracted by phytoextraction have their market value, such as Ni, Tl and Au;
- (3) sustainable management of land where phytoextraction gradually improving the quality of soil for growing crops later with increasing market value.

In addition, rapid growth and high biomass yield in plants such as willow, poplar etc. can be used for energy production by phytoremediation [15].

Phytoremediation also enjoys popularity in public as a “green” clean alternative to chemical technologies [16].

#### **ADVANTAGES AND DISADVANTAGES OF PHYTOREMEDIATION**

As previously mentioned, phytoremediation is a relatively new field of research and application. Currently, most research is limited to laboratory tests and greenhouses, while very little research carried out and tested the efficiency of phytoremediation in the open field. Results in real terms in the field may be different from those obtained in the laboratory and greenhouses [17] because it is an open field real world where different factors act simultaneously and have their role. Factors that may affect phytoremediation in the open field include variations in temperature, nutrient elements, precipitation and atmospheric moisture, plant diseases, unequal distribution of pollutants, soil type, soil pH, soil structure [14]. The efficiency of phytoremediation different plants targeted for heavy metals must be tested under field conditions in order to realize the feasibility of this technology for commercialization.

After identifying desirable traits in natural hyperaccumulators, these traits can be isolated by conventional techniques of breeding, or hybridization using new methods such as protoplast fusion or genetic manipulation in transgenic plants [18]. During a study to identify the genetic code for hyperaccumulation of certain heavy metals in plants. The identification and the successful transformation of such genes in the appropriate plant makes it possible to obtain "superbug" - plant for phytoremediation. Transgene (modified) plants can also be developed to separate the metal selective ligands in the rhizosphere, which would allow greater solubility of elements that are important for phytoremediation [19]. In this way, various desirable traits can be combined in a single plant, which will best serve the purpose.



However, genetic transformation have to be studied very carefully and responsibly, in order to avoid unwanted adverse effects on the biosphere in the present and in the future. A good understanding of chemical properties and behavior of metals in plant tissues will help researchers to precisely define the process of phytoremediation [20].

One of the biggest advantages of phytoremediation, and some other biotechnologies, such as bioremediation, for example, is that she is one of the cheapest biotechnology, which is also the natural, "environmental friendly" [8], and its application does not additional burden on the environment because they are such factors used exclusively for the natural purification facilities ie. those species that normally can not grow or grow in a given contaminated area.

Pilipovic et al. [7] referred to as the advantage that the provision of energy for this biotechnology takes place in a completely natural way because the plants themselves use solar energy to the extent that they are necessary in order for the growth, development and performance of all physiological processes and mechanisms for phytoremediation.

Then, the biotechnology achieved some side effects that are not of little importance to environmental protection, and whose character changes depending on which plant species or species used in phytoremediation. By planting certain tree species are created and protective belts, which can effectively reduce the noise in the region and to provide protection from the wind, to reduce emissions of carbon dioxide into the atmosphere to create new habitats for fauna or development that are a source of biomass for the felling of trees at the end of treatment if they need to be removed from the location.

According to Ernst [21], the performance of phytoremediation depends on:

- the degree of soil pollution,
- the availability of the metal for the adoption of roots of plants (bioavailability), and
- ability of plants to absorb and accumulate heavy metals in their bodies

On the other hand, there are limits in terms of type of pollution (toxic substances) that is present in nature as well as its concentration, because if the concentration exceeds the capacity of species for tolerance to the toxic substance, she will work on her suppressive and perhaps lethal. This particularly applies to pollution originating from pesticides [22].

Selecting the type that will be used in phytoremediation is a critical step that determines the success of phytoremediation [22]. Therefore, knowledge of the species, their entire ecology, and physiology and characteristics of their tissue and organs, and anatomy and morphology of vital importance.

Although phytoremediation is a promising approach for the remediation of soil contaminated with heavy metals, it also has some limitations [23, 24, 25, 26, 27, 28, 29]. Some of these limitations are:

- Long period of time to clean the land;
- The efficiency of phytoremediation in most hyperaccumulative metal is usually limited to their slow growth and low biomass;

- Difficulty in mobilizing not tightly bound metal ions to soil particles, or limited bioavailability of contaminants in soil. Is only applicable to areas with low to moderate concentrations of metals because of the growth of plants in a very difficult polluted soils;
- There is a risk of contamination of food in case of bad management and lack of proper responsibilities and worries.

In summary form Pilipovic et al. [7] point out the following drawbacks and limitations of phytoremediation:

- The application is limited to shallow land;
- The application is restricted in certain types of water courses;
- For each species there are certain values of environmental factors including in terms of tolerance of plants to the toxic substances;
- The time period for conducting the removal of contamination from the environment is higher than that of other methods, such as mechanical removal;
- Phytoremediation is effective only in a moderately hydrophobic compounds;
- There is a potential risk that the entry of toxins into the food chain by entering the plant tissue akumulirnim pollutants in animals and its further distribution through the food chain.

## **CONCLUSION**

In addition to all the above advantages and disadvantages it has been proven that Phytoremediation is a cost effective, green technology in Serbia is still underutilized. One of the very important factors when it comes to the applicability and effectiveness of phytoremediation is the availability of pollutants and its plant rhizosphere. To pollutants could successfully rehabilitated first she must not be too deep because it is a city of events related to the land that surrounds the roots of plants, ie. rhizosphere. Then, it should not be too tightly bound to the particles of contaminated soil, as can be the case when we have a large proportion of clay in the same fractions. Clay is known to have great power of adsorption of molecules on their surface. The roots of plants will be the best and easiest to adopt those molecules, ions and atoms that are dissolved in the soil solution. Despite many new izazovima and uncertainties, phytoremediation is considered a green, environmental remediation technology with expected high potential in the future.

## **REFERENCES**

1. Stevanović B., Janković M.M. (2001) Ekologija biljaka sa osnovama fiziološke ekologije biljaka. - NNK, Beograd.
2. Eszényiová A., Polakovicová G., Bilská V., Rajnohová H. (2000) Biological clean-up of hydrocarbon pollution. Petroleum Technology Quarterly 133-137.
3. Reis J. (1996) Environmental Control in Petroleum Engineering, Gulf Publishing Company, Houston, Texas, USA.
4. Atlas R. M. (2002) Applicability of Bioremediation to Eastern European Pollution Problems, Internet.

5. EPA (2000) Introduction to Phytoremediation. U.S. Environmental Protection Agency, Washington, D.C. 72 p.
6. Reichenauer T. (2002) Selection of Stress-Resistant clones of *Populus nigra* and Possible Application, In: van Dam C. Barbara and S. Bordacs, Proceedings of an International Symposium Europop, Szekszard, Hungary.
7. Pilipović A., Klačnja B., Orlović S. (2002) Uloga topola u fitoremedijaciji zemljišta i podzemnih voda, *Topola*, 169/170: 57-66.
8. Lasat M.M. (2002) Phytoextraction of Toxic Metals: A Review of Biological Mechanisms, *Journal of Environmental Quality*, 31: 109-120.
9. Chaney R.L. (1983) Plant uptake of inorganic waste constituents. In: Parr, J.F.E.A. (Ed.), *Land Treatment of Hazardous Wastes- Noyes Data Corp.*, Park Ridge, NJ, 50-76.
10. Garbisu C., Alkorta I. (2003) Basic concepts on heavy metal soil bioremediation. *Eur. J. Miner. Process. Environ. Prot.* 3, 58–66.
11. Van Aken B. (2009) Transgenic plants for enhanced phytoremediation of toxic explosives. *Curr. Opin. Biotechnol.* 20, 231–236.
12. Prasad M.N.V. (2003) Phytoremediation of metal-polluted ecosystems: hype for commercialization. *Russ. J. Plant Physiol.* 50, 686–700.
13. Chaudhry T.M., Hayes W.J., Khan A.G., Khoo C.S. (1998) Phytoremediation-focusing on accumulator plants that remediate metal-contaminated soils. *Aust. J. Ecotoxicol.* 4, 37–51.
14. Vangronsveld J., Herzig R., Weyens N., Boulet J., Adriaensen K., Ruttens A., Thewys T., Vassilev A., Meers E., Nehnevajova E., Van der Lelie D., Mench M. (2009) Phytoremediation of contaminated soils and groundwater: lessons from the field. *Environ. Sci. Pollut. Res.* 16, 765–794.
15. Abhilash P.C., Powell J.R., Singh H.B., Singh B.K. (2012) Plant-microbe interactions: novel applications for exploitation in multipurpose remediation technologies. *Trends Biotechnol.* 30, 416–420.
16. Pilon-Smits E. (2005) Phytoremediation. *Annu. Rev. Plant Biol.* 56, 15–39.
17. Ji P., Sun T., Song Y., Ackland M.L., Liu Y. (2011) Strategies for enhancing the phytoremediation of cadmium-contaminated agricultural soils by *Solanum nigrum* L. *Environ. Pollut.* 159, 762–768.
18. Pollard A.J., Powell K.D., Harper F.A., Smith J.A.C. (2002) The genetic basis of metal hyperaccumulation in plants. *Crit. Rev. Plant Sci.* 21, 539–566.
19. Thakur I.S., (2006) *Environmental Biotechnology*. I. K. International, New Delhi.
20. Saraswat S., Rai J.P.N. (2011) Complexation and detoxification of Zn and Cd in metal accumulating plants. *Rev. Environ. Sci. Biotechnol.* 10, 327–339.
21. Ernst W.H.O. (1996) Bioavailability of heavy metals and decontamination of soil by plants. *Applied Geochemistry* 11: 235-239.
22. Anderson A.T. (2002) *Development of a Phytoremediation Handbook: Considerations for Enhancing Microbial Degradation in the Rhizosphere*, Institute of Environmental and Human Health, Texas Tech University, Texas.
23. Clemens S. (2001) Developing tools for phytoremediation: towards a molecular understanding of plant metal tolerance and accumulation. *Int. J. Occup. Med. Environ. Health* 14, 235–239.

24. Tong Y.P., Kneer R., Zhu Y.G.(2004) Vacuolar compartmentalization: a second generation approach to engineering plants for phytoremediation. *Trends Plant Sci.* 9, 7–9.
25. LeDuc D.L., Terry N. (2005) Phytoremediation of toxic trace elements in soil and water. *J. Ind. Microbiol. Biotechnol.* 32, 514–520.
26. Karami A., Shamsuddin Z.H. (2010) Phytoremediation of heavy metals with several efficiency enhancer methods. *Afr. J. Biotechnol.* 9, 3689–3698.
27. Mukhopadhyay S., Maiti S.K. (2010) Phytoremediation of metal enriched mine waste: a review. *Global J. Environ. Res.* 4, 135–150.
28. Naees M., Ali, Q., Shahbaz M., Ali F. (2011) Role of rhizobacteria in phytoremediation of heavy metals: an overview. *Int. Res. J. Plant Sci.* 2, 220–232.
29. Ramamurthy A.S., Memarian R. (2012) Phytoremediation of mixed soil contaminants. *Water Air Soil Pollut.* 223, 511–518.



## QUALITY OF WATER OF THE SAVA LAKE ON ADA CIGANLIJA IN THE PERIOD 2012.-2015.

**Dragan Pajic, I. Ristanovic Ponjavic\*, S. Mladenovic, A. Tanaskovic**

The Institute of Public Health of Belgrade

\*[ivana.ristanovic@zdravlje.org.rs](mailto:ivana.ristanovic@zdravlje.org.rs)

### INTRODUCTION

The lake on Ada Ciganlija is a popular recreational and sport area on the territory of the City of Belgrade attended by a great number of visitors during the summer season. Quality monitoring of water from this lake is performed in order to protect the health of swimmers and other athletes who are in contact with this recreational water, as well as in order to protect the zone of sanitary protection of the Belgrade water supply system, since there are deep drilled wells on the Ada that capture water for purification for the aforementioned water supply system.

The results of water quality monitoring of water from the Sava Lake in the period 2012.-2015., performed by the Institute of public health of Belgrade will be presented in this paper.

**Key words:** the Sava Lake, Ada Ciganlija, recreational water, water quality monitoring.

### MATERIAL AND METHOD

The results of quality monitoring of water from the Sava Lake in the period 2012.-2015., performed by the Institute of public health of Belgrade are used in this paper.

Monitoring was carried out according to the recommendations of the World Health Organization and the EU Directive on bathing water. Sampling was carried out during the bathing season twice a week from 1 June to 15 September, at four locations: "Children's pool at the refereeing tower", "Round Bathroom", "Ranney well no. 12-1" and "Ranney well no. 14-1".

The sampling locations were selected according to the recommendations of the WHO: for every 500 m of length there should be one sampling location, and these locations are, at the same time, the most visited places for swimming.

Sampling methods, methods of sample preparation and analysis are in accordance with local regulations and standards, as well as with international standards (ISO, SMEWW) and the US EPA methods.

The following parameters were analyzed in terms of defining the physical-chemical characteristics of water from the Sava Lake: temperature, pH, dissolved oxygen, oxygen saturation level, five-day biological oxygen demand (BOD<sub>5</sub>), chemical

oxygen demand (COD from  $\text{KMnO}_4$ ), nitric triad (ammonia, nitrites and nitrates), mineral oils, phenols, phosphates and total suspended solids. Some of parameters are field parameters, analyzed immediately after sampling.



**Figure 1.** Sampling locations on the Sava Lake



**Figure 2.** Laboratory for chemical analysis (Gas Chromatography)

Microbiological parameters that were analyzed are: total coliforms in 100 ml of water, fecal coliforms in 100 ml, fecal enterococci in 100 ml, *Proteus* sp. and *Pseudomonas aeruginosa*, aerobic heterotrophs and oligotrophic and heterotrophic bacteria ratio.



**Figure 3.** Microbiological laboratory

Biological indicators of ecological potential that were analyzed are: concentration of chlorophyll a, composition of phytoplankton and phytobenthos, Cyanobacteria, the index of phosphatase activity and Carlson trophic state index for water transparency, the concentration of total phosphorus and chlorophyll, the composition of the community of aquatic macro invertebrates, the total number of Oligochaeta taxon and Tubificidae taxon, and corresponding saprobic and biodiversity index.



**Figure 4.** Sampling of biological indicators

Sampling methods, as well as analytical methods are accredited according to ISO 17025: 2006. The results are interpreted in accordance with relevant domestic legislation. Testing of some parameters (biological indicators) is carried out at the Institute for Biological Research "Siniša Stankovic".

Water quality is evaluated in accordance with the Regulation on limit values of pollutants in surface and ground water and sediment and the deadlines for their achievement ("Off. Gazette of RS", No 50/2012), Regulation on the parameters of the ecological and chemical status of surface water and chemical and quantitative status of ground water ("Off. Gazette of RS", No. 74/2011), Regulation on categorization of

watercourses (“Off. Gazette of RS”, No. 5/68) and the Regulation on water classification (“Off. Gazette of RS”, No. 5/68).

## RESULTS

In the period 2012.-2015. total number of 367 samples of water from the Sava Lake were analyzed.

During this monitoring period temperature had small seasonal and daily variations. Annual temperature range was 20 °C to 30 °C. The water temperature is usually high enough for swimming in the first decade of June, but the first swimmers always appear before the official start of the season.

Oxygen super saturation is characteristic of water from the Sava Lake, as well as from the other closed water. This is usual phenomena, especially during summer season, due to very intensive photosynthesis of algae and macrophytae. Oxygen saturation level ranged in the interval 95% - 140%.

Elevated pH values are also common for shallow, closed water such as Sava Lake. pH values ranged in the interval 8,5-8,7.

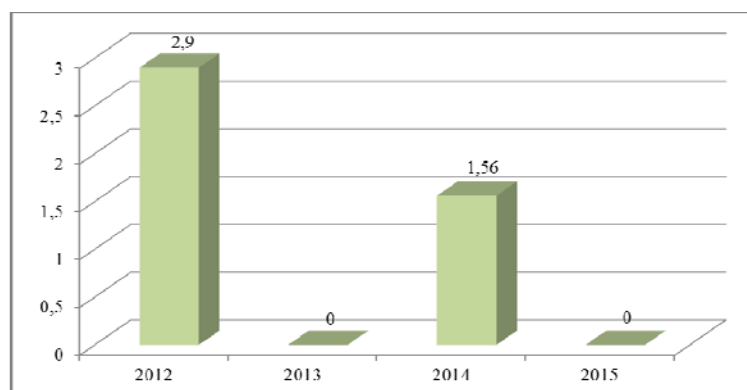
Suspended solids concentration was low during monitoring period, and ranged in the interval <1 mg/l - 14 mg/l.

Concentration of phosphorus, as one of the main nutrients in water, varied from 0,005 mg/l in 2013. to 0,2 mg/l in 2015., but in the great number of samples was lower than 0,035 mg/l, which is very good result.

Compounds from „nitric triade“ are present in very low concentrations, which are in accordance even with the Regulation on drinking water quality, mainly as a result of efficient and rapid oxidation and primary producers assimilation.

On the basis of detected concentrations of mineral oil and phenols, it can be concluded that neither the health of the swimmers, nor the Belgrade waterworks water source are threatened.

Microbiological quality of water from the Sava Lake in the period 2012. – 2015. is presented in the Figure 5.



**Figure 5.** Percentage of non-compliance with the criteria for the second class of water from the aspect of microbiological quality in the period 2012.-2015.



Microbiological status of water from the Sava Lake was satisfactory during observed period and it complied with all domestic and foreign legislative on bathing water quality. Only 5 samples of water did not comply with the EU Directive on bathing water quality during the period 2012. – 2015. but they still complied with the domestic legislative.

The presence of bacteria *Pseudomonas aeruginosa* and *Proteus* sp. is rarely detected in the tested samples of water, and that is very good from the aspect of health protection.

Enteropathogenic bacteria that can cause waterborne diseases were not detected in the Sava Lake.

The results of all microbiological tests show that the process of auto-purification of water almost completely maintained a balance of aquatic system in the lake, although the efficiency of this process occasionally was poor due to a great number of bathers which exceeded the capacity of the lake, or due to extensive works on the coast.

The process of eutrophication is also monitored through Carlson's trophic indexes, which made easier to conclude on the causes and possible measures for aquatic status improvement. Carlson's trophic index for the chlorophyll a corresponded to mesotrophic status in all tested samples of water in the period 2012. – 2015. The concentration of total phosphorus corresponded to mesotrophic to hipereutrophic status, while the value of water transparency ranged from mesotrophic to eutrophic status.

All analysed Carlson's trophic indexes corresponded to a relatively good ecological status of water. Low concentration of chlorophylls a also corresponds to relatively good ecological status of water, as well as to good ecological status according to the Regulation on the parameters of the ecological and chemical status of surface water and chemical and quantitative status of ground water ("Off. Gazette of RS", No. 74/2011).

The phytoplankton community of the Sava Lake is changing over the years in small extent and is usually represented by a hundred of taxa classified into 6 or 7 algal sections. The most common algal sections are Bacillariophyta and Chlorophyta. It is very important that the presence of blue-green algae is registered in all samples in very small number, and it does not present any risk to bathers' health or the ecosystem. A relatively constant composition of the phytoplankton community in the period from 2012 to 2015 indicates the stability of the environmental factors that influence the development of phytoplankton.

The phytobenthos community is poorer than the phytoplankton community and it usually consists of seventy species of the 6 or 7 algal sections. The most common algal sections are Bacillariophyta and Chlorophyta .

Unlike the good ecological potential of the lake according to present plankton communities, macroinvertebrate community has small number of species. The main reason for this status of macroinvertebrate community is a fact that this lake is a recreational water under strong antropogenic influence, which is present throughout most of the year and is highest during the spring, due to preparations on the coast and the banks for the upcoming bathing season, as well as during the bathing season. Such a

heavy anthropogenic influence leads to a small macroinvertebrate community diversity, mostly presented by the species that are more resistant to negative influences.

The macrophytes community in the lake in the reporting period is constant. They are mostly submerged species of the genus *Myriophyllum*, *Ceratophyllum* and *Potamogeton* that dominate in terms of number and coverage. More numerous are: *Myriophyllum spicatum*, *M. verticillatum*, *Ceratophyllum demersum*, *Potamogeton fluitans* and *P. crispus*.

It is difficult to evaluate the macrophytes community from the standpoint of cover and biomass, due to ongoing "harvesting".

On the examined profiles one of the three vegetation zones of macrophytes is still absent, and that means that there was no formation of zone of floating plants.

## **DISCUSSION**

On the basis of results of water quality monitoring program performed in terms of health protection from 1 June to 15 September, in the period from 2012 to 2015, it can be concluded that quality of water of the lake corresponded both to domestic regulations, EU Directive for bathing water, as well as to the recommendations of the WHO. A rare deviations of some individual microbiological parameters were not significant neither from the aspect of number, nor from the aspect of type of microbiological indicator.

Also, none of tested physical and chemical parameter did not differ from the second class of water quality which is satisfactory in terms of the use for swimming, water sports and recreation.

Concentrations of harmful and dangerous substances in water (phenol, mineral oil, ammonia, nitrites, nitrates, etc.) were either significantly lower than the upper limits, or below the detection limit for the applied analytical method, which is very important from the standpoint of protection of groundwater for Belgrade waterworks.

Finally it should be noted that quality and characteristics of water from the Sava Lake mainly depend on the number and behavior of swimmers, availability of sanitary-hygienic facilities and communal services (a sufficient number of public toilets and showers, green areas, etc.), intensity of processes of auto-purification (auto-purification and stability of ecosystems), as well as from the flow of water through the lake due to its connection with the precipitation field of Belgrade waterworks (upstream) and the mouth of the river "Čukarička Reka" (downstream).

## **CONCLUSION**

Only 5 (1.34%) of total number of 367 tested samples of water from the Sava Lake did not meet the criteria for the second class (class II) of water, according to the Regulation on water classification ("Off. Gazette of RS", No. 5/68). This result is entirely satisfactory from the aspect of protection of the health of swimmers and other athletes (water sports), as well as from the aspect of preserving the quality of surface and ground water that are used in the Belgrade waterworks. Stated quality of the water is the

result of the balance between ecosystem characteristics of the Sava Lake, the achieved level of municipal development and human impact referring to behavior of users.

#### **REFERENCES**

1. The Institute of Public health of Belgrade, Report on water quality from the lake "Savsko jezero" in the period 2012.-2015.;
2. Guidelines for safe recreational water environments Volume 1: Coastal and fresh waters, WHO, 2003;
3. Directive 2006/7/EC of the European Parliament and of the Council of 15 February 2006 concerning the management of bathing water quality and repealing Directive 76/160/EEC
4. Standard SRPS ISO 17025:2006;
5. Regulation on limit values of pollutants in surface and ground water and sediment and the deadlines for their achievement ("Off. Gazette of RS", No 50/2012);
6. Regulation on the parameters of the ecological and chemical status of surface water and chemical and quantitative status of ground water ("Off. Gazette of RS", No. 74/2011);
7. Regulation on categorization of watercourses ("Off. Gazette of RS", No. 5/68);
8. Regulation on water classification ("Off. Gazette of RS", No. 5/68).



## VULNERABILITY OF GROUNDWATER POLLUTING IN THE AREA OF NATIONAL PARK „FRUSKA GORA“

Zarko Veljkovic\*, T. Petrovic Pantic, M. Tomic, M. Mandic, K. Samolov

Geological Survey of Serbia, Rovinjska 12, Belgrade, SERBIA

\*zarkoveljkovic@gmail.com

### ABSTRACT

Groundwater vulnerability model of National Park Fruška Gora is presented in this paper. Base of vulnerability model is studying a number of different factors affecting the penetration of pollutants and possible disruption of water quality. At the researched area DRASTIC method is applied. The aim of this method is to get the map which will provide us with general assessment of the groundwater vulnerability by map compilation.

**Key words:** Vulnerability, modeling, groundwater, National park, Fruška Gora.

### INTRODUCTION

Fruška Gora was declared as National park in 1960. Area of National Park Fruška Gora is located in the municipality of: Petrovaradin, Sremski Karlovci, Beočin, Bačka Palanka, Šid, Sremska Mitrovica, Irig and Inđija. National park occupies area of 255,25 km<sup>2</sup>. Spatial plan from 2004 defined the borders of National park zone of protection. Area of active protection coincides with border of National park Fruška Gora whereby protection zone and protection of natural values are also defined. Due to its excellent strategic location, proximity to large cities of Novi Sad and Belgrade, rich flora and fauna, as well as a very pleasant climate, Fruška Gora recorded a population increase in the last twenty years. The constant increase in population causes economic development, industry and tourism which leads to enhanced anthropogenic impact on the natural values of the National Park. Ground and surface waters as a part of natural values may be particularly vulnerable therefore the special attention should be paid. Groundwater is main source of water supply in this area.

### DRASTIC METHOD

DRASTIC method [1] was developed in order to assess the groundwater vulnerability to the area of more than 40 ha. It represents one of the first methods that have been developed in order to evaluate the vulnerability of groundwater in terms of pollution. According to impact of various factors the method analyzes the possibility of

contaminants infiltration from the surface. The map shows classified zones of analyzed area according to groundwater vulnerability. Factors that are being analyzed are:

- *Depth to the Water Table*
- *Recharge (Net)*
- *Aquifer Media*
- *Soil Media*
- *Topography (slope)*
- *Impacts of the Vadose Zone Media*
- *Conductivity of the Aquifer (Hydraulic)*

The basis of the method is to perform evaluation and ranking of each DRASTIC factor. DRASTIC final index is calculated based on the following equation:

$$\text{DRASTIC index (Pollution Potential)} = 5Dr + 4Rr + 3Ar + 2Sr + 1Tr + 5Ir + 3Cr$$

where: *Dr, Rr, Ar, Sr, Tr, Ir, Cr* – parameter values in a specific point;



- Weight ratio parameter.

The vulnerability level varies based on the vulnerability index:

<75 Very low vulnerability level

75-100 Low vulnerability level

100-125 Low- medium vulnerability level

125-150 Medium- high vulnerability level

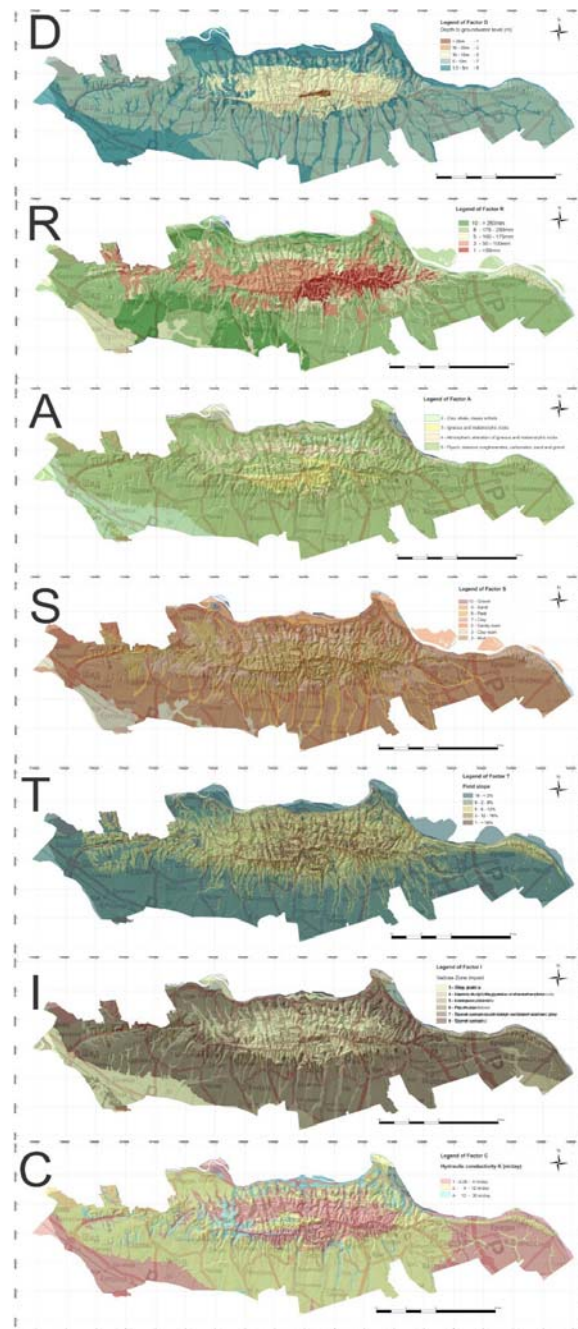
150-175 High vulnerability level

> 175 Very high vulnerability level

Maps are being made in Geographical Information System (GIS).

### **DRASTIC METHOD APPLICATION TO THE NATIONAL PARK FRUŠKA GORA**

Vulnerability map of Fruška Gora and factor map are shown on figure 1. The explanation of their creation is given in the text below. The evaluation for each factor has been established thus obtained values for DRASTIC parameters got the numbers from 1 to 10.



**Figure 1.** Groundwater vulnerability factor map of Fruška Gora (DRASTIC)

#### **Map of factor D- Depth to water table**

In the area of National park Fruška Gora, depth to water table was determined by wells and on the basis of hydrogeological terrain properties and the distance between springs and surface flows.

Springs and wells data, collected by previous research are shown on the water facility map. At this map, distance between wells, springs and rivers is presented. Other factor which directly affects the water table are hydrogeological properties of the environment (aquifer types). Therefore, the map with distance zones is overlapped with hydrogeological map.

On the basis of obtained map of factor D (Fig. 1), maximum depth are registered on the ridge of Fruška Gora (>20 m), whilst minimum depths are registered on the outskirts of the National park (1.5-5 m).

#### **Map of factor R- Recharge**

Recharge zone depends on several factors. Primary factors are: rainfall, slope and soil permeability. The impact of these factors are analyzed through creating the following maps [2]:

- Precipitation map, which was done on the basis of analyzed precipitation on several rain gauge, which are located in a wider area.
- Terrain slope map, which was done on the basis of DEM model
- Soil map, which was done on the basis of pedology map

By input of three overlap maps- precipitation map, terrain slope map and soil map, the map of factor R was obtained (recharge map).

Minimum recharge is at the central part of Fruška Gora, to 100 mm, whilst at the parts of the terrain near Danube River and at around Erdevik and Mandelos (south slope) is higher than 250 mm.

#### **Map of factor A- Aquifer media**

Factor A represents the environment properties in which aquifers are formed. Velocity and way of groundwater flow, namely pollutants and processes, depend on lithological characteristics of environment (rock fractureness). Environment with higher porosity is characterized by higher permeability. These environments are the most vulnerable in terms of pollution.

From the lithological aspect, the most vulnerable are: flysch, massive conglomerates, carbonate rocks, sand and gravel which are dominant.

#### **Map of factor S- Soil media**

Factor S reflects the characteristics of soils. The possibility of surface water infiltration and thus polluting underground depends on its characteristics. Crucial features are the particle size which constitutes the soil and its thickness. If material is smaller, the possibility of infiltration is less. Characteristic of the soil, on which basis the

classification was determined, was done by granulometric analysis. Soil map is a base for creating the map of factor S. For the researched area factor S is from 2 to 10 (Fig. 1), so the lower factors are assigned to mud, clay, while the higher factors are assigned to thin or non-existent soil, gravel, sand, peat.

#### **Map of factor T- Topography**

Faktor T includes the terrain impact on the possibility of pollutant infiltration into the underground. With slope increase, denudation is more intensive compared to infiltration, therefore there are less chances that a potential contaminant reaches the groundwater.

In some parts of researched area, the terrain slope is <2%, whilst in other is higher than 18%.

#### **Map of factor I– Impact of the Vadose Zone**

Map of factor I represents the zone of aeration which affects pollutant penetration to groundwater level. According to zone of aeration, pollutant flow towards the aquifer might be slow so the effects of pollution will reduce due to various processes. The most unfavorable zone of aeration affect is on pollutant penetration in gravel, sands, while in clayey environments, which are impermeable both for water and pollutants, are the least.

#### **Map of factor C- Hydraulic conductivity**

Map of factor C shows the ability of the water- bearing environment to conduct water. If that ability is higher, the vulnerability of groundwater against pollution is higher as well. Characteristic of the environment to conduct water is coefficient of conductivity. This coefficient, at lithologically or genetically same rocks, might vary in wide range of values especially in consolidated environments. In that case, coefficient of permeability depends on fractures of rocks.

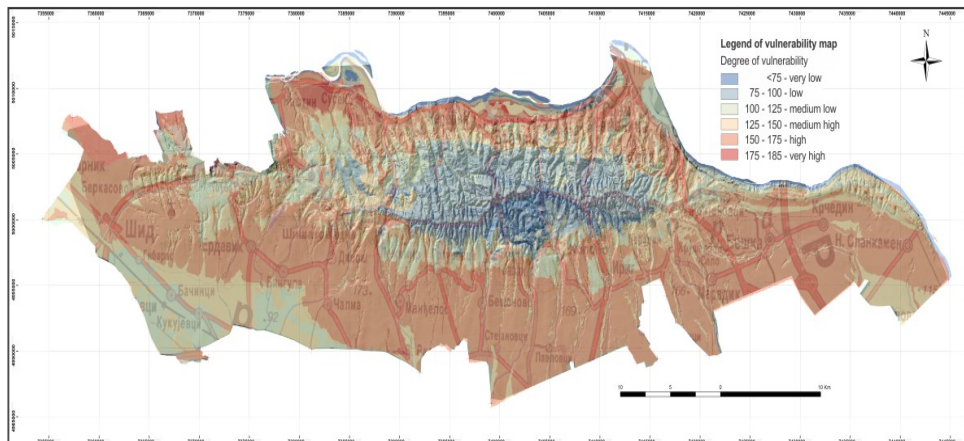
Hydraulic conductivity K (m/day) provides factor C class evaluation. On the basis of previous data hydraulic coefficient is between 0.05 and 30 m/day at the area of Fruška Gora.

#### **Groundwater vulnerability map**

By factor and their weight parameter input into equation, the vulnerability index for the whole area is acquired. This vulnerability map (Fig. 2) enables groundwater pollution overview based on the natural factor analysis that are specific for the area of National park Fruška Gora.

On the groundwater vulnerability map it is noted that in central part of Fruška Gora (ridge) is low to very low vulnerability level. Down the slope of Fruška Gora vulnerability level increases thus ridges of the Mountains, which are densely populated, are the most vulnerable.





**Figure 2.** Groundwater vulnerability map of „National park Fruška Gora“

## CONCLUSION

Vulnerability map provides terrain characteristic overview in terms of groundwater pollution, as a result of natural conditions in the area. This map, created by DRASTIC method, analyses the impact of geological, hydrogeological, pedological, topographic and climate conditions on evaluating the groundwater vulnerability. The significance of the map reflects in obtaining data in natural possibilities and limitations of area when considering conditions of preserving groundwater quality. Such information enables us to determine development of the area and activity planning for groundwater issues, which risks would be assessed in advance. Recommended use of groundwater vulnerability map is due to creating zones of sanitary protection, estimating the pollution risk which is made in order to preserve environment and for spatial planning.

## REFERENCES

1. Aller L., Bennet, T. Lehr, J. Petty R. and Hackett G.: DRASTIC. A standardized system for evaluating groundwater pollution potential using hydrogeologic settings, U.S. EPA, Chicago, Illinois, 1985.
2. Piscopo G.: Groundwater vulnerability map explanatory notes, NSW Department of Land and Water Conservation, Australia, 2001.



## TECHNO-ECONOMIC ASPECTS OF THE TREATMENT OF WASTEWATER INCURRED DYEING TEXTILES

Snezana Urosevic<sup>1\*</sup>, M. Smelcerovic<sup>2</sup>, D. Djordjevic<sup>3</sup>

<sup>1</sup>University of Belgrade, Technical Faculty in Bor, Bor, SERBIA

<sup>2</sup>Technological artistic college Leskovac, SERBIA

<sup>3</sup>University of Nis, Faculty of Technology, Leskovac, SERBIA

\*snezanaur@gmail.com

### ABSTRACT

To carry out the treatment of wastewater generated in the textile industry, but also other industries, requires great financial resources, investing in terms of process technology and equipment for wastewater treatment. These are long-term interventions aimed at protecting the environment. The paper presents the economic feasibility of different ways of treating waste water generated in the process of textile dyeing in textile factories. Attention has been focused on the waste materials which are used as adsorbents for decolorisation, which are capable of removing pollutants from the waste water from the textile industry at low cost. The special attention in this paper will be given to modified fly ash from power plants and thermal power plants as a waste water treatment model that is economical and advantageous because it is environmentally friendly and it meets our and international standards. Modification of the natural waste materials and the formation of new efficient adsorbent for the purification and design a model for successful treatment and recycling in industrial conditions is a current topic that is in line with new trends and tendencies for the recycling of waste with the ultimate goal to prevent environmental pollution.

**Key words:** textile industry, waste water, adsorbent, economic justification, wastewater treatment, environmental protection.

### INTRODUCTION

Industrial wastewater can pollute groundwater and surface water in the area, and that is why water pollution is one of the most serious ways of environmental degradation. Wastewater treatment is an absolute priority in the protection of water resources and the health of the population [1]. The textile industry is the biggest wastewater polluter, because huge amount of water is used at every stage of textile production. The textile industry generates waste water in the production process, starting from raw material production to end use of the product and is located at the site of the top five in the world by quantity of waste water near the paper industry, beverages, leather and ferrous metallurgy. Tests have shown that the discharge of waste water from the textile industry makes up about 80% of the total pollution [11].

In the textile industry is used the largest quantity of the most toxic colors and additives. It is well known that colors can cause danger to the environment due to the presence of a large number of contaminants, such as toxic organic residues, acids, bases and inorganic matter. Some of the colors are carcinogenic and mutagenic because previously emerged from dangerous chemicals [2]. Due to the strict limitations of organic content in industrial waters are discharged, it is necessary to remove the paint from the waste water [2-4]. Textile industries produces a wide variety of pollution and their treatment is a very serious problem because of high total dissolved solids (TDS), the presence of toxic heavy metals and bio-degradable substances in wastewater. [6].

Making colored liquid waste in surface water not only affects their aesthetic nature, but also interferes with the transmission of sunlight and thus reduces the photosynthetic activity, which disrupts the natural balance affecting the aquatic life and the food chain [7].

In order to eliminate the suspended organic and inorganic substances, as well as coloring matters, provides for the processing technology using the device for waste water treatment. Method of waste water treatment in the textile industry depends on the composition and the type of waste water and can be: a chemical process (neutralization, oxidation or reduction), the physical process (precipitation, filtration, adsorption, etc.), a physical-chemical process (coagulation/flocculation, aeration, extraction, osmosis, electrolysis, etc.) and biodegradation (aerobic, anaerobic). Only after purification, waste water can be discharged into the sewer system.

In this paper, attention is focused on the new adsorbent - the waste materials which are used as adsorbents for decolorisation, which is obtained by modifying a waste that is able to remove pollutants from wastewater of textile industry at a low price, this is a special emphasis on modified ash from the plant or thermal power plants that is economical and the advantage of satisfactory eliminate liquid waste that is. Treated waste water.

Modification of the natural waste materials and the formation of new efficient adsorbent for the purification and design a model for successful treatment and recycling in industrial conditions is a current topic that is in line with new trends and tendencies for the recycling of waste with the ultimate goal to prevent environmental pollution.

Through a review of the environmental pollution, especially water resources, which is often the result of irrational and uncontrolled discharges of toxic substances from various industrial plants in the immediate environment and waterways, in our case, textile plants and solving the problems related to the disruption of the ecological balance has been done techno-economic analysis of the entire process from the standpoint of efficiency and justification processes through:

- Techno-economic analysis of the justification for using the modified adsorbent and the process of bleaching,
- design a model for the most efficient utilization - waste recycling.

This method of processing waste water and to obtain treated water for reuse is very cost-effective, relatively simple without greater engagement of additional material resources, productive and cost-effective procedure compared with existing systems.

## **WASTE WATER MANAGEMENT FROM TEXTILE INDUSTRY**

Protection of water from pollution is carried out in order to enable harmless and undisturbed use of water, protection of human health, animal and plant life. Protecting water from pollution implemented through stopping, limiting and preventing the introduction into water of hazardous and harmful substances, prescribing and taking other measures to preserve and improve water quality. There is a less clean water than ever, so care about water and pollution becomes one of the biggest priority of global population and the most comprehensive issue regulated by the legislation of the European Union. Framework guide the EU Water is a common instrument of pollution control in the member countries of the Association. The provisions of the Framework guidelines insist on a single integrated water management through the implementation of management plans within the river basins in the whole territory of the European Union. Integrated protection of water means water protection, taking into account the natural interaction between them by applying the principles of integrated water resources management (surface, ground, mixed water) [8].

With increasing importance of the textile industry in the world is growing concern about the impact of its activities on the environment. Little is known about the extent of pollution of the environment and natural resources caused by the textile industry. Each of the segments of the technological process of production affects the environment to a certain extent. The textile industry is one of the biggest polluters, with enormous risks to human health and the environment, with respect to: the quantity, diversity and characteristics of resources used, technology and equipment used. The revival of the textile industry in the world, is expected to increase the share of waste water industry in total wastewater. Making undiluted or untreated waste from the textile industry into waterways, it can be dangerous to wildlife in them.

On the basis of the research, pointed out that no company in the field of textile industry does not possess a system for wastewater treatment. Industrial waste water is discharged mainly in the sewage network of the village, and some industrial plants wastewater directly discharged into the watercourse Figure 1, which significantly threatens the quality of its waters [9].



**Figure 1.** Colored textile discharged into waterways without prior treatment

For all these reasons, today's textile industry in the spotlight environmental protection. This leads to the adoption of new regulations and standards, as well as the strict criteria laid down by the Law on the protection of our environment. The law provides measures to protect waters, which should provide for preventing or limiting entry into the dangerous water, sewage and other harmful substances, monitoring and testing the quality of surface water and groundwater, as well as the quality of waste water treatment in order to preserve the flora and fauna of water eco-system [10].

In order to execute the treatment of wastewater generated in the textile industry requires large financial investments for projects process technology and equipment for wastewater treatment. These are long-term interventions, which aims to protect and preserve the environment. Most of the company from the textile industry does not possess a system for wastewater treatment. Industrial waste water is discharged mainly in the sewage network of the village, and some industrial plants wastewater directly discharged into the watercourse which significantly threatens the quality of its waters.

With proper process control, as well as proper selection of process water treatment, ensures the quality of finished textile products and the quality of water discharged into the recipients, which is the goal of modern textile industry.

In the last few decades, the textile industry uses several physical, chemical and biological methods faded, and among the many techniques for removing paint, adsorption procedure gives the best results as it can be used to remove different types of materials paintable. Most used activated carbon as an adsorbent for the removal of paint from the waste water due to its excellent adsorption capacity, but this paper analysis was performed with modified ash from power plants or thermal power plants which is very economical and convenient because it eliminates liquid waste satisfactory, in our case, textile waste water, resulting in the process of dyeing textiles.

#### **COMPARATIVE ANALYSIS OF THE FEASIBILITY OF DIFFERENT PROCESS WASTEWATER TREATMENT**

The processes of making textiles associated with the consumption of large quantities of clean water. During the various processes frees up a significant amount of polluted water. The average consumption of water in the textile industry is about 100-200 l/ kg of product. In comparison with the annual production of 40 million tons of textile fibers, it is estimated that the amount of wastewater generated, can reach 4-8 billion cubic meters per year.

Since the waste water is harmful to the environment and people, there are strict requirements in terms of wastewater discharge. However, due to differences in the raw materials, products, colors, technology and equipment standards for waste water discharge have too many items. They were developed at the national level for the protection of the environment according to local conditions and requirements of environmental protection that are not fixed.

Construction of the plant for the treatment of industrial wastewater costs between 1 and 10 million €. Ongoing maintenance of such equipment per month is around 3,000 € (data are relative and average, because they depend on many specific parameters, which can not be taken into account precisely in this calculation) [11]:

5,000,000 € + € 3,000.00 € x 12 = 5,036,000 € for the first year of operation of the plant.  
 3,000€ x 12 = 36,000 €/year for each additional year of plant operation.

The cost in this particular case studies with modified ashes, for solving the waste with the two above-mentioned apparatus (*Jet dyeing apparatus and Jigger dyeing apparatus*) for painting (one central factory), in the course of one year is:

$$1080 \text{ €/year} + 1650 \text{ €/year} = 2730 \text{ €/year.}$$

The quantities of waste water after the dyeing machines Jet and Jaeger are presented in Tables 1 and 2.

**Table 1.** The volume of waste water after the Jet dyeing apparatus for a certain period of time and the cost of treatment

Parameters	Period			
	Per shift 8 h	For the day (Two shifts)	For the month days (22 days)	For the year
The amount of wastewater after dyeing cotton	2 t	4 t	88 t	1.056 t
The cost for wastewater water modified ashes	2,05 EUR	4,1 EUR	90 EUR	<b>1.080 EUR</b> ili 1 EUR/m <sup>3</sup>

**Table 2.** The volume waste water after the Jigger dyeing apparatus for a certain period of time and the cost of treatment

Parameters	Period			
	Per shift 8 h	For the day (Two shifts)	For the month days (22 days)	For the year
The amount of wastewater after dyeing cotton	3 t	6 t	132 t	1.056 t
The cost for wastewater water modified ashes	3.125 EUR	6.25 EUR	137.5 EUR	<b>1.650 EUR</b> ili 1 EUR/m <sup>3</sup>

If you leave the town of treatment (if this is possible), or utility company, then the cost would be 1.5 - 2.5 €/m<sup>3</sup> (average of € 2). Data on the average annual level of between 5,000 and 8,000 € per plant, depending on the capacity.

More specifically, in the case of this study:

*Jet* appliance outlets, or 2 t (2 m<sup>3</sup>) while *Jigger* discharges or 3 t (3 m<sup>3</sup>) of wastewater per shift.

$$2\text{m}^3 + 3\text{m}^3 = 5 \text{ m}^3/\text{shift} \times 2 \text{ shifts} = 10 \text{ m}^3/\text{day} \times 22 \text{ days} = 220 \text{ m}^3/\text{month}$$

$$220 \text{ m}^3/\text{month} \times 12 = 2,640 \text{ m}^3/\text{year} \times 2 \text{ €} / \text{m}^3 = 5,280 \text{ €/year}$$

**Table 3.** Comparative analysis of the economic feasibility of the various processes of purification of waste waters generated by coloring textiles

Type of process wastewater treatment incurred by coloring textiles	The cost for a period of one year	Note
Construction of the plant for the treatment of industrial wastewater	36.000 €/ year	Construction of industrial waste water, will cost between 1 and 10 million €. The cost for the first year of operation of the plant would be 5,036,000 €
<b>Application of modified ash for solving waste Jet and Jigger appliances</b>	<b>2.730 €/year</b>	
Purification of waste water in the city's utility company	5.280 €/year	

Certainly the outpouring of undiluted or untreated waste from the textile industry into waterways threatening wildlife. Legal provisions and standards, as well as the strict criteria laid down by the Law on Environmental Protection, dictate purification procedure, which will be implemented in all industries, including the textile.

### CONCLUSION

To carry out the treatment of wastewater generated in the textile industry requires large financial investments for projects process technology and equipment for wastewater treatment. These are long-term interventions, which aims to protect and preserve the environment. Most companies in the field of textile industry does not possess a system for wastewater treatment. Waste water from the textile industry is mainly discharged into the nearest waterways and a small part is directly discharged into the sewer system network, which significantly threatens the quality of water. It is obvious that the acceptance of wastewater from different industries easiest to organize at the city level, ie. the area where the pollutants, considering that it is the most economical. If this is not feasible, then the implementation of the modified ash from thermal power plants can be a model that is economical and advantageous because satisfactory eliminate liquid waste (waste-colored water). From the above it can be concluded that the modification of the natural waste materials and the formation of new efficient adsorbents for purification as well as design models for successful treatment can be performed in the recycling of industrial environments which is in line with new trends and tendencies for the recycling of waste with the ultimate aim of prevent environmental pollution.

### *Acknowledgements*

*Prepared as a part of project No. TR 34020, supported by the Ministry of Education, Science and Technological Development of the Republic of Serbia*

## REFERENCES

1. Jovanović Kolomecjeva L. Hemija i zaštita životne sredine-Ekološka hemija, Savez inženjera i tehničara Srbije, Beograd, 2010.
2. Urošević S., Đorđević D., Textile Dye As Potential Dangerous Polluters, International scientific conference, International scientific conference, Sustainable Economy And The Environment, Beograd, 23-25.april 2014, Book of abstracts, pp.132.
3. Sun X.F, Wang, S.G. Liu, X.W., Gong W.X., Gao B.Y, Zhang H.Y, Biosorption of Malachite Green from aqueous solution onto aerobic granules: Kinetic and equilibrium studies, *Bioresource Tehnology*, 99 (2008) 3475-3483.
4. Malik, R., Ramteke D.S., Wate S. R, Adsorption of malachite green on groundnut shell waste based powdered activated carbon, *Waste Management*, 27 (2007) 1129-38.
5. Dhaouadi, H., Henni, F.M., Vat dye sorption onto crude dehydrated sewage sludge, *Journal of Hazardous Materials*, 164 (2009) 448-458.
6. Eswaramoorthi, S. Dhanapal, K. and Chauhan, D.S. (2008): Advances in textile waste water treatment: the casefor UV ozonation and membrane bioreactor for common effluent treatment plants in Tirupur, Tamil Nadu, India, *Environmental Technology Awareness Series*, pp.1-17.
7. Demirbas, E., Koboya, M., Sulak M.T., Adsorption kinetics of basic dye from aqueous solution onto apricot stone activated carbon, *Bioresource Technology*, 99 (2008) 5368–5373.
8. Directive 2000/60/EC of the European Parliament and of the Council of 23 October 2000 establishing a framework for Community action in the field of water policy, 2000.
9. <http://alfa.tf.ni.ac.rs/simpozijum/PDF/P17.pdf> -Žižić D., Otpadne vode najveći zagađivači životne sredine u gradu Leskovcu.
10. Urošević S., Alagić S., Uticaj otpadnih voda iz industrije tekstila na vodene ekosisteme, *Ecologica*, Beograd, godina XVII broj 58- 2010, str. 215-222.
11. Šmelcerović M, Prerada otpadne vode iz procesa bojenja pamuka i priprema za ponovnu upotrebu, doktorska disertacija, Tehnološki fakultet, Leskovac, 2016.





## ENERGY POTENTIAL OF COAL SLURRIES DEPOSITED IN ENVIRONMENT

Marcin Lutynski<sup>1</sup>, A. Lutynski<sup>2</sup>

<sup>1</sup>Silesian University of Technology, Faculty of Mining and Geology,  
Akademicka 2, 44-100 Gliwice, POLAND

<sup>2</sup>Institute of Mining Technology, Pszczynska 37,  
44-101 Gliwice, POLAND

\**marcin.lutinski@polsl.pl*

### INTRODUCTION

The use of coal slurries and post-flotation muds from the coal mining industry is an important element of rational waste management. Work in this field is being conducted for many years and the results are introduced to the industrial practice with good or bad results.

Reject from the beneficiation of flotation muds still has some valuable carbon content [1]. On the other hand the impoundments where these slurries are deposited contain also other coal processing waste. These were mostly waste from coal burning in local power or heating plants or other, such as construction waste. Therefore, impoundments are deposits of various types of waste and were not perceived as a valuable resource for further processing. Issues related to the assessment and inventory of such impoundments in Southern Poland were performed within the frame of development project Nr N R09 0006 06/2009 titled "Identification of energetic potential of coal slurries in the national fuel balance and technological development strategy of their usage". The project was implemented by the Institute of Mechanized Construction & Rock Mining in Warsaw in cooperation with the Department of Mineral Processing and Waste Utilization of the Silesian University of Technology. For the study, fifty-nine impoundments were identified where twenty were subjected to in-depth analysis of steam and coking coal slurries. From selected impoundments drillings were made and dozens of samples were acquired according to the certain methodology. In the vast majority of analyzed beneficiation methods the first step in order to obtain valuable carbon fraction is to separate fine grains. Fine grains are usually a problem for the beneficiation. Nevertheless, analysis of coal slurries and muds show that carbon content in grain of the size <0.1 mm is relatively high which is reflected in relatively high calorific value of this fraction.

## ENERGY POTENTIAL OF COAL SLURRIES

The basic quality [3], [4], [5] and quantity analysis of coal slurries allowed initial assessment of energetic potential of these deposits [2], [7].

In order to determine the energy potential of coal slurries an assessment algorithm was developed which is based on the following data:

- Estimated mass of coal slurry in the impoundment,
- Average calorific value determined based on the qualitative investigation of samples collected from the impoundment

These data serve as the approximate estimation of energy potential which is commonly reported in qualitative studies.

Thus, average energy potential of individual coal slurry deposit (impoundment) on as received or analytical state can be calculated using the following formula:

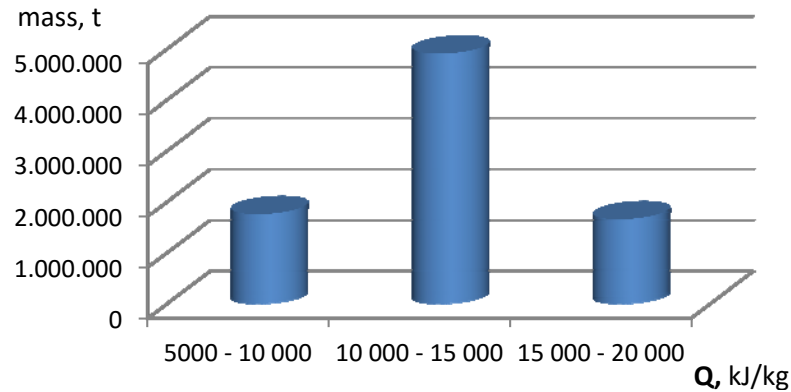
$$E_{avg} = M \cdot Q_{avg}^a \cdot 10^{-3} \quad [\text{GJ}]$$

where  $E_{avg}$  denotes mean energetic potential of the coal slurry deposit (impoundment) in GJ,  $M$  estimated mass of coal slurry in the deposit in t,  $Q_{sr}^a$  mean calorific value at analytical state or as received basis in kJ/kg determined in qualitative tests of individual samples collected from the impoundment. The results of these calculations are presented in Table 1.

**Table 1.** Average energy potential of coal slurries in impoundments calculated on as received basis [7]

Impoundment no,	Coal slurry mass,	Average calorific value	Energy potential,
	$M$ T	$Q_{av}^r$ kJ/kg	$E_{avg}$ GJ
1	1 000 000	12 380	12380000
2	300 000	12 552	3765600
3	1 000 000	12 179	12178667
4	100 000	7 737	773747
5	100 000	8 587	858675
6	640 000	11 087	7095825
7	1 521 000	6 874	10455354
8	176 000	13 115	2308240
9	1 117 000	10 213	11408107
10	155 000	18 979	2941794
11	153 000	19 352	2284311
12	345 600	19 285	6664939
13	163 000	12 038	1962221
14	460 000	16 155	7431258
15	130 000	8 256	1073316
16	228 000	13 648	3111873
17	106 000	14 869	1576075
18	102 000	15 385	1569270
19	176 000	15 057	2650090
20	236 000	14 636	3453624

Results from Table 1 served as the basis to construct a graph where ranges of calorific values of coal slurries in impoundments is shown (see Fig. 1)



**Figure .5.** Estimated mass of coal slurries with calculated calorific values

The next step of the study was to assess the potential for the recovery of valuable matter, namely coal. Beneficiation tests of coal slurries were carried out at a laboratory and a semi-technical scale [6]. Three different separation methods were tested:

- Centrifugal force separation method with the use of hydrocyclone classifier-separator and centrifugal separator,
- Wet gravity separation method with the use of Reichert spiral separator LD4,
- Physico-chemical method – flotation.

Results of tests are presented in [6] and served as the input of calculation of energy potential after the beneficiation for each method. Based on these results loss of energy potential (based on the efficiency of the method) was assessed. The energy potential assessment was conducted taking into account the following:

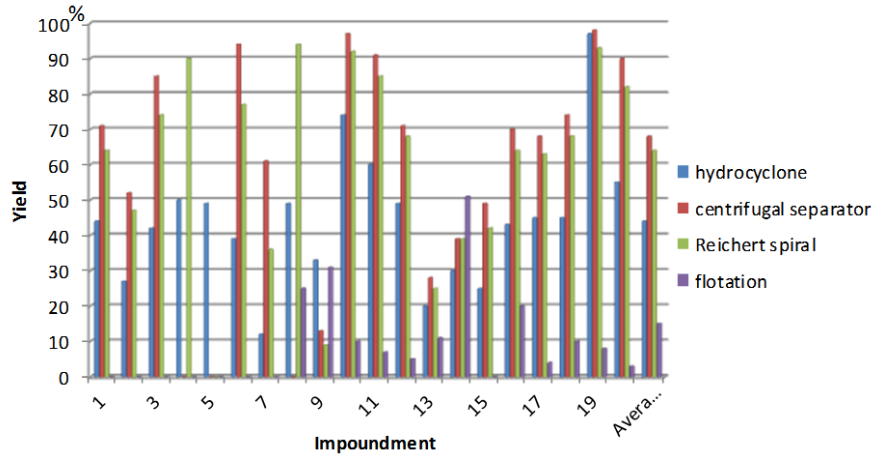
- Mass of coal slurry in the impoundment,
- Concentrate yield of beneficiation method,
- Average calorific value of concentrate from technological tests.

In order to compare different beneficiation methods it was decided to estimate the energy potential at analytical state. The average energy potential of impoundment is calculated with the following formula:

$$E_{avg}^a = M \cdot U \cdot Q_{avg}^a / 10^3 \quad [\text{GJ}]$$

Where  $E_{avg}^a$  is the mean energetic potential of the coal slurry deposit (impoundment) in GJ,  $M$  estimated mass of coal slurry in the impoundment in Mg,  $Q_{avg}^a$  denotes average calorific value of concentrate at analytical state determined in qualitative tests for individual beneficiation method in kJ/kg,  $U$  concentrate yield at technological test of beneficiation [-].

Results of energy potential loss of coal slurries at analytical state for four methods of beneficiation are presented in Fig. 2.



**Figure 2.** Coal slurries energy potential losses due to beneficiation with different methods

## CONCLUSIONS

Presented results show that coal slurries deposited in impoundments have a considerable energy potential. However, the quality of coal slurries varies which is obvious when considering different geology of coal deposits of the mines.

The average calorific value at analytical state of coal slurries deposited in impoundments varies between 9265 to 23293 kJ/kg

Results of test [6] indicate that there is a possibility for further beneficiation of these coal slurries. The most promising results, which seems obvious for this particular process, gives flotation method. On average, the loss of energy potential was 15% and it varied from 3 to 31% for the material from different impoundments. The average calorific value of the flotation product was 25 057 kJ/kg and was the highest amongst all the other methods. Unfortunately, not all the slurries were prone to flotation with the flocculants used in the tests.

Therefore, in any case of coal slurry beneficiation energy potential losses need to be taken into account. Moreover, each of these beneficiation methods requires additional quantities of water for the efficiency of the process.

From the results of tests we can conclude that coal slurries deposited in impoundments can be effectively recovered and the end-method of utilization will depend on the technology used for the beneficiation.

## REFERENCES

1. Blaschke W.: Określenie wartości mułów węglowych zdeponowanych w osadnikach ziemnych. Materiały VII Ogólnopolskiej Konferencji Naukowej pt. „Kompleksowe i szczegółowe problemy inżynierii środowiska” . Politechnika Koszalińska. Koszalin 2005r.
2. Lutyński A., Baic I., Lutyński M.: Potencjał energetyczny zdeponowanych mułów węglowych. Polityka Energetyczna Instytut Gospodarki Surowcami Mineralnymi i Energią Polskiej Akademii Nauk. Tom 15. Zeszyt 3. Kraków 2012r.
3. Lutyński A., Szpyrka J., Baic I.: Właściwości fizyko-chemiczne mułów węglowych zdeponowanych w osadnikach ziemnych. Monografia: Innowacyjne i przyjazne dla środowiska techniki i technologie przeróbki surowców mineralnych. Rozdział 3 Obiegi wodno-mułowe – technologie i automatyzacja procesów. ISBN 978-83-607008-59-0. Gliwice 2012 r.
4. Lutyński A., Szpyrka J.: Analiza jakości mułów węgla kamiennego zdeponowanych w osadnikach ziemnych. Kwartalnik Górnictwo i Geologia. Tom 6. Zeszyt 2. Gliwice 2011r.
5. Szpyrka J., Lutyński A.: Właściwości fizyko-chemiczne mułów węglowych zdeponowanych w osadnikach ziemnych. Rozdział Monografii: Innowacyjne i przyjazne dla środowiska techniki i technologie przeróbki surowców mineralnych. ISBN 978-83-60708-59-0. Gliwice 2012r.
6. Szpyrka J., Lutyński A.: Badanie podatności na wzbogacanie zasobowych mułów węglowych. Materiały Konferencji: Górnictwo zrównoważonego rozwoju. Politechnika Śląska Gliwice 28. 11. 2012r
7. Projekt rozwojowy Nr N R09 0006 06/2009 pt: „Identyfikacja potencjału energetycznego depozytów mułów węglowych w bilansie paliwowym kraju oraz strategia rozwoju technologicznego w zakresie ich wykorzystania”. Materiały niepublikowane.



## IMPROVING ENERGY EFFICIENCY OF FIRED HEATER BY HIGH EMISSIVITY COATING

Ladislav Lazic<sup>1</sup>, M. Lovrenic Jugovic<sup>1</sup>, A. Varga<sup>2</sup>, J. Kizek<sup>2</sup>

<sup>1</sup>University of Zagreb, Faculty of Metallurgy, Sisak, CROATIA

<sup>2</sup>Technical University, Faculty of Metallurgy, Kosice, SLOVAKIA

\*[lazic@simet.hr](mailto:lazic@simet.hr)

### ABSTRACT

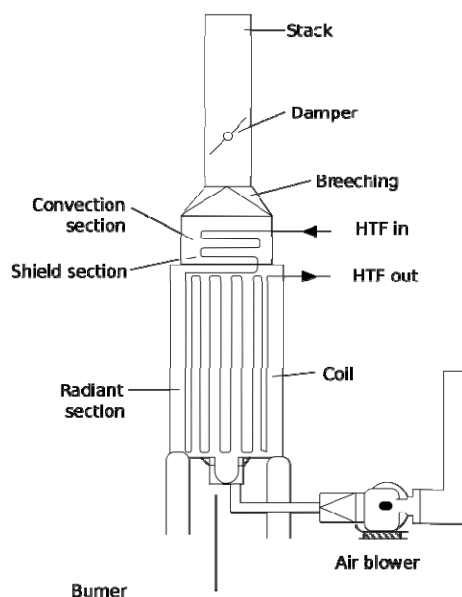
All process heaters consume large amounts of fuel to produce the necessary heat that must be transferred to the feed flowing through coils of tubes aligned throughout the heater. Energy costs represent up to 65% of the cost of running a chemical/petrochemical/refining complex. Furnace and heater fuel is the largest component of this cost. In this paper the application of high emissivity coating in fired heaters in order to intensify the heat transfer by radiation and increase the fired energy efficiency was analyzed. The objective is to find out effectiveness of the emissivity coatings on the fuel consumption.

**Key words:** fired heater, radiation, coating emissivity, energy efficiency.

### INTRODUCTION

A fired heater is a direct-fired heat exchanger that uses the hot gases of combustion to raise the temperature of a feed (Heat Transfer Fluid (HTF)) flowing through coils of tubes aligned throughout the heater. Depending on the use, these are also called furnaces or process heaters. Some heaters simply deliver the feed at a predetermined temperature to the next stage of the reaction process while others perform reactions on the feed while it travels through the tubes. These heaters are widely used for heating purposes in petroleum refining, petrochemical plants and other chemical process industries.

Tubular fired heaters are generally built with two distinct heating sections (Fig. 1): a radiant section, variously called a combustion chamber or firebox, and a convection section followed by the stack. The hot flue gases arising in the radiation section flow next into the convection section where they circulate at high speed through a tube bundle before leaving the furnace through the stack. A third section, known as a shield or shock section, separates the two major heating sections. It contains those tubes close to the radiation section that shield the remaining convection section tubes from direct radiation.



**Figure 1.** Schematic representation of a fired heater [1]

The radiant zone with its refractory lining is the costliest part of the heater and 85% of the heat should be gained in this zone, which is also called the firebox [2].

Fired heaters are usually classified as vertical cylindrical or box-type heaters depending on the geometrical configuration of the radiant section. In box-type heaters, the radiant section has generally a square cross section (as in older furnaces, where the reduced height is compensated for by a larger construction site) or a rectangular cross section (with its height equal to 1.5 to 2.5 times its width) as in cabin-type heaters. The tubes in the radiant section may be arranged horizontally or vertically along the heater walls and the burners are located on the floor or on the lower part of the longest side wall where there are no tubes. A fire wall is often built down the centre of the combustion chamber in heaters fired from the sides. Cylindrical heaters are often preferred to box-type heaters. This is mainly due to the more uniform heating rate in cylindrical heaters and higher thermal efficiency.

In both sections heat is transferred by radiation and convection, where radiation is the dominant mode of heat transfer at the high temperatures prevalent in the radiant section and convection predominates in the convection section where the average temperature is much lower. About 45-55% of the total heat release in the furnace is transferred to the process fluid in the radiant section. About 25-45% of the remaining total heat is partially transferred to the process fluid in the convection section and the unused portion is lost by the flue gases through the stack [3].

This clearly indicates that heat transfer by radiation is of particular significance for the thermal analysis and design of fired heaters in general. Otherwise, the radiant zone with its refractory lining is the costliest part of the heater. The heat-absorbing surface

is the outside wall of the tubes mounted inside the heater. The overall thermal efficiency of the fired heater is dependent to a large extent on the effectiveness of the recovery of heat from the flue gases, which depends in turn on the size of the heat exchange surface area in the furnace, as well as emissivity of combustion products, walls and tubes.

In this paper the application of high emissivity coating in fired heaters in order to intensify the heat transfer by radiation and increase the fired energy efficiency was analyzed. The objective is to find out effectiveness of the emissivity coatings on the fuel consumption.

### REFRACTORY WALL EMISSIVITY

The efficiency by which materials radiate is defined as emissivity ( $\epsilon$ ). Its value depends on the surface temperature and material properties of the radiating object's surface, and on the radiation wavelength. A surface with high emissivity has the ability to absorb radiant and convective energy at high temperature and reradiate up to 95% of that energy. Furnace refractories are often assumed to have an emissivity of about 0.9. However, in the case of most refractory materials the emissivity significantly decreases with temperature increase. Conventional refractories have low wall emissivity at high temperatures, so e.g.  $\epsilon$  can be  $<0.5$  at  $1000^{\circ}\text{C}$ . For instance, if the emissivity of a given type of a shamotte refractory brick is 0.9 at a temperature of  $130^{\circ}\text{C}$ , at  $1000^{\circ}\text{C}$  the emissivity might be 0.5 only. Ceramic fibre linings may also have an emissivity as low as 0.5-0.6 at high temperatures (Fig. 2). In the past forty years great attention has been paid to studying the emissivity of furnace linings [4] as well as to energy conservation through utilization of high emissivity coatings [5], the latter well complementing the use of low density insulating materials, such as ceramic fibres and refractory bricks [6].

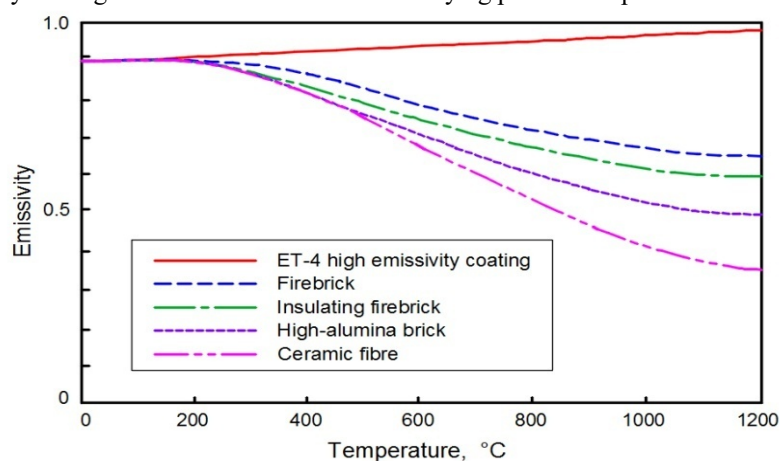
Emissivity, the measure of a material's ability to both absorb and radiate heat, has been considered by engineers as being an inherent physical property which like density, specific heat and thermal conductivity, is not readily amenable to change. However, the development of high emissivity coatings now allows the surface emissivity of materials to be increased, with resultant benefits in heat transfer efficiency and in the service life of heat transfer components. The high emissivity coating is applied on refractory or metal substrate to expose at high temperature. It should be remembered that high emissivity coating are not insulator or reflector. They are not barrier to conductivity of thermal energy through a furnace wall. Insulating refractories are generally place behind dense refractories at the cold phase of refractory design [7].

When high emissivity coating is applied in the interior surfaces of a high temperature heater, radiant energy from the burners and convective energy from heater atmosphere is absorbed by the surface face of the coating and reradiated to cooler process fluid (i.e. the fluid inside the reactor tube), where the temperature of wall furnace is higher than reactor tube. Namely, in gas or oil fired furnace, the gases are fired and after combustion in presence of air they absorbed and emit radiation at specific wave length corresponding to the spectra of  $\text{CO}_2$  and  $\text{H}_2\text{O}$ . Radiant energy from hot gases reflected back from the heater walls does not change its wavelength and hence can be significantly absorbed by gas before reaching to the reactor tube surface. Radiation that is absorbed by the wall on account of its emissivity is reemitted. If the wall is



black or a high emissive then more radiation will reach the reactor tube surface without reabsorption by the gas. Thus net redistribution of energy occurs across the spectrum resulting in an increase in heat transfer to the reactor tube.

High emissivity coatings are widely used in many high temperature applications to effectively transfer the heat by radiation [8-10]. The application of high-emissivity coatings in furnace chambers promotes rapid and efficient transfer of heat, uniform heating, and extended life of refractories and metallic components such as radiant tubes and heating elements. For intermittent furnaces or where rapid heating is required, use of such coatings was found to reduce fuel or power to tune by 25-45%. Other benefits are temperature uniformity and increased refractory life. In general, the emissivity of furnace that operates at high temperature is found to be 0.3. But with the help of emissivity coating, this can go to up to 0.85-0.95. This significantly results in increase of heat transfer through radiation. Emissivity is a property of the coating, which is in this case, remains between 0.85 and 0.95 up to temperatures in excess of 1650°C [11,12]. The Figure 4 shows emissivity of various insulating materials including high emissivity coatings. High emissivity coating shows a constant value over varying process temperatures.



**Figure 2.** Emissivity of refractory materials at different temperatures [10]

Emissivity coating is prepared by two major components: a high emissivity agent and a binder. A mix of various constituents is weighed in a weighing scale and added water to maintain a coating consistency after milling for certain duration. Ceramic coating thus prepared with desired rheological characteristics have been applied onto the surface of ceramic substrates by spraying /brushing. The settling of the slip is made to a minimum level with a higher solid content. The slip is coated on suitable ceramic substrate such as refractory insulation bricks, ceramic insulation fibre for attaining desired thickness. The details of the formulation of the coating materials are described in Ref. [13]. All the ceramic substrates can be spray and brush coated. The sprayed coated material looked to be more uniform as compared to that of brushing.

## MATHEMATICAL MODEL

The single gas zone model was used to analyze the impact of the emissivity of refractory lining on the heat transfer, and hence, on the energy efficiency as well as on the fuel consumption of the furnace.

The most significant development of a simple furnace model, so-called simple well-stirred furnace model, was made by Hottel [14] and is based on the presumption that many industrial furnaces operate with sufficient momentum in the air and/or fuel streams to create a reasonably well-stirred furnace chamber. This assumption allows most of the complex geometric problems associated with radiative heat transfer calculations to be reduced to a numerically simple solution.

Otherwise, zone models provide accurate calculations of thermal radiation and have very short computing times so that they can yield transient predictions and can be used to quickly analyse the relative effect of design options such as fuel type and refractory selection, and operating parameters such as air preheating, oxygen enrichment and excess air.

For this type of model, the following simplifying assumptions were made:

1. Combustion gas mass and flame are assigned a single temperature  $T_g$
2. The combustion gases leave the radiant section of the furnace at a temperature below  $T_g$
3. Spectral effects of combustion gases were included in the single well-stirred zone mode
4. Surface of reactor tube, area  $A_m$ , is grey, with an emissivity  $\varepsilon_m$ , at a single temperature  $T_m$
5. External heat losses and convective heat transfer to the walls (internal and external) are calculated
6. The reactor tube and refractory wall surfaces are intimately mixed, such that the view factors to load surface are the same from all points (speckled wall assumption)
7. Convection from the gases to the reactor tube is taken into account through the calculation of the coefficient of convection heat transfer.

This type of model belongs to the category of the steady-state models, which is based on the following balances:

- The mass balance: Mass Flow In = Mass Flow Out
- The energy balance: Energy Inputs = Energy Outputs

In this stirred heater model three zones are assumed: two surface zones (the reactor tube and the refractory) and the gas zone comprising the combustion products. The basic structure of the model is described by the following equation:

Rate of enthalpy derived from fuel + Rate of enthalpy with preheated combustion air - Rate of enthalpy (energy loss) with flue gases = Radiative and convective heat transfer (heat flow) to the reactor tube + Heat losses (heat flow) through the walls.

## RESULTS

In this article, energy efficiency and fuel consumption of the heater were compared for two cases:

- using the convectional refractory,
- using the convectional refractory with high emissivity coating on the refractory and reactor tube,

observed at two different temperatures of reactor tube.

The convectional refractory lining consists of high-alumina brick in the metal contact area and high strength brick (40% alumina firebrick, density 2000 kg/m<sup>3</sup>, maximum service temperature 1500°C, thickness 300 mm, thermal conductivity 1.0 W/mK, emissivity 0.5), which is sprayed with high emissivity coating with emissivity of 0.9.

The heater is fired with natural gas of the low heating value 48.5 MJ/kg. The internal dimensions of the heater filled with combustion gases are: D x H = 4.0m x 8.0m. The input data are as follows:  $T_g$ ,  $T_m$ ,  $\varepsilon_w$ ,  $\varepsilon_m$ ,  $h_{g-m}$ ,  $U$ .

Input and calculated values are presented for the convectional refractory lining in Table 1 and for coated lining and reactor tube in Table 2. In the last line of each table, for the case when the coating is applied, the value of temperature of combustion gases is set in such a way that the heat flow is the same as in the case of uncoated lining. This is done for reasons of comparison of energy efficiency and fuel consumption.

**Table 1.** Input and calculated values for the convectional refractory lining

$T_g$ °C	$T_w$ °C	$T_m$ °C	$\varepsilon_w$	$\varepsilon_m$	$h_{g-m}$ W/m <sup>2</sup> K	$U$ W/m <sup>2</sup> K	$\Phi_m$ kW	$\eta$	Fuel input kg/s
1100	823	200	0.5	0.8	5	1.5	7547	45.42	0.34242
1100	820	200	0.9	0.9	5	1.5	9042	45.57	0.40895
1035	772	200	0.9	0.9	5	1.5	7550	48.97	0.31774

**Table 2.** Input and calculated values for the coated lining and the reactor tube

$T_g$ °C	$T_w$ °C	$T_m$ °C	$\varepsilon_w$	$\varepsilon_m$	$h_{g-m}$ W/m <sup>2</sup> K	$U$ W/m <sup>2</sup> K	$\Phi_m$ kW	$\eta$	Fuel input kg/s
1100	857	500	0.5	0.8	7	1.5	6871	45.3	0.31264
1100	853	500	0.9	0.9	7	1.5	8233	45.46	0.37322
1042	815	500	0.9	0.9	7	1.5	6876	48.46	0.29242

Nomenclature:

$T_g$ - temperature of combustion gases, °C

$T_m$ - reactor tube temperature, °C

$T_w$ - refractory hot face temperature, °C

$\varepsilon_m$ - emissivity of reactor tube

$\varepsilon_w$ - emissivity of walls

$h_{g-m}$ - convective heat transfer coefficient between combustion gases and reactor tube, W/m<sup>2</sup>K

$\eta$ - thermal efficiency of the furnace

$U$ - overall heat transfer coefficient through the walls, W/m<sup>2</sup>K

$\Phi_m$ - heat flow to the reactor tube, kW

## CONCLUSIONS

Based on the results shown in the tables, it is evident that with the high emissivity coating can be achieved the increase of heat flow to the reactor tube by approximately 16.5%, which means the increase of heat capacity of heater for the same value. For the same heat capacity, in case of applying the high emissivity coating, energy efficiency can be increased by approximately 7%, and for the same value the fuel consumption might be reduced.

The replacement of the existing conventional convectional refractory lining or the choice of a high emissivity coating for furnaces and fired heaters is one of the key factors in minimization of energy consumption and adverse environmental impacts with the emissions of pollutants. It should be the objective to choose the optimal refractory lining under which the fired heater should be operated in order to maximize the energy efficiency and minimize the fuel consumption, taking into account the profitability of the investment i.e. the payback period.

## REFERENCES

1. <https://en.wikipedia.org/wiki/Furnace>, 15.03.2016.
2. Matlab - Modelling, Programming and Simulations, book edited by Emilson Pereira Leite, 2010, Chapter 16, Hassan Al-Haj I., Fired process heaters, <http://www.intechopen.com/books/matlab-modelling-programming-and-simulations/fired-process-heaters>, 15.03.2016.
3. Wildy F., Fired Heater Optimization, Technical Sales Support Manager, AMETEK Process Instruments, 150 Freeport Road Pittsburgh, PA 15044, <http://www.analitech.ru/files/Fired%20Heater%20Optimization.pdf>, 15.03.2016.
4. Goldsmith A., Waterman T.E., Hirschhorn H.J., Handbook of thermophysical properties of solid materials, Pergamon Press, Oxford (1961,1963).
5. Inst. of Energy, London: Ceramics in energy applications, Adam Hilger, Bristol and New York, 1990.
6. Benko I., High infrared emissivity coating for energy conservation and protection of inner surfaces in furnaces, Int. J. Global Energy Issues, 17 (2002) 1/2, pp.60-67.
7. [http://www.naref.com/products/Publications/Electric\\_Furnaces.pdf](http://www.naref.com/products/Publications/Electric_Furnaces.pdf), 15.03.2016.
8. Cockeram B.V., Measures D.P., Mueller A.J., The Development and Testing of Emissivity Enhancement Coating for Thermophotovoltaic (TPV) Radiator Applications, Thin Solid Films, 355–356 (1999), pp. 17-25.

9. Sumita T. et al., Terrestrial Solar Cells in Space, Proceedings of 2004 IEEE Radiation Effects Data Workshop Record, J. Black (Ed.), Atlanta, U.S.A., July 19–23, 2004, pp. 130-136.
10. He X., Li Y., Wang L., Sun Y., Zhang S., High emissivity coatings for high temperature application: Progress and prospect, *Thin Solid Films*, 517 (2009), pp. 5120–5129.
11. <https://beeindia.gov.in/sites/default/files/2Ch5.pdf>, 15.03.2016.
12. Sheil P.C., Kleeb T.R., High emissivity Coating for Improved Performance of Electric Arc Furnaces, *Iron Steel Technol.*, 3(2006), 2, pp. 49-53.
13. Chauhan D.V., Misra S.N., Shukla R.N., Synthesis of high emissivity coating for ceramic substrate towards energy conservation, *International Journal of Scientific Engineering and Technology*, [www.ijset.com](http://www.ijset.com), 1(2012)3, pp.36-40.
14. Hottel H.C., First estimates of industrial furnace performance – the one-gas-zone model re-examined, in *Heat Transfer in Flames*, Chapter 1, edited by Afgan and Beer, Wiley, New York, 1974, pp. 5-28.



## AN INFLUENCE OF DOMINANT ENERGY EFFICIENCY FACTORS ON ENERGY RENOVATION OF AN OLDER HOUSE

Zdravko Praunseis

<sup>1</sup>University of Maribor, Faculty of Energy Technology, Institute of Energy Technology,  
Hocevarjev trg 1, Krsko, SLOVENIA

*zdravko.praunseis@um.si*

### ABSTRACT

This paper presents an energy renovation of an older house, following the state regulations for efficient energy use. There are many ways to design successful energy efficient homes, because that they can be constructed from many different types of construction material. Becoming a successful builder of energy efficient homes does not merely require a good knowledge of theory in new building techniques, but also skills in implementing innovative designs and high-quality construction practices. The energy performance of building is evaluated and then an energy performance certificate is granted; these certificates are obligatory for all public buildings and also for all buildings that are rented or sold.

**Key words:** Energy, Energy Performance Certificate, Renovation, Renewable Sources.

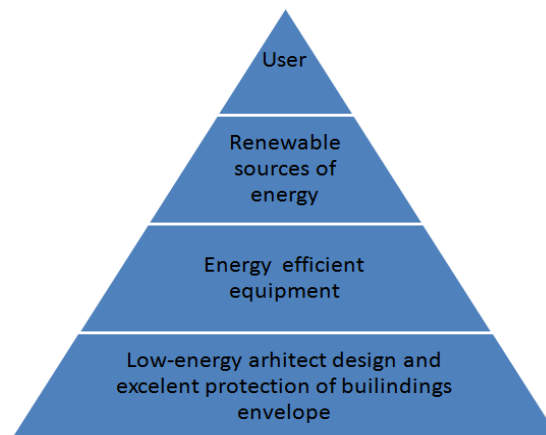
### INTRODUCTION

In the Republic of Slovenia, buildings are mostly energy inefficient. For example almost two-thirds one of multi-dwelling buildings are energy inefficient with regard to the thickness of the insulation of the external walls. Only 16% of all windows have energy efficient glass. Energy efficient renovation is defined as one that accomplishes at least a 30% reduction of energy use and, of course, fulfils all requirements set by the law. Such goals can be reached by carefully planning the renovation; specifically, the following steps shall to be followed, *Praunseis, [1]*:

- Constructing a so-called buildings envelope with additional heat insulation made without heat-bridges and airless,
- Installing new efficiency equipment for heating and air-conditioning with recuperative functions and low electricity consumption,
- Installing low-emissivity window glazing can control solar heat gain and lose in hot climates,
- Making use of solar energy for hot water preparation can reduced energy consumption by at least 50%,
- Installing a photovoltaic system (PV system) for generating electric power influences the energy balance of the building,

- Selecting appropriate energy carriers, i.e. choosing renewable energy and systems where possible,
- Building a passive cooling system.

With the practical case of the Jozlinova house, some possibilities of renovation of the old house shall be demonstrated with main goal making an energy efficient house. Materials and construction types for walls, ensuring the presence of excellent heat envelope of the building as well as some renewable sources of energy shall be presented.



**Figure 1.** Dominant factors for energy efficiency building

### ENERGY EFFICIENT BUILDINGS – LAW REQUIREMENTS

As the member of EU, the Republic of Slovenia has adopted EU Directive EU-EPBD Recast 2010/31/EU (previously Directive EU-EPBD 2002/91/EU). Both directives are related to the energy efficiency of buildings. Some other EU directives have also been adopted for the purposes of energy reduction, e.g. Directive 2006/32/EC on end-use efficiency and energy services and Directive 2009/28/EC on renewable energy, according to which Slovenia has to achieve a goal of 25 % renewable energy sources in end-use.

On the basis of the above mentioned EU directives Slovenia has adopted new proposals and requirements in its legislation *UL RS*, [2, 3]. The law covering civil engineering has prescribed new regulations:

- Statute of efficient energy use in buildings ( PURES 2010)
- Technical guide TSG-1-004:2010- Efficient energy use

When preparing project documentation for obtaining building permission, a document of energy performance for building must be prepared as a standard part of physics of the civil engineering requirements.

## RENOVATION

Renovation typically entails two phases; civil works for improving the building envelope and installing new equipment, *Praunseis and others, [4]*:

### *Renovation for Improving Building Envelope-Civil Works*

The building envelope represents the border between the building and its surroundings; mostly the external walls, roof and ground-floor.

*External wall* - A decision was made that outside wall shall be built from modular bricks, which are good insulators and are a well-known material. Recently development bricks thicker walls to provide better thermal insulation; the latest type versions use internal fillers instead of air.

Requirements for much lower thermal transmittance for walls can be attained with the use of *insulating material* such as glass wool (fiberglass), mineral wool (stone wool), EPS (expanded polystyrene) and where water is present XEPS (extruded polystyrene) shall be used. All these insulating materials have low thermal conductivity ( $\lambda$  ; W/mK) i.e. they retain heat. All the above mentioned insulating materials can be built with easy as they are light, inexpensive and easily handed. Recently cellulose insulation has been used in wooden panel building; it is placed in the space between wooden panels with the blower. Cellulose is considered an ecologically sound material and has lower temperature conductivity ( $a=\lambda/\rho \times c$ ; m<sup>2</sup>/h) than mineral wool. It also has lower phase delay, which means that more time is needed to warm or cool the place, which is especially in summer when the building is being cooled at night.

For insulation against water and moisture (waterproofing), a *hydro-isolation* material shall be used. This *waterproofing membrane* (Fig.2) is made from different types of reinforcement (glass fleece, geotextile) coated on both sides with oxidized bitumen. This shall be built as the first ground-layer insulation on the concrete floor. Special requirements for waterproofing are necessary for basement rooms.

Special attendance must be dedicated to physic of building and for water and water vapour transferring trough different walls or construction system. For this purpose *protective membranes* made very thin from PVC or PE (Fig.3) are used. They are classified according to their function: to stop water and let trough vapour, to stop vapour and to stop water. It is a rule that on the outside shall be guaranteed waterproof and on the inside must be membrane which lets vapour trough.



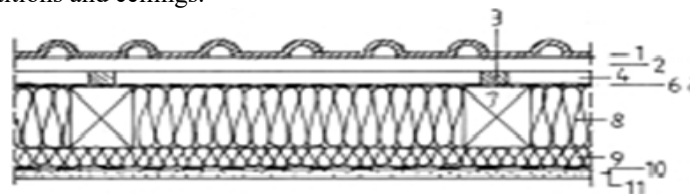
Figure 2. Waterproofing membrane





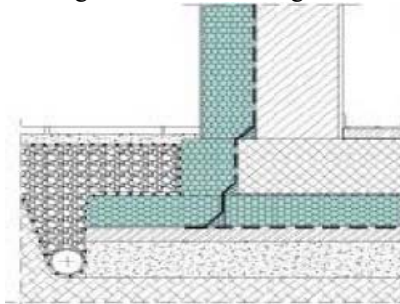
**Figure 3.** PE protective membrane

*Roof* – for roof a typical type of roof with ventilation (Fig.4) shall be built with two layers of isolation mineral wool that all thickness of isolation is more than 20 cm ; between wooden beams shall be fixed wool in rolls (pos. 8) and then additionally shall be fixed wool in slabs (pos. 9) to wooden beams. On the isolation from inside of space was put vapour-stop membrane from Aluminium (pos.10) which has been tightened well. At the end as final layer “knauf” gypsum board (pos.11) which are technically excellent for cladding walls and ceilings constructed on metal grids and wooden frames : for furring, partitions and ceilings.



**Figure 4.** Roof details

*Basement* – renovation of the basement of the old house requires high attention while thinking that earth is a good isolator is wrong. Floor in basemen (Fig.5) must be isolated (isolation under concrete baseplate) and at same time protected against water (hydro-isolation). On the concrete baseplate first isolation from XPS (extruded polystyrene) shall be fixed (Fig 6.), than layer of concrete (slab concrete) and finally ceramic. Layer of concrete shall be used for levelling and served as hard ground for final layer.



**Figure 5.** Basement waterproofing detail



**Figure 6.** Placing of XPS isolation

*Doors and windows (building furniture)* – for windows have been chosen wooden windows type Ekolight. These windows are double-glazed with  $U_w = 1,2$  W/m<sup>2</sup>K. Also wooden doors has been chosen from wood of spruce type Klasik  $U_d < 1,6$  W/m<sup>2</sup>K (Fig.7).



**Figure 7.** Windows and Doors

#### ***Placing New Equipment Based on Renewable Energy***

State regulation prescribes that a least 25 % all needed for building energy must be full-filled by *renewable sources of energy*.

Renewable sources of energy are:

1. Sunlight ( solar thermal collection system for hot water and photovoltaic system – PV system for converting sunlight into electricity)
2. Wind ( bulk movement of air)
3. Hydro (rivers, rain, tides, waves)
4. Biomass ( biological material)
5. Geothermal ( thermal energy generated and stored in the Earth)

For our object following steps have been made:

- Placing *solar thermal collectors* type evacuated tube collectors (Fig.8) for hot water and supporting of heating in winter time



**Figure 8.** Fixed solar collectors



**Figure 9.** Evacuated tube collectors

For hot water evacuated tube collectors (Fig.9) have been fixated while they are based on the latest technology and also achieving greater efficiency as previous flat-plate collectors, especially in colder conditions. Vacuum between the two glass layers insulates against heat loss.

- Placing an *air-source heat pump for heating*

Air source heat pumps (Fig. 10) are used to provide interior space heating and cooling even in colder climates, and can be used efficiently for water heating in milder climates (Fig. 11). A major advantage of some ASHPs is that the same system may be used for heating in winter and cooling in summer, though it is not true air conditioning without a facility to adjust the humidity of the inside air. Though the cost of installation is generally high, it is less than the cost of a ground source heat pump because a ground source heat pump requires excavation to install its ground loop.



**Figure 10.** Air source-heat pump

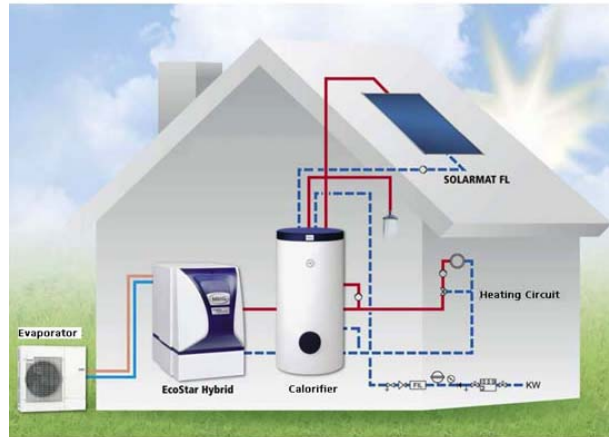


Figure 11. Function of air source heat pump

- Placing *heat recovery ventilation*

*Heat recovery ventilation*, also known as *HRV*, is an energy recovery ventilation system using equipment known as a heat recovery ventilator, heat exchanger, air exchanger, or air-to-air heat exchanger (Fig. 12) which employs a counter-flow heat exchanger (counter current heat exchange) between the inbound and outbound air flow. HRV provides fresh air and improved climate control, while also saving energy by reducing heating (and cooling) requirements.



Figure 12. Main unit of heat recovery ventilation

- Placing *underfloor heating*

Underfloor heating (Fig.13) was selected for warmer due to its low temperature level of heating ( 35 degrees Celsius) which it is for human most comfortable while heat must be placed on feet not on head. Low temperature level of heating is more economical as middle or high temperature while energy needed for building can be reached with less power. Alternative is also wall heating system (Fig. 14)



Figure 13. Underfloor heating system



Figure 14. Wall heating system

### RESULTS OF ENERGETIC RENOVATION

All activities done for energetic renovation of older house becoming energy efficient building can be measured by calculating. Approval for energy efficient building is given by numeric (energetic) indicators. For this purpose *energy performance certificate, UL RS, [5]*, has been adopted which is public document with accompanied by recommendations for cost-effective improvement of the energy performance. Energy performance certificate can be measured or calculated depending on type of buildings. For our object calculated energy performance certificate was made and issued by software program Knauf-energy and can be seen on next page.

1. Coefficient of heat loss due to transmission through building envelope area  
 $H_t'(T) = H(t)/A$

$$H_t' < 0,28 + T_L/300 + 0,04/f_0 + z/4 \quad (4.1)$$

Where means no number between window area (z- civil engineering frame) and building envelope area

$$H_t' = 0,295 \text{ W/m}^2\text{K} < H_{t'_{\max}} = 0,396 \text{ W/m}^2\text{K}$$

<b>ENERGY PERFORMANCE CERTIFICATE</b>	
<b>Building data</b>	<b>Type of EPC: calculated</b>
Reference number:                      Validity:	Type of building: dwelling house
Identification of building: JOZLINOVA HOUSE	Picture of building:
Dwelling type: 11100 One-dwelling building Year of built up : 2013 Address : Jozlinova house , Krško  Commune : VIDEM Property nr.: 1 Coordinates (Y,X): 539000 , 90000	
<b>Energy need for heating</b>	
Razred <b>B1</b> 18 kWh/m <sup>2</sup> a 	
20 kWh/m <sup>2</sup> a REFERENČNA KLIMA	
<b>Energy need for working of all system in building</b>	
45 kWh/m <sup>2</sup> a 	
<b>Primary energy and CO<sub>2</sub></b>	
63 kWh/m <sup>2</sup> a 	
33 kg/m <sup>2</sup> a	
<b>Publisher</b>	<b>Qualified assessor</b>
FE (accreditation number: )	SR (assessor nr: )
Name and surname : SR	Name and surname:
(opojia: elektronski podpis)	(opojia: elektronski podpis)
Date of issue : 10.04.2013	Date of certificate: <T607>
<small>                         Izdajatelj je energetska izkaznica s podpisom poštujem, da ne obstaja kalibra od državnih Energetskih zakonov (Ur. l. RS 27/07) - uradno preč. besedilo s spremembami, ki bi ni pripravljena izdelavo energetske izkaznice.                     </small>	
<small>                         Energetska izkaznica stabe je izdelana v skladu s Prilinkom o metodah izdajanja in izdaji energetske izkaznice stabe in z Energetskim zakonom (Ur. l. RS 27/07) - uradno preč. besedilo s spremembami. Page 1/3                     </small>	



Figure 15. Energy performance certificate

2. Allowed yearly energy need for heating of building  $Q_{(NH)}$ , calculated to condition area  $A_{(k)}$  or volume of the building  $V_{(e)}$  shall not be exceeded:

$$Q_{(NH)}/V_{(e)} < 45 + 60 f(0) - 4,4 T_{(L)} \text{ ( kWh/m2a ) ( for residential buildings )} \quad (4.2)$$

$$Q_{(NH)}/A_{(k)} = 17,9 \text{ kWh/m2a} < (Q_{(NH)}/A_{(k)})_{\max} = 43,1 \text{ kWh/m2a}$$

As can be seen in energy performance certificate ( figure on the previous page) our object is classified into B1 class.

3. Allowed yearly energy need for cooling  $Q_{(NC)}$  of building, calculated to condition area  $A_{(k)}$  shall not be exceeded .

$$Q_{(NC)}/A_{(k)} < 50 \text{ kWh/m2a (for residential buildings)} \quad (4.3)$$

$$Q_{(NC)}/A_{(k)} = 18,6 \text{ kWh/m2a} < (Q_{(NC)}/A_{(k)})_{\max} = 70 \text{ kWh/m2a}$$

4. Allowed yearly energy need for working all systems in building  $Q_{(p)}$ , calculated to condition area  $A_{(k)}$  shall not be exceeded :

$$Q_{(p)}/A_{(k)} = 200 + 1,1 ( 60 f(0) - 4,4 T_{(L)} ) \text{ kWh/m2a} \quad (4.4)$$

$$Q_{(p)}/A_{(k)} = 62,5 \text{ kWh/m2a} < (Q_{(p)}/A_{(k)})_{\max} = 187 \text{ kWh/m2a}$$

5. Calculated yearly CO2 emission is 33 kg/m2a
6. The percentage ratio of renewable sources of energy is 44 % what confirms that prescribed demand has been reached.
7. Calculated thermal conductivities of the building envelope are below prescribed values in book TSG-1-004:2010

## CONCLUSIONS

The scope of the task was to illustrate integrity of solving building energy efficiency which is provided by the latest state regulation. Main materials and technologies are demonstrated as sample model for construction type of building envelope in purpose to achieving all prescribed requirements. Renewable sources of energy are classified and technical solutions which have been chosen for our object.

By making and issuing energy performance certificate on the basis of program Knauf-energy was confirmed, due all done activities in building, that calculated energy indicators are below as prescribed. Definitively it has been confirmed that our renovated object "Jozlinova house" is energy efficiency building which should be served to the owner with low-cost operating of the house.

Our object is classified according to energy performance certificate into B1 class what means that object has very high energy efficiency and it belongs to the group of



“low-energy houses”.

Energy becomes more and more important and its role in the future will be great also in geo-political field. Part of energetic plan is also controlling and managing over need consumption of energy, which shall be limited due to new state regulation. Managing with the energy shall become more and more economically due to regulations and new technical solutions.

#### **Nomenclature**

(Symbols): (Symbol meaning);  $\lambda$ : thermal conductivity,  $a$ : temperature conductivity,  $U$ : heat transfer coefficient

#### **REFERENCES**

1. Z. Praunseis, R. Strojko: *Energy efficient Jozlinova house*, Seminar work, Faculty of Energy Krško, April 2013
2. UL RS: *Statue of efficient energy use in buildings ( PURES 2010) ( Pravilnik o učinkoviti rabi energije v stavbah - UL RS št. 52/30.6.2010)*
3. UL RS: *Technical guide TSG-1-004:2010-Efficient energy use; ( Tehnična smernica za graditev TSG-1-004- Učinkovita raba energije - UL RS št. 52/30.6.2010)*
4. Z. Praunseis and others: *Energy efficient house*, EOO-Seminar work, Faculty of Energy Krško, February 2012
5. UL RS: *Statue of methodology making and issuing of energy performance certificates for buildings (Pravilnik o metodologiji izdelave in izdaji energetskega izkaznika stavb – UL RS št. 77/2009 z dne 02.10.2009 in Pravilnik o spremembah in dopolnitvah Pravilnika o metodologiji izdelave in izdaji energetskega izkaznika stavb – UL RS št. 93/2012 z dne 07.12.2012)*





## SHALE GAS POTENTIAL AND METHODS OF GAS CONTENT MEASUREMENT IN POLAND

Marcin A. Lutynski<sup>1\*</sup>, M. A. Gonzalez<sup>1</sup>, J. Szczepanski<sup>2</sup>, P. Słomski<sup>2</sup>

<sup>1</sup>Silesian University of Technology, Faculty of Mining and Geology, Institute of Mining,  
ul. Akademicka 2, 44-100 Gliwice, POLAND

<sup>2</sup>University of Wrocław, Institute of Geological Sciences, Pl. M. Borna 9,  
50-204 Wrocław, POLAND

\**marcin.lutinski@polsl.pl*

### ABSTRACT

Recent research performed on Polish shales shows the potential of these types of formations as a source of unconventional gas and oil as well as a geological trap for CO<sub>2</sub> storage [1–3]. The paper presents general information about the Baltic-Podlasie-Lublin basin and the methods used to perform gas in place calculations. These issues are within the scope of the SHALESEQ project funded by Polish-Norwegian Research Fund.

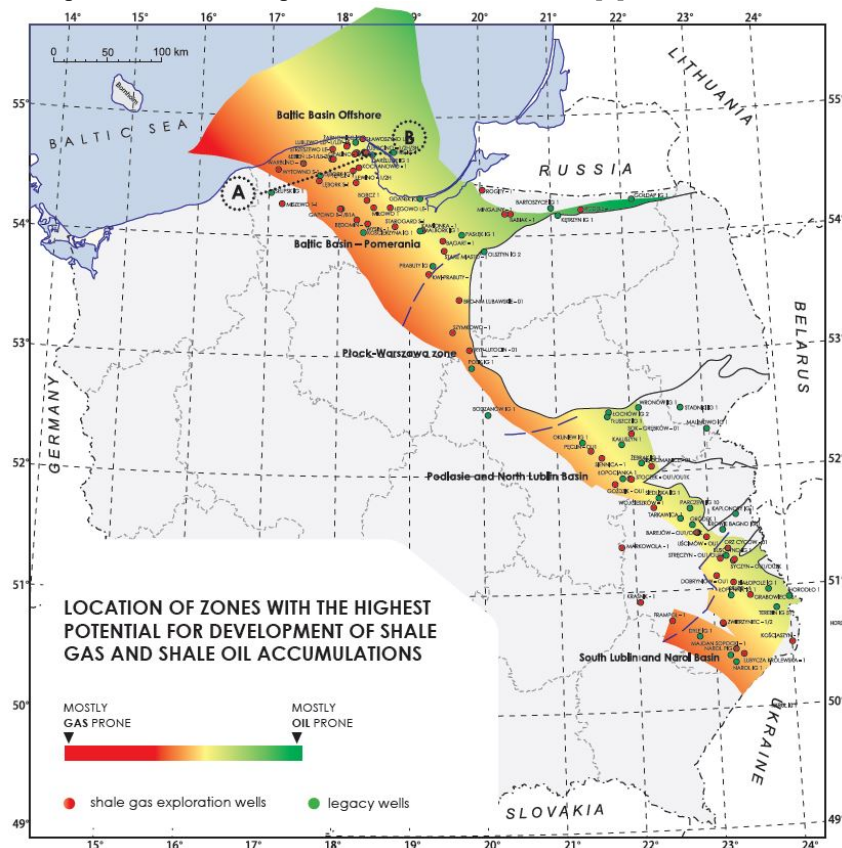
**Key words:** Polish shales, Ordovician–Silurian boundary, unconventional resources, gas in-placer, sorption.

### INTRODUCTION

During the first decade of XXI century USA and the lesser degree also Canada experienced “energetic revolution” related to production of unconventional gas and oil. A significant impact on gas and oil prices as well as in energetic security was achieved, due to the fast increase of the production of these resources. Technologic and economic success of this sector of petroleum industry in North America has inspired attempts to export this concept to other continents, including Europe at the beginning of the second decade. Most intensive exploration of shale gas and oil, apart from the two mention countries, took place in the Lower Paleozoic Baltic-Podlasie-Lublin Basin in Poland. First shale gas exploration well in Poland was opened in 2010 and till the first quarter of 2015, 70 exploration wells were done (Fig. 1), including 16 horizontal wells. The prospective shale formations are spread over a large area of 37000 km<sup>2</sup> and occur at depths ranging from about 2000 m to 5000 m [4,5].

For the time being, hydraulic fracture stimulation jobs have been performed in 25 wells, of which only 12 are horizontal. The best initial production rates were achieved in the Baltic Basin. It is believed that the current level of economical production in Poland should be at least three times higher than the rates that were achieved so far.

Therefore, more exploration wells and new rock stimulation ideas are needed to contour the sweet spots and unlock the potential of the Polish shales [5].



**Figure 1.** Location of the zones with the highest potential for development of shale gas and shale oil accumulations. Source: Kiersnowski & Dyrka, *Polish Geological Review*, vol. 61, nr 6, 2013 after Poprawa, *Polish Geological Review*, vol. 58, nr 3, 2010.

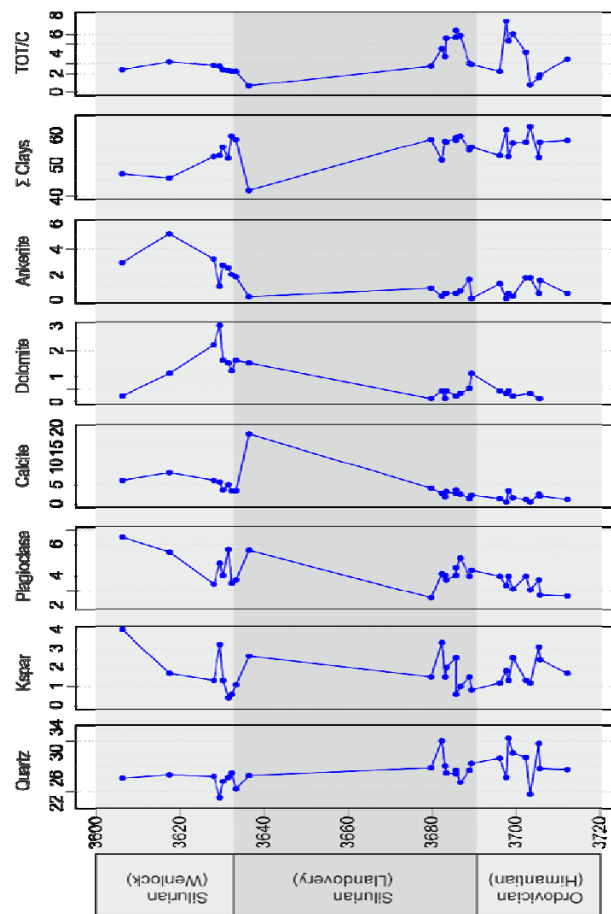
## GEOLOGICAL SETTINGS

The Lower Palaeozoic shale succession forms a ca. 700 km long belt extending from S Sweden, through Poland to Ukraine (Fig. 1) and resting on crustal basement of SW margin of the East European Craton (EEC) and the Trans European Suture Zone (TESZ). The sedimentary succession that fills the basin was deposited in three depocentres, referred to as the Baltic, Podlasie and Lublin basins. These rocks hold the unconventional potential for shale gas and shale oil exploration [6–8].

During the course of the Shaleseq project Upper Ordovician (Hirnantian) through Lower Silurian (Landowery) to Middle Silurian (Wenlock) shale samples were collected (Fig. 2). Studied set of samples represent thinly laminated mudrocks with

matrix composed of mixture of clay minerals, true micas and chlorites. Carbonates, both dolomite and calcite, occur as small crystals from 10 – 30 microns in diameter, evenly dispersed in the matrix. Framework grains are represented by quartz, feldspar, chlorites and both dark and white mica flakes. Moreover, in some samples barite and titanium oxide are present as accessory phases. Opaque minerals are represented mainly by pyrite, occurring both, as relatively large, elongated concentrations of crystals aggregates of up to 2.5 mm in length and as framboids of up to 20 microns in diameter. As determined by the XRD analysis (Fig. 2) the bulk mineralogy of the studied samples is dominated by clay minerals, quartz, carbonates and feldspars. In general, clay content decreases up the stratigraphic profile, whereas feldspar and carbonate content increase in the same direction.

Total Carbon (TC) content as well as Total Organic Carbon (TOC) were measured using LECO technique. Values of TC fall in the range from 2.23% to 7.32% (Fig. 2) with the largest values recorded for lower portion of the analysed profile.



**Figure 2.** Vertical variability of mineralogical composition of investigated samples based on XRD analysis.

## **METHODS OF GAS CONTENT ESTIMATION**

For the estimation of gas content in the basin, two main methods, called direct and indirect, are available. In the direct method, the sample is introduced in a canister where the gas desorption is measured. These measurements can be done in different ways: the quick crushing method, the extended desorption method and the pressure coring method. In the quick crushing method, the sample is crushed right after being extracted and immediately introduced in a desorption canister. This is a widely used method due to low cost and fast results, although it has several disadvantages such as the impossibility of measuring the desorbed and the residual gas separately and the desorption time [9].

For the extended desorption method, the sample is directly introduced into the canister to complete the desorption process and afterwards, it's crushed inside an air-tight container to find the amount of the residual gas. Despite of being more accurate than the previous method, it takes a much longer time to desorb the sample without being crushed; therefore it's not used in the cases where a fast estimation is needed [10]. Pressure coring method is the most accurate one and is used to obtained samples at an in-situ condition without losing gas content, but with the major drawback of being much more expensive [11].

Most commonly used indirect method is the one based in the sorption capacity of the rock, where sorption capacity and Langmuir parameters are calculated. These measurements can be performed using different types of setups such as a high pressure manometric setup shown in Fig. 3. These can be later used in conjunction with other basin characteristics such as permeability, porosity and bulk density to upscale the laboratory results [12].



**Figure 3.** High precision manometric sorption setup from the Mining and Geology Faculty of the Silesian University of Technology

## CONCLUSIONS

Poland still has a huge potential for unconventional resources, but the huge extension of the prospective area makes necessary the excavation of new wells to get more detailed information of the Polish potential of shale gas and oil producer.

These new wells should improve the understanding of the different formations and their characteristics, due to the huge heterogeneity of results obtained at close distance inside the same formation, not only taking under consideration the XRD analysis but also the porosity, water saturation, etc.

Results obtained so far, using the indirect method, concord with the theoretical assumptions, where Llandovery and Hirnantian formations have the highest sorption capacity and gas in-place calculations, the realization of more in-situ tests to estimate the gas content is needed to accurately correlate the laboratory experiments to the in-situ conditions of the rock.

### *Acknowledgments*

*The research leading to these results has received funding from the Polish-Norwegian Research Programme operated by the National Centre for Research and Development under the Norwegian Financial Mechanism 2009-2014 and Project Contract No. PL12-0109*

## REFERENCES

1. Mustafa, K.; Sephton, M.; Watson, J.; Spathopoulos, F.; Krzywiec, P.; 2015. *Organic geochemical characteristics of black shales across the Ordovician–Silurian boundary in the Holy Cross Mountains, central Poland*. Marine and Petroleum Geology, 66: 1042–1055.
2. Kosakowski, P.; Krajewski, M.; 2015. *Hydrocarbon potential of the Zechstein Main Dolomite (Upper Permian) in western Poland: Relation to organic matter and facies characteristics*. Marine and Petroleum Geology, 68: 675–694.
3. Lutyński, M.; González, M.; 2016. *Characteristics of carbon dioxide sorption in coal and gas shale - The effect of particle size*. Journal of Natural Gas Science and Engineering 28. 558–565.
4. Polish Geological Institute, 2012. *Assessment of shale gas and shale oil resources of the Lower Paleozoic Baltic-Podlasie-Lublin basin in Poland*.
5. Polish Geological Institute, 2015. *Oil and Gas in Poland, new opportunities*.
6. Kanev S., Margulis L., Bojesen-Koefoed J., Weil W., Merta H., Zdanavičiūtė O., 1994. *Oils and hydrocarbon source rocks of the Baltic syncline*. Oil and Gas Journal, 92: 69-73.
7. Klimuszko E., 2002. *Utwory syluru południowo-wschodniej Polski jako skały potencjalnie macierzyste dla dewońskich rop naftowych*. Biuletyn Państwowego Instytutu Geologicznego, 402: 75-100.

8. Poprawa P., 2010. *Potencjał występowania złóż gazu ziemnego w łupkach dolnego paleozoiku w basenie bałtyckim i lubelsko-podlaskim*. Przegląd Geologiczny, 58(3): 226-249.
9. Perera, S., Ranjith, P., Choi, X., Airey, D., Weniger, P., 2012. *Estimation of Gas Adsorption Capacity in Coal: A Review and an Analytical Study*. International Journal of Coal Preparation and Utilization 32(1): 25-55.
10. Sawyer, W., Zuber, M., Kuuskraa, V., Homer, D., 1987. *Using reservoir simulation and field data to define mechanisms controlling coalbed methane production*. Coalbed Methane Symposium, University of Alabama, Tuscaloosa, AL, 295–307.
11. Owen, L., Sharer, J., 1992. *Method calculates gas content per foot of coalbed methane pressure core*. Oil Gas Journal 2: 47–49.
12. Ambrose, R., Diaz-Campos, M., Akkutlu, Y., Sondergeld, C., 2010. *New Pore-scale Considerations for Shale Gas in Place Calculations*. SPE Unconventional Gas Conference, SPE 131722.



## UTILIZATION OF *MISCANTHUS GIGANTEUS* AS THERMAL INSULATION MATERIAL

Ivana Jelic\*, D. Antonijevic, G. Drazic, J. Aleksic, I. Petric

\*Singidunum University, Faculty of Applied Ecology – Futura, Belgrade, SERBIA

\*ivana.jelic@futura.edu.rs

### ABSTRACT

This study is carried out to investigate the possibilities of utilization of ecoremediation plants based on cellulose fibres, as non-constructive insulating material. Study represents characteristics of *Miscanthus Giganteus* as well as recommended analyses for evaluation of thermomechanical properties of its possible insulation products. In previous studies, proposed plant has already shown excellent remediation properties. Insulating material made from *Miscanthus Giganteus*, since it belongs to a cellulose-based species, is expected to perform as satisfactory insulation. Thermal conductivity for *Miscanthus Giganteus* insulation products is anticipated to meet prescribed values and criteria for non-constructive and constructive insulating materials.

**Key words:** green-building, heat-transfer, insulation, *Miscanthus Giganteus*, ecoremediation.

### INTRODUCTION

For decades, the highest amount of the final energy is consumed in buildings for heating, cooling, ventilation and lighting. Energy use in buildings, in public and residential sector is predominated by the use of energy for heating, and in recent years more and more of final energy is spent on cooling [1]. Buildings make a considerable environmental impact and contribute with over 30% to the global carbon footprint, with prediction to grow in the future. There is a significant potential for current conditions improving by reducing environmental impact of building materials. It is, therefore, necessary to promote use of best techniques available and innovative solutions in the production processes, in order to reduce the depletion of the natural, finite resources [2]. Consequently, one of the future challenges is energy efficient construction, and new ecological insulation materials based on natural organic materials. Also, the intensive growth of world population and the lack of raw materials for building materials production, comfort the return to the almost forgotten natural fibres [3].

Thermal insulations are materials or combinations of materials which retard flow of heat energy. Imperative for these materials are functions to conserve energy by reducing heat losses or gains, control surface temperatures, prevent vapour flow and water condensation on cold surfaces, and of HVAC systems.



During development and quality control, the extent to which thermal insulation materials fulfil their performance expectations is continuously studied. Some questions include the following: how a particular insulating material is performing, what is the heating/cooling load of a building, how this changes with the outside conditions (weather) and how it can be improved. The main objective of this paper is to assess the possibilities of using ecoremediation *Miscanthus Giganteus* biomass for production of building insulation.

Some types of plants during the growth on contaminated soil absorb and accumulate organic or inorganic pollutants from soil in their roots or rhizomes. After that they can be harvested and used for other purpose, for example as insulating material with adequate thermomechanical properties. The utilization of lignocellulose-based *Miscanthus Giganteus* steams for insulation is expected to be particularly beneficial in the Republic of Serbia and Balkan region.

### POSSIBLE ECOREMEDIATION BIOMASS FOR INSULATION

Plant biomass is mostly lignocellulose-based material, made from long linear chains of cellulose that create hydrogen bonds with neighbouring chains, which causes weak interactions with water. Thermal insulation materials based on cellulose are made of conifers and deciduous trees, other fibrous materials, as well as the use of recycled and waste material (75-85% is recycled paper), by adding: 15% boron salt for better anti-fire properties, insecticides and fungicides [3]. Cellulose insulation is easily recycled, and might be re-incorporated into the building structure. These materials usually have a B2 flammability class – the group of normal combustible materials [3].

Evaluations of the possibilities of ecoremediation biomass implementation as an insulating material should include:

- a) Selection of remediation soil (e.g. coal overburden dams and ash disposals) and the determination of soil agrochemical properties;
- b) Selection and analysis of suitable biomass based on its physical, chemical and toxicological characteristics;
- c) Monitoring of phytoremediation effects;
- d) Biomass transport and transport of possibly contaminated materials after remediation (e.g. plant's root or leaf) and its analysis, especially of heavy metals;
- e) Experimental testing of physico-chemical characteristics of biomass after remediation;
- f) Experimental verification of biomass characteristics after its decontamination;
- g) The available treatment processes of biomass for further use (insulation building material or fuel – pelleting or briquetting);
- h) In case of use as a building material the essential analyses are thermomechanical analyses (thermal conductivity, thermal diffusivity, specific heat, heat transfer coefficient and thermal resistance), along with overview of mechanical properties as durability, strength at a pressure and inflexion and other analyses such as water absorption, flammability as well as determination of volatile compounds and combustion products due to fire.



### Thermomechanical Features

*Miscanthus Giganteus* insulation might be produced in various shapes – as panels, loose-fill or composites. These materials' thermomechanical properties have to be examined. Insulation properties are defined not only by physical parameters but also by structural parameters.

First of all it is necessary to determine the *thermal conductivity* ( $\lambda$ ) of material. Thermal conductivity is a thermophysical characteristic of a material defined as amount of heat ( $Q$ ), which is transmitted through a substance during time ( $t$ ) at distance ( $L$ ) in direction normal to the area ( $S$ ), due to temperature differences ( $\Delta T$ ) in stationary conditions, when the heat transfer is caused only by the temperature difference:

$$\lambda = Q / t \cdot L / (S \Delta T) \text{ [W/(mK)]} \quad (1)$$

The thermal conductivity is not constant – it changes with material's temperature, pressure, moisture content, density, etc. In the case of the fibrous biomaterials used for the purposes of thermal insulation, the overall or resulting thermal conductivity of a layer of certain complex material, is determined as the sum of the solid state thermal conductivity, the gas thermal conductivity, the radiation thermal conductivity, the convection thermal conductivity, the leakage thermal conductivity, as well as the thermal conductivity accounting for second order effects between the various thermal conductivities, should be considered [4].

Perforated and friable insulation materials, such as fibrous materials, have many cavities filled with air (sometimes in mixture with other gas or vapour). Hence, the thermal conductivity usually decreases by increasing the air that fills free volumes. It is also lower if the cavities are smaller, due to the prohibited gas circulation inside the material and convective heat transfer.

Another heat transfer concept important to understand the physicality of heat transfer in the insulation materials is the *thermal resistance*. It depicts the temperature change across material's layer under the heat flow conditions. If the temperature of surface changes under some external cause, for example a sudden change of outside temperature, sun load or wind, the heat conduction through the observed wall will start to be transient (due to the boundary condition change), and will reach the stationary conditions only after certain time period.

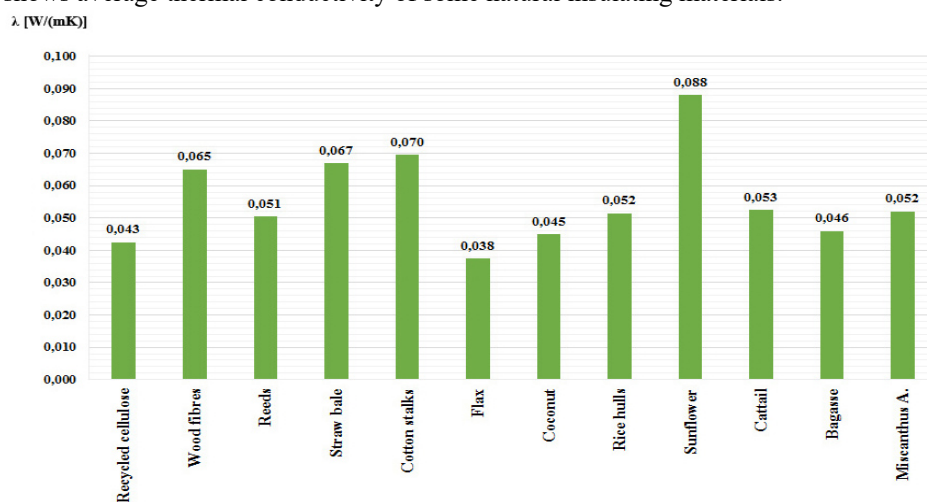
The physical property important for transient heat conduction through the insulation material is the *thermal mass*. It is a property of the wall's material which enables it to store heat, providing "inertia" against temperature fluctuations. Higher heat capacity and density insulation material would contribute better to the thermal mass of the wall it is applied on.

### UTILIZATION OF *MISCANTHUS GIGANTEUS* STEMS

The possible cellulose-based insulating materials are recycled cellulose, wood or wood by-products, reeds, straw, cotton, flax, coconut, rice hulls, sunflower, cattail, etc. [3,5].

*Miscanthus Giganteus* (China reed) is a hybrid perennial tall woody grass, mainly consists of lignin, cellulose and hemicellulose. *Miscanthus Giganteus* planting is suitable on soils appropriate for all cereals plants. In addition to soil quality, yield and growth depend the most on the amount of rainfall [6]. Exploitation of *Miscanthus Giganteus* takes about 20 years, with harvesting each year. Maximal yields are obtained in the period of 3 – 17 years. If it was grown on contaminated soil, for the purpose of ecoremediation, nearly the entire amount of absorbed pollutants is retained in underground organs (rhizomes and roots) [7-9].

The capacity of *Miscanthus Giganteus* products usage as insulating materials could be expected based on the thermophysical data of similar materials. Figure 1. shows average thermal conductivity of some natural insulating materials.



**Figure 1.** Average thermal conductivity of natural insulating materials [W/(mK)] [3,5,10]

Average thermal conductivity value of *Miscanthus Giganteus* insulating products is depending on utilized physico-mechanical and structural parameters, as well as supplementary materials. The expected average thermal conductivity value of *Miscanthus Giganteus* insulating panels is in the range of 0,038 to 0,090 W/(mK). This value is predicted to be similar to the average values for alike natural fibres with large amount of cellulose (e.g. reed, *Miscanthus A.*, recycled cellulose), which is in range of 0,043 to 0,052 W/(mK).

Expected thermal conductivity values for composite material, the "bio-concrete" should be higher, within the limits allowed for constructive insulating materials regarding its components (grinded brick, limestone and gypsum), which would increase overall thermal conductivity due to their own higher thermal conductivity.

Non-constructive insulating materials' thermal conductivity is considered to be less than 0,060 W/(mK) and for constructive insulating materials in range 0,060 – 0,300 W/(mK).

### ***Miscanthus Giganteus* Case Studies**

*Miscanthus Giganteus* might be used for production of panels, loose-fill or composites, such as "bio-concrete". Production and examination of these biomaterials would vary according to their type. Procedure will depend on shape and length of the fibres, compaction, i.e. density of material, additional materials (e.g. type of aggregates, their shape and size or applied binders) as well as of used spreads.

For example, a cottage with roof and walls built in *Miscanthus Giganteus* panels (Fig. 2.) is under construction at the Faculty of applied ecology.



**Figure 2.** Cottage built with *Miscanthus Giganteus* panels

Reed's stems might be primarily used for production of wall's and roof's insulation. Dry stems after cleaning are compressed and knitted with the wire of different thicknesses, forming the panels of any required length and width, in various thicknesses. Reed's insulation panels might be cut to any size or produced in specific dimensions [11].

They could be fixed easily to the building constructive elements. In order of reinforcement, panels may be overlaid by cement, clay or mortar due to good adhesion with these binders, i.e. composites.

The underway project is the creation of "bio-concrete", the type of light-weight low-cost concrete, with increased thermal resistance values compared to the standard concrete. The "bio-concrete" pilot blocks made at the experimental field of the Faculty of applied ecology are shown in Figure 3.



**Figure 3.** Pilot panels – *Miscanthus Giganteus* "bio-concrete"

This is the development of innovative, "eco-friendly" building materials based on green-building principles with the use of biomass, reuse of construction waste, e.g. grinded brick waste and natural binding materials such as hydraulic lime and gypsum. Natural aggregates (gravel, stone and sand) are substituted with fragments of biomass and grinded construction or demolition waste, which minimize the exploitation of natural resources, energy consumption and the greenhouse gases emissions.

For the purpose of "bio-concrete" production from *Miscanthus Giganteus*, its stems have to be smashed into small pieces (particles) of 5 to 30mm and further mixed with brick aggregates and binders [12]. Manufacturing process is short, has less CO<sub>2</sub> emissions with a minimum energy consumption, requiring the lower energy consumption with regard to production of mineral wool or some synthetic organic (polymer) insulation [3]. Due to the morphological structure and high presence of silicon, a piece of stem provides a continuous process of micro-condensation and vapour evaporation. The natural fibre has a certain level of self-thermoregulation, difficult to achieve with synthetic materials. Hydraulic lime, as binder, stabilizes *Miscanthus Giganteus* by creating a mineralized membrane, protecting it from decay, flammability or attacks by insects and rodents [13].

"Bio-concrete" blocks could not be considered as a common insulation material, with respect to higher thermal conductivity value, but could significantly contribute to energy efficiency requirements.

### CONCLUSION

The potential reuse of biomaterials from ecoremediation biomass, with a special focus on *Miscanthus Giganteus* have been observed. Previous studies have shown that *Miscanthus Giganteus* grows effectively in Serbian climate region, it is easy to breed and maintain, and performs as an efficient remediation media of polluted soils.

In addition, it is cost-effective and could be partly used as a combustion fuel due to the high energy value.

The significant advantage is based on *Miscanthus Giganteus* possible reuse after ecoremediation process for the production of thermal insulation. Generally, the production of insulation from plants already used in ecoremediation processes is a very important sustainability issue and meets so-called 3R criteria: reduce, recycle and renew. Furthermore, insulating materials from *Miscanthus Giganteus* are anticipated to demonstrate satisfactory insulation properties, due to *Miscanthus Giganteus* great similarities with related cellulose-based plants, and thus to contribute to the energy efficiency principles and sustainable development.

Further research is planned in order to determine thermomechanical and other mentioned properties of *Miscanthus Giganteus* insulating materials and the possibility of combining (hybridization) with conventional or recycled (wasted) materials, e.g. fly ash, with the aim to improve certain properties by newly synthesized materials.

#### **Acknowledgements**

*This study was supported by the Ministry of Education and Science of the Republic of Serbia, grant No. TR 31078.*

#### **REFERENCES**

1. Perez-Lombard, L., Ortiz, J., Pout, C., A review on buildings energy consumption information, 394-398, *Energy and Buildings* 40, 2008
2. Giama, E., Papadopoulos, A.M., Assessment tools for the environmental evaluation of concrete, plaster and brick elements production, 1-11, *J. Clean. Prod.*, 2015
3. Pfundstein, M., Gellert, R., Spitzner, M., Rudolphi, A., *Insulating Materials – Principles, Materials, Applications*, Aumüller Druck Regensburg, 2008
4. Jelle, B., Gustavsen, A., Baetens, R., *The High Performance Thermal Building Insulation Materials and Solutions of Tomorrow*, SINTEF Building and Infrastructure, 1-67, Department of Materials and Structures, Trondheim, Norway, ASHRAE, 2010
5. Asdrubali F., D'Alessandro F., Schiavoni S., A review of unconventional sustainable building insulation materials, 1-17, *Sustainable Materials and Technologies* 4, 2015
6. Group of authors: External and internal factors influencing the growth and biomass production of short rotation woods genus *Salix* and perennial grass *Miscanthus*, Eds.: Jureková Z., Drazic G., pp 176, Publisher: Faculty of Applied Ecology – Futura, Singidunum University Belgrade, 2011
7. Milovanovic J., Drazic G., Ikanovic J., Jurekova Z., Rajkovic S., Sustainable production of biomass through *Miscanthus giganteus* plantation development, 79-82, *Annals of Faculty Engineering Hunedoara International Journal of Engineering* 10 (1), 2012

8. Drazic G., Arandjelovic M., Milovanovic J., Jureková Z., Marisová E., Potentials For Agro-Energy Crops Production: Example Of *Miscanthus* Cultivation In Serbia, 29–36, Acta Regionalia et Environmentalica 2, 2015
9. Dzeletovic Z., Drazic G., Blagojevic S., Mihailovic N., Specific agro-technical conditions of growing *Miscanthus x Giganteus*, 107-115, Agrocultural Technic 31, 2006
10. Nagl K., Barbu M., Schnabel T., Petutschnigg A., Jäger A., Huber H., Use of annual and perennial plants for dimensionally stable insulation panels, 181-186, ProLigno, 2015
11. Köbbing J., Thevs N., Zerbe S., The utilisation of reed (*Phragmites australis*): a review, 1-14, Mires and Peat, Volume 13, 2013
12. Caslin B., Finnan J., Easson L., *Miscanthus* Best Practice Guidelines, Teagasc – The Irish Agriculture and Food Development Authority, 2010
13. Dzeletovic Z., Mihailovic N., Glamoclija Dj., Drazic G., Djordjevic S., Milovanovic M. Harvest And Storage *Miscanthus x giganteus* Greef et Deu., 9-16, Agricultural Technology No. 3, 2009



## RENEWABLE ENERGY SOURCES IMPACTS ON ENVIRONMENT

Bojan Stojcetovic<sup>1</sup>, Z. Sarkocevic<sup>1</sup>, M. Mistic<sup>1</sup>, M. Jovanovic<sup>2</sup>

<sup>1</sup>High technical school of profesional education, Zvecan, SERBIA

<sup>2</sup>RMHK Trepca, Kosovska Mitrovica, SERBIA

### ABSTRACT

Development of any modern economy requests large quantity of energy. The largest part of the required energy is obtained using fossil fuels, which contributes to environmental pollution. However, energy production can be performed by using renewable energy sources. In this case, the impact on the environment would be negligible or lower than in the case of fossil fuels. But, RES have certain impacts on the environment too. In paper that follows some impacts of renewable energy sources on environment are presented.

**Key words:** renewable energy, hydro, wind, solar, biomass.

### INTRODUCTION

Renewable energy sources (RES) can be defined as sustainable resources available over the long term at a reasonable cost that can be used without negative effects [1] [2]. Today, renewables are seen not only as sources of energy, but also as tools to address many other pressing needs, including: improving energy security; reducing the health and environmental impacts associated with fossil and nuclear energy; mitigating greenhouse gas emissions; improving educational opportunities; creating jobs; reducing poverty; and increasing gender equality [3].

Development of any modern economy is inconceivable without energy. However, it has its price. Every energy generation and transmission method affects the environment. As it is obvious conventional generating options can damage air, climate, water, land and wildlife, landscape, as well as raise the levels of harmful radiation [4].

Many scientific studies reveal that overall CO<sub>2</sub> levels have increased 31% in the past 200 years, 20 Gt of Carbon added to environment since 1800 only due to deforestation and the concentration of methane gas which is responsible for ozone layer depletion has more than doubled since then [5]. The global mean surface temperature has increased by 0.4–0.8° C in the last century above the baseline of 14° C. Increasing global temperature ultimately increases global mean sea levels at an average annual rate of 1–2 mm over the last century. Arctic sea ice thinned by 40% and decreased in extent by 10–15% in summer since the 1950s [6].



**Table 1.** Life cycle emissions from various energy sources [7].

Energy Sources	Green-house gas emission		
	CO <sub>2</sub>	SO <sub>2</sub>	NO <sub>x</sub>
	g/kWh	g/kWh	g/kWh
Coal (best practice)	955	11.8	4.3
Coal (NO <sub>x</sub> ) and FGD	987	1.5	2.9
Oil (best practice)	818	14.2	4.0
Natural gas (CCGT)	430	–	0.5
Diesel	772	1.6	12.3
Small hydro	9	0.03	0.07
Large hydro	3.6–11.6	0.009–0.024	0.003–0.006
Wind	7–9	0.02–0.09	0.02–0.06
Solar photovoltaic	98–167	0.2–0.34	0.18–0.30
Solar thermal electric	26–38	0.13–0.27	0.06–0.13
Energy crops – current practice	17–27	0.07–0.16	1.1–2.5
(likely to improve to)	(15–18)	(0.06–0.08)	(0.35–0.51)
Geothermal	7–9	0.02	0.28

Environmental aspects and quality of life indicate that environmental pollution (of air, water, etc.) is largely linked to the increasing use of energy, presently the climate changes due to heavy use of fossil fuel with emissions of sulphur dioxide, nitrogen oxide and carbon dioxide become more and more a planetary problem and will influence in the future [7].

Renewable energy sources that meet domestic energy requirements have the potential to provide energy services with zero or almost zero emissions of both air pollutants and greenhouse gases [5]. However, RES also can have some impacts on environment. In text that follows we described some of most often mentioned RES impacts on environment.

## RENEWABLE ENERGY IMPACTS

### Wind power plants impacts

Environmental and human impacts of wind power plants that is often mentioned in literature are: [8].

**Birds and bats death** - Wind turbines cause fatalities of birds and bats through collision, most likely with the turbine blades. Species differ in their vulnerability to collision. The probability of fatality is most likely a function of abundance, local concentrations, and the behavioral characteristics of species [8]. Some species, such as bats, face additional risks from the rapid reduction in air pressure near turbine blades, which can cause internal hemorrhaging [9]. However, Klugmann-Radziemska [10] stated: fossil-fueled facilities are about 17 times more dangerous to birds on a per GWh basis than wind and nuclear power stations.

**Noise** - Wind turbines produce noise that can be classified into the following categories [8]:



1. *Mechanical noise* which is produced from the motor or gearbox; if functioning correctly, mechanical noise from modern wind turbines should not be an issue. Mechanical sources of noise include the gearbox, cooling fans, the generator, the power converter, hydraulic pumps, the yaw motor and bearings.

2. *Aerodynamic noise* which is produced by wind passing over the blade of the wind turbine. The level of aerodynamic noise is highly correlated with the tip speed. The noise limit for wind farms is 35 A-weighted decibels, which is usually around 5 A-weighted decibels above a quiet countryside. Alternatively, the limit is 5 A-weighted decibels above the level of background noise (i.e. without wind farm noise), if that is greater than 35 A-weighted decibels [11].

**Shadow flicker** – Shadow flicker occurs when the sun is located behind a wind turbine casting a shadow that appears to flick on and off as the wind turbine blades rotate [8]. Shadow flicker can be a nuisance to nearby humans, and its effects need to be considered during the design of a wind-energy project. However, this can easily be avoided by locating the wind farm to avoid unacceptable shadow flicker, or turning the turbine off for the few minutes of the day when the sun is at the angle that causes flicker.

**Aesthetic impacts** - Wind-energy facilities often are highly visible. For some people, wind turbines are visually pleasing, while others view them as intrusive industrial machines which distort natural landscape. If we take into account the size (for example GE 1.5-megawatt model, for example, consists of 35 m blades a top a 64 m tower for a total height of 100 m) of the turbine aesthetic problems are some what logical. Aesthetic impacts is probably present because wind turbine are innovation and some time is necessary to be accepted as normal part of landscapes [8].

**Impacts on historic, sacred, and archeological sites** - Impacts (removal or physical harm) to historic, sacred, or archeological sites can be easily avoided in most instances by site investigation before power plant will be built. Wind turbines may also distort the impression of historic early age origin which can be linked with the aesthetic impact. On the other hand it can lure many tourists to visit specific area because of the wind turbines [8].

**Electromagnetic interference** - Electromagnetic interference (EMI) from wind turbines may affect electromagnetic, radio communication signals including broadcast radio and television, mobile phones and radar [13]. Care must be taken to ensure that wind turbines do not passively interfere with telecommunications installations, radio and television masts, mobile phone base stations and similar facilities by directly obstructing, reflecting or refracting their radio frequency EMR signals [8].

### **Solar power plant impacts**

Solar power plants are energy facilities for production electricity from solar energy potential. They work on the principle of photovoltaic effect, whereby the influence of solar radiation in solar cells generate DC voltage and current [12].

Solar energy technologies are divided into two broad groups namely: solar photovoltaic and solar-thermal.

Photovoltaic (PV) systems do not emit greenhouse gases in electricity generation. PV systems that is roof installed have a minimal impact on the environment

and landscape. PV cell technologies have relatively lower environmental risks compared to other types of electric sources. However, chemicals used in PV cells could be released to air, surface water, and groundwater in the manufacturing facility, the installation site, and the disposal or recycling facility [14].

Solar thermal power plants occupy a large area and the impacts on land and wild-life are similar to those of PV systems. These power plants are built for high power and they greatly reduce CO<sub>2</sub> emissions [15]. Unlike PV systems, large volume of water is required for cooling or as a working fluid, or for washing reflective surfaces which affects water quality [15].

### **Hydro power plant impacts**

Hydroelectric power plants are plants used for electricity production from water power. This means that it uses the conversion of potential and kinetic energy of water into electricity.

The principal advantage of using hydropower are its large renewable domestic resource base, the absence of polluting emissions during operations, its capacity in some cases to respond quickly to utility load demands and its very low operation costs.

There are some potential negative impacts of hydro power plants (HPP) on environment. Operation of large HPPs require construction of dams which prevent free movement of fish. However, this problem can be solved by construction of fish passages. Also, hydropower often entails changes to the natural variations in the water in a watercourse. There is HPPs potential for flooding. It can cause land destruction and displacement of people from flooded areas. The environmental impact of reservoir hydroelectric projects is significantly greater than run-of-river, as land, which is often forested, is flooded, displacing both humans and wildlife.

Negative impact of dams are as follows: in flat basins large dams cause flooding of large tracts of land, destroying local animals and habitats; people have to be displaced causing change in life style and customs -about 40 to 80 million people have been displaced physically by dams worldwide; large amounts of plant life are submerged and decay anaerobically; the migratory pattern of river animals like salmon and trout are affected; dams restrict sediments that are responsible for the fertile lands downstream; salt water intrusion into the deltas means that the saline water cannot be used for irrigation; large dams are breeding grounds for mosquitoes and cause the spread of disease; dams serve as a heat sink, and the water is hotter than the normal river water - this warm water when released into the river downstream can affect animal life [16].

### **Biomass power plant impacts**

Biomass power plants are based on the same principle as conventional power plants. Biomass power plants have direct emissions of greenhouse gases. Biomass power plants, like coal and natural gas-fired power plants, require water for cooling. There are global warming emissions associated with growing and harvesting biomass

feedstock, transporting feedstock to the power plant, and burning or gasifying the feedstock [10].

One reason this source is frequently promoted is that much of the CO<sub>2</sub> emitted from its combustion, is offset by the CO<sub>2</sub> absorbed by the plant during its life cycle to produce biomass [17]. However, studies have shown that the carbon sequestration capability of a mature tree, for example, is much greater than that of the resulting cleared area. In addition, the relatively instantaneous release of carbon stored in wood biomass has a significantly larger impact on global warming than the gradual decomposition process that would occur in a forest [18]. The chemical composition of biomass is also low in sulphur, resulting in lowered SO<sub>2</sub> emissions over those of fossil fuels [17].

## CONCLUSION

The most important conclusions are:

- demand for energy in modern society is growing,
- production of energy from fossil fuels in large extent affects the environment,
- the share of renewable energy in the energy production should be increased.
- energy production from renewable energy sources also affect the environment but it is negligible or much smaller than the conventional ways of producing energy.

## REFERENCES

1. Charters, W.W.S., Developing markets for renewable energy technologies, *Renewable Energy* 22, 217–222 (2001).
2. Dincer, I., Environmental impacts of energy, *Energy Policy* 27, 845–854 (1999).
3. REN21. 2014. Renewables 2014 Global Status Report (Paris: REN21 Secretariat). ISBN 978-3-9815934-2-6
4. Tsoutsos, T., Frantzeskaki, N., Gekas, V., Environmental impacts from the solar energy technologies, *Energy Policy* 33, 289–296 (2005).
5. Panwara, N.L., Kaushik, S.C., Kothari, S., Role of renewable energy sources in environmental protection: A review, *Renewable and Sustainable Energy Reviews* 15, 1513–1524, (2011).
6. Sims REH. Renewable energy: a response to climate change, *Solar Energy*, 76:9–17, (2004).
7. Akella, A.K., Saini, R.P., Sharma, M.P., Social, economical and environmental impacts of renewable energy systems, *Renewable Energy* 34, 390–396, (2009).
8. Stojčetović B., Velinov V., (2014) *Impact of wind power plants on the environment, humans and economic development*, The 46<sup>th</sup> International October Conference on Mining and Metallurgy.

9. Baerwald, E.F., D'Amours, G.; Klug B, Barclay R; Barotrauma is a significant cause of bat fatalities at wind turbines. *Current Biology*, 18(16): 695-696, (2008)
10. Klugmann-Radziemska, E., Environmental Impacts of Renewable Energy Technologies, 2014 5th International Conference on Environmental Science and Technology IPCBEE vol.69 (2014) © (2014) IACSIT Press, Singapore DOI: 10.7763/IPCBEE.2014.V69.21
11. The wind energy fact sheet, *Department of Environment, Climate Change and Water NSW*. 2010.
12. Stojčetočić B., Šarkoćević T., Mišić M.: „Potential of renewable energy sources in Serbia”, Međunarodno Savetovanje Energetika 2014, Energija (Energija, ekonomija, ekologija), (ISSN 0354-8651), Publisher: Savez energetičara,16,(1-2),392-397, (2014).
13. Environment Protection and Heritage Council (EPHC), National Wind Farm Development Guidelines – Public Consultation Draft. Commonwealth of Australia, Adelaide, (2009).
14. Klugmann-Radziemska E., Environmental impact of photovoltaic technologies; *Low Carbon Earth Summit “ Leading the Green Economy, Returning to Harmony with Nature”* Dalian, China, October 19-26, (2011).
15. Vezmar, S., Spajić, A., Topić, D., Šljivac, D., Jozsa, L., Positive and Negative Impacts of Renewable Energy Sources, *International Journal of Electrical and Computer Engineering Systems*, 5 (2), 15-23, (2014)
16. Sanguri M; Negative Impacts of Hydroelectric Dams, *Bright Hub Engineering* 2013.
17. Kruger, P. (2006). *Alternative Energy Resources: The Quest for Sustainable Energy*. Hoboken, John Wiley and Sons.
18. Johnson, E., Goodbye to carbon neutral: Getting biomass footprints right, *Environmental Impact Assessment Review* 29: 165-168, (2009).



## ECO-DRIVING AS MEASURE OF INCREASE ENERGY EFFICIENCY IN ROAD TRANSPORTATION

Bozidar Rancic<sup>1\*</sup>, N. Rancic<sup>2,3</sup>, S. Otasevic<sup>2,3</sup>, B. Kocic<sup>2,3</sup>, B. Petrovic<sup>2,3</sup>, M. Ilic<sup>2,3</sup>

<sup>1</sup>MBR Press, Nis, SERBIA

<sup>2</sup>University of Nis, Faculty of medicine, Nis, SERBIA

<sup>3</sup>Institute for public health Nis, Nis, SERBIA

\**mbrpress@medianis.net*

### ABSTRACT

Eco-driving is the operation of a vehicle in a manner that minimises fuel consumption and emissions. It includes: optimising gear changing, avoiding vehicle idling, e.g. by turning the engine off when the vehicle is stationary, avoiding rapid acceleration and deceleration, driving at efficient speeds. The most efficient speed for most cars is between 60 km/h and 90 km/h. Reducing weight by removing unnecessary items from the car, and reducing wind resistance by removing roof attachments such as ski racks. A significant advantage is that it can be implemented with drivers of both new and old passenger cars, as well as those of all sizes of commercial vehicles.

**Key words:** eco-driving, energy efficacy, road transportation.

### INTRODUCTION

The transport sector is a huge consumer of energy (accounting for 19% of global final energy consumption in 2007) and will account for 97% of the increase in world primary oil use between 2007 and 2030 (1). The consequent energy security and greenhouse gas emission implications of oil-dominated road transportation mean that reducing the fuel used in this sector is one of the highest priorities for all countries.

In view of this, it is important to note the relevance of the road transport energy paradigm, which can be split into three main parameters:  $E_{road\ transport} = (vehicle\ fuel\ efficiency) \times (vehicle\ travel) \times (the\ vehicle\ population)$  where the vehicle fuel efficiency is determined by the technical energy efficiency; vehicle travel denotes the type of travel/driving and the number of miles driven; and the vehicle population is the number of vehicles on the road (2).

Road transport (passenger cars and freight trucks), in particular, will continue to dominate overall transport energy and oil use, accounting for nearly 80% of demand in 2050.

There are no simple policy measures to resolve the challenges associated with energy use in the transport sector. The The International Energy Agency (IEA) four transport recommendations mainly focus on vehicle and tyre efficiency and do not address driver behaviour (aside from the recommendations on eco-driving) or travel demand.

Eco-driving has been shown to reduce fuel consumption and CO<sup>2</sup> emissions by up to 20% for some drivers and by 10% for all drivers long term. Most countries now have programmes of eco-driving, either at national or sub-national level, with varying levels of success. Programmes can be supported with technical aids such as in-car feedback instruments. The European Union has mandated the fitting of Gear Shift Indicators (GSI) in all new cars from 2012. Eco-driving is implemented at member state level and countries have different programmes.

In Japan, eco-driving is promoted through campaigns orchestrated by several ministries and manufacturers generally offer feedback instruments even though they are not required to do so. In 2009 more than 70% of new cars contained such instruments. In the United States, there are several programmes at state level that are supported by the auto industry association (1).

Eco-driving is gaining widespread recognition as a low cost method of reducing vehicle fuel consumption without the need for vehicle technology improvements. A significant advantage is that it can be implemented with drivers of both new and old passenger cars, as well as those of all sizes of commercial vehicles. However, regular updates through information campaigns and driver training are needed in order to ensure long-term savings. In-car feedback instruments would support this.

Improvements in driving techniques, or eco-driving, can significantly improve on-road fuel efficiency and CO<sup>2</sup> emissions. This can also contribute to better safety, and reduced noise and stress. In some countries, eco-driving training is an important part of road safety programmes. Eco-driving is the operation of a vehicle in a manner that minimises fuel consumption and emissions. It includes: optimising gear changing, avoiding vehicle idling, e.g. by turning the engine off when the vehicle is stationary, avoiding rapid acceleration and deceleration, driving at efficient speeds. The most efficient speed for most cars is between 60 km/h and 90 km/h. Above 120 km/h, fuel efficiency falls significantly in most vehicles. Reducing weight by removing unnecessary items from the car, and reducing wind resistance by removing roof attachments such as ski racks. Used together, these steps could save up to 20% of the fuel used by some drivers and possibly 5% to 10% on average across all drivers on a lasting basis.

Under European Union regulations, it is compulsory to teach eco-driving to novice drivers. The implementation of eco-driving training, as a part of the driving license education and examination, can improve fuel economy. Many countries have implemented eco-driving through national and regional eco-driving programmes; these will not be described individually here (3).

Eco-driving has been in place in Japan since 2003. For passenger cars, automobile manufacturers offer in-car feedback instruments for eco-driving on a voluntary basis. In 2009, more than 70% of new cars had such instruments. Although ecodriving remains a voluntary, non-mandatory, measure in Japan, some positive results have been achieved nonetheless.

Since April 2010, progress has been made in eco-driving in Korea and the government is developing the law and budget for promoting eco-driving guidance equipment. The Ministry of Knowledge Economy has developed a plan to encourage eco-driving equipment, such as onboard indicators of fuel efficiency, and in 2011 will provide fiscal support to target fleet operators, such as bus and taxi companies (1).

In New Zealand, The Ministry of Transport announced implementation of the Safe and Fuel Efficient Driving New Zealand (SAFED NZ, 2010) eco-driving programme in July 2010. This programme is primarily directed at commercial fleet drivers to provide benefits such as: increased fuel savings and lower costs for fleet operators; • reduced reliance on imported fossil fuel; • improved road safety; • increased economic productivity; • improved workforce skills. Throughout the pilot trial programme, one company made fuel savings of 17.8% and halved the number of safety incidents over a three-year period (4).

In November 2007, the IEA, in cooperation with the International Transport Forum, held a workshop to review current experiences around the world in implementing and promoting eco-driving (5).

The workshop reviewed certain initiatives (Table 1).

**Table 1.** Eco-driving programmes and targeted improvements in different countries or projects

Country	Method	Short-term	Mid-term
Netherlands	National programme	10-20%	10-20%
Austria	National programme	10-15%	5-10%
Japan	Smart driving contest	25%	
Japan	Idle stop driving	10%	
Japan	Eco-drive workshop	12%	
Japan	Average mileage workshop	26%	
Sweden	Driver training courses	5-15%	
Austria	ÖBB Post Bus Best Practice training courses, competition, monitoring, feedback	10%	
Austria	Eco-driving competitions for licensed drivers	30-50%	
Austria	Mobility management for company fleets	10-15%	
Deutsche Bahn	Training courses, monitoring, feedback, rewards	3-5%	
Shell		5-20%	
Ford	Training courses and trip/driving style analysis	25% 10% 15%	
FIA – AASA (South Africa)		14%	
FIA – Plan Azul (Spain)		25%	
FIA – ADAC (Germany)		6%	
FIA – öAMTC (Austria)		12-16%	
FIA – JAF (Japan)		18%	
Nissan			4%
UK – Lane Group			9%
UK – Walkers			

Source: IEA (2007)

Presentations at the IEA workshop quantified the impact of individual schemes on both a shortterm (less than three years) and medium-term (more than three years) basis. Immediately after eco-driving training, average fuel economy improvements of between 5% and 15% were recorded for cars, buses and trucks. Over the medium term, fuel savings of around 5% were sustained where there was no support beyond the initial training or around 10% where further feedback was available.

Given the potential for very large fuel savings, some eco-driving initiatives are also operating without the help of government measures. Fleet operators are incentivised by cost savings to take action themselves, and eco-driving initiatives can be shown to support wider claims to responsible or sustainable entrepreneurship. Even though the up-front costs of encouraging and tracking eco-driving schemes tend to be more visible than the long-run savings, there is potential for many more fleet operators and drivers to introduce eco-driving (4).

Of the four IEA transport energy efficiency recommendations, eco-driving was the policy measure implemented most widely, by 46% of IEA countries, in 2009. This is not surprising since cost-effectiveness studies of CO<sup>2</sup> emissions abatement repeatedly show eco-driving to have negative costs.

It is surprising that there is not a 100% implementation of this initiative. The fact that this policy is not implemented in all countries most likely reflects the public good nature of this activity since the agent paying for the training (normally the government) does not directly recoup the benefits. Another reason is that eco-driving has a smaller profile as a policy initiative compared with say, an announcement of exciting new technologies. However, since March 2009 there has been further progress in introducing eco-driving policies so that 89% of IEA member countries now have eco-driving in the category of "implementation underway" (1,2).

## **CONCLUSION**

The new policy measures that will be, or already are, implemented should result in significant energy savings compared with energy consumption today. In those countries where the policy measures are fully implemented or implementation is underway, energy savings of between 41% to 67%. There remain several IEA member countries, in particular those outside the main vehicle manufacturing regions, that have implemented very few of the four IEA transport energy efficiency recommendations.

## **REFERENCES**

1. Kazunori Kojima and Lisa Ryan. Transport Energy Efficiency Implementation of IEA Recommendations since 2009 and next steps. 2010. International Energy Agency.
2. Banerjee, A. and B.D. Solomon (2003), "Eco-labeling for energy efficiency and sustainability: a meta-evaluation of U.S. programmes", *Energy Policy*, 31 p. 109-123. EU (2009b), Regulation (EC) No 1222/2009: The labelling of tyres with respect to fuel efficiency and other essential parameters, Brussels.



3. EU (European Union) (2009a), Regulation (EC) No 443/2009: Setting emission performance standards for new passenger cars as part of the Community's integrated approach to reduce CO<sub>2</sub> emissions from light-duty vehicles, Brussels. EU (2009b), Regulation (EC) No 1222/2009: The labelling of tyres with respect to fuel efficiency and other essential parameters, Brussels.
4. MLIT (2010), Jidosha Nenpi Ichiran (List of passenger cars' fuel economy) Available at [www.mlit.go.jp/jidosha/nenpi/nenpulist/nenpulist.html](http://www.mlit.go.jp/jidosha/nenpi/nenpulist/nenpulist.html).
5. IEA (2007), Workshop on eco-driving, OECD/IEA, Paris.



## MONITORING AND IMPROVEMENT ENERGY EFFICIENCY OF COMMERCIAL VEHICLE FLEET BASED ON DATA DRIVEN APPROACH

Predrag Stolic<sup>1\*533</sup>  
, S. Stolic<sup>2</sup>, A. Milosavljevic<sup>3</sup>, M. Pantovic<sup>4</sup>

<sup>1</sup>University of Belgrade, Technical faculty in Bor, Bor, SERBIA

<sup>2</sup>Bor, SERBIA

<sup>3</sup>Mining and metallurgy institute Bor, Bor, SERBIA

<sup>4</sup>University of Belgrade, ICTM-CEH, Belgrade, SERBIA

\**pstolic@tfbor.bg.ac.rs*

### ABSTRACT

Large amount of transportation nowadays are done by using trucks in short and long distance tours. Truck transport has a massive carbon footprint which must be reduced in aim to reduce impact of this kind of transportation to environment. Although there are major construction improvements related to vehicles, there are still big considerations which must be done in some efficient way. We surrounded with large amount of data which could give us better insights to problems related to energy efficiency of trucks and transportation doing by trucks. According to that in paper will be discussed a new approach to energy efficiency of commercial vehicles. This approach will be based on data driven approach.

**Key words:** Commercial transportation, Data streaming, Energy efficiency, Insight, Internet of things, Monitoring.

### INTRODUCTION

Cambridge Business English Dictionary defines commercial vehicle as "a vehicle used by a business to transport goods or people on public roads" [1]. Usually, when the term "commercial vehicle" is used, it refers to using some kind of vehicle which transport goods from one to another point regardless the distance. Commercial transportation has evolved as a necessary branch of people aim to provide better conditions for living, to be equipped with all particular goods which represents modern way of life. Nowadays, commercial transportation is essential link in trading and fluctuation of goods and services. There aren't modern logistics without commercial transportation so we can say that commercial transportation is one of the crucial parts in modern countries and their economies.

Modern transportation is mostly carried out by land (dominant type of transportation), rather than sea and air. Land transportation is realized primary by using different types of trucks, rather than using railways. There are some global efforts to

switch part of truck transport to transportation by rail, sea and inland waters. We can mention European Commission and their Marco Polo programme [2] in Europe which had great results in period 2003-2012, but still, truck transportation remains dominant.

In recent years, this domination is followed by big concerns about influence and impact which truck transport produce related to environment. This concerns reflected to energy efficiency consideration of vehicles which are using in truck transportation. Although many improvements are made in construction of engines such as improvements of EURO standards which brings more usage of power with reducing carbon footprint, construction of brakes which more efficient nowadays, there are many considerations which must be analyzed in further deployment of trucks and transportation which are done by those trucks.

In this paper will be discussed data driven approach to problems mentioned above instead traditional approaches which are based on other techniques such as model approach.

### SOME ASPECTS OF COMMERCIAL VEHICLES ENERGY EFFICIENCY

Energy losses for truck combined with trailer are presented on figure 1. This vehicle has full payload of 60 tons and in this example it is on freeway with speed of 80 kilometers per hour [3].

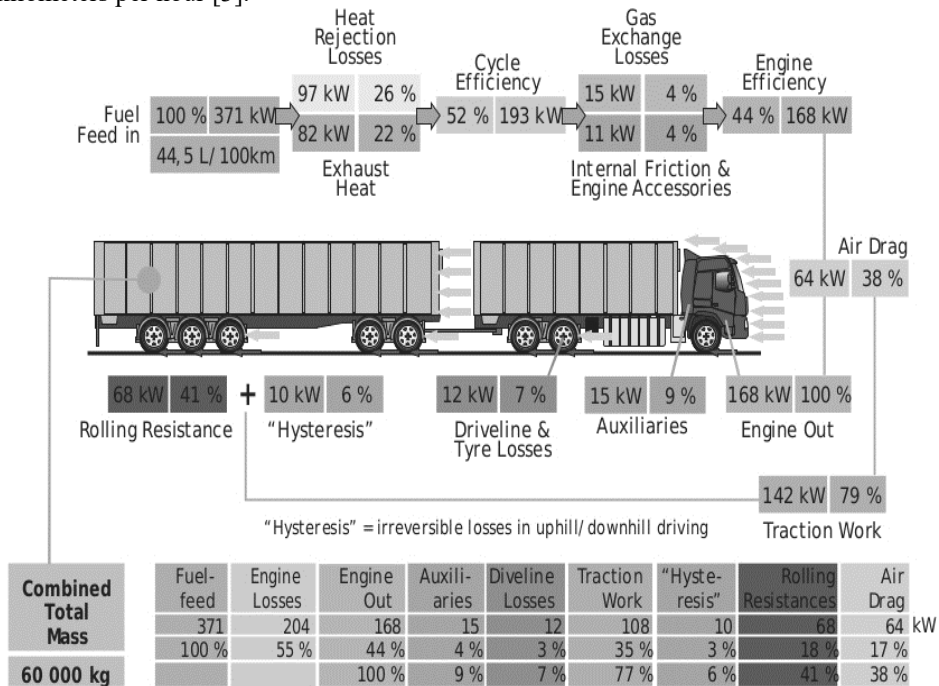


Figure 1. Some aspects of energy efficiency presented on 60 ton truck and trailer with full payload on the freeway at 80 km/h [3]

As we see in this study, which conducted by VTT Technical Research Centre of Finland, the power of the engine is 371 kW. Engine efficiency of this vehicle is below a half of the engine start power and it is about 44 percent (168 kW). Nearly 56 percent of losses are produced by heat rejection, exhaust heat, gas exchange and internal friction and engine accessories.

In some cases over one third of that power became a power needed to overcome air drag effect (sometimes there is a term wind resistance in use instead air drag). That amount of power could be vary within wide limits depends on factors such as vehicle air drag coefficient or type of the road and current weather conditions. Similarly to the previous we have significant losses produced by rolling resistance (sometimes there are terms rolling friction and rolling drag instead rolling resistance).

Losses by auxiliaries are less than ten percent but became losses which are significant to observe because that losses are directly connected to the modernization of vehicles and has a trend to grow in future years. There are increasing in number of various equipment which are embedded in modern vehicles as standard or additional kit. That increasing of equipment is manifested also as increasing of losses in major of cases. Almost same amount of losses are generated by driveline (for example energy which are lost by shifting gears) [4] and tyre losses.

Cargo which are transported by trucks made the way of uphill and downhill driving of trucks. That special way of driving produced the losses known as "hysteresis" marked as irreversible losses in uphill or downhill driving [3].

These are some of the significant losses in the truck vehicles. Of course, there are many more other particular losses, but they will not observed in this paper. Some researchers said that only about fifteen percent of the whole energy from the fuel which are using in driving are energy used for moving vehicle down the road and for run useful accessories [4].

## **CURRENT APPROACHES IN ENERGY EFFICIENCY OF COMMERCIAL VEHICLES**

There are two major approaches in energy efficiency of commercial vehicles which are currently in use, indirect and the direct one.

Indirect approach is based on two directions. First one is substitution of truck transport with other forms of transportation while the second one truck transport combine with other forms of transportation. We said that these are indirect approaches because in both ways using of trucks are reduced and limited somehow. Logically, lesser use of trucks means lesser use of fuel and reduced carbon footprint. We already mentioned Marco Polo programme above which represented combination of truck transport with transport by rail, sea or inland waterways. In first impact of Marco Polo programme (period 2003-2006), over 1,23 million 18 tons truck trips avoided with saving of 1,5 million tones CO<sub>2</sub> [5] . These numbers represented avoided truck trips which distance is more than 1000 kilometers. These trucks are transported one part of the route by specialized trains or ships.

Direct approach has no limitations for further using of trucks in transportation. On the contrary, direct approach improves vehicles in construction way, part by part.

Nowadays, engines become more eco-friendly which means lower fuel consumption and reduced CO<sub>2</sub> emissions. For example, in Europe most of the countries conducted their producing and using of commercial heavy duty vehicles with Euro VI standard which represents lower emissions of CO<sub>2</sub> for truck diesel engines [6]. A lot of researches is focused to using of hybrid engines and alternative fuels in aim to achieve bigger engine utilization with smaller impact to environment. Improvements are not related only to engines. Also, there are improvements of brake systems which are more efficient today, improvements in construction of truck tyres which are constructed to reduce fuel consumption, low energy light bulbs, efficient hydraulics [7]. Construction improvements for energy efficiency related to trucks could be done on lot of ways.

These are most common ways of thinking related to energy efficient truck transport. If we analyze these approaches we could concluded that we have these approaches presented in truck transportation in some form over decades. Although there are a lot of improvements, the problem of energy efficiency is still exists.

### **DATA DRIVEN APPROACH**

One of the key problems of energy efficiency in truck transport is idle running which could represented energy losses between twenty and thirty percent [7]. This could be prevented with modern stop/start systems which switch off engine when trucks are idle. And this systems already are incorporated to many vehicles as standard equipment.

This solution cut off energy losses, but is this the best solution to the idle running problem in domain of energy efficiency? This is raw solution based on the "turn off consumer" practice, no consumer, no energy to lose. But more efficient way is in analysis and optimization. So, we could analyze patterns and behaviors, optimize further actions and operate following procedures derived from analysis and optimization. In core of all that techniques are data, so we have approach based on using of data, or as a popular terminology refers, we have data driven approach.

Data driven approach on the example of idle running will look at the more factors than the classical stop/start system do. The most of the idle runnings are products of traffic jam or red traffic light. Let's assume that trucks could communicate with each other directly or via some kind of dispatcher centre and that trucks could interchange data between them. In that case trucks could provide to each other whole sets of information: potential traffic jams, average speed needed to avoid red traffic light, information about the fastest lane and other kinds of information. With all these streamed information and processed on right way and timely, vehicle could avoid all potential conflict situations related to idle running. According to that stop/start system became also part of data driven system as a last defense line - in situations when potential idle running could not be avoided data will informed stop/start system to be prepared to act and activate it when idle running is started.

Data driven approach enables much more benefits than other approaches. Other approaches not included drivers as the key element in realization of energy efficient driving of vehicle. By using information provided from various types of data, behavior of drivers and vehicles, which are used by those drivers, could be predicted in more efficient way. This efficiency leads to energy efficient style of driving.

Researching related to this efficiency mentioned above is conducted in company which made overnight delivery of shipments by trucks. Company had two identical vehicles which every night operated with almost identical amount of cargo at the same distance of 600 kilometers. One vehicle always finish tour with much lower fuel consumption than the other. Also, first vehicle arrives always earlier than the other. Second vehicle then checked for potential failures, but there aren't any. Next step were providing sets of data which could explain differences between two vehicles. During one working week both vehicles are monitored and large amount of data are collected which are further processed and analyzed. Some of collected data are acceleration, velocity, braking, idle running time. Also driver's data are collected and processed so the drivers could be profiling.

According to collected data after processing and analyzing, first vehicle has a constant speed about 75 kilometers per hour with small braking intervals. Also driver of the first vehicle had better organized cargo so he had uniform distribution of load. Opposite to that second vehicle had a lot of peaks in speed (maximum peaks are on 110 kilometers per hour), used much often brake with large braking intervals, so based on data conclusion was that driver drove aggressive with often braking and shifting. Distribution of load was not uniform, weight of cargo was concentrated on first half of cargo space.

Data driven approach gave us insights in behavior of drivers and their vehicles, so we could predicted further aspects of using trucks. Based on analysis some correction methods are done after the generated report. Both vehicles limited to maximum speed of 80 kilometers per hour. Also, both vehicles used trailers which are loaded previously by warehouse personnel with uniform distribution of load. Vehicles after these correction had almost same consumption of fuel and almost same time of arrival.

We could conclude that we improve second vehicle energy efficiency by using data from the first vehicle. In this particular case we had only two vehicles, but this data driven approach could be used on whole fleets with hundreds and thousands vehicles.

Data driven approach could be realized without interacting with human. Nowadays, Internet of Things achieved communication and data transfers between devices without human intervention [8]. This means that analysis could be done in real time, more accurate and faster and according to that, better decisions about energy efficiency are made. In other words automation of data collection and analysis are done on higher level.

The key benefit of data driven approach in domain of energy efficiency is ability to monitor and meter what is relevant and then extract what is needed to gain intelligence about energy consumption [9].

## **POTENTIAL BARRIERS**

There are a few aspects of data driven approach in energy efficiency of commercial vehicles that could be potential obstacle for its full implementation in everyday using in truck transport.

One of the major problems with data driven approach globally is related to legislation. There are numerous laws that treated data and using of data. Some of them

are local laws, some of them are regional and also there are international laws. All of them highlighted one common data problem and that is privacy. Sometimes it is hard to tell what data is private and what data should or should not be distributed and processed. Using various types and kinds of data could potentially made a serious and very complex law situations. For example when you made a profile of the driver in some laws it could be treated as a personal data and the processing and further usage of that kind of data could be banned even that data could revealed many potential gaps in energy efficiency of truck transport.

Second law related problem is the problem of jurisdiction. Many of truck routes are international routes so it could be a little bit confusion which law is applied on data from the aspect of point of origin, storage and processing. For example, truck belongs to company and it is registered in one country, but data is collected on the route in other state. Which country than has a jurisdiction over the data which are collected and streamed to headquarters? Unfortunately there is no unique way to interpret this problem and the point of view are different from state to state. Some states these data streamings also could treated as a forbidden activities.

In economic way, data driven approach as a relative new approach could bring cost issues. Initial investments could be potentially large amounts of money, so it could be potential barrier to implementation data driven solutions in numerous of the companies, especially for small and mid-ones. But it should be pointed out that practice of data driven solutions show tendency of ROI (Return of Investments) in very short time. In fact, data driven solutions from the business point of view represents value added solutions because the knowledge extracted from analyzed data has a big value for company in aim to consolidate economic aspects of company business processes.

We also must emphasized one common problem with data approach globally which are presented in companies worldwide and that is the fear of obtain and sharing data with second and third parties. Often companies are worried that revealing and sharing data could potentially made that other companies became more concurrent. Fear of data sharing is mostly related to potential losing market position. This is basically could be true if data are streamed in some chaotic way and without procedures and some order. But in most of the cases systems are detailed projected and tested so that possibility of revealing unwanted data and information is reduced to minimum.

## **CONCLUSION**

There are many approaches related to achieving energy efficiency within different areas. Every approach has its own benefits and strength to contribute to better use of various types of energy and to reduce carbon footprint.

We are living in era of information, we could say that today society is information society, so with no doubts we can say that the need for implementing data driven approach in all areas will grow in future years. That tendency could be expected also in area of energy efficiency. Better understanding of data, using of data in real time, predictive analysis and data visualization are key areas which are must to be considered in every future implementation of systems that treated energy efficiency problem.

If we analyze energy efficiency use in domain of commercial vehicles

transportation individually we must noticed that traditional approaches has some limits which must be considered. First at all, internal combustion engines reached their limits related to efficiency. Construction of these engines dictated that maximum of achieved efficiency is about 40-45 percent. We also have a similar situation with few other factors which are observed within truck transportation energy efficiency problem.

Data driven approach is solution which will provided overcoming most of gaps that are presented in area of energy efficiency today and in the future. Strength of data driven approach lies in fact that the number of observed factors are growing and that analysis are faster, more accurate and easier to do. Insights provides by these ways will be key values for every companies regardless the size or structure.

In the area of truck transportation data driven approach will be crucial link in better understanding every energy efficiency effort and actions that will made to reduce carbon footprint and improve energy efficiency of vehicles that are used in area of transportation.

### REFERENCES

1. Cambridge English Dictionary, Cambridge University Press, Cambridge, United Kingdom, 2016.
2. European Commission, Marco Polo Programme, 2014., [HTTP://Europa/transport/Marcelo/about/index\\_en.htm](http://Europa/transport/Marcelo/about/index_en.htm)
3. Nyland Nils-Olof, Vehicle Energy Efficiencies, VTT Technical Research Centre of Finland, Oulu, Finland, 2013.
4. Consumer Energy Center, Energy Losses in a Vehicle, California Energy Commission, State of California, Sacramento, California, USA, 2016.
5. European Commission, Marco Polo: The Results, Executive Agency for Competitiveness and Innovation (EACI), Brussels, Belgium, 2013.
6. N.L.J. Gense, Riemersma, C. Such, L. Ntziachristos, EURO VI technologies and costs of Heavy Duty vehicles, TNO, Delft, Netherlands, 2006.
7. Volvo Trucks Global, Energy efficiency, 2016., <http://www.volvotrucks.com/trucks/global/en-gb/values/environment/Our-operations/Pages/Energy-efficiency.aspx>
8. Aleksandra Milosavljević, Predrag Stolić, Danijelas Milošević, Internet of labs as a new concept in prediction and validation of results in laboratory investigations, 47<sup>th</sup> International October Conference on Mining and Metallurgy, Borsko jezero, Bor, Serbia, 2015., Conference Proceedings
9. Ethan A. Rogers, Edward Carley, Sagar Deo, Frederick Grossberg, How Information and Communications Technologies Will Change the Evaluation, Measurement, and Verification of Energy Efficiency Programs, American Council for an Energy-Efficient Economy, Washington, DC, USA, 2015.



## ESTABLISHING GAMMA IRRADIATION METHOD OF PRUNES CONSERVATION

Ivica Vujcic<sup>1\*</sup>, S. Masic<sup>1</sup>, M. Medic<sup>1</sup>, I. Vukoje<sup>1</sup>, S. Putic<sup>2</sup>, M. D. Dramicanin<sup>1</sup>

<sup>1</sup>University of Belgrade, Vinca Institute of Nuclear Sciences,  
P.O. Box 522, Belgrade 11001, SERBIA

<sup>2</sup>University of Belgrade, Faculty of Technology and Metallurgy,  
Karnegijeva 4, Belgrade, 11000, SERBIA

\*[ivicav@beotel.rs](mailto:ivicav@beotel.rs)

### ABSTRACT

Gamma irradiation is a feasible food processing technology and is used for disinfestation, decontamination, sterilization and shelf-life extension of food products. We studied effects of high-energy radiation on prunes and developed a method of prunes conservation by gamma irradiation. Results of microbiological measurements showed a significant reduction of micro-organisms in all contaminated samples after irradiation treatment. Irradiation dose of 6 kGy was sufficient to kill almost all micro-organisms prune samples. Reduction of number of micro-organisms improves the quality, microbiological safety and shelf life of prunes.

**Key words:** food, irradiation, conservation, microorganisms, microbiological safety.

### INTRODUCTION

Agricultural products are consistently associated with a high microbial load mostly from soil, atmosphere and handling. This microbial load can cause a rapid spoilage of foods (Figure 1). Furthermore, the presence of pathogenic bacteria and high levels of mycotoxins has also been extensively reported, which makes these products potential hazards for health of consumers. Also, it reduces quality and shelf life of these products [1].



**Figure 1.** Deterioration of prunes caused by microorganisms

Irradiation has been identified as a valid option for food processing, guaranteeing the decontamination and sterilization of products. Only certain radiation sources can be used in food irradiation, one of them is the cobalt-60. Energy from this radiation source is too low to induce radioactivity in any material, including food. This process is validated and regulated by international organizations such as FAO (United Nations Food and Agriculture Organization), WHO (World Health Organization), Codex Alimentarius and by the European Directives (Directive 1999/2/EC; Directive 1999/3/EC) [2, 3, 4].

This technology is accredited to ingredients, being increasingly recognized, and it is characterized by being efficient in conservation, reducing losses caused by natural physiological processes (maturation and aging), eliminating or reducing microorganisms, parasites and pests without causing any change (chemical or organoleptic) to food. All of these make ingredients safer for the consumer; and also, reduces dependence on chemical fumigants and preservatives used by the food industry. In this way, gamma irradiation, sometimes also called "cold pasteurization", could be used by food and pharmaceutical industry to establish a feasible procedure for plants preservation and decontamination. The disinfestation with fumigants is quite effective but nevertheless limited to a surface effect due to its low penetration ability, unlike other methods such as irradiation [5, 6]. These processing technologies may be used to decontaminate imported and exported products. The integration of these technologies in the process will be an added value to the commercialized products [7]. However, this method must be validated for each matrix since the results vary significantly with the type of food, radiation dose, food geometry (which affects dose uniformity), in order to understand how the major nutrients are preserved and simultaneously guarantee the microbial decontamination.

This work aims to evaluate the feasibility of using gamma irradiation for preservation of prunes, seeking validation for the treatment of products with interest for food, assuring quality of products and microbiological safety. Herein, we evaluate the effect of ionizing radiation doses (gamma radiation) on the microbial population of prunes in order to verify the efficacy of irradiation as a decontamination (reduction of the microbial load of bacteria and fungi) and disinfection (absence of potentially pathogenic microorganisms) treatment. With the aim of evaluate the efficiency of ionizing radiation to inactivate potentially pathogenic microorganisms present on prunes, contaminated samples and exposed to sub-lethal doses of ionizing radiation. For that, an initial step of validation and optimization of the methodologies was carried out. The obtained results in this work allow to estimate the minimum radiation dose to guarantee the disinfection and the decontamination to meet the microbiological safety criteria for foodstuffs defined by the legislation (Commission regulation EC n° 1441/2007) [8].

## **EXPERIMENTAL**

The validation of the bioburden method was based on the contaminated prunes samples prunes samples with known concentrations of microorganisms. Fresh prunes were processed equally dry fruit, without stalks, pits and other impurities. Products are not genetically modified (non GMO) and does not contain color additives, sugar and allergens. Prunes are dark brown, purple to black color, typical for the respective type of

dried fruit (Figure 2). Moisture content is 28 – 34%. Shelf life of one year from date of pack under recommended storage conditions in original packing.



**Figure 2.** Samples of prunes from the manufacturer GAIA FOODS

The gamma sterilization process in “Vinča” Institute of Nuclear Sciences uses cobalt 60 radiation for research and industrial irradiation, for radiation sterilization of medical devices, pharmaceutical and as well as for microbial decontamination of herbs and spices and variety of different products. Processing with gamma rays yields quick turnaround time, easily penetrating packaging and product and is cost-effective. Dosimetry measurements were performed using the ECB dosimetry system which provides a reliable means of measuring absorbed dose in materials [9].

The microbiological parameters evaluated: total counts, molds and yeasts counts detection. The evaluation of the microbiological parameters was performed before and after irradiation treatments based on the validated methodologies. The characterization of herbs microbiota was performed by conventional microbiological techniques in order to define a contamination pattern and identify the major microbiological contaminants.

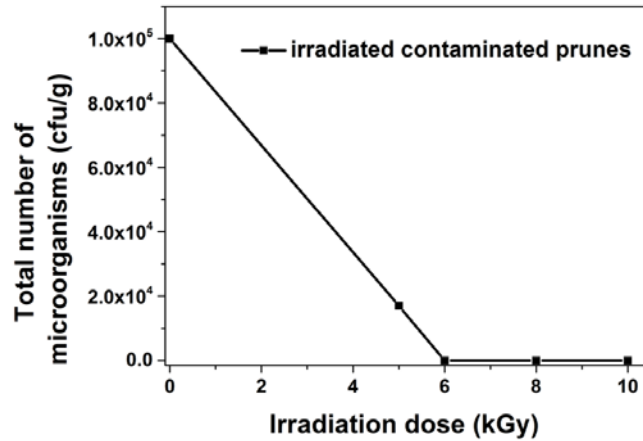
## RESULTS AND DISCUSSION

The results of microbiological tests of contaminated prunes samples before irradiation treatment are presented in Table 1.

**Table 1.** The results of microbiological tests of contaminated prunes samples before irradiation treatment

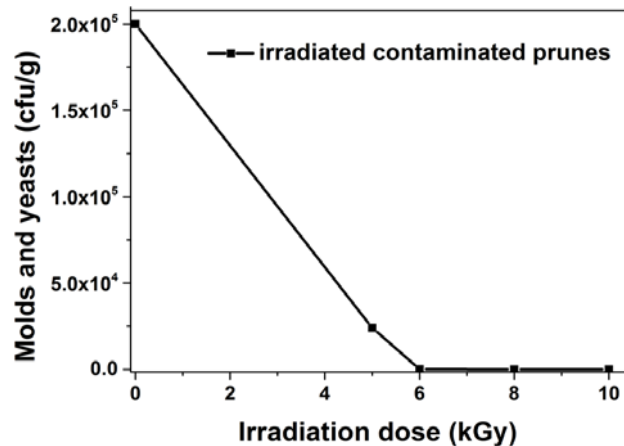
Microbiological parameters (cfu/g)	samples					Method
	1	2	3	4	5	
	<b>contaminated prunes</b>					
total number of micro-organisms	100 000	115 000	130 000	110 000	80 000	SRPS EN ISO 4833-1:2014
molds and yeast	200 000	170 000	230 000	190 000	250 000	SRPS EN ISO 21572-2:2011

These samples were exposed to different doses of gamma irradiation 0 – 10 kGy in order to destroy the microorganisms which exist in the samples. Effect of the radiation doses to reduce the total number of micro-organisms is shown in the picture (Figure 3).



**Figure 3.** Reduction of total number of micro-organisms exposed to different doses of gamma irradiation

Also, the reduction of mould and yeast in contaminated samples of prunes is shown in the Figure 4. The graphs show that with increasing of radiation dose the content of microorganisms in the samples reduces. Also, one should note that with delivered irradiation dose of 6 kGy all micro-organisms in samples were killed.



**Figure 4.** Reduction of molds and yeasts in samples of prunes exposed to different doses of gamma irradiation

The delivered dose of 6 kGy is completely safe for the conservation of these kinds of foodstuffs. Removal these micro-organisms affects the extension of the shelf-life of these foods, because there will be no deterioration in quality.

## **CONCLUSIONS**

Gamma irradiation has been identified as a valid option for food processing and conservation. In this work successful validation of the radiation dose for conservation of prunes was established. The effect of gamma irradiation on the microbial population of prunes is determined in order to verify the efficacy of irradiation as a decontamination and disinfection treatment. It is shown that delivered irradiation dose of 6 kGy removed all micro-organisms in prune samples enabling in this way the extension of their shelf-life.

## ***Acknowledgements***

The financial support from the APV Provincial Secretariat for Science and Technological Development of the Republic of Serbia through project no. 114-451-1850/2014-03.

## **REFERENCES**

1. Molins R., 2001. Food Irradiation, Principles and Applications, A John Wiley & Sons, inc., Publication, 1 – 32, Canada55
2. WHO, World Health Organization, 1981. Wholesomeness of irradiated food, 7 – 13, Geneva, Switzerland
3. CODEX STAN 106-1983, rev.1-2003. General Standard for Irradiated Food, 1 – 3, Vienna, Austria
4. Directive 1999/2/EC. (22 de February de 1999). Directive of the European Parliament and of the Council. OJ L 66 of 13.03.1999. 16 – 23 European Parliament, Council of the European Union
5. CAC/RCP 19-1979 Rev 2., 2003. Recommended International Code of Practice for Radiation Processing of Food. 1 – 7, CCFA
6. SANCO/1332/2000 - rev. 14., 2004. List of Approved Facilities for the Treatment of Foods and Food Ingredients with Ionizing Radiation in the Member States. J O C 166 , 2.
7. Kume, T., Todoriki, S., 2013. Food irradiation in Asia, the European Union and the United States: A status update. Radioisotopes, 62, 291 – 299, United States
8. COMMISSION REGULATION (EC) No 1441/2007, amending Regulation (EC) No 2073/2005 on microbiological criteria for foodstuffs, 2007. Official Journal of the European Union
9. ISO/ASTM 51538:2009 Standard Practice for Use of the Ethanol-Chlorobenzene Dosimetry System, 2009. International Organization for Standardization, Geneva, Switzerland



## PROVIDING FOOD SECURITY HAVING IN MIND ONE RISK MORE –PLANT PEST AND DISEASES

Vesela Radovic<sup>1\*</sup>, S. Krnjajic<sup>1</sup>, B. Ilic<sup>2</sup>

<sup>1</sup>University of Belgrade, Institute for Multidisciplinary Research, Belgrade, SERBIA

<sup>2</sup>Ljilje, Ljubinje, Republika Srpska, BOSNIA I HERZEGOVINA

\*vesela.radovic@imsi.rs

### ABSTRACT

Food security is important issue in every country. This article brings together the available evidence against food security issue, particularly address the issue of food security in the Republic of Serbia. The main objective of this article is to increase the awareness regarding food security, and also highlight the additional risk-plant pest and disease. Authors present a current state in Serbia regarding providing for food in emergencies, and also plant health which is jeopardizing due to increase previously known not so harmful plant pests and diseases. Policy makers still do not have adequate strategy to prevent different risks of various levels, and in the future have to establish it following the EUs common agricultural policy.

**Key words:** food security, plant pest, disease, stakeholder, conflict, climate change.

### INTRODUCTION

Even the most pessimistic forecasts could not have foreseen the upward spiral in negative socio economic consequences of disasters in the years at the beginning of the 21st Century. The current migrant crises in Europe, numerous conflicts all over the world and increase number of natural disaster made food security hit topics for global community. The concept of food safety has expanded significantly to cover environmental safety and national safety. The 2013 World Economic Forum Report stated that global food and nutrition security is a major global concern in an era of increased volatility and uncertainty. Thus, measures to 'improve food security are urgently needed' [1]. In emergencies, food is essential for the survival and maintenance of the population's health in affected areas.

Explanation of some events from human history made by scientific research community bring to light numerous instances claim that food is used as a weapon, but no one expected that it will be seen in 21st century. The UN secretary general identified the right to food as a third track of the Comprehensive Framework of Action (CFA) at the Madrid High Level Conference on Food Security in January 2009. Anyhow, despite all efforts secretary general Ban Ki-Moon in New York in January 2016 commented situation in besieged town Madaya in Syria as 'utterly unconscionable' and warned that

the use of starvation as a weapon during conflict is a war crime [2]. Unfortunately, there are so many places where the global food system showed how it is vulnerable, both structural and social. The United Nations Office for the Coordination of Humanitarian Affairs (OCHA) reported that increasing problems had been compounded by insecurity as well as impact of climate change. Climate changes are crucial factors affecting food security in many regions. Countries like Ethiopia, Sudan, Somalia, Bangladesh, South Korea, and Afghanistan are usually recipients of food aid. In South Sudan political conflict has caused massive displacement, raging violence and dire food shortages. Over 5 million people were in need of aid and nearly 3 million people are at risk of starvation [3].

Food security architecture in the global community is in the period of challenge to response food needs which will continue to increase due to various conditions [4].

In 2009 the UK Government's Chief Scientific Advisor, Professor Sir Jon Bedington, raised the prospect of a "Perfect Storm" of global dimensions by 2030 with the impacts of global challenges such as climate change, food, and energy and water security coming together to impact significantly the lives of all people on Earth. According to the prediction the world's population is expected to increase from six to eight billion by 2030 and we can expect demand for food to increase by 50% [5]. There is a challenge for global agriculture to grow more food on not much more land, using less water, fertilizer and pesticides than historically have done. Projecting it on different way, it means that farmers by the year 2050 will have to produce more food each year than all the food produced by farmers since 10 000 BC, when most experts contend farming began [6].

The question is how to realize this task having in mind data about decreasing agricultural land and increasing the average age of farmers even in developed countries, and increasing various threats on agriculture in generally. For instance, new pathogens and insects are clearly threat to the ability of farmers worldwide in produce enough food to feed the planet in the future. Some data showed that every year 10-16% of global harvest is lost to plant pests and diseases and therefore plant pathologist and expert in food security understand that insuring a healthy crop is the best road to food security [7]. In the Republic of Serbia there is obvious need for improvement of the protection of agriculture from different threats from one side, and provide food and overall security for its population from another. Serbia faced with enormous consequences from extreme weather events: draught in 2012, and flood in 2014 in almost third of its territory. In that flood total disaster effects on agriculture is estimated at 228 million of Euros [8].

Therefore, the determinants of food insecurity in emergencies and the capacity of the state to cope with effects of disasters are of paramount importance for every country. One of the main research questions that this article envisions to answer is: "What are the government's plans and capacities to deal with disaster, and how its food security policy can coordinate with other programs and policies, especially pest protection in agriculture?"

The hypothesis of this article is that the food security in Serbia could not be provide without legal protection of agriculture as a part of critical infrastructure, especially having in mind presence of significant climate change. This article also address specific climate change altering the distribution of animal and plant pests and diseases which the full effects are difficult to predict, but could be a significant factor of

jeopardize agricultural production. Climate change allows the establishment of pests in areas where they could so far not established, and even its use as a weapon use in specific terrorism form agroterrorism [9]. The methodology used in article is usual for social researchers: historical analyses, comparative analyses, and data analyses. Authors used various documents from electronic databases, books, scientific journals, official documents and positive practice from international communities. The article is helpful for all interested parties in the area of emergency management and agriculture who have to create policies in the future regarding achievement of adequate level of food security. Investing in plant health protection is absolutely essential to give farmers a chance to produce enough for insuring food security because it begins at the farm level, and after that through all activities of other interested parties. Hence, the article outcome is aimed to improve national capacities to handle situations of crises, and build resilience into adequate food supply during emergencies.

### **FOOD SECURITY IN ERA OF DISASTERS –WHO'S JOB IS TO HANDLE THE URGENT SUPPLY**

Food security in one country could be seen as a measure of the success of agriculture, and has not been taking for granted. Among various term authors choose definition that food security is a state when all people at all times have physical and economic access to sufficient, safe and nutrition food to meet their dietary needs and food preferences for an active and healthy life style [10]. Hence, food aid represent voluntary transfer of food from one country to another for humanitarian purpose without getting into depth of current debate and ongoing efforts of a needed changes in food aid and food assistance policies and strategies within the international aid system [11].

No doubt that the security of food supply is a major priority in any comprehensive national strategy response in emergency. It is not difficult to imagine how hard is to handle food security in a global environment where threats are constant and evolving. The most influential organization work in the area of food security is the World Health Organization (WHO). It works closely with the Food and Agriculture Organization of the United Nations (UN FAO), the World Food Program (WFP), and with numerous humanitarian organizations all over the world. WFP is developed as a multilateral food aid project to complement the United States' food aid program in 1961. In 2004, WHO launched the International Food Safety Authorities Network (INFOSAN) as an early warning, communication and prevention system which enables rapid access to information during the food safety emergencies [12]. The United Nations established a High Level Task Force (HLTF) and a Comprehensive Framework of Action (CFA) to enhance the efforts of the UN system, and the international financial institution to response to the food crises. Some of the most active institutions in this area are: International Federation of the Red Cross and Red Crescent (IFRC), United Nations High Commissioner for Refugees (UNHCR), Save the Children, the North Atlantic Treaty Organization- North Atlantic Alliance (NATO) and etc.

In the European Union (EU) there are a lot of documents that outline the addressed policies about food supplies, food safety and nutrition, and also about mobilization of resources for the activities on poverty and health [13, 14]. The European



Commission, the European Parliament and many member states have proposed food security as a key theme for the post - 2013 Common Agricultural Policy (CAP). In its recent communication 'The CAP towards 2020', experts, for instance, highlights the need to preserve the EU's food production potential, 'so as to guarantee long-term food security for European citizens'. All this has turned food security into the most pervasive and powerful argument of those calling for the protection of EU agriculture [15]. Republic of Serbia has to follow the European Union practice in the area of food security.

Recent emergencies have proven that Serbia, similar to Bosnia and Herzegovina (B&H) and Montenegro does not have the required human, material and financial resources, and thus in current macroeconomic conditions are not able to execute comprehensive plans related to food supply in emergencies. Noteworthy, the US Military (214th Aviation battalion of the United States of America Combat Aviation Brigade headquartered in Katter Bach in Germany) provided helicopter assistance for Montenegro winter emergency relief s in winter of 2012 to deliver critical supplies and provide rescue services to inhabitants in the areas most heavily hit by snowstorms. Hence, after every disasters figures confirmed increase of pour population policy makers have to have this important fact in mind. For instances, the number of percentage of pour population increased even in normal circumstances, like in the region which has been known as the most favourable agricultural region (the Autonomous Province of Vojvodina from 5, 6% in 2013 on 7, 8% in 2014 [16]. It is obvious that situation is alarmed. In winter 2012 during emergency state population in several cities in Vojvodina got food aid donated from regional emergency headquarter. In floods in 2014 more than 200 enterprises donated food to the affected population, mostly for the vulnerable groups, children, aged population, Roma, women and disability and pour persons [17].The scientist and academic community needs to envision producing concrete policy recommendations on food security with focus on the unimpeded flow of food supply in emergencies. Serbia has to introduce significant changes to safeguard food security especially because it is a function of self-efficiency.

#### **THE DOMINO EFFECTS-ONE RISKS FOLOWING WITH ONE NEW AND HOW MANY MORE?**

In the last decade a lot of articles and report have been published with the objective to explain how to improve the resilient of agriculture due to climate change. Yet the future of agriculture given expected changes in climate and other environmental drivers uncertain. In the area of risk management is important to understand the linkage among different kind of risk and its internal relations [18]. In the area of food security this interconnection is visible and therefore there is no one solution which could be implied. The adequate solution should be considered environmental, socio economic and policy changes. Many scientist addressed new approach in the area of food security insist that not only increasing of production is needed. They present the concept that the following measure is also a permanent action to increase to plant health and therefore increase yield in generally. European Union set as a priority tackling emerging plant pest and diseases which increase due to numerous factors. Warming and drought, temperature

variation, soil moisture evaporation, and other environmental drivers co-occurring with insect and diseases outbreaks, have been linked to plant health in many region.

Serbian agriculture also is exposed to different kind of risks. Frequent periods of drought caused great losses in last decade. According to the results of investigation on the influence of drought on the yield of crops in the region of Eastern Serbia in the period of 1989-2000, the reduction of crop yield was 40.9% in comparison to average yields without drought [19]. The most serious was the draught in 2012. Serbia suffered an extreme drought, with record dry weather and high temperatures even exceeding previous drought years of 2001, 2004, and 2008. The Serbian Chamber of Commerce estimates total losses in agricultural production were around 2 billion USD [20]. Having on mind that consequences could be direct and indirect is obvious that indirect damage (decrease in export of agricultural products, loss of market because of non-compliances of contracts and so on) was enormous.

In the Republic of Serbia were a lot of numerous actions in Serbia regarding plant health protection and pest management in generally. Some of this was established legal regulation [21], academy awareness and many others, but there still are a lot of room for its improvement. For instance, inspection and control systems at the border could be discussable question having in mind visible regional political situation and porous borders especially on south, because unsolved Kosovo-Serbian question. In Serbia public perception of plant pest and disease is also confronted with a lack of trust among agricultural community and Ministry of Agriculture and Environmental Protection, and its special unit in charge for this task Plant Protection Directorate. In the future this deficiency has to be urgently removed, because it makes a lot of misunderstand. Hence risk communication is Achilles' heel of adequate risk management in Serbia in many areas [22]. One of recent instances happened in summer 2014 when nine of farmers from three villages in central Serbia submitted a High Court lawsuit against the Ministry of Agriculture because of destroyed last generation potatoes. The Plant Health Act and the Rule on establishing a program of measures to protect plant health for 2015, which was adopted by the Serbian Government, contains part of the constant monitoring that applies to potatoes, but they claimed that these measures did not apply properly, for reasons unknown, although the budget for this purpose was provided as a part of funds for the implementation of control on the presence of harmful organisms. Farmers claimed that they Advisory Service of the Ministry did not inform producers about the moth invasion. Potato tuber moth (in 2015 destroyed the entire potato of over 200 hectares). Their legal representative said that the Plant Protection Act specifies that service of the Ministry of Agriculture must conduct constant supervision of plants, what also includes forecasts of harmful organisms, as well as the development and movement of their populations [23]. In Serbia potato tuber moth has been long at the list of quarantine pest, even first time is noticed in 1994 near city Leskovac (Jablanica District), without significant losses. [24]. During the period 2009-2013 at same area is recorded more intensity presence of potato tuber moth, with increasing economic damages. Furthermore, the presence is also recorded in some other localities (near city Cacak and Gornji Milanovac), as well as in South Banat, Bačka, and Srem region [25].

Growing scientific evidence suggests that rising extreme events will have increasing impacts on Serbian agriculture. Agriculture represents a part of so called

`critical infrastructure` and it is necessary to protect it from risks. According to the First National Communication to the the United Nation Framework Convention on Climate Change (UNFCCC), Serbia will be affected by climate change seriously, and the general trend of increase in air temperature to decrease in precipitation will decrease crop yields by 10% until 2050 (for selected crops) [19].

Global warming is disrupting millions of delicately balanced ecological relationships among species in different ways. The age-old rhythm of the Earths season is changing and some parts of the world heat up more rapidly than others. Great number of invasive alien species has rushed in to fill newly created ecological niches [26]. Among all agriculture threats in the area of food security is noticed it's direct connection with pest management. New plant pest and diseases threat agricultural production all over the world. Hence, the International Plant Protection Convention Secretariat try to increase risk awareness of the public and political decision maker on global, regional and national level about plant health and its contributions to protecting sustainable agriculture and thus enhancing global security through the prevention of pest spread regarding this issue by established 2020 as an International Year of Plant Health. Pests, pathogens and weeds cause the loss of more than 40% of the world's food supply. Pest impacts food security, economy and implementation of adopted concept of sustainable development. Additional threats to plants from climate change are a reduction of crops tolerance and resistance to pest and disease, a decrease of soil fertility and possible increase of soil erosion that reduces the natural capacity of soils to control soil borne pest disease, reduces a beneficial organisms for pest and disease control and reduction in the effectiveness of safe pesticides and herbicides. Understanding perception of risk, awareness and trust in management agency is critical to effective pest management. The agriculture in the Republic of Serbia is faced with main challenges in the area of food-production systems, problem surrounding the lack and price of food, and the ways in which to build sustainability, as well as food security and justice, into the food arena.. Stakeholders action has to be coordinated at the local, national and international scales and that there is a need for greater integration across the nature, biological and bio technological science and social science.

## **CONCLUSION**

No doubt that the safety and security of food supply is a major priority in any country. It is not difficult to imagine how hard is to handle food security in a global environment where threats are constant and evolving. In emergencies all over the world, it has become evident that food supplies are not adequate. Improving supply of food in emergencies will increase the effectiveness of coordination and cooperation, communication and reporting between government and stakeholders. Despite the involvement of international organizations in the improvement of state services to promote food security, there is still room for improvement.

The results of the article confirmed that if the approach of food security has to be changed in practice. Serbia should avoid being the object of numerous scientific and institutional reports presenting Serbian insufficient capacity to cope with different perils. Reducing the risk of invasive pest and pathogens, combining legislation, targeted

management and public awareness risk knowledge and trust is the basic for increasing the level of sustainable agriculture and adequate food security in three major level: the family, the nation, and the globe. Serbia has to move toward fostering self-sufficiency in food and sustainable interaction with the environment.

### **Acknowledgements**

*This paper was written as a part of the project Nr. III 43010 "Modulation of antioxidative metabolism in plants for improvement of plant abiotic stress tolerance and identification of new biomarkers for application in remediation and monitoring of degraded biotopes" and project III43001 "Agrobiodiversity and use of land in Serbia: an integrated assessment of biodiversity core group of arthropods and plant pathogens", which are financed by the Ministry of education, science and technological development of the Republic of Serbia.*

### **REFERENCES**

1. World Economic Forum. Achieving the New Vision for Agriculture: New Models for Action. Geneva, Switzerland
2. UN News Centre. 2016. Starvation 'as a weapon' is a war crime, UN chief warns parties to conflict in Syria. Available on: <http://www.un.org/apps/news/story.asp?NewsID=53003#.VzdV96Uk>
3. MercyCrops. 2016. Quick facts: What you need to know about the South Sudan crises. Available on: <https://www.mercycorps.org/articles/south-sudan/quick-facts-what-you-need-know-about-south-sudan-crisis>
4. World Health Organization (WHO). 2013. The International Food for Reform. Available online: <http://www.oxfamamerica.org/take-action/campaign/food-farming-and-hunger/food-aid/>
5. Bedington, J., 2009. Food, energy, water and the climate: A perfect Storm of Global Events? Retrieved September 10, 2012, from [www.bis.gov.uk/assets/geoscience/docs/p/perfect-storm=paper.pdf](http://www.bis.gov.uk/assets/geoscience/docs/p/perfect-storm=paper.pdf)
6. Robertson, R. 2011. Good plant health will key future food security. Available online: <https://foodsecuritysm.wordpress.com/2011/01/25/good-plant-health-will-key-secure-future-food-y/>
7. Chakraborty, S., Newton, A. 2011. Climate change, pest diseases and food security, an overview. <https://publications.csiro.au/rpr/download?pid=csiro:EP104035&dsid=DS2>
8. Serbian Government, Flood in Serbia 2014 Year. <http://www.obnova.gov.rs/uploads/useruploads/Documents/RNA-REPORT-140714.pdf>
9. Radović V.: 2012. The Mitigation of the Agro-Terrorism Threat to the Republic of Serbia, In: Managing the Consequences of Terrorist Acts - Efficiency and Coordination Challenges. Ed, Čaleta, D., Shemella, P. Institute for Corporate Security Studies-ICS, Ljubljana, Slovenia, and Centre for Civil Military Relations, Naval Postgraduate Scholl Monterey, USA, Ljubljana,

- Slovenia, pp.199-211.
10. Food and Agriculture Organization of the United Nations (FAO). 1996. World Food Summit. Recommended international code of practice general principles of food hygiene. Available on: <http://www.fao.org/docrep/005/Y1579E/y1579e02.htm>
  11. Barrett, C., Maxwell D., 2005. Food aid after fifty years: Recasting its role, Routledge, NY, USA.
  12. World Health Organization (WHO). The International Food Safety Authorities Network (INFOSAN). Available on: [http://www.who.int/foodsafety/fs\\_management/infosan/en/](http://www.who.int/foodsafety/fs_management/infosan/en/)
  13. World Health Organization (WHO) and WHO Regional Office for Europe. 2002. Food and health in Europe: a new basis for action. Copenhagen, Denmark. Available on:
  14. Kaluski DN (2009). Strengthening food safety and nutrition policies and services in south Eastern Europe. WHO Regional Office for Europe, Copenhagen, Denmark. Available from: [http://www.euro.who.int/\\_\\_data/assets/pdf\\_file/0006/99897/E92650.pdf](http://www.euro.who.int/__data/assets/pdf_file/0006/99897/E92650.pdf).
  15. Zahrt, V.2011. Food Security and the EU's common agricultural policy: facts against fears. ECIPE Working paper No 01/2011, pp. 1-23, Brussels, Belgium
  16. Mijatović, B. 2014. Siromaštvo u Srbiji 2014. Tim zasocijalnouključivanjemanjenjesiromaštva. Available on: <http://socijalnouključivanje.gov.rs/wp-content/uploads/2015/10/Siromastvo-u-Srbiji-2014.pdf>
  17. Udruženigradani, Izveštaj o proceni potreba nastalih usled poplava u manu 2014. Available on: [www.udruzeni.org](http://www.udruzeni.org)
  18. World Health Organization (WHO). (2013). The International Food for Reform. Available online: <http://www.oxfamamerica.org/take-action/campaign/food-farming-and-hunger/food-aid/>
  19. Radović, V. 2012. Climate Change and Adoption Strategies: A Report from the Republic of Serbia. In: National Security and Human Health Implications of Climate Change, NATO Science for Peace and Security: Series C Environmental Security, p. 95-102, Springer, Dordrecht.
  20. United States Department of Agriculture (USDA) Foreign Agriculture Service. 2013. Global Agricultural Information Network. Gain Report Number RB 1302 Annual Report on Wheat, Corn, and Barley in Serbia.
  21. Law on plant health and plant protection product. Official Gazette of the Republic of Serbia, No. 41/2009.
  22. Radović V., Mercantini, J.M., 2015. The Importance of Risk Communication as an Integral Part of Risk Management in the Republic of Serbia.” In book Risk and Cognition. EdsMercantini, J.M., Faucher C. Verlag Springer Berlin Heidelberg, pgs. 61-88.
  23. Tanaskovic, S., Popovic, B.,Marjanovic,M., Draskovic.G., 2016. Moljac krompira kao štetčina-od prisustva do visoko ekonomski značajne vrste u Srbiji. Zbornik radova sa XXI Savetovanja o biotehnologiji, 11 i 12 mart, 2016, Čačak, Srbija

24. Jovanović, G. (2015). Moljac krompira (*Phthorimaea operculella*). 15.10.2015. <http://www.agrozastita.rs/index.php/15-moljac-krompira-phthorimaea-operculella>
25. Kereši T., Sekulić R., Tanasković S., Konjević A. (2015). Krompirov moljac - sve važnija štetočina krompira u Srbiji. *Biljni lekar*, 43(6):608-621.
26. Al Gore, A. 2006. *An Inconvenient Truth: The Planetary Emergency of Global Warming and What We Can Do About It*, RodalePress, Emmaus, Pennsylvania, the United States.



## CONTENTS OF SOME OLIGOELEMENTS IN SERBIAN WINES AND FRUIT WINES

Zorica Basic\*, S. Masic

Institute of hygiene, Military Medical Academy,  
Crnotravska 17, 11000 Beograd, SERBIA

\**basiczorica@yahoo.com*

### ABSTRACT

Fruit wines in Serbia have a reputation as a source of good health, immunity and blood count. Wine has been traditionally consumed for centuries in winegrowing regions; nowadays, it is consumed in small quantities as a support to health preservation as well. Inductively coupled plasma-atomic emission spectrometry (ICP-AES) provides a rapid and precise means of monitoring elements simultaneously for minor- and trace- levels. The aim was determination of the oligoelements (iron, zinc, copper, chrome, manganese, cobalt) content in fruit wines and in domestic red grape wines, using ICP-AES spectrometry, and to compare the obtained results. Domestic fruit wines are a good source of oligoelements, as well as some grape wines from the market. The advantage can be given to fruit wines because of the lower ethanol content, making them suitable for the general population.

**Key words:** fruit wines, oligoelements, ICP-AES.

### INTRODUCTION

The expansion of nutritional labeling programs and increased customer interest in nutrition have created new demands on the food industry to specify the quantity of individual carbohydrate fractions in fresh and processed foods, rich in minerals [1]. In spite of a rich offer of industrially produced wines, there is also a variety of fruit wines traditionally made from red fruits.

Minerals have many important physiologic functions. They assist in fluid regulation and energy production, are essential to the health of our bones and blood, and help the body to get rid of harmful by-products of metabolism. Minerals are classified according to the amounts we need in our diet and according to how much of the mineral is found in the body – oligoelements (trace minerals) and major minerals [2]. Some metals may have harmful effects on health; these metals should be analyzed [3].

Inductively coupled plasma-atomic emission spectrometry (ICP-AES) provides a rapid and precise means of monitoring elements simultaneously for minor- and trace- levels. The ICP-AES technique is widely regarded as the most versatile analytical technique in the chemistry laboratory [4].

## MATERIAL AND METHODS

Four types of fruit wines were analyzed (blackberry, raspberry, cherry, apple) and red grape wines of various producers, a total of 30 samples. Samples were prepared by microwave sample digestion: 5 g of the sample and 5 mL HNO<sub>3</sub> 65% were added. A microwave furnace was used for the digestion and dissolution of the experimental samples. In the method, the samples were dissolved at 180 °C and 400 psi pressure in apparatus. After further 20 min processing, the samples were put into 25 mL polyethylene flasks, which were made up with deionized water.

The metals were analyzed by ICP-AES (ICAP Series 600 Thermo Fisher scientific). The calibration curves were constructed using a series of dilutions containing different levels of metals (0,005 mg/L to 2 mg/L). The reading was made at the emission wavelengths for zinc, manganese, iron, copper, chrome and cobalt of 202.548, 257.610, 238.204, 324.754, 267.716 and 238.616 nm, respectively. The results were evaluated according to iTEVA iCAP Software ICP Spectrometer, and for the comparison of the metal values One-Sample *t*-test was used. The method was validated using certified reference material „Environment Canada TM-25.3“ (Table 1) and by successful participation in Proficiency Testing Provider API, schem: 2016 Food Chemistry – 1st Event.

## RESULTS AND DISCUSSION

Zinc, manganese, copper, chrome and cobalt contents did not vary significantly in commercial wines, while iron contents did, depending on type of wine. In fruit wines, contents of manganese, iron and chrome varied significantly, depending on the origin of wine, while zinc, copper and cobalt contents showed less variation (Table 2). Certain oligoelement values are in accordance with their contents in corresponding fruit [5].

There is statistically significant difference in terms of higher zinc and copper contents in fruit wines, compared to other wines. In terms of average manganese, chrome and cobalt contents, there is no statistically significant difference. Regarding iron content, average values differ, but there are significant differences between certain types of fruit wines, resulting in no statistical significance (Table 3).

**Table 1.** Method validation using certified reference material „Environment Canada TM-25.3“

CRM *	Mn mg/L	Fe mg/L	Cu mg/L	Cr mg/L	Co mg/L
Determined	26,8	27,9	25,1	23,7	30,3
Certificated	25,4±2,54	29,6±4,76	27,6±2,84	24,4±2,13	27,9±2,56

\*)Environment Canada TM-25.3 lot 0809



**Table 2.** Content of selected elements in grape wines and fruit wines originating from Serbia

Wines	Zn mg/L	Mn mg/L	Fe mg/L	Cu mg/L	Cr mg/L	Co mg/L
Chardonnay	1,371	0,928	1,430	0,804	0,104	0,007
	1,227	0,778	1,445	0,424	0,084	0,005
	1,121	0,754	1,767	0,742	0,094	<0,005
	1,043	0,986	1,307	0,876	0,099	<0,005
Graševina	1,623	0,875	3,157	0,350	0,106	0,009
	1,443	0,774	4,123	0,331	0,086	0,005
	1,534	0,821	3,572	0,399	0,076	<0,005
	0,935	1,069	2,180	0,214	0,121	0,007
	1,442	0,733	2,337	0,287	0,104	0,007
Vranac	0,963	1,140	2,926	0,201	0,096	0,006
	0,762	0,814	3,216	0,281	0,086	0,005
	0,933	0,910	2,426	0,193	0,077	0,006
Prokupac	1,528	1,438	2,364	0,698	0,068	0,006
	1,338	1,137	1,742	0,595	0,064	0,007
	1,223	0,938	2,554	0,447	0,083	0,008
	1,326	1,332	2,068	0,613	0,065	0,005
Fruit wines						
Cherry	0,575	3,152	6,065	0,358	0,187	0,011
	0,595	3,002	4,064	0,287	0,102	0,005
	0,483	2,782	4,534	0,266	0,147	0,006
	0,477	2,835	3,675	0,298	0,153	0,007
Rasbery	0,388	0,324	1,147	0,264	0,038	0,005
	0,344	0,302	1,237	0,327	0,068	<0,005
	0,372	0,287	1,402	0,269	0,059	<0,005
Blackberry	0,563	2,482	2,421	0,181	0,106	0,009
	0,611	2,683	2,712	0,176	0,091	0,007
	0,456	2,724	2,122	0,168	0,094	0,008
Blueberey	0,371	1,378	5,351	0,207	0,102	0,008
	0,421	1,189	4,761	0,177	0,082	0,006

**Table 3.** Mean content of selected elements in grape wines and fruit wines

	Zn mg/L	Mn mg/L	Fe mg/L	Cu mg/L	Cr mg/L	Co mg/L
Mean values for grape wines	1,238	1,143	2,392	0,466	0,088	0,006
Mean values for fruit wines	0,404	1,469	2,821	0,213	0,087	0,006
p	<0,01	>0,01	>0,01	<0,01	>0,01	>0,01
p>0,01 – The difference between mean levels of elements is not significant;						

### CONCLUSIONS

Fruit wines are a good source of oligoelements, as well as some grape wines from the market. The advantage can be given to fruit wines because of the lower ethanol content, making them suitable for the general population, as well as one good excipient for some supplements.

### REFERENCES

1. John Howlett (2008). Functional Foods: From Science to Health and Claims. ILSI Europe,.
2. Janice L. Thompson, Melinda M. Manore, Linda A. Vaughan (2011), The science of nutrition Second Edition, Pearson US,
3. Randelovic S., Kostic D., Arsic B., Mitic S., Rasic I., Mitic M., Dimitrijevic D., Stojanovic G., (2015) Chemometric Analysis of Grapes. Analysis of Grapes, Open Chem., 13: 675–682;
4. Bingol M., Yentur G., Er B., Oktem A.B., (2010) . Determination of Some Heavy Metal Levels in Soft Drinks from Turkey Using ICP-OES Method, Czech J. Food Sci. 28 No3: 213-216
5. Piotez Szefer, Jerone O. Nriagu, (2007). Mineral Components in Foods, CRC Press Taylor & Francis Group,



## ECONOMIC IMPORTANCE OF WILD FRUIT AND AUTOCHTHONOUS VARIETIES OF GRAPE

Gorica Paunovic, R. Ilic, V. Vukosavljevic, I. Glisic, Lj. Boskovic Rakocevic

University of Kragujevac, Faculty of Agronomy, Kragujevac, SERBIA

### ABSTRACT

Wild fruits and autochthonous (indigenous) varieties of grape, are very important natural resources. Our country has a very rich and fruity polymorphic wild flora, which represents a significant source of germplasm of fruit trees. The importance of wild fruit species is multiple especially for fruit science and practice. Their genetic potential is of immense importance in breeding of cultivated fruit trees. In the nursery production of fruit seedlings many of wild fruit species are used in the production of generative rootstocks. Wild fruit species have fruit that are usually of excellent quality and high nutritional value for human nutrition.

**Key words:** wild fruits, the fruits, the economic significance.

### INTRODUCTION

In natural ecosystems, Serbia recorded over 100 species of wild fruit trees. Wild fruits are very important natural resources and inexhaustible genefond of extremely important species. The importance of wild fruit is multiple. Firstly, wild fruits are a natural source of the genetic potential of immense importance in breeding of cultivated fruit species. Work on fruit breeding is based on the collection at start, and selecting indigenous species of fruit trees from natural populations. Selecting positive ecotypes of wild fruit trees is also the way to their domestication in order of their conservation and utilization of positive qualities. Second, a big number of wild fruits are used as generative rootstocks in fruit growing practice in our country, specifically in nursery production of fruit seedlings. In the nursery production of high importance, as the basis, have *Prunus cerasifera* Ehrh., *Pyrus communis* L., *Malus silvestris* Mill., *Prunus avium* L., *Juglans regia* L., *Corylus colurna* L., *Prunus spinosa* L., *Crataegus nigra* Wald. et Kit. Furthermore, wild species give fruits usually of excellent quality and high nutritional value, and they are used in human nutrition and industrial processing.

In spite of the abundance of archaeological, bio-archaeological, historical and genetic data, the origins, historical biogeography, identity of ancient grapevine cultivars and mechanisms of domestication are still largely unknown. The grapevine (*Vitis vinifera*) belongs to the family Vitaceae, which comprises about 60 inter-fertile wild

*Vitis* species distributed in Asia, North America and Europe under subtropical, Mediterranean and continental–temperate climatic conditions. It is the single *Vitis* species that acquired significant economic interest over time; some other species, for example the North American *V. rupestris*, *V. riparia* or *V. berlandieri*, are used as breeding rootstock due to their resistance against grapevine pathogens, such as *Phylloxera*, *Oidium* and mildews. Indeed, a great majority of cultivars widely cultivated for fruit, juice and mainly for wine, classified as *Vitis vinifera* L. subsp. *vinifera* (or *sativa*), derive from wild forms *Vitis vinifera* L. subsp. *sylvestris* [21], [24], [5], [25]. The wild grapevine is a heliophilous liana growing generally along river banks, and in alluvial and colluvial deciduous and semi-deciduous forest [14], [2]. The present distribution of the wild grapevine is highly fragmented, in disjoint micro-populations or metapopulations, with few individuals, at least in the western part of the Mediterranean Basin. Anthropogenic pressure on their natural habitats and pathogens introduced from North America during the second part of the 19th century, may explain the progressive decline of wild grape populations [2]. The ‘Phylloxera crisis’ that affected European vineyards had a considerable impact on both cultivated varieties and wild grapes. As a result, modern wild grapevines are endangered and threatened with extinction [2]. The future of *Vitis vinifera* subsp. *sylvestris* represents a major stake in biodiversity conservation. The autochthonous (indigenous) varieties of grape are important to the history and identity of the wine industry in Serbia. Varieties indigenous Prokupac, Tamjanika, Smederevka, Začinak, Bagrina, Kavčina, Crna okata, Zelenika, Slamkamenka crvena (Plovdina), Slamkamenka bela (Mađarka), Ružica (Kevidinka), Skadarka, Prokupac (rskavac), Tamjanika, Lalica, Kečun, Gak, Pandurka, Smetuša, Hajmana, Volujsko oko, Šljiva grožđe, Crna ranka, Bela ranka, Peršun grožđe, Pljuca, Radovinka, Meljnik, Vrapčije grožđe, were once widely planted but amounts have fallen off significantly.

The economic importance of wild fruits and autochthonous (indigenous) varieties of grape can be seen from several aspects:

- picking and collecting wild fruits, as an additional source of revenue and income
- possibility of processing fruits and wild
- wild fruit as raw materials for the pharmaceutical industry.

#### **PICKING AND COLLECTING FRUITS OF WILD FRUITS SPECIES - ADDITIONAL SOURCE OF INCOME**

Collecting the fruits of wild fruit species can be economically beneficial in two ways: 1) for the individual - to meet their own needs for biologically more valuable food; 2) for people - especially for economically poor in underdeveloped and rural areas, as an additional source of income. Collecting the fruits of wild fruits for their own use is interesting, because it's free food from nature and can be consumed immediately fresh or processed the same day. If it is processed on the same day there is chance to save maximum of the taste and composition of vitamins and other labile bioactive substances. From June to late autumn, our forests, mountains, fields, valleys of rivers and streams, bushes and hedges are full of the fruits of wild fruits. These fruits are very

healthy food of high nutritional and vitamin values. These orchards are endless natural mines and cheapest factory of vitamin C. The fruits of wild fruits are much richer in vitamin C than fruits grown in commercial orchards. The second most important vitamin that meets the wild fruits is carotene (carotene), provitamin that the body converts to vitamin A. There is large quantity of most vitamins in wild fruits A (vitamins B complex, vitamin E, vitamin K, vitamins PP) and they can be regarded as natural poly-concentrates.

Collecting wild fruits can be particularly interesting for the inhabitants of the cities, because going to nature provides city man great satisfaction and relaxation. This restores lost contact with nature and became an advocate of the preservation and improvement of the environment.

For a population of some rural areas collecting wild fruits can be a significant source of supplementary or seasonal income. In our country, for the purposes of processing are bought: blueberries, blackberries, wild strawberries, Cornelian cherry, rosehip, cherry plum. For these fruits are interested in the factory for processing of fruits, which have facilities for the production of healthy food, made from wild fruit, in the form of: juices, jams and baby porridge.

Wild fruit should be picked at full maturity, as these fruits are more qualitative, tastiest and aromatised. During harvesting and collecting wild fruits should be taken to ensure that the wealth of nature are not unlimited and that harvesting should be done rationally.

### THE POSSIBILITY OF PROCESSING WILD FRUITS

The best way to use all nutrient of wild fruits is to consumate them fresh. But, some of them are more compatible as processed. There are many ways to process and conserve wild fruits. The use of wild foods, of which wild fruits form a part as a component of local responses to increasing food insecurity and as one of the major coping mechanisms at times of food shortage and famine is widely documented [1], [7], [6], [20].

Most price have red, orange and yellow fruits (because most contain beta-carotene). The best known are: *Pyrus communis* L., *Malus sylvestris* Mill., *Sorbus domestica* Mill., *Mespilus germanica* L., *Cydonia oblonga* Mill., *Fragaria vesca* L., *Rubus ideus* L., *Vaccinium myrtillus* L., *Prunus spinosa* L., etc. Each fruit alone or in a mixture, is a true arsenal and a wealth of protective substances: vitamins, herbal acid, pungent substances (tannin), a variety of useful salts and other medicinal ingredients.

Wild fruits are usually used as raw material for making vitamin concentrates which are often called natural multivitamins [19].

Also, they can be processed to juices or fruit wine which are very effective in struggling with alcoholism. In some more development countries those juices are sold as "vitamin fruit juices" or "fluent fruit" and it is used to cure some diseases [8]. However, in some countries, such as Botswana, there are fruits of *Sclerocarya birrea* Sond processed into an array of products such as cosmetic formulations (marula soap, marula oil), marula jam, marula chips and sweets and marula alcohol [18]. Compotes, fruit salads, jams, marmalades, sweets, baby puree and so on are also very famous products

that can be made of wild fruits. Fruits can be dried, too, so we are able to use them as fruit teas or refreshing drinks, especially in winters days, when we need some extra vitamins.

Studies have shown that harvesting fruits from the wild and also from the semi domesticated trees growing in farms can boost rural employment and generate substantial income from processing and adding value [22].

### **WILD FRUITS AS RAW MATERIALS FOR THE PHARMACEUTICAL INDUSTRY**

The healing properties of plants have been known since the earliest times of human civilization. From then, until the present day, the plant were used as food, medicines, preservatives, for religious purposes, for decoration, etc. Until the development of chemistry, and in particular the synthesis of organic molecules in the nineteenth century, the source of pharmacologically active substances were only plants. In recent years, increased interest in the fruits and vegetables that contain high concentrations of polyphenols because of their potential biological and health beneficial effects. These biological effects are in part conditioned by their antioxidant capacity.

Due to the large amount of vitamins and mineral nutrient and very specific chemical characteristics, wild fruits can be used not only in traditional medicine, but also in pharmaceutical industry. The most frequently reported medicinal uses were for treating gastrointestinal ailments, skin injuries and problems followed by respiratory, urinary-genital and cardiovascular problems [10]. Most of wild fruit species, besides fruits, have some other organs that are very medicinal. For example, very precious are leaves of *Rubus fruticosus* L., *Rubus idaeus* L., *Fragaria vesca* L., *Ribes* ssp., *Juglans regia* L., *Castanea sativa* Mill., etc. or fruit stalk of *Prunus avium* L., *Prunus cerasus* L. All that fruit parts are most commonly used in pharmaceutical industry for extracting medicinal ingredients such as: alkaloids, glycosides, saponins, tannins, essential oils, vitamins etc. [8]. Also, some authors [10] in their investigation says that plant parts that are used for medicinal and non-medicinal purposes often differed, i.e. fresh or prepared fruit was most frequently used for human nutrition, whereas the leaves of the same species were used for tea in phytotherapy.

Between usual fruit and vegetables in the diet, the highest antioxidant capacity stands out berries dark-blue or red [15].

Berries is known as a good source of polyphenolic compounds that contribute to the high antioxidant activity. Of polyphenols and the highest percentage represented by these molecules, in the form of glycosides and flavonoids of which are the most common derivatives of quercetin and kaempferol [12], [9].

Studies of epidemiology have shown a correlation between high polyphenol intake and reduced risk of cardiovascular disease as well as beneficial effects on certain types of cancer and neurodegenerative diseases such as Alzheimer's and Parkinson's disease [16], [11]. Some authors [17] found that in the leaves of *Prunus spinosa* L., there was higher amount of total phenols, esters of tartaric acid and of the total flavonols in respect of the fruit as a whole.

Research in the field of chemistry, biochemistry and medicine confirmed that fruits, vegetables, spices and herbs, grains and other foods of plant origin, as well as extracts, containing natural antioxidants: polyphenolic compounds, vitamins (vitamin E, vitamin C) terpenes and others [23]. So they show antineoplastic, antiviral, anti-inflammatory, anti-allergic and antioxidant properties [4].

Polyphenol compounds are very important to the organoleptic characteristics of food and for its positive health effects. The most important fact of polyphenolic compounds are: antioxidant, antibacterial and antiviral [13]. Some polyphenolic compounds have a role of plant pigments.

The autochthonous (indigenous) varieties are important source of nutrients and compounds with functional properties. The grape obtained low and pH below neutral, which can help prevent growth of pathogenic microorganisms. The amount of total dietary fiber is quantitatively greater compared to that of carbohydrates, proteins, and lipids, indicating that this residue could be included in the daily diet as a source of fiber and food supplement. Regarding compounds with functional properties, show that grape may be a potential source of bioactive compounds, especially higher concentration of insoluble fibers in relation to the soluble fraction, and significant amounts of vitamin C and anthocyanins. Minerals, iron, potassium, zinc, calcium, and manganese are present in higher concentrations. Furthermore, the flour produced from grape, which is environmentally appropriate and easy to obtain, may be a potential food ingredient in the daily diet or as a nutritional supplement. The microbiological and toxicity bioassays of the indigenous grape was not contaminated.

## **CONCLUSION**

In the aim to increase fruit production, there is need for the development of appropriate conservation, cultivation and harvesting strategies. In that case, especially should be investigated place of origin of some wild fruit species and their relatives. Our country can be flattered with very convenient geographical position and climatic conditions so there is enormous population of very different fruit species. The economic importance of wild fruits and autochthonous (indigenous) varieties of grape can be viewed from several aspects including: reading and collecting wild fruits, as a supplementary source of income, the possibility of processing of wild fruits and wild fruits as raw materials for the pharmaceutical industry.

It is necessary to continue testing indigenous varieties of grapes and increase their production in the regions in which they showed the best results, but certainly grown in areas with similar agro-ecological conditions. It is also necessary to apply the latest technology for making wine. Very useful would be if the government provided financial support winegrowers who would be in favor of the cultivation of indigenous varieties and the production of nutritional preparations which are very useful for humans.

## REFERENCES

1. Abbink J: Meen ritual, medicinal and other plants: a contribution to south-west Ethiopian Ethnobotany. *J Ethiopian Stud.*, 26(2): 1-21., 1993.
2. Arnold C, Gillet F, Gobat JM.: Situation de la vigne sauvage *Vitis vinifera* subsp. *silvestris* en Europe. *Vitis.* 37:159–170, 1998.
3. Arnold C, Schnitzler A, Douard A, Peter R, Gillet F. (2005): Is there a future for wild grapevine (*Vitis vinifera* subsp. *silvestris*) in the Rhine Valley. *Biodiversity and Conservation.*;14:1507–1523.
4. Capasso F., Gaginella T. S., Grandolini G., Izzo A. A. *Fitoterapija- Priručnik biljne medicine*, Prometej, Novi Sad, 2005.
5. Crespan, M.: Evidence on the evolution of polymorphism of microsatellite markers in varieties of *Vitis vinifera* L. *Theoretical and Applied Genetics.*;108:231–237, 2004.
6. Getachew A, Kelbessa U, Dawit D: Ethnobotanical study of edible indigenous plants in some selected districts of Ethiopia. *Hum. Ecol.*, 33(1): 83-118., 2005.
7. Guinand Y, Dechassa L: Indigenous Food plants in Southern Ethiopia: reflections on the role of “famine foods” at the time of drought. Addis Ababa, United Nations Emergencies Unit for Ethiopia (UNEUE), 2000.
8. Kojić, M., Mratinić, E.: *Samonikle vrste voćaka Srbije*. Institut za istraživanja u poljoprivredi Srbija. Beograd, 1998.
9. Koponen, J. M., Happonen, A. M., Mattila, P. H., Törrönen, A. R.: Contents of anthocyanins and ellagitannins in selected foods consumed in Finland, *J Agric Food Chem*, 55, 1612 -1619, 2007.
10. Jaric, S., Popovic, Z., Macukanovic-Jocic, M., Djurdjevic, L., Mijatovic, M., Karadzic, B., Mitrovic, M., Pavlovic, P.: An ethnobotanical study on the usage of wild medicinal herbs fom Kopaonik Mountain (Central Serbia). *Journal of Ethno-pharmacology*, 111: 160-175, 2007.
11. Joshipura, K. J., Hu, F. B., Manson, J. E., Stampfer, M. J., Rimm, E. B., Speizer, F. E., Colditz, G., Ascherio, A., Rosner, B., Spiegelman, D., Willett, W. C.:The effect of fruit and vegetable intake on risk for coronary heart disease, *Ann. Intern. Med*, 134, 1106-1114, 2001.
12. Määttä-Riihinen, K. R., Kamal-Eldin, A., Mattila, P.H., GonzálezParamás, A. M., Törrönen, A. R.: Distribution and contents of phenolic compounds in eighteen Scandinavian berry species, *J. Agric. Food Chem*, 52, 4477-4486, 2004.
13. Lampe J. W., Health effects of vegetables and fruit: assessing mechanisms of action
14. Levadoux L.: Les populations sauvages et cultivées de *Vitis vinifera* L. *Annales de l'Amélioration des Plantes.* 6:59–117, 1956.
15. Soobrattee, M. A., Neergheen, V. S, Luximon-Ramma, A., Aruoma, O.I., Bahorun, T.: Phenolics as potential antioxidant therapeutic agents: Mechanism and actions, *Mut. Res*, 579, 200-213, 2005.
16. Hertog, M. G., Bueno-de-Mesquita, H.B., Fehily, A. M., Sweetnam, P. M., Elwood, P. C., Kromhout, D.: Fruit and vegetable consumption and cancer mortality in the Caerphilly Study, *Cancer Epidemiol. Biomarkers Prev*, 5, 673677, 1996.



17. Milenković, M.: Fenolni sastav, antioksidativna i antimikrobna aktivnost delova ploda i lišća *Prunus spinosa* L. iz Jugoistočne Srbije. Master rad. Prirodno-matematički fakultet Departman za hemiju, Univerzitet u Nišu, 2013.
18. Motlhanka, M. D., and Makhabu, W.S.: Medicinal and edible wild fruit plants of Botswana as emerging new crop opportunities. *Journal of Medicinal Plants Research* Vol. 5(10), pp. 1836-1842. Botswana College of Agriculture, Medicinal Plant Research Laboratories, Basic Sciences Department, Bag 0027, Gaborone, Botswana, 2011.
19. Mratinić, E., Kojić, M.: Samonikle vrste voćaka Srbije - Wild fruit species of Serbia Institut za istraživanja u poljoprivredi Srbija, Beograd, 1998.
20. Redzic, S.J.: Wild edible plants and their traditional use in human nutrition in Bosnia-Herzegovina. *Ecol. Food Nutr.*, 45(3): 189-232, 2007.
21. Rossetto, M., McNally, J., Henry, R.J.: Evaluating the potential of SSR flanking regions for examining relationships in Vitaceae. *Theoretical and Applied Genetics*. 104: 61–66, 2002.
22. Saka, J.D.: The nutritional value of edible indigenous Fruits: Present research and future directions. In Maghembe, J.A., Simons, A.J., Kwesiga Freddie and Rerieya Marie (eds). *Selection of indigenous fruit trees for domestication in South Africa*. ICRAF Nairobi, 1994.
23. Scalbert, A., Williamson, G.: Dietary intake and bioavailability of polyphenols in chocolate: modern science investigates an ancient medicine, *Am. Soc. Nutr. Sci.*, 2073, S-2085S, 2000.
24. Sefc, K.M., Steinkellner, H., Lefort, F.: Evaluation of the genetic contribution of local wild vines to European grapevine cultivars. *American Journal of Enology and Viticulture*. 54:15–21, 2003.
25. This, P., Jung, A., Boccacci, P.: Development of a common set of standard varieties and standardized method of scoring microsatellites markers for the analysis of grapevine genetic resources. *Theoretical and Applied Genetics*. 109:1448–1458, 2004.



## ARONIA - FRUIT FOR ECOLOGICAL GROWING

Gorica Paunovic<sup>1</sup>, M. Kulina<sup>2</sup>, R. Ilic<sup>1</sup>, Lj. Boskovic Rakocevic<sup>1</sup>, I. Glisic<sup>1</sup>

<sup>1</sup>University of Kragujevac, Faculty of Agronomy, SERBIA

<sup>2</sup>University of East Sarajevo, Faculty of Agriculture, BOSNIA AND HERZEGOVINA

### ABSTRACT

Aronia is highly valued fruit in the world, and in our country it has started to cultivate recently. Growing aronia is essentially simple. The advantages are that the aronia can be grown in different soil types, it is resistant and well tolerated to climatic change and it is very suitable to organic production. It is recommendable for cultivating because of profitable and high priced fruit, any fresh or processed, as fruits are very requested because of healing effects. The aim of this investigation is to give basic information about aronia so the production of aronia could be interesting for its producers.

**Key words:** Aronia, ORAC, flower, fruit, cultivar.

### INTRODUCTION

Aronia represents a type of fruit that is little known to us, which is widespread in natural populations in the southern parts of the United States and Canada. Due to the fact that it is submitted to very low temperatures ( $-35^{\circ}\text{C}$ ), as well as the beautiful and lush flower, to Europe it is first populated in the cooler parts of the former Soviet Union, as an ornamental bush, and, since then, it is usually called 'Siberian blueberry'.

Only later, Soviet scientists had recognized it as a valuable fruit species. In our region, aronia has arrived from Russia and Ukraine, where it has populated and grown. In addition to our areas, it is presented in Poland, also.

English name for aronia is Chokberries which means bitter berries. This name comes from its features that are hard to swallow, like with sloes or rowan, all as a result of the chemical composition of the fruit. In fact, its harshness comes from the high content of tannins and polyphenols, but because of the characteristics of many growers is called 'Russian rowan', despite the fact that her fruit reminiscent of blueberry fruit, whereas some call it 'Black rowan' [1].

Recently, this kind of fruit is grown in the world, given the increasing importance to it, primarily because of health benefits and benefits for organic farming, but also because of the fact that it is self-pollinated species. This is corroborated by the fact that, only a single bush in the garden is enough to achieve a satisfactory yield.

The oldest plantings in our country date back to 30 years ago and were erected in the vicinity of Gornji Milanovac, and all for the needs of the former plant "Takovo".

In Serbia, currently has about 150 hectares of aronia. All of these are young plantations, because aronia have been registered recently, but thanks to that it is involved to the list of fruit species and varieties for cultivation in our country [2]. Promoting the health benefits of the fruit, this fruit should create incentives for more intensive plantations chokeberry. This is exactly the aim of this work - to give basic information about aronia so the production of aronia could be interesting in the foreseeable future. Also, to attract the interest of agricultural producers and show all the benefits that can have this kind of fruit.

### CHEMICAL CHARACTERISTICS OF ARONIA'S FRUIT

Chokeberries are rich in nutrients and medicinal substances. It contains from 25-30% of dry matter, most of saccharide, 6.2 to 10.8% of the sugar, 3.0-3.1% of cellulose, 0.63 to 0.75% of pectin, the organic acid of 0.7 to 1.3%, 600-2300% of anthocyanins. The fruits are a treasure trove of macro and micro elements such as iron, calcium, copper, iodine, boron, molybdenum, manganese, potassium, and cobalt, and vitamins C, P, PP, B6, B2, E and provitamin A. But from all in the mature fruit of black chokeberry, the most important are colored matter, anthocyanins. It was found that 1480 mg of anthocyanin per 100 g of fresh products, while the concentration of proanthocyanidins was 664 mg per 100 grams. These substances are mostly placed in the epidermis and below the fruit skin [3]. They are of great importance because it protects the flesh and seeds from the harmful effects of UV radiation. In second place for its richness in anthocyanins are ripe fruits of *Rubus occidentalis* L., with about 320 mg, while *Ribes nigrum* L. has about 250 and *Rubus fruticosus* L. 205 mg per 100 g of the fruit.

Aronia is especially characterized by a high content of anthocyanins, the natural sources of color, which is appreciated in the food industry. As already mentioned above, contains a large amount of vitamin P, which is of great importance to a healthy diet. There is also big amount of the other vitamins. Thus, for example, 100 g of the fruit is sufficient to satisfy secondary needs for folic acid. In addition, aronia has a variety of minerals, primarily iron, and high content of iodine. Compared to the high sugar content, which is about 10%, the acid content of 1% is relatively low. Content of pectin matter is up to 0.75%, while the proportion of tannin decreases during ripening from 0.6% to 0.35% [4].

Mature fruits of aronia definitely make the strongest antioxidant to fight free radicals.

Anthocyanin is definitely the most powerful antioxidant, with the greatest concentration in Aronia. Aronia has 800 ORAC units, and a wild one even the 1200 ORAC units, while other types of fruits and vegetables (local fruits) value of 30 ORAC units in the berries up to maximum 353 ORAC<sup>1</sup> units in elderberry (*Sambucus nigra*), as measured in mg per 100 g of fruit [5].

The daily needs of the human body amounts to 3,000-5,000 ORAC units, enough to consume 20-30 grams of aronia berries.

---

<sup>1</sup> ORAC = "Oxygen radical absorbance capacity" -unit for measuring antioxidant capacity "(in mg per 100 g nutritious raw materials or finished products) (Source: Dr. Clarissa Gerhäuser," Krebsforschungszentrum', Heidelberg, G<sup>1</sup>ermany) -Center for research cancer ", Heidelberg, Germany.

## BIOLOGICAL PROPERTIES OF ARONIA

Black chokeberry (*Sorbus melanocarpa* Neynhold) grows as a bush of 2-2.5 meters of height and width of 1.5 meters, rarely to 3 m in height. The plant makes canes and gives bush from new canes. The bush can have up to 30 canes. The canes are thin. The leaves are ovoid, leathery, around the circumference of finely serrated and like wedge in the base part. During the autumn assume a reddish color, which makes it very decorative shrub.

It was only after the development of leaves, in late April, when the first flowers appear. Individual flowers are white, 12 mm wide and grouped in clusters. Clusters usually consist of 10 to 15, and the tops of the shoots up to 30 flowers. Flowering lasts for about 10 days, with each individual flower blossom only 5 days. In our agroecological conditions Aronia flower blossoming in early May, and it lasts about 10 days. Mainly bees pollinate flowers, but wind pollination is also possible. It is selfpollinating plant.

At last year's shoots chokeberry distinguish between vegetative and generative or gender buds. Vegetative buds are popular with branches and pointed and generative (floral) buds are rounded and move away from the branches.



**Figure 1.** Flower of Aronia

Chokeberry fruits are round, purple and red. The fruits appear regularly in large numbers. It is a small pome fruits. The diameter of a fruit is 6.0 to 13.5 mm, and weight of 1.0-1.5 g. The fruits are initially covered with a whitish coating, without which look like they were painted. The fruits ripen in August. The flesh has an intense red color and sweet to sour, astringent flavor reminiscent of blueberries. The fruit has no seeds, and the seeds are tiny and there are 5 to 8, and the average weight of one seed is about 3 grams.



**Figure 2.** Fruit of Aronia

With adequate agricultural and pomotehnics, primarily the destruction of weeds, in the tenth year of life chokeberry plant can make a contribution of about 5-10 kg per bush, or 11 to 22000 kg / ha.

The first yields can be reach in the first and second year of growing, especially in the case of two and tree year-old planted seedlings. Then forms about two clusters on the plant, with about 35-40 fruits, or about 50-100 grams yield. Thus, in the first year after planting two yers old seedlings, can be obtained from 100-200 kg of fruit per hectare. In the next vegetation bush gives 7-8 clusters, 200-300 grams per plant or 4400 to 6600 kg of fruits per hectare. Individual fruits weigh from 0.6 to 1.1 gram, so that one kilogram has about 1000-1600 fruits.

With the harvest can not be late. Ripening appearances at the end of July and the harvest can take up to a month and a half.

At the same time, the losses are very small. Only a small number of fruits get dried and waste, while the others stay normal and healthy. There is minimum of losing weight.

Water losses are compensated by supplementing plant fruit with fresh food, as long as the leaf is green and photosynthesis possible. After a while, harvested fruits get on quality, start to be sweeter and more nutritious, less pungent. If they are exposed to strong sunlight, they are drying and falling off. Their weight is even same in November: from 0.6 to 1.1 gram. Up to 30% of fruit may stay during the winter on the branches of the plant. Good yields chokeberry can expect up to 20 years of age yet.

By irrigation could be ensured high and stable yields, during years. Drought is the biggest enemy of chokeberry. Pruning branches 5-7 years old gives very good results. Wood grows slowly. It is very hard, and that characteristic comparing it with cornel. Can reach a height of 1.5 to 2.5 meters, so you can easily pick fruits from the ground. It is resistant to diseases and pests, so there is no need for any forms of protection. As such, chokeberry is an ideal plant species for cultivation in organic or bio-organic production. When plants, during 4-5 years, grow in height over one meter, then they themselves suppress weeds in the row, and space between rows can be mowed. After the tenth year, if the grass between the rows is low, does not have to be mowed, so

that orchard of aronia is a true oasis of animal world, it is an ideal habitat for birds and rabbits. Aronia is an ideal bee pasture, which is particularly evident in the period of flowering, when the orchard of white flowers chokeberry looks like snow.

### CHOOSING OF CULTIVARS

If we take into account the fact that the Aronia is relatively new fruit species, it is the logical conclusion that the varieties of Aronia are very modest. In the production there is a small number of cultivars that have been developed at Eastern and Northern Europe. The most famous are three cultivars: Viking, Nero and Moravska slatkoplodna.

Finnish cultivar *Viking* is the most cultivated in the Nordic areas in Poland. It is very vigorous, bush grows upright. For ten years bush reaches a height of about 2 m, and after 15-20 years and up to 3 m. It is very resistant to cold, which is comparable to the Nordic varieties of black currant. Early enters the period of fertility and gives high yields. Already in the third year gives 3-4 kg of fruit per bush, and in the twelfth year yield increases to 8-10 kg per bush. It ripens evenly. Individual fruits weight about 1.5 g and are working on the tips of branches, causing a bending of shoots which facilitates harvesting. They are not prone to shedding, have a firm fruit skin that makes it easier mechanized harvesting. Fresh fruits have a tart taste, like unripe blackberries. Juice smells like almonds and bitter taste. Utilization of chokeberry juice is high 75-80%, we can increase by 6%, if the fruits before juicing relieved some time at -5 ° C.

*Nero* is a Czech cultivar, which is grown mostly in Germany, Russia, Lithuania and Estonia, and recently in Poland. It is an upright bush, that grows straighter than other cultivars, and a bush reaches a height of 2 meters and a width of up to 2.5 meters. The branches are thick and nicely branched and canes (saplings which develop from the roots) and shoots (gains that develop on the overhead system) are very strong. The flowers are not only white, but in deed and pink, and the clusters are composed of 10 to 20 individual flowers. It is easily propagated. It has a high yield and fruits rich in anthocyanins and vitamin C. The fruits have a diameter of 12 mm, round shape and have a purple to blue-red color, solid wax epidermis and weight of 1.0-1.5 g. The taste is tart and sweet. Fresh juice smells like bitter almond, and the mezocarp is firm. This variety is suitable for mechanized harvesting.

*Moravska slatkoplodna* is cultivar that is originated in the Czech Republic and is similar to the varieties of Nero. It has an upright bush, but less exuberant than their predecessors. It is very fertile cultivar, full of fertility gives up to 12 kg of fruit per bush.

### AGROECOLOGICAL CONDITIOS FOR ARONIAS GROWING

Aronia has very low requirements in terms of growing place and climate, so that it can grow in very different climatic areas and can be successfully grown in areas of sharp continental climate.

Temperature - It is very resistant to low winter temperature and late spring frosts, and grows in cold areas, also. As resistant fruit species can cope with frosts of -30 ° C to -35 ° C. It is tolerant to late spring frosts, so late spring frosts are not a limiting factor. Frost certainly not harm the stem and flower.

Aronia better manage the habitats with higher soil moisture and air. Optimum precipitation is 500-600 mm a year. Aronia grows even in habitat with high groundwater levels, where other types of fruit, such as apples and cherries, fail.

Also, aronia can be successfully grown on land not suitable for growing other fruit species. Do not have special requirements of the land so it can be grown on poor, sandy and acid soils where no longer holds water or groundwater level is not high. Specifically, it is suitable for planting in less fertile soil. What we need to bear in mind is to avoid extremely dry sand, dense, moist and marshy land.

Root of chokeberry spreads very shallow in the soil, so it can be grown on those soils with a higher level of groundwater (0.7-0.8 meters below the ground surface).

The optimum pH value of land for aronia berries are from 6.0 to 6.6, corresponding to slightly acidic reaction.

If planting executed on alkaline soils, there is a problem and the impossibility of adoption of certain nutrients, such as iron, wherein appears chlorosis (leaves assumes a yellow color).

### CONCLUSION

The world cultivation of chokeberry, lately, attaching increasing importance, primarily because of the health benefits provided by this fruit species, as well as the benefits of organic farming in organic agriculture.

Production chokeberry in our country in the nearest future should attract the interest of agricultural producers to show all the benefits that can have this kind of fruit cultivation. Planting and education of potential manufacturers, will establish relations with potential customers chokeberry. In this way, open a space for the cultivation of this fruit, which would become an important resource in the further development of horticulture.

### REFERENCES

1. Kulina, M.: Sibiriska aronija (*Aronia melanocarpa* Michx.) hranljiva i lekovita voćna vrsta. Izvodi radova, 19th Meeting „Proizvodnja i plasman lekovitog, začinskog i aromatičnog bilja“, Bački Petrovac, 2012.
2. Nikolić, M., Milivojević, J.: Jagodaste voćke, tehnologija gajenja. Univerzitet u Beogradu, Poljoprivredni fakultet Beograd, 2015.
3. Mikulic Petkovsek, M., Schmitzer, V., Slatnar, A., Stampar, F., Veberic, R.: Composition of sugars, organic acids and total phenolics in 25 wild of cultivated berry species. *Journal of Food Science*, 77 (10), 1064-1070, 2012.
4. Slimestad, R., Torskangerpoll, K., Nateland, H., Johannessen, T., Giske, N.H.: Flavonoids from black chokeberries, *Aronia melanocarpa*. *Journal of Food Composition and Analysis* 18, 61-68, 2005.
5. Oszmiański, J., Wojdyło, A.: *Aronia melanocarpa* phenolics and their antioxidant activity. *European Food Reserch Technology*, 221, 809-813, 2005.



## INFLUENCE OF ARTIFICIAL INFESTATION WITH WCR EGGS ON MAIZE ROOT DAMAGES AND BIOMASS

Snezana Tanaskovic<sup>1\*</sup>, B. Popovic<sup>1</sup>, S. Gvozdenac<sup>2</sup>,  
Zs. Karpati<sup>3</sup>, C. Bognar<sup>3</sup>, M. Erb<sup>4</sup>

<sup>1</sup>University of Kragujevac, Faculty of Agronomy, Cara Dusana 34, Cacak, SERBIA

<sup>2</sup>University of Novi Sad, Faculty of Agriculture,  
Trg D. Obradovića 8, Novi Sad, SERBIA

<sup>3</sup>Plant Protection Institute Hungarian Academy of Sciences, Department of Zoology,  
Budapest, HUNGARY

<sup>4</sup>University of Bern, Institute of Plant Sciences, Functional Plant Biology,  
SWITZERLAND

\*stanasko@kg.ac.rs

### ABSTRACT

The Western corn rootworm (WCR), *Diabrotica virgifera* sp. *virgifera* (Col., Chrysomelidae), is an important maize pest, which was, in Europe, first identified in Serbia, 1992. Field experiment was carried out in Bečej, during 2015. In field 96 plants (maize cultivar NS 640) arranged in 48 pairs were selected. Each pair consisted of one plant artificially infested with WCR eggs (D plant) and the control plant (C plant). Root damages were assessed according to 1-6 scale and biomasses were measured at the end on the experiment, in September. The results indicate that statistically more damaged roots were on infested plants. However, according to Kruskal-Wallis test, the difference between root biomasses was not statistically significant.

**Key words:** WCR, root, artificial infestation, volumes, damages.

### INTRODUCTON

Western corn rootworm (WCR) *Diabrotica virgifera* sp. *virgifera* Le Conte (Col., Chrysomelidae) is an oligophagous pest, originating from America [1]. It is an invasive species in Europe. The first identification of WCR in Europe was near the Belgrade airport, Serbia in the early 90's [2], and from that point forward, the pest spread to almost every maize field in Europe [3]. WCR is a very dangerous pest because it attacks roots (larvae) and also the above-ground parts of maize (adults) [4]. Feeding on maize roots, WCR larvae, causes the most important damages in the field [5, 6]. The presence of larvae in the field cause the loss of root tissue thus disturb water and nutrients uptake [7]. WCR caused root damages have the significant effect on nutrient assimilation in maize plants and grains [8]. WCR larvae are feeding on the nodal and lateral roots [9]. In the field, one of the main symptoms that indicate the presence of

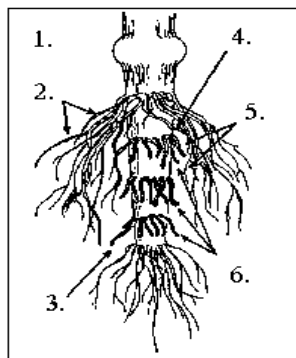


WCR larvae is called goose neck (GN) [7, 5]. Also, plant lodging is an obvious symptom of WCR infestation and it can lead to physiological and mechanical disorder [1]. Well-developed root system, plant lodging and the amount of secondary roots are the indicators of maize tolerance to WCR [10]. According to [11], larger and more developed root system is a measure of higher tolerance of maize to WCR roots injury, but also decreased lodging [12]. Damages caused by WCR larvae are highly depended of soil moisture, the soil type and the larval abundance in soil [4]. Environmental conditions also have strong influence on the level of root damages [13].

## MATERIAL AND METHODS

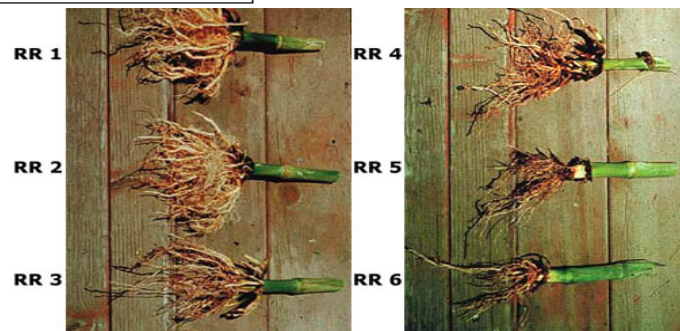
The field experiment was carried out in Bečej, Vojvodina province, Serbia, from May 30<sup>th</sup> to September 10<sup>th</sup> 2015, with cultivar NS-640. The field chosen for experiment represents field with low natural WCR infestation.

Prior to the experiment set up, 96 maize plants were selected, labeled and arranged into pairs. The plants are set up in two rows with a distance of 1 m between labeled plants. In each pair consisted of one artificially infested plant (D plants) and a control plant (C plant). D plants were infested with 4 mL of WCR eggs in 0.125% agar suspension by injecting the solution in the root zone. One mL of suspension contains 136 WCR eggs. In root zone of C plant the same amount of distilled water (4 mL) was injected.



Root rating scale (Ostlie and Notzel, 1987)

- 1 - No feeding damage
- 2 - Visible feeding scars present
- 3 - At least one root chewed to within 1.1/2 inches of plant
- 4 - One entire node of roots destroyed
- 5 - Two nodes destroyed
- 6 - Three or more nodes destroyed



Picture 1. Root damage scale [14]

During the last field inspection in September we evaluated the damages of maize root causes by WCR larvae. The root inspection was conducted as follows: all marked plants were dugged up, the soil was shaken, and rinsed off. After the preparation, root damage is evaluated according to 1 to 6 scales [14]. The biomass of roots was measured on a technical balance (Kern EW 1500-2 M).

The differences between number of damaged D and C plants, as well as in biomass was tested using non parametric Kruscal-Wallis test, for the confidence interval of 95%.

## RESULTS AND DISCUSSION

The results in our experimental field indicate at bigger damages of (D) plants (figure 1) according to Ostlie and Notzel (1987) root damages scale. Of total 48 D plants only four (8.3%) were with healthy root system (rate 1). The majority of infested plants, 18 D plants (37.5%) were with high root damages (rate 6), 8 D plants (16.7%) were with visible damages causes by larvae (rate 2), and seven D plants (14.6%) were with at least one root chewed to within 3.8 cm (1½ inches) of plant (rate 3) and 11 plants (22.9%) were with one entirely destroyed node (rate 4). D plants with two nodes destroyed (rate 5) were not recorded in the experimental field

Among C plants, out of 48 plants, 25 were with healthy roots (rate 1) or 52.1%. Only two C plants (4.2%) were with three or more nodes destroyed (rate 6), three plants (6.25%) had visible damages caused by larvae (rate 2), nine plants (18.75%) were with at least one root chewed to within 3.8 cm (1½ inches) of plant (rate 3), only one plant (2.1%) was with one entire destroyed node (rate 4) and eight plants (16.7%) were with two nodes destroyed (rate 2), (figure 1).

Infestation with WCR eggs caused damages on 95.7% of infested plants, but at different rates. The inspection of C plants showed that 52.1% was evaluated as rate 1 (healthy root system). The presence of WCR in maize monoculture can cause increase of yield losses by plant lodging of 3-15% of plants [15]. In extremely high abundance WCR larvae can cause lodging up to 75% of plants [16].

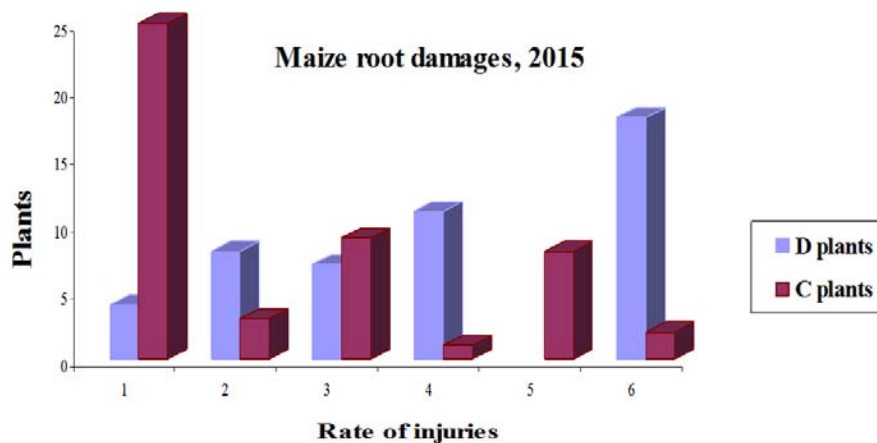
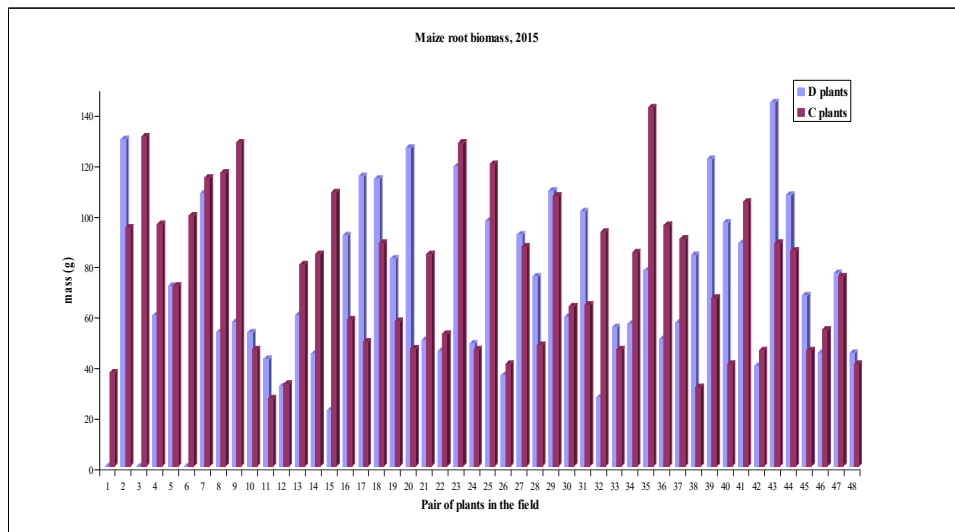


Figure 1. WCR root damages in 2015

During 2015 in our experiment artificial infestation caused damages on 47.9 % of C plants. This is in accordance with the literature data indicating that mobility of WCR larvae in soil is less than 50 cm [17].

Although the level of root damages was very high, the differences in root mass between D and C plants were not statistical significant.

The results of root biomass measuring are presented in the Figure 2. The smallest measured root biomass of C and D plants were 26.88 g and 22.17g, respectively. The highest root biomass of C and D plants were 142.2g and 144.4g respectively. The average values of root biomass of C and D plants were 75.94g and 69.62 g respectively. According to Kruskal-Wallis test there is no significant differences between root biomass of infested and control maize plants. These results also indicate a possible maize tolerance to larvae attack on root system.



**Figure 2.** Maize root biomass in 2015

Inspection of the rest of the field indicate at the presence of 6 % of natural WCR infestation, i.e between 100 randomly chosen plants in the row, we detected six plants with the goose neck symptoms. In experimental field, we recorded 24 GN plants between infested and neighboring plants. Between them are 8 islands or patches with 2-4 plants. In 5 patches were D and plant from left and right sides of D plant. According to these results there is no rule of movement WCR larvae in the soil.

WCR shows tolerance to several control measures including cultivation practices and pesticides control [18, 19]. The main reason for the spread of WCR in maize field is the monoculture [20]. Maize monoculture contributes to an increase in WCR population abundance and to plant damages causes by this pest [21]. As mentioned, the maize monoculture favors the reproduction and the spread of WCR, so today the biggest damages and losses are in such mode of cultivation.

In our country, WCR also causes the biggest damages in maize fields in monoculture. Since larval mobility is less than 50 cm, they are not able to survive in soil cultivated with other crops [16]. Root larval attack can be reduced to minimum by crop rotation. One of the reasons for the reduced plant growth and yield of maize can be larval feeding with root system [22, 23].

Root tolerance is associated with maize ability to develop new roots after larval injury [10]. The greater root regrowth and the larger root system are the primary maize defense mechanism is stronger [12]. Tolerance is the ability of the roots to develop despite the injuries caused by WCR larvae [24, 25]. According to [9], WCR damages which cause the reduction of root system by 25 % can decrease plant growth.

During our further research we intend to monitor the effect of WCR artificial infestations on yield and the damages on maize plants caused by larvae but also adults.

#### **Acknowledgement:**

*These results are the part of SCOPES project "Understanding plant-mediated interactions between two major maize pests of Eastern Europe - From phytochemical patterns to management recommendations". Project No. IZ73Z0\_152313/1 project.*

#### **REFERENCES**

1. Tollefson J.J.: Evaluating maize for resistance to *Diabrotica virgifera virgifera* Leconte (Coleoptera:Chrysomelidae) Department of Entomology, Iowa State University, 110 Insecary Bldg., Ames, IA 50011, USAMaydica 52, 311-318. (2007).
2. Bača, F.: New member of harmful entomofauna of Yugoslavia *Diabrotica virgifera virgifera* Le Conte (Coleoptera: Chrysomelidae). IWGO, News Letter, vol. XII(1-2), 21. (1993).
3. Hummel, H.E., Dinnesen, S., Nedelev, T., Modic, S., Urek, G., Ulrichs, C.: *Diabrotica virgifera virgifera* LeConte in confrontation mood: simultaneous geographical and host spectrum expansion in southeastern Slovenia. Mitt. Dtsch. Ges. allg. angew. Ent 16: 127 – 130. (2008).
4. Ciobanu, C., Șandor, M., Ciobanu, G., Domuța, C., Samuel, A. D., Vușcan, A., Chereji, I.: Research regarding *Diabrotica virgifera virgifera* Le Conte (The Western Root Worm) control in sustainable agriculture. Romanian Agricultural Research No 26, pp.79-84. (2009)
5. Wesseler J. and Fall E.H., : Potential damage costs of *Diabrotica virgifera virgifera* infestation in Europe – the “no control” Scenario. Online at <http://mpira.ub.uni-muenchen.de/33231/> MPRA Paper No. 33231. (2010).
6. Ivezich, M., Raspudich, E., Majich, I., Tollefson, J., Brmez, M., Sarajlich, A., and Brkich, A.: Root compensation of seven maize hybrids due to Western Corn Rootworm (*Diabrotica virgifera virgifera* Leconte) Larval injury. Bulgarian Journal of Agricultural Science, 17 (No 1) 2011, 107-115 Agricultural Academy. (2011).

7. Chiang, H. C.: Bionomics of the northern and western corn rootworms. Annual Reviews of Entomology, 18: 47-72. (1973).
8. Kahler, A.L., Olnese, A.E., Sutter, G.R., Dybling, C.D., and Devine, O.J.: Root damage by western corn rootworm and nutrient content in maize. Agron. J. 77: 769-774. (1985).
9. Gavlovski, J.E., Whitfield, G.H., and Ellis, C.R.: Effect of larvae of Western corn rootworm (Coleoptera: Chrysomelidae) Mechanical Root Pruning on Sap Flow and Growth of Corn. J. Econ.Entomol. 85(4): 1434-1441 (1992).
10. Gray, M.E., and Steffey, K.L.: Corn Rootworm (Coleoptera: Chrysomelidae) Larval Injury and Root Compensation of 12 Maize Hybrids: an Assessment of the Economic Injury Index. J. Econ. Entomol. 91(3): 723-740. (1998).
11. Branson, T.F.: Larval feeding behavior and host plant resistance in maize, pp.159-182. In J.L. Krysan and T.A. Miller [eds.], Methods for the study of pest Diabrotica. Springer, New York. (1986).
12. Riedell, W.E., and Evenson, W. E.: Rootworm feeding tolerance in single-cross maize hybrids from different eras. Crop Sci. 33: 951-955. (1993).
13. Spike, B. P. and Tollefson, J. J.: Relationship of root ratings, root size, and root regrowth to yield of corn injured by western corn rootworm (Coleoptera: Chrysomelidae). Journal of Economic Entomology, 82: 1760-1763. (1989).
14. Ostlie, K., and Notzel, D.: Managing corn root worms, Minnesota Extension Service, University of Minnesota, AG-FO 3281, pp. 1-4. (1987).
15. Čamprag, D.: Integralna zaštita kukuruza od štetočina. Štamparija „Feljton“, Novi Sad, str. 534. (1994).
16. Chiang, H. C. and Flaskerd, R. G.: Northern and western corn rootworms in Minnesota. J. Minnesota Acad. Sci., 36, 1: 48-51. (1969).
17. Bača, F., Lopandić, D., Stojčić, J., Živanović, D.: The results of monitoring *Diabrotica virgifera virgifera* Le Conte in 1998. In Republika Srpska “Western Corn Rootworm 98” 3 rd FAO WCR/ICP Meeting 4th Meeting of the EPPO and ad hoc Pand and 5th Internacional IWGO Workshop on *Diabrotica virgifera virgifera* Le Conte, 27-29 October, Rogaska Slatina, Slovenia, Abstract: 21-22. (1998).
18. O’ Neal, M., Gray, M., Spencer, J., Steffey, K., Levine, E.: Western corn rootworms in corn after soybeans: effort towards an economic threshold. Illinois Agric. Pest. Conf., Univ. of Illinois, Jan.: 66-72. (1977).
19. Wright, R. J., Scharf, M. E., Meinke, L. J., X. Zhou, X., Siegfried, B. D., and Chandler, L. D.: Larval susceptibility of an insecticide-resistant western corn rootworm (Coleopteran: Chrysomelidae) population to soil insecticides: laboratory Bioassays, assays of detoxification enzymes, and field performance. Journal of Economic Entomology, 93: 7-13. (2000).
20. Levine, E., Spencer, J. L., Isard, S. A., Onstad, W. D., and Gray, M. E.: Adaptation of the western corn rootworm to crop rotation: evolution of a new strain in response a management practice. American Entomology, 48: 94-107. (2002).

21. Chiang, H. C., Sisson, V., and Rasmussen, D.: Conversion of results of concentrated samples to density estimates of egg and larval populations of the northern corn rootworm. *J. Econ. Entomol.* 62: 578-583. (1969).
22. Sivcev, I., Stankovic, S., Kostic, M., Lakic, N., Popovic, Z.: Population density of *Diabrotica virgifera virgifera* LeConte beetles in Serbian first year and continues maize fields. *Journal of Applied Entomology*, 133: 430-437. (2009).
23. Godfrey, L.D., Meinke, L.J., Wright, R.J.: Field corn vegetative and reproductive biomass accumulation: response to western corn rootworm (Coleoptera: Chrysomelidae) root injury. *Journal of Economic Entomology*, 86, 1557-1573. (1993).
24. Ivezich, M., Tollefson, J.J., Raspudich, E., Brkich, I., Brmez, M., Hibbard, B.E.: Evaluation of corn hybrids for tolerance to corn rootworm (*Diabrotica virgifera virgifera* LeConte) larval feeding. *Cereal Research and Communication*, 34: 1001-1007. (2006).
25. Painter, R.H.: *Insect resistance in crop plants*. Univ. Press of Kansas, Lawrence, KS. (1951).



**EFFICACY OF Voliam Targo 063 SC IN SUPPRESSION  
*Cydia pomonella* ACCORDING TO CAS**

**Snezana Tanaskovic<sup>1\*</sup>, G. Draskovic<sup>1</sup>, M. Marjanovic<sup>1</sup>, S. Gvozdenac<sup>2</sup>**

<sup>1</sup>University of Kragujevac, Faculty of Agronomy in Čačak, SERBIA

<sup>2</sup>University in Novi Sad, Faculty of Agriculture, D. Obradovica 8,  
21 000 Novi Sad, SERBIA

\*[stanasko@kg.ac.rs](mailto:stanasko@kg.ac.rs)

**ABSTRACT**

The aim of this study was to determine the biological effects of insecticide Voliam Targo 063 SC in suppression of codling moth near Čačak. The experiment was set up in Miokovci village, Serbia, according to the requirements of EPP0 PP 1/7 (3) standards and rules of crop adapted spraying (CAS). After application of the insecticide, based on the on the critical number of caught moths in population monitoring by pheromone traps during vegetation 2014, we can conclude:

- CAS concept is highly applicable in Serbian orchards;
- CAS concept provides rationalizes of insecticides;
- Voliam Targo 063 SC applied by CAS concept provides excellent control of *Cydia pomonella* populations.

**Key words:** *Cydia pomonella*, CAS approach, Voliam Targo 063 SC, pheromone traps.

**INTRODUCTION**

The codling moth (CM) - *Cydia pomonella* L. (Lepidoptera: Tortricidae) is economically the most important pests of apples worldwide [1]. It represents a limiting factor in production, because it decreases profitability of apple orchards due to decline of market value of infested fruits.

For the Čačak municipality, apple production has high economical significance. In the municipality area, around 642.6 ha or 4.48 % of the state total area is under apple production, with 603087 apple trees or 3% of total number of apple trees in Serbia [2]. Apple is the second most abundant fruit species in this region. Potential yield is estimated at about 12000 tons per year and represents 5% of the total apple production in the Republic of Serbia [2]. This data are consequence of biological potential of planted varieties and applied horticultural measures in orchards.

In the second half of the 20th century, suppression of CM was achieved intensively by organophosphorus insecticides. At the end of this period, the resistance of CM populations was registered in several production regions [3, 4, 5, 6, 7].

Market demands for high quality apple fruits request integral approach in CM control [8]. The lack of monitoring during vegetation and tricky quality of pheromone traps represent the main reasons of insufficient effectiveness in CM control [9].

The aim of this study was to determine the biological efficacy of insecticide Voliam Targo 063 SC, as suppressing agent for CM, when applied according to the CAS rules (Crop Adapted Spraying). The use of CAS method in insecticide application represents new approach of application in Serbian orchards. This method provides the possibility to adapt the consumption of carrier volume to the requirements of an orchard.

## MATERIALS AND METHODS

**Location:** The experiment was set up in 2014 near Čačak, in the locality of Miokovci (GPS : N 43 ° 57 '0 " , E 20 ° 15' 14.4"). Village is situated in the valley of the river Čemernica, at an altitude of about 350 meters, (Fig. 1). In the orchard, apple varieties are: Golden Delicious, Jonagold, Red Chief and Mutsu. Golden Delicious, Mutsu and Jonagold are planted on M9 rootstock, Red Chief the rootstock MM106.



**Figure 1.** Map of the Čačak municipality, with marked experimental locality (orig.)

**Methods.** The experiment was set according to EPPO PP 1/7 (3) standard. According to the requirements, insecticide time spraying is determined by the critical



number of CM adults caught in pheromone traps in the orchard. Applications of insecticide were carried out according to the CAS, which is in compliance with the good agricultural practices (GAP).

**Pheromone trap** used in the experiment is Csalomon, product of Plant Protection Institute in Budapest, Hungary. The trap was placed in the 3rd orchards row, on 9th May 2014, in the upper part of the crown zone. Sticky bases were inspected weekly. Each time, the number of caught CM male was counted, until 28th August 2014. Type, time and frequency of assessment were done according to the requirements of EPPO PP 1/7 (3) standards, i.e. 7, 14, 21, 30, 60, 90 days after the treatment (DAT) and fruits were harvested on 10th September 2014. In the field, all abscised fruits from the marked trees were collected and the% of CM attacked fruits was determined in the laboratory of Faculty of agronomy in Čačak by longitudinal cutting of apples.

**Insecticide** Voliam Targo 063 SC, registered on the Serbian market [10] was used. Insecticide is a combination of two active ingredients: chlorantraniliprole (45 g L<sup>-1</sup>) and abamectin (18 g L<sup>-1</sup>).

**Insecticide spraying.** CAS method allows the modulation of water amount during spraying [11]. To calculate the level of a carrier i.e. water, it is necessary to calculate the volume of the row, TRV (Tree row volume).

TRV - Step 1: Measuring the row volume TRV (m<sup>3</sup>ha<sup>-1</sup>). The effective volume of the row is calculated using following formula:

$$TRV = \frac{H \times W \times 10000 \text{ m}^2}{R} \text{ m}^3 \text{ ha}^{-1}$$

TRV - Step 2: Adopting dose rate (L ha<sup>-1</sup> or kg ha<sup>-1</sup>). Calculate adapted amount of dose rate performed on the basis of the form:

$$\text{L ha}^{-1} \text{ or kg ha}^{-1} = \frac{\text{Label rate L ha}^{-1} \text{ or kg ha}^{-1}}{2} + \frac{\text{Label rate L ha}^{-1} \text{ or kg ha}^{-1} \times \text{Calculated TRV m}^3 \text{ ha}^{-1}}{2 \times \text{Referent TRV m}^3 \text{ ha}^{-1}}$$

## RESULTS AND DISCUSSION

Calculating water consumption and the application rate done according to the CAS method. The measured parameters are essential in the orchards and are required to calculate the row volume, as follows:

H - Crown height (total height - height of branching = 2.1 m)

W - Crown width (measured at half the height of the crown = 0.6m)

R – Inter-row spacing (distance between two rows = 3.8m)

Measured TRV in the experimental apple orchard is necessary to calculate the adapted rate of insecticide preparation for application in the next step.

To calculate the insecticide rate per unit area obtained by the TRV (data from step 1) and use the labeled dose (the recommended application rates 0.75 - 1.1 L ha<sup>-1</sup>) and the reference TRV (standard value -TRV 10000 m<sup>2</sup>), namely:

$$\text{Lha}^{-1} \text{ or } \text{kg} \text{ha}^{-1} = \frac{0.75 \text{Lha}^{-1}}{2} + \frac{0.75 \text{Lha}^{-1} \times 3315 \text{m}^3 \text{ha}^{-1}}{2 \times 10000 \text{m}^3 \text{ha}^{-1}} = 0.375 \text{Lha}^{-1} + 0.1243 \text{Lha}^{-1} = 0.4993 \text{Lha}^{-1} \approx 0.5 \text{Lha}^{-1}$$

The obtained value represents the modulated (adapted) amount of insecticide per unit area of 1 ha. A necessary quantity for experimental plot is  $0.170 \text{ L ha}^{-1}$  i.e.:

$$0.3315 \text{ha} \times 0.5 \text{L ha}^{-1} = 0.166 \text{ L ha}^{-1} \approx 0.170 \text{ L ha}^{-1}$$

### Spraying and the efficacy of insecticides

CM flight dynamics was monitored from 9 May to 28 August (Fig. 2). The first threshold was registered on 17th May 2014, with 28 caught specimens. This number indicates at condition that needs urgent application of insecticides. The application was made on 21<sup>st</sup> May 2014. The spraying was carried out by tractor trailed rotary atomizer. The consumption of water in working mixture was according to the CAS method. The application rate of Voliam Targo 063 SC ( $0.170 \text{ L ha}^{-1}$ ) was diluted in 300 L volume of water.

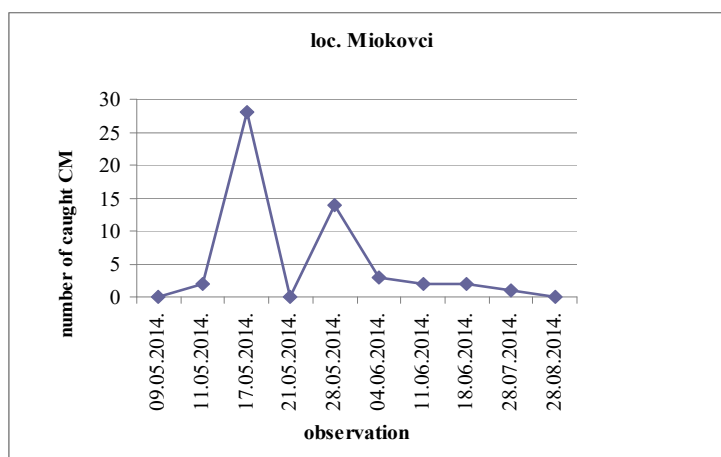


Figure 2. Monitoring of codling moth in 2014, loc. Miokovci (orig.)

Fruits were collected under the trees prior to the application of insecticide. A total of 450 fruits was collected and inspected (Table 1). The level of initial infestation varied significantly in the experimental field between plots (Table 1).

**Table 1.** Level of infested fruit during the inspection in the orchard

plot	DAT				
	21.05.	7	14	60	90
I	2.22	5.23	1.43	0	0
II	9.16	8.33	1.45	0	0
III	1.01	1.59	0	0	0
IV	-	4.25	0	0	0
κ	-	11.11	0	0	0

According to the results, no damaged fruits were registered under the untreated (control) trees and in the of the IV plot. In the remaining three plots the level of damages ranged from 1 to 9%, and indicates a different preference determined by the varieties in the orchard. These differences may be the result of different levels of fertility and plant physiological response to the extreme conditions during May 2014.

After the application of insecticide eight inspections were done, May 28th, 4th, 11th, 18th and 28th June, 28th July, 28th August and 10th September 2014. In the first inspection 7 DAT the increase of damaged fruits was registered (tab. 2). The highest increase was recorded in the control block and IV plot. In the remaining plots the level of damaged fruits was the same level of significance as in the previous control.

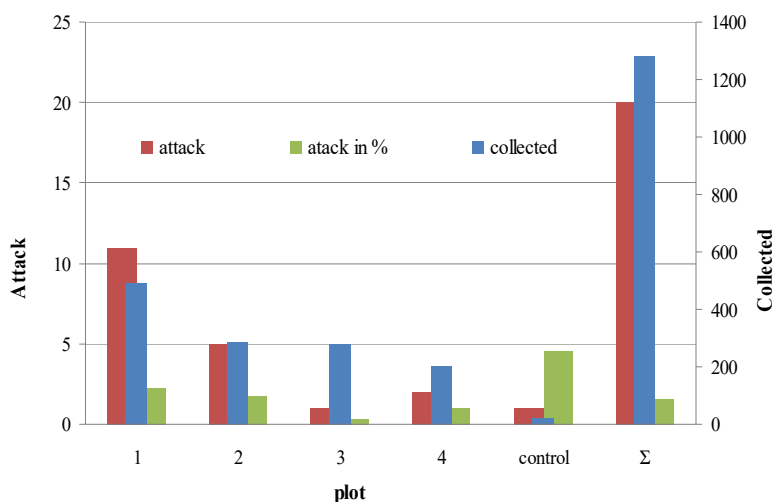
During the visual inspection on 28th May, the catch of CM adults on sticky bases was above the economic threshold (14 specimens), which required repeated treatment with Voliam Targo 063 SC. This indicates that applied in rainy conditions (>60 mm per day), unusual for the May did not achieve satisfactory efficacy of CM population. The weather conditions in May probably influenced the flight of overwinter population and prolonged eclosion period of moths. The general opinion is that the insects are in diapause or provoked interruption of development in conditions of heavy rain and temperature decrease. Also, the part of that illusion is that flying insects stay still and do not eclose or hatch. The data obtained by pheromone traps deny such statement and point out the necessity of continuous monitoring and surveillance during entire season.

During observation on 14 DAT a high decrease in a number of damaged fruits was recorded in all collected samples (Table 1).

The results of the first and second inspection indicate high level of efficacy of the applied insecticide, based on the levels of infestation.

On 11, 18 and 28 June, the abscised fruits were collected, but the larval injuries on fruits were not registered. Number of collected fruits was 326, 85 and 98 fruits, respectively.

Observations carried out one and two months after the application of the insecticide indicate the absence of CM caterpillars in fruits (fig 3).



**Figure 3.** The collected and attacked fruits

During the experiment, the number of collected and infested was the highest in the untreated plot (graph 2) i.e. 4.54%. In the treated plots the highest injury level is registered in 1<sup>st</sup> plot - above the acceptable threshold of 2%. However, this could be a consequence of higher level of infestation before the spraying.

Voliam Targo 063 SC achieved satisfactory control of the CM. Registered damaged level of fruits was below the economic injury level or economic threshold.

Harvest was carried out on 10th September 2014. In four plots and the control, a total of 450 fruits per plot were checked. At the same time, the visual inspection of each harvested fruit was carried out. Ijured or infested fruits was not detected.

### CONCLUSION

In the vicinity of Čačak, in 2014, the efficacy of insecticide Voliam Targo 063 SC in suppression of *C. pomonella* population was assessed. Insecticide was applied according to CAS method. Application time was determined by the flight monitoring dynamics of CM. Obtained results of biological effects of insecticide indicate that the CAS concept of insecticide application is applicable in Serbian orchards and provides economization of insecticides. In these conditions, insecticide application according to CAS methods, Voliam Targo 063 SC provides satisfactory suppression of CM population in orchard.

### REFERENCES

1. Neven, L. G. and Hansen, L. D.: Effects of temperature and controlled atmospheres on codling moth metabolism. *Annl. Ent. Soc. Am.*, 103: 418–423. (2010).

2. Anonymous: Voćnjaci i površine pod bobičastim voćem. [http://popispoljoprivrede.stat.rs/?page\\_id=6221](http://popispoljoprivrede.stat.rs/?page_id=6221) (2012).
3. Varela, L. And S. C. Welter, V. P. Jones, J. F. Brunner and H. Riedl.: Monitoring and characterization of insecticide resistance in codling moth (Lepidoptera: Tortricidae) in four western states. *Journal of Economic Entomology*, 86: 1-10. (1993).
4. Knight, A. L., J. F. Brunner, and D. Alston: Survey of azinphosmethyl resistance in codling moth (Lepidoptera: Tortricidae) in Washington and Utah. *Journal of economic entomology* 87(2), 285-292. (1994).
5. Sauphanor, B. and J. C. Bouvier (1995): Cross-resistance between benzoylureas and benzoylhydrazines in the codling moth, *Cydia pomonella* L. *Pesticide Science* 45(4), 369-375.
6. Tanasković Snežana, Milenković, S., Sretenović Dušica: Ispitivanje efikasnosti Avaunta 15<sup>®</sup> SC i Neem - Azala na suzbijanju *Lymantria dispar* L. (Lepidoptera, Lymantridae). X Savetovanje o biotehnologiji; vol.10, br.10, 269-275, Čačak. (2005).
7. Stará J., Nad'ová K., Kocourek F. (2006). Insecticide resistance in the codling moth (*Cydia pomonella*). *Journal of Fruit and Ornamental Plant Research* 14(3): 99-106.
8. Prokopy, R. J., S. A. Johnson, M. T. O'Brien, and M. T. O'Brien: Second-stage integrated management of apple arthropod pests. *Entomologia experimentalis et applicata* 54(1), 9-19. (1990).
9. Milenković, S., Krnjajić, S., Tanasković Snežana (2002): Štetočine jabuke - savremeni pristup suzbijanju. *Zimska škola za agronome, zbornik radova*; vol.6, br.6, 117-123.
10. Savčić-Petrić, S.: Sredstva za zaštitu bilja u prometu u Srbiji. *Biljni lekar*, 43(1-2): 15-257. (2015).
11. Deveau J.: Crop Adapted Spraying Project Results to date. <http://www.omafra.gov.on.ca/english/crops/hort/news/orchnews/2015/on0215a4.htm> (2015).



## **ECONOMIC CONTEXT OF ORGANIC AGRICULTURE AND FARMS IN SERBIA-CASE STUDY**

**Slobodan Neskovic**

University Business Academy in Novi Sad, SERBIA

*slobneskovic@gmail.com*

### **ABSTRACT**

The economic context of organic agricultural holdings and conglomerats includes several parameters and postulates of importance for economic operators and the country. Organic agriculture has many advantages over conventional especially in the area of human health which affirms the commitment of agricultural production. Organic agriculture is associated with the multifunctional character of agriculture and to the preservation of villages, traditions, folk culture, traditional crafts, rural tourism and special type ie. eco-tourism. Consumers underdeveloped awareness, the underdeveloped market, low demand and low standard of living, high prices of control and certification, lack of use of pesticides, are just some of the many problems faced by manufacturers in this field of agriculture. Serbia has significant resources for development of agricultural production, which represents the country's export opportunity.

**Key words:** Economy, organic agriculture, farms, food, Serbia.

### **INTRODUCTION**

Agricultural area is an extremely important natural resource for agricultural production and people's life. Research has shown steady growth in demand for organic food and beverages in the world market. The goal of organic agriculture is the production of high quality and safe food in an environmentally sustainable manner. Such production improves the health and productivity of interdependent communities - people, animals, plants and soil. The advantages of organic production compared to conventional are numerous, and the data of the competent authorities show constant growth of organic production and interest in this area. Serbia is also more present in this type of production due to available land that is not contaminated. The organic method of production has great economic importance and may contribute to the development of rural areas, and thus the entire agriculture.

### **METHODS AND RESULTS**

The main problem of this study is to analyze the importance of organic production, both in the modern world and in our country. The protection and enforcement of innovation as indispensable factors and sources of the creation of agricultural development is a prerequisite of competitive advantage in modern organic agriculture.

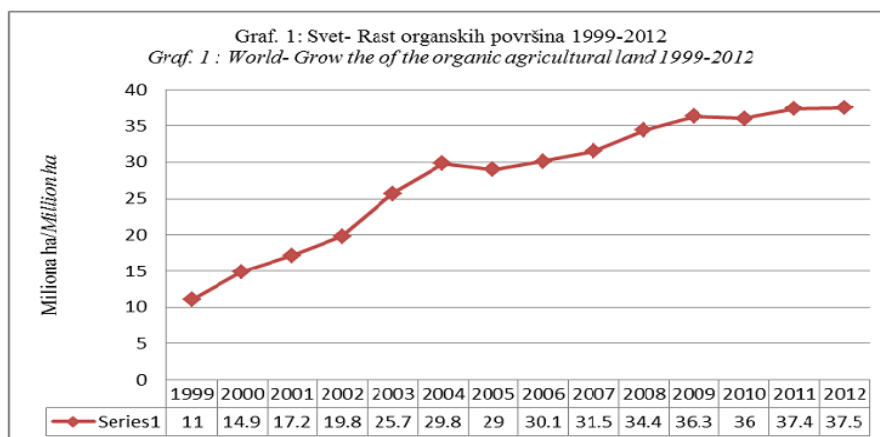
The subject of this research is conjunctive relationship between organic production and overall national economic development and competitive advantages in the modern world. Competitive advantage, and consequently agricultural development does not exist outside the framework of globalized market, at the same time closely associated with intellectual capital and innovation process and their strategic management. Given the importance of agriculture to the economic development of the country aim of this research is the description of the direct connections and conditioning of organic production and quality management in sector of agriculture in Serbia.

The purpose of this paper is to highlight the importance of the development of organic farming, production and innovation in organic farming are there in the realization of the development of agriculture and hence competitiveness in the globalized market conditions.

### ECONOMIC CONTEXT OF ORGANIC AGRICULTURE IN SERBIA

According to the definition of the International Federation of Organic Agriculture Movements (IFOAM), organic agriculture is a holistic production system that promotes the natural activity in the soil, maintains the health of ecological systems and humans, relies on ecological processes, biodiversity and natural cycles, taking into account local conditions, to the exclusion of inputs with harmful effects. Organic production methods relating to the use of natural substances and processes in the production and eliminate or limit the use of synthesized funds.<sup>2</sup>

Size of land area under organic production in the world is constantly growing in the period from 1999 - 2012 and has increased more than threefold. The value of organic products in the world market reached a value of about 50 billion euros, and in 2000. amounted to 13.6 billion euros.<sup>3</sup>



**Graphic 1.** Growth of organic area in world for the period 1999 – 2012.

Source: FiBL –IFOAM (2014)

<sup>2</sup> Neskovic, S., Ecological management, Belgrade, College PEP, 2010, pp. 15.

<sup>3</sup> National Action Plan for the development of organic production for the period 2014 - 2019, Ministry of Agriculture and Environment of Republic of Serbia, pp 6-7.

In Serbia, the organic area increased approximately fourteen times compared to 2008, when began to keep a record of organic production in the Ministry of Agriculture and Environmental Protection. In parallel with the surface, increasing the value of organic products, in the last fifteen years has increased more than three times. In the EU, 70% of the value of agricultural production makes animal production, while 30% comes from the structure of plant production. For us the situation is reversed, 30% is animal production, a 70% value makes the vegetable production. In Gross National Product agricultural production accounts for about 11.9% of which about 7.7% were agriculture, forestry and fisheries and the food industry 3.3%. The most important agricultural products of Serbia, according to data of the Serbian Chamber of Commerce are: corn, wheat, sunflower, sugar beet, soya beans, potatoes, apples, plums, grapes, and also pork, beef and milk.

In Serbia there are two basic types of organic producers:

- independent, who have a direct contract with one of the control organizations and
- subcontractors, whose production is subject to group of producers, so that the the entire production is intended for export markets, while they have secured the support of: inputs, training, certification costs covered, where the holder of the certificate is company and not the manufacturer.<sup>4</sup>

In 2014, organic production in Serbia is realized on a total area of 9,430 ha, if you include the products that are already certified or are in the process of obtaining certification. In 2013, organic farming was taking place on a total area of 8,227 ha. The increase in area in the amount of 14.6% compared to 2013, confirms the interest of producers for this type of agricultural production. According to the Ministry of Agriculture and Environment, of the total number of organic producers in Serbia is 1,867, of which 292 are certified for organic production, while the number of subcontractors is 1,575. In 2014, the most common is organic grain production, in the amount of 35%, followed by fruit production in the amount of 28%, industrial and forage crops in the amount of 15%, vegetables in the amount of 2%, medicinal and aromatic plants in the amount 1%, and other crop production in the amount of 4%. Data on organic production by region show that in Vojvodina most common this type of production, in the amount of 66%, followed by the region of Southern and Eastern Serbia, in which the organic production represented 23% of arable land, region of Šumadija and Western Serbia with 11% .

---

<sup>4</sup> Kalentić M., Stefanović E., Simić I., Maerz U., *Organska poljoprivreda u Srbiji*, Beograd: Nacionalno udruženje za razvoj organske proizvodnje Serbia organica, 2014., p. 12.



**Table 1.** Representation of the area under organic production in the regions in Serbia in 2014

REGIONI	OBRADIVA POVRŠINA	UČEŠĆE(%)
Beograd	18,9	0
Šumadija i zapadna Srbija	1.018,3	11
Južna i istočna Srbija	2.151,7	23
Vojvodina	6.241,2	66

*Source: Simić I., Organic agriculture - unused potential of Republic of Serbia, 2015, p. 11.*

Representation of products with organic certification in the Serbian market is not enough, whether it is on the supply of fresh and processed products, which is supported by the fact of more and more frequent imports of these products into our market.<sup>5</sup> Since there is often a lack of storage space, the products are only available during the peak season, when manufacturers flood the market.<sup>6</sup>

For the most part the production is aimed at export, in 2013 the total amount of exported organic products amounted to 7,101,301.24 kg (2012: 1,561,672.50 kg), and the realized export was in the valuation code of approx. 10.090.801 euros. The highest value is achieved exports of frozen vegetables - raspberries, blackberries, cherries, followed by dried fruits - raspberries, blackberries, cherries and strawberries, fresh fruit - apples and plums, followed by fruit juices and fruit juices concentrates- blueberries and apples and dried herbs. From Serbia mainly exported products are those with a low degree of processing, thus have less added value.<sup>7</sup> Marketing activities aimed at branding organic products and their promotion abroad are not represented sufficiently. Support should be given to exporters by strengthening, deepening and expansion of their business connections and relationships as well as support participation in fairs.<sup>8</sup>

#### THE LEGAL AND INSTITUTIONAL FRAMEWORK OF ORGANIC AGRICULTURE

The first law that regulated the production of agricultural and other products by methods of organic production was adopted in 2000. In 2006 a new law was adopted and at the end of the same year he established a national sign, which marked certified organic

<sup>5</sup> Nešković, S., Jovanović, Ž., Ecological Paradigm within the Context of the International Policy – Development Study, *Balkan Journal of Philosophy*, Bulgarian Academy of Sciences, Vol. 8, Issue 1, 2016, p. 71.

<sup>6</sup> Berenji J., Milenković S., Kalentić M., Stefanović E., Nacionalna istraživačka agenda za sektor organske proizvodnje, Beograd, 2013., str. 25.

<sup>7</sup> Nešković, S., Saobraćaj i ekologija u konceptu održivog urbanog razvoja, Travnik: Internacionalni univerzitet Travnik, BiH, 2014, str. 31.

<sup>8</sup> National Action Plan for the development of organic production for the period 2014 - 2019, Ministry of Agriculture and Environment, pp 27-29.

products. Because of the new Regulation of the European Union in 2007, there was a need to harmonize the legal framework with new regulations, and in May 2010 Government adopted a new law on organic production, which is still topical.<sup>9</sup> In the future we can expect the adoption of the new law, given that in 2012 and 2013, work was done on the amendments to further harmonization with the European Union, which has since changed. The provisions of the law apply to primary agricultural products, processed agricultural products used in food, feed, seed and planting material and yeasts that are used for human and animal nutrition.<sup>10</sup>

In the Ministry of Agriculture and Environmental Protection operates a special working group - Expert Council on organic production, which gives expert opinions and discuss professional issues in the field of organic production. Aside from the subsidies for agricultural activities, the state needs to invest in measures that will improve the quality of life of the rural population. Investments in infrastructure, education of the local population, promotion of traditional customs and traditional crafts and tourism should be part of a national action plan in the region.<sup>11</sup>

### **ECONOMIC CONTEXT OF HOUSEHOLDS IN SERBIA**

According to the Regulations on Registration of agricultural holdings from 2013, the farm area is at least 0.5 hectares of agricultural land in the territory of the Republic of Serbia, where agricultural production is performed by a legal person or individual. The total number of farms in Serbia, according to data from Chamber of Commerce is 631,552, and the number of farms and permanent staff amounts to 1,442,628. According to the agricultural census in 2012, prevailing small farms with an average area of about 5.4 hectares of agricultural production is mainly done in the traditional way, without the use of modern machinery and large amounts of pesticides and fertilizers. This farm is easily converted to organic production.<sup>12</sup>

Results of agricultural census in 2012 showed the following:

- The total number of registered agricultural land in 2011/2012. that was used is 89% or 3,437.423 ha. Of the total land use, 30% of the land is leased;
- Average farm size is 5.4 ha;
- Every household has an average of six plots, each of which is around 0.98 ha;
- In 2012, irrigation had used 3% of farms;
- 95% of the total number of tractors are older than 10 years;
- The average farmer is 59 years old.

---

<sup>9</sup> Nešković, S., Jovanović, Ž., Ecological Paradigm within the Context of the International Policy – Development Study, Balkan Jopurnal of Philosophy, Bulgarian Academy of Sciences, Vol. 8, Issue 1, 2016, p. 74-75.

<sup>10</sup> Nešković, S., Ecological Management, Belgrade, College PEP, 2010, pp. 53.

<sup>11</sup> FAO Regional Office for Europe and Central Asia Coordination Office in Serbia, Belgrade, 2014, p. 53.

<sup>12</sup> National Action Plan for the development of organic production for the period 2014 - 2019, Ministry of Agriculture and Environment, pp 6-7.

The future of these small farmers in organic production is an alternative to intensive agriculture.<sup>13</sup> According to data of the Serbian Chamber of Commerce, the total area of agricultural land is 3,861,477 hectares, of which land used is 64.3% of the forest cover consists of 19.1%, 7.9% of unused land and other land 8.7%. As far as land use, participate in the structure: arable land and gardens - 73.1%, meadows and pastures - 20.7%, fruit orchards - 4.8%, vineyards - 0.6%, yards - 0.7% and others permanent planted in the amount of 0.1%. For arable land and gardens, the largest area under cereals (68%) dominated the area under maize (39%) and wheat (24%). Fruit, mostly plums are grown on 45% and apples at 15% of the area under fruit.

Organic agricultural products are mainly sold to wholesalers and processing companies, with which almost 70% of primary producers conclude contracts prior to the start of the season. Direct sales, for example, green markets and in retail stores practice only 20% of farmers. Because of this system, increase in price they obtain for their organic produce is very moderate (average 10-20%) and confirmed that added value is not generated at farm level. In the sector of present and new tendencies, namely the big supermarket chains have upped their offer of organic products. A large number of these products are imported, which confirms the fact that the development of organic production for the domestic market is not at sufficient level.<sup>14</sup>

According to statistical data and analysis, the following findings are:

- agriculture in Serbia is traditional and extensive (low-productive, highly oscillatory and highly dependent on climatic factors). Therefore, low marketability and low product specialization are present in agricultural production;
- in domestic agriculture dominate the so-called small and medium-sized farms in terms of area and economic power of households. Their development significantly limits the underdeveloped agricultural markets and lack of vertical integration in the production chain of agricultural products;
- despite all of the foregoing, these farms are of great importance in the local market of goods, in terms of food production, as well as from the standpoint of resources and rural environment;
- it is necessary to initiate measures aimed at their economic empowerment and building sustainable competitive advantages in both domestic and foreign markets.<sup>15</sup>

## CONCLUSION

Given that the organic products occupy only 1% share of global food market, and that demand is growing steadily despite the global financial crisis, improvement and investment in Serbia in this type of production has the ability to increase exports of organic products. Export of organic food is at much lower level than the potential that

---

<sup>13</sup> FAO Regional Office for Europe and Central Asia Coordination Office in Serbia, Belgrade, 2014, p. 7.

<sup>14</sup> Berenji J., Milenković S., Kalentić M., Stefanović E., Nacionalna istraživačka agenda za sektor organske proizvodnje, Beograd, 2013., p. 22

<sup>15</sup> [http://www.kombeg.org.rs/aktivnosti/zadruzni\\_savez/Detaljnije.aspx?veza=14627](http://www.kombeg.org.rs/aktivnosti/zadruzni_savez/Detaljnije.aspx?veza=14627) (11.05.2016.)

Serbia has in this field of production. Although the world's land area under organic production has been constantly growing, there is an unmet demand when it comes to fruits, cereals and fodder. Serbian government should take advantage of these shortcomings. Organic products have higher market value, a good physical, chemical and biological properties of soils which in most cases is not contaminated. Favorable climatic conditions provide an incentive and opportunity for the successful development of organic production. This would solve the existential problem of a significant part of the rural population, and also significantly improve human health and environmental protection.<sup>16</sup>

#### REFERENCES

1. Neskovic, S., Ecological Management, Belgrade, College PEP, 2010.
2. National Action Plan for the development of organic production for the period 2014 - 2019, Ministry of Agriculture and Environment of Republic of Serbia, 2014.
3. Kalentić M., Stefanović E., Simić I., Maerz U., Organska poljoprivreda u Srbiji, Beograd: Nacionalno udruženje za razvoj organske proizvodnje Serbia organica, 2014.
4. Nešković, S., Jovanović, Ž., Ecological Paradigm within the Context of the International Policy – Development Study, Balkan Journal of Philosophy, Bulgarian Academy of Sciences, Vol. 8, Issue 1, 2016.
5. Berenji J., Milenković S., Kalentić M., Stefanović E., Nacionalna istraživačka agenda za sektor organske proizvodnje, Beograd, 2013.
6. Nešković, S., Saobraćaj i ekologija u konceptu održivog urbanog razvoja, Travnik: Internacionalni univerzitet Travnik, BiH, 2014.
7. Neskovic, S., Ecological management, Belgrade, College PEP, 2010.
8. FAO Regional Office for Europe and Central Asia Coordination Office in Serbia, Belgrade, 2014.
9. [http://www.kombeg.org.rs/aktivnosti/zadruzni\\_savez/Detaljnije.aspx?veza=14627](http://www.kombeg.org.rs/aktivnosti/zadruzni_savez/Detaljnije.aspx?veza=14627)

---

<sup>16</sup> Nešković, S., Jovanović, Ž., Ecological Paradigm within the Context of the International Policy – Development Study, Balkan Journal of Philosophy, Bulgarian Academy of Sciences, Vol. 8, Issue 1, 2016, p. 75.



## NITRATE IN GREEN LEAFY VEGETABLES FROM CONVENTIONAL AND ORGANIC PRODUCTION

Gordana Milojevic Miodragovic<sup>1</sup>, Lj. Torovic<sup>1,2</sup>, S. Bobic<sup>1</sup>, D. Lukic<sup>1</sup>

<sup>1</sup>Institute of Public Health of Vojvodina, Novi Sad, SERBIA

<sup>2</sup>University of Novi Sad, Faculty of Medicine, SERBIA

### ABSTRACT

Analysis of nitrate was conducted on various fresh green leafy vegetables, originating from conventional and organic production, acquired in consumer goods stores, in the area of Novi Sad. Rucola, as expected, showed the highest nitrate content (3432mg/kg organic, 4451mg/kg conventional). Nitrate level varied considerably among other vegetable species, ranging in organic products from undetectable level in parsley leaves to 1416mg/kg in red salad, and from 212.9mg/kg in parsley leaves to 1540mg/kg in cabbage when conventional samples were considered. When compared with their conventional counterparts, parsley leaves, cabbage, spinach, Swiss chard and rucola from organic production exhibited lower nitrate levels.

**Key words:** vegetables, organic, nitrate, ion chromatography.

### INTRODUCTION

Vegetables include vegetable crops – products or parts of vegetable plants aimed for human nutrition: leaves, heads, bulbs, tubers, roots, leguminous plants or stems in fresh or processed form. Nutritive significance of vegetables is due to their high content of vitamin C, vitamins of B group, minerals (K, Mg, Ca, P, Fe), they are good source of soluble carbohydrates and row cellulose. Unfortunately, due to increased environmental pollution, residuals of numerous xenobiotics could also be found in vegetables. The most significant contaminants noticed in fresh vegetables are toxic metals, pesticides, nitrate and nitrite. In previous times, nitrate was indicated as natural constituent in plants, while nowadays it is classified as contaminant. Sources of increased content of nitrate in fresh vegetables could be various: artificial nitrogen fertilizers used in agriculture, industrial waste-waters used in irrigation of vegetables, acid rains formed by dissolution of gaseous forms of contaminants. Fertilizers having inorganic nitrogen salts are rapidly transformed in soil into ammonia, which is thereafter oxidized to nitrate and nitrite that can be accumulated in vegetables. Excess of nitrogen from soil is easily rinsed and reaches water streams and in this way could also influence contamination of vegetables by nitrate.

Therefore, ecological system such as organic production is very important in vegetable growing. Organic production comprises entire system of food production and management, based on ecological procedures, high level of biological variety (biodiversity), sustaining of natural resources, use of high standards concerning wellbeing of animals (Law on organic production of RS, 2010). Concerning this reason, ecological system as organic production is a model of sustainable agriculture and it is highly significant in vegetable production, having in mind that vegetables are important part of human nutrition. Furthermore, usage of agro-technical measures in organic productions protects the nature and the environment (2).

Numerous investigations indicate that, depending on plant and animal species and ecological specificity, organic food has natural aroma and flavor and intensive color, with increased content of dry matter, vitamin C, secondary metabolites (phenolic compounds) and antioxidants, significantly lower content of nitrate, without harmful pesticide and hormone residuals and is not genetically modified (2). In some studies, organically produced vegetables exhibited 50% lower content of nitrite (3).

Increased soil fertility is basis for successful vegetable production. Vegetables need great quantity of potassium. However, species having large leaves (cabbage vegetables, lettuce) also need larger quantity of nitrogen. Depending on the type of production, nitrogen is added in the form of artificial fertilizers or in the form of organic, organic mineral and allowed natural mineral fertilizers (4).

Some vegetable types have ability to accumulate nitrogen, e.g. spinach, lettuce, red radish, kohlrabi etc. Nitrate content in these vegetable types is above 1500mg/kg. Nitrate level depends on the type of vegetable, part of the plant, its maturity, and also from atmospheric and agricultural conditions (different ways of growing, different soil types, etc.). Nitrite concentration in fresh vegetables is mainly low, but vegetables containing significant nitrate quantities could also have increased nitrite content. Microbiological reduction of nitrate to nitrite is also possible. Concentration of nitrate and nitrite in raw vegetables is influenced by numerous factors: length of storage time, conditions of storage (temperature), as well as procedures of vegetable treatment (washing, peeling, boiling) (5).

Nitrate is substantially less toxic than nitrite, and their noxiousness is in fact referred to reductive transformation into nitrite. Toxicity of ingested nitrite could result in possible development of methaemoglobinemia and formation of carcinogenic nitrosamines. Methaemoglobine (MetHb) does not participate in transfer of oxygen to cells and tissues. Normal level of MetHb is under 2% in adult persons and in babies under three months is below 3% . When MetHb level reaches 10% from normal Hb level, clinical symptoms develop: cyanosis (blue discolorisation of the skin due to presence of non-oxidized blood) and asphyxiation. Such potentially fatal conditions are known as methaemoglobinemia or blue baby syndrome (6). Particularly vulnerable population groups are: infants, children aged from 1-3, pregnant women, people with decreased gastric chloride acid production, people with deficit of glucoses-6-phosphat-dehydrogenasis or methaemoglobine-reductasis (7).

An acceptable daily intake (ADI) for nitrate of 3.7mg/kg b.w./day (equivalent to 222mg/day for a 60kg adult) was established by Scientific committee on food and

reconfirmed by the Joint FAO/WHO Expert committee on food additives in 2002 (8) and European food safety authority in 2008 (5).

According to report by Santamaria (6), World Health Organization assessment of daily intake of nitrate in European population from all sources (except as additives) resulted with 155mg/day. European food safety authority assessed potential health impacts from the different vegetable intake scenarios and compared it with the ADI. A person eating 400g of mixed vegetables at typical median nitrate levels would have a daily intake comprising 71% of ADI. The more probabilistic scenario includes fruit as half of the total recommended daily intake of 400g of fruit and vegetables, and regarding nitrate, this leads to considerable reduction of intake, to 36-48% of ADI. It is important to emphasize that, even when the intake of nitrate from other dietary sources is considered, a total intake was within the ADI in both these scenarios. However, consumers of large quantities of vegetables grown under unfavorable production conditions may exceed the ADI approximately two fold. Interestingly, a person consuming more than 47g of rucola containing median nitrate concentration would exceed the ADI (5).

## **MATERIAL AND METHODS**

Standard method SRPS EN 12014-2: Foodstuffs – Determination of nitrate and/or nitrite content – part 2: HPLC/IC method for determination of nitrate content in vegetables and vegetable products, was used for all analytical determinations conducted in present study.

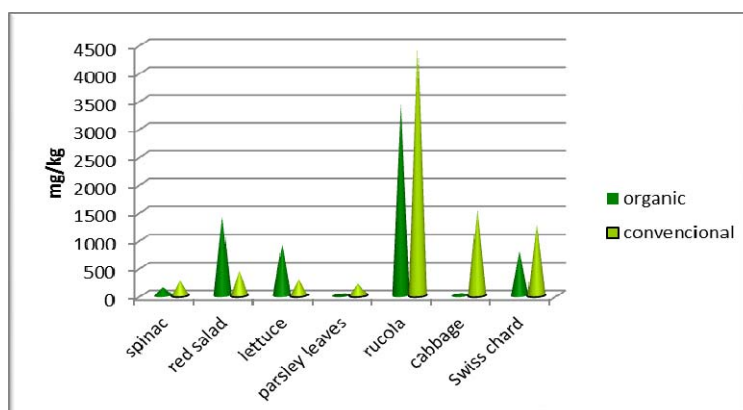
Method is based on nitrate extraction from food using hot water. After the extraction, ion chromatography on Dionex Ion Pac AS 19 4 $\mu$ m 250 mm analytical column with conductivity detector was applied for the analysis.

Certified reference material, a cabbage puree with nitrate content of 1014 $\pm$ 115 mg/kg, when analyzed in the laboratory as quality control sample, gave the result of 1048 mg/kg. Participation with the methods used in this study in proficiency testing "Nitrate analysis in vegetable leaves" resulted in satisfactory *z*-score of -1.38 (9).

The most commonly consumed fresh green leafy vegetables (spinach, red salad, lettuce, parsley leaves, rucola, Swiss chard and cabbage), originating from conventional and organic production, were acquired in consumer goods stores, in the area of Novi Sad, in May 2016, and subjected to the determination of nitrate content.

## **RESULTS AND DISCUSSION**

Nitrate levels determined in studied samples of green leafy vegetables originating from organic and conventional production are shown on Figure 1.



**Figure 1.** Nitrate content in green leafy vegetables from conventional and organic production

Rucola, as expected, had the highest nitrate content, regardless of the production type, although the sample from the organic production contained 77% of the nitrate determined in the conventional one. Generally, nitrate level varied considerably among other vegetable species, ranging in organic products from undetectable level (below 0.1mg/kg) in parsley leaves to 1416mg/kg in red salad, and from 212.9mg/kg in parsley leaves to 1540mg/kg in cabbage when conventional samples were considered. When compared with their conventional counterparts, parsley leaves, cabbage, spinach, Swiss chard and rucola from organic production showed lower nitrate levels, whereas lettuce and red salad exhibited higher levels. The largest difference was observed in case of cabbage, with 3600% higher nitrate level in conventionally grown cabbage. Present study was primarily conducted to give insight into the nitrate levels in the products available to the consumers, and obtained results indicate that organic products do not necessarily have lower nitrate content than conventional. It was not possible to come to a conclusion about the impact of agricultural practice on nitrate level in vegetables.

There are many studies in literature comparing conventional and organic vegetables regarding many variables, including nitrate levels. Some studies reported a lower nitrate levels in organically grown vegetables, whereas others reported the opposite results, as summarized by Gonzales et al. (10). Additionally, some authors showed a content of nitrate independent from the agricultural practice used (11). Further investigations are needed to clarify this important question.

Results of the present study were also used to assess compliance of the samples on the market with the food safety standards defined by legal framework. In Serbia, the regulation issued by the Ministry of Agriculture and Environment (12) permits 3500mg of nitrate per kilogram of fresh spinach, 3000 or 4000mg/kg in fresh lettuce, if produced on open air or in green house, respectively, and 6000mg/kg in rucola. With exclusion of spinach, all values apply to the products collected in summer period, which is of interest for the studied samples. In present investigation, maximum levels were not exceeded in any of the samples referred in the regulation. For other studied vegetable types, risk assessment should be performed to evaluate their nitrate content, as statutory maximum levels were not established.



## CONCLUSION

Health benefits of a diet rich in vegetables, excellent source of vitamins, minerals and biologically active compounds, have been widely acknowledged. However, nitrate could also be an important component of vegetables due to its potential for accumulation, affected by various factors, including agricultural practice. Attention should be paid to ensure nitrate levels are as low as reasonably achievable, in order to protect the health of people, especially the most vulnerable population of children. Further investigation is needed for comparison of organic and conventional cultivation conditions, to make differences more apparent.

## REFERENCES

1. Mirić M, Šobajić S. Food safety. Institute for text edition and teaching aids 2002; 85-92; 146-154.
2. Lazić B. Wonderful world of organic agriculture, chapter in Monograph Excellent world of organic farming, Green Network of Vojvodina 2014. M;11-26.
3. Larion D. Nutritional quality and safety of organic food. EDP Sciences, JNRA, 2009.
4. Lazić B. Organic agriculture, chapter in Monograph Excellent world of organic farming, Green Network of Vojvodina 2014. M; 109-136.
5. EFSA (European Food Safety Authority). Nitrate in vegetables -Scientific Opinion of the Panel on Contaminants in the Food chain. The EFSA Journal. 2008; 689: 1-79.
6. Santamaria P. Nitrate in vegetables: toxicity, content, intake and EC regulation. Journal of the Science of Food and Agriculture 2006;86:10-17.
7. EFSA Panel on Contaminants in the Food Chain (CONTAM). Scientific Opinion on possible health risks for infants and young children from the presence of nitrates in leafy vegetables. EFSA Journal 2010;8(12):1935.
8. FAO/WHO (Food and Agriculture Organisation of the United Nations/World Health Organization). Nitrate (and potential endogenous formation of N-nitroso compounds). WHO Food Additive series 50, Geneva: World Health Organisation, 2003. Available at URL: <http://www.inchem.org/documents/jecfa/jecmono/v50je06.htm>
9. LGC standards. Proficiency test report, Nitrate analysis in vegetable leaves. Lancashire, UK, 2016.
10. Gonzales MCM, Martiney-Tome MJM, Isasa MET. Nitrate and nitrite content in organically cultivated vegetables. Food Additives and Contaminants Part B 2010;3:1-29. (and references cited there in)
11. De Martin S, Restani P. Determination of nitrates by a novel ion chromatographic method: occurrence in leafy vegetables (organic and conventional) and exposure assessment for Italian consumers. Food Additives and Contaminants 2003;20:787-792.
12. Ministry of Agriculture RS. Maximum allowed contents of contaminants in food and feed. Off Bull Rep Serbia 29/14:1.



## PHYSICOCHEMICAL FACTORS WHICH AFFECT MILK DENSITY

Rodica Caprita, A. Caprita\*

Banat's University of Agricultural Sciences and Veterinary Medicine  
"King Michael I of Romania" from Timisoara, ROMANIA

\* [adi.caprita@gmail.com](mailto:adi.caprita@gmail.com)

### ABSTRACT

Bovine milk is one of the main sources of nutrients worldwide, providing proteins, fats, lactose and minerals necessary for human growth. Milk is also probably the most processed food fluid. Many products can be made from fresh milk involving a great number of industrial processes such as thermal treatment and cooling. During processing, milk suffers changes in temperature and composition, which contribute to changes in the physical properties. In this paper, the effect of temperature on whole milk density was studied within ranges commonly used by dairy industries. Correlations between density, viscosity and protein content were established. The obtained experimental data revealed a high positive correlation between density and protein content ( $r = 0.7815$ ) and a high negative correlation between density and dynamic viscosity ( $r = -0.7983$ ). The density of whole milk decreases slightly with increasing temperature.

**Key words:** density, specific gravity, viscosity, protein content, milk.

### INTRODUCTION

Milk is the most complete nutritional food found in nature, containing vitamins, minerals, proteins, carbohydrates, and lipids [1].

Milk is a versatile food. Milk is consumed in its natural form and also it is used to make a wide range of food products: cream, butter, yogurt, cheese, ice cream. The major source for human consumption is cow milk. Cattle produce 83% of world milk production, followed by buffaloes with 13%, goats with 2% and sheep with 1%; camels provide 0.3%.

Milk is a very complex food with over 100,000 molecular components. Therefore, only an approximate composition of milk is usually given. Cow milk is composed of 80-90% water, 4-4.5% fats, ~4.5% carbohydrates (lactose), 3-4% proteins, minerals, and vitamins [2-6]. Lactose is a specific sugar for milk and gives milk its sweet taste [7]. Fat is dispersed throughout the milk in globules. If the fat content is lowered to 3.25%, the milk is known as whole milk. Low-fat milk typically has 1-2% fat. Fat has a lower specific gravity than the milk serum (density at 15.5°C is 0.93 g/cm<sup>3</sup>). As the fat globules are not only the largest particles in the milk but also the lightest, they tend to rise to the surface and so fat can be skimmed from the milk. The collected fat is called

"cream" and the milk deprived of fat is called "skimmed milk" or "skim milk". Fat milk rise to the surface occurs with changing density. The layers up to the surface have decreasing density.

Many products can be made from fresh milk by industrial processes. During processing milk suffers changes in temperature and composition, which contribute to changes in the physical properties.

Knowing the thermo-physical properties such as density and viscosity is very important for calculating dimension of equipment in the food industry [8].

Milk is heavier than water. The specific gravity varies (at 60°F) between 1.028 - 1.030 for cow milk, 1.030 - 1.032 for buffalo milk and 1.035 - 1.037 for skim milk. The specific gravity of milk is influenced by the proportion of its constituents, each of which having different specific gravity, approximately as follows: water – 1.000, fat – 0.93, protein – 1.451, lactose – 1.545 salts – 4.12 (solids-not-fat - 1.616) [6].

The physical characteristics such as moisture, total solids, specific gravity, pH, conductivity, viscosity and titratable acidity are important parameters in studying the physicochemical compositions and nutritional aspects of milk [1,9-11].

In this paper, the effect of temperature on whole milk density was studied within ranges commonly used by dairy industries. Correlations between density, viscosity and protein content were established.

## **MATERIALS AND METHODS**

The experiment was made on raw milk samples collected from dairy cows. Milk samples were cooled to 8°C immediately after milking and transported to the laboratory. Standard laboratory methods were used to analyze the milk samples [12].

Gravimetric determination of milk density was conducted using an analytical balance (Kern ABJ 220-4M) with given uncertainty  $\pm 0.0001$  g and a standard volumetric pycnometer (25 mL) [13,14]. The pycnometer was previously calibrated with distilled water for each temperature kept constant using a thermostatic water bath (LabTech LSB-015S). Specific gravity of whole cow milk represents the ratio of density of milk to density of water.

Density of the cow milks investigated was measured at 4 temperatures: 4, 10, 20, 40, 60, and 80°C.

The dynamic viscosity was determined using a cone/plate viscometer (Brookfield Model DVIII Cone CP-40) at 60 rpm.

Results were expressed as mean  $\pm SD$  of three separate determinations. The statistical significance of the differences among the mean values was tested by ANOVA.

## **RESULTS AND DISCUSSION**

All the biochemical and biophysical parameters of the milk samples are within the normal limits (Table 1).

**Table 1.** Biochemical and biophysical parameters of milk

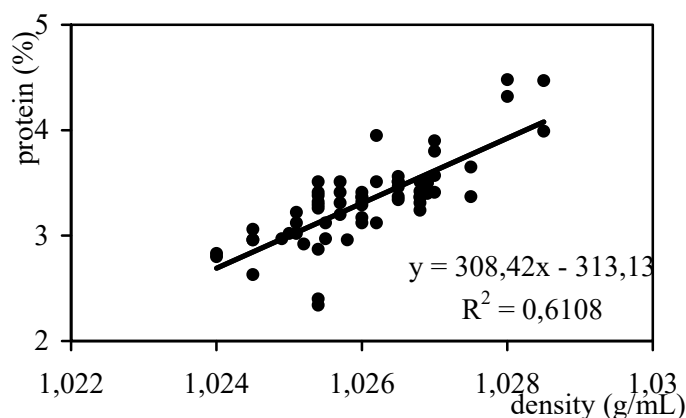
Fat (%)	3.95±0,60
Protein (%)	3.37±0,40
Casein (%)	2.687±0.313
Density (g/mL)	1.027±0.002
Dynamic viscosity (cP)	1.73±0.22

Milk density is the summary result of the densities of its various components. It is dependent on the amount of dissolved or suspended matter, changes in chemical composition of the constituents, and variations in physical states of components. The mean value of milk density was 1.027±0.002 (range 1.0249 to 1.0338).

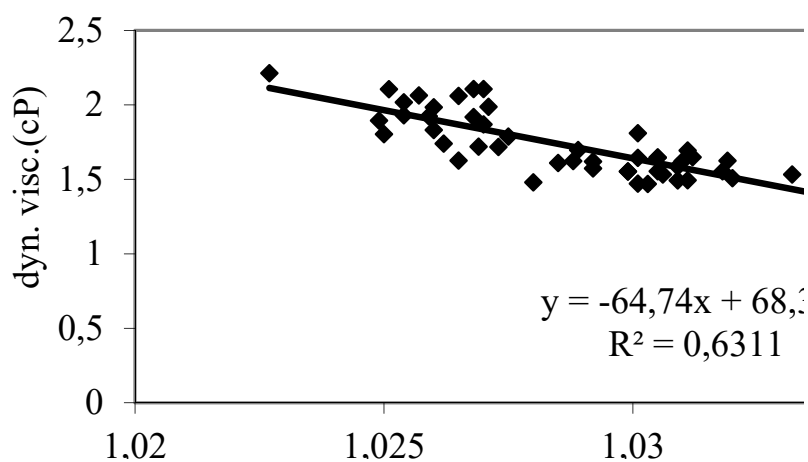
Shortly after the milking, density is low, primarily due to the change of the aggregate state of the fat particles, which are contracted upon cooling (solidifying). The density of milk should not be determined for at least one hour after it is drawn from the animals; else a lower-than-normal value will be obtained (due to the Recknagel phenomenon).

The density of milk products can be used to convert volume into mass and mass into volume, to estimate the amount of solids present in milk, and to calculate other physical properties.

The obtained experimental data revealed a high positive correlation between density and protein content ( $r = 0.7815$ ) since casein micelles range in size from 10 to 300 nm and they have a density of 1.11 g/mL (Figure 1).

**Figure 1.** Correlation between protein content and density of whole milk

The density is also highly negative correlated ( $r = -0.7983$ ) with the dynamic viscosity (Figure 2).



**Figure 2.** Correlation between density and dynamic viscosity of whole milk

The increase in temperature reduced the overall density value due to the average thermal expansion of the milk components (Table 2).

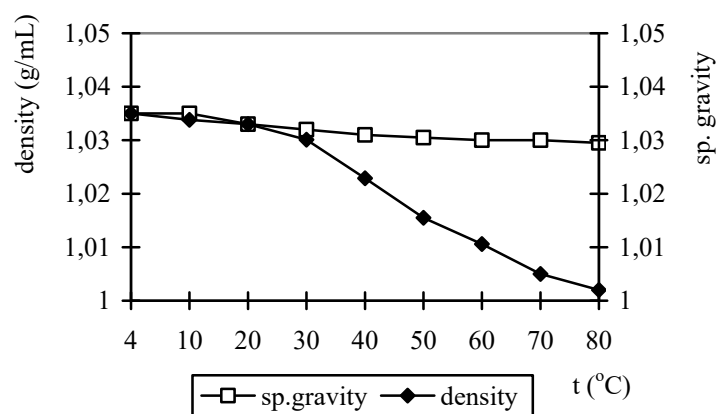
Milk fat has a density of approximate 0.9 g/mL at 60°C. Density of the solids-non-fat is about 1.616 at 60°C. Specific gravity is used to estimate solids-non-fat and the total solids content of milk and to screen samples for added water.

The higher the fat content of the milk, the bigger the density changes with temperature. The reason is that the volume of fat changes much more with temperature than the volume of water. These decreases are non-linear [15].

**Table 2.** Density of whole and skim milk at various temperatures

Temperature (°C)	Density (g/mL)	
	whole milk	skim milk
4	1.035	1.035
10	1.0338	1.035
20	1.030	1.033
40	1.0229	1.022
60	1.0106	1.010
80	1.002	1.002

The specific gravity of whole milk decreases slightly with increasing temperature (Figure 3) partly because of the effect of temperature on milk fat but also because the contraction of the other solids that occur on mixing with water decreases slightly with increasing temperature.



**Figure 3.** Variation of density and specific gravity of whole milk with temperature

### CONCLUSIONS

The obtained experimental data revealed a high positive correlation between density and protein content ( $r = 0.7815$ ) and a high negative correlation between density and dynamic viscosity ( $r = -0.7983$ ).

The density decreases more rapidly as temperature increases, while the specific gravity lowers more slowly and remains relatively constant up 40°C.

### REFERENCES

1. Căpriță R., 2014, Evaluation of some physicochemical properties of milk caused by acidification, *Scientific Papers Animal Science and Biotechnologies*, 47(2), 137-141.
2. Boor K.J., Brown D., Murphy S., Kozłowski S.M., Bandler D.K., 1998, Microbiological and chemical quality of raw milk in New York State, *J. Dairy Sci.*, 81, 1743-1748.
3. Brew K., Chrysina E.D., Acharya K.R., 2000, Crystal structures of apo- and holo-bovine  $\alpha$ -lactalbumin at 2.2-Å resolution reveal an effect of calcium on interlobe interactions, *Journal of Biological Chemistry*, 275, 37021-37029.
4. Ontsouka C.E., Bruckmaier R.M., Blum J.W., 2003, Fractionized milk composition during removal of colostrum and mature milk, *J. Dairy Sci.*, 86, 2005-2011.
5. Rasmussen M.D., Bjerring M., Justesen P., Jepsen L., 2002, Milk quality on danish farms with automatic milking systems, *J. Dairy Sci.*, 85, 2869-2878.
6. Singh H., McCarthy O.J., Lucey J.A., 1997, Physico-chemical properties of milk. In: P.F. Fox (ed), *Advanced Dairy Chemistry, Volume 3: Lactose, Water, Salts and Vitamins*, 2<sup>nd</sup> ed., Chapman&Hall, New York, 469-495.

7. Căpriță R., Caprita A., Cretescu I., 2014, Determination of lactose concentration in milk serum by refractometry and polarimetry, *Scientific Papers Animal Science and Biotechnologies*, 47(1), 158-161.
8. Guimarães G.C., Coelho Júnior M.C., Garcia Rojas E.E., 2009, Density and kinematic viscosity of pectin aqueous solution, *J. Chem. Eng. Data*, 54, 662-667.
9. Căpriță A., Căpriță R., 2001, The effect of lactose content on the milk electric conductivity, *Ann. Western Univ. Tim., ser. Chem.*, 10(2), 375-378
10. Căpriță, A., Căpriță, R., Crețescu, I., 2014, The effects of storage conditions on some physicochemical properties of raw and pasteurized milk, *Journal of Agroalimentary Processes and Technologies*, 20(2), 198-202
11. Căpriță, R., 2001, *Principii și tehnici în biochimie*, Ed. Mirton, Timișoara, 125-126.
12. Walstra P., Jenness R., 1984, *Dairy Chemistry and Physics*, John Wiley, New York.
13. Fontan R.C.I., Santos, L.S., Bonomo R.C.F., Lemos A.R., Ribeiro R.P., Veloso C.M., 2009, Thermophysical properties of coconutwater affected by temperature, *J. Food Process Eng.*, 32, 382-397.
14. Minim L.A., Telis V.R.N., Minim V.P.R., Alcantara, L.A.P., Telis-Romero J., 2009, Thermophysical properties of lemon juice as affected by temperature and water content, *J. Chem. Eng. Data*, 54, 2269-2272.
15. Tagawa A., Muramatsu Y., Kitamura Y., Tanaka C., 1997, A new experimental equation for viscosity of liquid food involving concentration dependence, *Nippon Shokuhin Kagaku Kogaku Kaishi*, 44, 69-74.



## SOME RHEOLOGICAL ASPECTS OF WHOLE MILK

Rodica Caprita, A. Caprita\*

Banat's University of Agricultural Sciences and Veterinary Medicine  
"King Michael I of Romania" from Timisoara, ROMANIA

\*[adi.caprita@gmail.com](mailto:adi.caprita@gmail.com)

### ABSTRACT

Milk's physical and chemical properties depend on intrinsic compositional and structural factors, and extrinsic factors such as temperature and post-milking treatments. Viscosity is one of the parameters which have influence on rheology of fluid milk. The effect of temperature on whole milk viscosity was studied within ranges commonly used by dairy industries. Correlations between viscosity, pH, and protein content were established. The dynamic viscosity and density of cow milk lowered with increasing temperature. At the temperature around 80°C the viscosity of milk increased, which could be due to denaturation of proteins in the samples. The experimental data revealed a moderate positive correlation between the dynamic viscosity and the pH ( $r = 0.5501$ ,  $P < 0.001$ ) and a strong positive correlation between the dynamic viscosity and the protein content ( $r = 0.7815$ ,  $P < 0.001$ ).

**Key words:** dynamic viscosity, kinematic viscosity, pH, protein, milk.

### INTRODUCTION

Milk has high nutritive value containing all essential nutrients for human and animal growth in an easily digestible and assimilable form. Milk provides body-building proteins, bone-forming minerals and health-giving vitamins and furnishes energy-giving lactose and milk fat [1].

Milk's physical characteristics are influenced by several factors including the composition and processing of milk [2-4]. The physical and chemical properties of milk have been reviewed previously [5,6]. Measurement of some of the physicochemical properties is used to assess milk quality [7-9].

The biophysical characteristics, such as specific gravity, pH, electrical conductivity, viscosity and titratable acidity, are important parameters in studying the physicochemical compositions and nutritional aspects of milk. Milk is a dilute emulsion of fat dispersed phase and an aqueous colloidal continuous phase [10]. The physical properties of milk are influenced by the presence of various solutes in the continuous phase (proteins, lactose and salts) and by the degree of dispersion of the emulsified and colloidal components [2]. Casein is the principal contributor to the milk viscosity. Fat, whey proteins and low molecular mass species have less influence on the viscosity.



The viscosity of a heterogeneous substance such as milk at a given temperature depends upon its composition and the physical state of its dispersed colloidal substances, including milk fat. The viscosity of fluids is influenced by various factors, which knowledge is of immense value in understanding the behavior of these fluids during processing. Viscosity is one of the parameters which have influence on rheology of fluid milk. Milk viscosity is twice as high as water due to the friction of fat in milk. Viscosity is influenced by several factors: state and concentration of protein, state and concentration of fat, temperature of milk and age of the milk [11-13].

Milk behaves as a Newtonian liquid, in which the viscosity is independent of the rate of shear. Milk, skim milk and cream are fluids with Newtonian rheological properties at moderate shear rates, at fat contents lower than 40% and at temperatures higher than 40°C. Under these conditions the fat is liquid and no cold agglutination occurs [14]. The viscosity for a Newtonian fluid is independent of shear rate but is influenced by temperature and pressure.

Raw milks and creams exhibit non-Newtonian rheological properties at temperatures below 40°C and low shear rates. Lower temperatures enhance cold agglutination, resulting in stronger fat globule aggregates. Under these conditions, both apparent viscosity and deviation from Newtonian behavior increase [15].

Viscosity, an important physicochemical property of many foods, can be modified by proteins or polysaccharides. The caseins form rather viscous solutions, a reflection of their rather open structure and relatively high water-binding capacity. While the high viscosity of caseinate may be of some importance in casein-stabilized emulsions (e.g., cream liqueurs), it causes production problems; for example, due to very high viscosity, not more than about 20% sodium caseinate can be dissolved even at a high temperature. The low protein content of caseinate solutions increases the cost of drying and results in low-density powders which are difficult to handle [14].

In this paper, the effect of temperature on whole milk viscosity was studied within ranges commonly used by dairy industries. Correlations between viscosity, pH, and protein content were established.

## **MATERIALS AND METHODS**

The experiment was made on raw milk samples collected from dairy cows. Milk samples were cooled to 8°C immediately after milking and transported to the laboratory. The physical characteristics of various milk samples were determined shortly after they were brought to the laboratory.

Standard laboratory methods were used to analyze the milk samples [16]. Titratable acidity expressed as % lactic acid was determined by titration of a known amount of milk with 0.1N NaOH using phenolphthalein as indicator, as described by AOAC [17].

Gravimetric determination of milk density was conducted using an analytical balance (Kern ABJ 220-4M) with given uncertainty  $\pm 0.0001$  g and a standard volumetric pycnometer (25 mL) [18,19]. The pycnometer was previously calibrated with distilled water for each temperature kept constant using a thermostatic water bath (LabTech LSB-015S).

Viscosity of the investigated milk samples was measured at 6 temperatures: 4, 10, 20, 40, 60, and 80°C.

The dynamic viscosity was determined using a cone/plate viscometer (Brookfield Model DVIII Cone CP-40) at 60 rpm.

Kinematic viscosity is the ratio of dynamic viscosity and density, as shown in the equation below:

$$v = \frac{\eta}{\rho}$$

where:

$v$  = kinematic viscosity ( $\text{m}^2 \cdot \text{s}^{-1}$ )

$\eta$  = dynamic viscosity ( $\text{Pa} \cdot \text{s}$ )

$\rho$  = density ( $\text{kg} \cdot \text{m}^{-3}$ )

The pH measurement was made using a multi-parameter analyzer (Consort, model C861) calibrated with pH 4 and 7 buffers.

Reagents and chemicals of analytical grade and deionized double distilled water were used throughout this work.

Results were expressed as mean  $\pm$  SD of three separate determinations. The statistical significance of the differences among the mean values was tested by ANOVA. Correlations between physicochemical parameters were investigated by regression analysis.

## RESULTS AND DISCUSSION

All the biophysical parameters of the milk samples are within the normal limits (Table 1).

The pH values in fresh milk ranged between 6.24 and 6.74 with an average value of  $6.48 \pm 0.09$ . The dynamic viscosity values ranged between 1.479 and 2.263 with an average value of  $1.73 \pm 0.22$ .

**Table 1.** Biochemical and biophysical parameters of milk

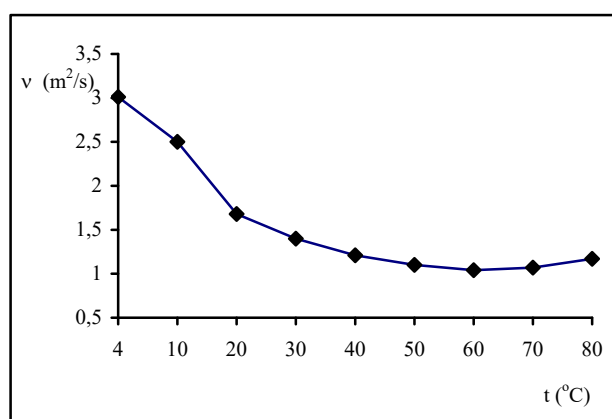
Biophysical parameter	Mean value
Density (g/mL)	$1.027 \pm 0.002$
Dynamic viscosity (cP)	$1.73 \pm 0.22$
Titrateable acidity (°SH)	$6.882 \pm 0.904$
pH	$6.48 \pm 0.09$

Viscosity depends on temperature, namely it is inversely related to temperature, at temperatures below 60°C. Viscosity increased with increasing solids content and at lower temperatures (Table 2). Dynamic and kinematic viscosities slightly increased at temperatures above 60°C (Figure 1), due to denaturation of the whey proteins [20].

The viscosity of milk shows thermal hysteresis; milk usually shows greater viscosity during heating than during subsequent cooling, probably due to the melting and crystallization behaviour of milk triglycerides [14]. Kinematic viscosity works in line with density and dynamic viscosity [21,22].

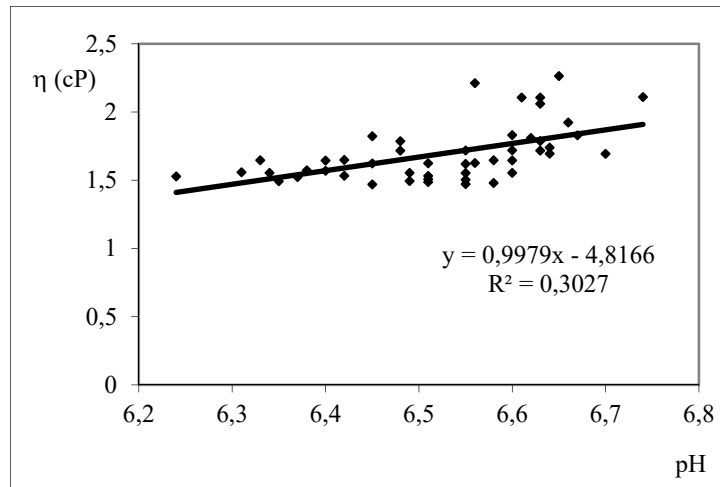
**Table 2.** Density, dynamic and kinematic viscosities of whole milk at various temperatures

Temp. °C	Density g/mL	Dynamic viscosity $\eta \cdot 10^3 \text{ Pa}\cdot\text{s}$	Kinematic viscosity ( $\nu$ ) $\text{m}^2\cdot\text{s}^{-1}$
4	1.035	3.12	3.014
10	1.0338	2.70	2.596
20	1.030	1.73	1.679
40	1.0229	1.24	1.212
60	1.0106	1.06	1.048
80	1.002	1.18	1.177



**Figure 1.** Variation of milk kinematic viscosity with temperature

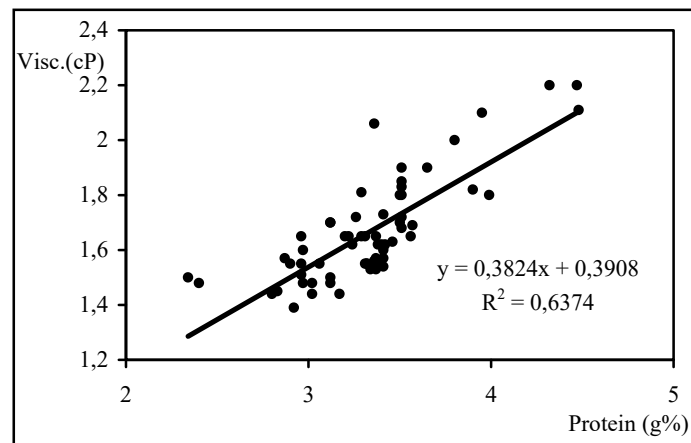
The experimental data revealed a moderate positive correlation between the dynamic viscosity and the pH ( $r = 0.5501$ ,  $P < 0.001$ ) (Figure 2). The viscosity of colloidal systems depends upon the volume occupied by the colloidal particles. Changes in the caseinate micelles, produced by either raising or lowering the pH, result in changed viscosity. Increasing pH increases viscosity slightly (perhaps as a consequence of micellar swelling), while a small decrease in pH reduces viscosity, although a large decrease in pH causes aggregation of casein micelles.



**Figure 2.** Correlation between pH and dynamic viscosity of milk

The dynamic viscosity depends directly proportional to the protein content. Casein is the component that contributes largely to changes in viscosity. The experimental data (Figure 3) revealed a strong positive correlation between the dynamic viscosity and the protein content ( $r = 0.7815$ ,  $P < 0.001$ ) since casein micelles range in size from 10 to 300 nm and they have a density of 1.11 g/mL.

The degree of dispersion of proteins has a major effect on the viscosity. Conditions and treatments that affect the stability of casein are very significant in the viscosity of milk. Acidity, salt balance, heat treatment and the action of various enzymes and bacteria are some of the factors which affect the stability of caseins.



**Figure 3.** Correlation between protein content and dynamic viscosity of milk

## CONCLUSIONS

Viscosity of cow milk lowered with increasing temperature, at temperatures below 60°C.

Dynamic and kinematic viscosities slightly increased at temperatures above 60°C, due to denaturation of the whey proteins.

Increasing pH increases viscosity slightly (perhaps as a consequence of micellar swelling) while a small decrease in pH reduces viscosity, although a large decrease in pH causes aggregation of casein micelles.

The experimental data revealed a moderate positive correlation between the dynamic viscosity and the pH and a strong positive correlation between the dynamic viscosity and the protein content.

## REFERENCES

1. Minim L.A., Coimbra J.S.R., Minim V.P.R., Alcantara L.A.P., Telis-Romero J., 2002, Influence of temperature and water and fat contents on the thermophysical properties of milk, *J. Chem. Eng. Data*, 47, 1488-1491.
2. Singh H., McCarthy O.J., Lucey J.A., 1997, Physico-chemical properties of milk. In: *Advanced Dairy Chemistry*, vol. 3, Lactose, Water, Salts and Vitamins, 2nd edn., P.F. Fox (ed.), Chapman and Hall, London, pp. 469–518.
3. McCarthy O.J., Singh H., 2009, Physico-chemical properties of milk. In: *Advanced Dairy Chemistry*, vol. 3: Lactose, Water, Salts, and Minor Constituents, McSweeney, P.L.H. and Fox, P.F. (eds.) Springer, London, pp. 691-758.
4. Căpriță A., Căpriță R., 2001, The effect of lactose content on the milk electric conductivity, *Ann. Western Univ. Tim., ser. Chem.*, 10(2), 375-378.
5. Kailasapathy K., 2008, Chemical composition, physical and functional properties of milk and milk ingredients. In: *Dairy Processing and Quality Assurance*, John Wiley & Sons, pp. 75-103.
6. Sherbon J.W., 1988, Physical properties of milk. In: *Fundamentals of Dairy Chemistry*, 3rd edn., Wong N.P., Jenness R., Kenny M., Marth E.H., (eds.), Van Nostrand Reinhold, New York, pp. 410–414.
7. Căpriță R., Căpriță A., Crețescu I., 2014, Determination of lactose concentration in milk serum by refractometry and polarimetry, *Scientific Papers Animal Science and Biotechnologies*, 47(1), 158-161.
8. Căpriță R., 2014, Evaluation of some physicochemical properties of milk caused by acidification, *Scientific Papers Animal Science and Biotechnologies*, 47(2), 137-141.
9. Căpriță A., Căpriță R., Crețescu I., 2014, The effects of storage conditions on some physicochemical properties of raw and pasteurized milk, *Journal of Agroalimentary Processes and Technologies*, 20(2), 198-202.
10. Rolf J., 2002, Milk and dairy products. *Ullmann's Encyclopedia of Industrial Chemistry*. Wiley, Weinheim.

11. Park Y.W., 2007, Rheological characteristics of goat and sheep milk, *Small Ruminant Research*, 68(1-2), 73-87.
12. Božiková M., Hlaváč P., 2013, Temperature and storing time influence on selected physical properties of milk and acidophilus milk, *Acta Universitatis Agriculturae et Silviculturae Mendelianae Brunensis*, 61, 1589–1595.
13. Kumbár V., Nedomová S., 2015, Viscosity and analytical differences between raw milk and UHT milk of czech cows, *Scientia agriculturae bohemica*, 46(2), 78-83.
14. Fox P.F., Uniacke-Lowe T., McSweeney P.L.H., O'Mahony J.A., 2015, *Dairy Chemistry and Biochemistry*, Springer International Publishing Switzerland.
15. Walstra P., Jenness R., 1984, *Dairy Chemistry and Physics*, John Wiley, New York.
16. Căpriță, R., 2001, *Principii și tehnici în biochimie*, Ed. Mirton, Timișoara.
17. AOAC, 2000, *Official Methods of Analysis International*, 17th edn., Association of Official Analytical Chemists, Washington DC.
18. Fontan R.C.I., Santos, L.S., Bonomo R.C.F.; Lemos A.R., Ribeiro R.P., Veloso C.M., 2009, Thermophysical properties of coconutwater affected by temperature, *J. Food Process Eng.*, 32, 382-397.
19. Minim L.A., Telis V.R.N.; Minim V.P.R., Alcantara, L.A.P., Telis-Romero, J., 2009, Thermophysical properties of lemon juice as affected by temperature and water content, *J. Chem. Eng. Data*, 54, 2269-2272.
20. Miller G.D., Jarvis J.K., McBean L.D., 2000, *Handbook of Dairy Foods and Nutrition*, 2nd ed., CRC Press, Boca Raton.
21. Tagawa A., Muramatsu Y., Kitamura Y., Tanaka C., 1997, A new experimental equation for viscosity of liquid food involving concentration dependence, *Nippon Shokuhin Kagaku Kogaku Kaishi*, 44, 69–74.
22. Kumbár V., Dostal P., 2014, Temperature dependence density and kinematic viscosity of petrol, bioethanol and their blends, *Pakistan Journal of Agricultural Sciences*, 51, 175–179.



## IMPACT OF NATURAL DISASTERS AGRICULTURE PRODUCTION IN THE WESTERN BALKANS COUNTRIES

Aleksandra Fedajev\*, D. Durkalic, D. Riznic

University of Belgrade, Technical Faculty in Bor, Bor, SERBIA

\*[afedajev@tf.bor.ac.rs](mailto:afedajev@tf.bor.ac.rs)

### ABSTRACT

Today, natural disasters are more frequent ecological phenomenon that greatly affect the situation in the national economies. They leave a deep negative effect on the natural and economic system, which can be expressed in huge losses measured by decline of growth rate or human capital. This paper creates a picture of the characteristics and impact of natural disasters on indicators of agricultural production in the Western Balkans. Theoretical and empirical analysis will allow to reach a scientifically valid and practically useful conclusions that should raise awareness of environmental disasters impact on the cost of living and economic development. This should result in the formulation and implementation of appropriate measures to reduce the risks of natural disasters which should be incorporated in development strategies in Western Balkan countries.

**Key words:** natural disasters, agriculture, Western Balkans, economic growth.

### INTRODUCTION

In recent years recorded the climate and the natural changes that have brought significant negative consequences on the functioning of the economy and society in general. Climate change, such as earthquakes, floods and other natural disasters are increasingly affecting the country, not choosing geographical territory or time. They produced high chain shocks for the overall nature and society and their influence manifested through reduction in quality of life, worsening nutrition and general health of the nation. Bearing in mind all the negative consequences that carry natural disasters it is necessary to impose the study of the effect of the changes which remain after the natural and climatic conditions.

If we bearing in mind the fact that the biggest impact of disasters left in agriculture and primary products, this paper is based on the analysis of the study of natural disasters and their impact on key macroeconomic indicators. The main task of the paper is to detect the amount of damage that natural disasters have left the countries of the Western Balkans, with the aim of increasing awareness of timely responding to these changes. Data on natural disasters collected from the Centre for Research on the Epidemiology of Disasters (CRED), based on stats EM-DAT (Emergency Events

Database). Macroeconomic data on trends in agricultural production were collected from Faostat and World Bank database.

Ecological losses may not always be tracked only economic or human losses, but it is very important to note that these losses are recoverable slowly. Once destroyed nature is very difficult to recover, but recovery has required a long period of time. For countries with very low economic growth and predominant agricultural activities, economic losses may significantly slow down economic development. However, although the majority of natural disasters cannot be prevented, it is possible to alleviate their negative effects.

### OVERVIEW OF NATURAL DISASTERS OF THE WESTERN BALKANS COUNTRIES

Overall, one of the main challenges that the world faces today is the question of to deal and how to limit the impact of large natural disasters, given that the frequency of their intention to seriously and dramatically increased since the 1970s. [4] The Food and Agriculture Organization of the United Nations states that in developing countries most affected is agriculture sector with about 22% of total damage and losses, which are caused by natural disasters. [2] This indicates a duty to protect and defend agriculture from climate change. Table 1 shows the sum of the natural disasters which hit Western Balkans.

**Table 1.** Sum of natural disasters by Western Balkans countries from 2008-2013

Country	Occurrence	Total deaths	Affected	Injured	Homeless	Total affected	Total damage (000 \$)
<b>Albania</b>	4	5	250600	0	150	250750	0
<b>Bosnia and Herzegovina</b>	7	10	58987	0	0	58987	87000
<b>Macedonia</b>	2	2	10011	0	0	10011	0
<b>Montenegro</b>	4	1	11300	0	0	11300	0
<b>Serbia</b>	13	34	124784	620	1470	126874	132260

Source: [1]

If one looks natural disasters in Albania, it can be noted that the greatest damage in the last six years, suffered in 2012, when Albania suffered of extreme temperatures and only this occurrence took 5 lives. The emergence of the homeless as the cause of the earthquake was in 2010 when it hit as many as 150 persons. In addition to these, Albania has felt the consequences of natural disasters back in 2009 and 2010, as a result of floods, which had high consequences for human lives and economic losses.

Bosnia and Herzegovina in the period from 2008 to 2013 faced a natural disaster of large proportions. These are natural and climatic changes which claimed totaling as many as 10 human victims. As a result of extreme temperatures in 2009, 2010 and 2012 have lost their lives 7 people, while the rest of the casualties took the natural disasters that occurred in 2010 when they recorded a large-scale floods that have caused the economic loss of 87 million dollars.



The observed 6 years Macedonia and Montenegro did not have major consequences of natural disasters in relation to other observed countries of the Western Balkans. In the case of Macedonia, was recorded only 2 adverse natural events and to floods and extreme temperatures, which claimed one human life, where not caused economic losses. When it comes to Montenegro, she had 4 adverse natural events which took one human life and hit 11300 persons.

Beginning in 2008, Serbia was faced with the largest negative effects of natural disasters compared with other Western Balkan countries. The biggest disasters in 2010 were related to as much as 6 adverse natural events of which Serbia experienced floods 3 times, 2 times of extreme winter temperatures and the earthquake that caused extensive damage of 132.26 million dollars, left people without homes and took people's lives. Ice wave in 2012 took as many as 25 lives. In addition to Bosnia and Herzegovina, Serbia is a country that has had a large economic losses of all natural disasters that can be measured 132,260,000 dollars. For small open economies, such as Serbia, it can have major consequences on the development of agricultural production, which makes the main branch of economy of the country.

#### THE IMPACT OF NATURAL DISASTERS ON AGRICULTURAL PRODUCTION AND ECONOMIC ACTIVITY IN THE WESTERN BALKANS

For the majority of the Western Balkan countries agriculture is a key economic activity. Bearing in mind that they still lag with the implementation of reforms aimed at the transition to a market economy, agriculture still has a significant share in creating the GDP by almost all countries in this group. In order to comprehend the importance of agriculture for the countries of the region Figure 1 shows the movements of GVA in agriculture, given as a share of GDP.

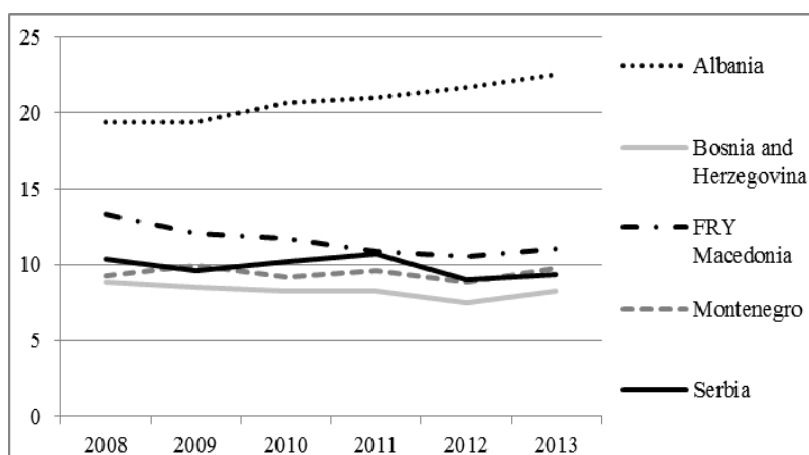
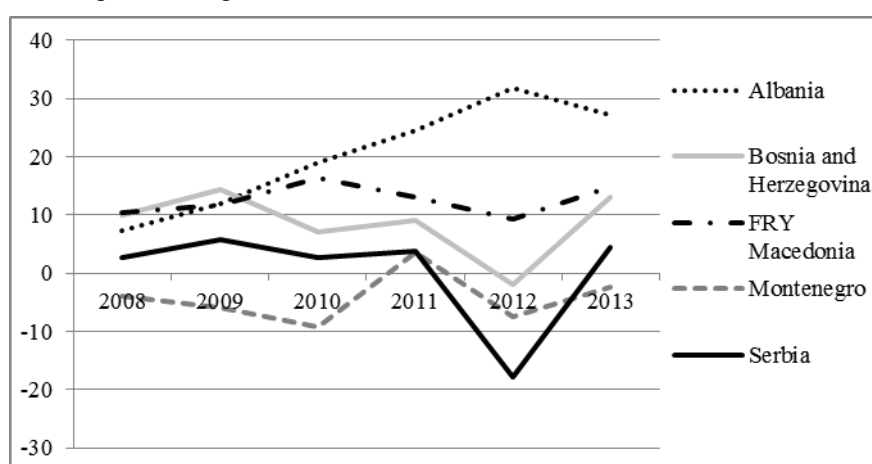


Figure 1. The trend of GVA in the Western Balkans 2008-2013  
Source: [5]

On the basis of Figure 1 it can be concluded that the largest share of GVA in agriculture in GDP has Albania. This share was 19.4% at the beginning of the period, and during the period it is continuously growing and has reached a value of 22.5%. Slightly lower share of GVA has Macedonia, where it is constantly declining, recording a decline from 13.3% to 11%. GVA in agriculture in Serbia and Montenegro is about the same and ranged around 10%, with minor variations. The lowest value of GVA throughout the period had Bosnia and Herzegovina, about 8%.

Bearing in mind that agricultural production largely depends on climatic conditions, natural disasters undoubtedly negatively affect its trend. This is especially true for the observed economies that are facing with numerous development obstacles in the transition process. In order to comprehend the impact of natural disasters on the agricultural production volume in the observed countries, Figure 2 shows trend of the agricultural production growth rate in the Western Balkan countries.



**Figure 2.** The agricultural production growth rate in the Western Balkan countries 2008-2013 during the period 2008-2013

Source: [3]

From the Figure 2 it can be noticed that the agricultural production growth rate in Albania recorded a dynamic growth by 2012 (from 7.3% in 2008 to 31.7% in 2012), and then it was recorded a decrease in 2013. Such trend of the given indicator indicates that the floods in 2009 and 2010 and the extreme temperature in 2012 did not significantly affected the agricultural production, and that they were not the larger scale natural disasters. Macedonia recorded a relatively stable agricultural production growth rate (with average rate amounting 12.4%). A significant decline of agricultural production occurred in 2012, due to the extreme temperatures recorded in this country. On the other hand, the floods that befell the country in 2013 did not significantly affect the level of agricultural production.

Bosnia and Herzegovina recorded two significant reduction of agricultural production growth rate - one in 2010, due to floods and extreme temperatures, and second, even more intensively, in 2012, when catastrophic floods hit the country.

Although the country was faced with floods and extreme temperatures in 2009 also, they were not so be disastrous for agriculture, such as those in 2010. At the end of the reporting period, agricultural production growth rate in Bosnia and Herzegovina amounted 13.1%, which is 3.2% more than in 2008.

During the period 2008-2011, Serbia had a relatively stable rate of growth of agricultural production, amounting 3.5% on average. This low average growth rate is certainly the result of numerous natural disasters recorded in this country. However, they were not even half devastating as floods that hit Serbia in 2012, bearing in mind that there has been a sharp decline in agricultural production in that year (the rate of growth of agricultural production amounted to -17.9%). During the next year, it was recorded some recovery in this area of economic activity, enabling Serbia to record an agricultural production growth rate of 4.5% at the end of the period. Finally, Montenegro recorded a negative growth rate of agricultural production during the almost the entire observed period (except in 2012). The average growth rate in the country amounted to -4.3%. Negative growth rates in 2009 and 2010 is certainly attributable to the floods that hit the country. Also, a significant decline in production in 2012 was in large extent a result of the extreme temperatures recorded in this country.

From simultaneously analysis of previous presented figures it can be concluded to what extent the dynamics of agricultural production affected the economic growth in the observed economies. In this regard, Figure 3 shows trends in growth rates in Western Balkan countries during the analyzed period.



**Figure 3.** The trend of growth rate in the Western Balkan countries 2008-2013  
Source: [5]

Based on Figure 3 it can be noticed that Albania recorded a constant decline in growth rate and it has decreased from 7.5% in 2008 to 1.1% in 2013. At the same time, it should be borne in mind that the country recorded a significantly lower fluctuations of this indicator than other observed countries and a positive growth rate over the entire period, which enabled it to record an average growth rate of 2.7%. These relatively

favorable economic performances are largely the result of the considerable increase in agricultural production, bearing in mind that this economic activity has a significant share in GDP of the country.

On the other hand, Montenegro recorded the highest variation of growth rate in the reporting period. This economy had the sharpest decline in production among the observed economies. It was recorded in 2009 when the growth rate decreased by 12.6% compared to the previous year and amounted to -5.7%. Next, somewhat lower, decline in economic activity was recorded in 2012, when the growth rate amounted -2.7%. Bearing in mind that agriculture has no significant share in GDP of the country, it can be concluded that this activity has not largely contributed to this situation in the Montenegrin economy, except to a lesser extent in 2012 when it recorded a sharp decline in agricultural production.

Macedonia recorded a slightly lower growth rate fluctuations. This country had a significant decline in economic activity in 2009, due to the effects of the global economic crisis. After that, it recorded the fall of growth rate in 2012 too, and that fall was in great extent the result of drop in agriculture production due to extreme temperature recorded in a given year. The average growth rate in this country was 2.1%.

Growth rates in Bosnia and Herzegovina and Serbia followed almost the same trend. Firstly, these countries had a significant fall in economic activity in 2009, due to effects of global crisis, and, in Serbia, also due to fall in agriculture production. The next drop in growth rate was recorded in 2012 and it was merely result of the drop in agricultural production due to extreme temperatures recorded in both countries in a given year. Both countries have recorded an average growth rate of 0.9%.

## **CONCLUSION**

The paper represents a small part of global economic and environmental problems created by climate change and which affect all countries. The risks of natural disasters are great, especially for small open economies, such as the Western Balkans. These countries are faced with numerous natural disasters in the reporting period, but Bosnia and Herzegovina and Serbia suffered the greatest damage. Natural disasters in some countries were so devastating, so they greatly affected the volume of agricultural production. The decline of agricultural production caused by natural disasters was reflected on economic growth in most of these economies, bearing in mind that they have a significant share of agriculture in GDP.

In order to reduce the impact of natural disasters on the socio-economic development, it is necessary to provide adequate and punctually management of natural disasters, which will include an early measurement of natural disasters risks and, accordingly, the formulation of policy for development of the national economy. To achieve this goal, the Western Balkan countries should follow the rules and regulations in this area which are implemented in developed economies of the EU.

## **REFERENCES**

1. Centre for Research on the Epidemiology of Disasters, EM – DAT, [http://emdat.be/country\\_profile/index.html](http://emdat.be/country_profile/index.html)
2. Food and Agriculture Organization of the United Nations, (2015), The impact of disasters on agriculture and food security, FAO, Italy.
3. FAOSTAT
4. Klomp, J. (2016). Economic development and natural disasters: A satellite data analysis. *Global Environmental Change*, Vol. 36, 67-88.
5. World bank database.



## THE IMPORTANCE OF SUSTAINABLE AGRICULTURE ON THE EXAMPLE OF RED WORMS COMPOSTING

Misko M. Milanovic<sup>1</sup>, A. D. Markovic<sup>2</sup>, M. S. Ilic<sup>2\*</sup>

<sup>1</sup>University of Belgrade, Faculty of Geography, Belgrade, SERBIA

<sup>2</sup>Local ecological movement, Smederevo, SERBIA

\*[lepsmederevo@gmail.com](mailto:lepsmederevo@gmail.com)

### ABSTRACT

Application of worm composting in agricultural production is the best way to achieve sustainable development of agriculture. Soil, as the main, (non)renewable resource for agricultural production, is populated by numerous strains of bacteria that allow plants to absorb micro and macro elements. Fertility depends on the number of bacteria, and the number of strains. Wind erosion, denudation, as well as excessive irrigation and drought, and the most of all abundant usage of chemical agents in intensive production, lead to decrease in the percentage of humus in the soil i.e. extinction of saprophytic microorganisms [1]. As it is known from the first civilizations that the worms are credited for emergence of fertile layer of soil, so in the second half of the last century at the University of California, Berkeley was carried out the selection of red hybrid, here known as red Californian worm, as a species

which due to their rapid metabolism and reproduction, is suitable for intensive cultivation, and it helps us to be able to at least stop deterioration of our fertile soil [2]. Manure, as a raw material, contains micro and macronutrients originating from food for livestock, as well as bacteria that were used by cows to digest food. Digesting manure further on by bacteria which they excrete from their glands in their digestive tracts, worms additionally enrich their excrement with new strains of bacteria. Using red worms composting, we return to the soil micro and macronutrients which we took out by plant production, but what is more important we spread out microorganisms that make soil fertile. Using row (chemical, thermal and mechanical non treated) red worms composting in which there are both adult red worms and cocoons (red worms' eggs which can hatch up to 20 worms), we inhabit the soil with the same fauna that participated in its genesis, enriching and diversifying the ecosystem. Considering that red worms for their own nutrition need manure that is fresher than the one safe to use in fertilization of soil, the danger of underground water flows pollution by stocking that lasts up to 3 years is also decreased. Worms itself (live or processed), due to its protein structure, can be used as stover [1].

**Key words:** red worms, red worms composting, sustainable agriculture, soil, saprophytic bacteria.

### INTRODUCTION

Agriculture as a primary industry has as their primary objective the provision of sufficient quantities of food for the needs of the population. Development of agricultural production had a substantial effect on many socio-economic processes during the development of human civilization. Basic resources in agricultural production is cultivable land. Cultivable land (arable land, fertile soil) is a layer of variable depth (up

to about 80 cm), consisting of sand, clay, fly ash and contains the micro and macro elements and organic matter-humus.

It was formed the first decomposition wall, then rotting plant and animal remains and processing the same by worms. The latter, the land is populated saprophytic strains of bacteria to make the land fertile. This process lasted from the formation of the Earth and in places where there was no man's influence, he still continues. Because of the need for intensive agriculture (high profit), the man broke biochemical processes that led to the creation of fertile soil, and the unreasonable, excessive and unfounded use agro-technical measures, irreversibly destroys the layer to which we owe own survival.

The function of humus in the soil is dually On the one hand changes the physical properties of the soil such as sandy seems less permeable, clayey soil seems looser and airy. On the other hand, thanks to saprophytic micro-organism make plants available to micro and macro elements. The percentage of humus in arable land is steadily and continually reducing wind erosion, denudation and drought, and in situations where there is a watering (which is often unnecessarily abundant) and intensive use of synthetic pesticides and chemical fertilizers, we can talk about the progressive degradation of arable land, because the chemical inputs reduce the number of saprophytic bacteria, as well as the number of their strains. So coming into a situation that we need more and more chemical inputs, which further accelerates the implementation of a dying land.

### **RED CALIFORNIAN WORMS (RCW)**

The fifties, at the University of California, Berkeley, methods of selection of species and emphasizing its most desired features, separate the type of red worms with the best characteristics for intensive cultivation. It should be noted that it was not about crossing species or genetic engineering. Advantages in comparison with other worms are the following:

- 3,5-4 times faster propagation
- 800 times denser population per unit volume of habitat
- 8-60 times smaller habitat depth (25 cm compared to 2-6 meters)
- 4 times longer lifetime
- many times faster metabolism (eating food equivalent to their weight for 24 hours)
- lower sensitivity to temperature fluctuations [3].

### **RED WORMS COPOSTING**

RCW are not demanding when it comes to food. But in terms of the quality of earthworm like the final product is best to use sheep, horse, beef and rabbit manure. Worms manure steam with the help of bacteria secreting glands in their digestive tract and which, together with excrement eject. Excrement RCW-a is called red worms composting and except the micro and macro elements and bacteria that prompt of manure which was used as food, including new strains of bacteria. So that the process of creation cultivable land to which they are most deserving worms in nature, which lasted

for thousands of years, now with the help of industrially (intensively) cultivated Californian worms is significantly cuts. Overall quality of red worms composting depend as from the food that feeds the worms, so and from many factors that followed production cycle - air temperature and litters, wetness in litters, the amount and frequency of rainfall or irrigation, po interval division litters, the impact of predators, polutation size, involvement of owners of farms and so on. Red worms composting high quality has 40-45% of humus. In addition, for quality determination, is important difference in the value of the pH of water and the pH in the acid, then the ratio of carbon and nitrogen, as well as the quantity and the ratio of humic and fulvic acids. If these items are in the upper limit, the amount of micro and macro elements in red worms composting, as well as the content of the treated soil is of secondary importance. Since in this case receives a land that is hygroscopic, loose and rich in oxygen, from which plants can to take micro and macro elements when and how they need.

**Table 1.** Comparative comparison of properties red worms composting and manure

	RED WORMS COMPOSTING	MANURE
humus	40-45%	< 7-8%
number of saprophytic organisms	10x10 <sup>8</sup>	10x10 <sup>5</sup>
range of application	daily	every 3-4 years
structure	crumbly	compacted
mechanical impurities	does not have	there is
content and quality	equable	uneven
application	anywhere	limited

Source: (amended and supplemented Marković A., 2015).

**Table 2.** Comparative comparison of properties red worms composting and artificial fertilizers.

	RED WORMS COMPOSTING	ARTIFICIAL FERTILIZERS
humus	40-45%	0%
number of saprophytic organisms	10x10 <sup>8</sup>	0
humic and fulvic acid	there is	does not have
population of earthworms	there is	does not have
micro and macro elements	are all	5-6
Ph	5,5-7,5	<6

Source: (amended and supplemented Marković A., 2015).



## USE OF RED WORMS COMPOSTING

Red worms composting have the broadest possible application in all areas of agricultural production, both organic and conventional. Indispensable when raising plants, whether it is about varieties of fruit or reforestation because only red worms composting has the property that it can be when planting to pour into the very pit planting, in direct contact with the root system, because of all their characteristics listed above will not take you to the "burning" of the plant. Using the red worms composting in the root zone improves loose ground and root can easily and quickly developing. Also, because of their expressed hygroscopicity, allows seedlings growth and development and in cases of insufficiently rainfall, or insufficient watered. And in all this, in zone the most intensive operation of the root system bring all necessary micro and macro elements. Use in already raised plantations leads to a balance fruit trees. Now that the plants adopt what, when and how they need from micro and macro elements, decreases exuberance, and increasing differentiation vegetative buds in gender, reducing the risk of alternative fertility, provides the not overflowing already permanent and normal yield per unit area. By strengthening the country settling by the microorganisms, strengthens the plant itself which become resistant to viruses and bacteria. This is the way that reduces the need for synthetic pesticides that led to reduced quality of land. Practice has shown improvements in the case of timely coloring fruits and earlier fruit ripening which has a positive effect on the market.



**Figure 1, 2 and 3.** Agricultural farm Marković, Ajdared apple variety, the harvest in the first decade of September (author: Ilić M., 2015).

Continuous application of red worms composting improves organoleptic characteristics of the fruit, increasing the amount of ascorbic acid, timely resistance to rejection of fruits, and reducing collaps of the fruits during storage.

Because of its loose and crumbly structure is suitable for mixing with other elements when preparing the substrate which is used in the production of plants for planting, as well as in the production of vegetable crops. If the red worms composting obtained by processing only manure without any extras whether it comes to the production or packed, then we can talk about a clean and concentrated of red worms composting. That red worms composting entails lower transportation costs, because it requires a small amount of percentage when mixing with other elements of the substrate. On the other side, as studies have shown the red worms composting either alone or as an element of the substrate, give considerable contribution to the quality of plants for planting [4].

Entering raw red worms composting, which is not a mechanical, chemical and thermal treatment, inhabit the lands with worms, but what is more important and cocoons from which can incubate for up to 20 worms. If we added like agro technical measure mulching plants residues, that after the process of rotting present food for worms, then it increases the chances of survival of worms, we might say that in this case we have a daily renewal of land. The only fault was observed that after ejection in the open field, with mechanical treatment should be entered in the land (or at least mixed) ie. prevent dry up red worms coposting, which would reduce the number of saprophytic organisms.

#### **OTHER POSSIBILITIES OF APPLICATION WORMS AND RED WORMS COMPOSTING IN SUSTAINABLE AGRICULTURE**

With the development of society, there has been an increase in urban areas, which is among other environmental problems leading position occupied the city landfill problem. Citizens throw waste near watercourses which environmental awareness is no promising character. Educating people and the development of environmental ethics, would reduce the deficit of moral values to the environment [5]. So we all organic waste ( remains of food and remainders when preparing the same, cardboard packaging, waste paper, grass clippings) could be used as food for worms.

Waste water sewage, as a direct polluter of watercourses, indirectly pollute and reduce productivity of land resources, through shallow freet issued that used for irrigation (Ilić M., Milanović M. 2015). At the beginning of the development lumbriculture worms are used for the treatment of urban sewage sludge. Unfortunately that was dropped. The main reason for this was that in just dehydrated sludge was large amounts of heavy metals, that impede, and even disable multiply worms but in some cases came up to death. Also thus obtained red worms composting, contained in itself heavy metals, and as such it was not suitable for use in agricultural production of food, but only for fertilizing forests and horticulture. Today, thanks to the development of science and technology, there have been advances in technology and the processing of waste water, so from the scientific, economic and environmental aspects were interesting, right through the sightseeing, try again.

From the aspect of sustainable development of agriculture is important to mention the possibility of using RCW and for animal feed. RCW one containing about 1 g. protein and is a natural food, the same one that would breeding species consume and live in the countryside. For feeding cows, bulls, horses was used in refined protein flour, while for pigs, mercury and fish can also be used live.

In this regard, the fact that in the processing industry of agricultural products receives a large amount of waste, that represents an environmental problem and therefore negatively affect the sustainable development of agriculture. In many cases, such a bin contain fruit sugars that as well as other types of sugar stimulated multiply of RCW. The farm-RCW which would benefit from this kind of food, would be focused on the production of worms, for mentioned above, animal feed. It should cite the fact that it was such a waste must first undergo a fermentation process (leavening, composting), with the addition of 5-15% of manure, to increase the number of microorganisms.

### CONCLUSION

From all the above it can be concluded that lumbri cultura and application red worms composting can play a major and indispensable role in the sustainable development of agriculture. This role can be viewed from several aspects. Development lumbri culture will open for now not existing, work places. The resulting drives for production and processing red worm composting which do not have a chimney and wastewater. Would solve the problem with waste companies for the production milk and fattening animals, abattoir and the meat processing industry, industrial processing of agricultural products, city sewage, and with a little training and goodwill the city's landfill problem would be significantly reduced. Would create a basis for serious and advanced organic production. In the current conventional production stopped to further deterioration and disappearance of fertile soil, would be reduced the use of synthetic pesticides, to get a delicious, healthy and market-competitive fruits, and yields to become more balanced and more in the aggregate. As the problems that stand in the way of development lumbri culture, I'd pick poorly developed legislative activity, whose authors are not seeing all of the above facts, however, the issue of access sloppy and incomplete. In this connection is not loyal competition, that because lack of market control, has the ability to "entrepreneurial inventiveness." as well as insufficient awareness of individual farmers.

### REFERENCES

1. Марковић А. (2015): „Примена глистењака – одрживи развој пољопривреде“, књига апстракта 4. Српски конгрес географ са међународним учешћем: Достигнућа, актуелности и изазови географске науке и праксе поводом 150 година рођења Јована Цвијића – Копаоник, Универзитет у Београду, Географски факултет, Српско географско друштво, Београд, стр. 254 – 255.
2. Mitrović M. (1999): „Lumbrikultura – gajenje glista“, Nolit, Beograd.
3. Rajković N., Minić B. (1986): „Gliste-humus“, Ekonomski biro, Beograd.

4. Đorđević N., Marić M., Aleksić V., Dželatović S. (2004): „*Upotreba organskog đubriva – glistenjaka u organskoj poljoprivredi*“, Ekološka istina 2004, Borsko jezero, Univerzitet u Beogradu, Tehnički fakultet u Boru, Bor.
5. Ilić M. (2015): „*Monitoring i oditing površinskih voda Grada Smedereva – problemi zagađenja površinskih voda*“, Zbornik sa osmog naučno – stručnog skupa sa međunarodnim učešćem: Planska i normativna zaštita prostora i životne sredine – Palić, Asocijacija prostornih planera Srbije, Univerzitet u Beogradu, Geografski fakultet, Beograd, str. 265 – 271.
6. Ilić M., Milanović M. (2015): „*Primena oditinga voda Grada Smedereva na primeru industrije*“, Zbornik sa trećeg naučno – stručnog skupa: Politehnika 2015 – zaštita životne sredine, reciklažne tehnologije, dizajn i tehnologije, menadžment kvalitetom, bezbednost i zdravlje na radu – Beograd, Visoka škola strukovnih studija – Beogradska politehnika, Beograd, str. 84 – 89.



## INVESTMENT TREATY CLAIMS CONCERNING ENVIRONMENTAL LAW CHANGES

**Bojana Babic**

Belgrade, SERBIA

*bojana.babic57@gmail.com*

### ABSTRACT

Practice of the arbitral tribunals resolving investment treaty claims is still divided in respect to the state's right to regulate through non-discriminatory actions, *inter alia*, the environment without providing compensation for indirect expropriation of foreign investor's property. Just a few international agreements introduced provisions which clearly govern this subject matter and material criteria establishing whether an indirect expropriation resulting from change of environmental regulations requires compensation or not. Having failed to determine the above noted expressly in international investment treaties and agreements, every signatory state is exposed to a risk that different tribunal ruling on investment treaty claim may interpret such legal lacunae in favor of foreign investor.

**Key words:** ICSID Center – fair and equitable treatment – indirect expropriation – state liability.

### INTRODUCTION

Companies established in developed countries often shall decide to move its production from country-of-origin to third states (non-developed countries or developing countries), motivated by reduction of costs necessary to comply with strict requirements imposed by environmental regulations in country-of-origin.[1]

This paper aims to identify legal basis for investment treaty claims concerning environmental regulations, which can be potentially filed by the foreign investor against the host state in the arbitration procedure before the International Centre for Settlement of the Investment Disputes (ICSID Centre).[2]

First part of the paper shall explain role of the environmental regulations in investment decision process of each foreign investor. Second part shall shed some light on the legal basis for investments claims and will continue in third part with analysis of investment treaty claims concerning environmental regulations before the ICSID Centre. To conclude the article, we shall offer our opinion how to mitigate potential risk and avoid liability.

## **ENVIRONMENTAL LAW**

Corpus of the environmental regulations is constantly and rapidly changing and growing. Facing complexity of the subject matter, especially in era of technological and chemical progressive global evolution it is impossible to list all internationally recognized environmental regulations common to modern society and enacted in all countries. Unified international environmental law is at the moment just a vision.

Endeavors of the economic integrations such as European Union or North America states to unify environmental regulations, adjust, improve and transposit them into local law, and obligations of the potential member states to harmonize its environmental regulations with the regulations of the EU member states in order to access the EU, accelerates day-to-day volatility of environmental regulations. Unpredictable ecological legal framework further may have “butterfly effect” to all other aspects and life of each ongoing project.

It is worthy to point out just one direct effect of environmental regulation change. During the period of license’s validity, competent body in some countries has legal right and obligation to revise already issued Integrated Pollution Prevention and Control license (IPPC license) for the project due to changes in the environmental regulations.[3]

When investing in foreign country, diligent investor shall perform ecological due diligence pertaining to its investment by hiring local council in host state holding for ecological experts. In this case, team of ecological experts shall analyze the legal framework of the host state with purpose to identify all environmental regulations relevant for the development of the project.

Cost sensitive investor might just tackle the issue by conferring this task to its own legal team which is not familiar with local law or might even rely on assurances of the officials of the host state which shall be most probably incorporated in the investment agreement. Such approach in some cases might lead to a risk of omission to identify certain step, all procedural requirements and timeline for issuance of the permit or license that is required for full development of the project that is sensitive to the environment.

## **INVESTMENT TREATIES AND STANDARDS**

Most of the treaties relevant to investments, concluded on bilateral basis between two states (bilateral investment treaty or BIT)[4] or regionally or multilateral and bilateral free trade agreements with investment provisions[5], impose international obligation to the contracting states to provide fair and equitable treatment (FET) and to compensate the investor for expropriation.

FET standard counts as substantive standard and one of the fundamental principles found in each investment treaty encompassing certain components, i.e. aspects such as legitimate expectations, stability and predictability of the legal framework, arbitrary or discriminatory conduct, transparency and procedural fairness, unreasonableness and other aspects.

Legitimate expectations as the ultimate element of this standard are interpreted in *Biwater Gauf* case by the arbitral tribunal as follows: “the purpose of the fair and equitable treatment standard is to provide to international investments treatment that does not affect the basic expectations that were taken into account by the foreign investor to make the investment, as long as these expectations are reasonable and legitimate and have been relied upon by the investor to make the investment.”[6]

If one put FET standard in context of environmental regulations, arguably the main function of this standard is to provide the investor with legal instrument to protect its legitimate expectations with respect to predictability of the legal framework in host state, transparency and procedural fairness whenever ecological concerns embodied in legal provisions are involved. Consequently, there is always a possibility that the tribunal will find existence of the breach of FET due to newly introduced changes in the law.

The other relevant obligation undertaken by states in investment treaties is to compensate the investor for expropriation of the investment, including indirect expropriation (“creeping expropriation”) and measures tantamount to expropriation. Case law and jurisprudence accepted the standpoint that depreciation of value of overall investment, i.e. when production costs increase and material adverse effect occurs as result of ecological regulation enactment represents indirect expropriation.[7]

Customary international law recognizes principle that the state has to pay promptly to investor whenever the following conditions are met: the taking of the investment is made for a public purpose, as provided by law, in a non-discriminatory manner and with adequate compensation. According to some legal writers, however there has to be distinction between compensable and non-compensable expropriation, whether direct or indirect. Some writers are of the opinion that non-discriminatory measures related to environmental protection are non-compensable takings since they are regarded as essential to functioning of the state. Differently expressed, state is not responsible for loss of property or for other economic disadvantage resulting from *bona fide* environmental regulation if it is taken within the police power of the states, and if it is not discriminatory.

In the light of the above said, in each case the tribunal shall determine what situation should be considered as indirect expropriation and if there is exception where the state shall not pay compensation. Numerous cases resolved before ICSID Centre already showed that in connection with the investment treaties “the provisions designed to ensure security and predictability for the investors have now created uncertainty and unpredictability for environmental (and other) regulators”.[8]

If we compare situation with GAAT[9] provisions where Article XX(b) provides for exceptions for trade-restrictive measures “necessary to provide human, animal or plant life or health” and Article XX(g) provides an exception for measures “relating to the conservation of exhaustible natural resources if such measures are made effective in conjunction with restrictions on domestic production or consumption”, we can clearly see the difference.

Contrary to this, investment treaty will highly unlikely provide an exception for investment-restrictive measures, including environment-related measures. In some investment treaties there are positive outcome of efforts to find common ground between sovereign authority of the state to enact environmental regulations and to respect

fundamental standards in investment treaties by introducing the non-precluded measures clause (NPM clause). NPM clause is invented to enable the state to carve out undertaken obligations under investment treaty and substantive standards of protection of investment in certain situations. Namely, NPM clause sets out exceptions from state's liability for conduct in respect to environmental regulations and measures. For example U.S. model of BIT's provide that "nothing in this Treaty shall be construed to prevent a Party from adopting, maintaining or enforcing any measure otherwise consistent with this Treaty that it considers appropriate to ensure that investment activity in its territory is undertaken in a manner sensitive to environmental concerns".

### **LIST OF NOTABLE ICSID CASES**

ICSID Centre stands for reputable forum for dispute resolution between states and foreign investors. We would like to draw attention to the most famous cases in connection to the environment protection which serve as the benchmark for all future cases to come. Here we intend to underline how case law may vary on case-to-case basis when investment treaty claim concerns environmental regulations.

#### **Metalclad Corp. v. The United Mexican States**

The tribunal appointed before the ICSID Centre decided that Metalclad as investor was not treated fairly and equitably under NAFTA and adopted its investment claim against The United Mexican States under Article 1105 of NAFTA. Article 1105(1) of NAFTA provides that "each Party shall accord to investments of investors of another Party treatment in accordance with international law, including fair and equitable treatment and full protection and security.[10]

Facts of the case were that Metalclad as the foreign investor in Mexico had the project to construct and operate a hazardous waste landfill in the valley of La Pedrera, in Guadalucazar, SLP on the land that acquired. The project was fully approved and endorsed by the federal government who issued federal construction and operating permits. Apart from this, Metalclad was led to believe and did believe that the federal and state permits allowed for the construction and operation of the landfill. Relying on the representation of the federal government, Metalclad started constructing the landfill and did this openly and continuously and with the full knowledge of the federal, state and municipal governments, until the municipal "Stop Work Order" had been issued, which stated that Metalclad failed to obtain municipal construction permit.

In the light of the stated assurances of the federal officials, Metalclad believed that it was entitled to continue its construction works and further following the advices of these officials it filled municipal permit application after the order was issued in full expectations that the permit would be granted. The Municipality denied Metalclad's application for reasons which included among others ecological concerns regarding the adverse environmental effects of the hazardous waste landfill and impact on the site and surrounding communities. Even further SLP issued an Ecological Decree which effectively and permanently prevented the use by Metalclad of its investment, by announcing the acquired land for landfill to be national park.



The arbitral tribunal found that Municipality acted outside its authority and denied construction permit without any basis in regulations and thus effectively and unlawfully prevented the investor's operation. The undertaken measures together with the representations of the Mexican Federal Government, on which Metalclad relied and absence of timely, orderly or substantive basis for denial of the construction permit amount to indirect expropriation.

Expropriation under NAFTA includes not only open takings of the property, but also covert or incidental interference with the use of property which has the effect of depriving the owner, in whole or significant part of the use or reasonably-to-be-expected economic benefit of property.

It is worthy of emphasizing that the tribunal in its reasoning noted that Metalclad was "entitled to rely on the representations of federal officials" because it "was led to believe, and did believe, that the federal and state permits allowed for the construction and operation of the landfill".

It is undisputable in legal writings that this aspect of the award is notable as an example how a claimant in investment dispute "can prevail on a stability and predictability – based FET claim if it can show that it relied on specific assurances." [11]

#### **Compañía del Desarrollo de Santa Elena v. Costa Rica**

Tribunal in this ICSID case rendered award expressly in favor of compensation without any concern in respect to environmental regulations. The tribunal stated:

"Expropriatory environmental measures – no matter how laudable and beneficial to society as a whole – are, in this respect, similar to any other expropriatory measures that a state may take in order to implement its policies: where property is expropriated, even for environmental purposes, whether domestic or international, the state's obligation to pay compensation remains."

#### **Técnicas Medioambientales Tecmed S.A. v. The United Mexican States**

The investor, Técnicas Medioambientales Tecmed, S.A. filed a claim alleging that the Mexican government's failure to re-license its hazardous waste site was an expropriatory act.

Here, the arbitrators in order to determine whether the acts undertaken by Mexico were to be characterised as expropriatory, citing the ECHR's practice in award, considered "whether such actions or measures are proportional to the public interest presumably protected thereby and the protection legally granted to investments, taking into account the significance of such impact plays a key role in deciding the proportionality". They added that: "there must be a reasonable relationship of proportionality between the charge of weight imposed to the foreign investor and the aim sought to be realised by an expropriatory measure".

This case is significant because the tribunal found contrary to the previous two that this state action is non-compensable takings. It reasoned that: "the principle that the state's exercise of its sovereign power within the framework of its police power may

cause economic damage to those subject to its powers as administrator without entitling them to any compensation whatsoever is undisputable.”

**Zelena N.V. (Belgian), Energo-Zelena d.o.o Indija (Serbian) v. Republic of Serbia**

This is still pending ICSID case where Zelena N.V. (Belgian) and Energo-Zelena d.o.o Indija (Serbian) submitted investment claim against Republic of Serbia.

Zelena N.V. (Belgian) and Energo-Zelena d.o.o Indija (Serbian) filed investment claim against Republic of Serbia at ICSID Centre[12], citing the government failed to enforce its own legislation concerning the treatment of animal by-products, thus jeopardizing the viability of Energo-Zelena’s operations. The enterprise issued a press release at the time, saying it had suffered substantial and recurrent damage and losses and that it had been “continuously exposed to unfair competition and blatant discrimination. According to the available public information, IPPC license has been given to Energo-Zelena d. o. o., plant for treatment of hazardous animal by-products, six months after ending its operations due to the non-implementation of the Serbian laws and regulations.”[13]

This ICSID arbitration is based on alleged breach of BIT between Republic of Serbia and Belgium-Luxembourg[14], i.e. breach of FET standard and indirect expropriation of the investment in question. Claims arose out of the Government's alleged failure to enforce legislation on the handling of hazardous animal by-products equally among Zelena and its competitors, rendering the claimant's operation of an animal-rendering facility unviable.[15]

According to the cited published article, 11 IPPC permits have been issued in Serbia. Five are for new and six for old facilities. There are 165 old facilities in total, including the six mentioned above, which have to get the IPPC permit by 2020.

Having in mind significance of IPPC license in terms of satisfaction of the strict requirements for safeguard measures in connection to the protection of environment, this case clearly shows double standards of the state towards old and new facilities. If the investor succeeds in this dispute, this can potentially lead to the investment claims against the state for each new project that requires IPPC license in similar circumstances.

**PERSPECTIVES**

The investor is always driven by profit and it is logical that he might not base his decision on care for environment especially when investing in foreign country. Hence, analysis of the environmental regulations may become matter of perspective.

Should the best practical solution be for the investors to acquire only existing plants in non-developed country and to operate without IPPC license until deadline expires and be in line with the law notwithstanding the environment protection, i.e. pollution prevention and control? This approach is successfully tested in practice in financial sector when foreign banks are acquiring domestic banks with operational licenses. Difference is that operations of the banks with foreign shareholders will not jeopardize health and environment.

However, if environmental law changes it is disputable whether the claim will be objectively reasonable and not based upon investor's subjective expectations. The ground for this standing is once found in Oscar Chinn case from 1934 where the Permanent Court of International Justice refused to accept the contention of indirect taking. It noted that, in those circumstances, a granting of a de facto monopoly did not constitute a violation of international law and that "favourable business conditions and good will are transient circumstances, subject to inevitable changes": "No enterprise...can escape from the chances and hazards resulting from general economic conditions. Some industries may be able to make large profits during a period of general prosperity, or else by taking advantage of a treaty of commerce or of an alteration in customs." Hence, investor who makes large profits due to circumstances where IPPC license is not required for some period of time, arguable cannot base its claim on its subjective expectations that such regulations will not change.

On the other hand, second scenario can be in establishment of the new company, file for IPPC license, and then to cease operations if there is no desirable profit and sue the state for breach of FET and discrimination because the other companies. i.e. investors operate without IPPC license.

In any discussed case above, the state may be found liable and shall potentially pay damages to investor or to people due to pollution of the environment.

It is also disputed what legitimate expectations investor can essentially have in terms of FET clause, when there is minimum standard of corpus of environmental rights protected in customary international law and practice which has to be incorporated in new and upcoming environmental legislation. Can it be even considered as *bona fidae* when it is common opinion present about corpus of environmental rights and obligations and standards, and is it even in theory possible to prove that investment is based on state of affairs that does not include the challenged regulatory regime.

## CONCLUSION

Julius Ceasar said "If you must break the law, do it to seize the power: in all other cases observe it."

In order to observe the law, there must be the law. In our opinion one of the legal solutions can be found in introducing into the existing or new investment treaties similar provision as model of USA BIT has:

"Except in rare circumstances, non-discriminatory regulatory actions by a Party that are designed and applied to protect legitimate public welfare objectives, such as public health, safety and the environment, do not constitute indirect expropriations"

The updated Canada's model of Foreign Investment Promotion and Protection Agreement stipulates also that clarification of indirect expropriation which provides that, except in rare circumstances, non-discriminatory measures designed and applied to protect legitimate public welfare objectives, such as health, safety and the environment, do not constitute indirect expropriation and are not subject, therefore, to any compensation requirements.

In addition, states can stipulate NPM clause and protect from the risk of liability for regulatory changes sensitive to environment.

To conclude, raising the awareness and transparency during the whole investment procedure especially when the investment is sensitive to ecology is *sine qua non* for implementation of any foreign investment in the country, especially in situation where the above legal protection still do not exist.

#### REFERENCES

1. Prof. dr Predrag Cvetkovic, Monografija "Strana ulaganja"
2. ICSID Centre was established by the ICSID Convention. ICSID Convention entered into force on 14 October 1966, and it has been ratified by 150 Contracting States. Serbia signed ICSID Convention on 9 May 2007, and it entered into force on 8 June 2007
3. Article 18 of the Law on Integrated Pollution Prohibition and Control of Republic of Serbia (Official Gazette of Republic of Serbia, no. 135/2004 and 25/2015, Zakon o integrisanom sprečavanju i kontroli zagađivanja životne sredine). The new deadline for issuance of IPPC licenses in Serbia for existing plants is 31 December 2020 (previous deadline was end of 2015), which means that every new plant has to have IPPC license, while existing can operate without until end of 2020
4. Serbia concluded 50 Bilateral Investment Treaties, see more on <https://icsid.worldbank.org/apps/ICSIDWEB/resources/Pages/BITDetails.aspx?state=ST119>
5. See more on: <https://icsid.worldbank.org/apps/ICSIDWEB/resources/Pages/Other-Treaties.aspx>
6. Biwater Gauf (Tanzania) Ltd v. United Republic of Tanzania, ICSID Case no. Arb/05/22
7. Rahim Moloo and Justin Jacinto, Environmental and Health Regulations: Assessing Liability under Investment Treaties, Berkley Journal of International Law, Volume 29, Issue 1 (2011)
8. Howard Mann & Konrad von Moltke, NAFTA's Chapter 11 and Environment: Addressing the Impacts of the Investor-State Process on the Environment (International Institute for Sustainable Development Working Paper 1999) 5, Dow AgroSciences LLC v. Government of Canada case, Ethyl Corp & Canada Ethyl Corp v. Government of Canada case, Marion Unglaube v. Costa Rica case, Vattenfall AB. et al v. Germany
9. General Agreement on Tariffs and Trade 1994, see more on [https://www.wto.org/english/docs\\_e/legal\\_e/06-gatt\\_e.htm](https://www.wto.org/english/docs_e/legal_e/06-gatt_e.htm)
10. Article 102(1) of the North American Free Trade Agreement (NAFTA)
11. Rahim Moloo and Justin Jacinto, Environmental and Health Regulations: Assessing Liability under Investment Treaties, Berkley Journal of International Law, Volume 29, Issue 1 (2011)
12. Case was registered on 7 November 2014, and tribunal was constituted on 30 January 2015

<https://icsid.worldbank.org/apps/ICSIDWEB/cases/Pages/casedetail.aspx?CaseNo=ARB/14/27>

13. See <http://balkangreenenergynews.com/energo-zelena-gets-permit-six-months-after-ending-operations/>
14. Bilateral investment treaty is signed between Republic of Serbia and Belgium-Luxemburg on 4 March 2004 and entered into force on 13 August 2007
15. See <http://investmentpolicyhub.unctad.org/ISDS/CountryCases/187?partyRole=2>



## **ECO-LOGISTICS - CONNECTION OF ECOLOGY, ENVIRONMENT PROTECTION AND LOGISTICS**

**Eva Tomkova, E. Mikusova**

Technical University of Košice, Logistics Institute, Faculty BERG, SLOVAKIA

### **ABSTRACT**

The paper presents the partial results of the case study focused on the research of suitable way of connection of ecology, environment protection and logistics. This paper deals with the new approach to an application field of logistics, namely eco-logistics which was defined during the mentioned case study by the researchers of the Institute of logistics, Faculty BERG, Technical university of Košice, Slovakia.

**Key words:** ecology, environment, logistics.

### **INTRODUCTION**

The base of the research problem – connection of ecology, environment protection and logistics, is possible to find in logistics, and therefore, it is suitable and needed to apply with this term. Logistics is currently the base for effectively operating system of control in the industries. Logistics presents multidisciplinary science, of which base is an integration of knowledge and principles from the theory of control, decision-making, optimization, simulation, economy, technique, informatics. The literature sources present definition of logistics by understanding of different authors from different points of view. For example Malindžák (1996) defined logistics as a philosophy of flows selection with application of the system approach, planning, coordination, algorithm thinking with global optimization (1). By the Council of Logistics Management (1996) logistics presents the process for planning, realization, control of raw materials flow and their storage, final product, semi products, services from the point of creation to the point of consumption with satisfaction of consumer demands (2). The Chartered Institute of Logistics and Transport (2011) defined logistics as a tool for allocation of supplies sources by accepting of time schedule, place, price and quality (3).

From the literature sources and also from our own experiences it is possible to say that:

- logistics is a philosophy in the sense of integrated theory of management, control, goods, products, information flows, at the direction from the source to the consumers;
- logistics applies by its realization the theory of systems. The base is created by the system approach and implementation of the methodology consists of system definition, the aim of solution, system analysis, definition of relations among them, synthesis and final evaluation;
- logistics brings implementation of principles of organization and coordination.

These presented ideas create a clearly contents about the current understanding of logistics. But also there is a question, where is the place of ecology and environment protection in the logistics and how is possible to create a connection of ecology and logistics. By the case study we speculated about the answer to these questions by the formulation of new application field of logistics – eco-logistics.

### **DISCUSSION – WHAT IS ECO-LOGISTICS?**

By the approach to the eco-logistics it was speculated with the knowledge of logistics, and also with the knowledge about the environment and ecology. It is needed to emphasize that for the current state of environment it is important to orientate management of logistics activities at the direction of environment care which consists of protection and creation of environment.

Protection of environment brings activities for conservation of the current values, such as energy sources for the present and future and at the same time this emphasizes rational intervention in the environment and its parts in accordance with ecological equilibrium (homeostasis) with minimal negative impacts on the environment (4).

Creation of environment is systematic intentional transformation of the environment, its parts and substances by the current acceptance of the conditions of environment protection (5).

As it was said, these terms present the complex of activities which are included in the environment care, which presents continuous realization of measures in the sense of disposal of negative aspects and effects of anthropogenic activities on the environment and preventive activities, oriented to the negative aspects and effects of anthropogenic activities on the environment, which create a base of eco-logistics.

For the need of ecological understanding of logistics it is important to emphasize ecological approaches of logistics. It is possible to talk about three basic fields:

1. selection of adequate locality for realization of logistics activities with the aim of environment protection;
2. acceptance of legislative related with the parts of environment;
3. additional environment value.

## RESULTS

On the base of these facts, it was formulated the following approach to the eco-logistics: Eco-logistics is an application field of logistics of which main object is control, support and realization of logistics activities with the main criterion – protection and creation of environment, that means environment case (6).

The case study speculated with two elements of eco-logistics, namely with reverse logistics and green logistics. In the case of reverse logistics and implementation of its procedure, the case study drew information from the studies of foreign experts, for example Fleischmann (2001), Georgiadis, Vlachos (2003), Dekker (2004), Fernandez (2004), Škapa (2005), Dejax (2013), Brezina (2007), Guo (2010), Gežik (2012), Divahar, Sudhar (2012). On the base of these information, these facts were applied for reverse logistics – reverse logistics puts the accent on the reverse material flow at the direction from the customer to the producer of the original product or specialized enterprise oriented to the collection/processing of elements of reverse logistics (for example used products, semi-products, wastes, broken products, etc.), for realization of reverse material flow existence of auxiliary operations (transport, storage), emphasis on wastes and waste management with the needed processes oriented to the reduction of wastes. On the base of these knowledge about reverse logistics understanding, the case study speculated with the following approach to reverse logistics: Reverse logistics as a part of eco-logistics deals with control, provide and realization of reverse flows of materials, raw materials in the collecting networks at the direction from the customers to the point of processing (7).

In the case of green logistics is possible to understand the study of the effects of logistics on the environment, and also elimination of negative impacts of logistics activities on the environment. For the green logistics was applied this approach: Green logistics as a part of eco-logistics presents the way oriented on the impacts of enterprise activities on the environment, and it research connection of enterprise logistics activities and the level of environment pollution at the direction of decrease of material and energy intensity of logistics activities in enterprise. On the base of this procedure, it is possible to say, that the aim of the green logistics is study and at the same time minimization of impacts of logistics on the environment, for example by measurement of effects of specific types of transport on the environment, decrease of material and energy inputs to the production process, etc.

Within the frame of management of green supply chain or by the right application of green logistics it is needed to implement three basic approaches (8):

1. approach – reactive approach – enterprise in the supply chain realizes financially unpretentious realization, for example option of product reuse by labelling;
2. approach – proactive approach – its base is a suppose that the enterprise designs green products and also realizes recycling of own products;
3. approach – values – the approach supposes the fact, that the enterprise considers environmental impact elimination as a strategic aim and at the same time implements environmental management systems and tools of green



logistics (for example environmental audit, environmental impact assessment, etc.).

Green logistics presents active approach to environment care, but with comparison with standard characteristics of logistics, respectively logistics systems it has some paradoxes in the field of externalities reduction (Table 1).

**Table 1.** Paradoxes of green logistics (8)

Paradox	Impact	Field of dimension
Often externalization of environmental costs	Decrease of costs on the base of improvement of goods storage and at the same time elimination of wastes from the package	Costs
Extension of production, distribution creates higher energy consumption, production of emissions	Integrated supply chains uses conceptions of just in time and door to door with the asset of flexible and effective systems creation	Time and flexibility
Increase of negative impact on the environment	Increase of effectiveness of the supply chain, distributive systems by the changes in the network, by the system hub and spoke	Network
Impact of transport to the environment	Early and reliable distribution	Reliability
Transfer of supplies to the places of consumption by urban communication, increase of traffic jams	Decrease of needs for private storage devices	Storage
Modification of physical distributive systems leads to increased energy consumptions	Higher rate of business opportunities, diversification of the supply chain	Information technologies

## CONCLUSION

The aim of this paper was to present the partial output of the case study realized by the Logistics institute, Faculty BERG, Technical University. The case study is oriented to the research of possible connection of logistics, ecology and environment protection. For this purpose, the researchers speculated about the new approach to logistics, by the form of eco-logistics. This application field of logistics presents a possible way of connection of logistics and environment protection by managing of logistics activities at the direction of environment care and creation. The basic tools of eco-logistics are green logistics and reverse logistics which present interesting tools for enterprises and organizations for managing of activities with the accent on the legislative in the field of environment protection and also emphasize environmental consciousness.

## REFERENCES

1. Malindžák, D. et al. 2009. Modelling and simulation in logistics/theory of modelling and simulation/ 1<sup>st</sup> ed. Košice: TU. 182 p. ISBN 978-80-553-0265-2
2. Bewersox, D.,J. – Closs, D.,J. 1996. Logistical management: the integrated supply chain process. 1st ed. New York: McGraw – Hill, 1996. 730 p. ISBN 0070068836
3. Rushton, A. – Croucher, P. – Baker, P. 2006. The Handbook of Logistics and Distribution Management. 3rd ed. London: Kogan Page, 2006. 613 p. ISBN 0749446692 citovaná str. 6
4. Law about the environment. (Law No. 17/1992) § 9 Environment protecton. Available: <http://zakonypreludi.sk/zk/1992-17>
5. Environment care. Enviroportal. Information portal of the resort of Ministry of environment of SR. Available: [www.enviroportal.sk/environmentlne-temy/starostlivost-o-zp](http://www.enviroportal.sk/environmentlne-temy/starostlivost-o-zp)
6. Husáková, N. 2014. Possibilites of reverse logistics solutions. Habilitation thesis. TU. Košice. 119 p.
7. Husáková, N. 2008. Reverse logistics of worn down tires in the conditions of SR with the focus on the mining operations. Dissertation thesis. TU Košice, F BERG, 136 p.
8. Lalinská, J. – Kremeňová, I. 2011. Green logistics. In: 12th International Scientific Conference LOGI 2011. p. 252-257. Available: < <http://logi.upce.cz/proceedings/2011/30lalinska-kremenova.pdf> >



## STAKEHOLDER BASED CLASSIFICATION OF SUSTAINABLE INDICATORS IN FREIGHT TRANSPORTATION

Anja Basic<sup>\*</sup>, M. Velickovic

University of Novi Sad, Faculty of Technical Sciences,  
Department of Traffic Engineering, 21000 Novi Sad, SERBIA

<sup>\*</sup>*anjuskab@gmail.com*

### ABSTRACT

Freight transportation have many not desirable external effects related with moving goods by different transport modes. The balance between economic, environmental and social effects should drive the sustainable transportation development. Therefore, there is a need to implement adequate policy instruments which would help to monitor, control and mitigate negative impacts of transportation activities. The paper focuses on the indicators that can be used to measure performance of sustainability in freight transportation. The identified indicators are classified for fast, easy and reliable usage by stakeholders.

**Key words:** Indicators of sustainability, freight transportation, selection and classification.

### INTRODUCTION

The increasing population density in urban areas and traffic activities have harmful effects on living conditions and environment. The problems linked to freight transportation require sustainable development. The rapid development of techniques and technologies enable much easier freight transportation management. However, right data and right indicators are of key importance for successful monitoring and sustainable management.

The subject of this research is to identify the main international practices and indicators of sustainable transportation and to develop a set of indicators for measuring and evaluating the impact of transportation sustainability regarding stakeholders.

The paper consists of five sections. The second Section describes theoretical basis of the transportation sustainability and actions taken to support sustainability in transportation worldwide. The third Section gives an identification and overview of sustainability indicators. In the fourth Section, a selection and classification of indicators is done, while the final remarks and conclusion are given in the last Section.

## TRANSPORTATION SUSTAINABILITY

The transportation of goods has positive and negative effects on the society. Economic and social impacts can be both positive and negative, but the impact on the environment is mostly negative. The planning and organization of transportation is important as much as the characteristics of vehicles, fuel quality, etc. Therefore, the transportation stakeholders should act in order to create sustainable transport system.

The term *sustainable development* was introduced in 1980 and popularized in the 1987 report of the World Commission on Environment and Development (the Brundtland Commission) [1]. The sustainability gained the status of a global mission by the United Nations Conference on Environment and Development (UNCED) held in Rio de Janeiro in 1992. The Brundtland Commission defined sustainable development as "development that meets the needs of the present without compromising the ability of future generations to meet their own needs". The concept of sustainable development with equal importance takes into account environmental, social and economic objectives. The sustainable transport system is a system that [1]:

- Enables secure implementation of the transport needs of individuals and of society without endangering human health and the ecosystem, with equity within and between generations;
- Is economically efficient, offers a choice between transport modes and supports variable economy;
- Reduces emissions and waste within the planet's possibilities, minimizes consumption of non-renewable energy sources, limit the consumption of renewable resources to the limits of their sustainable production;
- Reuses and recycles its components, and minimizes the land use and the noise level.

Transportation is one of the main sources of environmental polluters and climate change caused by anthropogenic activity, and a priority area of action for sustainable development. It plays an important role in the economy with its omnipresence in the whole supply chain, for all geographical scales [2]. The results of a study showed that there is an urgent need to implement appropriate policy instruments that would help to alleviate and control the negative impacts of transportation activities. Indicators can be considered as a valuable policy tool for measuring and assessing the impact of transportation sustainability.

Development of sustainable indicators was first brought up as a political agenda issue at the United Nations Conference on Environment and Development (UNCED) held in Rio de Janeiro in 1992. The UNCED policy declaration Agenda 21 requested countries at the national level and governmental and non-governmental organizations at the international level to develop indicators in the context of improving information for decision making [3]. Since then, indicators are thought to be important tools for measurement of different aspects of sustainable development, including transportation related issues. Indicators are frequently defined as quantitative measures that can be used "to illustrate and communicate complex phenomena simply, including trends and progress over time" [4]. A number of international organizations have been

involved in the development of indicators aiming to achieve a more sustainable transportation on the local, regional, and global levels. Indicators reflect society's values and goals and become key drivers of change. Litman [5] in his paper on developing indicators for comprehensive and sustainable transportation planning states that "indicators are things we measure to evaluate progress towards goals and objectives. As suggested in [5], indicators linked to transportation activities should be balanced, reflecting a combination of economic, social and environmental objectives. Selection of indicators is generally based on certain internationally established and commonly used quality criteria. In the report of Canadian Victoria Transport Policy Institute (VTPI) [5], the best practices for selecting indicators to measure transportation performance take into the account the following criteria: Comprehensiveness, Data quality, Comparability, Easiness to understand, Accessibility and Transparency. Quantitative criteria for the development of indicators are also of significant importance. Several specific quantitative targets aiming as sustainable transportation activities are also suggested by the European Road Transport Research Advisory Council [6]:

- Improvements in vehicle efficiency delivering a 10% reduction in CO<sub>2</sub> emissions for heavy duty vehicles for the new vehicle fleet in 2020;
- Good vehicle maintenance and eco-driving reducing fuel consumption and CO<sub>2</sub> emissions by at least 5% for heavy duty vehicles;
- Improvements in the road transport infrastructure, the optimal use of transport modes, information technology systems, higher freight loading factors contributing to further reductions in fuel consumption by 10-20%;

#### **A REVIEW ON INDICATORS OF SUSTAINABILITY**

All the above mentioned conditions that define transportation sustainability play an essential role and provide a basis in the development of indicators to measure and monitor transportation activities. This paper is focused on the identification and classification of indicator set for measurement and evaluation of transportation sustainability performance. Taking into account ten major international transportation related initiatives, a set of 55 indicators has been developed, reflecting the 5 major components; i.e. economic, social, environmental, technical/operational and institutional. The 17 indicator themes behind these components focus on the major EU transportation policies. This set of indicators attempts to provide a complete characterization of sustainable transportation system (Table 1). The selection of indicators presented in the Table 1 reflects the multidisciplinary nature of transport. As the issue of transportation is very complex involving many and various aspects, the current set of indicators includes numerous transportation sustainability aspects which are closely linked to the EU transport policy priority issues. Referring to the literature, the indicator sets may include more or less components linked to transportation activities depending on various policy priorities [5]. Quantification of chosen indicators is another important step in the assessment of transportation activities. It is not always possible to obtain quantitative values for certain indicator, often due to limited availability of data or due to difficulty to translate certain indicators into quantitative terms (e.g. external

costs of congestion, noise, etc.). For example, it is widely known that environmental assets are difficult to estimate in monetary values and other quantitative terms [7].

**Table 1.** Indicator framework for the evaluation of transportation sustainability performance - adjusted from [8]

DIMENSION	THEME	RELATED INDICATORS
Economic	<i>Transport Demand and Intensity</i>	1. Volume of transport relative to GDP
		2. Road transport (tonne-km)
		3. Railway transport (tonne-km)
		4. Maritime transport (tonne-km)
		5. Inland waterway transport (tonne-km)
		6. Air transport (tonne-km)
		7. Intermodal transport (tonne-km)
	<i>Transport Costs and Prices</i>	8. Total transport expenditures per capita (vehicle parking, roads and transit services)
		9. Motor vehicle fuel prices and taxes (for gasoline, diesel, LPG, etc.)
		10. Direct freight transport cost by mode
		11. External costs of transport activities (congestion, emission costs, safety costs) by transport
		12. Internalization of costs (implementation of economic policy tools with a direct link with the marginal external costs of the use of different transport modes)
		13. Subsidies to transport
		14. Taxation of vehicles and vehicle use
		15. % of GDP contributed by transport
	<i>Infrastructure</i>	16. Investment in transport infrastructure (per capita by mode/ as share of GDP)
		17. Road quality - paved roads, fair/ good condition
		18. Total length of roads in km by mode
		19. Density of infrastructure (km-km <sup>2</sup> )
Social	<i>Accessibility and Mobility</i>	20. Average delivery time
		21. Average driving distance per mode
	<i>Risk and Safety</i>	22. Persons killed in traffic accidents with freight vehicles (number of fatalities or injuries – 1000 vehicle km; per million inhabitants)
		23. Population exposed to traffic noise, by noise category and by mode associated with health and other

<b>DIMENSION</b>	<b>THEME</b>	<b>RELATED INDICATORS</b>
		24. Cases of chronic respiratory diseases, cancer, headaches. Respiratory restricted activity days and premature deaths due to motor vehicle pollution
	<i>Employment</i>	25. Contribution of transport sector (by mode) to employment growth
<b>Environmental</b>	<i>Transport Emissions</i>	26. NOx emissions (per capita, per tonne-km)
		27. VOCs emissions (per capita, per tonne-km)
		28. PM <sub>10</sub> and PM <sub>2.5</sub> emissions (per capita, per tonne-km)
		29. SOx emissions (per capita, per tonne-km)
		30. O <sub>3</sub> concentration (per capita, per tonne-km)
		31. CO <sub>2</sub> emissions (per capita, per tonne-km)
		32. N <sub>2</sub> O emissions (per capita, per tonne-km)
	33. CH <sub>4</sub> emissions (per capita, per tonne-km)	
	<i>Energy Efficiency</i>	34. Energy consumption by transport mode (tonne-oil equivalent per vehicle km)
		35. Fuel consumption (vehicles-km by mode)
	<i>Impacts on Environmental</i>	36. Habitat and ecosystem disruption
37. Land take by transport infrastructure		
<i>Environmental Risks and Damages</i>	38. Polluting accidents (land, air, water)	
	39. Hazardous materials transported by mode	
<i>Renewables</i>	40. Use of renewable energy sources (number of alternative-fuel vehicles) - use of biofuels	
<b>Technical and operational</b>	<i>Occupancy of Transportation</i>	41. Occupancy rate of passenger vehicles
		42. Load factors for freight transport (LDV, HDV)
	<i>Technology Status</i>	43. Average age of vehicle fleet
		44. Size of vehicle fleet (vehicle/ 1 mln. inhabitants)
		45. Proportion of vehicle fleet meeting certain air emission standards (Euro IV, Euro V etc.)
<b>Institutional</b>	<i>Measures to Improve Transport Sustainability</i>	46. R&D expenditure on "eco vehicles" and clean
		47. Total expenditure on pollution prevention and clean-
		48. Measures taken to improve freight transport
	<i>Institutional Development</i>	49. Uptake of strategic environmental assessment in the transport sector

### CLASSIFICATION OF INDICATORS AND DISCUSSION

Sustainable performance indicators are intended to use by stakeholders in supply chains and transportation systems: companies, their partners, government, local authorities, investors and customers. In Table 2 we classified indicators which may be of

use or can be interesting for some of the stakeholders. The classification was conducted with respect to sustainable groups/dimensions. The sustainable performance indicators used for classification are shown in previous chapter (in Table 1).

**Table 2.** Classification of sustainable transportation indicators

	Stakeholders					
	Company itself	Partners	Government	Local authorities	Investors	Customers
Economic	2, 3, 4, 5, 6, 7, 10, 11, 12, 13, 14, 16, 17	10, 11, 12, 13, 16, 17	1, 8, 9, 12, 15, 16, 17, 18, 19	1, 8, 9, 12, 17	1, 2, 3, 4, 5, 6, 7, 10, 11, 13, 16, 17	14, 16, 17
Social	21, 25	20	22, 23, 25	22, 23, 25	/	20, 22, 23, 24, 25
Environmental	34, 35, 38, 39	34, 35, 40	31, 32, 33, 37, 38	26, 27, 28, 29, 30, 37, 38	40	26, 27, 28, 29, 30, 31, 32, 33, 36, 38
Technical and operational	42, 43	42, 43	45	/	42, 43, 44, 45	45
Institutional	46, 47, 48	48	47, 49	47, 49	46, 48, 49	/

Traditionally, the most economic indicators are important for all the actors and stakeholders in freight transportation. Therefore, the economic indicators are relatively proportionally distributed between stakeholders. Social indicators are found to be less useful for the investors, but the customers as the most impacted stakeholders are interested in 5 of 8 listed social indicators. It is also very important to report the environmental indicators to the customers as this is one of the reasons why customers choose to buy products and services of the company. So, the competitive advantage of the company on the market is dependent on environmental indicators reported to customers. On the other side, customers are not interested in knowledge of technical, operational and institutional indicators of transportation sustainability. These indicators are more important for government and local authorities in order to develop the best strategies and plans for the market and community. Development of the strategies, plans and legal acts based on sustainable transportation indicators should increase the welfare of the whole community.

## CONCLUSION

The fast and reliable identification of sustainable transportation indicators would certainly represent a significant first step in the creation of optimal conditions for sustainable transportation with optimum energy efficiency. The indicators reflect the values and objectives of the company and become key drivers of change. In the transport sector, as well as in many other areas, indicators are useful to highlight the problem,



identify trends, contribute to prioritization, policy formulation and evaluation and monitoring of the process. Also, it can be used to inform the public and decision-makers. Quantitative criteria for the development of indicators are also of importance. What is important is to determine what policies should be adopted by national governments to ensure achievement in the development of environmentally sustainable transportation with us. For all these reasons the classification of indicators with regard to stakeholders is done in this paper. The result should help the stakeholders in easy and fast identification of reliable and useful sustainable indicators for them.

This paper is limited to research of a transportation subsystem of logistics. Therefore, future research should certainly cover the indicators of sustainability with regard to other logistics subsystems: planning, procurement, production, inventory, etc. It will be interesting to investigate how indicators of transportation sustainability can be implemented in other subsystems, would it require adjustments of identified indicators and will there be additional indicators.

### ***Acknowledgement***

*This work was financed by the Ministry of Education, Science and Technological Development of the Republic of Serbia for the period 2011–2016 (Project No. TR36030).*

### **REFERENCES**

1. Sustainable Development: From Brundtland to Rio 2012 Background Paper, prepared for consideration by the High Level Panel on Global Sustainability at its first meeting, 19 September 2010
2. Rodrigue, J.P., Comtois C. and Slack B, *The Geography of Transport Systems*. New York: Routledge, 284 pages, ISBN 0-415-35441-2, (2007).
3. UN (1992). Agenda 21: Programme of Action for Sustainable Development. Rio Declaration on Environment and Development, E.93.1.11, New York
4. Litman, T. (2007), *Well Measured: Developing Indicators for Comprehensive and Sustainable Transport Planning*, Victoria Transport Policy Institute, Canada
5. EEA (2005). *EEA core set of indicators: Guide*. EEA Technical Report, Copenhagen.
6. ERTRAC (2004). *Strategic Research Agenda Overview*. Brussels, Belgium.
7. Perman, R., McGilvray J. and Common, M. *Natural resource and environmental economics*. 2nd ed. Prentice Hall, UK, (1999).
8. A. Dobranskyte-Niskota, A. Perujo and M. Pregl Indicators to assess sustainability of transport activities



## DEVELOPMENT OF WASTE MANAGEMENT SYSTEM IN SERBIA – NOVI SAD WASTE REGION

Visnja Mihajlovic

University of Novi Sad, Faculty of Technical Sciences,  
Trg Dositeja Obradovica 6, Novi Sad, SERBIA

*visnjamihajlovic@uns.ac.rs*

### ABSTRACT

Transposition and implementation of the European waste management policy is obligation for candidate countries like Serbia. Fulfillment of the European Waste Directives goals and development of waste management infrastructure will be challenging task for the country in the next period. Identification of waste quantities and flows will be the key for sustainable waste management system. Selection of waste treatment technology will depend on many factors, but most important is selection of technology appropriate for local conditions and needs. Implementation of advanced technology, will increase the cost of the system which may not be sustainable in long term.

**Key words:** waste management, EU Directives goals, sustainability, waste treatment cost, waste management infrastructure.

### INTRODUCTION

In the next period, municipal solid waste (MSW) management system in Serbia will go through the changes. Serbia is a candidate country for European Union membership and will have to transpose and implement the total body of EU legislation, so-called *aquis-communautaire*. Part of the EU legislation is concerned with environmental protection, including waste management. Within the framework of the country's efforts to become a member of the EU, waste legislation has been fully aligned with EU standards, the Landfill Directive (LD) [1], the Waste Framework Directive (WFD) [2] and the Packing and Packaging Waste Directive (PPWD)[3].

Based on experience of EU Member States where the disposal of waste remained cheap, and where there are no fees and charges for waste disposal, diversification of biodegradable waste from landfills and implementation of waste treatment technologies has been more slowly, unlike in countries where fee for waste disposal was introduced prior to LD implementation, and thus gradually started to build the necessary infrastructure for waste management [4]. In addition, new member states e.g. Poland, Bulgaria, Romania, Croatia, still depend on landfilling and treatment options

are rarely in place and therefore still a large amount of biodegradable waste is disposed of in landfills [5]

Similar to countries in south-eastern Europe [6], waste management in Serbia suffered from long historical negligence of solid waste issues and it's focused on fulfillment minimum regarding public health. Waste management in Serbia, is still focused on waste collection and protection of public health. Main deficiencies in solid waste management in Serbia are weak and inefficient law enforcement mechanism, lack or weak capacity or motivation of staff, lack of finances for investments etc. Dominant waste treatment method is still landfilling with high share of biodegradable municipal waste (BMW) going to landfill. Separate waste collection, is not established in Serbia as well.

Serbia will have difficulties in practical implementation and enforcement of EU waste legislation and fulfilling the waste reduction goals, particularly to divert biodegradable waste from landfill. This task will need the strategy for development of waste management infrastructure and activities in accordance with policy goals. Main focus of this paper is to identified MSW quantities and technologies for waste treatment which are in accordance with EU waste management goals in Novi Sad Waste Region.

### METHODOLOGY

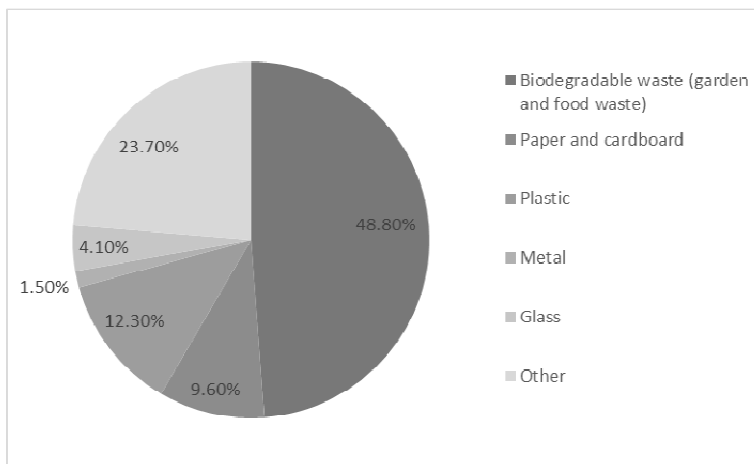
Novi Sad Waste Management Region (NSWMR) represents one of 27 waste management centers defined by National Waste Management Strategy [7]. European waste management goals analyzed in this paper are given in Table 1. Targeted year is 2030.

**Table 1.** EU waste management targets

EU Directive	Target
Landfill Directive	Reduction of BMW going to landfill by: ✓ 75% of 1995 baseline levels by 2010 ✓ 50% of 1995 baseline levels by 2013 ✓ 35% of 1995 baseline levels by 2020 (EC, 1999)
Packaging and packaging waste Directive	By 2011: recycling of 55–80% of packaging waste
Waste Framework Directive	Reuse and/or recycling of minimum 50% waste by weight from households

Starting point for waste quantities estimation is total waste generated in NSWMC in 2008, which was 190.000 tonnes of MSW/year [8].

Morphological composition of the MSW in NSWMC is used for waste flows identification, Figure 1.



**Figure 1.** Morphological composition of MSW in NSWMC

GDP real growth rate for Serbia was used as an indicator for waste generation growth rate [9]. According to available data, GDP real growth rate between in Serbia varied, and forecast analysis indicate growth of GDP in 2017 to be 2.7% [10]. Considering the variations in GDP growth and forecast, 2% GDP growth rate was used in this paper.

Technologies analyzed in this paper are biological and thermal waste treatment including sanitary landfill. Packaging waste recycling was not analyzed, only quantity is identified in order to comply with PPW Directive goals.

Composting is biological treatment, which include composting and the stage of maturation. Compost, wastewater and residues are produced during the process. The waste quantity entering the composting consists of source-separated biodegradable and garden waste.

Incineration includes combustion of waste at high temperature, producing bottom and fly ash, flue gas and heat. The waste quantity entering the incineration plant is mixed municipal waste (residual waste).

Estimation of capital cost for analyzed technologies will be given as well, based on identified quantities and cost data from literature.

## RESULTS AND DISCUSSION

For the year 2030 the total MSW is 292,342 tonnes. In order to comply with the requirements of the EU LD it would be necessary to treat 103,050 tonnes of biodegradable waste and 43,121 tonnes of packaging waste in order to comply with EU PPW requirements. After separation of biodegradable waste and packaging waste 146,171 tonnes of residual waste remains.

Treatment of biodegradable waste in composting unit and recycling of packaging waste fulfill the goals of analyzed Directive. Residues after biological treatment are disposed at landfill as well as residual waste. Biological treatment of waste and recycling of packaging waste increase the waste disposed at landfill.

Since composting only reduces the quantity of biodegradable waste at landfill, implementation of incineration plant will reduce the amount of waste sent to landfill and thereby helps to fulfil the waste hierarchy. Residues after the incineration treatment are disposed at the landfill, while fly ash is exported for disposal, since it is hazardous waste and cannot be disposed at sanitary landfill.

**Table 2.** Capital cost estimation

Waste treatment technology	Waste quantity (t/year)	Capital cost (€/t)	Total cost (€)
Composting	103,050	159	16,384,950
Incineration	146,171	531	77,616,801

The most important issue regarding the waste management system development is system's cost. Composting is technologically less demanding and its cost are not high, as well as the cost of sanitary landfill. Capital cost of composting in EU are from 159 €/t to 219 €/t, while sanitary landfill capital costs are in range from 118 €/t to 152 €/t (EC, Annex E) [11]. Waste incineration has a high cost and it is advanced technology comparing to composting. Capital cost of incineration are in range from 531 €/t to 651 €/t. Taking into account above data cost, cost of biological treatment is much lower comparing to biological and thermal treatment, Table 2. Therefore, incineration will significantly increase the cost of the system and cost of the waste management service.

## CONCLUSION

Development of waste management system in accordance with EU waste targets will be difficult, but inevitable. Design of the waste management system in Novi Sad, will face the increase of municipal waste quantities, and the need to manage it properly, in order to protect the health and environment. Experience from EU Member States, indicate that countries where waste management was low cost, relying on landfilling, the technology shift was very slow, contrary to Member States where mechanisms like landfill taxes were already in place, they simultaneously built-up the necessary infrastructure for cleaner and more efficient waste management treatment technologies. Important issue regarding the development of EU waste management system is the cost of the system and waste treatment technologies. Implementation of waste treatment technologies and need to be developed and tailored specifically to local needs and conditions, otherwise waste management system will not be sustainable in long term.

## REFERENCES

1. EC (1999) Directive 1999/31/EC on the landfill of waste, European Parliament and of the Council, Official Journal L 182, 16/07/1999, p 1-19, Luxembourg
2. EC (2009) Directive 2009/98/EC on waste and repealing certain Directives, European Parliament and of the Council, Official Journal of the European Union L 312/3, 19/11/2008, p 3-30, Luxembourg
3. EC (1994) Directive 94/62/EC on packaging and packaging waste, European Parliament and of the Council, Official Journal L 365, 20/12/1994, p. 10.-23., Luxembourg
4. Lasaridi, K., Implementing the Landfill Directive in Greece: problems, perspectives and lessons to be learned, *The Geographical Journal*, 175 (4): 261 (2009)
5. BiPRO, Support to member states in improving waste management based on assessment of member states' performance 070307/2011/606502/SER/C2. Final report to the European Commission, Beratungsgesellschaft für integrierte Problemlösungen (BiPRO), Brussels, Belgium, (2013)
6. Stanic-Maruna I., Fellner, J., Solid waste management in Croatia in response to European Landfill Directive. *Waste Management and Research*, 30(8), 825 (2012)
7. Official Gazette of Republic of Serbia National Waste Management strategy for the period 2010-2019. *Official Gazette* 29/10 (2010)
8. Vujić G, Jovičić N, Redžić N et al. A fast method for the analysis of municipal solid waste in developing countries – case study of Serbia. *Environmental Engineering and Management Journal* 9:1021–1029 (2010)
9. Alevridou, A., Venetis, C., Mallini, D. et al. Guidelines for development of alternative waste management, Project: Waste Network for sustainable solid waste management planning and promotion of integrated decision tools in the Balkan Region (2001)
10. World Bank (2015) Economic indicator database <http://data.worldbank.org/indicator/NY.GDP.MKTP.PP.KD> (Accessed 10 July 2015)
11. Hogg, D., ARCADIS: Assessment of the options to improve the management of Bio-Waste in the European Union – Annex E: Approach to estimating costs, ARCADIS Belgium, 2009



## CONTRIBUTION TO PHARMACY MANAGEMENT SYSTEM UNUSABLE DRUGS IN THE REPUBLIC OF SERBIA

Natasa Bukumiric\*, A. Bozic, V. Alivojvodic, M. Stamenovic, S. Djarmati

<sup>1</sup>College of Vocational Studies, Belgrade Polytechnic, Belgrade, SERBIA

\**natasa.bukumiric@gmail.com*

### ABSTRACT

Regulation on medical waste management had been made by Ministry of Environment and Spatial Planning of the Republic of Serbia, in October of 2010. It prescribes the manner and procedure for managing of hazardous waste from health care facilities, and manner of pharmaceutical waste management, the contents of waste management plan, as well as the list of pharmacies that are obliged to take useless drugs from citizens. Research had been conducted with intention to indicate the spatial, organizational and technical readiness of pharmacies to participate in disposal of unusable drugs.

**Key words:** medical waste management, unusable drugs.

### INTRODUCTION

In the overall environmental pollution pharmaceutical waste does not take up a large part, only 3% of the total amount of medical waste, but it is potentially among the more dangerous types of waste, because it can lead to poisoning and many other negative consequences [1]. By discovering and proving adverse effects caused by the influence of drugs due to inadequate waste (disturbance of ecological balance, extinction of species, toxicological and epidemiological trends, etc.). Unusable medicines and their cleavage products today represent one of the key environmental issues. When unusable drugs got thrown in the trash or in the sewers, the active drug substance enters the environment and ends up in groundwaters, lakes and rivers, where it directly or through accumulation by plants and animals constitute a danger to human health [2,3]. Even modern facilities for waste water treatment and production of drinking water are not able to remove pharmaceutical substances from wastewater, groundwater or surface water. Considering that inadequate deferred unusable medications can result in a range of negative consequences for the environment and human health, the year 2010 came into force the Ordinance on medical waste management (hereinafter referred to as the Rules), which shall prescribe the proper way to manage this category of waste [3]. According to the provisions of the Regulations all pharmacies are obliged to collect unusable drugs. In practice, this means that all pharmacies within their business premises should have a special container in which the citizens could dispose their medicines unusable for any

reason, as well as information about that option. In order determining whether and to what extent, after 5 years since the Ordinance came into force pharmacies adhere to that will be shown through the results in this paper.

## MATERIALS AND METHODS

In order to determine the degree of practical implementation of the provisions of the Ordinance in the segment which refers to useless drugs, College of Vocational Studies - Belgrade Polytechnic in collaboration with the Faculty of Applied Ecology - Futura, have carried out research through survey in 15 cities and municipalities of the Republic of Serbia: Beograd, Vršac, Bela Crkva, Lazarevac, Smederevo, Golubac, Valjevo, Arandjelovac, Požarevac, Lučani, Smederevska Palanka, Požega, Kraljevo, Babušnica and Vranje.

The survey was conducted in April-May 2015 on a sample of 222 private and public pharmacies (Table 1).

**Table 1.** Number of respondents state and private pharmacies

Pharmacies	Number	%
Pharmacies are privately owned	186	83,8
Pharmacies state-owned	36	16,2
Total	222	100

The objectives of the research were:

- Testing familiarity pharmacist and Ordinance on medical waste management [4] is actually determining how many pharmacies, 5 years after its entry into force to comply with the same;
- Determining the extent to which the Ordinance applies in pharmacies.

For this study was used a questionnaire of 17 questions that were a combination of alternative (dichotomy) questions and closed questions. The respondents were guaranteed anonymity, which is aimed at getting you more honest answers. Entering and statistical analysis of data obtained during the research, as well as graphic interpretation of the findings made in the Microsoft Excel computer program.

## RESULTS AND DISCUSSION

Of the more than 350 pharmacies contacted, interviewing was conducted in 222 private and public pharmacies, which has already been shown in the description of the sample. From enclosed can be seen that a large number of pharmacists refused to participate in the survey, with the most frequently cited reasons for refusal are the same: lack of rights, time, and that they do not have the obligation to provide the requested information.

In accordance with the aforementioned objectives of the research, results of the survey pharmacy will be presented in three parts:



- Knowledge of Regulations by the surveyed pharmacists;
- Implementation of the Regulations in pharmacies;
- Assessment of the professional abilities of staff to contribute to the correct implementation of the Order.

### Knowledge of the rules by trained personnel pharmacy

When asked if they are familiar with the Regulations on the management of medical waste, obtained 79.2% of affirmative answers, but if you take into account that the Regulations came into force in 2010, 20.8% of respondents pharmacists who report that they are not familiar the Ordinance is not negligible percentage (Figure 1).

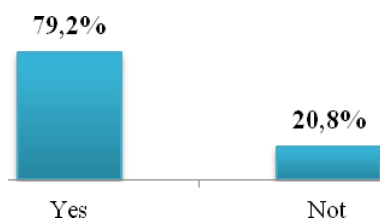


Figure 1. Knowledge of Regulations-self-assessment pharmacist

Although knowledge of professional pharmacy personnel is not checked by direct issues related to the Ordinance, the answers to individual questions indicate that the percentage of pharmacists who are not familiar with the Rules considerably higher. As confirmation of the above is that a large number of pharmacists uncertain answer very basic questions. So it is not the question, "Are the pharmacy obliged to take from citizens unusable medications? Only half of the surveyed pharmacists (54%) gave a positive answer. Despite the fact that the Ordinance states that pharmacies are obliged to take unusable medications, are all pharmacies established as healthcare institutions in accordance with the law, as well as pharmacies established as private practice, 12% say that only 'state' pharmacies have that obligation, while 19% of pharmacists said that pharmacies do not have that obligation. If it had not addressed the stated points out 15% of the surveyed pharmacists (Figure 2).

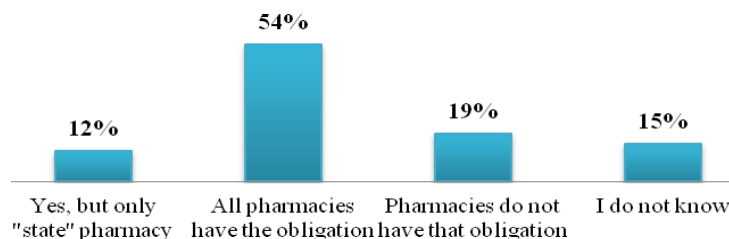
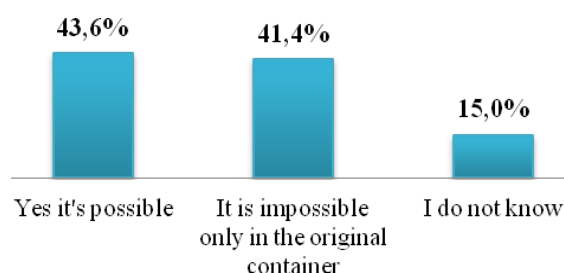


Figure 2. Familiarity pharmacist in the pharmacy office to citizens takes unusable medications

The answer to the question that also confirms that the percentage of insufficient knowledge of the Rules greater than these (20.8%), concerns the possibility of return of unusable drugs in the pharmacy, while not in the original package. The correct answer to this question gives 41.4% of the surveyed pharmacists, 15.0% said they did not know, while 43.6% stated that the return of such drugs is possible, despite the fact that the Regulations provide that the unusable drugs returned to the original outer or the inner package (Figure 3). However, analyzing the above noted problem of incomplete, defining, respectively uncertainty Regulations regarding the term "original packaging". On the basis of the definition of unusable medicinal product stating that these are the remains of drugs that were left to the end user after using the drug, and that the end user throws, intends to throw or has to throw the question arises, how likely is that the remains of medicines as such, can be found in the original interior, in the original outer packaging, but also what to do with medicinal products that do not meet the given condition?

Such lack of specific formulations Ordinance may pose a problem because leaving space for possible manipulation of drugs that are treated as unusable.

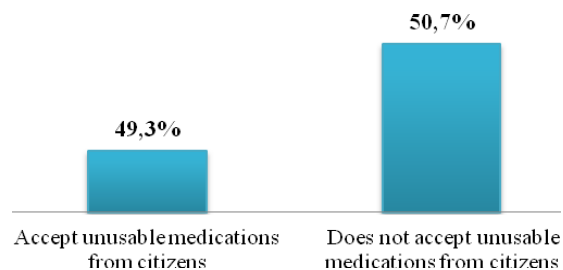


**Figure 3.** Familiarity pharmacist about the possibility of return of medicines in pharmacies that are not in the original package

Similar responses were obtained, and the question of whether the pharmacy shall, within their business premises provide space for a container designed to collect unusable drugs? A positive response was recorded at 50.5% pharmacists, 16.5% stated that pharmacist pharmacy does not have this duty, while one third of the surveyed pharmacists (33%) were not sent to the above, precisely does not know the provisions of the Ordinance.

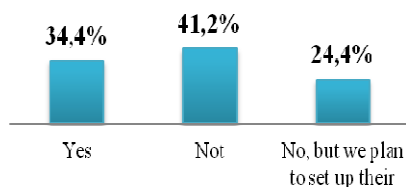
### **The application of the regulations in pharmacies**

Based on the results of the low familiarity pharmacist in the provisions of the Rules governing the treatment of unusable medicines, it is clear that the worse the situation can be expected when it comes to its application. And after five years since the entry into force of regulations [4], 50.7% of pharmacies did not made the collector of unusable medications from citizens (Figure 4).

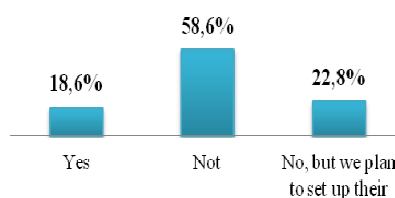


**Figure 4.** Download unusable drugs in pharmacies by citizens

As confirmation of this is an extremely small number of pharmacies (34.4%), which results in an operating room have placed containers (Figure 5) to collect unusable drugs and prominent notice of the given options (18.7%) (Figure 6).



**Figure 5.** Possession of containers for collecting unused medications

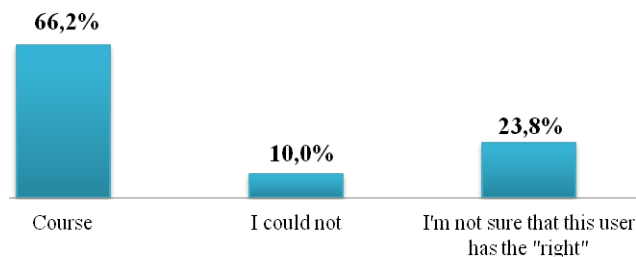


**Figure 6.** Possession of the notice to the pharmacy for the data collection of unusable medications from citizens

Taking the horizon that the Ordinance stipulates that the containers and the notification shall be made visible and marked place in the pharmacy, and the fact that during the survey in most pharmacies where the survey was carried out notices and containers are not observed, the situation is apparently even worse.

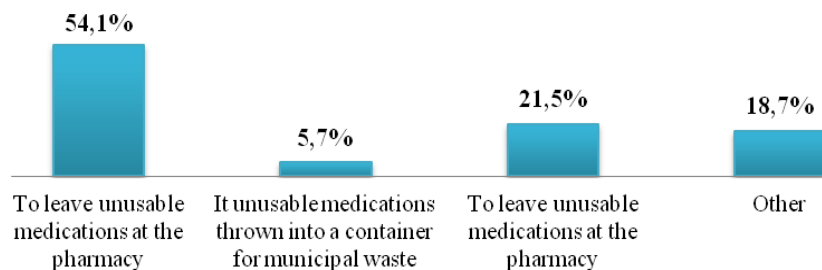
#### **Assessment skills of professional pharmacy personnel to contribute to the implementation of regulations**

In addition to determining the level of awareness of the pharmacist Regulations and application of the same, the survey included questions on which it should have examined the ability of pharmacists to provide adequate information to interested citizens how to proceed with the useless drugs that have in their households. Slightly more than half of the surveyed pharmacists (66.2%) said they would be interested in giving the citizens the right guidance, points out that 10% would not know to find his way in a given situation, while 23.8% are not sure into which the user "right" (Figure 7).



**Figure 7.** Willingness pharmacist to give adequate instructions to citizens on how to proceed with the useless drugs from their homes

Asked what would you recommend to those who would ask them how to proceed with the useless drugs?, more than half (54.1%) of the surveyed pharmacists to interested citizens advised correctly, that unusable medications leave the pharmacy. However one can not ignore 21.5% of the surveyed pharmacists who, advising that unusable medications carried in a humanitarian organization indicates the problem is not distinguishing the concept of unusable drugs from the concept of excess drugs. Unusable medications thrown into container for waste advised to 5.7% of pharmacists, while 18.7% of the surveyed pharmacists gave different answers, one of which is the most useless drugs that bring them to the state or another pharmacy, although it's obligations under the Ordinance all pharmacies (Figure 8).



**Figure 8.** Tips pharmacist how to proceed with the useless drugs from households

## CONCLUSION

Bearing in mind the risks, which are pharmaceuticals in the environment, proper management of this type of waste is of paramount importance. However, based on research results shown in this paper, it can be concluded that after five years since the Ordinance came into force on the disposal of unusable drugs in the Republic of Serbia is nowhere near solution. In addition to the problem that a large number of pharmacies has no secured adequate conditions for collecting this type of waste, what is even more worrying is the poor level of awareness of professional pharmacy personnel to this issue

and the Ordinance itself. For this reason it is necessary as soon as possible to deal with the problem of how to, while not yet taken off, how to avoid environmental - medical, and financial consequences of this kind of waste is certainly carries with him.

To begin with, the implementation of educational programs and training of employees in pharmacies in order to thereby enable the organic conscientious handling of unusable drugs and providing adequate information to stakeholder citizens what to do with it.

#### REFERENCES

1. Vera, M., Mihajlov, A., Hodolič, J., Agarski, B. (2008.). Analiza stanja opasnog otpada iz medicinskih ustanova u Srbiji i svetu, 3. Konferencija o kvalitetu života, Asocijacija za kvalitet i standardizaciju Srbije, Kragujevac.
2. Richardson, M. L., Bowron, J. M. (1985). *The fate of pharmaceutical chemicals in the aquatic environment*, J. Pharm. Pharmacol. 37, (1-12).
3. Grujić, D. S. (2009). Određivanje tragova lekova u vodi metodom tečne hromatografijesa tandem masenom spektrometrijom, Doktorska disertacija, Beograd, Tehnološko metalurški fakultet,
4. Pravilnik o upravljanju medicinskim otpadom, („Sl. glasnik RS“, br.78/2010).



**ASPECTS REGARDING THE CERTIFICATION  
OF ROMANIAN ECOTURISM**

**Cipriana Sava<sup>\*</sup>, G. Pinteala**

Faculty of Tourism and Commercial Management Timișoara  
Christian University “D. Cantemir” Bucharest, ROMANIA

*\*cipriana.sava@gmail.com*

**ABSTRACT**

Protected areas are the "unpolluted oasis" of the Planet, leisure destinations for many people. Practicing tourism at the periphery of these areas is based on the principles of sustainable tourism development. Ecotourism meets the needs of tourists and of the local population.

According to the legislation in force there are numerous protected natural areas in Romania, and ecotourism began to develop. Therefore, the certification of ecotourism is a step towards providing quality products and services.

**Key words:** protected areas, legal aspects, ecotourism, certification.

**INTRODUCTION**

The negative effects of the global economic development have been discussed since 1972 (UN Conference on Environment in Stockholm). Sustainable development is the answer to the issues raised by environmental pollution.

Long before, people who have appreciated the environment and have realized its importance, tried to protect it. Hence, the first national parks - natural areas protected by law - were established (Table 1).

**Table 1.** First national parks in the world

Place	Year of establishment	Name of park
USA	1872	Yellowstone National Park
Australia	1879	Royal National Park
Canada	1885	Hot Springs Reservation, today Banff National Park
South Africa	1898	Sabi Sand Game Reserve, today Kruger National Park
Sweden (Europe)	1909	Stora Sjöfallet and Sarek

The first national park in Romania was established in 1935, namely: Retezat National Park.

Protected areas are marked and protected by law, being classified in accordance with national and international standards. Generally, protected areas are scientific reserves, national parks, natural monuments, natural parks, natural reserves, biosphere reserves, wetlands of international importance, natural sites of universal natural heritage, special areas of conservation and special protection areas for aqua fauna.

According to the Romanian legislation, namely the Government Emergency Ordinance no. 57/2007 on the regime of protected natural areas, conservation of natural habitats and wildlife, approved with amendments by Law no. 49/2011: the protected natural area is "a terrestrial / aquatic and / or underground area where there are species of wildlife, bio-geographic, landscape, geological, paleontological, speleological or other elements and formations with ecological, scientific or outstanding cultural value or with a special protection and conservation regime established under legal provisions."

The total protected natural areas in Romania, including the Natura 2000 sites (there were 1,486 protected natural areas in 2015) account for 23% of the country's total area. The protected national and natural parks are presented in Table 2.

**Table 2.** National and natural parks in Romania

Name of national park	Area (ha)	Name of natural park	Area (ha)
Buila -Vânturița	4186	Apuseni	75784
Călimani	24041	Bucegi	32663
Ceahlău	8396	Cefa	5002
Bicazului-Hășmaș Gorges	6575	Cindrel	9873
Nerei-Beușnița Gorges	36758	Comana	24963
Cozia	17100	Mureșului Superior Gorges	9156
Danube Delta	580000	Dumbrava Sibiului	993
Domogled-Cernei Valley	61211	Grădiștea Muncelului-Cioclovina	38184
Defileul Jiului	11127	„Țara Hațegului” Dinosaurs Geopark	102392
Măcinului Mountains	11321	Lunca Joasă a Prutului Inferior	8247
Rodnei Mountains	46599	Brăila's Little pond	17529
Piatra Craiului	14733	Mureșului Grassland	17166
Retezat Mountains	38047	Maramureș Mountains	148850
Semenic-Carașului Gorges	36664	Mehedinți Plateau	106,5
		Iron Gates	115665,8
		Putna-Vrancea	30204
		Vânători-Neamț	30818
		Văcărești	182,9901

Source:[http://ro.wikipedia.org/wiki/Lista\\_parcurilor\\_naționale\\_și\\_naturale\\_din\\_România](http://ro.wikipedia.org/wiki/Lista_parcurilor_naționale_și_naturale_din_România)

One of the national parks, the Danube Delta is inscribed on the UNESCO Heritage List.

The activities allowed in certain areas of protected areas are stipulated in the Law no. 49 of 13 April 2011 for the amending and supplementing of the Government

Emergency Ordinance no.57 / 2007 on the regime of protected natural areas, conservation of natural habitats and wildlife in section 3 "The management of the national network of protected areas in Article 22, paragraphs 6, 8 and 9". They refer to:

- knowledge and education - scientific research and educational activities;
- prevention and protection - rational use of grasslands in authorized areas, localization and operative extinction of fires, actions to remove the effects of disasters, prevention of overgrowth of harmful pests, interventions to protect and maintain natural ecosystems, rehabilitation of degraded habitats and maintenance of habitats for the protection of different species;
- economy – carrying out traditional activities, using renewable resources (controlled harvest of berries, mushrooms, herbs), controlled tourism, fishing, hunting (with permits from the area's administration, after establishing strict quotas for harvest).

All these activities can only be achieved with the permission of the Scientific Council of the protected area and its administration.

### **ECOTURISM**

The controlled tourism that can be practiced in protected areas is actually ecotourism. The Association of Ecotourism in Romania considers that "ecotourism is a form of tourism in which the main motivation of the tourists is the observation and appreciation of nature and of local traditions directly connected to nature."

The most commonly used definition is that of the International Ecotourism Society (TIES), enunciated in 1991, according to which ecotourism is „responsible travel to natural areas that conserves the environment and improves the well-being of local people."

This form of tourism has the following features<sup>1</sup>: always involves a trip to natural destinations, will have a minimal impact, raises awareness on environmental issues, provides direct financial benefits for conservation, provides financial benefits and empowerment for local people, respects the local culture and supports human rights and democratic movements.

People can practice plenty of activities like birdwatching, watching wildlife (Wildlife Spotting), botanical tours, trekking, camping, diving, speleology, archaeology, photo safari and painting workshops of nature.

Ecotourism services cover transportation, accommodation, food, support and guidance, all of which having low environmental impact.

The concern for the development and support of ecotourism at international level can be seen through the activities carried out by many existing organizations (Table 3).

---

<sup>1</sup> Honey, Martha, [https://en.wikipedia.org/wiki/ecotourism#cite\\_note-Honey\\_EandSD\\_29to31-7](https://en.wikipedia.org/wiki/ecotourism#cite_note-Honey_EandSD_29to31-7)



**Table 3.** International organizations involved in developing ecotourism

Tourism organizations	Ecotourism organizations	Environmental organizations	International organizations involved
World Tourism Organization (WTO)	The International Ecotourism Society (TIES)	International Union for Conservation of Nature (IUCN)	United Nations (UN)
World Travel and Tourism Council (WTTC)	International Ecotourism Club (IEC)	World Wildlife Fund (WWF)	United Nations Environment Programme (UNEP)
European Travel Commission (ETC)	European Centre for Ecological Tourism and Agritourism (ECEAT)	European Environment Agency (EEA)	United Nations Development Programme (UNDP)
	EC3 Global	International Institute for Environment and Development (IIED)	United Nations Educational, Scientific and Cultural Organization – UNESCO
		European Council European Centre for Nature Conservation – NATUROPA	World Bank
		European Federation of National and Natural Parks – EUROPARC	

The Romanian ecotourism is supported at government level by the Romanian National Authority for Tourism, the Ministry of Environment, Water and Forests, the Ministry of Regional Development and Public Administration, the National Institute of Research - Development in Tourism. The latter institution (INCDT) has formulated and launched the "National Strategy for Ecotourism Development in Romania".

Several non-governmental organizations support the development of ecotourism in Romania (Table 4).

**Table 4.** Non-governmental organizations in Romania supporting ecotourism

Ecotourism organizations	Involved organizations
Association of Ecotourism Romania (AER)	Association of Rangers Romania (ARR)
Romanian Association for Accommodation and Ecologic Tourism - "BED & BREAKFAST" (ARCTE B&B)	National Association of Mountain Guides
National Association of Rural, Ecologic and Cultural Tourism (ANTREC)	National Association of Travel Agencies in Romania (ANAT)
"Ivan Patzaichin – Mila 23" Association	UNESCO Pro Natura ecologic club
	Romanian Speleology Federation
	Club for the Protection of Nature and Tourism

The Association of Ecotourism in Romania aims to promote the concept of ecotourism and the development of ecotourism for nature conservation and to raise the living standard of the local people, but also to ensure quality services for eco-tourists. The organization is the one to have developed, in cooperation with Green Cross Romania and Partnership Foundation, a System of Certification in Ecotourism - Eco-Romania – having as models the Accreditation Programme in Nature and Ecotourism promoted by the Australian Association of Ecotourism and Nature's Best of the Swedish Association of Ecotourism.

This system applies to:

- accommodation facilities (usually pensions) located in the countryside having up to 25 rooms;
- the ecotourism programmes promoted by tour operator travel agencies for up to 15 people.

The certification is renewed periodically every three years, but may be lost if during this period the accommodation facility or agency do not meet the criteria under which they were certified.

For better visibility a logo is used for the certified facilities and programmes.



**Figure 1.** Eco-Romania Logo

Source: <http://www.eco-romania.ro/ro/sistemul-de-certificare>

Currently, this system is not mandatory but it constitutes an advantage over the competition. Certification provides:

- an easy identification;
- a guarantee of authenticity and quality of services provided;
- international market penetration and promotion of ecotourism.

Certified products are still scarce to date, but there are growth perspectives. Such products are operated by AER members and products operated by non AER members (Table 5).

**Table 5.** Eco-Romania certified products

Operated by AER members	Location	Operated by non AER members	Location
Bio-Haus	Valea Hârtibaciului, Sibiu	Poarta Călimani Guesthouse	Gura Haitii, Suceava
Casa dintre sălcii	Delta Dunării	Valea Dornelor Guesthouse	Dorna Arini, Suceava
Felicia Pension	Suceava	Casa Verde Pension	Băile Tușnad, Harghita
Kalnoky Pension	Micloșoara, Covasna	Ibolya Pension	Băile Tușnad, Harghita
Popasul Hunea Pension	Dornelor Basin, Suceava	Pension Moara La Făgădău	Băile Tușnad, Harghita
Mosorel Pension	Zărnești, Brașov	Feher Akac Pension	Băile Tușnad, Harghita
Casa Alexandra Pension	Lunca Ilvei, Bistrița Năsăud	Hanul Hotarul Ciucului	Băile Tușnad, Harghita
Hilde's Residence	Gura Humorului, Suceava	Vila Șoimul	Băile Tușnad, Harghita
My Romania	<a href="http://www.myromania.com.ro/">http://www.myromania.com.ro/</a>	Mara Pension	Râu de Mori, Hunedoara
Inter Pares	<a href="http://www.inter-pares.ro/-/Sibiu">http://www.inter-pares.ro/-/Sibiu</a>	Zamolxe Pension	Sarmizegetusa, Hunedoara
Tioc Nature & Study Travel	<a href="http://www.tioc-reisen.ro/">http://www.tioc-reisen.ro/</a>	Ulpia Traiana Pension	Sarmizegetusa, Hunedoara
Mountainbike Romania.com	<a href="http://www.mountainbike-romania.com/">http://www.mountainbike-romania.com/</a>	Dora Pension	Râșor, Hunedoara
Photo Tour	<a href="http://phototour.ro/ro/">http://phototour.ro/ro/</a>	Iancu Pension	Sălașu De Sus, Hunedoara
		Codrin Chalet	Cârnic, Hunedoara
		Vila Veche	Hațeg, Hunedoara
		Mărioara Pension	Breb, Maramureș
		Padeș Pension	Breb, Maramureș
		Țiplea Pension	Ocna Șugatag, Maramureș
		Gherasim Pension	Danube Delta
		Oprișan Pension	Danube Delta
		Equus Silvania	Șinca Nouă, Brașov

Source: <http://www.eco-romania.ro/ro/sistemul-de-certificare/produse-certificate>

The number of certified accommodation facilities is greater than the certified travel agencies, as well as the number of certified products operated by non AER

members. Thus, it can be stated that the owners of accommodation facilities want to provide quality tourism products and services to maintain themselves on the tourism market and to better promote themselves.

This certification does not affect the classification of the accommodation facilities and travel agencies, which is done under the current legislation (Order no. 221/2015 on amending the Methodological Norms on the issue of classification of tourist accommodation and food service facilities, licenses and patents for tourism approved by Order of the President of the National Tourism Authority no. 65/2013 for approving the methodological Norms on the issue of classification of tourist accommodation and food service facilities, licenses and patents for tourism). It comes as an adjunction and gives domestic or foreign eco-tourists more confidence.

### CONCLUSIONS

Ecotourism is a form of tourism that aims people who prefer to spend their free time far away from crowds, polluted environments and want to live new experiences. A national strategy was formulated for the development of ecotourism in Romania, and the Association of Ecotourism in Romania supports the certification of products and services.

At the moment, several accommodation facilities from different parts of the country have been certified, as well as several travel agencies whose activity is carried out in the online environment.

Ecotourism can be developed in Romania with the common effort of governmental organizations, of central and local authorities, of NGOs and of the population in protected areas since there are sufficient valuable natural resources (protected areas) and legislation adapted to the current requirements.

### REFERENCES

1. Megan Epler Wood, 2002, *Ecotourism: Principles, Practices and Policies for Sustainability*, Paris, Burlington VT, UNEP;
2. Tudorache, D. (coord.), 2009, *Strategia națională de dezvoltare a ecoturismului în România* [National Strategy for Ecotourism Development in Romania], National Institute for Research -Development in Tourism, Bucharest, [http://www.mdrl.ro/\\_documente/turism/studii\\_strategii/ecoturism\\_faza1.pdf](http://www.mdrl.ro/_documente/turism/studii_strategii/ecoturism_faza1.pdf)
3. Honey, Martha, [https://en.wikipedia.org/wiki/ecoturism#cite\\_note-Honey\\_EandSD\\_29to31-7](https://en.wikipedia.org/wiki/ecoturism#cite_note-Honey_EandSD_29to31-7)
4. [www.eco-romania.ro](http://www.eco-romania.ro)
5. [www.pensiune-ecoturistica.ro](http://www.pensiune-ecoturistica.ro)
6. [www.wikipedia.org](http://www.wikipedia.org)
7. Government Emergency Ordinance no.57 / 2007 on the regime of protected natural areas, conservation of natural habitats and wildlife, approved with amendments by the Law no. 49/2011, Gazette of Romania, Part I, up to 13 April 2011.



## **IMPORTANCE OF WASTE MANAGEMENT AND ITS PLACE IN EDUCATIONAL SYSTEM OF THE REPUBLIC OF SERBIA**

**Aleksandra Bozic\* , N., Bukumiric, V. Alivojvodic, M. Stamenovic**

College of Vocational Studies, Belgrade Polytechnic, Belgrade, SERBIA

*\*abozic@politehnika.edu.rs*

### **ABSTRACT**

In the Republic of Serbia, there is a huge change in the field of waste management in the last decade. In order to improve the quality of working environment, local governments are introducing new, sustainable methods of waste management. The waste streams that had been generated have to be managed in a manner that is consistent with the basic principles of sustainable development. To make this area even more improved, it is necessary to strengthen the public awareness of environmental and, especially, problems of waste generation, and as a way to resolving this problems the greater attention has to be placed on the education of future professionals. This paper has the aim to highlight the importance of generating the future professionals in the field of waste management, and its placement in the educational system of Serbia.

**Key words:** waste, waste management, education.

### **INTRODUCTION**

In the Republic of Serbia, Waste Management is facing a period of rapid and radical changes. Following the European legislation and the need to improve the quality of the environment, local self-governments in the Republic of Serbia are faced with the necessity of finding sustainable methods of waste management and resources management. Also, it is necessary to find a way to reduce the amount of waste, exploitation of resources and solutions to reduce the amount of hazardous waste. It is necessary to manage the waste in a way that it does not threat the present and the future and to be kept in accordance with the basic principles of sustainable development. This approach requires a radical change in the current position of each individual towards waste by accepting responsibility and raising awareness that the responsibility will not be left to others. The key improvement of waste management is the need to develop the ability of professionals who work in the industry and the introduction of techniques and technologies in the education of future professionals in the field of waste. Public awareness about waste and the environment must be developed through the media, education in schools and various campaigns. To raise public awareness, education and training are the basic methods by which the whole community can reach their full potential.

## **NATIONAL LEGISLATION IN THE FIELD OF WASTE MANAGEMENT**

In the area of domestic legislation Waste Management Strategy for the period 2010 - 2019 (Official Gazette of RS, No.29 / 2010) and the Law on Waste Management (Official Gazette of RS, no. 36/2009 and 88/2010) are the two key documents defining the system of waste management at the national level.

Waste Management Strategy for the period 2010 - 2019, is a key document in order to provide conditions for rational and sustainable waste management in the Republic of Serbia. Implementation of the strategy involves all levels of government - from local government to the national level. As the most important objectives, defined strategy can be singled out as:

Compliance with EU legislation in the field of waste management;

- Providing of an organized system of waste collection for at least 90% of the population by the end of 2020
- Construction of the regional centers with sanitary landfills by at least 90% of the population by the end of 2020
- Reducing the amount of biodegradable waste that is deposited in the next 15 years, in line with the objectives of the EU Directive on landfills
- Achieving the objectives defined in the EU Directive concerning the recycling and reuse of waste until the end of 2025 [1].

The general objective of the waste management strategy, is to apply the basic principles of waste management at the national level, is solving the problem of waste at the source by the principle of prevention, separateing collection of waste materials, by the principle of neutralization of hazardous waste, solving the regional waste disposal and remediation dumps, implementing the basic principles of the EU in the field of waste, and preventing further danger to the environment.

Waste Management Strategy for the period 2010-2019. is the basic document that provides the conditions for rational and sustainable waste management in the Republic of Serbia [1].. The strategy must be supported by a large number of implementation plans for the management of specific waste streams (biodegradable, packaging, etc.). Identification of economic instruments and financial mechanisms is necessary to ensure the system for domestic and foreign investment in the long term sustainable activities. Also, the strategy considers the need for institutional strengthening, development of legislation, enforcement of regulations at all levels, education and raising public awareness.

To achieve the goals of sustainable development, in line with the National Strategy for Sustainable Development, it is necessary to ration the use of raw materials and energy and the use of alternative fuels from waste, reduce the risk of improperly disposed waste for future generations, ensure stable financial resources and incentive mechanisms for investment and implement activities according to the "polluter pays" and / or "user pays" principle, the establishment of a unified information system on waste, increase the number of inhabitants covered by municipal waste collection system,

to establish standards and capacity of waste treatment, reduce, reuse and recycle, raise public awareness at all levels of society on the issue of waste and ect.

For proper waste management, knowledge and constant communication with experts in the field are essential. Waste management is a profitable field that can employ a large number of individuals with the possibility of opening small factories of small and medium enterprises and strengthening existing enterprises. One of the big problems regarding waste management is a small number of experts who represent the pillar of the development of new recycling processes, landfill management, as well as the entire system of waste management. The contribution of higher education in the formation and training of personnel in the field of waste management is insufficient.

Law on Waste Management, which officially came into force in 2009, defines and regulates the following segments of waste management in the Republic of Serbia: types and classification of waste, waste management planning, entities, responsibilities and obligations in waste management, waste management of specific flows, conditions and procedures of licensing, cross-border movement of waste, reporting, financing of waste management, supervision and other issues of importance for waste management [2].

According to this Act, waste management represents an activity of general interest, and includes the implementation of measures prescribed for waste management including collection, transport, storage, treatment and disposal of waste, including the supervision of these activities and taking care of waste management facilities after their closure.

Pursuant to Article 8, paragraph 1 of the Law on the National Assembly ("Official Gazette of RS, No. 9/10) and Article 4, paragraph 3 of the Energy Law ("Official Gazette of RS ", No. 145/14), the National Assembly of the Republic of Serbia on the seventh session of the Second regular session in 2015, held on 4 December 2015, adopted the Strategy of energy development of the Republic of Serbia until 2025. with projections to 2030, in which significant attention is paid to obtaining energy from renewable energy sources including waste.

### **ASSESSMENT OF WASTE MANAGEMENT IN THE REPUBLIC OF SERBIA**

Despite the actions taken, the situation in the field of waste management is not satisfactory. There is insufficient education of the population about waste, the method of handling, treatment and disposal. They identified the following problems in waste management in the Republic of Serbia:

- Insufficient infrastructure for waste treatment and disposal,
- Joint disposal of municipal and hazardous waste from households,
- Lack of data on the composition of the waste stream,
- Lack of facilities for storage, treatment and disposal of hazardous waste,
- Contamination of soil, surface water and groundwater management.

The existence of a national waste management strategy and key legislation in the field of waste management, harmonized with EU directives, completed construction

of several regional sanitary landfills - regional centers for waste management, started construction of several regional sanitary landfills are good indicators that the Republic of Serbia on the road to systematic regulation problems that exist in this area.

On the other hand there has been untapped potential for waste recycling, as well as the possibility of incineration of waste in cement factories and power-plants. The problem exists in the field of establishing a system for the treatment and disposal of hazardous waste, as well as the lack of infrastructure for waste treatment and disposal (landfill REGIONAL regional centers for waste management, recycling plants, composting);

The consequence of poor waste management practices are polluting water, soil and air, and there are also degraded areas due to inadequate waste disposal and a large number of dump sites and illegal dumps. In rural areas there is a visible lack of an adequate system of organized waste collection and disposal [3, 4, 5].

Despite efforts in recent years there is still a lack of accurate data on the quantities of waste generated. Waste recycling capacities are limited. The population's awareness of their role in the system of waste management is underdeveloped.

It is important to mention that the analysis showed that in the Republic of Serbia is extremely small number of study programs to a greater extent, pay attention to this issue and that the observed area for the development of new study programs at higher education institutions at all levels of study.

#### **GOALS OF WASTE MANAGEMENT**

In the context of waste streams of Waste Management Strategy (Official Gazette of RS, No. 29/2010) the goals of waste management are determined.

General objective of waste management is to develop a sustainable waste management system in order to reduce environmental pollution and spatial degradation.

Specific objectives - Long-term objectives (2015-2019):

- Introduction of separate collection and treatment of hazardous waste from households and industry;
- Construct 12 regional centres for waste management – regional landfills, plants for the selection of recyclable waste and transfer stations in each region;
- Provide the capacities for burning (incineration) of organic industrial and medical waste;
- Strengthening professional and institutional capacities for hazardous waste management;
- Achieve the level of re-use and recycling of packaging material waste (glass, paper, carton, metal and plastic) of 25% of its volume;
- Establish the system of construction waste management and the asbestos-containing waste [1].

One of the factors of a strategic framework for waste management and the training of staff are raising of public awareness.



Development of human resources for the proper and sustainable waste management can be divided into three main areas:

- Professional training of staff (including training of waste producer);
- Education;
- Development of public awareness.

The aim of the training of personnel and development of public awareness is making recommendations for action that will:

- Increase the level of awareness of the widest population on environmental issues, especially among children and young people, creating a foundation for future action in sustainable waste management;
- Provide adequate technical and professional competence at all levels of institutions and organizations working in government bodies at all levels in accordance with the responsibilities, including private sector companies, with responsibility for waste management and law enforcement at all levels.

### **STAFF TRAINING**

Public awareness towards waste generation and the environment protection have to develop through discussions, media, education in schools and various campaigns.

To raise public awareness on any issue, the education and training are the basic methods by which the whole community can reach their full potential. Work on the development of human resources ready to commit themselves in resolving important issues for the survival of society in whole, which has its place at the handling of waste, is of great importance for strengthening the capacity of the country in the field of sustainable development.

According to Waste Management Strategy, professional training is required in the following fields of waste management [1]:

- ✓ Legal and legislative framework;
- ✓ Financial system and accountancy;
- ✓ Tender preparation;
- ✓ Licensing and monitoring;
- ✓ Economic planning and budgets;
- ✓ Practice and procedures of waste separation;
- ✓ People's health and safety;
- ✓ Practice and procedures of medical waste management;
- ✓ Practice and procedures of individual composting;
- ✓ Practice and procedures of hazardous waste management (households hazardous waste, chemicals packaging waste, etc.).

Efficient education and adequate motivation of students in primary schools will have long-term effects on behaviour of individuals. These individuals can become participants in the realisation of various initiatives in waste management.

The Republic of Serbia is at the very beginning of the development of waste management systems. Very encouraging are the efforts of relevant institutions to improve waste management at local, regional and the national level.

Development in any sector of the economy of one country has to have support by the experts in the specific field of interest. This creates the need for education of professional staff in the field of waste management. Without creating public awareness about the importance of education of experts in this field, there can't be neither fully or correctly implemented strategy for development of new industries, nor "the green technology".

### **CONCLUSIONS**

Waste management field in the Republic of Serbia represents a set of new opportunities for economic development, with respect of the environmental protection principles, as well as sustainable development. Serbia as a developing country has to meet strict laws and directives in the field of waste management on its path towards the EU. Laws are not the only documents that oblige us to take care of generated waste, but also concern for the future of generations that are coming after us.

It is of a crucial importance to improve the current situation in the field of waste management in the Republic of Serbia. One way to do that is to develop professionals trained to work on the development and application of techniques and technologies related to approaches to waste management practice, and their active involvement in the work processes of public and private systems that deal with the management of non-hazardous and hazardous waste, municipal activity, or utilization of energy from waste.

### **REFERENCES**

1. The National Waste Management Strategy, 2010-2019, Official Gazette of RS, no. 29/10,
2. The Law on Waste Management, Official Gazette of the Republic of Serbia, no. 36/09.
3. Report on the state of the environment in the Republic of Serbia for 2014, Ministry of of Agriculture and Environmental Protection, Belgrade, Serbia, 2015.
4. G. Tchobanoglous, F. Kreith, Handbook of Solid Waste Management, McGraw-Hill, Inc., New York, 2002.
5. Вујић, Г., Убавин, Д., Станисављевић, Н., Батинић, Б. Управљање отпадом у земљама у развоју, ФТН НОВИ САД, 2012.



## ENVIRONMENTAL ASPECTS OF SUSTAINABLE DEVELOPMENT

Dina Maria Luț

“Dimitrie Cantemir” Christian University Bucharest,  
Faculty of Touristic and Commercial Management Timișoara, ROMANIA

dinalut@yahoo.com

### ABSTRACT

Sustainable development has developed as a concept through several decades of active international scientific debate and has acquired distinct political connotations in the context of globalization. It is widely recognized that the Earth has a limited capacity to meet the growing demand of the socio-economic systems for natural resources and to absorb the destructive effects of their overuse. All definitions of sustainable development require that we see the world as a system - a system that connects space and a system that connects time.

When we focus on the environmental aspects of sustainable development, we look at the natural resources, both renewable and non-renewable, those make up our surroundings and help us to sustain and better our lives. One way of measuring a country's level of development is to look at environmental data such as **access to safe water**, which measures the percentage people who can get all the safe water they need to lead healthy lives.

Several research studies showed that, treated wastewater, if appropriately managed, is viewed as a major component of the water resources supply to meet the needs of a growing economy.

Early research on tended to focus on the separation of metals for analytical and/or environmental applications. In all the reported studies, commercially available metal specific liquid extractants were used to impregnate porous particles, mostly polymeric, to recover heavy and precious metals from low concentration aqueous solutions.

**Key words:** sustainable development, environmental protection, access to safe water, material impregnated, resin.

### INTRODUCTION

Sustainable development has been defined in many ways, but the most frequently quoted definition is from *Our Common Future*, also known as the *Brundtland Report*:

*"Sustainable development is development that meets the needs of the present without compromising the ability of future generations to meet their own needs."* (WCED, 1987: 46).

*It contains within it two key concepts:*

- *the concept of **needs**, in particular the essential needs of the world's poor, to which overriding priority should be given;*
- *the idea of **limitations** imposed by the state of technology and social organization on the environment's ability to meet present and future needs."*

All definitions of sustainable development require that we see the world as a system - a system that connects space and a system that connects time.

When we think of the world as a system over space, we grow to understand that air pollution from North America affects air quality in Asia, and that pesticides sprayed in Argentina could harm fish stocks off the coast of Australia.

And when we think of the world as a system over time, we start to realize that the decisions our grandparents made about how to farm the land continue to affect agricultural practice today; and the economic policies we endorse today will have an impact on urban poverty when our children are adults.

We also understand that quality of life is a system, too. It's good to be physically healthy, but what if you are poor and don't have access to education? It's good to have a secure income, but what if the air in your part of the world is unclean? And it's good to have freedom of religious expression, but what if you can't feed your family?

The concept of sustainable development is rooted in this sort of systems thinking. It helps us understand ourselves and our world. The problems we face are complex and serious and we can't address them in the same way we created them. But we *can* address them.

### **EVOLUTION OF THE “SUSTAINABLE DEVELOPMENT” CONCEPT**

Sustainable development has developed as a concept through several decades of active international scientific debate and has acquired distinct political connotations in the context of globalization.

The concept of sustainable development proposes an integrated policy and decision-making approach, in which environmental protection and long-term economic development are considered to be complementary and interdependent.

The first signal that economic and social development of the world's states and of humanity as a whole can no longer be separated from the consequences of human activity on the natural environment was set forth in the 1972 report of the Club of Rome on the *Limits of Growth* (Meadows Report).

The issues involved in the relationship between humankind and the environment became a matter of concern for the international community starting with the United Nations Conference on the Human Environment (Stockholm, 1972) and took concrete shape in the work of the World Commission on Environment and Development, which was established in 1985.

The report of the Commission on *Our Common Future* was presented in 1987 by G. H. Brundtland. It offered the first broadly accepted definition for sustainable development, as “*the development path that meets the needs of the present generation without compromising the ability of future generations to meet their own needs*”.

Henceforth, the complex problems of sustainable development acquired a global political dimension as they were tackled at the summit-level United Nations Conference on Environment and Development (UNCED) in Rio de Janeiro (1992), the Special Session of the United Nations General Assembly which adopted the Millennium Goals (2000) and the Earth Summit in Johannesburg (2002).

It is thus widely recognized that the Earth has a limited capacity to meet the growing demand of the socio-economic systems for natural resources and to absorb the destructive effects of their overuse.

A series of international conventions were adopted in the course of this process, spelling out precise obligations for states and strict implementation deadlines in such areas as climate change, biodiversity conservation, the protection of forests and wetlands, curbs on the use of certain chemicals, access to information regarding the state of the environment, and more. Those agreements define the international legal space for the application of the aims and principles of sustainable development.

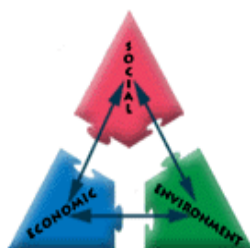
Bugle (2008: 20) believes that Brundtland report contains four basic principles which are the basis of both policy and legal framework:

- Equity and social justice; meeting the basic needs for all individuals;
- Integration of environmental considerations in all aspects of economic and social development;
- A strict prohibition of destroying / degrade the natural resources and environment on which life and welfare of future generations;
- Integration of long-term perspective in making decisions.

### THE THREE E'S OF SUSTAINABLE DEVELOPMENT

People concerned about sustainable development suggest that meeting the needs of the future depends on how well we balance social, economic, and environmental objectives or needs when making decisions today. Some of these needs are itemized around the puzzle diagram.

When we focus on the social aspects of sustainable development, we look at the issues that impact people directly and that either help or hinder the process of improving the quality of life. The goal of sustainable development is to improve living standards and the quality of people's lives, both now and for future generations. Social issues are an important piece of the development "puzzle."



<p><b>Services</b></p> <p><b>Household Needs</b></p> <p><b>Industrial Growth</b></p> <p><b>Agricultural Growth</b></p> <p><b>Efficient Use of Labor</b></p>	<p><b>Equity</b></p> <p><b>Participation</b></p> <p><b>Empowerment</b></p> <p><b>Social Mobility</b></p> <p><b>Cultural Preservation</b></p>	<p><b>Biodiversity</b></p> <p><b>Natural Resources</b></p> <p><b>Carrying Capacity</b></p> <p><b>Ecosystem Integrity</b></p> <p><b>Clean Air and Water</b></p>
---	--	--

Figure 1. Dimensions of sustainable development

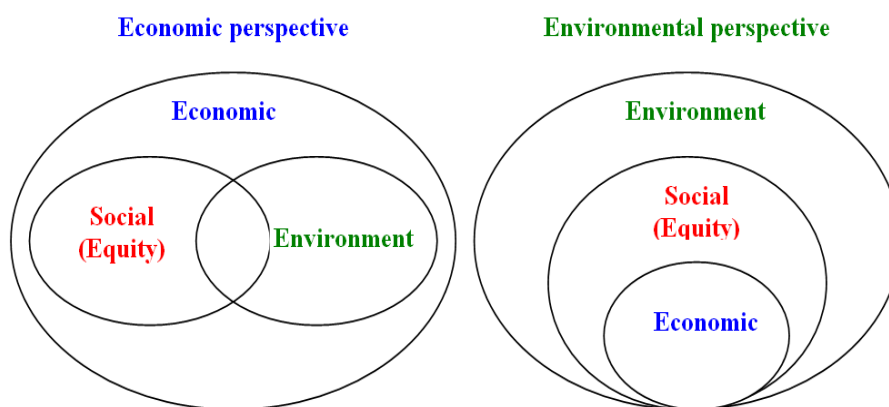
When we focus on the economic aspects of sustainable development, we look at the system that determines how the limited resources needed to improve peoples' lives are distributed. We also examine how these limited resources are used.

When we focus on the environmental aspects of sustainable development, we look at the natural resources, both renewable and non-renewable, those make up our surroundings and help us to sustain and better our lives.

Environmental concerns are inextricably linked to economic issues such as poverty. People living in poverty may damage the environment as they struggle simply to survive, cutting down trees for fuel wood, exhausting crop land, and contaminating urban water supplies with waste they cannot afford to treat.

Environmental concerns are also linked with social issues such as population growth. A rapidly growing population places strains on a country's natural resources, as well as on its ability to provide housing, health care, education, safe water, and sanitation for all.

Although ideally these three dimensions should be tied, this is more difficult to achieve in practice. Traditionally, the economic dimension has received the most attention.



**Figure 2.** The three e's of sustainable development  
Sursa: Wheeler (2004), p. 31.

Wheeler (2004) says that we are now in a transition from an economic perspective towards an environmental perspective. In the first approach, economic values are fundamental and only within these values, we have the social and environmental dimensions, as sub-sets of values. (fig. 2)

In the environmental perspective, sustainable development requires that economic values are only a subset of ecological and social values, with a greater scope of coverage.

## ENVIRONMENTAL ASPECTS OF SUSTAINABLE DEVELOPMENT.

### *Access to safe water*

One way of measuring a country's level of development is to look at environmental data such as *access to safe water*, which measures the percentage people who can get all the safe water they need to lead healthy lives.

Access to safe water is measured by the number of people who have a reasonable means of getting an adequate amount of water that is safe for drinking, washing, and essential household activities, expressed as a percentage of the total population. It reflects the health of a country's people and the country's capacity to collect, clean, and distribute water to consumers.

Water is essential for life, yet in 1995, more than one billion people in low- and middle-income countries and an additional 50 million people in high-income countries lacked access to safe water for drinking, personal hygiene and domestic use (World Bank Institute, 2003).

Safe water includes treated surface water, as well as untreated but uncontaminated water from sources such as natural springs and sanitary wells. On average, a person needs about 20 liters of safe water each day to meet his or her metabolic, hygienic, and domestic needs. Without safe water, people cannot lead healthy, productive lives.

Improvements in water supply and sanitation tend to lead to improvements in people's health and the quality of their lives. Throughout history, when people have had an adequate supply of safe water and have been able to practice good hygiene, they have been healthier and have had a better chance of living longer.

Experience from around the globe shows that when people, even the poorest, have a choice in the quality of their water supply and sanitation services, they often are willing to pay a higher price to get higher quality. For example, people who are unwilling to pay for operating and maintaining low quality handpumps and pit latrines may be willing to pay more to get a basic system of piped water and sewers that works fairly and efficiently.

On the other hand, households and industries are not always willing to pay for higher quality services if they feel that what they are receiving is already good enough. For example, some coastal communities in the United States have refused to pay for what they perceive to be unnecessary and expensive sewage treatment even though it is required by federal law for environmental protection. In the end, it appears that when members of a community - households, factories, farmers, and businesses, together with scientists and policy makers - all participate in making decisions about the most feasible system of supplying safe water and sanitation, everyone tends to be more satisfied with the quality and price of these services (World Bank Institute, 2003).

Conventional polymer-based chelating ion-exchange resins have great selectivity for the separation of various metal ions from water. However, there are only a few notable large-scale industrial applications of chelating ion-exchange resins to date due to the fact that the synthesis of these materials is complex, time consuming and costly. Solvent-impregnated resins (SIRs) can be considered as alternative adsorbent

materials since they are similarly capable of selective sorption. SIRs comprise a polymeric matrix impregnated with readily available liquid ionic extractants, are relatively easy to prepare and they combine the unique features and process advantages of liquid–liquid extraction and ion exchange.

## CONCLUSIONS

Water shortage is currently one of the biggest concerns of human beings world wide. According to the Kyoto summit in 2003, two billion people will not have access to safe drinking water supplies in the year 2015 (Bahri 2003).

Several research studies showed that, treated wastewater, if appropriately managed, is viewed as a major component of the water resources supply to meet the needs of a growing economy (El-Fadel, 2002: 619, Tahboub, 2000, Wendland, 2003.).

Access to safe water is critical to economies and ecosystems, too, and a scarcity of safe water can directly affect long-term prospects for sustainable development. Without an adequate water supply, factories that depend on water may have to close temporarily; crop yields may decline; sick workers may be unproductive; fisheries may be destroyed. The destruction of aquatic life not only cuts into the economy, but also damages the ecosystem. In addition, lack of a reliable system of piped water can prompt people to sink their own wells and deplete the fresh water supply. Air quality can also be affected by shortages of safe water. When people boil household water to kill dangerous bacteria, the fuel they burn can pollute the air. And when they use wood or charcoal as their source of fuel, forests can be destroyed causing additional environmental problems, including erosion and loss of top soil (World Bank Institute, 2003).

There are currently more than 1000 million people in the world that lacks access to an easily accessible and safe water source, such as a connection to water mains or a protected well. Instead, water access is limited or available through unprotected sources. The target, under the Millennium Development Goals, is to halve, by 2015, the proportion of people without sustainable access to safe drinking water and sanitation. (Ahlenius, H., UNEP/GRID-Arendal, 2005)

Ensuring that people have an adequate supply of safe water involves an often complex mixture of social, economic, and environmental issues. In recent years, people, industries, farmers, and governments have begun to acknowledge that water is an economic good, not a "free" limitless resource. And as an economic good, there is a wide range in the quality and level of water delivery and sanitation services that people want and are willing to pay for.

## REFERENCES

1. Ahlenius, H., UNEP/GRID-Arendal, Access to safe drinking water, 2005 ([http://www.grida.no/graphicslib/detail/access-to-safe-drinking-water\\_de64](http://www.grida.no/graphicslib/detail/access-to-safe-drinking-water_de64)).
2. Bahri A., Water reuse in the Middle East, North Africa and Mediterranean Countries. National Research Institute for Agricultural Engineering, Water and Forestry, Tunisia, Kyoto Water Forum, 2003.



3. Bugge, H. C., „1987-2007: „Our Common Future Revisited”, in Sustainable Development in International and National Law, Groningen: Europa Law Publishing, 2008.
4. El-Fadel M. El-, M. Zeinati and D. Jamali, Water resources in Lebanon: characterization, water balance, and constraints. *J. Water Resour. Develop.*, 16(4) (2002) 619–642.
5. Tahboub M.A., Evaluation of wastewater treatment alternatives for Hebron City, Master Thesis, Birzeit University, Palestine, 2000.
6. WCED (The World Commission on Environment and Development), *Our Common Future*, Oxford: Oxford University Press, 1987.
7. Wendland C., J. Behrendt and R. Otterpohl, Sanitation concepts for small communities. Contribution to the decision making process for the pilot plants within EMWATER-Project report, 2003.
8. Wheeler, S.M., *Planning for Sustainability. Creating Livable, equitable, and Ecological Communities*, New York: Routledge, 2004.
9. World Bank Institute, WDR 2003: Sustainable Development in a Dynamic World, 2003 ([www.worldbank.org](http://www.worldbank.org)).



## **PLAN FOR ESTABLISHING LAWNS**

**Nenad Stavretovic**

University of Belgrade, Faculty of Forestry, Belgrade, SERBIA

*nenad.stavretovic@sfb.bg.ac.rs*

### **ABSTRACT**

Plan for establishing lawns need always to determine, primarily for reasons of economy. Good plan enables savings in time, materials, labor force and ensure the quality of the work done.

**Key words:** lawn, maintenance, horticulture, landscape architecture.

### **INTRODUCTION**

Any business that does not take place it is necessary to pre-plan. Planning provides us with a better execution of the task, or better, cheaper, faster. When we planned the city every element that constitutes work, planned work force necessary for the execution, we need a material, a large part of our work is done.

In order to plan the establishment of any green space, and the elements that make it we must have full information about it, whether it be on the structure of an area, village, street, building, green areas. These same goes when it comes to establishing a single element green spaces such as trees, groups of trees, shrubs or lawn.

Establishment plan needs to be familiar with the information listed below:

1. The detailed introduction to the edaphic-climatic conditions
2. defining the purpose lawn
3. defining the size and shape lawn
4. The selection of the city to raise the lawn
5. The surface preparation of land for the establishment of lawns
6. Calendar of Activities

### **DETAILED INTRODUCTION TO EDAPHIC-CLIMATIC CONDITIONS**

Introduction to edaphic climatic conditions means and knowledge to interpret it in a proper manner and for the purpose of establishing the pitch.

We will briefly describe some examples of why this part of the planning for establishing lawns very important:

- Floristic composition of natural and artificial lawn is different depending on the altitude, as they vary valley, mountain and alpine meadows. The altitude and climatic conditions determine the botanical composition of natural grassland, and an engineer with knowledge and skills form a mixture of seeds for artificial grass surfaces. The composition of these mixtures depend on the purposes of the pitch, altitude, climate, soil composition or from environmental conditions prevailing.

- The soil composition, soil affect the survival of plants at the place where they are used, some plant species can not tolerate shallow soils, others do not tolerate compacted soil, wetland, or drought. In an earlier practice of forming pitch we had a case that the high grass cover, good density and color brought in the form of grass carpets the meadows on the soccer fields. In terms of the city, drainage, substrates such lawn is rapidly deteriorating. The main reason for the deterioration was the change in soil conditions in which it occurred, and its transplantation into the drier climate conditions, lack vlažnosti and drainage present in the form of drainage channels.

### **DEFINING THE PURPOSE OF LAWN**

Another very important issue in planning for establishing grass surfaces is its purpose. In agriculture are clearly distinct methods of establishing grasslands for grazing purposes, or meadow. This is very important both in landscape planning and greening of small projects.

Even in a mountain and we need to determine the purpose of the turf. At the entrance to a garden, yard usually form a decorative (parterre lawn), around the house is formed by an ordinary lawn that are trampled and often form a lawn that has the purpose of intensive trampling type sport lawn. If there is a large area under the slope then the surroundings have a lawn with no fixed purpose erosion control. Each of these grassland is based in a different way, different seed mixtures, different substrate preparation. Later on they apply different rates of care and maintenance, where their intensity varies (Beard, 1983).

Parks also contain more than one type of grass areas, rarely in them only a park lawns or just decorative. If they all formed, renovated and maintained as a decorative lawns, it would be too expensive, uneconomical, and the kranju hand bad, wrong. Decorative lawn would be quite expensive to maintain if it was conceived as a grass shadows, shadows or lawn would collapse if we kept as decorative lawns. Consider the case of a nursing management lawn watering.

In football fields, for example, different courts and the establishment of the main auxiliary. Auxiliary fields are used several times a day, while the main course mostly used for games and warming (Eric and Bošković, 1998).

On the golf course has five teams lawns and a very differences their establishment, maintenance, and prices generally. "Green" is contrary to a few millimeters to one centimeter, while "semiraf" cuts a couple of times a year (sometimes one).

Defining the purpose of the lawn in any space, also includes knowledge of methods of formation, care and maintenance. Without knowledge of the problems of the lawn, defining their purpose can not be comprehensive and well (Stavretović, 2008).

### **DEFINING THE SIZE AND SHAPE OF THE LAWN**

Size of the pitch is directly related to the design of green spaces. There is a large green area with a small lawn and a small green area with a large lawn in respect of its entire surface. Size lawns directly affect the price of its establishment, that is the unit cost of establishing  $m^2$  grass surface. Also affect the price and the way of maintenance, or the use of certain tools, machines and methods during the establishment and subsequent care and maintenance. When establishing lawns large area is possible machining area, whilst in small areas of grassland this operation must be carried out manually.

Form of lawn to a large extent determined by good design green spaces of any type, park, residential blocks, and similiary (Turgeon, 2002). A well designed lawn is easier to design and easier to maintain. Too many curves lawn edges require the application of additional tools, machinery in the process of its formation, and the rate is much more important, but it will be more expensive during the entire time of his life in a particular place. As an example, we will mention the most common measure of lawn maintenance, mowing. Mow the lawn in the direction back and forth is the simplest and fastest, while mowing the lawn around the flower garden, shrubs and individual trees require more time, more precise work, and accessories, which in regards to the need for additional time and resources.

### **CHOOSING WHERE WE WILL FORM A LAWN**

The procedure of selecting the place where we will form a lawn or a lawn certain purposes requires effort and knowledge, as in the previous items.

The formation of lawn for children to play on steep areas is a false choice, because the game will be limited children or impossible. The formation of a new lawn at the surface where there is a lot of root offshoots would endanger the survival of the species whose roots whether it is about trees or other vegetable elements green areas.

The formation of the lawn with concrete curbs that are molded concrete or around columns, helps prevent the growth of grass in the warmer periods of the year.

The lawn is a green area which efficiently opens and defines the way to significant space objects such as fountains, lakes, sculpture, places to play and other aspects of the assembly.

### **PREPARATION OF THE SURFACE AREA FOR THE ESTABLISHMENT OF LAWNS**

Surface preparation of land for the establishment of lawns require consideration of the need for ravnasnjem surface profiling, installation of drainage and irrigation, liming, fertilizing, Primary and preseedings treatment area.

- Handling and profiling the surface, it is depending on the type of lawn that is formed, the finest terrain profiling is done on the lawns of "green" golf course.
- Setting up of drainage and irrigation systems.
- Liming is done on acid soils to sour, which corresponds to the growth and development of grass that will make up the lawn.
- fertilization has required surgery for poor land, of those who do not have enough humus, and nutrients.
- Basic and preseedings tillage, are performed on all surfaces. The quality and fineness sowing process is different in different types of grass surfaces, finer processing is necessary for fine, thick, low-mowed lawn. The finest-sowing treatment of the terrain like the lawns of "green" golf course, whereas the toughest codes erosion grasslands, meadows and pastures (Stavretović, 2012).

### **CALENDAR OF ACTIVITIES**

Calendar of activities related operations for formation, care and maintenance of lawns should be viewed from two temporal aspect, it is an annual and daily aspect.

Grass is the best in terms of efficiency and cost-based best during the spring and autumn. Then the conditions of humidity and temperatures favorable for the operations of soil preparation and seed germination.

Establishing lawns during the summer and winter requires fortunate circumstances with the weather conditions and large funds to supplementing them. An early frost in late fall or early winter can completely destroy a lawn designed in any way. Also the high temperatures and drought can cause destroying the lawn to a large extent or completely.

Daily activity aspect is often neglected, but very important. Sowing seeds or setting up grass carpet is best to perform in the morning or evening hours. Operations watering, chemical handling, nutrients, it is best carried out during the early morning or early evening. This is valid for operation vertikulacije, aeration, and even cutting. Of course, proper sled operation reduces the possibility of major damage to the lawn. In a word, we can conclude lawn requires proper and timely implementation of measures establishing, and later measures of care and maintenance.

### ***Acknowledgements***

*This paper has been realised as a part of the project, "Studying climate change and its influence on the environment: impacts, adaptation and mitigation" (43007) financed by the Ministry of Education and Science of the Republic of Serbia within the framework of integrated and interdisciplinary research for the period 2011–2015.*

### **REFERENCES**

1. Beard, J. B. (1983): How to have a beautiful lawn (Easy steps in turf grass establishment and care For aesthetic and recreational purposes), Third Edition Published by BeardBooks College Station, Texas, 113.

2. Erić, P., Bošković, P. (1998): Travnjaci okućnica, parkovai igrališta. – Naučni institute za ratarstvo I povrtarstvo, Novi Sad, 151.
3. Stavretović, N. (2008): "Kvalitetne vrste i korovi u travnjacima urbanog područja", Monografija, Unija Bioloških naučnih društava Srbije, Beograd
4. Stavretović, N. (2012): Proizvodnja travnih tepiha, monografija, ured. Božidar Ćurčić, str. 1-108, Srpsko biološko društvo, Beograd, ISBN 978-86-81413-06-7.
5. Turgeon, A. J. (2002): Turfgrass management (sixth edition). Copyright by Pearson Education, Inc. Upper Saddle River, New Jersey 07458 (USA), 387.



## THE ROLE OF SPATIAL PLANNING IN SERBIA ON ADAPTATION TO CLIMATE CHANGE

Dejan Filipovic<sup>1\*</sup>, G. Trbic<sup>2</sup>, V. Secerov<sup>1</sup>, I. Samardzic<sup>1</sup>

<sup>1</sup>University of Belgrade, Faculty of Geography, Studentski trg 3/III, Belgrade, SERBIA

<sup>2</sup>University of Banja Luka, Faculty of Sciences, Department of Geography, Banja Luka, BOSNIA AND HERZEGOVINA

*\*prof.dejanf@gmail.com*

### ABSTRACT

Based on previous research and practice can be concluded that at the national level in Serbia there are a number of relevant strategic documents are observed adaptation to climate change. Spatial Plan of the Republic of Serbia until 2020 considered the issue of climate change. Defines general and specific objectives, defined the concept of development and certain strategic priorities for the first implementation period in terms of establishing a system of risk management of climate change. Based on the setting of strategic documents and obligations arising from international treaties, conventions and declarations, in spatial plans define the basic settings that climate change may have on the appropriate space.

**Key words:** Spatial planning, Serbia, climate change, adaptation.

### INTRODUCTION

The Republic of Serbia is included among the regions of the world that are heavily influenced by climate change and are very sensitive to them. This area is rapidly heated more intensively for years been hit by the consequences of climate change: an increase in temperature, tropical heat waves, droughts and fires, floods and landslides, soil erosion, high groundwater, storm winds, seismic activity. Adverse effects related to agricultural production, energy production, water supply, biodiversity, human health and the extensive damage to infrastructure facilities, which is expected to rise in the air temperature and evaporation, further reducing the number of days with snow cover and precipitation as well as the rainfall in the warm period followed by reducing water flow, soil moisture and availability of water resources. Expected changes in the frequency and intensity of climate extremes - storms accompanied by flooding, and the devastating effect of wind, drought, extremely high or low air temperatures, heat waves, landslides and forest fires.

The first report of the Republic of Serbia to the United Nations Framework Convention on Climate Change (2011) pointed out that on an annual basis to expect a further rise in temperature. According to one scenario, the temperature rise for the

period 2001-2030. amounted to between 0.8 and 1.1 ° C, while in the case of the second scenario this increase for the period 2071-2100. ranged from 3.4 to 3.8 ° C. Also, according to the first scenario changes of rainfall in the first thirty years of this century was slightly positive with values up to + 5% in most of the territories in relation to the reference period 1961-1990. According to another scenario in the last thirty years of this century on the territory of Serbia would have a deficit of rainfall annually with a maximum of 15%. According to this report, the assessment is to unfavorable climatic conditions caused a further increase in temperature, decrease in precipitation and other changes in the climate system in the future certainly had multiple negative effects.

### **THE RELATIONSHIP OF SPATIAL PLANNING AND CLIMATE CHANGE**

The issue of climate change in the zoning plans is variously represented. Appropriate instruments in the plans attention is paid primarily to reducing the impact of climate change due to excessive heat and exhaust gases that threaten the ozone layer, as well as engagement of alternative, renewable, energy sources where there exist favorable conditions. In the plans, within the natural characteristics and natural disasters, must be considered consequences for space arising extreme deterioration phenomenon due to the impact of climate change.

An integral part of the plan seems to identify the basic problems in the field of climate change, operational objectives, the concept of spatial development in the context of the effects of climate change, as well as the determination of the strategic priorities in order to establish a risk management system to climate change. The plan primarily focuses on the reduction of the impact of climate change due to excessive heat and exhaust gases that threaten the ozone layer, as well as engagement of alternative, renewable, energy sources where there exist favorable conditions.

According to the general definition, adaptation to climate change involves predicting when and where the effects of global warming to happen, developing adaptation strategies and taking concrete measures to reduce vulnerability to climate change impacts. Measurements can be very diverse from the technical, institutional, legal, educational measures to change the behaviors.

Customizing can be considered a kind of precautionary principle, as is done in advance - it is an activity to prevent or reduce future risks. But as in all high-risk situations, when we opt for a strategy we need to evaluate and compare the existing risks and opportunities (Giddens, 2010: 198).

The document *Climate Neutral Cities: How to Make Cities Less Energy and Carbon Intensive and More Resilient to Climatic Challenges* emphasizes the crucial importance of connecting policy of adaptation to climate change with spatial planning. Spatial planning has instruments to reduce vulnerability and increase the resilience of the risks in the specific local conditions. Complex and comprehensive planning of adaptation measures can be incorporated in a variety of areas of intervention, from the protection of infrastructure to prevent social segregation.

Various forms of spatial planning represent an adequate framework for integrating policy of adaptation to climate change. Planning includes tools to identify areas



that are at risk, as well as intervention strategies with consequences that last for decades and centuries. As part of planning decisions which created a cycle of dependence: the investment depend on the patterns of land use and infrastructure in place, which further determine the economic development of certain types and intensities.

Today it is widely accepted that the planning does not amount to making the plan only needs to show the distribution of physical structures in space, but it is part of the political process, in order to balance the relevant public and private interests, to relativize the conflicting requirements of spatial and development programs, the role of planners as mediators in this process (the New Charter of Athens 2003, the ECTP's Vision for Cities in the 21st Century). Climate change is presenting a completely new kind of challenge for spatial planning and spatial research, particularly as the European Commission in 2009, presenting a White Paper on adaptation to climate change for the space of the European Union, stressed the key role of spatial planning, through coordinated and integrated approach to be established adjustment measures within the framework of the national strategy of spatial development.

Adaptation and mitigation of climate change is becoming urgent multidimensional and interdisciplinary area of consideration and research. Climate change is no longer just a matter of environmental protection and environmental awareness. This term encompasses the main topics of this century: economic growth, energy security and sustainable environment. They are global in its causes and consequences, so that only joint international action can run effective and efficient solutions at different levels. The consequences of climate change can not be predicted with absolute certainty, but already knows enough to be considered risks in the area of increasing the air temperature, the availability of drinking water, reduction of biodiversity, food quality, and overall living conditions and the impact on human health. To achieve transition to a climate-smart world (a climate-smart world) required to act now, to act jointly and to act on several fronts.

The total reinventing spatial planning in our country should be aimed at, first of all, an integrated approach to spatial planning by the principles of sustainable development, adapting to climate change and the evident acceptance of territorial cohesion as one of the development principles of the European Union, in order to reach successful coping with insufficient foreseeable risks of climate change . According to Giddens, the essence is not in dealing with risks, not over-estimate the danger. Our obligation is to assess the risks measured and versatile, with due consideration to the positive aspects of climate change.

### **THE SPATIAL PLAN OF THE REPUBLIC OF SERBIA**

The strategies and plans adopted in recent years in Serbia, more represented the concept of sustainable development, which is a prerequisite for solving problems that have an impact on the environment and climate change. Based on the analysis, strategic orientation and the current legislation, it can be stated that the aim of the Republic of Serbia increased use of energy from domestic sources, reducing imports of energy and reducing negative impacts on the environment, all of which contributes to climate change.

To adaptation measures were successful, they need to be integrated into a number of public policy. This is certainly a very challenging and difficult achievable in conditions of underdevelopment and the major development problems faced by countries in transition. Integration is an iterative process of linking development policies with adaptation policies, budget financing, implementation and monitoring process (sectoral and intersectoral, at different levels). This activity implies the involvement of numerous stakeholders in the various stages of the process, linking the public, private and civil sector. For a successful integration of the basic problem is finding the key points of connection and the establishment of joint interest. It is necessary to understand the relationship between different priorities, climate and development, as well as the understanding of the administrative, institutional and political context that allows the inclusion of different aspects of policy adaptation in development planning. The problem of integration is generally considered at the national level, the national plans and sector strategies based on an insight into the specific factors, the impact, vulnerability, adaptation assessments, as well as the socio-economic analysis.

The Spatial Plan of the Republic of Serbia from 2010 to 2020, set out the long term fundamentals of the organization, development, use and protection of the Republic of Serbia with the aim of harmonizing economic and social development of the natural, environmental and cultural potentials and limitations in its territory. As one of the components of the Plan, climate change is seen as a separate chapter and for the first time in the methodology of development of republican physical plans. Spatial Plan of the Republic of Serbia (RS, 2010a) is the first formal comprehensive document, strategic spatial plan in which climate change mitigation and adaptation is given an important place. This document formulates a large number of operational objectives and include various aspects of activities related to climate change (Chapter: Operational objectives). In the document does not indicate the manner in which they exercised at different levels, but especially at the local level, which will bring significant results.

The main goal is the inclusion of climate change as a factor of sustainable development and environmental protection in sectoral strategies and to develop a sustainable system of risk management of climate change in the Republic of Serbia.

*The main problems* in the area of climate change that have been identified in the Republic of Serbia are:

- in the application of climate data and information for planning and design still apply standard methods and guidelines based on the stationarity of sentiment;
- there is heightened awareness of the need for inclusion of climate change as a factor of sustainable development into sectoral strategies, particularly the vulnerable sectors to climate change (agriculture, water management, forestry, energy, tourism, health, construction, transport, etc.);
- not provided adequate support for the implementation of multidisciplinary research program of climate change impacts, vulnerability and adaptation options;
- there is a special state program for solving the problem of climate change;
- limited financial capabilities for the purpose of strengthening the capacities (systemic, on institutional and individual), education, training and information.

The concept of spatial development in the context of the effects of climate change in the development of certain areas of Serbia in the Spatial Plan of the Republic

of Serbia can be impl through two complementary approaches: general concept of development based on knowledge of Observed and expected climate change and the impacts of climate change on the availability of natural resources (first phase) and sectoral development concepts that will thoroughly consider the effects of climate change, both negative and positive, necessary for the proper planning of spatial development in the framework of the sector (second phase).

*The concept of spatial development* in the context of the effects of climate change include:

- a. determining changes in climate zones for different scenarios of global climate change and the different time periods relevant to strategic planning and long-term measures for the protection and sustainable use of natural resources;
- b. determining the effects of climate change on the availability of natural resources, especially water resources, arable land, forests and other ecosystems and biodiversity in order to plan for sustainable development and environmentally friendly activities in areas vulnerable to climate change;
- c. development of spatial data and information on local and regional climate change, including information on climate extreme events and disasters, the vulnerability of certain areas, for their use in spatial and urban planning;
- d. adoption and implementation of new measures in the conservation and protection of water resources, agricultural and forest land and use of renewable energy sources in the context of the assessment of the effects of climate change and adaptation to changing climatic conditions;
- e. Application of Conventions, standards and good practices and experiences in the EU and other developed countries on the inclusion of climate change factors in the planning of spatial development;
- f. updating of sector strategies, instruments, measures and policies to the harmonization of inter-sectoral coordination and participation of the local communities and institutions is; etc.

The Spatial Plan of the Republic of Serbia, in order to protect the climate and to establish a system of risk management of climate change are determined by the following strategic priorities that must be the basis for developing the lower level:

- The implementation of the program of multidisciplinary research of climate change and local impacts of climate change on agriculture, forestry, water management, energy, biodiversity and ecosystems, infrastructure and health of the population and development sectoral plans and programs of adaptation and mitigation of climate change;
- implementation of the strategy of introducing environmentally friendly technologies in manufacturing, energy, transport, etc., including greater use of available renewable energy sources;
- Development of climate monitoring systems and spatial databases, and information on local and regional climate change, including information on climate extreme events and disasters, the vulnerability of certain areas, for their use in strategic planning and spatial development planning;

- the establishment of operational, research and communications and information functions of the National Centre for Climate Change, which performs the functions of Sub-regional center for climate change for South Eastern Europe;
- participation in preparing the implementation of projects under the Sub-regional Framework Action Plan for Adaptation for South East Europe.

For the following period the authors PPRS expect continuous advancement of knowledge, technology and capacity building in the field of climate change in the European integration process, and the acceptance of the general principles and concepts in the plans of lower hierarchical levels.

The Programme of Implementation PPRS from 2010 to 2020 for the period from 2011 to 2015, the number of goals is significantly reduced. They are limited primarily to mitigate the KP. Little attention is devoted to the elaboration of the instruments of implementation, determining the jurisdiction of the various administrative levels (beyond the obvious competence of state institutions), as well as determining the precise action / measures and costs. The implementation of the emphasis on the formation of a database, as well as conducting research in the area of vulnerability and risk, which is certainly an important activity at the state level. However, absent guidelines for policy making activities at different levels, sectoral and cross-sectoral, in relation to the preparation of plans, programs and measures, as well as the ways of their monitoring and audit. This is especially important for Serbia as a developing country, where the challenges are huge KP, actions are urgently needed resources are limited, time is short, the institutional capacity small. Although the RSPP and other strategic documents of sustainability issues, as well as the wider policy framework KP, get a prominent place, there are no clear criteria, measures, legislation that would facilitate job local actors. Local planning, which is in Serbia traditionally formulated as a very complex task, not getting enough from the RSPP of the expected directions, guidelines for reducing vulnerability nor an increase in resistance at the local level. The fact is that there is no program implementation did not provide answers to the open questions.

## **CONCLUSION**

Based on the available data on climate change, their frequency and instability, the amount of gases emitted into the atmosphere from both the industry and the energy sector in Serbia imposes the necessity of immediate and most urgent action in the direction of reducing, and potentially in the near future and complete elimination of broadcaster emissions.

Spatial planning in the theoretical part provides solutions to combat climate change through more segments, prevention of causes that cause pollutants to adaptation to climate change. Spatial planning as a combination of multidisciplinary activities can help in eliminating certain problems in implementation in practice through the integration of legal obligations and choice of the most suitable solutions.

Planning includes tools to identify areas that are at risk, as well as intervention strategies with consequences that last for decades and centuries. As part of planning decisions which created a cycle of dependence: the investment depend on the patterns of

land use and infrastructure in place, which further determine the economic development of certain types and intensity.

In the future, it is necessary to develop a spatial data and information on climate change in a particular area, in order to determine adverse effects of climate change on natural resources. Based System Strategy (related to climate change), which should be done and what will follow the action plan will define the main actors and activities that are necessary in order to adapt to climate change.

## REFERENCES

1. Prostorni plan Republike Srbije od 2010. do 2020.godine ("Sl. Glasnik RS", br.88/10)
2. Strategija prostornog razvoja Republike Srbije, Republička agencija za prostorno planiranje, Beograd, 2009.god
3. Nacionalni akcioni plan za korišćenje obnovljivih izvora energije Republike Srbije („Sl. Glasnik RS”, br.53/13)
4. Prvi izveštaj Republike Srbije prema Okvirnoj konvenciji Ujedinjenih nacija o promeni klime (2010), Poglavlje: Energetika, Ministarstvo životne sredine i prostornog planiranja, Beograd
5. IPCC (2014) - Fifth Assessment Report Intergovernmental Panel on Climate Change: Climate Change Mitigation of climate changes), Jokohama, Japan.
6. Bazik D., Dželebdžić O. (2011). Prilagodavanje klimatskim promenama - nova uloga prostornog planiranja (primer Podunavlja u Srbiji). U: Đokić V., Lazović Z. (ured.) (2011). Uticaj klimatskih promena na planiranje i projektovanje (str.66-84). Univerzitet u Beogradu, Arhitektonski fakultet;
7. COM (2009) 147 final. White Paper – Adapting to Climate Change: Towards a European Framework for Action. Commission of the European Communities;
8. Lazarević Bajec, N. (2012) - „Strategic and Autonomous Climate Change Adaptation Actions and Implications for Transformation of Urban Planning Model in Serbia“. U: Bogdanović, R. (ur.). New Urbanity: Cities vs. Global Challenges. International Symposium on Sustainable Development and Planning, Belgrade, 26–28 April 2012. Strand (Sustainable Urban Society Association), CD-ROM;
9. Pucar M., Nenković-Riznić, M. (2011b) - Uticaj obnovljivih izvora energije na prostorni razvoj naselja u Srbiji u svetlu klimatskih promena, Zbornik radova Društva urbanista Beograda "Budućnost razvoja naselja u svetlu klimatskih promena" 2011, Društvo urbanista Beograda str. 17-27;
10. The World Bank (2010). World Development Report 2010 (WDR10). The International Bank for Reconstruction and Development / The World Bank, Washington, USA;
11. UNECE (2012). Climate Neutral Cities: How to Make Cities Less Energy and Carbon Intensive and More Resilient to Climatic Challenges (April 2012). United Nations, Economic Commission for Europe, New York and Geneva;
12. Füssel, H.-M. (2007). „Adaptation planning for climate change: concepts, assessment approaches, and key lessons“. Sustainability Science, 2 (2), 265–275;



## COMPETENCE OF LOCAL GOVERNMENT IN ENVIRONMENTAL PROTECTION – TOWARDS EU STANDARDS

Dejan Filipovic\*, M. Milincic, M. Pecelj

University of Belgrade, Faculty of Geography,  
Studentski trg 3/III, Belgrade, SERBIA

\**prof.dejanf@gmail.com*

### ABSTRACT

The activities related to environmental protection at a local government level are numerous and challenging. Taking into account that local governments already have considerable powers, they will have even more duties related both to the implementation of a large part of provisions of the laws in the field of environmental protection, and to the monitoring and reporting on the state of the environment at the local level. The role and capacity of the relevant municipal/ city authorities in the field of environmental protection will therefore have to be re-examined. In the process of harmonization with the environmental protection standards of the European Union, local government units in Serbia will face numerous challenges, but with adequate implementation they will nonetheless be in a position to achieve many benefits for themselves and their citizens. Inconsistent implementation of legislation in the field of environmental protection is currently a key drawback at a local level, resulting in several legal and financial obstacles, as well as in the lack of capacity, awareness and political will.

**Key words:** Local government, environment, laws, harmonization, competence.

### INTRODUCTION

In relation to the field of environmental protection, we can conclude that the Republic of Serbia has adopted the most vital strategic documents that regulate environmental policies. The strategic framework consists of the National Sustainable Development Strategy (2008), National Environmental Protection Program (2010), the Spatial Plan of the Republic of Serbia (2010), National Environmental Approximation Strategy (2011), Strategy and Action Plan for the Implementation of Aarhus Convention (2011) and the National Strategy for Sustainable Use of Natural Resources and Goods (2012).

The process of harmonization of our legislation with the EU environmental regulations started in 2004 (by adopting a set of four laws) and continued in 2009 when the so-called package of green laws was adopted (a set of 19 environmental laws). This established the basis for improvement and further regulation of waste management, nature conservation, industrial pollution control, air quality, impact assessment and strategic environmental assessment, chemicals management, waste and packaging

management, ionizing and non-ionizing radiation protection, protection from noise pollution etc. On basis of the adopted laws, more than 70 by-laws were passed, as further harmonization with the EU regulation in this field.

The field of horizontal legislation is regulated by the Law on Environmental Protection, the Law on Strategic Environmental Assessment, the Law on Free Access to Information of Public Importance and by the accompanying by-laws. On basis of expert opinions, a conclusion can be reached that a high level of compliance with the relevant EU regulations has been achieved in the field of horizontal legislation.

In October 2011, the National Environmental Approximation Strategy (*The Official Gazette of the Republic of Serbia*, No. 80/11) was adopted in order to confirm the willingness of our country to conduct negotiations with the EU as efficiently as possible. The above-mentioned strategy contains an overview of economic instruments and financial mechanisms in the field of environmental protection necessary for domestic and foreign investment as well as an overview of the necessity for institutional reform, development of legislation, implementation of regulations at all levels, education and development of public awareness in the field of environmental protection.

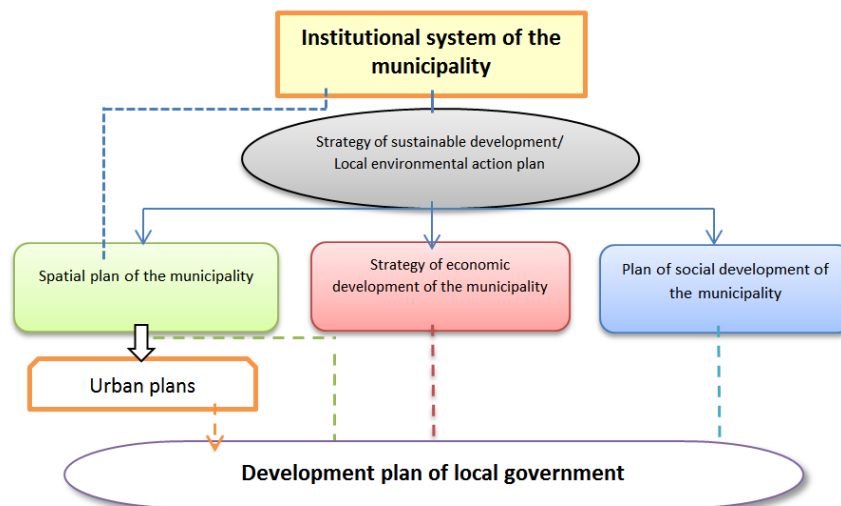
### **LOCAL GOVERNMENT AND ENVIRONMENTAL PROTECTION**

In the system of environmental protection, a local government unit is accountable for each activity that changes or may change the state and conditions of the environment, or for a failure in conducting environmental measures, in compliance with the Law on Environmental Protection.

According to the Law on Local Government from 2007 (*The Official Gazette of the Republic of Serbia*, No. 129/07), local government shall adopt and implement programmes and projects of local economic, social and environmental development and ensure improvement of the general framework for development of the municipality. The above-mentioned law stipulates that the local authority in charge of environmental protection shall “protect the environment, adopt programmes for use and protection of natural values and environmental programmes, i.e. local action and rehabilitation plans, in compliance with the strategic documents and its interests and special features and determine a specific compensation for protection and improvement of the environment”. Each local government unit is accountable for high quality and efficient performance of the primary and later entrusted duties.

A local government regulates and provides the performance and development of communal tasks in compliance with the Law on Public Utilities (*The Official Gazette of the RS*, No. 88/2011). The activities in the field of disposal and treatment of rainwater and waste water, maintenance and municipal waste management, the problem of noise pollution and maintenance of green areas are of special interest in terms of the environment.

Environmental problems, whether at a global or regional level, always have a local element, i.e. are manifested locally. To solve the local environmental problems, there should be appropriate capacities of the local government with clearly defined roles, as well as the appropriate mechanisms of horizontal and vertical coordination.



One of the characteristic problems in local governments is the lack of employed experts who would point out the problems in the environment and conduct appropriate measures for their solving. Various activities (meetings, trainings, workshops and courses) and raising education levels are necessary for the education of as many people as possible whose activities can contribute to better implementation of regulations in this field, and therefore to the quality of the environment at the local level. Furthermore, employment of young and ambitious experts can raise the levels of capacity and thereby of the environment quality of local governments and provide a healthier environment for all citizens.

#### ***Provisions according to the Law on Environmental Protection***

The Law on Environmental Protection (*The Official Gazette of the RS*, No. 135/04, 36/09, 36/09 – other law, 72/09- other law and 43/11- decision CC) is the general normative framework for internal and external system of environmental protection. The law establishes an integral system of environmental protection that guarantees every person the right to live and develop in a healthy environment and a balance between economic development and the environment. The system of environmental protection consists of measures, conditions and instruments for sustainable management of natural values and environmental protection.

A significant part of provisions of the Law refers to local government units. An obligation of local government is to provide the integration of protection and improvement of the environment into all sectoral policies by conducting mutually harmonised plans and programmes through a system of permits, technical and other standards and norms, by financing, incentive and other environmental protection measures. In the above context, planning and development of the municipal area is one of the most important duties of local government, where the environmental protection duties need to be strictly respected.



In the part referring to preventive measures, local government participates in the procedure of preparing and adopting plans (spatial and urban plans) and various other programmes of use and management of natural resources and goods, in accordance with the strategic documents at the republic level.

Local governments, based on the Law, are entrusted with the duties of inspection control over the tasks assigned by this Law, and regulations passed on basis of this law.

A local government unit is entrusted with the following tasks:

- Providing conditions and measures of environmental protection in spatial and urban plans;
- Determining the status of a threatened area and rehabilitation and remediation regime in the area of local importance;
- Developing a contingency plan for accidents within the jurisdiction defined by the law;
- Announcing a threat to the environment within the jurisdiction defined by the law
- Organizing and keeping a local register of polluters;
- Adopting monitoring programmes and providing constant control and monitoring of the environment within the jurisdiction defined by the law and special law;
- Conducting inspection control over tasks assigned by this law and regulations adopted on basis of this law.

In addition to the listed tasks, local government is obliged to provide the Environmental Protection Agency with the quarterly data for a report on the environmental situation in the Republic. Environmental monitoring should be conducted on basis of simple and appropriate indicators that provide feedback on the potential impacts on the environment.

The law includes an obligation of “regular, timely, complete and objective informing of the public on the state of the environment, i.e. on the phenomena checked within the monitoring of levels of pollutants and emissions, as well as the warning measures or pollution that may pose a threat to human life and health”. Therefore the monitoring measures should be in accordance with the special features of the area and the capacity of local government. Local government as the carrier of planning process determines which monitoring measures will be conducted, in what period, in what manner and who will be in charge of that.

Finally, according to Article 83, local government, within its jurisdiction, provides funding and accomplishing the goals of the environment, in accordance with the Law. A local government unit, i.e. two or more local government units can establish a Fund, which will be financed from the revenue generated in its territory.

#### ***Negotiation chapter 27 – environmental protection***

It may be noted that the European Union has developed comprehensive legislation in the context of environment protection as it comprises over 200 legal documents referring to horizontal legislation, quality of air and water, waste

management, nature conservation, industrial pollution control and risk management, chemicals, noise pollution and forestry.

In the context of obligations and conditions that a local government has in terms of the environment, it should be emphasized that, in the pre-accession negotiations with the EU, Chapter 27 that refers to the environment is the most demanding and expensive chapter a candidate country must meet. Chapter 27 is considered the biggest challenge in compliance with the EU as it requires huge funds and major projects, as well as the expertise of the administration. Chapter 27 is interwoven with almost all other sections, and it was one of the biggest challenges to all countries in the process of accession to the EU. One of the key reasons is that the implementation of European standards in the field of environment requires large financial resources.

In 2013, the methodological framework for the Negotiation group 27 was prepared; a detailed analysis of the environmental situation was initiated as well as the preparations for development of software solutions that would facilitate the operation of the Negotiation group 27. The Negotiation group 27 is a basic mechanism for coordinating work of all institutions involved in the field of environment. The rules and procedures of the work of the Negotiation group 27 were adopted in April 2014 and in accordance with the requirements of the preparation process for Screening, sectoral work groups for individual regulations were established.

Towards the end of 2014, the Negotiation group for Chapter 27 presented the environmental situation at the Bilateral Screening in Brussels, in the following areas: horizontal legislation, air quality, waste management, nature conservation, noise prevention, climate change, industrial pollution, chemicals, civil protection and water protection. The principle plans regarding full transposition, further implementation steps, measures to strengthen the capacity and preparation of the planning documents were presented. It is estimated that Serbia will fully transpose the applicable legislation of the European Union by the end of 2018.

Certain analyses show that the current financial and administrative capacities are not sufficient for a full and detailed implementation of European legislation. The approximation costs in the area of the environment that include investment, operational and administrative costs are estimated at about 11 billion euros over a period of twenty years. The largest part of the investment is expected in water and waste sectors because the Directive on Landfills and Directive on Urban Water Treatment are considered as the most challenging and expensive and require the public sector costs. With the aim of successful implementation of the EU legal system, such as the Chapter 27 on the environment, and in order to reach the European environmental standards in the field of environment, local government units will have to improve their administrative capacities and to be able to provide significant financial resources.

In 2015, a Post-screening document was prepared and it contained additional information (the status and plans for the transposition and implementation) on the implementation aspects of the EU environmental regulations. The document was developed within the Negotiation group 27 and it presents the overview of aims in the environment field, institutional framework, the situation overview by sectors and approximation plans, estimation costs and financing the implementation, as well as the

progress in transposition. The post-screening document shows the status and plans of transposition and implementation of the EU acquis in Chapter 27.

### CONCLUSION

As a final point, we can underline that local governments already have considerable powers, and will have even more duties in the future related both to the implementation of a large part of regulations in the field of environment and to monitoring and reporting on the environmental status. According to some reports, a large part of the EU directives referring to the so-called horizontal sector, nature conservation, chemicals management and noise protection are fully or almost fully transposed into the national legislation. In other areas (air quality, waste management, water protection, industrial pollution control), the largest part of EU regulations has been transposed into the national legislation, but not completely.

Having reviewed the situation at the local level, it is obvious that local authorities will require significant support both in financial resources and in capacity building for the full implementation of law in the field of environment and for reaching the EU standards. A timely preparation of local governments is vital for the inclusion in the accession process on an equal, partnership grounds. Due to the above-mentioned, it is necessary to prepare the Action Plan for development of institutional capacity to implement regulations from the Chapter 27, i.e. to acquaint local government with the duties and powers arising from the legislation.

### REFERENCES

1. The Law on Environmental Protection (*The Official Gazette of the RS*, No. 135/04, 36/09, 72/09 and 43/11)
2. The Law on Local Government (*The Official Gazette of the RS*, No.129/07)
3. Nacionalni Konvent o Evropskoj uniji – radna grupa Životna sredina (analiza i preporuke), Evropski pokret u Srbiji, 2014.godina
4. Post skrining dokument "Životna sredina i klimatske promene", Ministarstvo poljoprivrede i zaštite životne sredine, 2015.godina
5. Grupa autora: Istraživački forum "Unapređenje kapaciteta jedinica lokalne samouprave, organizacija civilnog društva i privrednih subjekata za sprovođenje evropskih standarda u oblasti životne sredine", Evropski pokret u Srbiji, 2012.godina
6. Grupa autora: Stanje zaštite životne sredine na lokalnom nivou u Srbiji, Stalna konferencija gradova i opština, 2014.godina
7. Lokalne samouprave i pristupni pregovori, Fondacija Centar za demokratiju, 2015.godina
8. Priručnik za odnose sa javnošću "Približimo evropske integracije, zaštitu životne sredine, rodnu ravnopravnost i poslovno okruženje građanima", Stalna konferencija gradova i opština, 2015.godina
9. [www.sepa.gov.rs](http://www.sepa.gov.rs)
10. [www.pregovarackagrupa27.gov.rs](http://www.pregovarackagrupa27.gov.rs)
11. [www.mpzss.gov.rs](http://www.mpzss.gov.rs)



## EDUCATION FOR INOVATIONS AGAINST REBUILDING LANDSLIDES<sup>®2</sup>

Mirjana Marinkovic\*, Lj. Ilic

SERBIA

\*marinkovicmirjana00@gmail.com

### RESUME

Staff training conducted within the CARDS program is organized by JUPIN and based on the patent protected innovations by three patents made by PHD Ilic, and those are: 1. Increasing of the capacity of the building foundation, 2. Prevention from land-slide sites occurrence, and 3. Damp salvage by the noninvasive method, known as the common name "Kolubara method". The training is envisaged as the staff training at endangered municipalities in Serbia like: Belgrade, Niš, Novi Sad, Kraljevo, Čačak, Smederevo, and Novi Pazar, would be recovered by Kolubara Method.

### ABSTRACT

Education and training of personnel for the implementation in CARDS project in organisation of JUPIN of the innovative method of dr Ilic: (1) Prevention of foundations subsidence, (2) Remediation of landslides applying a non-invasive method, (3) The training of personnel for the implementation of the "Colubara Method" shall be organized in Belgrade including another seven regional centres in Serbia (Beograd, Niš, Novi Sad, Kraljevo, Čačak, Smederevo, and Novi Pazar). Damp-proofing of walls applying the method known and protected by the name of "Colubara Method".

**Key words** : To discover, Patent, Invention, Innovation, preventive, Rebuilding Landslides, KOLUBARA METHOD, education, training.

### INTRODUCTION

The aim of the writing this paper work is educating the scientific public about the modern trend of the developed society, related to one of the components, that is, the intellectual property and its influence on the contemporary science in this case fight against elementary disasters-landslide sites. Societies as European Union, USA, Japan, and such as we hope to become soon, realized that on time-20 years ago and the results of the intellectual property-innovations in great measure are used in the applied science. The

---

<sup>2</sup>Important notice!

This work is a confidential document, that contains patent protected solutions which cannot be copied, scanned, printed out of the complete paper works without written authorization of the Author  
Author Professor PHD Ljubinko Ilić

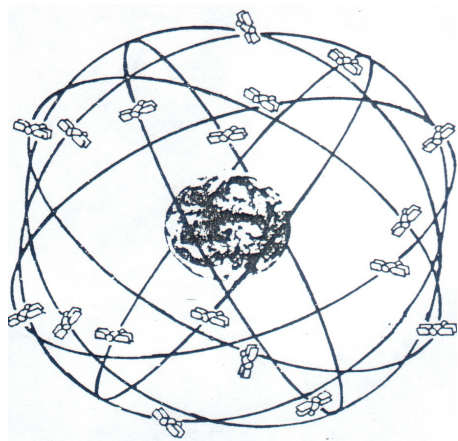
interest of the society is that the using of innovationa be optimum, for the ingenious inventions of which nobody knows except the inventor, has no value for the society! Care of the interest is one of the most important task of the state.

KOLUBARA METHOD (KM) is a seal-brand (ordinal no.50585), and is consisted of three patent and applied methods-innovations, and those are : 1. Landslide recovery by the noninvasive method (no. 49522), 2.The method of the noninvasive foundation drainage (no. 49525), 3. The method of soil capacity increase (бп. 40634).

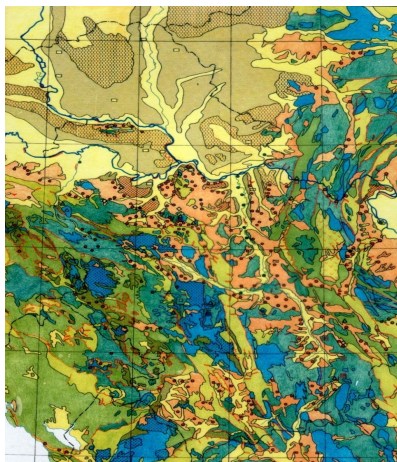
The important feature of the Patent is that all three patented methods are compatible, which means, they are conducted with the same equipement and when needed performed simultaneously, and the recovery can be started again, which means there is no waiting for the landslide to be sedated so that the recovery works could start as with the classical methods!

### **THE AIM OF THE WORK**

The aim of the work is to introduce the usage and advantage of the innovations in applied sciences and the contractor projects in all fields of techniques and technologies to the public. In this case there will be words on the fight against elementary disasters as land-slide sites. Recovery of the land-slide sites by modern patented technologies like the mentioned KM is possible with the interactive participation of the interested parties (endangered people and institutions by land-slides) with the previous education,training, stuff education towards the CARDS program of the European Union , and by the Author of the patented KM. Because of the increase of the noticed occurrences of the volcanoes,earthquakes, tsunamies and landslides, the last decade (1990 – 2000 . )is proclaimed by the UN ,that is UNESKO—as a decade of the fight against the elementary disasters, which passed unnoticed because of the recovery at the time being, and as a society we were not prepared enough. However because of the number of increase and intensity of the landslides because of the global issues mentioned above, and that is a team work on the education of the staff in individual municipalities endangered by the lanslides, in a way a network of of recovery could be covered to some extent of some endangered municipalities.In order to do the rebuilding well, certain adequate information is needed which is available through GPS and geology documentation, which is shown in the pictures no.1 and no. 2.



**Figure 1.** Satellite constellation GPS – SATAM



**Figure 2.** Geological map with the landslide sites in Serbia

It is much cheaper and more efficient to prevent the land-slide sites than to rebuild them, so prevention. The main measure of the prevention is eliminating of the factors of the landslide occurrence which is the uncontrolled inflow of water, deforestation which are one of the main factors of landslides occurrence, one should pay a special attention to dewatering of the terrain inclined to this phenomenon. With that aim, in urban surroundings one must take care of the building of the adequate sewage system. Septic tank and bad sewage, destabilize the terrain. There where it is possible one should plant a vegetation that has a big capability of the absorption of the extra damp from the soil (eg. poplar-tree), like the adequate kinds of grass. Forests have the capability to stabilize the soil with transpiration of damp and its roots. However, vegetation is not of great help with the big landslides, for land-slide site sliding surface can be at the depth bigger than the depth of roots. Then the whole forests starts moving. Landslides in forests are followed by the crooked trees and that phenomenon is called "drunk forest". When the landslide moves in some cases it is not possible to perform the recovery until the landslides are stopped. (That is the case in Bogdanje, beside Trstenik) Because of the landslide of the length around 2 km, the whole settlement had to be displaced). In the fight against the land-slide site, digging is performed mostly, pillars are driven in, the bearing walls are built and the drainage is performed (dewatering) of the terrain.

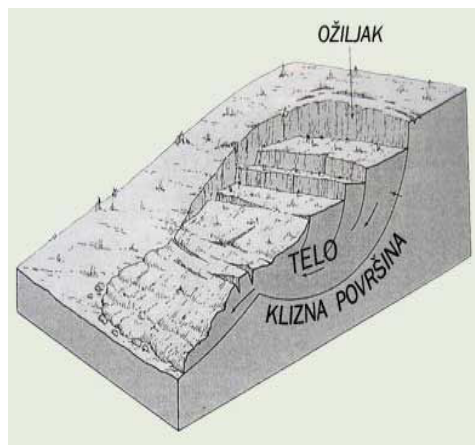


Figure 3. Landslide mechanism



Figure 4. Recovered landslide KM in Vranic

The application of the modern methods of the stabilization demands the optimum choice of the entering data starting with the geomechanic parameters, statistic analysis, reduction of geomechanic parameters, methods of stability methods, measuring of the deformities on the terrain. The very word rebuilding or sanacija (Serbian) is of the latin origin «sanare», which means remedy and is used in medicine, in technique it is incorrectly interpreted and our Serbian word is more correct stabilizacija (english: stabilisation; repair; rebuilding; remediation), for it has a wider sense for the leading the unstable terrain that is landslide in the stable state. With the special methods as Kolubara Method, the word stabilization of the landslide is logic to some extent, for by the ionic change in the treated soil on which the KM is based, the reason of the instability is eliminated.

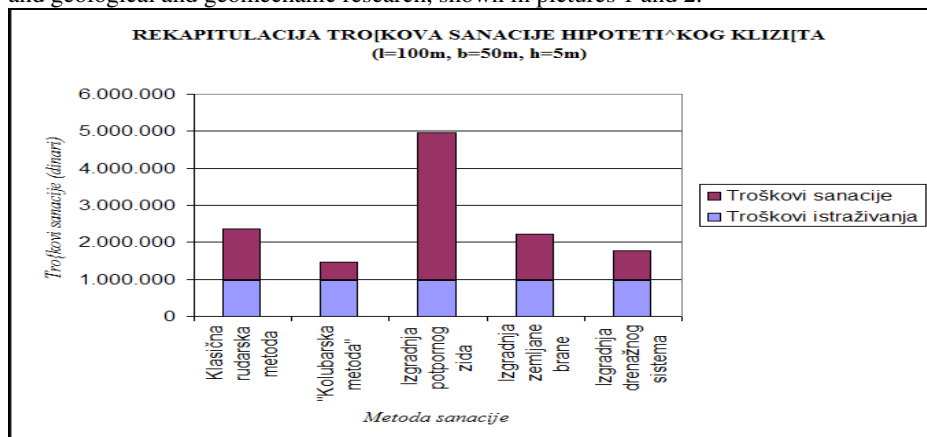
Serbia is endangered because of its geological composition of soil by the instability of the terrain: by land-slides sites, erosion, mudslides, as well as the possible earthquakes of the limited intensity.

In Belgrade at Banjica it killed 30 people. Beside the human victims material damage caused by the demolishing of buildings, roads and mines. In 1954. The river bed of Velika Rzava is reconstructed land-slide site and formed artificial lake of the dimensions 550 m x 50 m with 60 000 m<sup>3</sup> of water mass. In 1956 in Macedonia from the mountain Gradot on the right side of the river Vataša at Kavadarac it moved the mass and trapped the valley of the little river at length of 800 m, with 70 m of the thick cover, when 11 shepards were killed. In 1963 during the sudden melting of the snow in the river Visočica basin, on the right from Nišava bank the old land-slide site was activated on the southern foothill of Stara planina. Around 1,7 m<sup>3</sup> of the soil and rock fell into the canyon of this river and formed a lake 7,2km long. In 1975 a great land-slide site appeared in the coal mine Kosovo- Belačevac, when the mass of 9 million m<sup>3</sup> was moved during which 3 millions of tons burnt. In 1993 700 000 m<sup>3</sup> of soil mass was moved and coal in the Kolubara mine. Unfortunately many active, passive and sedated

land-slide sites are situated on the surface of Belgrade, I feel it as a citizen of our Capital as a duty with the aim of the education of my co-citizens to try to explain shortly these manifestations. Apart from its beauty which is given by the Danube and Sava and the ruffled terrain Belgrade has the another, more dangerous side, and that is, land-slide sites. So, south from Sava and the Danube on the surface of 211 Km<sup>2</sup> half is stable ( 104 km<sup>2</sup> or 49 % ) , while conditionally 65 km<sup>2</sup> ( 31%) of the surface and unstable 42 km<sup>2</sup> ( 20%) of the surface. In other words, out of 360000 of land-slide sites as many there are in Serbia 700 land-slide sites falls on the surface over 6000 ha. Geologically observed the area of Belgrade is built out of neogene sediments which are represented by : conglomerates, sandstones , limestone, marls and clay saturated by water. Through the neogene sediments the quaternary sediments are piled made of river-lake sediments which consist of pebble, sand, clay. In them at the depth of 1-3 m the level of underground water is formed which is in hydraulic connection with Sava and Danube. Land-slide sites are present worldwide, out of which I will mention only some outstanding examples, in 1996 heavy torrents provoked the deadly avalanche of mud and rocks in the north of Spain in the Pirineas and caused the death of 80 people, and it hurt 200 people in 1964.

### FREQUENTLY ASKED QUESTIONS

Frequently asked questions consider the staff training by the new technologies of the prevention and rebuilding of the land-slide site in the endangered municipalities and within the municipality organization. When the rebuilding of the land-slide site is considered , safety, that is prevention, efficiency, the time of the beginning and the duration of the rebuilding and the price ,is very important in the timely training that is staff training within the municipality organization. Namely in the developed countries emphasis is put on the prevention which is more efficient, cheaper and safer! Out of that reason data and results got by the satellite measurement are very important through GPS and geological and geomechanic research, shown in pictures 1 and 2.



**Figure 5.** comparable display of the prices of the inual recovery land-slide site rebuilding with the Kolubara Method.



Great number of land-slide sites in World and here ,which is displayed in the previous chapter, demand the adequate, extensive and good intervention, which can be achieved by the systematic staff training with the municipalities endangered by land-slide sites! Before each intervention an adequate analysis of the land-slide sites is needed, that is unstable zone, so the optimum choice of method of the rebuilding displayed and shown through the adequate project. It is the case with the pictures 6. 7. 8. Displayed practical training of the engineering staff of the Electric Network of Serbia (EMS) by the Author of the Kolubara method (KM) by professor Ilić, who gave the license of the rebuilding to EMS. In the picture the key activities of the training-rebuilding of the land-slide by the given license of the land-slide rebuilding of the author Ilic, as the theoretical knowledge is necessary, driving the electrodes in the land-slide sites that endangered (leaned) the transmission line pillar, connecting electrodes.

After driving the electrodes in the connection to a certain apparatus is executed,through which the ionic exchange between the electrodes and land-slide sites by the Kolubara method. Further training of the land-slide site Kolubara according to CARDS program of the staff training, expanding of training to the cities and municipalities endangered by the land-slide sites like the cities sated in the resume of this paper : Belgrade, Niš, Novi Sad, Kraljevo, Čačak, Smederevo, Novi Pazar, Lazarevac.

## **CONCLUSION**

In the paper theoretical premises are displayed, like the practically performed education of staff and modern methods, as Kolubara Method(KM) on the land-slide rebuildingc. Kolubara Method (KM) contains in itself three patented methods, and depending on the issues, the correct method is chosen. Practical examples of the successful application of Kolubara Method on the rebuilding of the land-slide sites and with it environment protection in civil engineering, mining and electricity are proved. In this case by the innovation mentioned above KOLUBARA METHOD in 2008 a team is formed MNERS OF KOLUBARA, which beside many world awards likehe Order of the Knight of the Kingdom of Belgium then Golden Archimedes from Moscow , Golden Tesla from Belgrade, Great award of the USA from Pitsburg and many other and the last is the first place and the golden medal on the contest of the best tecnological innovations in 2008.After receiving of the Golden Eureka, the public obtained the trust so after that many objects and land-slide sites public got the trust so after that many objects and land-slide sites were rebuilt successfully by KOLUBARA METHOD, among which the hometown house of Milutina Milankovića and Patriarchal Palace in Dalj, which ere financed by the government of the Republic of Serbia through the Ministry of Science of the Republic of Serbia, won on the competition for the best technological innovation in 2008 (**NTI-08**), from the Government of the Republic of Serbia is listed in its program of presentation on the World fair in Shanghai**EKSP0-2010**

Patented method of the recovery of the land-slide by noninvasive method is comparing to the classical methods faster, mobile and ecological, and for performing simpler, so that the fast and efficient staff training is possible,that can work

independently and successfully work as a team on the land-slide rebuilding by the licence and monitored by the Author professor Ilic.

### MEASURE PROPOSAL

With the aim of the problem defining it is needed to define the necessary parameters for the application of the energetic method, by which the ionic change is performed by the effects of electro-osmosis and electrophoresis. As stated belongs to the energetic methods, because the electric energy with its effects of the ionic change which brings the internal change of the structure of substance, in this case geological layer, and increasing of its hardness. For the successful application, which needs the adequate terrain and laboratory examination, by which a certain increase of the parameters of the hardness that provides the stabilization-recovery of land-slide site. The research itself is preconditioned by the type of object which is being recovered that is the fields like: mining, civil engineering, military technique, chemical industry, medicine, etc. In this paper the needed research relate to the field of civil engineering, mining that is mining and construction objects in the mine, which are land-slide sites, sedated land-slide sites and potential land-slide site, that is old construction objects as churches and monasteries, museums and all old buildings without hydroisolation which are as such affected by rising damp.

First researches are executed in 1979-1980 in INKOS in the shape of the one-year scientific-research project which was financed by the provincial community of Kosovo for the scientific work. The results which we achieved indicated the possibility of the recovery of the unstable zones made of clay material whose water permeability is  $K \geq 10^{-8}$  cm/sec. The research is related to the possibility of the application of electro-osmosis, and within the mentioned scientific-research project as well as making a study, is continued at Imperial College in London with professor Bishop, when all issues are made clear, so one reached a clear conclusion that the application of electroosmosis in stabilization of land-slide site is possible!

Later on the researches were continued in Kolubara coal basin with the application of electroosmosis in mining and civil engineering. The mentioned researches are executed in laboratory, geomechanic laboratory in Rudovci, as well as the terrain on the open-pit D. Similar issues are in mining related to the instability of the floors, when we have the consequence of increase of humidity, increase of porepressures  $r_u$ , which affect negatively the stability of the slope. Additional researches in the mentioned Kolubara geomechanic laboratory in Rudovci on the application of the method of increase of hardness gave the positive results. Received results indicated that the justifiability of the application of the application of electroosmosis after which one took over the work on the terrain. Practical application of electroosmosis in mining that is open-pit exploitation is possible in the zone of the end slopes, on the locations where because of the built objects the change of the slope geometry is not possible. By the application of Kolubara method a double effect is achieved without the change of floor geometry, permanent increase of hardness and reduction of coefficient of the pore pressure " $r_u$ " and what influences further increase of stability of the slope cohesion  $c$  and the angle of the internal friction  $\phi$  as well as the coefficient of the pore pressure  $r_u$

which interactively and iteratively given the stability  $F_p$  that accords with the hardness  $\tau_p$  that is their components  $c_p$  and  $\phi_p$  the treatment is performed on the endangered slope. It is important to mention that the development of the procedure became with the development of the information technologies, which led to the reduction of the calculation time, so it was possible for the researchers to dedicate themselves to the creative thinking and solution of the problem. In the described way it is possible with the adequate equipment and timely manner to get the needed increase of the hardness of the material  $\tau_p$  in the mass of the critical slope. After the final researches, the method is patented, and the world awards were received.

#### REFERENCES

1. Hisamitsu A. Intellectual Property Policies For the Twenty-First Century :The Japanese
2. EUROCODE 7: Geotechnical design, Part 3, Design assisted by field testing DN 237, 1997. Experience in Wealth Creation, WIPO, 1999.
3. Ilić Lj. : Kolubarska Metoda, Beograd, 2006.g.-Kolubara method, Belgrade, 2006
4. Ilić Lj. : Geomehanika na površinskim kopovima, Beograd, 1991.g., monografija Geomechanics on the open-pit, Belgrade, 1991, monography
5. Ilić Lj. Ilić M. Upravljanje geomehničkim procesima u rudarstvu, Beograd, 2015.g, monografija Managing the geomechanic processes in mining, Belgrade, 2015, monography
6. Ilić Lj. : Kolubarska metoda P- 692/00, patentirani postupak sanacije klizišta Kolubara method P-692/00, patented procedure of the land-slide site reco
7. Ilić Lj.: Computers application for slope stability analysis, Prague 1997 y. VI-th
8. Marinković M. Značaj SKAIN-a u borbi protiv prirodnih nepogoda, 6.SINOVIS, uvodno predavanje, Ilić Lj, Beograd, 2015.g.



## COMPARATIVE REVIEW OF THE INOVATION STRATEGIES FOR THE E-WASTE MANAGEMENT

Nada Strbac<sup>1\*</sup>, A. Mitovski<sup>1</sup>, D. Zivkovic<sup>1</sup>,  
M. Sokic<sup>2</sup>, Lj. Balanovic<sup>1</sup>, V. Grekulovic<sup>1</sup>

<sup>1</sup>University of Belgrade, Technical Faculty in Bor, SERBIA

<sup>2</sup>ITNMS, Frans d'Epere Boulevard, Belgrade, SERBIA

\**nstrbac@tf.bor.ac.rs*

### ABSTRACT

When considering possible solutions for economy and improvements in cost of labor, both in the world and in Serbia, unavoidable topics are formulation of a strategy for waste management, collection and waste classification and the usage of secondary raw materials in primary production. Recognizing that the problem of recycling and secondary raw materials usage in the industry are of a great importance from an economical and especially from an environmental aspects, this topic lately took great attention of socio-political organizations at the highest level.

The focus of this review paper is on the present time, in which modern man is totally dependent on electrical and electronic equipment, which will become E-waste at the end of life cycle of a product. For the control and management of this kind of waste, innovation strategies have been used, related to processing technology, which is being influenced by numerous factors. One of the main factors that create the conditions for the application of advanced strategies and technologies of recycling is the status of the country (whether it is a technologically highly developed country or a developing country). In regard to this, the paper aims to present some experience, knowledge and practice of the E-waste treatment in countries with different economic status.

**Key words:** E-waste, collection, models, WEEE, ecosystem.

### INTRODUCTION

Since the 1980s, with the development of consumer-oriented electrical and electronic devices, countless units of electronic equipment were sold to customers. However, each of these products has got its own life, where at the end of a life-cycle becomes an electronic or electrical waste (E-waste). E-waste is a serious problem both locally and globally. At first it appeared as a problem in developed countries, but later expanded to other developing countries. Therefore, the need to find the right solution for the E-waste management emerged, in terms of creating a form of single global, feasible, sustainable and innovation strategy. For now, one of the strategies caled extended producer responsibility (EPR) of the „polluter pays“ may not be perfect, but it is surely the best policy and the way to solve the burning problem of E-waste.

The basic premise of every society should be related to the fact that working with waste can be fertile and is underrated industrial sector. Knowledge about a material opens the way to new ideas and possibilities. Proper waste management has to be accepted by society as a responsible economic, economic and social task whose execution must include a wider range of participants. The first success is understanding of the character, the determination of tasks and involvement of political forces and social communities in the efficient use of waste. Society measures have to stimulate scientific research and educational organizations. By educational work, programs and activities of socio-political organizations in spreading the knowledge that the waste is useful, should reach every citizen. The wider society should be informed that waste is usable raw material, common good and that the basic social obligation is its collection, the prevention of interference with other waste, handing over to an organized place to which means protection against deterioration and degradation of quality properties that the waste possesses. [1]

In the last twenty years, the developed countries have established various control mechanisms for the management of waste materials, with priority given to the strategy to prevent the creation of waste. In doing so, in preventing preferred recycling, which is better than incineration, while the landfill is the least desirable way of managing EE waste. However, due to the manner of functioning of the existing system of waste collection, almost 90% of electronic waste ends up in landfills or in waste incineration plants.

#### ***EE waste incineration***

Even small amounts of E-waste which enter the incineration process result in high concentrations of metals, including heavy metals in gaseous products or solid product deposits on filters in the incineration plants. It is estimated that the emissions resulting from the incineration of EU annually amounted to 36 t of mercury 16 t of cadmium in 2000. In electronic and electric waste there is a significant amount of PVC which is not suitable for incineration due to toxicity of their products.

#### ***Disposal of E-waste in landfills***

This method of E-waste treatment represents the least desirable solution and brings a special risk, since any type of land is not completely impermeable. Dangerous substances may leak in the soil and ground water: mercury from circuit boards, PCBs from capacitors and cadmium from certain plastics. Significant amounts of lead can be dissolved from the glass of CRT monitors, entering the groundwater which contain various acids and are found in the landfills. A particular problems can be mercury evaporation and uncontrolled fires that can increase the emission of highly toxic dioxins and furans due to presence of wide range of hazardous materials in the landfills. [2]

There is a proposal that instead of dismantling the old electronic equipment can be disposed in open pits of abandoned mines, from which copper, gold, iron, glass and plastic could be recovered. Computers and other electronic equipment have more copper from the copper ore used for the primary copper production (for example, for 1t of copper cathodes more than 20 t of copper ore is needed). [3]

## **E-WASTE COLLECTION MODELS**

Hereinafter will be listed current models of waste collection which are used in a number of countries. These are usually collection models of solid waste, hazardous substances and E-waste in the municipality or county where each model carries a certain positive or negative aspects.

### ***Model 1 - Drop-off event (Waste collection through occasional campaign)***

Waste collection through occasional campaign is a model in which individual residents bring their E-waste in a special location provided for in the context of this action (the municipal buildings, schools, etc.). These actions are mainly implemented in cooperation with NGOs, primary and secondary schools, operators and recyclers. Activities include bringing the E-waste to the collection site, unloading from vehicles, sorting and packaging waste, then transport to the final operators. If these activities are carried out without direct cooperation with the final operator, the collected E-waste can be a problem, because, as such, it represents a generator of environmental pollution.

Collection of E-waste under this model is very much present. Often in the media informations can be found on implemented actions, in which the most frequently several tons of E-waste can be collected. However, on annual basis of these actions, is very little that this model has contributed to significant reduction of E-waste in households. The significance of these actions is reflected primarily in informing the citizens about the necessity of organized E-waste collecting, especially young people. During these actions special containers are placed in the appropriate places where citizens in the course of a few days can dispose their E-waste.

### ***Model 2 – Permanent collection facility (Recycling or collection centres)***

Recycling centers and companies for collecting E-waste have adequate working time when people can bring their waste. These objects can be part of other utilities, such as centers for recycling and sorting waste, landfills or facilities for hazardous substances. E-waste is solid waste, large in size and volume, requires a large space for unloading, sorting and storage. Existing facilities for processing and selection of municipal solid waste often do not correspond to the need of a large space in a small period of time and do not meet all the necessary conditions for the storage of hazardous waste.

### ***Model 3 - Bulky waste collection programs (Solid waste collection programs)***

Programs for E-waste collection that exist in some urban areas where actions of solid bulky waste collection are carried out. This is mostly done during the spring cleaning actions, the planned waste collection and collection of waste from illegal landfills. According to the present model, E-waste is collected together with other bulky solid waste. The collected E-waste is transported to a central place where is separated from other solid waste. These actions have to be carried out in cooperation with end operators (recyclers).

#### **Model 4 – Retail collection (Collection in the retail objects)**

Retail stores can provide residents and businesses to bring certain kinds of E-waste. This type of partnership is suitable for companies engaged in retailing of electrical and electronic products. Some companies give discounts for the purchase of new products if they bring an old one. The system "old for new" has so far proved to be a possibly effective way of collecting obsolete electronic and electrical products from households. A number of operators in cooperation with companies involved in trade, carry out taking old devices when purchasing new, where there is a price list for submitted obsolete devices.

Although in Serbia there are positive examples, traders still do not use this feature to a satisfactory extent. Deadlock application of this model to collect E-waste is created due to the low efficiency and speed of refund from the Fund for Environmental Protection operators. Substantiation the right to a voucher, a discount on the purchase of new products or money, can be achieved only if the units were handed over in good, complete condition. In these actions, traders perform transport of old equipment to their warehouse for the reception. Using the model of E-waste collection on a "new for old" should become the rule rather than the exception. An example of a successful campaign started this type are actions in Serbia realized the company "Tehnomanija", "Tehnomarket", "Samsung" and "Set Recycling". In addition, positive examples are computer equipment shops that offer the ability to purchase or replacement of old computer devices ( "Laptop servis " PC Diskont " Belgrade, etc.). [4]

#### **E-WASTE TREATMENT IN THE DEVELOPED COUNTRIES**

Developed countries are technically advanced countries which have significantly developed its own industrial production and wide international cooperation. On this matter, the focus is on the question of how these countries have developed regarding the treatment of E-waste, if they have innovative strategies and technologies that are used in this regard.

In developed countries, there are conventions, directives and laws governing the management of E-waste, mainly focused on extended producer responsibility. In fact, manufacturers are obliged to return the collected E-waste by retailers and local governments, as well as to safely destroyed or recycled materials to make E-waste. [5]

However, high costs for the proper collection, disposal and recycling of lead to the delivery of large quantities of electronic waste to China, India, Pakistan, Nigeria and other developing countries. Faster growth of E-waste in developing countries compared to developed countries, suggests an expansion of an expanded, cheaper and more informal way of processing, efficient in a certain way, but on the environmental aspects and very dangerous.

When we talk about waste with hazardous contents, which require special treatment, but could not be simply thrown in a landfill, it was a simple solution that is tantamount to being loaded on ships and trains and transported outside the borders of developed countries, countries in development.

Table 1 shows the leading manufacturers and the largest importers of E-waste, according to 2010 estimations. [6]

**Table 1.** The leading manufacturers and the largest E-waste importers

Country or region	From households	Landfills and incineration plants	Recovery by country	Exported	Imported
	milion tons				
USA	8,4	5,7	0,42	2,3	/
EU	8,9	1,4	5,9	1,6	/
Japan	4,0	0,6	2,8	0,59	/
China	5,7	4,1	4,2	/	2,6
India	0,66	0,95	0,68,	/	0,97
West Africa	0,07	0,47	0,21	/	0,61

Initiatives in the developed countries for E-waste treatment can be listed as follows:

1 – **Basel Convention** - The most important of the initiatives directed towards E-waste. It is based on the control of trans-border movement of hazardous wastes and their disposal.

2 – **WEEE Directive** - The EU directive, which has existed since 2003, and has been adopted by all EU member states in 2007. [7, 8]

Directive covers all types of electrical and electronic equipment sorted into 10 categories, and sets targets for its collection, treatment and recycling. [9]

3 – **3R** – Slogan “Reduce, reuse, recycle“ represents the initiative firstly presented by Japan at the G8 Summit in 2004. Japan has promoted this program first in his country and later at the international level. Term Reduce primarily means to prevent the creation of large amounts of E-waste, which is the first priority. The objectives of this initiative are improvements of the technologies for reuse, cooperation with developing countries on recycling and reuse of E-waste, as well as removing barriers to the international movement of materials intended for recycling.

4 - **USA legislative** - Although Congress of USA has not yet ratified the Basel Convention, a number of states within the USA have adopted laws that deal with E-waste. However, these state laws do not restrict the international movement of electronic waste.

### E-WASTE TREATMENT IN THE DEVELOPING COUNTRIES

Developing countries have relatively low living standard, underdeveloped industries and medium or low human development index. These countries are characterized by low income per capita, widespread poverty and low income from capital. Developing countries are faced with major challenges in the management of electronic waste, which is either internally generated or imported legally / illegally. Due to lack of proper infrastructure and outdated techniques and technologies for the E-waste management and its treatment in developing countries is usually not safe. [10]



It is well known that companies from developed countries use the absence or poor enforcement of environmental protection in developing countries, leaving traces that destroy the environment. This is unjust and environmentally detrimental to the ecosystems of the developing countries. Exports of electrical and electronic waste in developing countries are exposed to those countries at risk of hazardous wastes and toxins, forcing them to choose between "poverty and poison." [11, 12]

This occurs as a consequence of the fact that developing countries do not use the appropriate technology for waste management. As an example China can be mentioned, where the majority of E-waste recycling is carried out in their yards or in small workshops that use crude methods of waste treatment [13]. This scenario can only be regulated by law, and as an example can be taken of EU Directive (WEEE Directive), which is widely known, however, its application in developing countries is very slow. [14]

## CONCLUSIONS

E-waste is a serious problem locally and globally. E-waste problems appeared initially in developed countries and now extended widely to other countries around the world. The volume of E-waste is rapidly growing because consumer technology is changing fastly and the innovation of technology results in rapid obsolescence and, further, generating massive amounts of E-waste. E-waste consists of many different materials, some of which contain a variety of toxic substances that can contaminate the environment and threaten human health, if the end-of-life management is not meticulously managed.

In order to mitigate E-waste problems, there are investigations in term of the volume, nature and potential environmental and human health impacts of E-waste and extensive research into E-waste management. Several tools including LCA, MFA, MCA and EPR approach for E-waste management could ultimately ameliorate most E-waste problems. Any one tool may be imperfect but in concern they can complement each other to solve these issues. Moreover, a national scheme such as EPR is a good policy tool to solve the growing E-waste problem. Interaction of four tools can drive to success for E-waste management that is to develop eco-designed devices, to properly collect E-waste, recover and recycle material by safe methods, E-waste disposal by suitable techniques, forbid the transfer of used electronic devices to developing countries, raising awareness of the impact of E-waste pollution of both users and manufacturers. Over and above all of these, no matter how well the policies are introduced and implemented, benefits will only arise if the provided end users are prepared to accept introduced policies and adhere to them.

## *Acknowledgement*

*The authors are grateful to the Ministry of Education, Science and Technological Development (the paper is done under the frame of the projects No. TR 34023 and ON 172037).*

## REFERENCES

1. M. Janković, Secondary raw materials in the function of the economical development of Yugoslavia, INOT, Belgrade, 1987. (*in Serbian*)
2. J.M. Czuczwa, R.A. Hites, Environmental fate of combustion-generated polychlorinated dioxins and furans, *Environmental Science & Technology*, 18 (1984), 444–450.
3. H-Y. Kang, J.M. Schoenung, Electronic waste recycling: A review of US infrastructure and technology options, *Resources, Conservation and Recycling*, 45 (2005), 368-400.
4. B. Nedić, Models for E-waste collection, FQ 2012-Festival of Quality, Proceedings, 2012, A330-A334. (*in Serbian*)
5. S. Sthiannopkao, M.H. Wong, Handling E-waste in developed and developing countries: Initiatives, practices and consequences, *Science of the Total Environment*, 463-464 (2012), 1147-1153.
6. B.C.J. Zoeteman, H.R. Krikke, J. Venselaar, Handling WEEE waste flows: on the effectiveness of producer responsibility in a globalizing world, *Int. J Adv Manuf Technol*, 47 (2010), 415-436.
7. EU, 2002. Directive 2002/96/EC of the European parliament and of the council of 27 January 2003 on waste electrical and electronic equipment (WEEE). In: *Official Journal of the European Union* (Ed.), L037:0024-39.
8. EU, 2011. Directive 2011/65/EU of the European parliament and of the council of 8 June 2011 on the restriction of the use of certain hazardous substances in electrical and electronic equipment. In: *Official Journal of the European Union* (Ed.), pp. L174/88–L174/110.
9. Y. Barba-Gutiérrez, B. Adenso-Díaz, M. Hopp, An analysis of some environmental consequences of European electrical and electronic waste regulation, *Resources, Conservation and Recycling*, 52 (2008), 481–495.
10. I.C. Nnoroma, O. Osibanjo, Overview of electronic waste (E-waste) management practices and legislations and their poor applications in the developing countries, *Resources, Conservation and Recycling*, 52 (2008), 843-858.
11. T. Cooper, Slower consumption: Reflections on product life spans and the "throwaway society", *J Ind Ecol*, 9 (1/2)(2005), 51-67.
12. M.H. Wong, S.C. Wu, W.J. Deng, X.Z. Yu, Q. Luo, A.O.W. Leung, C.S.C. Wong, W.J. Luksemburg, A.S. Wong, Export of toxic chemicals – a review of the case of uncontrolled electronic-waste recycling, *Environmental Pollution*, 149 (2007), 131–140.
13. K. Brigden, I. Labunska, D. Santillo, M. Allsopp, Recycling of Electronic Wastes in China and India: Workplace and Environmental Contamination, Greenpeace Research Laboratories, Department of Biological Sciences, University of Exeter, Amsterdam, Natherlands (2005), 12.
14. J. Puckett, T. Smith (Eds.), BAN/SVTC (Basel Action Network/Silicon Valley Coalition), Exporting harm: the high tech trashing of Asia. The Basel Action Network/Silicon Valley Toxics Coalition, 2002.



## ENVIRONMENTAL PROTECTION IN GLOBAL LOGISTICS COMPANIES

Marko Velickovic<sup>1\*</sup>, Dj. Stojanovic<sup>1</sup>, D. Pantic<sup>2</sup>

<sup>1</sup>University of Novi Sad, Faculty of Technical Sciences,  
Department of Traffic Engineering, 21000 Novi Sad, SERBIA

<sup>2</sup>Schenker doo, Treca logisticka ulica 1, 22304 Novi Banovci, SERBIA

\**marvel@uns.ac.rs*

### ABSTRACT

Global logistics companies have very high impact on environment, due to the nature and volume of operations and services they offer. Public pressure and legal frames have increasingly influenced on them to implement a variety of measures in order to reduce their externalities. In this paper, ten global logistics service providers are selected to analyze their practice in environmental protection. Their activities, measures and targets in the field of environmental protection are briefly presented. Some of them are common for more companies, some of them are more unique. Thus, presented results also highlight the best practice in global logistics companies.

**Key words:** Environmental protection, Global Logistics Service Providers, Green logistics.

### INTRODUCTION

Economic development of society is closely related with transport and logistics industry growth. However, this sector is one of the leading environmental polluters in the world. Permanently rising trend of transport volume and increased public and governmental care for environment force large logistics companies to act in environmentally friendly manners.

The objective of this research are targets and efforts in global logistics companies in order to reduce their negative impact on environment. Generally, such efforts have two directions: to reduce negative impact of own operations on one hand and to support various environmentally friendly activities of company and other organizations on the other.

The aim of the research is to reveal and review the best practices of global logistics companies related with reducing their negative impact on environment. Planned and implemented activities and achieved results were briefly reviewed.

This paper is organized in 5 Sections. In the second Section, main transport and logistics impact on environment are summarized and classified. Research methodology is described in the third Section. Results and discussion are briefly shown in the fourth Section, and final remarks and conclusion are given in the last Section.

## **TRANSPORT AND LOGISTICS IMPACTS ON ENVIRONMENT**

The global supply chains gain an increasing attention due to growing international trade volumes. Manufacturers require reliable suppliers, traders require flexible connections with distributors and consumers require less expensive and high quality products. Therefore, sellers more often participate in the continuous expansion of the distribution network to reach the customers more efficiently.

Supply chain management has been changing in the last three decades primarily due to development of information technologies, communications and transport technologies. Those changes were partly generated by outsourcing own tasks to specialized logistics intermediaries – service providers. Today's international trade in global context would not be possible without global logistics providers. Their growth is strongly related with globalization of production and transport technology (including related ICT) development.

Further, growing international trade volumes increase the demand for goods delivery activities, which consequently increase negative impact on environment.

Transport activities contribute at different geographical scales to environmental problems [1]:

- Local (noise, air pollution);
- Regional (smog, acid rain);
- Global (climate change).

The most important environmental impacts of transport include climate change, air quality, noise and vibrations, water quality, soil quality, land take and biodiversity [1]. All these impacts are interrelated and have direct, indirect or, most often, cumulative and complex effects on humans, biosphere, soil, water, buildings and materials. The transport sector has become known as one of the dominant sources of air pollution and greenhouse gasses (GHGs) emissions [2]. However, less explored and less measurable, long-term effects like impact on soil and groundwater are also of crucial importance.

In addition to transport, warehouses are also major sources of pollution. According to The Common Fire Foundation, buildings use 36% of all energy consumed in the US, 65% of electricity, 30% of raw materials and 12% of potable water [3]. In UK, 35% of buildings are commercial, and of them 25% are warehouses. However, among commercial buildings, which comprise retail stores, offices and warehouses, building in warehousing sector will have the fastest growth. Warehousing costs can account for almost 10% of a company's revenue, with heating and lighting as the two largest energy users [3].

Logistics Service Providers (LSPs) provide services such as transportation, warehousing, freight forwarding, cross-docking, inventory management, packaging and all other services needed for efficient and effective goods delivery to final destination. Global logistics companies use to offer an integrated logistics service from "door to door" for the customer. All these services and related activities have negative impact on environment. Recognized as big polluters, LSPs, particularly the global ones, aim to reduce external negative effects of their operations. Their efforts to become recognized

as environmentally responsible are important due to increased legislative norms, market competition, customers' expectations, as well as public pressure.

Therefore, global logistics companies used to set various targets and objectives aiming to reduce negative environmental impacts.

### **METHODOLOGY**

For the research purpose, we wanted to explore the best practice of the biggest global logistics companies - service providers. The Supply Chain 24/7 website gives ranking of the global 3PL service providers every year. Ten global logistics companies from top 50 ranking lists are selected [4-6]. Then, environmental protection targets, measures and effects implemented in those companies are identified and compared. The selected companies are as follows:

DHL Supply Chain & Global Forwarding	Panalpina
Kuehne+Nagel,	Toll Holdings
DB Schenker Logistics,	Geodis
Nippon Express,	Hellmann Worldwide Logistics
DSV	Ryder Supply Chain Solutions

These companies are the most successful global 3PL companies and drive the global market. The first four selected companies are on the top of the list for years. DSV and Toll Holdings change their positions up and down the list. Panalpina holds a stable position at the end of the top 10 companies on the list. The last three companies (Geodis, Hellmann Worldwide Logistics and Ryder Supply Chain Solutions) are stable on the list ranking, but are lower ranked than the previous companies, around the 15<sup>th</sup>, 20<sup>th</sup> and 30<sup>th</sup> position, respectively.

For selected companies, we collected data related with environmental targets, activities and reached goals from their official websites and published reports. Their reports, measures and statistical data are mostly not unified. Therefore, they were not always comparable.

Companies have also developed a variety of green concepts, which may have many similarities. However, each company also used to focus on some particular measures, highlighting this as a competitive advantage within own environmental strategy.

### **RESULTS AND DISCUSSION**

The most of the companies included in research gave online access to their basic company characteristics – company size, number of employees, annual revenue, geographical coverage and warehouse capacity (Table 2). Companies are ranked with regard to gross revenue of the group/corporation logistics branch.

**Table 2.** Size and performance of the top global logistics companies

LSP Company name	Gross Logistics Revenue (mil USD) <sup>3</sup>	Size, no. of employees, geographic coverage	Warehouse area
DHL Supply Chain & Global Forwarding	32,193 (31,432)	220 countries 475 000 employees	/
Kuehne+Nagel	23,293 (22,587)	100 countries 63 000 employees	over 7 million m <sup>2</sup>
DB Schenker Logistics	19,861 (19,732)	2000 offices global 95 700 employees	7.1 million m <sup>2</sup>
Nippon Express	17,916 (17,317)	229 offices global 19 000 employees	4.8 million m <sup>2</sup>
DSV	13,470 (8,140)	70 countries 23 000 employees	150 000 m <sup>2</sup>
Panalpina	7,338 (7,293)	70 countries 16 000 employees	22 million m <sup>2</sup>
Toll Holdings	5,822 (6,266)	50 countries 40 000 employees	/
Geodis	5,960 (5,828)	67 countries 31 000 employees	3 million m <sup>2</sup>
Hellmann Worldwide Logistics	3,800 (3,433)	157 offices global 12 000 employees	2.5 million m <sup>2</sup>
Ryder Supply Chain Solutions	2,461 (2,280)	/ 29 000 employees	3.5 million m <sup>2</sup>

There is a wide range of environment protection measures that companies implemented: alternative fuels usage, renewable energy sources prioritization, CO<sub>2</sub> emission reduction, recycling, water consumption reduction, heating system improvement, energy savings in warehouses, less natural resources consumption, etc. The measures that are popular among global logistics companies in their operations are listed in Table 3. Four of ten analyzed companies have set 8 out of 11 identified environmental protection aims, two companies have set 7 aims, three from the rest 4 companies have set 6 aims and Geodis is the only company that have set only 5 aims which is less than a half of identified aims.

<sup>3</sup> The value in brackets is for year 2013, and the value outside brackets is for year 2014.

**Table 3.** Implementation of environmental protection activities in company

Environmental protection activity Company	Alternative fuels	Renewable energy sources	CO <sub>2</sub> emission reduction	Water consumption reduction	Less natural resources consumption	Recycling	Heating system improvement	Energy savings in warehouses	Organized transport of employees	Education and training of employees	New technologies testing
DHL Supply Chain & Global Forwarding	+	+	+		+	+			+	+	+
Kuehne+Nagel	+		+	+	+	+	+	+			+
DB Schenker Logistics		+	+		+	+		+	+		+
Nippon Express	+	+	+		+			+		+	+
DSV	+		+	+	+	+	+	+			+
Panalpina		+	+	+	+	+	+		+		+
Toll Holdings	+	+	+	+			+				+
Geodis	+		+			+				+	+
Hellmann Worldwide Logistics	+	+	+			+		+			+
Ryder Supply Chain Solutions	+		+	+		+			+		+

Environmental protection activities already implemented in companies have shown some results in the past. The results gained through various activities are shown in Table 4. However, there are some challenges to perform comparative analysis between companies and set the benchmarking. The referent year for values in Table 4 varies between companies due to available reports. Also, the results in Table 4 are not related with all activities identified in Table 3, due to a lack of data in reports. The third challenge are different units used for same activities (e.g. columns 2 and 7 in Table 3).

**Table 4.** Achieved benefits of the implemented activities

Company (referent year)	Environmental protection activity	CO <sub>2</sub> reduction	Fuel consumption reduction	Energy use reduction	Recycling increase	Water use reduction	Alternative fuels usage	Energy savings in warehouses
DHL Supply Chain & Global Forwarding (2012)		8%	1-5%		25%			<b>2%</b>
Kuehne+Nagel (2010)		3%		11%	13%	33%		17%
DB Schenker Logistics (2013)		7-9%			30%	8%		12%
Nippon Express (2011)		5,6%		11%			6130 vehicles	7%
DSV (2012)		3-8%	2,7%	9%	83%		64%	
Panalpina (2013)		9%	7%		35%	9%		4%
Toll Holdings (2008)			10%					
Geodis (2008)		5-9%	14%		73%		63%	
Hellmann Worldwide Logistics (2013)		30%					16%	
Ryder Supply Chain Solutions (2009)		13000 t /annually		6%		7%		<b>5%</b>

All companies have set high targets which had to reach in the previous period. However, only two companies (DHL and Ryder) reported failure in achieving some set goals. Both failures refer to the warehouse energy saving goals. The highest percentages in Table 4 refer to recycling. There are no obligational legal standards in this field, so the companies have had only moral and social responsibility to set and achieve targets. Recycling provide additional economic benefits for companies which explains high results.

Global logistics companies are willing to set targets and introduce measures in order to reduce negative impacts on environment in future, despite the fact that some of them do not give direct economic benefits. Table 5 show current targets of the companies, set for 2020, in order to enhance current efforts to care for environment. The future will show the success of companies in reaching these targets and courage to publish results.



**Table 5.** Environmental protection targets for year 2020

Company	Environmental protection activity	Targets
DHL Supply Chain & Global Forwarding (2012)	- CO <sub>2</sub> emission reduction for every delivered letter and every parcel	30%
Kuehne+Nagel (2010)	- CO <sub>2</sub> emission reduction - Energy efficiency improvement - Recycling	15% 20% 70%
DB Schenker Logistics (2013)	- CO <sub>2</sub> emission reduction - Energy and water savings	20% 19%
Nippon Express (2011)	- CO <sub>2</sub> emission reduction - Energy efficiency improvement	25% 30%
DSV (2012)	- Gases emission reduction - Energy efficiency improvement	15% 85%
Panalpina (2013)	- GHGs emission reduction	15%
Toll Holdings (2008)	- Gases emission reduction - Energy savings	20% 20%
Geodis (2008)	- CO <sub>2</sub> emission reduction	20%
Hellmann Worldwide Logistics (2013)	- Gases emission reduction - Recycling, energy savings, biofuels and solar energy usage	15% 20%
Ryder Supply Chain Solutions (2009)	- CO <sub>2</sub> emission reduction - Energy savings	20% 10%

## CONCLUSION

Logistics and transport industry strongly contribute to environmental pollution in different ways. Global logistics companies, due to their transport volume and related profits are the biggest individual polluters and therefore have the greatest responsibility to contribute to environmental protection. For that purpose, they use to set targets to decrease these negative impacts and related activities and metrics. In this paper, we identified the activities which global logistics companies most often use to mitigate these negative impacts and metrics to measure achievement of environmental targets.

The top logistics companies in the world have a similar way they look at environmental protection. Different measures are implemented, but the most attention is dedicated to CO<sub>2</sub> emission reduction, alternative fuels usage, materials recycling and reduction of energy consumption in warehouses.

The global LSPs usually do not regularly publish reports on their efforts, and do not have such obligation. It might be that the companies avoid publishing systematic and comprehensive reports because they failed to achieve the expected goals. However, most of them express willingness to deliver detailed and updated reports on demand. On the other hand, the brochures with strict orientation of companies to develop green logistics and corporate responsibility in the field of environmental protection are numerous.

There is the problem with monitoring and benchmarking of companies results. Companies present own results without external control and evaluation. Also, a comparative analysis of logistics companies' efforts to mitigate negative impact on environment reveal a great variety of activities, metrics and results. Their reports are not

adjusted for comparative analysis. Instead, it seems that they are rather created for market competition purpose and creating positive image on companies' care about environment. Although there are many similar metrics for targets, the activities and solutions to reach the targets are various. There is a lack of globally standardized legislative norms which global companies have to meet in doing business. The unified methodology for measuring impacts on environment, and publishing standardized reports are also missed. They are necessary for a comprehensive and accurate monitoring of companies' impact on environment and set a benchmarking system, applicable for the comparison of companies' efforts during the time, as well as the comparison between the companies.

### REFERENCES

1. Rodrigue, J., Comtois, C., Slack, B. (2013): *The Geography of Transport Systems*, 3rd Edition, New York: Routledge, 416 pages.
2. Ranisavljević, P., Dašić, T., Mladenović-Ranisavljević, I. (2013): Possibilities for the development of the concept of green logistics in Serbia across the transport sector, *Economics management information technology*, Vol. 2, No. 1, pp. 41-48.
3. Huston, J. (2013): *Save Energy in Your Warehouse to Meet Green Initiatives*, Available at: <http://www.supplychaindigital.com/warehousing/1905/Save-Energy-in-Your-Warehouse-to-Meet-Green-Initiatives>, Last accessed on: 25 April 2016.
4. Burnson, P. (2013), *The Top 50 Global & Top 30 Domestic 3PL Providers*, Available at: [http://www.supplychain247.com/article/the\\_top\\_50\\_global\\_top\\_30\\_domestic\\_t hird\\_party\\_logistics\\_providers](http://www.supplychain247.com/article/the_top_50_global_top_30_domestic_third_party_logistics_providers), Last accessed on: 05 May 2016.
5. Burnson, P. (2015), *2014/15 Top 50 Global & Domestic U.S. Third-Party Logistics Providers*, Available at: [http://www.supplychain247.com/article/2014\\_2015\\_top\\_50\\_global\\_us\\_third\\_pa rty\\_logistics\\_providers](http://www.supplychain247.com/article/2014_2015_top_50_global_us_third_party_logistics_providers), Last accessed on: 05 May 2016.
6. Burnson, P. (2014), *2013 Top 50 Global & Domestic Third-Party Logistics Providers*, Available at: [http://www.supplychain247.com/article/2013\\_top\\_50\\_global\\_top\\_30\\_domestic \\_3pls](http://www.supplychain247.com/article/2013_top_50_global_top_30_domestic_3pls), Last accessed on: 05 May 2016.



## SOIL PROTECTION POLICY – EU AND SERBIAN PERSPECTIVE\*

Slobodan Rakic<sup>1\*</sup>, A. Kekez Kljajic<sup>2</sup>, N. Raspopovic<sup>1</sup>

<sup>1</sup>Educons University, Faculty of Business Economy, SERBIA

<sup>2</sup>Educons University, Faculty for Applied Security, SERBIA

\*rakic@educons.edu.rs

### ABSTRACT

Pollution and depletion of natural resources has become a global problem. The response for tackling climate, pollution and depletion of natural resources has been mild at best, because the effects of human interference with the nature has not been fully contemplated and felt.<sup>4</sup> One of the pressing concerns regarding soil protection is the legislative part of EU institutions. In 2006, draft of the Soil Framework Directive has been prepared by the European Commission, and after years of debate in 2014 the proposal has been withdrawn and to this date there is still no common approach on EU level. These facts drove authors to tackle the issue of EU and EU candidate countries policies that are dealing with soil pollution. Authors in this article presented policy targets set by EU and candidate EU countries with respect to local soil contamination. The aim of this paper is to analyze reports, programmes, communications and other EU documents regarding strategies, and other relevant issues that tackle soil remediation. And in the last part of the paper, remarks on the new Serbian soil protection law will be presented. Conclusion shows that there is urgent need for common EU approach on soil protection as well as data collection and distribution on contaminated sites all across EU and candidate countries.

**Key words:** soil, remediation, policy, contaminated site, Serbia, European Union

### INTRODUCTION

From a global perspective soil pollution and contamination has become an increasing problem. Countries that are especially hit with rising number of contaminated sites are mostly developing countries. International response to this issue has been mild at best, and international community has just recently started creating a response to tackle these rising problems.<sup>5</sup> Policies for the remediation of contaminated sites emerged relatively late as a subfield of environmental protection. The policy area is adjacent to

---

<sup>4</sup> Rakic S., Gajic B., "Different types of funding mechanism for soil remediation", Scientific Journal "Ecologica", vol 22, nr 80, 2015, UDK: 502.07, ISSN 0354-3285, pages 617-622. Publisher: Scientific Organization for Environmental Protection in Serbia "ECOLOGICA". Page 622

<sup>5</sup> Rakic S., Mitić P., "International funding for soil remediation projects" Publisher: Kaposvar University, Faculty of Economic Science, H-7400 Kaposvar, Guba Sandor u.40., Hungary. Scientific proceedings: 5<sup>th</sup> Climate Change, Economic Development, Environment and People Conference "CCEDEP 2015", ISBN 978-963-9821-86-6, vol 5, pages 313-320, (Kaposvar, Hungary. May, 2015.)

other policies, such as waste policy, which often includes provisions on how to deal with waste dumps, as well as soil and groundwater protection policies, which deal with the prevention of contamination. Nevertheless, most countries introduces policies for the clean-up of contaminated sites in the course of the 1990s while only a handful already tackled this issue in the 1980s.<sup>6</sup> Among all issues the most important is to understand the purpose of supporting the soil policy. The possibilities for a common approach need also the development of adequate risk strategy in future remediation activities. Every country needs to assess the economic feasibility of chosen soil remediation process for contamination sites regarding their own needs and possibilities, but also following useful examples from practice.<sup>7</sup>

### TARGETS FOR LOCAL SOIL CONTAMINATION REDUCTION

Management of contaminated sites is tiered process starting with a preliminary survey searching, assessment of the contamination level, confirmation of environmental impacts and finally implementation of remedial and after care measures.<sup>8</sup> Each country that strives to begin with this process, should set strategic goal in dealing with this arising issue.

The overarching policy objective is to achieve a level of quality of the environment where man-made contaminants on sites do not give rise to significant impacts on or risks to human health and ecosystems. Legal requirements for the general protection of soil have not been agreed at the European Union (EU) level and only exist in some Member States.<sup>9</sup>

Since there is no common EU regulative approach on soil, some of the countries from EU, EEA and EU candidate countries have established their own targets for reducing local soil contamination. Table 1 shows those target dates.

Regulatory framework of most countries that are referred to in the table are centralized, but some countries such as Germany, Italy and Spain have local implementation of regulation while United Kingdom has regional approach.

Most of the data integrate information from the whole country. However the process greatly differs from country to country depending on the degree of decentralization. Also in countries with decentralized systems, the coordination may be different. In general, the quality and representativeness of the data increases with the centralization of the information.<sup>10</sup>

---

<sup>6</sup> Veenman S., *Understanding Environmental Policy Convergence, Chapter 6 "National policies for cleaning up contaminated sites"*, page 175, ISBN 978-1-107-03782-3, Publisher: Cambridge University Press, 2014.

<sup>7</sup> Radović, V., Rakić S., *The risk strategy in a future remediation activities – how to avoid the failure*, Publisher: University Donja Gorica, Podgorica, Montenegro: Scientific Proceedings 3rd Climate Change Economic Development and People Conference – CCEDEP 2013 (5-7, December 2013, Podgorica, Montenegro).

<sup>8</sup> Radović V., Rakić S., *The management of contaminated sites and soil remediation in Serbia*, Page: 323-330, ISBN: 978-86-6305-007-5, Publisher: University of Belgrade, Technical Faculty in Bor, Republic of Serbia; Scientific Proceedings XXI International Scientific and Professional Meeting "Ecological Truth" Eco-Ist '13. (4-7 June, 2013, Bor Lake, Hotel "Jezero", Bor, Serbia).

<sup>9</sup> Progress in management of contaminated sites, European Environment Agency – site accessed – 20.04.2016.

<http://www.eea.europa.eu/data-and-maps/indicators/progress-in-management-of-contaminated-sites-3/assessment>

<sup>10</sup> Progress in management of contaminated sites, European Environment Agency – site accessed – 20.04.2016.

<http://www.eea.europa.eu/data-and-maps/indicators/progress-in-management-of-contaminated-sites-3/assessment>

**Table 1.** Overview of existing policy targets for local soil contamination.

Country	Year	Policy or technical target
Austria	2025	Identification of contaminated sites completed
	2030-2040	Essential part of the contaminated sites problem should be managed
	2050	Remediation and re-integration of identified contaminated sites into economic and natural cycle
Belgium (Flanders)	2036	Remediation started on sites with potentially contaminating activities and/or that are considered to be contaminated
Croatia	2025	Remediation of "hot spots", locations in the environment which are highly burdened with waste
Czech Republic	2040	Political/technical level [government decree]: Environmental remediation of uranium and coal facilities DIAMO
Denmark	2016	Site identifications and preliminary investigations are completed nationwide
Estonia	2030	All contaminated areas to be remediated or sustained
Hungary	2050	Handling of all historic contaminated sites. The Gov. Decision No. 2205/1996. (VIII.24.) adopted the National Environmental Remediation Programme (OKKP), which has three stages: short, medium and long.
Kosovo* UNSCR 1244/99	2018	Drafting of land cadastre and developing monitoring system
	2025	Re-cultivation and adequate use of agricultural land
FYR of Macedonia	2008-2014	Implementation of the closure/remediation measures for the top three hotspots from the annex 1
Montenegro	2008-2012	Recovery and/or closure of existing dumpsites, remediation of hot-spots (contaminated sites), construction of regional sanitary landfills
Netherlands	2015	Bringing risk at sites to an acceptable level for the current land use Handling of sites at risk with current land use
Norway	2012	Handling of (approx. 250) sites completed, where pollution is shown to be most serious, i.e. where pollution is released to priority areas or can pose a human health risk
Romania	2020	Environmental remediation of the majority of polluted areas
Serbia	2014	Priority list for remediation will be established.
	2019	20% of priority sites should be remediated.
Slovakia	2015	Remediation of the contaminated sites with the highest risk to human health and environment (to reach "good status of water" with respect to the Water Framework Directive)
Sweden	2050	Environmental objective: a non-toxic environment Remediation of priority sites by 2010 Other contaminated sites contained or remediated by 2050 at the latest
Switzerland	2025	Remediation or containment of historic soil contamination

**Source:** Progress in the management of Contaminated Sites in Europe, Institute for Environment and Sustainability, Joint Research Centre reference report, European Commission, 2014.

## EUROPEAN UNION LEGISLATION ON SOIL PROTECTION

In order to assess regulatory progress on soil protection on European Union level, it is important to have concisely shown current regulatory framework. Table 2 shows most significant EU policies which deal with soil protection and gives important insight into those directives, especially in the parts which deal with soil protection.

**Table 2.** Most significant EU policies which deal with soil protection

REGULATION	DESCRIPTION
Plant Protection Products Regulation 1107/2009	The Regulation aims to ensure a high level of environmental protection, as well as to provide clearer rules to make the approval process for plant protection products more effective.
Pesticide Use Directive 2009/128/EC	Action to achieve the sustainable use of pesticides by reducing the risks and impacts of pesticide use on soil.
7 <sup>th</sup> Environmental Action Programme – 7 <sup>th</sup> EAP	The programme identifies priority to reduce the most significant man-made pressures on land, soil and other ecosystems in Europe.
Directive on Industrial Emissions IED 2010/75/EU	Directive provides an integrated approach for the prevention and control of industrial emissions into soil.
Landfill Directive 99/31/EC	Directive aims to ensure preventing or reducing negative effects on soil from the landfilling of waste by introducing stringent technical requirements for waste and landfills.
Carbon Storage Directive 2009/31/EC	The directive establishes a legal framework for the environmentally safe geological storage of CO <sub>2</sub> and therefore preventing risks to the soil.
Renewable Energy Directive 2009/28/EC	This Directive establishes a common framework for the production, use and promotion of energy from renewable sources in order to protect environment.
Waste Framework Directive 2008/98/EC	Directive aims to ensure that waste is recovered or disposed of without risk to air, soil and plants and animals.
Mining Waste Directive 2006/21/EC	Directive aims to ensure that waste is properly managed and to prevent, or minimize, any water and soil pollution.
Water Framework Directive 2000/60/EC	Water policy framework
Floods Directive 2007/60/EC	Directive aim is to reduce and manage the risks that floods pose to the environment.
Water Framework Directive 2000/60/EC	Establishing a framework for community action in the field of water policy
Common Agricultural Policy (CAP)	Deals with the prevention of soil degradation

Source: Authors

Even though there is no European Union Directive which deals only with soil protection, we cannot say that European Union does not take care of its soil. Numerous EU directives, national legislation and strategies show that soil protection is one of major EU issues and is current topic in EU institutions as a part of wider “environmental” conversation.

### SERBIAN LEGISLATION ON SOIL PROTECTION

The concept and responsibility to protect soil in Serbia arises primarily from the Environmental Protection Act<sup>11</sup>. Since Serbia is striving to become part of the EU,

<sup>11</sup> RS Official Gazette, no. 135/2004, 36/2009 - et al.72/2009 - other laws ,42/2011 - decision of US and 14/2016

Serbian environmental policies tend to get in line with European policies, and so Environmental protection act states: "Protection of soil and its sustainable use is achieved with measures of systematic monitoring of soil quality, monitoring indicators for assessing the risk of soil degradation, as well as the implementation of remediation programs for the elimination of consequences of contamination and degradation of soil, whether they occur naturally or are caused by human activities."<sup>12</sup>

On the basis of the Environmental Protection Act, which Government of the Republic of Serbia adopted in 2010, the National Environmental Protection Programme was established.<sup>13</sup> It represents a means for solving the priority problems in the field of environmental protection, and contributes to Serbia's accession to the European Union. Programme is based on the general approach that encourages the integration of environmental protection into sectorial policies, provides framework for the adoption of action plans that will address specific environmental issues, and particularly defines soil protection. Formation of a list of locations with the status of especially endangered sites and the priorities for rehabilitation and remediation to 20% of the territory of the RS was short term goal, and it was supposed to be achieved by 2014. According to the Programme, continuous objectives (2010-2019) are: to carry out the remediation of contaminated sites form the list of priorities; to develop a system for monitoring, protection and improvement of soil quality by pollutants; to develop modern standard operating procedures and guidelines for the performance of obligations related to the protection of soil; to educate general public through activities at the national and international level on combating soil degradation and desertification.

Systems, mechanisms and procedures for the harmonization of Serbian environmental legislation with EU law are established by National Environmental Approximation Strategy for the Republic of Serbia, adopted in 2011.<sup>14</sup>

In January 2016 came into force a Soil protection Act.<sup>15</sup> The Act regulates protection of soil, systematic monitoring of the quality of soil, measures for rehabilitation, remediation, re-cultivation, inspection and other important issues that are significant to protection and preservation of soil as a natural resource of national importance.<sup>16</sup> Protection of soil is provided by the Republic authorities, autonomous province authorities, local government units, legal entities, entrepreneurs, owners and users of soil that in carrying out activities threaten, degrade or pollute the soil.<sup>17</sup> The Act is based on the principle "polluter pays". In the Articles six and eight of the Act the preventive measures for the protection of soil are: planning and integrating soil protection into sectorial policies and plans, establishing the requirements of land protection, adoption of planning and program documents for land protection (land protection plan, annual program of protection of land and soil monitoring program). Remediation of soil is carried out in cases where soil contamination at a particular location exceeds the concentration of pollutants, hazardous and harmful substances

---

<sup>12</sup> Environmental Protection Act, Article 22

<sup>13</sup> RS Official Gazette, no. 12/2010

<sup>14</sup> RS Official Gazette, no. 80/2011

<sup>15</sup> RS Official Gazette, no. 112/2015

<sup>16</sup> Soil Protection Act, Article 1

<sup>17</sup> Soil Protection Act, Article 6

prescribed remediation value and is carried out according to the approved project.<sup>18</sup> Responsible person is obliged to perform remediation on the basis of the project and to provide funds for remediation.<sup>19</sup> The Act also regulates the monitoring of soil, state and local area network monitoring, information system of soil quality, as well as the public record of contaminated sites, which represents a collection of data on contaminated soils. Transitional and final provisions stipulate that the Bylaws will be adopted within one year from the date of entry into force of this Act, Soil Protection Plan within two years, and public record for contaminated sites will be established within six months from the date of entry into force of the bylaw.

## CONCLUSION

At the European level, there was no overriding directive on the soil protection as there was for water and the air. The issue was addressed indirectly by means of measures for environmental protection. EU policies must address soil threats and functions directly to ensure that the threats and functions are targeted by new sustainable soil management practices. Because existing legislation fails to address soil threats and functions directly, a common European soil policy is needed to ensure the conservation of soil functions.<sup>20</sup>

Regulatory framework in Serbia has centralized approach similar to other EU countries. As an EU candidate Serbia has established its own targets for reducing soil contamination and management of contaminated sites which includes a preliminary survey searching, assessment of the contamination level and implementation of remedial and after care measures. Adequate legal basis has established operational instruments for the implementation of soil protection, such as public record of contaminated sites, information system of soil quality and the accreditation of soil monitoring experts. Future issues to be dealt with are the problems of implementation of the regulation concerning soil protection. As far as regulation goes, Serbia is well on its way towards European soil protection goals and achievements, but there is a lot more work to be done, which falls into accession negotiations between Serbia and EU.

## Acknowledgements

*This paper was written as a part of the project Nr. III 43010 "Modulation of antioxidative metabolism in plants for improvement of plant abiotic stress tolerance and identification of new biomarkers for application in remediation and monitoring of degraded biotopes" which is financed by the Ministry of education, science and technological development of the Republic of Serbia.*

---

<sup>18</sup> Soil Protection Act, Article 22

<sup>19</sup> Soil Protection Act, see Articles 23, 24, 25

<sup>20</sup> Glaesner N., Helming K., Vries D.W., "Do Current European Policies Prevent Soil Threats and Support Soil Functions?", Open Access Journal: Sustainability, Publisher: MDPI, Basel, Switzerland, MDPI ISSN 2071-1050, doi:10.3390/su6129538, 2014.



## REFERENCES

1. Environmental Protection Act (RS Official Gazette, no. 135/2004, 36/2009- et al.72/2009 - other laws ,42/2011 - decision of US and 14/2016)
2. Glaesner N., Helming K., Vries D.W., “*Do Current European Policies Prevent Soil Threats and Support Soil Functions?*”, Open Access Journal: Sustainability, Publisher: MDPI, Basel, Switzerland, *MDPI* ISSN 2071-1050, doi:10.3390/su6129538, 2014.
3. National Environmental Approximation Strategy (RS Official Gazette, no. 80/2011)
4. National Environmental Protection Programme (RS Official Gazette, no. 12/2010)
5. Progress in management of contaminated sites, European Environment Agency – site accessed – 20.04.2016. <http://www.eea.europa.eu/data-and-maps/indicators/progress-in-management-of-contaminated-sites-3/assessment>
6. Progress in the management of Contaminated Sites in Europe, Institute for Environment and Sustainability, Joint Research Centre reference report, European Commission, 2014. [http://publications.jrc.ec.europa.eu/repository/bitstream/111111111/30755/1/lbn\\_a26376enn.pdf](http://publications.jrc.ec.europa.eu/repository/bitstream/111111111/30755/1/lbn_a26376enn.pdf)
7. Radović V., Rakić S. “*The management of contaminated sites and soil remediation in Serbia*”, Page: 323-330, ISBN: 978-86-6305-007-5, Publisher: University of Belgrade, Technical Faculty in Bor, Republic of Serbia; Scientific Proceedings XXI International Scientific and Professional Meeting “Ecological Truth” Eco-Ist ‘13. (4-7 June, 2013, Bor Lake, Hotel “Jezero”, Bor, Serbia).
8. Radović, V., Rakić S. „*The risk strategy in a future remediation activities – how to avoid the failure*“, Publisher: University Donja Gorica, Podgorica, Montenegro: Scientific Proceedings 3rd Climate Change Economic Development and People Conference – CCEDEP 2013 (5-7, December 2013, Podgorica, Montenegro).
9. Rakić S., Gajić B., “*Different types of funding mechanism for soil remediation*“, Scientific Journal “*Ecologica*”, vol 22, nr 80, 2015, UDK: 502.07, ISSN 0354-3285, pages 617-622. Publisher: Scientific Organization for Environmental Protection in Serbia “*ECOLOGICA*”.
10. Rakić S., Mitić P., “*International funding for soil remediation projects*” Publisher: Kaposvar University, Faculty of Economic Science, H-7400 Kaposvar, Guba Sandor u.40., Hungary. Scientific proceedings: 5<sup>th</sup> Climate Change, Economic Development, Environment and People Conference “*CCEDEP 2015*”, ISBN 978-963-9821-86-6, vol 5, pages 313-320, (Kaposvar, Hungary. May, 2015.)
11. Soil protection Act (RS Official Gazette, no. 112/2015)
12. Veenman S., *Understanding Environmental Policy Convergence, Chapter 6 “National policies for cleaning up contaminated sites”*, page 175, ISBN 978-1-107-03782-3, Publisher: Cambridge University Press, 2014.



## MODELING AND SIMULATION COST-TIME PROFILE OF BUSINESS GREEN PROCESSES

Obrad Anicic, S. Jovic, B. Pejovic, Lj. Savic

University of Pristina, Faculty of Technical Science, Kosovska Mitrovica, SERBIA

### ABSTRACT

New strategies and tools have been investigated constantly to improve processes, decrease cost and increase productivity and efficiency. The main aim of the paper is to research the impact of business processes on value stream optimization and decreasing of cost-time investment. Mapping of the value stream is a very efficient tool for the visualization of process activities within production flow focused on activity duration with the purpose to eliminate non-value added activities. Cost-time profile is a powerful tool for visualization and calculation of cost accumulation during the time across the entire business process flow. Leken scheduling system is software used in this paper for construction of the process schedules based on four different rules.

**Key words:** model, simulation, green process, cost-time profile, lean manufacturing.

### INTRODUCTION

Modern business processes have the conditions from the global market to force manufacturers to increase competitiveness which can be achieved by developing flexible manufacturing systems, producing the high quality products and reducing production costs. In the same time the manufacturers have to pay more attention to products variation, value of customers and delivery deadlines since mass production is not efficient at this time. To increase production effectiveness, companies could select the strategy of constant improvement through waste elimination. Process of the efficient production with high quality control has become very important for business processes in all companies to meet customers' satisfaction [1].

Reduction of the time and cost is the most important for every business process in companies hence the monitoring and control of manufacturing cost over the time can be a good base for improvements. By using the less consumable in manufacturing could be a good strategy for money making and money savings could also be achieved by preventing waste [2].

The customer value is the priority in modern economy as well as monitoring the cost of resources usage and productivity. Higher output and higher productivity are achieved with overall added value by lead time reduction, so manufacturers have to

develop processes which could create its added value as fast as possible [3]. With the implementation of modern business approaches, companies have to change business procedures in general to be compatible with new manufacturing systems [4-5]. Information are the most important resources in modern business environment, so information collection in the appropriate way is a big challenge for companies. Information collection from the business processes is mainly used in mass production and product cost is the crucial fact for management. In many companies identification and recognition of the complete value stress is not applicable.

### **LEAN MANUFACTURING**

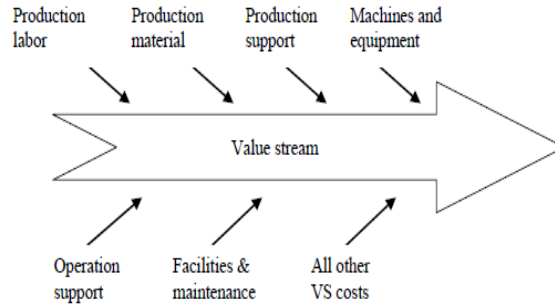
Global competition is forcing many companies to adopt new approached for production such as lean manufacturing to be more competitive. Lean production represents efforts to achieve high effects with less investment. Lean production is a multidimensional approach that merges together a different management practices in on system. When the elements are properly implemented and connected the synergy can be created with the high quality system with the level of production which is created according to the customer requirements [6].

Lean manufacturing is comprehensive set of tools and techniques for waste reduction with the goal to improve flexibility and effectiveness of a business system [7]. The basis of lean production is absolute waste elimination and the main aims are cost reduction and increasing production system efficiency [8]. According to the article [9] the lean production will be supplant mass production and other business approaches in all industrial areas and become a standard global production system of the 21<sup>st</sup> century. Lean management implementation is necessary in order to increase productivity, reduce costs, increase flexibility and create more value for the customer [10].

### **VALUE STREAM COSTING**

Many companies had failures with lean production implementation because the traditional accounting system is not based on lean principles and doesn't provide appropriate and timely information [11]. In traditional business systems the mass production is supported and differences between direct and indirect costs are not made. Assumption of long production runs is established in traditional cost systems. These systems will not be applicable for new business conditions and environment [12]. To avoid potential conflicts with the lean implementation, companies are starting to implement other accounting systems such as lean accounting in order to solve the problems of overseas allocation.

Lean accounting was developed to support the lean manufacturing implementation based on mapping of stream value. Therefore all cost become direct and their allocation along he stream value is shown in Figure 1 [13].



**Figure 1.** Value stream cost [13]

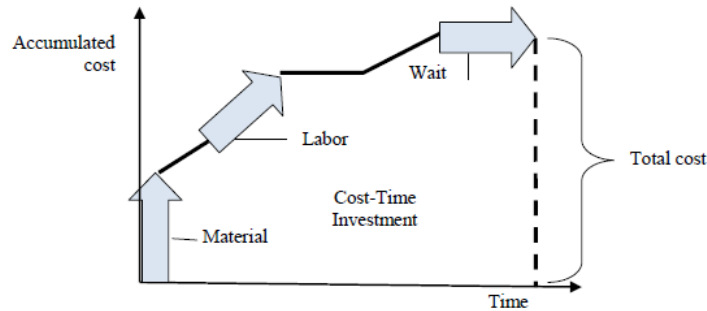
### COST-TIME PROFILE

Cost-time profile is a technique to measure process improvement or to select the right decision, which should be applied in order to improve process. The cost-time profile can be defined as a diagram of cash accumulation during each unit of time across the entire business cycle and this profile is a cash oriented diagram [14].

The main goal of cost-time profiling is the tracking the business activity as an accumulation of cost over time. The cost-time profile is a graph that shows how much money was spent for the production of the product and how much time elapses from process start to end until the money came back through the sale [15]. Cost-time profile searches the new possibilities or process improvements and evaluates and selects the measures to achieve the improvement in business process.

Cost-time profile diagram requires the information about process, cost and activities and has three components as shown in Figure 2:

1. **Material** – including services and information,
2. **Labour** – activity performing,
3. **Wait** [16].



**Figure 2.** Cost-time profile

**BUSINESS PROCESS SCHEDULING**

If completion of a job is successful it means the job was within the planned time. All activities, operations and processes in one company have to be scheduled in order to meet production plans. Scheduling is one of the most important tool in production planning and control because it defines arrangement of activities in order to utilize time in optimal manner and companies have to have good scheduler to be able to satisfy changeable customer needs [17]. It is very difficult problem since it requires large combinatorial search space [18]. The value stream mapping for a business process should be flexible to deal with the dynamic nature of job shops [19].

**PROBLEM DEFINITION**

In this paper the main aim is to investigate the impact of changes in schedules on decreasing of total cost and cost-time investment. In other words the cost dimension is included of scheduling which depends on beginning time of jobs and how long they are performing. Mapping of the value stream and job scheduling have goals also to decrease lead time and production cost as well as to increase customer value. Cost-time profile has aim to show cost accumulation during the time therefore this tool is used to simulate different scenarios after implementation of different schedules.

In the beginning the 10 data sets are generated for a business job consisting of five machines and seven business jobs in each data set. All 10 variants were examined and the results were similar and therefore in this paper is presented one representative sample as it shown in Table 1. Rows in the right columns contain the order of the operations for each job: each entry contains the index of machine and the processing time on it.

**Table 1.** Data about cost-time profile components

Jobs	Release date	Due date	Machines/Processing times
A	0	39	1/7 2/6 3/8 4/9 5/4
B	0	42	2/3 1/8 5/3 3/8 4/9
C	0	41	3/3 2/7 1/7 5/9 4/7
D	0	41	2/3 1/4 3/9 4/3 5/3
E	0	36	2/5 3/4 5/4 4/2 1/7
F	0	40	2/9 1/2 3/8 4/9 5/6
G	0	38	5/9 2/9 4/6 3/2 1/3

In the analysis very tight due dates are used to reflect the differences better. Due dates are related to the total work content.

These inputs are used to calculate the beginning and the end time for each of these 7 business jobs. Three dispatching rules are applied:

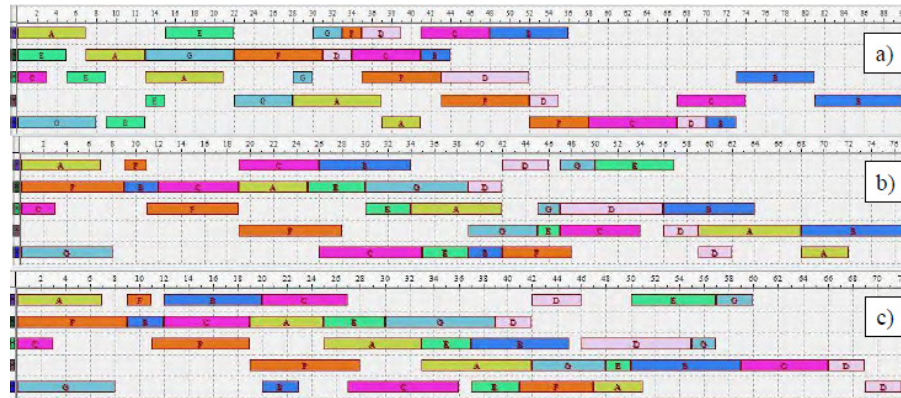
1. Earliest Due Date,
2. Critical Ratio,
3. Minimum Slack First.

Lekin scheduling system is used in this stage of research to construct the schedules. Table 2 presents the scheduling results.

**Table 2.** Output data from Lekin software

Jobs	Dispatchingrules		
	I	II	III
	Start - End	Start - End	Start - End
A	0 - 41	0 - 72	0 - 51
B	41 - 90	9 - 77	9 - 59
C	0 - 74	0 - 54	0 - 66
D	31 - 70	39 - 62	39 - 72
E	0 - 22	25 - 57	25 - 57
F	22 - 58	0 - 48	0 - 47
G	0 - 33	0 - 50	0 - 69

To visualize schedule and show how different rules cause different lead time, Gantt charts are presented for above mentioned dispatching rules (Figure 3(a-c)); rows show the utilization of machines 1 to 5). Table 3 presents the summary of the various performance measures of the schedules.



**Figure 3.** Grantt charts for applied rules: (a) rule I, (b) rule II and (c) rule III

**Table 3.** Output data from Lekin software

Rule	Makespan	Maximum tardiness	Total number of tardy jobs
I	90	48	5
II	77	35	7
III	72	31	7

The next step is calculating and simulating the cost-time profiles and cost-time investments under different conditions defined by the schedules. Cost-Time Profiler software is used for this purpose for data capture, calculations and graphic output. Other

relevant data are assigned such as material cost and labor cost for each job.

Data obtained from Lekin software for the dispatching rules are used for determination of start time and processing time for each job. The primary goal is to prove that scheduling has certain impact on investment. Results of performing calculation and cost-time profile simulation are presented in the next four Figures 4-6.

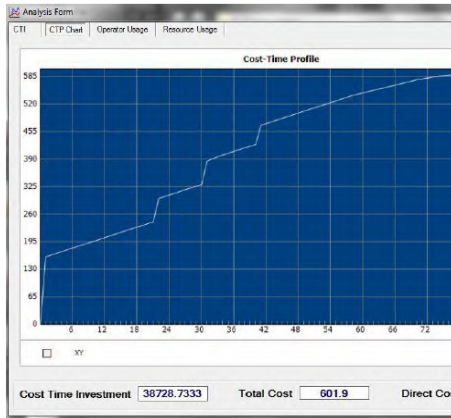


Figure 4. Cost-time profile for the dispatching rule I

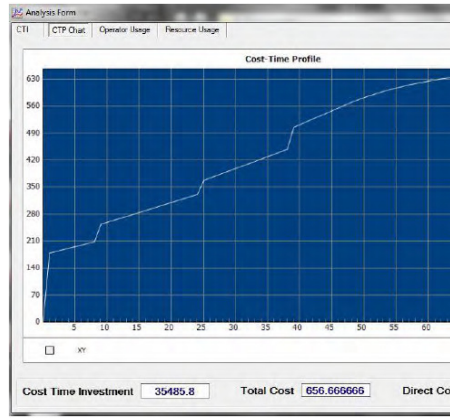


Figure 5. Cost-time profile for the dispatching rule II

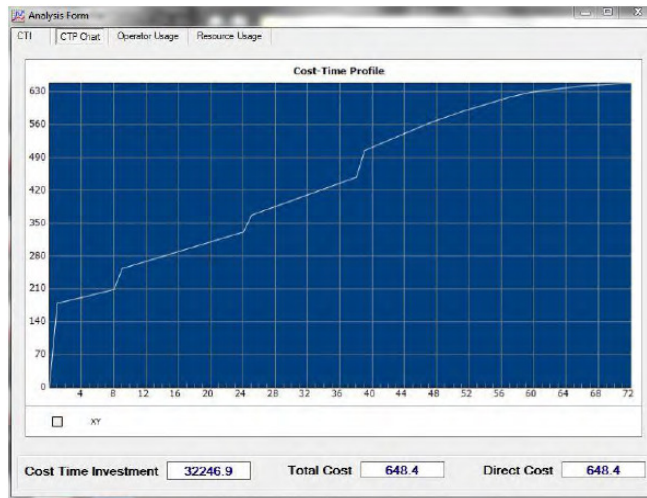


Figure 6. Cost-time profile for the dispatching rule III

## CONCLUSION

Generally, tools for the cost-time profile, as well as lean accounting in general, have not been widespread and widely accepted yet by companies, so popularization and proving of their importance are still a big challenge. Modern companies should be value oriented and implement those manufacturing and business strategies that organize production in such a way that creates company.

This paper is focused on proving that scheduling has essential influence on changes of cost-time investment. Original contribution of the paper is also the suggestion of an additional scheduling performance measure in software solutions.

## REFERENCES

1. Pan, G., Feng, D., Jiang, M., 2010, *Application research of shortening delivery time through value stream mapping analysis*, Proceedings of the 17th International Conference on Industrial Engineering and Engineering Management (IE&EM 2010), pp. 733-736.
2. Deif, A.M., 2011, *A System Model for Green Manufacturing*, Advances in Production Engineering & Management, 6(1), pp. 27-36.
3. Edtmayr, T., Kuhlang, P., Sihn, W., 2011, *Methodical Approach to Designing Workplaces and Increasing Productivity Based on Value Stream Mapping and Methods-Time Measurement*, Transactions of FAMENA, 35(1), pp. 91-99.
4. Duhovnik, J., Zargi, U., Kusar, J., Starbek, M., 2009, *Project-driven concurrent product development*, Concurrent Engineering – Research and Applications, 17(3), pp. 225-236.
5. Dolsak, B., Novak, M., 2011, *Intelligent decision support for structural design analysis*, Advanced Engineering Informatics, 25(2), pp. 330-340.
6. Shah, R., Ward, P.T., 2003, *Lean manufacturing: context, practice bundles, and performance*, Journal of Operations Management, 21(2), pp. 129-149.
7. Wilson, L., 2010, *How to implement lean manufacturing*, McGraw-Hill, New York.
8. Ohno, T., 1988, *Toyota production system – Beyond Large-Scale Production*, Productivity Press, Portland
9. Womack, J.P., Jones, D.T., Roos, D., 2007, *The Machine That Changed the World*, (Reprinted edition), Free Press, New York; Simon and Schuster, London
10. Maskell, B.H., Kennedy, F.A., 2007, *Why do we need lean accounting and how does it work?*, The Journal of Corporate Accounting & Finance, 18(3), pp. 59-73.
11. Sobczyk, T., Koch, T., 2008, *Method for Measuring Operational and Financial Performance of a Production Value Stream*, Lean Business Systems and Beyond, IFIP International Federation for Information Processing, 257(1), pp. 151-163.
12. Kaplan, R.S., 1983, *Manufacturing Performance: A New Challenge for Managerial Accounting*, The Accounting Review, 58(4), pp. 686-705.
12. Maskell, B.H., Baggaley, B., Grasso, L., 2011, *Practical Lean Accounting: A Proven System for Measuring and Managing the Lean Enterprise*, CRC Press – Taylor & Francis Group, Boca Raton.
14. Fooks, J.H., 1993, *Profiles for performance – Total Quality Methods for Reducing Cycle Time*, Addison-Wesley Publishing Company, Reading.



15. Rivera, L., 2006, *Inter-Enterprise Cost-Time Profiling*, PhD Dissertation, Virginia Polytechnic Institute and State University, Blacksburg.
16. Chaudhari, G., 2007, *Cost-time profile as a tool in value engineering*, *Value World*, 30(1), pp. 1-8.
17. Lestan, Z., Brezocnik, M., Buchmeister, B., Brezovnik, S., Balic, J., 2009, *Solving the job-shop scheduling problem with a simple genetic algorithm*, *International Journal of Simulation Modelling*, 8(4), pp. 197-205.
18. Gen, M., Tsujimura, Y., Kubota, E., 1994, *Solving job-shop scheduling problems by genetic algorithm*, *Proceedings of the IEEE International Conference on Humans, Information and Technology*, 2, pp. 1577-1582.
19. Alves, T., Tommelein, I., Ballard, G., 2005, *Value Stream Mapping for Make-to-Order Products in a Job Shop Environment*, *Construction Research Congress*, 2005(1), pp. 1-10.



## HOW TO INTEGRATE STANDARDIZED MANAGEMENT SYSTEMS

Velimir Komadinic\*, S. Manasijevic, R. Radisa

LOLA Institute, Belgrade, SERBIA

\*[velimir.komadinic@li.rs](mailto:velimir.komadinic@li.rs)

### ABSTRACT

There is a number of standards issued by the International Organization for Standardization in a structured and formal way (ISO standards) for the various management systems that can be applied in the organization. Organizations that decided to implement these standards are faced with following questions: what standards to introduce, in which order, when to start the implementation, how to implement the chosen standards - individually or simultaneously and of course the most difficult question - how to combine them together into one integrated management system? The aim of this paper is to consider the stated questions and possibly answer to some of them.

**Key words:** management system, standard, integration, ISO.

### INTRODUCTION

Companies that want to implement management systems in accordance with the requirements of ISO standards do it for various reasons. When it comes to the quality management system the reason they do it is the pressure of customers, or for a more favorable position in the market. Environmental management system is introduced to reduce costs, a system of safety and health at work is introduced due to legal requirements that must be fulfilled. In our country, for companies engaged in services, the key reason for the introduction of these systems is a better position in the public tender (higher score). In doing so, the order of introducing certain standards in management systems is the following: the quality management system (ISO 9001), a control of environment management system (ISO 14001), and safety and health management system (OHSAS 18001). Companies can adopt multiple management systems (based on the standards of the management system) at the same time, which can have certain complications as a result. If one accepts this kind of separate (one per one) introduction of management systems can lead to a complex administration, particular and at the same time conflicting procedures and guidelines, and ultimately to additional costs. Also, this approach may lead to the problem of the limits of the system, competence, authority and responsibility. The positive side of this approach can be seen (if the systems are introduced one at a time) in a relatively easier overcoming of the

problems in the implementation, faster check-up results and smaller earthquakes in the company.

To avoid disadvantages of the implementation of separate management systems, reduce costs and pursue organizational efficiency and effectiveness, a better approach might be an integrated system (IMS - Integrated Management System), which contains various management systems. The aim of adopting IMS must be fulfilling the needs of the organization in a simple and effective way. Table 1. provides an overview of possible benefits of IMS.

**Table 1.** Potential benefits of EMS.

<b>Benefits</b>	<b>Explanation</b>
Costs	Avoiding duplication in the system for audit, document management, etc.
operational benefits	Ensures that all consequences of any action are taken into account
Management benefits	The special "empire" for quality, environment and health and safety are avoided
	Involving employees in different processes leads to teamwork and a positive identification with the goals of the organization in a way that can not be achieved by other means.
Strategic benefits	The acceptance of future management system standards will be easier and cheaper. All systems are seen as parts of a single management system that contributes to the improvement of the organization.
	Stakeholders (including insurance companies) may request a re-insurance which the integrated system provides
	Emphasizes the unity of purpose of all employees, rather than individual goals, which contributes to team approach and teamwork

### **LEVELS OF INTEGRATION**

IMS can not be implemented by making different management systems compiled into one set (in a single manual). Integration must be carefully planned and implemented in a balanced mode. A well-planned IMS can significantly improve process management and an overall performance, reducing risk and responsibility for nonconformities that occur over time. Planning is the basis for the design and implementation of the so called "umbrella" system for quality, environment and health and safety.

A list of what the organization (the company) must do (the previous demands) and decisions that must be made with the aim of introducing IMS are given in Table 2.

**Table 2.** Previous requirements for IMS

Previous requirements	Processes
An organization should have:	The organization has to define:
An overview of the overall business from the standpoint of IMS	The choice of a single IMS model. Many organizations have developed a quality system that literally follows the clauses given in the standard.
Revision of the adequacy of the existing business organization and future needs for each management system.	How to keep the integrity of the existing system while developing the new system
Identification of key elements of each system that must be maintained and of appropriate levels of details that are applicable to each system	If you need a pilot system IMS
Definition of phase and extent of integration	The phase of implementation plan, control points and individual responsibility
Extensive consultations in organization	Appropriate training and analysis of training
The enthusiasm and support of top management	Permanent program employees commitment
Studies of recommendations of any specific industry standards and should consider the needs of external cooperation	
Established the measurable characteristics that are used for monitoring and evaluation of efficiency	

Renzi and Cappelli [6] studied the standards ISO 9001 and ISO 14001 and concluded that the potential level of integration depends on the organizational level. The maximum level of integration is on the top management (integrated strategy), lower level on the middle management level (specific technical requirements leading to differences), and a minimum level of integration on the operational (executive) level.

The integration of a management system can be done in two ways:

1. "A adjusted approach" - integration based on standard similarities. This approach leads to a reduction of administrative costs and the audits and can be adopted especially from the point of certification.
2. TQM (Total Quality Management System) access: a more holistic approach that leads to full integration of all relevant procedures and guidelines, focusing on employees, customers and the concept of continuous improvement.

Jorgensen et al [2] have formulated three levels of integration (Table 3):

1. „Integration as accordance“ between different standards (eg, ISO 9001, ISO14001, OHSAS18001) with a description of interconnections and possible common rules of procedure.

2. "The integration as coordination“, based on a common understanding of general management aspects (policy, planning, implementation, corrective actions, the review - the so-called PDCA cycle) and general (common) processes (top management, commitment, definition of policies, planning goals, procedures, audits, document and records management, management of nonconformities, corrective and preventive actions, management review).
3. "Integration as a strategic and natural approach" which includes the organizational culture of learning, continuous improvement of performance and involvement of stakeholders (interested parties) in relation to the internal and external challenges.

**Table 3.** Three levels of management system integration

Integration as	Focus is on	Answers the problems related to	Complementary solutions / Aspects
1. Accordance	System aspects	Bureaucracy, duplication of effort and confusion between different standards	Active participation of employees
2. Coordination	Process coordination	Management tasks and projects through different functional units and departments	Matrix organization, project teams
3. Strategic and natural approach	Organizational maturity and relations with stakeholders	Encouraging continuous improvement and contribution to sustainable development	Management commitment, motivation and participation of employees, changing routines and traditions, etc.

This approach "Integration as coordination" is based on the general aspects of management and processes. General aspects of management can form the main elements of a framework for IMS. General elements of the framework are given in the table below, Table 4. along with the phases of the PDCA cycle (Deming, 1982) – indicating the continuous improvement which is characteristic for this approach. The elements in Table 5. correspond to the elements that can also be found in ISO 9001, ISO 14001 and OHSAS 18001.

**Table 4.** The main elements of a framework for IMS

General management requirements	PDCA phase
1. Policy	Planning (Plan)
2. Planning	
3. Implementation and operation	Execution (Do)
4. Performance assessment	Controlling (Chek)
5. Improvement	
6. Management review	Corrective actions (Act)

There are seven basic elements for effective IMS, which are a little different from the ones mentioned above. They are [1]:

1. Policy, leadership and responsibility,
2. Organizational infrastructure
3. Strategic planning,
4. Management,
5. Customers, contractors and suppliers (interested parties),
6. Monitoring (measuring) performance,
7. Continuous improvement.

Sets up a series of questions that can be used for deeper analysis, with the aim of determining the status of implementation of the current system in the spectrum of full implementation of the IMS. This analysis is categorized into four stages of progressive improvements (developing phase, middle phase, mature and advanced phase) [1]. Comparative benefits can be achieved if the organization combines a new focus on customers in the quality system with a focus on products in the environmental management system. This can lead to synergies between the quality systems and environmental protection systems (as well as social, safety and health aspects), as well as increased focus on continuous improvement and innovation of products, compared with the traditional focus on the production process. Besides, this also includes the challenges related to the increased attention on other systems in the production chain, which also correspond to similar attention in the field of corporate social responsibility [2].

#### **A UNIQUE IMS STANDARD**

Some experts believe that the creation of a unique standard for the integrated (comprehensive) management system is impractical [7]. Constant changes and new standards could make it continually outdated. Also, not all contents are necessary and relevant to individual organizations.

On the other hand, there is an belief that IMS standard, including different areas of responsibility in the organization and their related interest parties, may be the next step for ISO to develop it [2]. Considering the interests of the company from the standpoint of integration and existence of several national initiatives for the development of standards for IMS, they hoped that there was a prolific area for such an ISO standard.

This however was not the ISO standard, but the BSI has issued a PAS 99: 2006 (Publicly Available Specification) that specifies common requirements for management systems, which can be used as a framework for the integrated management system. PAS 99 takes into account six common requirements for management systems standards (policy, planning, implementation and operation, performance evaluation, improvement and management review), and also follows the PDCA approach in all main requirements of the standard for management systems.

## CONCLUSION

The introduction of management systems in accordance with the requirements of ISO standards in today's business environment is ultimate. As there is no ISO standard for integrated management system, the key question is how to implement the existing (individual or group) and how to integrate them. There are some differences in theoretical as well as the practical approach. This paper presents, in broad outline, the similarities and differences in the theoretical approach of different experts. The authors, based on their experience, propose a specific implementation of management systems and in the following order: ISO 9001, ISO 14001, OHSAS 18001, ecc. The basis for integration is, therefore, a quality management system based on the model ISO 9001. Such access simplifies the implementation of the system, with fewer earthquakes in the company, it quickly leads to visible results and lays the foundation for other management systems based on ISO standards.

## REFERENCES

1. Hansen M.D., Management Systems: Integrating safety, health, environmental and quality programs, *Professional Safety*, Vol. 51., No. 10, pp.34-41, October, 2006.
2. Jorgensen T.H., Remmen A., Mellado M.D., Integrated management systems: three diferenet levels of integration, *Journal of Cleaner Production*, Vol. 14, No. 8, pp. 713-722. 2006.
3. Wilkinson G., Dale B.G., An examination of the ISO 9001:2000 standard and its influence on the integration of management systems, *Production Planning&Control*, Vol. 13, No. 3, pp. 284-297, 2002.
4. Kamp A., LeBansch K., Integrating management of OHS and the environment – participation, prevention and control, *Systematic Occupational Health and Safety Management, Perspectives on an International Development*, Pergamon, Amsterdam, 2000.
5. Nielsen K., Organisation theories implicit in various approaches to OHS management, *Systematic Occupational Health and Safety Management, Perspectives on an International Development*, Pergamon, Amsterdam, 2000.
6. Renzi M.F., Cappelli L., Integration between ISO 9000 and ISO 14000 opportunities and limits, *Total Quality Management*, , Vol. 11, No. 4-5-6, pp. 849-856, 2000.
7. Smith D., *IMS: Implementing and Operating*, British Standards Institution, IMS Risk Solutions, 2002.
8. Komadinić V., Koprivica N., Radonjić N., *Integrated management system – Manual and procedures*, Construction company „JUGOGRADNJA“, Belgrade, 2011.
9. Komadinić V., Stojanović D., *Integrated management system – Manual and procedures*, „PET-PROM“, Belgrade, 2015.



## EXPLOSION GASES AFTER BLASTING IN OPEN PIT MINE

Samir Nuric<sup>1\*</sup>, A. Nuric<sup>1</sup>, K. Gutic<sup>1</sup>, M. Brcaninovic<sup>1</sup>, H. Husic<sup>2</sup>

<sup>1</sup>University of Tuzla, Faculty of mining, geology and civil engineering,  
Tuzla, BOSNIA AND HERZEGOVINA

<sup>2</sup>Brown coal mine Banovici, Banovici, BOSNIA AND HERZEGOVINA

\**samir.nuric@untz.ba*

### ABSTRACT

Discontinuous technology of exploitation applies at open pit mines Banovici for digging and loading waste materials and coal. It implies prior preparation of rock masses, performing of drilling and blasting. Currently, work on the exploitation carried out in the immediate vicinity inhabited places. Special attention is paid to the selection of the parameters of drilling and blasting with which the negative effects of blasting (such as ground vibration, airblast and noise, flying rocks, the occurrence of harmful gases, etc.) kept to a minimum. In this sense, on this site are performed numerous experimental blasting.

**Key words:** mining, blasting, detonation, explosion gases, environmental effects.

### INTRODUCTION

Exploitation of coal in the coal mine "Banovici" is performed in two production organizational units "Surface mining" and "Underground mining". As part of the surface exploitation there are two active open pit mines "Turija" and "Grivice". The development of mining operations in both open pit mines are in direction of built-up areas, because of that we can expect more severe and negative impact of exploitation on the inhabited areas. In addition to the inevitable impacts, ie environmental effects (ground vibration regarding seismic waves, noise, airblast, flyrock) these areas are exposed to the influence of other phenomena as post-blast toxic gasses are referred to as post-detonation fumes or simply 'fumes'. This work will be focused on exploring of appearing post-detonation fumes.





**Figure 1.** The position of the front of mining operations on the pit mine "Grivice" with marked direction of advancement

### **DESCRIPTION OF TECHNOLOGIC PROCESS**

The system of open pit mining represents sequence execution of works in waste, ore, and other (extra) processes with ensuring designed capacity of the open pit mine. At the open pit mines Banovici apply longitudinal single wing systems of exploitation with deepening by immediate roof of coal seam. Exploitation is carried out by following work processes: drilling, blasting, digging and loading, and transport waste materials and coal, as well as the disposal of overburden. The coal crushed and then transported by rail to the separation for further treatment. For exploitation in the open pit mines used traditional discontinuous complex, which includes shovels (electric and hydraulic, draglines) and dumper trucks.

### **DRILLING AND BLASTING**

Drilling boreholes performed with chess and square arrangement of boreholes depending on the "quality" of rock material. For solid rock used chess schedule for plastic marls used square arrangement of drilling of bore holes. For drilling of overburden with ejection of material from the borehole is applied drilling equipment on the compressed air with diameter boreholes 110-120 mm. The removal of material from the borehole on coal and overburden is performed drill sets with spiral rods with a diameter 110-118 mm. The depth of bore holes is up to 15.5 m. Since surface mines in Banovici projected bench with work slope of  $70^\circ$ , it is also boreholes for blasting waste materials and coal drilled at the same angle, parallel to the slope bench. Blasting of rock masses is carried out in the form of loose material, while shooting down applies only

exceptionally in cases where bench height exceeds limit height digging of shovels or if shipping is done using the loader. Blasting overburden is performed in an open block whose width depends on the loading unit. Two ways of blasting, currently and with delay is applied. Mobile manufacturing units has been provided mechanized filling of bore holes with ANFO in dry, and emulsion explosives in wet bore holes, since 2009. Filling in wet drilling hole has been continuous, in circumstances where it is necessary and feasible discontinuous filling used.

### CHARACTERISTICS OF EXPLOSIVES

The most important characteristics of explosives for concrete practical application are density and oxygen balance. Velocity of detonation is designed according to the type of marl to be mine (clay marl, calcareous marl) combining explosives correspondingly (Table 1).

**Table 1.** Properties of ANFO and emulsion explosives

Characteristics	Unit	ANFO	Emulsion
Density	kg/l	0,852	1,256
The volume of gas	l/kg	1039	1039
Velocity of detonation	m/s	3300-3650	5100-5600
Oxygen balance	%	balanced	balanced
Energy of explosion	kJ/kg	3784	3315
Temperature of explosion	°C	2257	2030

The importance of density and oxygen balance explosives is reflected in the fact that depending on the method of mining, their disorder in mine slopes before detonating impact on transformation of other products of detonation (detonation velocity, the energy of the explosion, gaseous products of explosion). For this reason it is very important to determine the optimal way of mining, but in this particular case comes down to the determination of rational deceleration and quantity of explosives per stage ignition.

### THE COMPOSITION AND PROPERTIES OF GASES AS PRODUCTS OF EXPLOSION

Lack of oxygen in the explosion would lead to low and slow release energy, lower temperature and lower pressure. This could also lead to the formation of toxic products such as carbon monoxide (CO). Excess oxygen would lead to extreme sensitivity; release less energy and creating harmful and toxic sodium oxide (N<sub>2</sub>O<sub>5</sub>, N<sub>2</sub>O<sub>3</sub>, NO<sub>2</sub>, N<sub>2</sub>O and NO). There are visual indications whether the release of energy is good or not. The reaction was unsuccessful if the gases are yellow or rust, which can be due to excess oxygen in the mixture. If there is lack of oxygen in the mix creates a dark-gray gases, and often on the walls of the hole leaving carbon. Carbon monoxide is colourless, odourless, and tasteless and does not cause irritation. Oxides of nitrogen usually appear in form of nitrogen dioxide, a reddish-brown gas. Oxides of nitrogen present a greater hazard than CO.

## PARAMETERS OF BLASTING

The parameters of blasting for the specific location are presented through the planned amount of overburden and coal for blasting in 2015 (table 2), the planned consumption of explosives for blasting overburden and coal in 2015 (table 3) and the overview of realized parameters of blasting in 2015 (table 4).

**Table 2.** Planned amounts of overburden and coal for blasting in 2015

Mine	Overburden (m <sup>3</sup> )	Coal (t)	Mass blasting (m <sup>3</sup> )	Secondary blasting (m <sup>3</sup> )
Pit mine Grivice	4 200 000	214 600	4 333 984	4 200
Pit mine Turija	3 960 000	236 060	4 130 899	3 960
Total:	8 160 000	450 660	8 464 883	8 160

**Table 3.** Planned consumption of explosives for blasting overburden and coal in 2015

	Type of rock	Normative	Unit	Mass blasting	Secondary blasting	Unit
Planned quantity for drilling and blasting	Overburden	8 160 000	m <sup>3</sup>	8 151 840	8160	m <sup>3</sup>
	Coal	450 660	t	450 660		t
Explosive	Overburden	0,16265	kg/m <sup>3</sup>	1 325 896	1327	kg
	Coal	0,15956	kg/t	71 907		kg
	Powder	74	%	1 034 374		kg
	Emulsion	24	%	335 472		kg
	Plastic	2	%	27 956	1327	kg
	Total			1 397 802	1327	kg

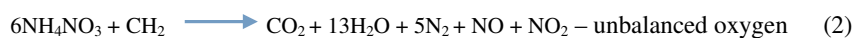
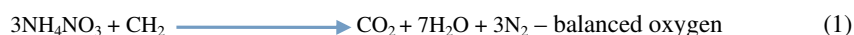
**Table 4.** Realized parameters of blasting works in 2015

Shovel	Loaded coal (t)	Coal (m <sup>3</sup> )	Difference coal (m <sup>3</sup> )	Explosive (kg)	Powder factor (kg/m <sup>3</sup> )	Loaded waste (m <sup>3</sup> )	Waste (m <sup>3</sup> )	Difference waste (m <sup>3</sup> )	Explosive (kg)	Powder factor (kg/m <sup>3</sup> )	Total loaded (m <sup>3</sup> )	Total (m <sup>3</sup> )	Difference total (m <sup>3</sup> )
PH 11	0	0	0	0		0	0	0	0		0	0	0
M 201	5590	0	4581,97	0		2301665	2022207,0	279458,0	507640	0,251	2306246,97	2022207,0	284039,97
LIB-1	318740	0	261262,30	0		2219425	2150584,5	68840,5	406241	0,189	2480687,30	2150584,5	330102,80
Terex 1	56820	0	46573,77	0		1217448	375095,0	842350,0	55227	0,147	1264018,77	375095,0	888923,77
Terex 2	371810	0	304762,30	0		2057265	840015,0	1217250,0	151477	0,180	2362027,30	840015,0	1522012,30
M 5	170680	25236	114665,64	7055	0,28	229090	15488,0	213602,0	3451	0,223	368991,64	40724,0	328267,64
M4	0	0	0,00	0		0	7864,0	-7864,0	2615	0,333	0	7864,0	-7864,00
M2	17330	21216	-7011,08	8068	0,38	46875	0	46875,0	0		61079,92	21216,0	39863,92
LIB-2	270240	0	221508,20	0		2184320	657175,0	1527145,0	115862	0,176	2405828,20	657175,0	1748653,20
EKG2	0	0	0	0		0	0	0	0		0	0	0
EKG-1	0	0	0	0		0	0	0	0		0	0	0
total	1211210	46452	946343,08	15123	0,33	10256085	6068428,5	4187656,5	1242513	0,2048	11248880	6114880,5	5133999,58
Turija	1913009 (m <sup>3</sup> )		31,32%			total	6107016,5 (m <sup>3</sup> )					11248880,08	
Grivice	4194007,5 (m <sup>3</sup> )		68,67%								mined	54,35990477	
Number of blasted fields, Grivice 39, Turija 37, total 76													

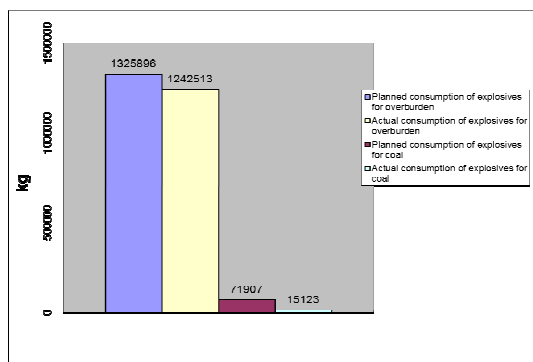
## ANALYSIS OF THE OBSERVATIONS RESULTS

To achieve the planned production, coal mine "Banovici" consumptions significant amounts of explosives. Figures below present the planned and actual consumption of explosives in coal and waste, powder factor as well as planned and realized blasted mass in coal and waste.

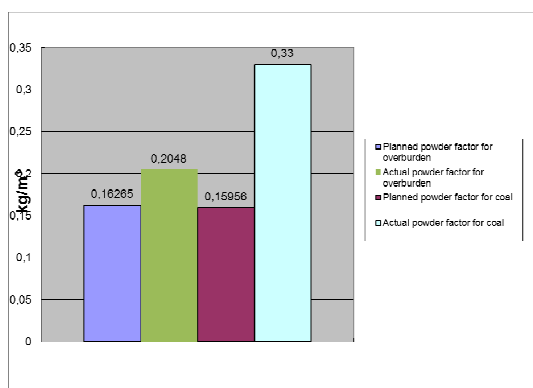
When detonate explosives, despite the ideal recipe manufacture of explosives, there is a phenomenon in drilling hole which distorts the structure of explosives. This distortion is caused by the way of mining, which is caused by measures to protect residential buildings from seismic impact. The measures taken for this purpose, in addition to increasing costs, cause other unwanted effects that usually concomitant with the creation of fumes that are emitted into the atmosphere. There are orange gases (nitrous gases) in these zones (Figure 3a). Theoretically it indicates on unbalanced oxygen in the explosives. Explosive consists of two basic components, fuel (diesel oil) and oxidation (ammonium nitrate).



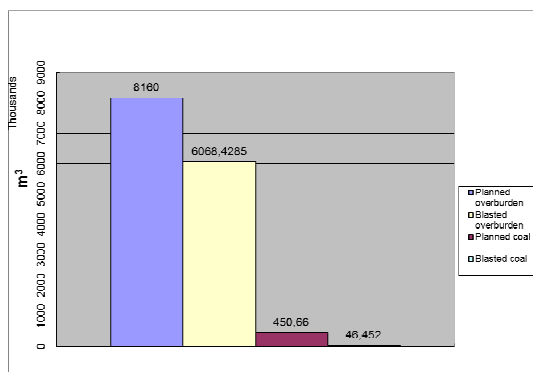
These phenomena necessitate consideration the state of explosives in mine borehole before detonating, and depending on the method of mining. Protection residential buildings from the seismic impact of blasting is mainly confined to reducing activation of explosives (from 150 kg to 300 kg) by millisecond delays and an increase in time of delays between boreholes. This method of mining gave good results in terms of reducing the ground vibrations.



a)



b)



c)

**Figure 2.** a) Planned and consumed explosives b) Planned and achieved powder factor  
c) Planned and consumed blasted mass

When activated one mine borehole it affects neighboring borehole that is not activated. Because of excessive deceleration, causes a physical change (density explosives) and changes in balancing fuel and oxidation components to explosives. It is known that changes in pressure and temperature may influence on change of phase state of hydrocarbons (diesel fuel), and thus to their vaporization. Also, the structure of ammonium nitrate is change with the changing above parameters.



**Figure 3.** The post-detonation fumes a) non-ideal detonation b) ideal detonation

### CONCLUSION

In the vicinity of settlements are carried out blasting in opencast mines "Grivice" and "Turija". The measures, which are applied in order to reduce the seismic impact on housing and other buildings, occasionally cause non-ideal detonation of explosives and unwanted fumes. Experimental blasting that is made indicated that reducing the quantity of explosives per delays and increased interval deceleration reduces the ground vibration. On the other hand such a mode selection of blasting causes the separation of fumes that threaten the environment. Generally gasses resulting from the detonation of explosives are carbon dioxide, nitrogen and steam. Each of these is non-toxic, but varying amounts of toxic or poisonous gasses are also produced the main ones being carbon monoxide and the oxides of nitrogen. In surface mine blasting, fumes are not generally considered dangerous; but it is possible for a hazardous situation to develop in the bottom of a deep pit on calm days. Post-detonation fumes can linger and, if inhaled for period, can cause discomfort or sickness.

### REFERENCES

1. *Safe and Efficient Blasting in Open Cut Mines*, Blasting Courses, Technical Services, Orica, Australia, 2008
2. Kričak L.: *Seizmika miniranja*, Beograd, 2006
3. Kricak L., Negovanovic M., Mitrovic S., Miljanovic I., Nuric S., and Nuric A.: *Development of a fuzzy model for predicting the penetration rate of tricone*

- rotary blasthole drilling in open pit mines*, The Journal of the Southern African Institute of Mining and Metallurgy, Vol. 115, pp. 1065-1071, November 2015
4. Nurić S., Nurić A., Knežiček T., Klopić M., Halilbegović V., Haračić E.: *Ekonomski parametri bušenja i miniranja otkrivke na površinskim kopovima RMU Banovići*, Rudarski radovi 1/2006, Institut za bakar Bor, Bor, 2006
  5. Nurić S., Nurić A., Husić H., Kovačević R., Lačić E.: *Ecological aspects application hydraulic shovel and reduction blasting on the pit mine RMU Banovici*, Proceedings XIX International Scientific and Professional Meeting Ecological Truth, pp. 197-204, Technical faculty at Bor University of Belgrade, Serbia, 2011
  6. Nuric S., Nuric A., Brcaninovic M., Husic H., Lapandic S.: *Ground vibration due blasting at open pit mines Banovici*, XXII International Conference Ecological Truth ECO-IST'14, pp. 175-183, Bor, Technical faculty at Bor University of Belgrade, Serbia, 2014
  7. Husić H., Jalmanović A.: *Uticaj seizmičkih efekata miniranja na površinskim kopovima RMU "Banovići"*, Mineral 02/2011, Zagreb 2011
  8. Project documentation RMU Banovići, d.d. Banovići



## THE CONNECTION BETWEEN ARCTIC OSCILLATION (AO) AND THE FOREST FIRES IN MANITOBA PROVINCE (CANADA)

Milan Milenkovic<sup>1\*</sup>, V. Babic<sup>2</sup>, V. Ducic<sup>3</sup>, M. Krstic<sup>2</sup>, B. Lazic<sup>3</sup>

<sup>1</sup>Geographical Institute »Jovan Cvijić«, Serbian Academy of Sciences and Arts,  
Belgrade, SERBIA

<sup>2</sup>University of Belgrade, Faculty of Forestry, Belgrade, SERBIA

<sup>3</sup>University of Belgrade, Faculty of Geography, Belgrade, SERBIA

\*[m.milenkovic@gi.sanu.ac.rs](mailto:m.milenkovic@gi.sanu.ac.rs)

### ABSTRACT

A downward trend of the annual number of forest fires and upward trends of the annual burned area and the average burned area per fire were recorded in Manitoba in the period 1970-2014. Pearson's correlation coefficient (R) was used in the research of the connection between Arctic oscillation (AO) and forest fires. The values of R significant at  $p \leq 0.01$  were recorded for the annual burned area and summer AO (0.425) and July AO (0.402), as well as for the average burned area per fire and summer AO (0.445).

**Key words:** forest fires, Arctic Oscillation, Manitoba, Canada.

### INTRODUCTION

The Manitoba Province is situated in the longitudinal center of Canada. It covers an area of 649,950 km<sup>2</sup>, and at 2011 census had the population of 1,208,268 (density 2.2/km<sup>2</sup>) [1]. More than half of the province population lives in the capital city of Winnipeg. Forests cover about 48% of the province territory. The forest types are: Boreal forest, Broadleaf/mixed forests and Small broadleaf forest stands. The most common conifers are jack pine (*Pinus banksiana* Lamb.), black spruce (*Picea glauca* (Moench) Voss) and white spruce (*Picea mariana* (Mill.) Britton, Sterns & Poggenb.), and the most common deciduous tree species are poplars and aspens (*Populus* spp.), white birch (*Betula papyrifera* Marshall) and swamp birch (*Betula pumila* L.) [2]. Great share of conifers significantly contributes to the forest fire danger. The main fire season is April to October, and the annual number of fires and the annual burned area vary significantly. Extreme fire season was in 1989, when the weather conditions were exceptionally suitable for the spread of fire: high air temperature, prolonged drought and strong winds. During the season 24,500 people were evacuated (about 2.2% of the province population), and the burned area was over 3,280,000 ha (more than the territory of the Kingdom of Belgium) [3]. Besides weather conditions, the link between teleconnections and forest fires have also been researched. Teleconnections are defined



as impacts of distant climate phenomena on the climate of a region, and the distances are measured in thousands of kilometers. Great part of research in this scientific field refers to certain parts of the USA [4-7]. As regards Canada, the connection between the fires in British Columbia and Niño3.4, Pacific Decadal Oscillation (PDO) and Arctic Oscillation (AO) with 1-2 year phase shift was determined [8]. The research of this type could be used as the basis for long-term forest fire forecasting. The main goal of our research was to determine the impact of the AO on forest fires in the central part of Canada.

## MATERIAL AND METHODS

Monthly, seasonal and annual values of AO index were used in the research. AO index is calculated on the basis of the differences in air pressure between 45°N (high) and over Arctic (low). AO has a positive phase and a negative phase. The positive phase in North America is a warm phase. The AO data were downloaded from Climate Prediction Center, National Weather Service, National Oceanic and Atmospheric Administration, U.S. Department of Commerce [9].

The data on forest fires in Manitoba were downloaded from National Forestry Database, Canadian Forest Service [10] and refers to the period 1970-2014. The following data were used:

- Total annual number of fires (N)
- Total annual burned area (P)
- Average burned area per fire (P/N)

Pearson correlation coefficient (R) based on the linear trend was used for the calculation of correlation, and statistical significance was tested at  $p \leq 0.05$  and  $p \leq 0.01$ . Monthly, seasonal and annual AO values were used in the calculations. One year phase shift was also performed, e.g. AO values from previous year were used. Data for the period September to December for the same year weren't used in the calculation, since the main fire season in Manitoba ends in September.

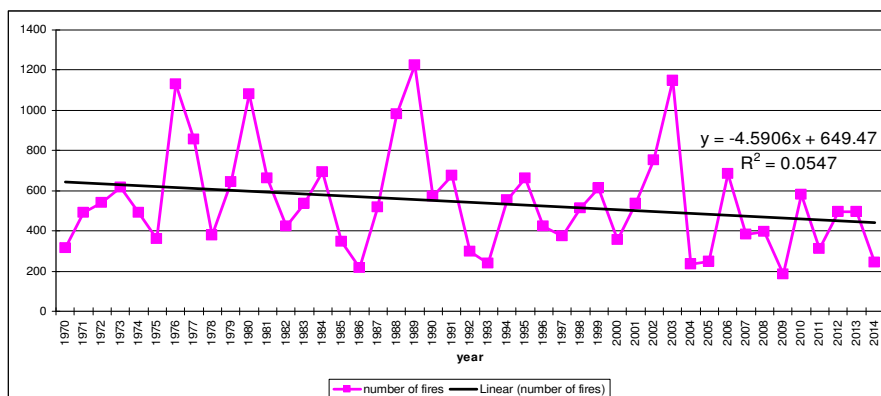
Statistical significance of linear trend was determined for  $n-2$  and on the basis of the coefficient of determination ( $R^2$ , attached to the charts). For the testing of the significance of linear trend t test was used:

$$t = R \sqrt{\frac{n-2}{1-R^2}} \quad (1)$$

where  $R^2$  - the coefficient of determination;  $n$  - the length of the series.

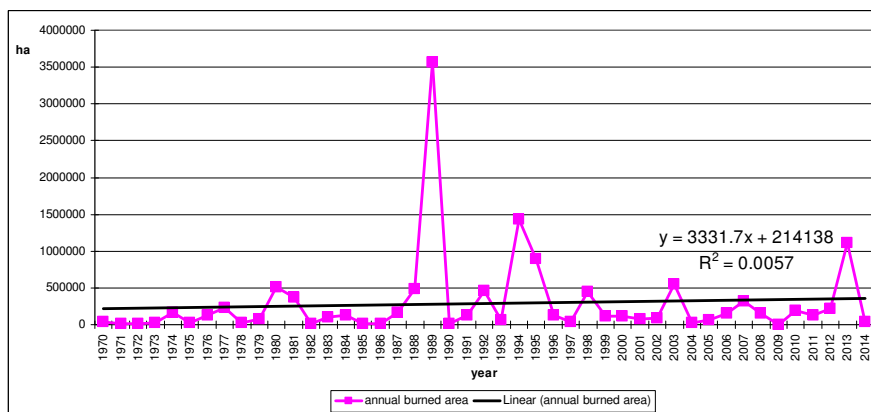
## RESULTS

A decreasing trend in the annual number of forest fires was recorded in Manitoba in the period 1970-2014 (Figure 1). On the basis of table values it was determined that the trend is not statistically significant at  $p \leq 0.05$ .



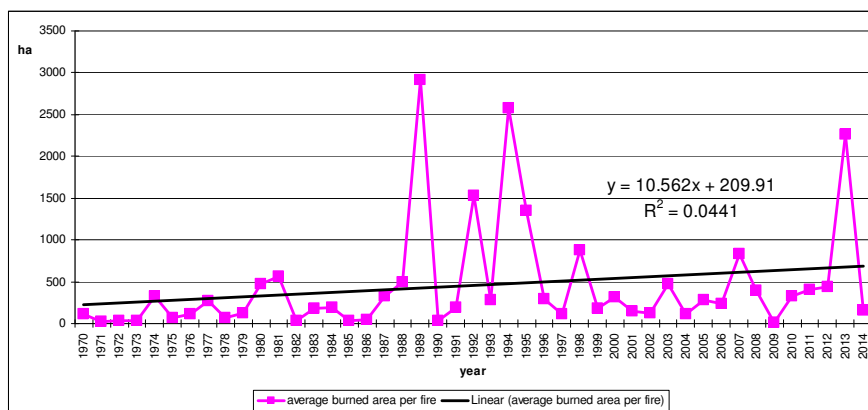
**Figure 1.** The annual number of forest fires in Manitoba (1970-2014) [10] with the trend line

In the same period an increasing trend in the total annual burned area was also noted (Figure 2). On the basis of table values it was determined that the trend is not statistically significant at  $p \leq 0.05$ .



**Figure 2.** The annual burned area in Manitoba (1970-2014) [10] with the trend line

The average burned area per fire also had an increasing trend in the period 1970-2014 (Figure 3). On the basis of table values it was determined that the trend is not statistically significant at  $p \leq 0.05$ .



**Figure 3.** The average burned area per fire in Manitoba (1970-2014) [10] with the trend line

Table 1 shows the results of the research of the correlation between AO and the forest fires in Manitoba (1970-2014).

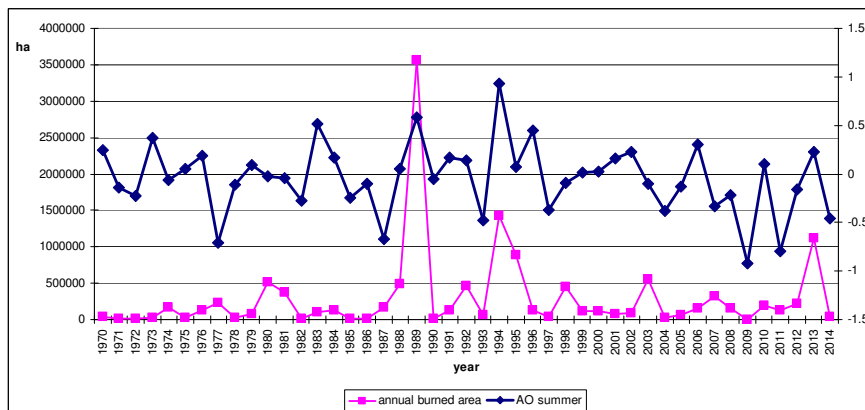
**Table 1.** Pearson correlation coefficient (R): AMO – forest fires in Manitoba in the period 1970-2014 (N – the number of fires, P – annual burned area, P/N – average annual burned area per fire)

AO – monthly values												
	Jan	Feb	Mar	Apr	May	Jun	Jul	Aug	Sep	Oct	Nov	Dec
N	0.021	0.224	-0.054	-0.112	0.032	0.325*	0.273	0.157	-	-	-	-
P	0.254	0.299*	0.132	-0.133	0.149	0.229	0.402**	0.277	-	-	-	-
P/N	0.191	0.210	0.086	-0.132	0.157	0.245	0.366*	0.326*	-	-	-	-
AO – seasonal and annual values												
	Winter			Spring		Summer		Autumn		Annual		
N	0.105			-0.071		0.371*		-		0.079		
P	0.304*			0.087		0.425**		-		0.366*		
P/N	0.234			0.059		0.445**		-		0.339*		
AO – monthly values (phase shift – 1 year)												
	Jan	Feb	Mar	Apr	May	Jun	Jul	Aug	Sep	Oct	Nov	Dec
N	0.173	0.107	0.071	0.020	-0.103	0.122	-0.034	0.069	0.239	-0.132	-0.102	-0.003
P	0.167	-0.029	0.115	-0.142	-0.312*	0.027	-0.050	0.060	0.276	-0.195	0.017	0.155
P/N	0.235	-0.013	0.180	-0.115	-0.317*	-0.025	-0.065	0.076	0.232	-0.300*	0.086	0.145
AO – seasonal and annual values (phase shift – 1 year)												
	Winter			Spring		Summer		Autumn		Annual		
N	0.126			0.019		0.093		-0.039		0.104		
P	0.091			-0.091		0.027		0.017		0.065		
P/N	0.170			-0.038		-0.001		-0.018		0.092		

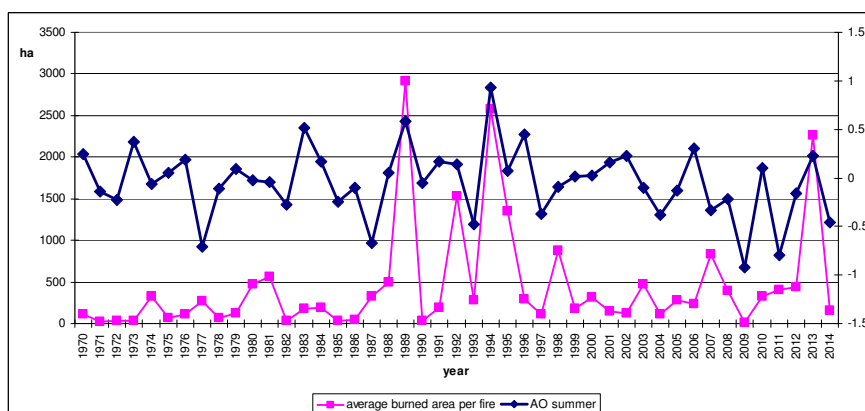
\* significant  $p \leq 0.05$ ; \*\* significant  $p \leq 0.01$

All statistically significant R values for the same year (no phase shift) have a positive sign. For burned area, R values significant at  $p \leq 0.01$  were recorded for summer AO (0.425) (Figure 4) and AO for July (0.402). The highest R value (0.445) was recorded in the case of average annual burned area per fire and summer AO (Figure 5). For the number of fires, R values significant at  $p \leq 0.05$  were recorded only for summer

(0.371) and July (0.325). With one year phase shift statistically significant R values ( $p \leq 0.05$ ) were recorded only for May (P, P/N) and October (P/N). All statistically significant R values recorded in the calculations with phase shift have a negative sign.



**Figure 4.** The annual burned area in Manitoba (1970–2014) [10] and AO values for summer [9]:  $R=0.425$  (significant  $p \leq 0.01$ )



**Figure 5.** The average burned area per fire in Manitoba (1970–2014) [10] and AO values for summer [9]:  $R=0.445$  (significant  $p \leq 0.01$ )

## DISCUSSION

The results of the research point to the existence of the connection between AO and forest fires in Manitoba, primarily annual burned area and average annual burned area per fire. The highest R values were recorded for the summer, which is the main fire season in Manitoba. The results of the research are expected, since the burned areas are larger during the positive (warm) phase of AO. However, the connection is less strong

compared to the connections recorded for fires in the USA and (Atlantic Multidecadal Oscillation) [11] and fires in France and AMO [12]. It is important to emphasize that high values of R were recorded with one year phase shift.

The results also lead to the conclusion that, besides AO, there are some other climate indices which affect forest fires in Manitoba. Thus, detailed climate research studies are necessary for the improvement of the long-term forecast of forest fires. Besides, it should be kept in mind that some teleconnections are under influence of solar wind, e.g. North Atlantic Oscillation (NAO) [13]. It is also confirmed that particles of solar wind cause wildfires in the USA [14-16]. For the previous, the research of climate indices and solar wind parameters are important in the fire forecast.

## CONCLUSION

In the Manitoba Province (Canada), a downward trend of the annual number of forest fires was recorded in the period 1970-2014. Increasing trends were recorded in the case of the annual burned area and the average annual burned area per fire. In the research of the connection between Arctic Oscillation (AO) and the annual burned area, the values of Pearson's correlation coefficient (R) significant at  $p \leq 0.01$  were recorded for summer AO (0.425) and AO for July (0.402). However, a higher value of R (0.445) was recorded for the average annual burned area per fire and summer AO. For the number of fires the highest values of R (significant at  $p \leq 0.05$ ) were recorded for summer (0.371) and July (0.325). All these R values are positive. With one year phase shift the values of R are lower, and they are negatively significant at  $p \leq 0.05$ . The results of the research could be used in the fire forecast in Manitoba only after detailed investigations of other climate indices and solar wind parameters.

## Acknowledgement

*The study is the result of project number 47007 III funded by Ministry of Education, Science and Technological Development of the Republic of Serbia.*

## REFERENCES

1. <http://www12.statcan.ca/census-recensement/2011/dp-pd/hlt-fst/pd-pl/Table-Tableau.cfm?LANG=Eng&T=101&S=50&O=A>
2. <http://web.archive.org/web/20090226181706/http://www.gov.mb.ca/conservation/forestry/forest-education/general.html#broadleaf>
3. Hirsch, K. G., 1991, A chronological overview of the 1989 fire season in Manitoba, *The Forestry Chronicle*, 67(4), 358-365
4. Swetnam, T. W., Batancourt, T. L., 1993, Temporal patterns of El Nino/Southern Oscillation – wildfire teleconnections in the southwestern United States, In: *El Nino: historical and paleoclimatic aspects of the Southern Oscillation*, 259-270

5. Norman, S. P., Taylor, A. H., 2003, Tropical and north Pacific teleconnections influence fire regimes in pine-dominated forests of north-eastern California, USA, *Journal of Biogeography*, 30(7), 1081-1092
6. Sibold, J. S., Veblen, T. T., 2006, Relationships of subalpine forest fires in the Colorado Front Range with interannual and multidecadal-scale climatic variation, *Journal of Biogeography*, 33(5), 833-842
7. Morgan, P., Heyerdahl, E. K., Gibson, C. E., 2008, Multi-season climate synchronized forest fires throughout the 20th century, northern Rockies, USA, *Ecology*, 89(3), 717-728
8. Wang, Y., Flannigan, M., Anderson, K., 2010, Correlations between forest fires in British Columbia, Canada, and sea surface temperature of the Pacific Ocean, *Ecological Modelling*, 221(1), 122-129
9. <http://www.esrl.noaa.gov/psd/data/correlation/ao.data>
10. [http://nfdp.ccfm.org/index\\_e.php](http://nfdp.ccfm.org/index_e.php)
11. Milenković, M., Barović, G., 2015, Atlantic Multidecadal Oscillation (AMO) and the wildfires in the United States of America (in Serbian), 4. Srpski kongres geografa, Zbornik radova, knjiga 1, 137-142
12. [12] Milenković, M., Ducić, V., Burić, D., Lazić, B., 2016, The Atlantic Multidecadal Oscillation and the forest fires in France in the period 1980-2014, *Journal of the Geographical Institute "Jovan Cvijić" SASA*, 66(1), 35-44
13. Boberg, F., Lundstedt, H., 2002, Solar wind variations related to fluctuations of the North Atlantic Oscillation, *Geophysical Research Letters*, 29(15), 13-1-13-4
14. Radovanović, M., Vyklyuk, Y., Jovanović, A., Vuković, D., Milenković, M., Stevančević, M., Matsiuk, N., 2013, Examination of the correlations between forest fires and solar activity using Hurst index, *Journal of the Geographical Institute "Jovan Cvijić" SASA*, 63(3), 23-32
15. Radovanović, M. M., Vyklyk, Y., Malinović-Milićević, B. S., Jakovljević, M. D., Pecelj, R. M., 2014, Modelling of forest fires time evolution in the USA on the basis of long term variations and dynamics of the temperature of the solar wind protons, *Thermal Science*, 19(Suppl. 2), S437-S444.
16. Radovanović, M. M., Vyklyuk, Y., Milenković, M., Vuković, D. B., Matsiuk, N., 2015, Application of adaptive neuro-fuzzy interference system models for prediction of forest fires in the USA on the basis of solar activity, *Thermal Science*, 19(5), 1649-1661



## IMPACT OF REGIONAL SANITARY LANDFIL " VRBAK'' ON GROUNDWATER QUALITY

Merita Borota<sup>1\*</sup>, T. Rakocevic<sup>2</sup>, A. Simic<sup>3</sup>

<sup>1</sup>Ministry of agriculture and environmental protection, Republic directorate for water,  
Belgrade, SERBIA

<sup>2</sup>Public Water Management Enterprise, Belgrade, SERBIA

<sup>3</sup>„ASA EKO“ Vrbak d.o.o, Belgrade, SERBIA

\*merita.borota@minpolj.gov.rs

### ABSTRACT

Depositing waste in sanitary landfills is often linked with a negative impact on the environment, groundwater, surface water and air, if appropriate measures are not properly applied.

This paper analyzes the results of groundwater quality within the landfill "Vrbak", Lapovo, central Serbia, after five years of operation. Results from June 2014 are compared with the identified zero state quality and results from 2013.

The samples originate from the monitoring wells - piezometers P1, P2 and P3. Results indicate that the characterized pollution parameters in groundwater are not exceeded even after five years of operation.

**Key words:** sanitary landfill, underground water, monitoring wells, pollution.

### INTRODUCTION

The scientific-technical progress directly affects the balance of man-nature causing quality alteration of air, soil, water with impacts on human health and the environment. Due to large amounts of waste and its diversity specific problems are created in the protection and prevention of environmental pollution. It can pollute the soil, contaminate water sources (surface or groundwater) and the air through its decomposition products and it also may contaminate foods with which it comes into contact <sup>[1]</sup>.

There are many different ways of waste disposal. The directive related to waste disposal is Council Directive 1999/31/EC of 26 April 1999. The objective of the Directive is to supplement the requirements of the Waste Framework Directive (2006/12/EC). It aims to prevent, or reduce as much negative impact from waste disposal on surface water, groundwater, soil, air and human health as possible <sup>[2]</sup>. It achieves this through specifying universal technical standards at Community level and sets out

requirements for the location, management, engineering, closure and monitoring of landfills<sup>[3]</sup>.

The Directive requires, among other tasks, the monitoring of leachate composition, level of groundwater and groundwater composition<sup>[4]</sup>.

Quality of leachate in landfills has the greatest impact on groundwater quality. Leachate mainly includes a concentration of Zn, Fe, Ni, Pb, Cr, Hg, Mn, Cu and dozens of heavy metal ions<sup>[5]</sup>.

Quality of groundwater is monitored:

- quantitatively: depth (level) of water
- qualitatively: composition and concentration of parameters in the samples.

The following text gives basic information on the landfill and covers its location in relation to hydrogeology. It focuses on the quality of groundwater which is monitored through piezometers.

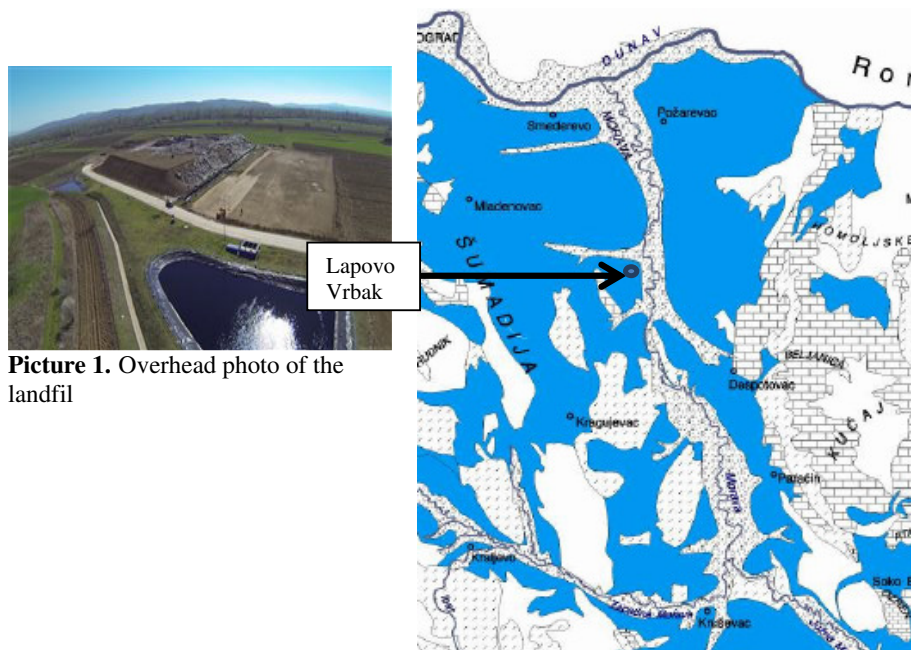
**General information about “Vrbak” landfill:** the regional landfill is situated in municipal Lapovo (central part of Serbia, region named Šumadija) and covers an area of 21,2 hectares. The landfill is designed and built for accomodating urban waste from four municipalities: Rača, Despotovac, Batočina and Lapovo.

The landfill is designed to expand, in phases, to its maximum capacity. Currently, more than 50,000 residents are using the services of the landfill<sup>[6]</sup>. The bottom of the landfill is sloped and isolated with foil. HDPE foil is enhanced by geotextile and is constructed under the gravel drainage.

Leachate which passes through the waste is collected with perforated drainage pipes, transported to the additional manholes and pumped into the reservoir.

Collected waste water from the reservoir returns to the landfill by a pipe system in order to moisturize trash meaning that the polluted waste water is not discharged into the environment.



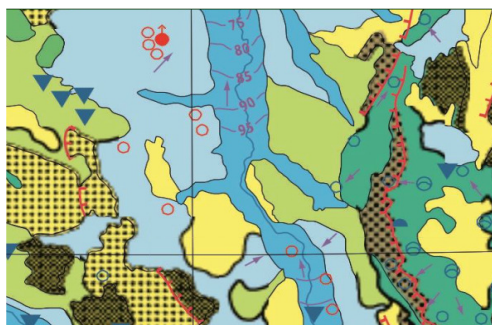


**Picture 1.** Overhead photo of the landfill

**Figure 1.** Hydrogeological map of the central part of Serbia

Picture 1 is taken from the web site of A.S.A Company<sup>[7]</sup>.

Figure 1 shows the position of the municipality of Lapovo and the landfill "Vrbak" in relation to the hydrogeological map<sup>[8]</sup>.



**Figure 2.** Geological Atlas of Serbia 1:2 000 000- Hydrogeological map<sup>[9]</sup>.

Blue colored areas represent alluvial deposits – inter granular porosity. Groundwater is often cheaper, more convenient and less vulnerable to pollution than surface water. Therefore, it is commonly used for public water supplies. Many municipal water supplies are derived solely from groundwater.

Polluted groundwater is more difficult to clean up than polluted rivers and lakes. Groundwater pollution most often results from improper disposal of land wastes. Major sources include industrial and household chemicals, landfills, excessive fertilizers and pesticides used in agriculture, industrial waste lagoons, wastewater from mines, oil field brine pits, leaking underground oil storage tanks and pipelines, sewage sludge and septic systems

## METHODS

Analyses of groundwater quality are carried out by an authorized laboratory in accordance with the domestic regulations<sup>[10]</sup>. Methods for sampling and analyses applied by the laboratory are defined by the scope of accreditation which the laboratory has a Certificate for, issued by the Accreditation Body of Serbia.

Samples are taken from constructed monitoring wells – piezometers.

## RESULTS AND DISCUSSION

Monitoring wells (P1, P2 and P3) were constructed around the perimeter of the landfill with the role to monitor groundwater quality. Before the landfill was put into use, the zero state of pollution parameters was established.

Results showed that the concentration of most parameters exceed the allowed limits defined in legislation which deals with water quality<sup>[11]</sup>. Results of sampled groundwater showed different levels of pollution: the pH value was within normal limits, COD, calcium and nitrates were in rise and nitrites and iron in decline.

Chemical analysis of groundwater in the monitored wider area was characterized by a high content of iron, manganese and ammonia content. Concentration of potassium permanganate was also elevated as well as the presence of certain bacteria, which indicated the presence of organic pollution<sup>[12]</sup>.

Analysis of groundwater quality, five years after the landfill was put to use, showed that groundwater has not been polluted more than recorded on zero state which was established in 2009<sup>[13]</sup>.

**Table 1.** Results of parameters sampled in monitoring well- piezometer P1

parameters	units of measure	2013	2014 June
turbidity	NTU	-	-
pH value		7,13	7,18
COD	MgO <sub>2</sub> /l	26,9	<10
consumption KMnO <sub>4</sub>	mgO <sub>2</sub> /l	0,21	-
ammonia	mgN/l	-	0,22
nitrite	mgN/l	-	0,74
nitrate	mgN/l	<0,04	9,52
chloride	mg/l	46,68	78,3
iron	mg/l	61,72	0,01
manganese	mg/l	-	-
calcium	mg/l	463	139,8
lead	mg/l	-	<2

Piezometer P2 is located on the north side of the reservoir for collecting leachate. It is used to monitor the quality of groundwater for the purpose of early detection of pollution if it happens. There have been no cases of this.

**Table 2.** Results of parameters sampled in monitoring well- piezometer P2

parameters	units of measure	2013	2014 June
turbidity	NTU	-	-
pH value		7,32	7,20
COD	MgO <sub>2</sub> /l	<10	<10
consumption KMnO <sub>4</sub>	mgO <sub>2</sub> /l	0,16	-
ammonia	mgN/l	-	0,42
nitrite	mgN/l	-	0,059
nitrate	mgN/l	<0,04	8,08
chloride	mg/l	62,04	109,6
iron	mg/l	74,24	0,01
manganese	mg/l	-	0,01
calcium	mg/l	2253	176,7
lead	mg/l	-	<2

Results in table 2 showed that the parameters of pH value and COD, and the concentration of iron manganese and calcium were less than recorded in 2013.

**Table 3.** Results of parameters sampled in monitoring well- piezometer P3

parameters	units of measure	2013	2014 June
turbidity	NTU	-	-
pH value		8,01	6,98
COD	MgO <sub>2</sub> /l	<10	<10
consumption KMnO <sub>4</sub>	mgO <sub>2</sub> /l	0,41	-
ammonia	mgN/l	-	0,30
nitrite	mgN/l	-	0,10
nitrate	mgN/l	<0,04	12,39
chloride	mg/l	<0,04	124,8
iron	mg/l	72,56	0,03
manganese	mg/l	-	0,43
calcium	mg/l	1360	118,6
lead	mg/l	-	<2

Results presented in table 3 above are the samples from piezometers P3 which was built on the rim of the lagoon. The lagoon is used to collect waste water from the plateau as well as the surface water from internal traffic roads.

The parameters of pH value and COD, and the concentration of iron manganese and calcium were less than recorded in 2013.

## CONCLUSION

Monitoring wells – piezometers, built around the perimeter of the landfill, are used to monitor groundwater quality of the area. The results indicate that all of the prescribed and all of the appropriate measures with the goal to protect groundwater quality were undertaken in the landfill.

Increased concentration of nitrate can be associated with the dispersion of pollutants and fertilizers used to cultivate the land. Despite the fact that nitrate has increased slightly compared to the zero state, it is still less than the maximum permissible concentration according to the maximum permissible concentration of inorganic substances in drinking water, which allows to 50 mg of nitrate per liter<sup>[14]</sup>.

As far as for the chloride, it is also less than the maximum permissible concentration, which according to the same regulation allows up to 200 mg of chloride per liter.

As for the other measured parameters in June 2014, the results shows that landfill "Vrbak" has no impact on groundwater quality, which is particularly evidenced by the parameters of iron, magnesium and calcium, which are characteristic of leachate wastewater.

Conclusion: the management of the landfill has met its goal - controlled waste water disposal while protecting the environment, in this case the quality of groundwater.

### *Acknowledgement*

*The authors acknowledge the Company "ASA" - Vrbak Ltd. Lapovo, for their generous partnership, ceded results and joint work to preserve and protect the environment.*

## REFERENCES

1. N. Băghină, Study regarding groundwater quality in the Aranca river basin during 2008-2009 period, Research Journal of Agricultural Science, 45 (2), 2013
2. Directive 1999/31/EC of 26 April 1999 on the landfill of waste, OJ L 182, 16.7.1999, Document 31999L0031
3. Environmental Permitting Guidance The Landfill Directive For the Environmental Permitting (England and Wales) Regulations 2010 Updated March 2010 Version 3.1, <http://www.defra.gov.uk/>
4. Shamas, Nazih K., Wang, Lawrence K., Hung, Yung-Tse, Handbook of Environment & Waste Management, 2014
5. Z. Pang, X.J. Li. The Wetland Treatment of Landfill Leachate. Techniques and Equipment for Environmental Pollution Control, Vol.6(2005),p.61-65.
6. Internet portal Lapovo.rs
7. <http://www.fcc-group.eu/sr/Srbija/Tehnologije/Deponovanje-1/Deponija-u->

- Lapovu.html
8. Dragan Kaluđerović, Possibility of artificial recharge of aquifers formed in the neogene basins in Serbia with dual purpose of wells. The Centre for scientific management – [www.advancegwt.com](http://www.advancegwt.com)
  9. <http://geoliss.mre.gov.rs>
  10. Law on Water (Official gazette RS No 30/2010)
  11. Regulation on limit values of pollutants in surface and ground waters and sediments, and the deadlines for their achievements (Official gazette RS No 67/2011, 48/2012)
  12. Dragan Kaluđerović, Example of mathematical representation of a mathematical model of Trnovče - Miloševac-Lozovik in order to determine the exploitation capacity groundwater capacity for water supply purpose for Velika Plana, page no 3, Advanced Environmental Technology – AET  
<http://www.advancegwt.com/images/istrazivanja/11.pdf>,
  13. M. Borota and others, Serbian Society for Water Protection, Proceedings 43 Conference on Water Protection, Water 2014 the influence of regional sanitary landfill " Vrbak 'u Lapovo to surface and underground water
  14. Rulebook on hygienic quality of drinking water, Page IIIa ( "Official gazette SRJ", no. 42/98 and 44/99)



## PRESENCE OF EXCESSIVE ENVIRONMENTAL NOISE – CASE STUDY MUNICIPALITY OF HERCEG NOVI

Aleksandar Nikolic<sup>1\*</sup>, V. Vujacic<sup>2</sup>, E. Nikolic<sup>3</sup>, L. Pezo<sup>4</sup>, T. Brandmajer<sup>5</sup>

<sup>1</sup>Institute for Physical Examination, Montinspekt, 81000, Podgorica,  
Milana Raickovica b.b., MONTENEGRO

<sup>2</sup>University of Montenegro, Faculty of Tourism and Hotel Management,  
Stari grad 320, Kotor, MONTENEGRO

<sup>3</sup>University of Montenegro, Department of physiotherapy, Medicine Faculty,  
81000, Podgorica, MONTENEGRO

<sup>4</sup>University of Belgrade, Institute of General and Physical Chemistry,  
Studentski Trg 12-16, 11000 Belgrade, SERBIA

<sup>5</sup>University of Montenegro, Medicine Faculty, 81000, Podgorica, MONTENEGRO

\*[tipotek@t-com.me](mailto:tipotek@t-com.me)

### ABSTRACT

Sustainable tourism is the basic guideline of development of the Municipality of Herceg Novi. Excessive housing, concentration of population and economic activities in the coastal area of Herceg Novi have led to pollution of the coastal sea area, which has a negative impact on many environmental aspects of this municipality. In this paper, the emphasis is put on issues and causes of excessive communal noise. In order to determine the presence of excessive environmental noise, several experimental measurements were carried out for positions exposed to the effects of different noise sources.

**Key words:** sustainable tourism, sustainable development, environmental protection, environmental noise.

### INTRODUCTION

The relationship between tourism and the environment is complex. Due to the high degree of interdependence between the two concepts, it is referred to as symbiotic (1). In some tourist destinations environment is very changed under the influence of tourism activity. Great anthrop environment leaves a number of negative consequences for nature. Negative impacts arise due to the stay of tourists in tourist destinations and accompanying comfort (2). Healthy environment is rapidly becoming very important value in human life and a criterion of the quality of living. To achieve this target, many of us consider the 'returning to nature' and respecting the ancient laws of nature as the ultimate solution.

Noise sources located in man's environment are defined as environmental noise or communal noise (3). Compared to other environmental factors, there is no understanding of the control of communal noise and it is not considered to be one of the priorities to be addressed in order to protect the environment. As a reason, we indicate insufficient knowledge about the effects of noise on human life, health and the environment, especially when noise exposure lasts for a longer period of time (4,5,6,7). The problem of noise in the Montenegro coastal municipalities is particularly evident during the peak tourist season, as is the case in the Municipality of Herceg Novi (8).

In order to determine the presence of excessive environmental noise as a pollutant, several experimental measurements were carried out in positions exposed to the effects of different sources of noise. Measurements were carried out during the winter and summer season. This paper deals with the problem of pollution on the territory of the Municipality of Herceg Novi, and presents concrete examples of environmental pollution. Proposal of measures necessary for quality protection and sustainability of the Municipality is given, which is of crucial importance for further development of tourism.

## **MATERIALS AND METHODS**

### **Experimental Determination Of The Excessive Noise Presence**

Tourism, in addition to the positive impact has a negative impact on the environment. The negative impact of tourism on the environment can be divided into four categories: water pollution, air pollution, noise and aesthetic pollution (9).

Given the large dispersion of the Municipality of Herceg Novi, four positions that characterize different sources of noise have been selected for carrying out the experiment, located in the part of the town directly by the coast, the most frequently visited during the tourist season.

As the noise sources are recognized: vehicles, motorcycles, boats, ships, swimmers, music program and guests from cafes, climatization outdoor units, and "urban canyons" (two-storey buildings that separates the street which ensures the propagation of sound without significant impairment of energy that otherwise typically decreases when the distance increase in relation to the noise source).

Noise is measured by precision modular analyzer Brüel&Kjaer, model 2250L, that meets the prescribed standard IEC60804. Selecting of measurement interval is observed by Article 6 in the Rulebook of measurement methods and instruments to be met by the organization to measure the noise (10). Under this Ordinance changeable noise levels are measured in three intervals during the day (07h-23h) and two intervals during the night (23h-07h). Minimum duration of the measurement interval is 60 minutes. The values of environment noise level are normatively regulated (11). In this case, residential area is classified in zone V, where the equivalent noise level limit shall not exceed a value of 60 dB for daytime, and 50dB during night. Characteristics of climatic conditions during the measurement process were clear and quiet weather (air speed  $\leq 5$  m/s), temperature varied in the range 13-32<sup>0</sup>C, air pressure was in the range 880-1020 mbar, and humidity of 59-73 %.

## RESULTS AND DISCUSSIONS

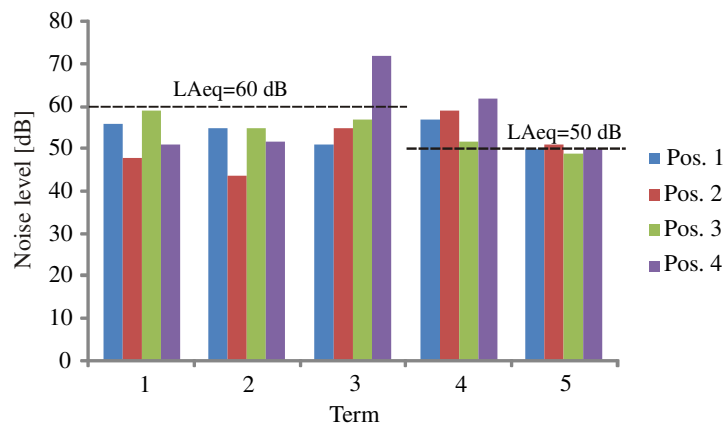
### Results And Analysis Of Performed Measurements Of Environmental Noise

The results obtained by experiment will be determined by whether equivalent noise levels, at selected measuring points, exceeds the limits for exposure to noise in the environment and causes excessive noise.

#### *The results obtained during the winter season*

During the month of January 2012 were performed measurements of noise levels at four selected measuring positions, during five different measurement periods. Measurement results for all measurement positions are shown in a Fig. 1.

From Figure 1. can be seen that during the day and evening were not recorded violations in relation to the permitted value equivalent noise levels at three selected positions. The exception is the result for position 4 in term 3, where the equivalent noise level was  $L_{Aeq} = 72\text{dB}$ . Deviation from the allowed value was 12dB, and it showed the need for more detailed analysis.



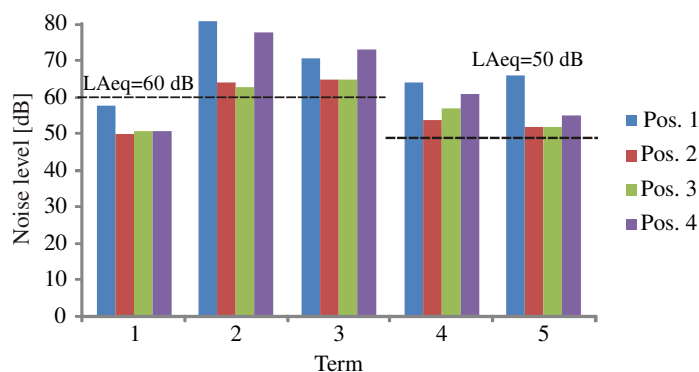
**Figure 1.** Results of measurements of noise levels in the winter at all four positions in all five terms

During the recording noise level was in the range of 40-60dB, and within the allowed limits. So one event has caused the equivalent noise level for the entire period of recording up, and moved the limit for 12dB. After frequency analysis we concluded that the mentioned event lead to the traffic noise source, or noise from motorcycles (12). Discrepancies noted during the night hours, were between 2dB-12dB. As the main noise sources were identified vehicles running local road and two external air conditioning units that were activated during recording.



**The results obtained during summer season**

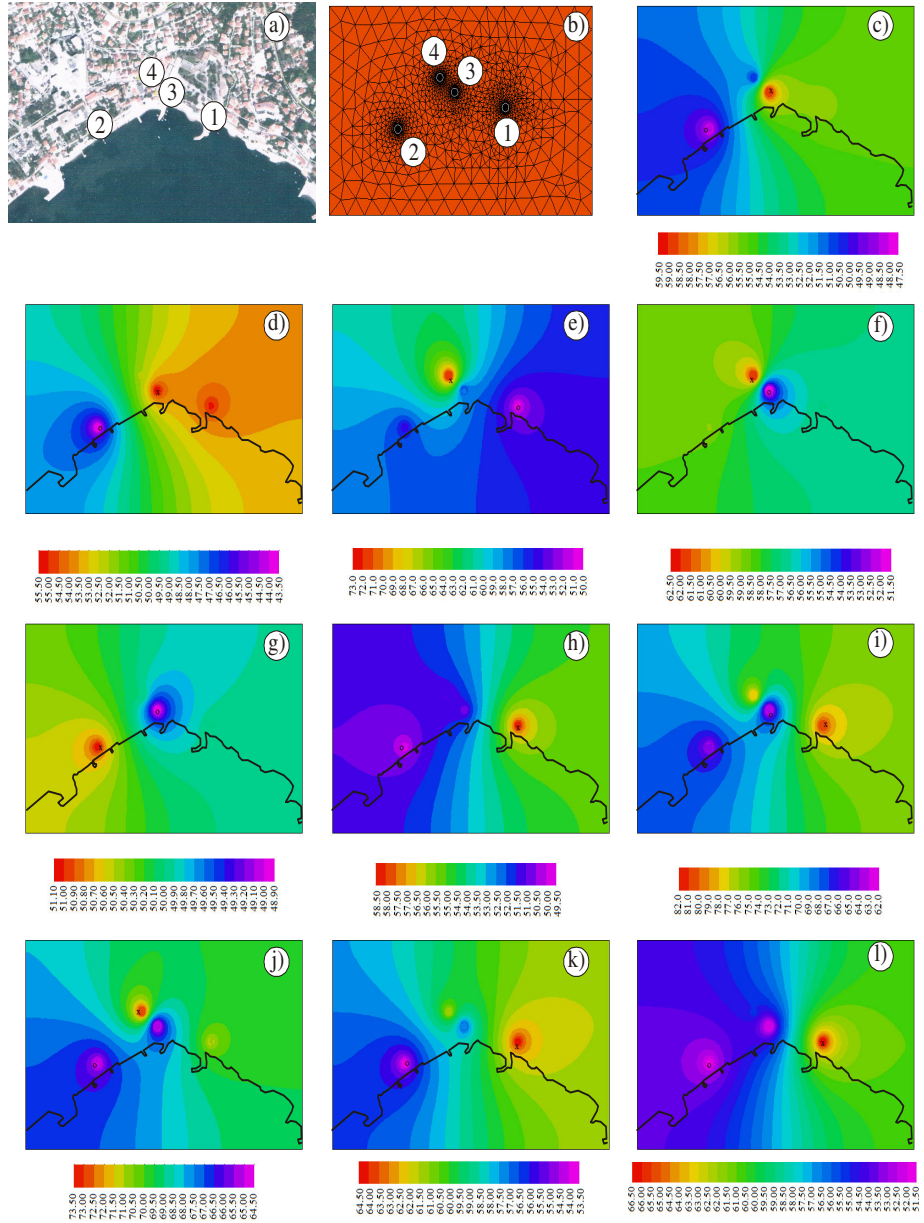
Measurements of noise levels in the period of the tourist season were made in the period from 15-18.7.2011 and was performed in all four measurement positions. In the period from 31.7-1.08.2011 the noise level measurement was performed at two characteristic positions at all times, in order to check the noise level in the peak tourist season in places where it gathers a large number of swimmers. Measurement results for all measurement positions are shown in Figure 2.



**Figure 2.** Results of measurements of noise levels in the summer at all four positions in all five terms

From Figure 2., it can be seen that for the daytime (Term 1, Term 2, Term 3) noise levels exceeded the permitted value at all four selected positions. Overdrafts are somewhere in between 3dB to 21dB. The night hours (periods 4 and period 5), we see clear deviations that are in the range from 2dB to 16dB. A detailed analysis led to the conclusion that the main causes of the excessive noise are motorcycles whose presence is noticeable during the summer, noise from restaurants and the noise that make tourists during the summer season

Based on the data shown in figure 1 and 2, a mathematical analysis regarding the geographical distribution of detected noise levels was conducted. The noise concentration was modeled as the partial difference equation, the analysis was performed using FlexPDU 5.9 program and the geographic profiles were drawn in AutoCAD 2011 program. The geographical layout of the observed location is shown in Fig. 3a, while the computational mesh is also shown in Figure 3b. Figures 3c-g show the noise levels in the winter, while figures 3h-l show the noise levels in the summer, at all four positions in all five terms, respectively.



**Figure 3.** The geographical distribution of the noise levels in the winter and in the summer, at all four positions in all five terms.

## CONCLUSION

The results of the conducted experiment indicate the presence of increased noise in the Municipality of Herceg Novi, so the endangerment of the population by noise has been recorded not only in the summer period but also in the winter period. Exceeding of noise levels range up to 21dB in the summer and 12dB in the winter and indicate the presence of problems that certainly represent a disturbing factor. What kind of and how big the negative impact on the life of the local population, tourists and the environment the identified noise sources (vehicles, motorcycles, air conditioners, music in restaurants, gatherings of large number of people) have, represents an issue that should be dealt with by municipal institutions and the entire community. In developed countries, citizens clearly recognize this problem and indicate the noise as one of the factors that negatively affects the entire population, so, if this problem is continuing to be seen as an "element" which follows everyday life, the competitiveness but also an ecological value of this tourist place could be brought into question.

## REFERENCES

1. Willams, A., M. Tourism Geography: A new synthesis, Routlage, London, 2009.
2. Djukic, P., & Pavlovski, M.: Ekologija i drustvo [Ecology and Society]. ECOcenter, Belgrade, 1999.
3. Prasevic, M., & Cvetkovic D.: Buka u zivotnoj sredini [Environmental noise]. University of Nis. Faculty on safety at work in Nis, 25, 2005.
4. Blukhn, G., & Ericcson, C. : Cardiovascular effect on environmental noise. Pub Med, Vol. 52, p. 2012-2016, 2011.
5. Stansfeld, S., & Matheson, M.: Noise pollution: non-auditory effect on health. British Medical Bulletin, Volume 68, p.243-257, 2003.
6. Zvyagina, L.A.: Peripheral nervous disorders in seafarers. European Journal of Neurology, Vol.11, p.136-182, 2004.
7. De Ruiter, E., Ph., J.: Urban traffic noise impact zones as brown field. Sustainable Development and Planning, Vol. 2, p.951-958, 2005.
8. Municipality of Herceg Novi. LEAP of the Municipality of Herceg Novi, 25, 2006.
9. Holden A. : Enviromental and Tourisam (2nd edition), Routledge, London, 2008.
10. Rulebook on Methods and Instruments for Noise Measurement and Conditions that must be Fulfilled by Organizations for Noise Measurement. Official Gazette of Republic of Montenegro No. 37/03, 2003.
11. Rulebook on Limit Values of Noise Level in the Environment. Official Gazette of Republic of Montenegro No. 60/11, 2011.
12. Torrey, D., & Culley, J.: Limiting motorcycle exhaust noise. Temple journal of Sci. Tech. & Envi. Law, XXV, 49-57, 2008.



**ENVIRONMENTAL IMPACT ASSESSMENT OF ROAD CONSTRUCTION:  
A CASE STUDY OF CORRIDOR VIII, ROAD A2, SECTION RANKOVCE -  
KRIVA PALANKA, MACEDONIA**

**Irena Stefanovska\*, T Mitev, E. Bozhinovska, K.A. Sackarska, A. Pavlov**

GEING Krebs und Kiefer International, str.Boris Trajkovski No.111,  
1050 Skopje; MACEDONIA

\**stefanovska.i@geing.com.mk*

**ABSTRACT**

The main aim of the EIA study for the construction of the road Rankovce – Kriva Palanka was to assess the environmental and social impacts of the proposed project and to provide sound measures aimed at impact mitigation and reduction, through which an integrated protection of the environment and the local communities would be achieved. The project was funded by the World Bank whose operational policies require preparation of an Environmental and Social Impact Assessment (ESIA). This study identifies the most suitable route alternative, evaluates the environmental and social impacts from the project, and proposes feasible mitigation measures to achieve integrated protection of the environment.

**Key words:** environmental impact assessment, mitigation measures, biocorridors, environmental protection, international financial institutions.

**INTRODUCTION**

Environmental Impact Assessment (EIA) is an assessment of the impacts of a planned activity on the environment in advance and provides avoidance and mitigation measures for prevention or reduction. The EIA is a practical decision-support tool that government bodies use to assess public or private projects before they grant consent or permit for the planned activity. The International Association for Impact Assessment (IAIA) defines EIA as “the process of identifying, predicting, evaluating and mitigating the biophysical, social, and other relevant effects of development proposals prior to major decisions being taken and commitments made”.

The legal, methodological and procedural foundations of the EIA were formally established in the United States in 1969. In Europe, the EIA was officially introduced with the European Commission Directive on EIA in 1985 (Glasson et al., 2013). In Macedonia, the legal foundation of EIA was established through the introduction of the national Environmental Law in 2005. Nonetheless, EIA has been applied in Macedonia on road projects before 2005, as it has been one of the funder’s compulsory criteria for

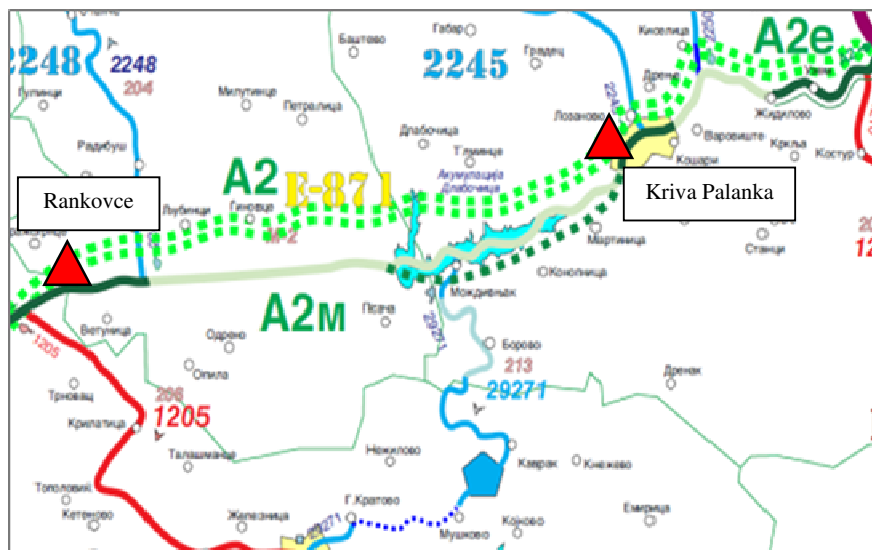
loan approval. The first generation of licensed EIA experts in Macedonia was produced in 2009.

The World Bank (WB) has provided an investment loan to the Public Enterprises for State Roads (PESR), for construction of a new road A2, Section: Rankovce – Kriva Palanka, Macedonia. The section Rankovce – Kriva Palanka is a part of Corridor VIII, known as the corridor East - West. This road spans across three states: Albania, Macedonia and Bulgaria through Drac - Tirana - Kafasan/Cafasan - Struga - Ohrid - Skopje - Kumanovo - Deve Bair - Gusevo - Sofia - Plovdiv - Burgas - Varna, thus connecting the Adriatic Sea (Bari – Brindisi) on the west with the Black Sea, Russia and Central Asia on the east.

The East - West corridor and the North - South corridor, as part of the primary road network of Macedonia, represent the most important international connections of Macedonia. The corridor VIII functions as a bridge connecting the East with the West Balkan countries, thus it is one of the prerequisites for rapid economic development of this region, and offers additional geopolitical and strategic significance for Macedonia. The road A2, Section: Rankovce – Kriva Palanka length is 25 km, and it is located in the north-eastern part of the Republic of Macedonia (Fig.1).

The main aim of the EIA study for the construction of the road Rankovce – Kriva Palanka was to assess the environmental and social impacts of the proposed project and to provide sound measures aimed at impact mitigation and reduction, through which an integrated protection of the environment and the local communities would be achieved. The project was funded by the World Bank whose operational policies require preparation of an Environmental and Social Impact Assessment (ESIA). According to the WB Operational Policy (OP) 4.01 'Environmental Assessment', this project classifies as category A that refers to projects associated with significant and long-term environmental risks positioned largely in natural landscapes, and thus necessitate significant mitigation measures.

This aim of this paper is to present and discuss the results from the ESIA study for the road construction section Rankovce – Kriva Palanka, prepared according to the Macedonian national legislation and supplemented with social aspects.



**Figure 1.** Section A2 Rankovce – Kriva Palanka  
(Roadmap of the Republic of Macedonia)

#### MATERIALS AND METHODOLOGY

The EIA procedure in Macedonia, is regulated with the national Law on Environment (Official Gazette No.53/05,81/05,24/07,159/08, 83/09, 124/10, 51/11,123/12, 93/13, 187/13, 42/14, 44/15, 129/15 and 192/15). The project objective was the construction of new road section, an activity regulated by Annex I of the national Decree on Annexed Projects for which the preparation of EIA study is compulsory (Official Gazette of RM No.74/05). The EIA is conducted prior the issuance of construction permit and approval for project implementation. In addition, a Strategic Environmental Assessment (SEA) and a Plan for Waste Management have been prepared for the project to comply with the national legislation.

In addition, an Environmental and Social Impact Assessment (ESIA) study has been drafted as a World Bank requirement. The ESIA examines the project's potential negative and positive environmental impacts and recommends adequate measures to prevent, minimise, mitigate or compensate for adverse impacts, thus improve the project's environmental performance. The ESIA is a World Bank's safeguard policy, which represents a mechanism for integration of environmental and social aspects of projects into the decision making process and prompts timely identification and management of environmental and social impacts and risks.

This project has triggered several World Bank policies and procedures: 1) OP/BP 4.01 'Environmental Assessment', 2) OP/BP 4.04 'Natural Habitats', 3) OP/BP 4.12 'Involuntary Resettlement', and 4) 'Access to Information'. To satisfy the Bank's

environmental and social requirements a range of instruments has been used such as: ESIA study, the mandatory Environment Management Plan (EMP), Resettlement Policy Framework (RPF), and Stakeholder Engagement Plan (SEP).

The scope of this paper is the ESIA study, which has been prepared in accordance with the national Law on Environment consolidated with the assessment of social aspects as required by the World Bank.

In accordance with the national Law on Environment (Official Gazette No.53/05,81/05,24/07,159/08, 83/09, 124/10, 51/11,123/12, 93/13, 187/13, 42/14, 44/15, 129/15 and 192/15), the EIA process consists of several stages. It includes three distinct procedures: 1) screening (decision on whether an EIA is required), 2) scoping (decision on the scope or extent of the impact assessment), and 3) review (independent assessment of the EIA study adequacy and accordance with the national law requirements).

The first step in the EIA process is the preparation of a notification for the Ministry of Environment and Physical Planning (MOEPP), which is an obligation of the developer that contains a description of the developer's project. This serves as a basis for the screening stage when the competent authority (MOEPP) decides whether an EIA is required. After the request of a Scoping Opinion from the competent authority the developer is required to appoint an EIA licensed expert to conduct the EIA study. After the submission of the draft EIA study to the competent authority, the draft EIA study is required to be delivered to the relevant stakeholders and be subjected to public discussion. Following the public debates completion, the stakeholders' considerations shall be incorporated in the final EIA study. The competent authority reviews the adequacy of the EIA. The final approval or rejection of the project is granted by the competent authority after the consideration of the EIA study, the EIA Review Report, and the stakeholders' opinion.

The ESIA study scope for the road construction section Rankovce – Kriva Palanka consisted of several phases:

1. Analysis of alternatives
2. Baseline information synthesis
3. Identification and evaluation of direct and indirect impacts
4. Projection of environmental and social impact mitigation measures

The methodology used for determining the most favourable alternative was the multi-criteria analysis (MCA). This method can be used to evaluate a number of options against several criteria. It was used to identify the most favourable road alternative. The multi-criteria analysis is comprised of several subsequent steps:

1. Identification of assessment criteria suitable to measure impacts of proposed alternatives;
2. Analysis of the relative importance of assessment criteria (weighting) to determine the relative weight of each criterion;
3. Analysis of the assessment criteria performance (scoring);
4. Multiplication of the weights and scores for each criterion. The highest sum represents the most favourable alternative.

## RESULTS AND DISCUSSION

### *Analysis of alternatives*

Project alternatives are functionally different ways of project realisation. The consideration of alternatives represents good-practice EIA and the heart of the EIA process (Noble, 2010). The review of different alternatives is most useful when they are undertaken early in the project cycle. The main considerations of the EIA alternatives analysis are the environmental implications of the road routes.

#### 1) The “no-go” alternative

The baseline condition of the existing road section between Kriva Palanka and Rankovce is of a poor quality. It causes road safety issues and accidents, and lacks proper drainage system. Environmental implications from vehicles' accidents are potential spills of diesel, fuel and lubricants, which can contaminate the soil and water. The existing road crosses through several settlements and it causes elevated noise levels, detriments the air quality that adversely affect the local communities. In addition, the absence of proper drainage system causes seasonal floods that deteriorate the water quality of the river Kriva Reka.

#### 2) Alternative A

This road route alternative is designed to pass through the existing wildlife corridor German – Osogovo (important biological corridor, mainly used by large mammals). An important advantage of this alternative is that some road segments are parallel to the railway, thus it is technically viable to connect the planned wildlife passes with the railway passes.

#### 3) Alternative B

This alternative causes more environmental implications than alternative A, as a result of the need to design new wildlife passes that would cause additional habitat fragmentation and project expense increase. Also, this route is closer to the River Kriva Reka (~1 km) compared to Alternative A (~3 km), which presents a higher risk for accidental surface water contamination and degradation of the new express road by spring floods. Moreover, Alternative B will entail greater extent of land expropriation and conversion of arable land.

**Table 6.** Values for weight and scoring criteria for alternatives analysis

Weight sets	Each Very negative effect (VNE) -2	Each minor negative effect (MNE) -1	Each neutral effect (NE) 0	Each minor positive effect (MPE) +1	Each very positive effect (VPE) +2
Score	0 points	1 points	2 points	5 points	10 points

Total score= (VNE\*0 + MNE\*1 + NE\*2 + MPE\*5 + VPE\*10)



Criteria:

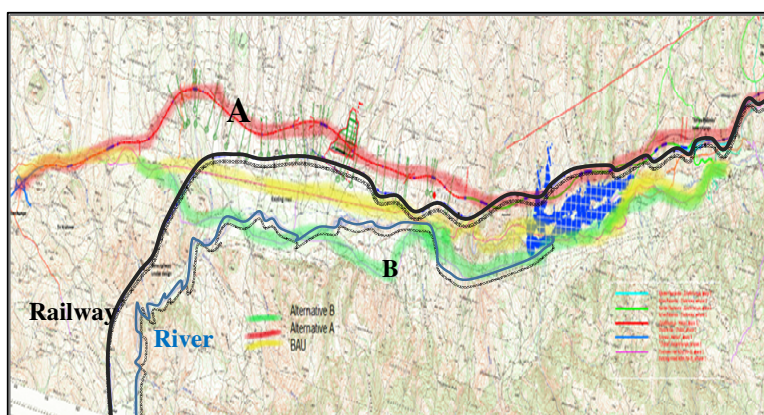
- |   |                                 |
|---|---------------------------------|
| 1. Waste  | 9. Soil pollution and drainage  |
| 2. Recreation / tourism                                 | 10. Geological formations       |
| 3. Traffic safety                                       | 11. Land-use changes            |
| 4. Noise  | 12. Landscape characteristics   |
| 5. Habitats protection (Important plant areas IPA)      | 13. Air Quality                 |
| 6. Passes for animals                                   | 14. GHG reduction(CO2-eq)       |
| 7. Bird habitats protection (Important bird areas IBA)  | 15. Heritage protection         |
| 8. Protection of forests (degradation, fires, diseases) | 16. Economic growth             |
|   | 17. Floods and nature disasters |
|   | 18. Unemployment rate           |
|   | 19. Material goods              |

Each alternative was assessed by assigning weights for all criteria (for example: soil pollution and drainage has been assigned weights -1 (MNE), 1 (MPE), 1 (MPE) for current situation, alternative A and alternative B, respectively), summing the number of occurrences of each weight set in each scenario, and multiplying the number of occurrences of each weight set with the corresponding score (Tab. 1 and tab. 2).

**Table 7.** Scoring of each alternative

Scenarios / Points	0 points	1 points	2 points	5 points	10 points	Score
“no-go” alternative	3 VNE	10 MNE	2 NE	4 MPE	1 VPE	44
Alternative A	0 VNE	2 MNE	4 NE	9 MPE	2 VPE	75
Alternative B	1 VNE	4 MNE	5 NE	8 MPE	1 VPE	64

The analysis of alternatives concludes that Alternative A is the preferred route for the new express road, due to fewer adverse and more positive environmental and social impacts compared to alternative B and the current situation.



**Figure 2.** Analysis of alternatives

### *Baseline information*

Environmental conditions of the project area

The project area covers the municipalities of Rankovce and Kriva Palanka. Approximately half of the area is characterized by high erosion intensity. The main water artery in the project area is the Kriva River which is fed by watersheds of the Osogovo Mountains and Mount German. According to analysis of the surface water quality data of the Kriva River carried out at 20 measuring points, the water quality (indicators: concentration of ammonia, turbidity and high concentration of iron) deteriorates as the river passes through the Kriva Palanka Municipality. This attributes to the presence of such permanent sources of pollution as neighbouring households, mining and other industries and illegal dumps. However, the quality of the Kriva River water is improved by the point of exit from Rankovce, mainly due to the dilution of pollutants through addition of higher quality water from inflowing tributaries. According to the monitoring reports of the NHMS, the area where the eastern part of the road is proposed to be constructed suffers from regular spring flooding caused by seasonal snow melting and rainfalls. This high risk flooding area includes the stretch of the Kumanovska River upstream the Pcinja River, and the stretch of the Pcinja and Kriva Rivers upstream their confluence.

Overall, the project area landscape is hills and mountains located north of the road. On the south, the proposed road alignment passes oak forest, black locust plantation, conifer tree plantation and hill pastures. The entire southern section of the road is parallel to the Kriva River, the closest point being at 850m from the river. The Osogovo Mountain is located south of the projected road, and the Mountains German and Bilina are to the north.

In order to analyse the natural habitats and assess the ecosystems value in the project area, a strip of 400 m (200 m of each side of the proposed road axis) has been defined. The EIA identified several areas within the study area, which bear various status of protection and ecological importance, as follows:

1. Osogovo Mountains - Area Proposed for Protection: Osogovo Mountains, proposed to a status of protected landscape (unique landscape characteristics and specific interactions of people with nature) under the 2010 UNDP/GEF project on the development of representative protected areas network in Macedonia. The road construction will not impact this landscape.
2. Osogovo-German Landscape Biocorridor: Osogovo-German has been identified as a biocorridor, important for large mammals (Brajanoska et al., 2009), as it allows for daily, periodical and seasonal movements and migration of various fauna species and dispersal of plants, namely amphibians, brown bear, grey wolf, ungulates, particularly roe deer, and some small mammals. The proposed road alignment will cross this landscape corridor. The project design incorporates adequate measures to maintain the function of the landscape.
3. Cultural Heritage Sites: Two protected cultural heritage sites in the study area: 1) Church St. Nicolas in vill. Psacha and 2) Monastery of St. Joachim on the Osogovo Mountain near Kriva Palanka. The sites will not be impacted by the project activities.

### Social conditions of the project area

The project area is dispersed to two political – territorial units: municipality of Kriva Palanka and municipality of Rankovce. The project activities will affect 19 rural settlements and the city of Kriva Palanka (urban settlement). The following table presents the number of people living in the affected settlements. Dominant activities for livelihood provision in the affected settlements are services (trade, transport, communal and medical domains) and agriculture. Production is barely present since the transition period (1980-90ties) that facilitated closure of main production capacities due to bad management. Temporary seasonal and to lesser extent permanent migration is also present in the project area.

### *Identification and evaluation of direct and indirect impacts*

The expected environmental and social impacts have been derived from the project scope and the baseline environmental and social conditions. The following main impacts have been selected and described for each project phase:

#### 1. Environmental Impacts

##### *Project phase: Construction*

- impacts on the natural landscape and aesthetics;
- impacts associated with extraction and transportation of road construction materials, and excess materials waste;
- potential short-term disturbance to the existing drainage systems;
- short-term degradation of air quality from increased dust and exhaust emissions;
- noise and vibration emissions near T'Iminici, Ginovce and Rankovce settlements;
- major impacts on flora and fauna in sensitive areas such as the Osogovo - German Landscape Biocorridor;
- impacts on local forests and tree plantations;
- impacts related to the generation and disposal of liquid and solid wastes at the construction phase;
- surface water pollution of Kriva River, which runs in parallel with the road route and Rankovska River, which is planned to be crossed at one point by the new road;
- potential impacts on the ground water in the project area;
- potential impacts on soil such as soil pollution from spills and leaks of hazardous liquids, and intense soil compaction and erosion from improper material excavation and use of heavy construction machinery.

##### *Project phase: Operation*

- noise and vibration emissions from road traffic;
- impact on air quality of dust and exhaust emissions from traffic;
- risk of accidental pollution of soils and water from unexpected fuel spills and leakages;

- impact on wildlife due to ecosystem fragmentation (Osogovo-German Landscape Biocorridor).

## 2. Social Impacts

The road construction will require land acquisition resulting with a permanent loss of agricultural land. The vulnerable groups of residents of Rankovce and Kriva Palanka settlements will be affected the most. During the operational and maintenance period of the road noise and vibration emissions are expected, which will affect the quality of life of the households near the road, particularly the settlements Rankovce, Ginovci, Gulinci, Ljubinci, Milutinice, Petralica, Dlabochica, T'Iminci and Kriva Palanka.

On the other hand, the construction of the road is expected stimulate local economic growth by creating local employment and business opportunities for local contractors during construction works. Significant economic, employment and educational benefits are anticipated to arise from the road use on local, regional (north-east region) and national level, as well as on international level (Balkan countries).

### *Environmental and social impact mitigation measures*

#### Air quality measures

Dust emission reduction measures:

- Construction of hoardings at construction sites to minimise dust emissions;
- Moistening construction sites to reduce dust formation;
- Use of hygroscopic additives to increase water presence in the ground;
- Reduction of dust-generating activities in days of strong wind;
- Moistening earth stockpiles to prevent dust emissions;
- Moistening ground during loading and unloading of aggregates in trucks;
- cover truck dumpers with tarps;
- Wash of loaded trucks prior to construction site departure to ensure loose material is not cast off beyond construction site.

Exhaust emission reduction measures:

- Regular maintenance of construction machinery to comply with national emission standards;
- Avoidance of unnecessary idling of construction machinery;
- Optimisation of construction truck traffic addressed in the Construction Traffic Management Plan;
- Truck routes planning to avoid peak traffic hours or routes with heavy traffic.

#### Water quality measures

- Sanitary wastewater generated in the construction camps will not be allowed to be discharged in natural water courses untreated. The camps will be provided with a wastewater treatment system to treat influents to admissible levels when discharged in the river;

- The construction materials and excavated soils will be stored at a safe distance from surface watercourses and drains;
- Drums and barrels will be properly labelled and stored in a designated bunded safe area within the site compound;
- Storage compounds for fuels, oils or other liquid chemicals should be sited away from surface water drains. The storage compounds will have an impermeable base as to avoid direct drainage into surface water. Where applicable, drainage from storage compounds should be passed through oil interceptors prior to discharge;
- Emergency response procedures should be planned in the hazardous materials management and spill prevention plan, before initiation of project activities to manage potential leakage or spillage of contaminating substances;
- Topsoil/vegetation along watercourses should be retained to aid attenuation and sediment infiltration;
- Constriction of road drainage system as protection measure for collecting and abstracting the storm water from the road surface;
- Construction of culverts and their associated elements, viaducts, or bridges for river crossing.

#### Waste management

- Preparation of Waste Management Plan to manage all types of waste generated during construction works;
- Regular cleaning and maintenance of drainage system of the road.

#### Soil quality measures

- Preparation of Sedimentation and erosion control plan;
- Preparation of Hazardous materials management and spill prevention plan;
- Preparation of Chemical Accident and Spills Management Program.

#### Noise and vibrations mitigation measures

- When feasible, the construction equipment should comply with the requirements of EU Directive 2000/14/EC, as there national legislation on outdoor equipment emission noise levels is lacking. All equipment should bear CE marking and the indication of the guaranteed sound power level and should be accompanied by an EC declaration of conformity;
- Installation of noise barriers at sites of great sensitivity;
- Use appropriate noise muffling devices for the equipment to reduce noise intensity;
- Regular maintenance of all machinery;
- Preparation of construction traffic plan to establish speed limits for construction vehicles and machinery, and organize traffic so as to avoid, where feasible, populated areas;
- Monitoring vibration levels during the performance of critical work processes (e.g. foundation of piles and catenary masts). All damaged objects will be repaired or paid a compensation;

- Activities such as demolition, earthmoving and ground-impacting operations will be scheduled not to coincide so as not to occur in the same time period. Unlike noise, the total vibration level produced could be significantly lowered when each vibration source operates separately;
- Planting high and dense forests to reduce the noise from road use.

Landscape management

- Installation of soft screens around the perimeter of these sites
- Terrain restoration at impacted landscapes to adjust to the surrounding land morphology;
- Planting autochthonous vegetation at water banks under the designed bridges and viaducts;
- aesthetic integration of the structural parts of viaducts and bridges (e.g. deck, pillars) and tunnel mouths, using construction materials with colours and textures that blend well with those of the surrounding landscape (e.g. dark concrete for pillars in a black pine forest);
- Restoration of the borrow pits at the end of the construction works.

Flora and fauna mitigation measures

- Haulage roads should have a width of 3.5 m and its route must avoid areas of highly sensitive vegetation;
- Workers' camps and auxiliary facilities to be constructed in low sensitivity habitats such as abandoned fields, ruderal and trampled sites, and Black Pine plantations;
- High and very high sensitive habitats will be marked and prohibited for construction works;
- In high nature value habitats such as Thermophilous oak forests, Mesophilous oak forests, and Riparian willow-poplar woodland, the habitat border of will be protected by fencing the construction site;
- Fencing river banks that meet at construction points;
- Education of construction workers to increase environmental awareness and instruct responsibilities;
- Deforestation and permanent conversion of forest land must comply with the Law on Forests (Official Gazette No.64/09, article 14). These activities require compensation fee determined in the Rulebook of prices for forest damage (Official Gazette No.64/09, article 60) (Fig. 3).

**Table 8.** Price for forest damage per tree type

<b>Tree</b>	<b>for 1 m<sup>3</sup> / MKD denar</b>	<b>Tree</b>	<b>for 1 m<sup>3</sup> / MKD denar</b>
Oak	35000.00	Black pine	32000.00
Ash	40000.00	Hazel	40000.00
Maple	40000.00	Poplar	25000.00
Black locust	30000.00	Cypress	40000.00

#### Habitat mitigation measures

- Drainage pipes along the road will be adjusted to allow the passage of small animals;
- Bridge undersides will be vegetated with riparian shrubs and small trees to create vegetal screens that hide the road structure.

#### Social mitigation measures

- Compensation in cash at full replacement cost for loss of arable land;
- Training of workers in Occupational Health and Safety to ensure workers' safety and full compliance with the national Health and Safety requirements;
- Informing the local communities (representatives of affected settlements) on the Timeline of construction activities that will take place in the area and the availability of the procedure of Grievance mechanism;
- Safe pedestrian corridors across construction site must be provided on demand of the local residents and community.

### **CONCLUSION**

The road construction is one of the prerequisites for rapid economic development of the north-east region in Macedonia. The aim of the ESIA is to address and propose mitigation measures for potential environmental and social impacts of the proposed road construction. The most important environmental impacts from the road construction are the water emissions, landscape degradation and habitat fragmentations. Therefore, the EISA proposes state-of-the-art measures and the best practices to address the identified impacts in order to achieve integrated protection of the environment. To conclude, the proposed project will yield socio-economic benefits for the region, while preserving the environment if the proposed measures are duly implemented in practice.

### **REFERENCES**

1. Brajanoska, R., Civic, K., Hristovski, S., Jones-Walters, L., Levkov, Z., Melovski, Lj., Melovski, D., and Veleviski, M. (2009) Background document on Ecological Networks – Project: Development of the National Ecological Network in FYR Macedonia (MAK-NEN). MES, Skopje, Republic of Macedonia; ECNC, Tilburg, the Netherlands
2. Glasson, J., Therivel, R., and Chadwick, A. (2013) Vol. Revised. N.p.: Routledge. Print.
3. Noble, B. (2010) Introduction to Environmental Impact Assessment. Oxford University Press. Don Mills, Ont. 2nd edition



## URBAN ENVIRONMENT NOISE ASSESSMENT

Sasha Petrushevska, D. Lazarevska

GEING Krebs und Kiefer International and others Ltd, Skopje, MACEDONIA

*ilievka.d@geing.com.mk*

### ABSTRACT

Noise pollution generated by road traffic is a significant and growing problem of modern times. Heavy traffic and growing construction of urban roads have great impact on the environment, hence the need for monitoring is essential to the identification of the areas where measures are needed to reduce the noise. This paper provides an overview of the measuring points, the method of determining the level of road traffic noise generated in urban areas and the results obtained from the measurements.

**Key words:** noise, environment, road traffic noise.

### INTRODUCTION

Environmental noise is noise caused by unwanted or harmful outdoor sound created by human activities, which is imposed on the nearby environment and causes discomfort and disturbance, including noise emitted by vehicles, railroad and air traffic and from sites of industrial activity. The total level of noise which transmits in the surrounding space is noise emission.

A noise source encompasses all activities that transmit or emit sound in the environment. Road traffic or motor vehicles with at least four wheels and a maximum speed exceeding 25 km / h are regarded as a separate source of environmental noise.

### TECHNICAL REQUIREMENTS

Measurements of traffic noise level generated on Boris Trajkovski intersection, Ivan Kozarov frontage road, Macedonia Blvd and Eseninova St. in Skopje, R. Macedonia were performed in accordance with the requirements of the appropriate method standard.

Measuring of environmental noise:

- MKS ISO 1996-2:2010 Acoustics - Description, measurement and assessment of environmental noise-Part 2: Determination of environmental noise levels.



### Measuring equipment

Environmental noise can be determined using the noise measurement device CR 171B (class 1), calibrated using a CR: 515 (class 1) produced by Cirrus Research plc. UK. The instrument is calibrated in accordance with the suggestions contained in international standards and national regulation.



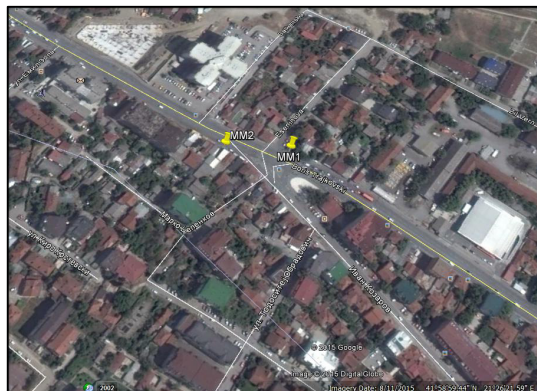
**Figure 3.** CR: 171B

### Description of measuring points and noise source

Measurements were performed in accordance with the requirements of the appropriate method standard MKS ISO 1996-2:2010 Acoustics - Description, measurement and assessment of environmental noise-Part 2: Determination of environmental noise levels, as well as in accordance with the legislation of the Republic of Macedonia, the Law on Environmental Noise Protection (Official Gazette of RM No. 79/07, 124/10, 47/11), and other regulations and acts.

According to the regulation on locations of monitoring stations and measuring points (Official Gazette of RM No. 120/08), the measuring points where noise measurement was carried out form part of a third (III) degree noise protection area where noise-causing activities are allowed and noise would cause less disturbance. It is a commercial and residential area where housing, craft and small scale manufacturing businesses and malls are located, agricultural activities are performed and commercial and catering services are rendered.

The measuring points were located in the Municipality of Kisela Voda, Skopje, R. Macedonia.



**Figure 2.** Micro location of measuring points

The first measuring point is located on an intersection between Boris Trajkovski St. and Eseninova frontage road. The noise measurement instrument was set on a tripod at a height of 1.5 m from the ground at a distance of 1.3 m from the traffic lane, 4.8 m from the traffic lights on Eseninova St. and at 2.8 m from the Boji lakovi store. The second measuring point was located on the intersection between Boris Trajkovski and Ivan Kozarov Streets. The instrument was set at a height of 1.5 m from the ground, 1.3 m from the traffic lane and 1.1 m from the Super cenii shop.

The road surface consists of hard asphalt. The average speed of the vehicles varied from 40 to 60 km/h. 30 vehicles pass during one test interval.



**Figure 3.** Measuring point MM1



**Figure 4.** Measuring point MM2

### Results

Noise indicators include: the equivalent noise level for a certain period of time ( $L_{Aeq, T}$ ), the maximum noise level ( $L_{Amax}$ ) and sound level (SEL).

Equivalent noise level for a certain period (LAeq, T) represents the noise levels measured during a period of time having the amount of energy equal to the one of the measured noise calculated with the following formula.

$$LA_{eq, T} = 10 \times \log \left[ \frac{1}{N} \sum_{i=1}^N 10^{0.1 \times (LA_{eq, T})_i} \right]$$

Where:

$N$  – is the number of measurements during the time period T;

$(LA_{eq, T})_i$  – Equivalent extended A - noise level measurement in the i - th measurement interval;  $T$  - Time period of measuring;

The maximum noise level, (LMax), represents a maximum - a certain level of noise during a certain time period. Level of sound exposure, (SEL), represents a measured sound pressure level for a periodic event in a certain time interval, calculated according to the following formula:

$$SEL_{AE} = 10 \times \log \left[ \left( \frac{1}{t_0} \right) \times \int_{t_1}^{t_2} \left( \frac{p_A(t)^2}{p_0^2} \right) dt \right], dB(A)$$

Where:

$p_A(t)$  – A, measured sound pressure in Pa  $p_0$  - Reference sound pressure in Pascals ( $p_0=20\mu Pa$ )

$t = t_2 - t_1$  - Period which covers all characteristic moments of one sound event beginning at time t1 and ending at t2;

$$t_0 = 1s$$

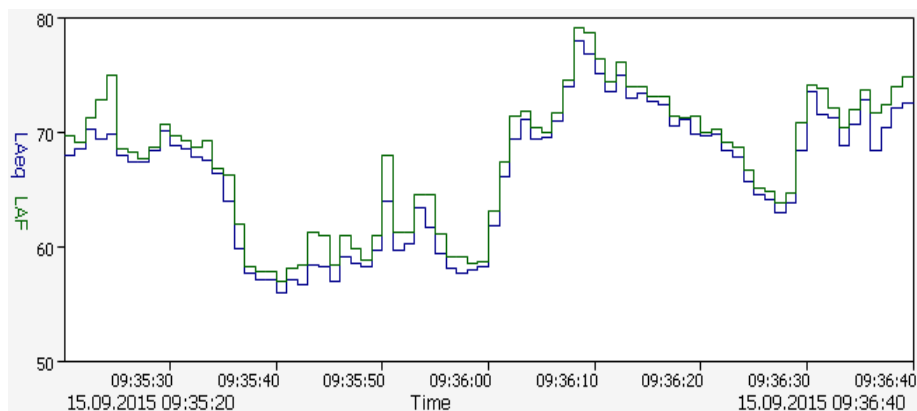
The results were expressed in accordance with the legislation of the Republic of Macedonia, the Law on Noise Protection (Official Gazette, No.79 / 07, 124/10, 47/11) and other regulations and acts.

- Table 1 presents the results from the measured noise level.

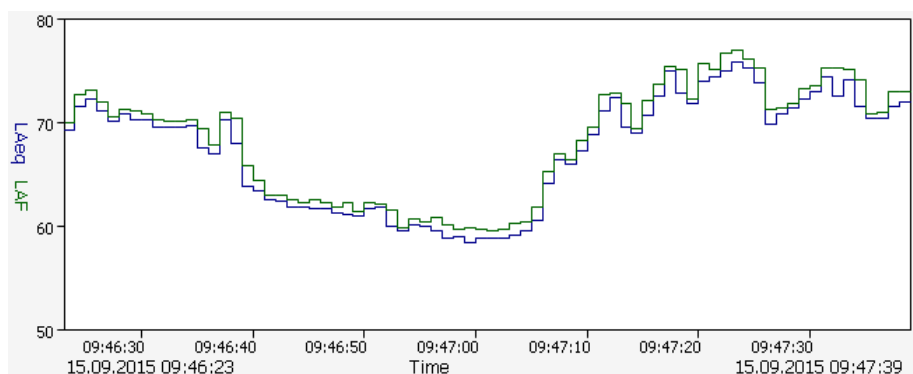
**Table 1.** Table of results

Project name:	Report on noise measurement on on the intersection between Boris Trajkovski St. and Ivan Kozarov St. and from Macedonia Blvd to Eseninova St.			
Date of measurement	15.09.2015			
Time/Period of measurements	09:00 - 10:00/Day 07 <sup>00</sup> - 19 <sup>00</sup>			
Thermal environment	Temperature [°C]	Air humidity[%]	Velocity [m/s]	
	23,8	60,73	0,36	
Measuring point	longitude/latitude	LAeq (dB)	Lmax(dB)	Limits value (dB)
MM1	41°59'1.52"N	69,5	79	60
	21°26'21.09"E			
MM2	41°59'2.25"N	69,9	77	60
	21°26'19.32"E			

- Results of Laeq and Lmax given in diagrams:



**Figure 5.** Results of Laeq and Lmax for MM1



**Figure 6.** Results of Laeq and Lmax for MM2

### Discussion

Environmental noise indication limits for day-time Laeq (e) in this type of areas should not be higher than 60 dB. The measured values exceed the limit ones, but because they are close to the statutory limit values in accordance with the regulation on limit values of environmental noise level (Official Gazette No. 147/08), calculations were made to predict the level of sound at different distances from the road construction. The calculations were made according to IIPC Horizontal Guidance for noise Part 2 - Noise assessment and control. The results are presented in the table below:

**Table 2.** Display of noise prediction according to the measured values of LAeq (dB)

Assessment of noise level at different positions according to noise emission	Equivalent Continuous Level LAeq, (dB)	
	MM1	MM2
Measurement location at a distance of 1.3 meters from the road;	69.50	69.90
Assessment of noise at a distance of 3 meters from the road edge;	64.73	65.13
Assessment of noise at a distance of 13 meters from the road edge;	58.36	58.76
Noise limit value for an area, outside of agglomeration exposed to traffic noise during day-time.	60 dB	60 dB

### CONCLUSION

The purpose of the measurements was to identify and determine the level of traffic noise created on the intersection between Boris Trajkovski St. and Ivan Kozarov frontage road and from Macedonia Blvd to Eseninova St. The noise result analysis has shown that it is necessary to take measures to reduce the noise generated by traffic. Urban environments require constant noise level monitoring because it is an additional problem to contemporary living.

### REFERENCES

1. Standard, MKC ISO 1996-2:2010 - Acoustics - Description, measurement and assessment of environmental noise-Part 2: Determination of environmental noise levels
2. Horizontal Guidance for Noise Part 2 – Noise Assessment and Control, Environmental Agency UK, 2004
3. [3] A. Lara Saenz, R. W. B. Stephens, Chapter 12, Road Traffic Noise: Generation, Propagation and Control, John Wiley & Sons Ltd, 1986
4. Highway Traffic Noise: Analysis and Abatement Guidance, December 2011
5. Official Gazette of RM No. 147/08, No .79 / 07, No .124/10, No .47/11



## **LEVEL OF RIVER WATER POLLUTION IN KRUSEVAC USING PROMETHEE METHOD**

**Danijela Stojadinovic, V. Domjan, N. Arsic**

Ecological Movement "White Birch" Krusevac, SERBIA

### **ABSTRACT**

The topic of the paper is establishing of the cause-consequence connection between the activity of anthropogenic sources of polluting substances in urban areas and the level of degradation of water. The city of Krusevac will be observed as a representative urban area, in which there are a number of anthropogenic sources of pollution that can significantly impair the quality of water status. For the analysis we used the statistical data contained in the relevant database of authorized institution, for the period from 2005 to 2010. After the statistical data processing will be carried out using the PROMETHEE multicriteria ranking methods of measuring points, according to the concentrations of pollutants in the water, after which the proposal will be given to the application of appropriate measures to protect and improve the environment.

**Key words:** Promethee method, water pollution, pollution sources

### **INTRODUCTION**

For the ranking of the observed measurement locations at the site of the city of Krusevac in relation to the present contamination in river water PROMETHEE method software package Decision Lab 2000 was used. On the basis of this method, in Krusevac were observed the parameters of quality indicators of water pH, oxidizability, nitrogen oxides, chlorides, sulfates, phosphates -detergents, phenols, oil in total and grease in the river waters.

Ranking of measuring points, in relation to the concentrations of beneficial and harmful substances, have been identified.

### **ANTROPOGENIC FACTORS OF ENVIRONMENT POLLUTION IN THE CITY OF KRUSEVAC**

According to the degree of influence on the environment, industrial production can be conditionally classified into the following three categories:

- a) Large pollutants (chemical industry)
- b) Medium pollutants (chemical-manufacturing industry and paper industry)
- c) Small pollutants (food industry, textile industry)

In the area of Krusevac the following industries operate: IMK "14<sup>th</sup> October" AD, "Trayal Corporation", HI "Zupa ", HI "Henkel Merima", NIS - Lubricant factory, "Rubin ", "Branko Perisic ".

The main source of the toxic substances flow into natural waters are the waste water of industrial enterprises. Regardless of the huge resources invested in to devices for the treatment, waste water of many industries still contain a certain amount of heavy metals, detergents, products based on processing of oil and other impurities. Natural unpolluted waters doesn't contain these substances at all or in much smaller concentrations.

The largest amounts of polluting components reach the water through industrial wastewater of the oil processing facilities, chemical industry, pulp and paper factories, textile and other industries. The scope and composition of these waters depends on the size of industrial buildings, production technology and the level of wastewater treatment.

A significant source of pollution are waste and leachate waters from agricultural areas, especially collector and drainage water from irrigation areas. These areas often pollute both groundwater and surface water. Water runoff from agricultural areas can be surface and underground.

The composition of mineral salts leached from the soil, depends on the conditions of irrigation, the state of the collector-drainage network and other conditions.

Also sewage wastewater from villages/settlements have great importance in the pollution of water basins and water flows. They are formed by exploiting water supplies in the households or industry, and dropping water in the sewerage.

The lack of proper waste management also contributes to water pollution, because the hazardous waste is dumped without any prior treatment, mainly at illegal landfills. In Serbia, there are 170 registered landfills, but also hundreds of illegal, which are different sizes, and the only method of dealing with waste is landfills disposal. Only the city of Novi Sad owns the plant for partial recycling of waste.

#### **AREAS OF PROMETHEE METHOD APPLICATION**

The application of PROMETHEE II method shortly involves defining of the appropriate preference function and assigning weights significance (weighting coefficient) to each individual criteria. Determining the weight significance is a very important step in all multi-criteria methods, including the PROMETHEE II method where the decision maker must be sufficiently informed and objective in order to adequately assign weight to each criteria (Macharis et al. 2004).

Behzadian and associates (2010) have performed a thoroughly research on the PROMETHEE method and its application in various fields starting from the year 1985 until 2010. Based on a sample of 195 scientific papers, they are divided into 9 main application areas: management of environmental protection, hydrology and water resources management, business and financial management, chemistry, logistics and transport, production and installation, energy management, social and other aspects. Other aspects are related to the field of application in medicine, agriculture, education, design, state administration and sport.

#### **RESULTS OF PROMETHEE METHOD APPLICATION BASED ON PARAMETERS MONITORED IN THE RIVER WATERS**

The river water sampling was conducted at the measuring points: Majdevo, Gornji Stepas, Mudrakovac, Novo kupaliste, Parunovacki most, Jablanicka, Nauparska, Trmcarska, Modricka, Lomnicka, Gaglovaacka, Kobiljska.

Weight coefficients are assigned based on each parameter share - criteria in the total measured pollution at all observed locations as follows: pH-11.02% oxidizabilities - 22.27%, ammonia-5.5% total oxides of nitrogen - 17.3 % Chloride-17.9% sulphate - 44,13%, Phosphates-3.9%, detergents-1.2% Phenols-0.8%, total oils and fats-18.3%. Medium values for given parameters are shown in Table 1.

**Table 1.** Medium values of parameters in the waters for the period from 2005 to 2010.

	pH	Oxidability	Ammonia	Total nitrogen oxides	Chlorides	Sulphates	Phosphates	Detergents	Phenols	Oils and fats in total
Majdevo	8,0683	27,4863	0,5442	0,4777	8,7240	22,5800	0,1040	0,0612	0,0005	0,2896
Gornji Stepos	8,1616	8,3286	0,4290	0,4427	8,7780	23,1500	0,1050	0,0609	0,0008	0,2200
Mudrakovac	8,1983	11,0280	0,3712	0,5508	9,2980	17,1416	0,1260	0,1218	0,0008	0,2018
Novo kupaliste	8,1533	10,3710	0,4799	0,6060	9,5250	29,6950	0,1300	0,0635	0,0005	0,2711
Parun. most	8,3412	13,4216	0,2376	0,8706	10,6233	30,7200	0,1550	0,0978	0,0006	0,2956
Jablanicka	7,4900	24,9426	0,2391	0,6803	7,3716	26,9600	0,1660	0,1052	0,0007	0,3525
Nauparska	7,6966	6,8250	0,1504	0,7467	7,0776	23,5416	0,2160	0,0125	0,6681	0,3443
Trmcarska	7,0780	7,5880	0,2605	1,9778	10,2200	32,8180	0,2340	0,0000	0,0010	0,3040
Modricka	7,8966	6,4766	0,1556	0,8534	7,6300	25,2800	0,1060	0,0262	0,0006	0,3710
Lomnicka	7,4800	10,8650	0,5360	1,5991	7,3360	22,9316	0,2290	0,0929	0,0004	0,2765
Gaglovacka	7,5983	46,2633	0,6440	4,6281	46,1200	80,4426	1,0280	0,2256	0,0052	8,9559
Kobiljska	7,9316	16,6133	0,6588	1,3407	20,0866	41,6216	0,7030	0,1336	0,0006	3,7297
Jedince		mgKMnO <sub>4</sub> /l	mgN/l	mgN/l	mgCl <sup>-</sup> /l	mgSO <sub>4</sub> <sup>2-</sup> /l	mgP <sub>2</sub> O <sub>5</sub> /l	[mg]/l	[mg]/l	[mg]/l

By the methods given in the above-mentioned software package application, Decision Lab 2000, defined by the data out of the water gives the following scenario shown in Table 2.

**Table 2.** Scenario of the ranked water samples at measuring points

Alternatives	pH	Oxidability	Ammonia	Total nitrogen oxides	Chlorides	Sulphates	Phosphates	Detergents	Phenols	Oils and fats in total
Max/min	Min	Min	Min	Min	Min	Min	Min	Min	Min	Min
Preferences function	linear	linear	linear	linear	linear	linear	linear	linear	linear	linear
The threshold of indifference	5%	5%	5%	5%	5%	5%	5%	5%	5%	5%
The threshold of preferences	30%	30%	30%	30%	30%	30%	30%	30%	30%	30%
Units of measurement		mgKMnO <sub>4</sub> /l	mgN/l	mgN/l	mgCl <sup>-</sup> /l	mgSO <sub>4</sub> <sup>2-</sup> /l	mgP <sub>2</sub> O <sub>5</sub> /l	[mg]/l	[mg]/l	[mg]/l
Majdevo	8,0683	27,4863	0,5442	0,4777	8,7240	22,5800	0,1040	0,0612	0,0005	0,2896
Gornji Stepos	8,1616	8,3286	0,4290	0,4427	8,7780	23,1500	0,1050	0,0609	0,0008	0,2200
Mudrakovac	8,1983	11,0280	0,3712	0,5508	9,2980	17,1416	0,1260	0,1218	0,0008	0,2018
Novo kupaliste	8,1533	10,3710	0,4799	0,6060	9,5250	29,6950	0,1300	0,0635	0,0005	0,2711
Parun. most	8,3412	13,4216	0,2376	0,8706	10,6233	30,7200	0,1550	0,0978	0,0006	0,2956
Jablanicka	7,4900	24,9426	0,2391	0,6803	7,3716	26,9600	0,1660	0,1052	0,0007	0,3525
Nauparska	7,6966	6,8250	0,1504	0,7467	7,0776	23,5416	0,2160	0,0125	0,6681	0,3443
Trmcarska	7,0780	7,5880	0,2605	1,9778	10,2200	32,8180	0,2340	0,0000	0,0010	0,3040
Modricka	7,8966	6,4766	0,1556	0,8534	7,6300	25,2800	0,1060	0,0262	0,0006	0,3710
Lomnicka	7,4800	10,8650	0,5360	1,5991	7,3360	22,9316	0,2290	0,0929	0,0004	0,2765
Gaglovacka	7,5983	46,2633	0,6440	4,6281	46,1200	80,4426	1,0280	0,2256	0,0052	8,9559
Kobiljska	7,9316	16,6133	0,6588	1,3407	20,0866	41,6216	0,7030	0,1336	0,0006	3,7297



For defined scenario PROMETHEE rankings was performed with the help of software package Decision Lab 2000. Based on the data from Table 2, positive (F+) and negative (F-) flows values were obtained, as shown in Table 3.

**Table 3.** Web flows of preferences for a defined scenario

Measuring points	$\Phi^+$	$\Phi^-$	$\Phi$
Majdevo	0,4888	0,1080	0,3808
Gornji Stepos	0,4446	0,1853	0,2593
Mudrakovac	0,6105	0,1418	0,4687
Novo kupaliste	0,30043	0,2966	0,0037
Parun. most	0,2937	0,3660	- 0,00723
Jablanicka	0,4101	0,2006	0,2095
Nauparska	0,3354	0,2655	0,0698
Trmcarska	0,1832	0,5118	- 0,3286
Modricka	0,2982	0,3042	- 0,0060
Lomnicka	0,3601	0,2471	0,1130
Gaglovacka	0,1600	0,7580	- 0,5980
Kobiljska	0,1944	0,6943	- 0,4999

**Table 4.** Scenario preferences

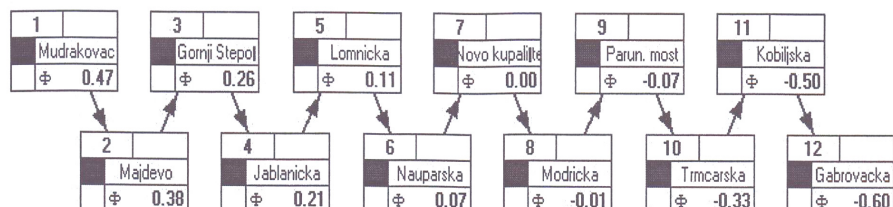
	pH	Oxidability	Ammonia	Total nitrogen oxides	Chlorides	Sulphates	Phosphates	Detergents	Phenols	Oils and fats in total
Type of function	4	4	4	4	4	4	4	4	4	4
Minimization	Accurate	Accurate	Accurate	Accurate	Accurate	Accurate	Accurate	Accurate	Accurate	Accurate
P	30	30	30	30	30	30	30	30	30	30
Q	5	5	5	5	5	5	5	5	5	5
S	50	50	50	50	50	50	50	50	50	50
Units	-	mgKMnO <sub>4</sub> /l	mgN/l	mgN/l	mgCl <sup>-</sup> /l	mgSO <sub>4</sub> 2 <sup>-</sup> /l	mgP <sub>2</sub> O <sub>5</sub> /l	[mg]/l	[mg]/l	[mg]/l
Scale	Numerical	Numerical	Numerical	Numerical	Numerical	Numerical	Numerical	Numerical	Numerical	Numerical
Weight	0,1102	0,2227	0,055	0,173	0,1789	0,4413	0,039	0,012	0,008	0,183

**Table 5.** Weight stability interval

	Absolute weights			Relative values (%)		
	Weight	Min	Max	Weight	Min	Max
pH	0,1102	0,0000	0,4407	7,74	0,00	25,13
Oxidability	0,2227	0,2041	0,2794	15,65	14,53	18,88
Ammonia	0,0550	0,0000	0,0661	3,86	0,00	4,61
Total nitrogen oxides	0,1730	0,1473	0,2576	12,16	10,54	17,09
Chlorides	0,1789	0,0614	0,2035	12,57	4,70	14,06
Sulphates	0,4413	0,2690	0,4769	31,01	21,51	32,70
Phosphates	0,0390	0,0000	0,0817	2,74	0,00	5,57
Detergents	0,0120	0,0000	0,0501	0,84	0,00	3,43
Phenols	0,0080	0,0000	0,0663	0,56	0,00	4,48
Oils and fats in total	0,1830	0,1609	0,3706	12,86	11,48	23,01

To determine the robustness of preference relations, an analysis of the stability of the interval was performed, as shown in Table 5. By this analysis stability intervals were obtained for each criteria, that define the limits within which the value of weighting coefficient of specific criteria can move, and that this has no effect on the result obtained

by PROMETHEE II ranking, whereby it the fact that the weight change may be performed only by one criteria must be adopted, while the relative weights of other criteria remain the same. Based on the obtained stability interval s it can be concluded that the final order of the ranking does not change when the weight coefficients vary in the shown boundaries.



**Figure 1.** PROMETHEE II complete ranking of measuring points at which sampling was carried out

PROMETHEE II has performed a complete ranking of sites, measuring points, from the best to worst, (alternative), taking into account the criteria (values of the pH parameters, Oxidability, Ammonia, Total nitrogen oxides, Chlorides, Sulphates, Phosphates, Detergents, Phenols, Oils and fats, and total), for a defined scenario (Table 1).

The results show that the best quality of water - the least contaminated sites, at a place called Mudrakovac, while the most polluted, with the worst water quality from Gaglovačka River.

### **PROPOSAL OF THE MEASURES FOR PROMOTION AND PROTECTION OF THE ENVIRONMENT**

In order to protect the environment and the entire ecosystem the following measures are necessary to undertake to protect and improve the environment:

1. Collection of solid waste from all residential areas including villages, proper allocation of the available containers, including public in joint activities.
2. Implement and control the technological procedure.
3. Reduce emissions by installing purification devices at the emission sources.
4. Growing the green areas in order to protect soil and groundwater from pollution, ensure proper storage of raw materials, semi products and finished products in accordance with specific laws and method of collection and treatment of waste materials.
5. Form the sewerage system and water supply network in rural areas.
6. Given that the concentrations of heavy metals in the soil increased, their origin should be determine, taking into account the geological composition of the soil.
7. Public participation and raising awareness through newspapers, films, posters, banners, TV, seminars, educational courses in schools, universities, institutions and companies.

8. Prohibition of waste disposal outside of the space reserved for that purpose.
9. Containers for primary waste disposal are planned for installation on each individual site, on the corresponding concrete surfaces. Permanent storage or disposal of waste materials of any kind of waste at stated location and outside of special containers is prohibited.
10. The prohibition waste water discharge without treatment.
11. Mandatory pre-treatment of specific factory waste water prior to discharge into the sewer system and the mandatory installation of equipment for wastewater treatment.
12. Recording of all pollutants in the city and implementation of water quality control.
13. Arrangement and regulation of Garski stream and other water courses in this zone with the planning, preservation and floristic enrichment.
14. Do an analysis of condition and location capabilities for existing work complexes within this zone as a condition for further activity with the obligatory assessment of environmental impact.

### CONCLUSION

Considering the impact of natural and anthropogenic factors it can be concluded that only by establishing control over anthropogenic sources of pollution (by placing an air purification system, treatment of waste water before discharge into the main recipient, the disposal of waste at sites designated for this purpose, less use of pesticides, creation of bypass roads, etc.) concentration of pollutants can be reduced and contribute to improving the quality of environment in the city of Krusevac.

### REFERENCES

1. Bojovic – Todorov M., Urbana ekologija, Beograd, 1993.
2. Velasevic V., Uticaj sumskih ekosistema na zivotnu sredinu, Beograd – Novi Sad, 1998.
3. Grupa autora (1979). Zastita i unapredjenje zivotne sredine. Beograd: Naucna knjiga. Nacionalni ekoloski akcioni plan u Srbiji, 2004.
4. Društvene promene, zastita zivotne sredine i obrazovanje, zbornik radova, Nis, 23-24. maj, 2002.
5. Djukanovic M., Ekoloski izazov, Elit, Beograd, 1991.
6. Djukanovic M., Ekoloske dimenzije u izgradjivanju prostora, Prosveta, Nis, 1984.
7. Djukanovic M., Osnovni uslovi higijene urbanog prostora u okviru Beograda, izgradnja 10, Beograd, 1981.
8. Djukanovic J., Zastita zivotne okoline, Sarajevo, 1990.
9. Ekoloski pokret "Bela breza" (White birch), Diverzitet flore i vegetacije severnog dela Velikog Jastrebca, Krusevac, 2004.
10. Zivkovic. N, Djordjevic A., Zastita vazduha, Univerzitet u Nisu, Fakultet zastite na radu, Nis, 2000.
11. Zagadjenost vazduha na teritoriji Republike Srbije u mrezi stanica zdravstvene sluzbe tokom 2005. Godine, Institut za zastitu zdravlja Srbije „Dr Milan Jovanovic Batut“, Beograd, 2006.

12. Zakovic A.R., Zagadjivanje i prečišćavanje vazduha, Gradjevinska knjiga, Beograd, 1981.
13. Zakon o zaštiti životne sredine RS, <http://www.ecoserb.gov.rs>
14. Jakovljevic M., Pantovic M., Hemija zemljišta i voda, Poljoprivredni fakultet, Beograd, naučna knjiga, 1991.
15. Jablanovic M., Biljka u zagadjenoj sredini, naučna knjiga, beograd, 1991.
16. Kristoforovic – Ilic M., Komunalna higijena, Prometej, Novi Sad
17. Meteorološki godišnjak – kvalitet vazduha, Republicki meteoroloski zavod
18. Milenovic B., Ekoloska ekonomija, Fakultet zaštite na radu, Nis, 1984.
19. Miloradov M., Marjanovic P., Bogdanovic S., Metodologija za izradu integralnog katastra zagadjivaca životne sredine, Agora, Beograd, 1998.
20. Milosavljevic M., Klimatologija, Naučna knjiga, Beograd, 1990.
21. Naučna stručna konferencija sa međunarodnim ucescem, zbornik radova, Beograd, 29. i 30. Oktobar 2009.
22. Perkins H.C. (1974), Air pollution, Tokyo: Mc-Grow-Hill
23. Plaznenic S., Tehnicka meteorologija, Naučna knjiga, Beograd, 1986.
24. Pravilnik o granicnim vrednostima, metodama merenja emisije, kriterijuma za uspostavljanje mernih mesta i evidenciji podataka, „sluzbeni glasnik RS“, br. 54/92, 30/99 i 19/06
25. Pravilnik o granicnim vrednostima emisije, nacinu i rokovima merenja i evidentiranja podataka, „Sluzbeni glasnik RS“, br. 30-97, 35/97 i izmene dopune 135/04
26. Prostorni plan opštine Krusevac, Direkcija za urbanizam, Krusevac
27. Rakovic A., Zagadjivanje i preciscavanje vazduha, Gradjevinska knjiga, Beograd, 1981.
28. Ristic V., Optimizacija izbora postupka upravljanja cvrstim otpadom, magistarska teza, Nis, 1997.
29. Rose R.D. (1972), Air pollution and Industry, New York: Van Nosstrand Reinhold Comp
30. SRPS ISO 14001:2005, Sistemi upravljanja zastitom životne sredine – Zahtevi sa uputstvom za primenu
31. SRPS OHSAS 18001:2008, Sistemi upravljanja zastitom zdravlja i bezbednoscu na radu – Zahtevi
32. Staletovic N., Razvoj metoda ocene i modela upravljanja ekoloskim rizikom u funkciji održivog razvoja, Doktorska disertacija, univerzitet u Novom Sadu, ACIMSI, Novi Sad, 2006.
33. Stankovic-Nusic D., Aerozagadjenje i zdravlje, Beograd 2003.
34. Stern C. (1977), Air pollution, New York: Academic Press
35. Strucni nalazi o izvrsenim merenjima, Gradski zavod za javno zdravlje, Krusevac
36. Tomic P., Markovic S., (1996), Turizam i zaštita sredine – Skripta za studente, Novi Sad: Prirodno-matematicki fakultet, Institut za geografiju
37. Tosovic S., Koncentracija toksicnih materija u vazduhu od znacaja za procenu zona opasnosti od hemijskih udesa, Beograd, 2004. Tchobanoglous G., Theisen H., Eliassen R., (1977), Solid Wastes, tokyo: MCGraw-Hill
38. Uredba o uslovima za merna mesta, monitoring i zahtevima kvaliteta vazduha, „Sluzbeni glasnik RS“ br. 11/2010.
39. Dzamic R., Stevanovic D., Agrohemija, Partenon, Beograd, 2002.



## THE IMPACT IN SITU OF GEOMECHANICAL INVESTIGATIONS ON EFFECTS OF THE ENVIRONMENTAL PROTECTION – ZAGRAD

Jelena Majstorovic<sup>1</sup>, M. Korac<sup>2</sup>, S. Savkovic<sup>1\*</sup>

<sup>1</sup>University of Belgrade, Faculty of Mining and Geology, Belgrade, SERBIA

<sup>2</sup>Open pit Bauxite mine “Zagrad” – Niksic, MONTENEGRO

\*savkovic.snezana@yahoo.com

### ABSTRACT

Sometimes standard examinations do not provide the data which are relevant enough, mostly because of the special properties of the working environment, which is in this case the moraine material on the open pit bauxite mine “Zagrad” near Niksic. During the open pit mine exploitation of moraine material, with making and development of the working benches, it was notable, that in their geometry, inclination and height exist a significant reserve in their safety. Research “in situ” of moraine material was applied. The results of these investigations have enabled the design of work and final slopes. It provided significant savings in the amount of the chats in its transport and disposal, this has had positive effects on the environmental protection.

**Key words:** Environmental protection, moraine, “in situ” investigations, bauxite.

### INTRODUCTION

Zagrad deposit is one of the largest sites of red bauxite in the former Yugoslavia. Moraine material is located in the roof. Depending from the position of profile, moraine material occupies from 1 to 100 m depth.

General characteristics of moraine material are:

- different in composition and to size pieces and grains,
- moraine material consists of mainly rounded or slightly rounded angular grains with sharp edges,
- the material is usually scarred due to tearing during transport, allowing its recognition and position determination glacier,
- heterogenous material with wide boundaries regarding moraine granulometric content, in the moraines can be found silt, sand, large pieces of rocks and blocks.

Moraine material has a specific grain size distribution, that is why can not be tested using standard laboratory procedures on standard small test bodies. This material

with very specific granulometric content, can not be examined with standard laboratory procedures on small samples. By using small samples, the structure of this material is destroyed and obtained values for the angle of internal friction ( $\varphi$ ) and cohesion ( $c$ ) are no longer valid.

### **MORAINIC MATERIAL GRANULOMETRIC CONTENT**

Moraine material with very specific granulometric content has a high degree of unevenness. Size of moraine material particles are from 0.02 mm to 3000 mm. Figure 1, shows size of particles in moraine material.



**Figure 1.** Sample for direct shear test and test body block [1].

We used a number of methods for determining particle size distribution content. On-site was used to analysis by sieving. Screening is done with 12 sieve whose openings are: 160; 125; 100; 80; 50; 30; 25; 20; 15; 12; 10 and less than 10 mm. Moraine material which is less than 10 mm was examined in the laboratory Rock mechanics laboratory in Faculty of Mining and Geology, method sieving and areometer method. Moraine material which is less than 10 mm is sifted through a sieve size: 20; 10; 5; 3; 2 and 0.2 mm. Fractions which are less than 0.2 mm were analyzed by the method of areometer, and were separated dust clay fractions.

Granulometric analysis results, average (mean) values are shown in figure 2.

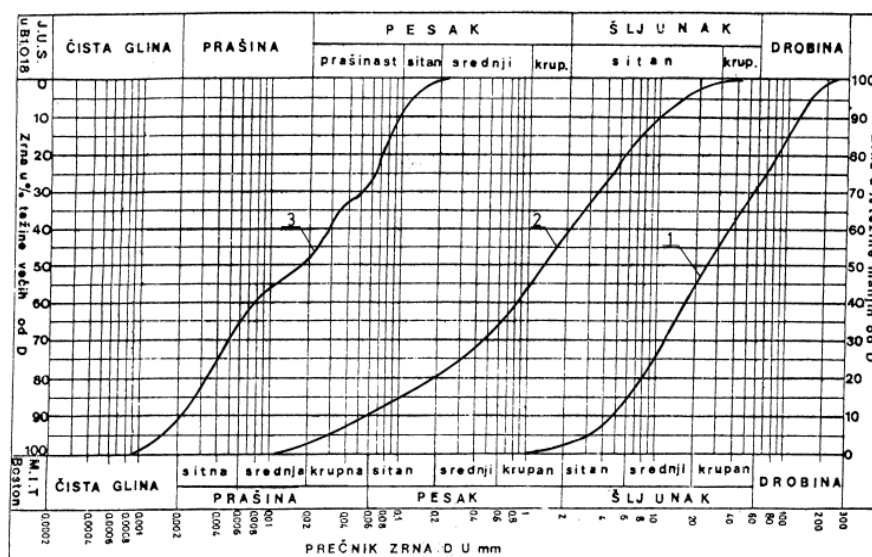


Figure 2. Granulometric Diagram of mean values: 1) On terrain; 2) Laboratory conditions; 3) Areometer method.[2]

#### “IN SITU” INVESTIGATIONS RESULTS OF SHEAR STRENGTH PARAMETERS

Laboratory investigations of moraine material (the angle of internal friction –  $\varphi$  and cohesion - c) were carried out by the current standards. Results are shown in table 1.

Table 1.

Lithologic unit	Angle of internal friction $\varphi$ (°)	c (kN/m <sup>2</sup> )	$\gamma$ (kN/m <sup>3</sup> )
Moraine material	29.83	5.76	20.36

On the basis of the data for the angle of internal friction ( $\varphi$ ) and cohesion (c) for the moraine material, the following geometry was adopted for the moraine material:

- for working bench:  $h = 15.0$  m;  $\alpha = 42^\circ$ ,
- for final slope:  $H = 100.0$  m:  $\alpha = 23^\circ$ .

During the open pit mine exploitation of moraine material, with making and development of the working benches, it was notable, a significant reserve in their safety. Research “in situ” of moraine material was applied. Angle of internal friction ( $\varphi$ ) and cohesion (c) were determined on the terrain “in situ”. The shear tests were carried out on the blocks of large dimensions, on the predisposed angles:  $\alpha_1 = 60^\circ$ ;  $\alpha_2 = 45^\circ$ ;  $\alpha_3 = 30^\circ$ .

Making of the blocks with dimensions of 60 cm x 60 cm was done in the way that the moraine material is not distracted, so that the connection between the individual granulites is not interrupted, which would not give the real values for cohesion.

The figure 3, shows the results of the direct shear test, on the blocks 40 x 40 x 60 cm and the results obtained by the reverse stability analysis of slopes in moraine material.

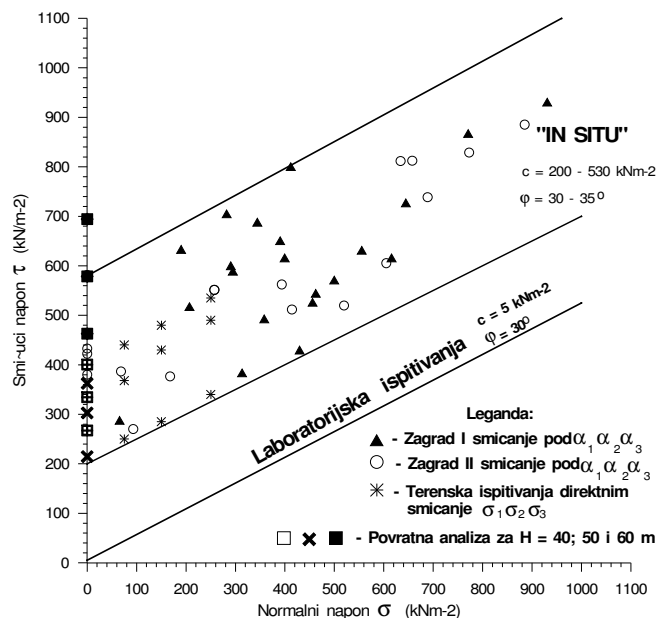


Figure 3. Shear test and reverse stability analysis of slopes in moraine material

With analysis shown in Figure 3, for the designing working and final slopes in moraine material the following values are adopted:

$$\begin{aligned} \gamma &= 23,14 \text{ KN/m}^3 \\ c &= 200,00 \text{ KN/m}^2 \\ \varphi &= 30^\circ. \end{aligned}$$

Based on this values verified geometry of the final slopes in moraine material is shown in table 2.

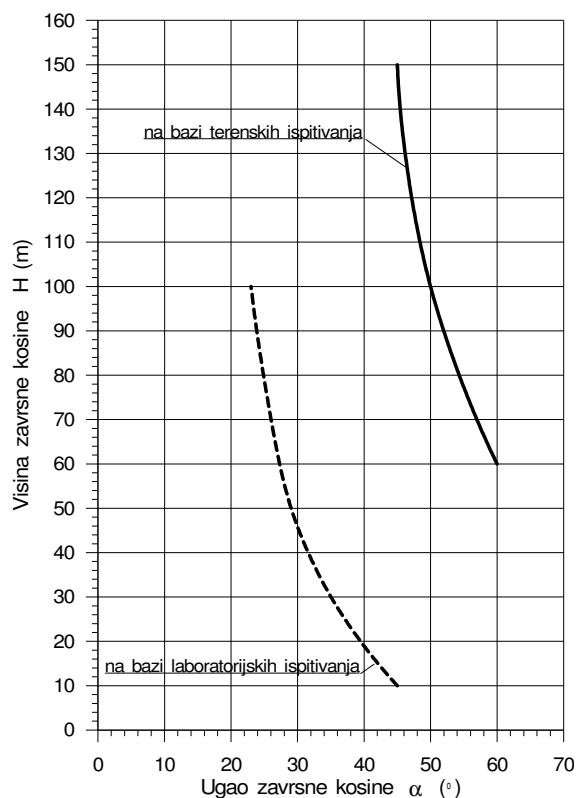
Table 2.

Maximal heights and angles $\alpha$ of the final slopes for safety factor $F_S = 1.3$		
Type of material	$\alpha$ (°)	H (m)
Moraine material	45	150
	50	100
	60	60



## CONCLUSION

On the figure 4, beside the existing slope defined by laboratory shear tests, the slope which was determined by “in situ” test is shown, too. It is obvious that the terrain tests have confirmed that the cohesion of moraine is not  $5 \text{ kN/m}^2$ . Actual value of moraine cohesion is from  $200 - 500 \text{ kN/m}^2$ , which is 100 times larger than the values determined in laboratory. This allowed to form the slope  $\alpha = 50^\circ$  on the profile of mine, with moraine material of 100 m thickness, instead of former slope  $\alpha = 23^\circ$ .

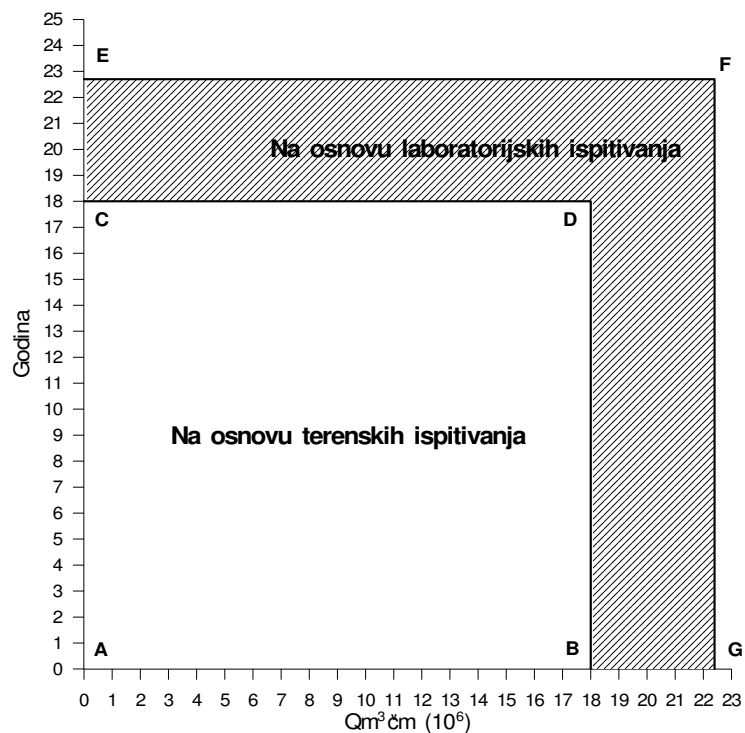


**Figure 4.** Diagram of dependence between slope  $\alpha$  and height  $H$  for safety factor  $F_s = 1.3$ . [1]

The extent of the influence of the increased reliability of determining the physical and mechanical properties of the working environment, can be seen, with arguments, on the example of open pit bauxite mine “Zagrad” near Niksic, in Montenegro.

In the case of open pit bauxite mine, deeper location of mineral raw materials is followed by larger layers of chats. In this case the costs of excavation, transport and disposal of chats are growing with increasing of the depth. As a consequence, there is also a growing peril for environment. A million cubic meters of excavated chats should be transported and put away, which occupies great surfaces of the surrounding terrain.

The newly formed angles of final slopes in moraine material, with slopes  $\alpha = 23^\circ$  and later  $\alpha = 50^\circ$  caused great and significant savings in exploitation costs of the bauxite ore on the "Zagrad" deposit.



**Figure 5.** Graphic view of the time of exploitation and the amount of excavated waste for the condition  $\alpha = 23^\circ$  and  $\alpha = 50^\circ$   
 ABCD – time and amounts for the final slopes of  $\alpha = 50^\circ$   
 AGEF – time and space for the final slopes of  $\alpha = 25^\circ$ . [3]

Among other savings, the savings consists in the following:

- savings in the reduced volume of excavated moraine material by forming the final slopes, which are around  $3 - 4 \text{ € / m}^3$ ;
- savings in the reduced excavating of limestone in the final slope, around  $7.15 \text{ € / m}^3$ ;
- savings in the reduced duration of exploitation of deposit for 4, 5 years;

- savings through the increased mining of the bauxite ore (45 000 tonnes);
- savings in the space and volume of the waste dump, on which 4 500 000 m<sup>3</sup> was not disposed.

These savings were achieved by using the data for the properties of moraine material – the angle of internal friction ( $\varphi$ ) and cohesion ( $c$ ), determined on terrain (“in situ”) and in all they amount: 32 500 000 €.

#### **REFERENCES**

1. Cvetkovic M., Popovic R., Majstorovic J.: Uticaj dimenzije uzorka na odredjivanje parametara otpora pri smicanju morenskog materijala na PK “Zagrad”, Medjunarodni naucni skup Pravci razvoja Geotehnike, Beograd, 1996.
2. Korac M.: Metodologija istrazivanja morenskog materijala u funkciji sistema povrnsinske eksploatacije, doktorska disertacija, RGF, Univerzitet u Beogradu, 2002.
3. Korac M., Cvetkovic M., Majstorovic J.: Uticaj promene ugla završne kosine na ekonomske efekte eksploatacije, IMES'03 (Informatika, menadžment, ekologija i standardi), Aradjelovac, 2003.



## THE WATER TEMPERATURE TRENDS OF THE SAVA RIVER IN SERBIA

Milan Milenkovic<sup>1\*</sup>, V. Babic<sup>2</sup>, V. Ducic<sup>3</sup>, M. Krstic<sup>2</sup>, B. Lazic<sup>3</sup>

<sup>1</sup>Geographical Institute »Jovan Cvijic«, Serbian Academy of Sciences and Arts, Belgrade, SERBIA

<sup>2</sup>University of Belgrade, Faculty of Forestry, Belgrade, SERBIA

<sup>3</sup>University of Belgrade, Faculty of Geography, Belgrade, SERBIA

\**m.milenkovic@gi.sanu.ac.rs*

### ABSTRACT

The research of water temperature trends of the Sava River used the datasets from the hydrological stations Šabac and Belgrade. Mostly positive trends were recorded. Trends for Šabac station were not statistically significant. Negative trends were recorded for September and October (1983-2014), as well as for February, March, May, June, August, spring and summer (the hiatus period, 1998-2014). Trends for Belgrade (1983-2014) were all positive: November and year ( $p=0.01$ ), January, April, July, December and all seasons ( $p=0.05$ ). The trend for the hiatus period were not statistically significant and negative values were recorded for February, March, May, June, spring and summer.

**Key words:** water temperature, trends, Sava, Serbia.

### INTRODUCTION

According to IPCC [1] there has been a trend of global warming since the end of the 19<sup>th</sup> century. The anthropogenic emission of CO<sub>2</sub> and other greenhouse gases (GHG) was marked as the main cause of this phenomenon. However, since 1998 there has been a hiatus in the increase of global temperature, despite the continuous increase in CO<sub>2</sub> concentration [2]. The well-known term “global warming” has been replaced with the term “climate change”. The majority of the investigation in this field is focused on air temperature, but there have also been researches on the river water temperature [3-8].

The Sava river is a Central European river and a right tributary of the Danube which flows through Slovenia, Croatia (also a border with Bosnia and Herzegovina), and Serbia. The total length of the Sava is 990 km.

The water temperature of the Sava was researched at Zagreb (1948-1998) and Slavonski Brod (1956-1998) stations. Increasing trends in the maximum annual water temperature were recorded at both stations: Zagreb (0.06°C per year) and Slavonski Brod (0.05°C per year). There has also been an increase in minimum annual water temperature – since 1965 the river has not frozen, but in the earlier period the freezing was frequent [9].

The length of the Sava River in Serbia is 206 km. The river mouth is in Belgrade. There are four hydrological stations at Sava in Serbia: Jamena, Sremska Mitrovica, Šabac and Beograd. Missing data present the major problem in the river water temperature research in Serbia. There are a lot of missing data from the stations Jamena and Sremska Mitrovica. The situation is much better with the other two stations – only a few missing data. The aim of the research was the analysis of the water temperature trends at stations Šabac and Beograd in the periods 1983-2014 and 1998-2014.

### DATA AND METHODS

Mean monthly, seasonal and annual water temperature data from the hydrological stations Šabac and Belgrade [10] on the Sava were used in the research. The water temperature data refer to the period 1983-2014. The problem with missing data was solved by the method of interpolation. Data from the nearest meteorological stations Šabac and Belgrade were also used [11]. The significance of the trends was determined from the equation:

$$y = R[(n-2)/(1-R^2)]^{1/2}$$

where  $R^2$  – coefficient of determination,  $n$  – length of the series

### RESULTS

The water temperature trends at the hydrological station Šabac are shown in Table 1.

**Table 1.** The water temperature trends of the Sava: hydrological station Šabac

Water Temperature Šabac	Periods	
	1983-2014 Trend (°C/ per year)	1998-2014 Trend (°C/ per year)
January	0.0414	0.0775
February	0.0119	-0.037
March	0.0297	-0.0059
April	0.0235	0.0412
May	0.006	-0.091
June	0.037	-0.0721
July	0.0348	0.0388
August	0.0118	-0.0023
September	-0.0056	0.0395
October	-0.0113	0.0144
November	0.0388	0.038
December	0.0186	0.0681
Winter	0.0244	0.0244
Spring	0.0197	-0.0186
Summer	0.0278	-0.0118
Autumn	0.0073	0.0307
Year	0.0197	0.0091

\* - significant at 0.05; \*\* - significant at 0.01; Note: the period 1984-2014 for winter

Water temperature trends at Šabac station were not statistically significant. On the monthly level, negative trends were recorded for September and October (1983-2014), as well as for February, March, May, June and August (hiatus period). On the seasonal level, negative trends were determined for spring and summer (hiatus).

The trends of surface air temperature at the nearest meteorological station Šabac were also analyzed (Table 2).

**Table 2.** The surface air temperature trends: meteorological station Šabac

Surface Air Temperature Šabac	Periods	
	1983-2014	1998-2014
	Trend (°C/ per year)	Trend (°C/ per year)
January	0.0463	0.1122
February	0.0616	-0.098
March	0.0637	0.0221
April	0.0355	0.0062
May	0.0294	-0.059
June	0.0883	-0.03
July	0.0653**	0.0392
August	0.0423	-0.0341
September	0.0158	0.0436
October	0.0582	-0.0089
November	0.096*	0.1235
December	0.0251	0.2025*
Winter	0.0364	0.0509
Spring	0.0429	-0.0103
Summer	0.0653**	-0.0083
Autumn	0.0566*	0.0528
Year	0.0523**	0.0266

\* - significant at 0.05; \*\* - significant at 0.01;

Unlike water temperature, in the case of surface air temperature (Šabac) statistically significant increasing trends were recorded for the period 1983-2014: July, summer and year ( $p=0.01$ ), November and autumn ( $p=0.05$ ). For the hiatus period statistically significant increase ( $p=0.05$ ) was recorded only for December, and negative trends for four months (February, May, June and August) and two seasons (spring and summer).

The water temperature trends at the hydrological station Belgrade were shown in Table 3.

**Table 3.** The water temperature trends of the Sava: hydrological station Belgrade

Water Temperature Beograd	Periods	
	1983-2014 Trend (°C/ per year)	1998-2014 Trend (°C/ per year)
January	0.0553*	0.1034
February	0.0224	-0.0262
March	0.053	-0.0201
April	0.056*	0.0439
May	0.0373	-0.0848
June	0.0686	-0.0936
July	0.0902*	0.0581
August	0.0591	0.0064
September	0.0549	0.0493
October	0.0391	0.052
November	0.0699**	0.0559
December	0.0519*	0.0941
Winter	0.0431*	0.0482
Spring	0.0488*	-0.0203
Summer	0.0726*	-0.0097
Autumn	0.0546*	0.0524
Year	0.0548**	0.0199

\* - significant at 0.05; \*\* - significant at 0.01; Note: the period 1984-2014 for winter

Unlike water temperature at Šabac station, some statistically significant increasing trends were recorded at Belgrade station for the period 1983-2014: November and year ( $p=0.01$ ), January, April, July, December and all seasons ( $p=0.05$ ). Trends for the hiatus period were not statistically significant and negative values were recorded for February, March, May, June, spring and summer.

The trends of surface air temperature at the nearest meteorological station Beograd were also analyzed (Table 4).

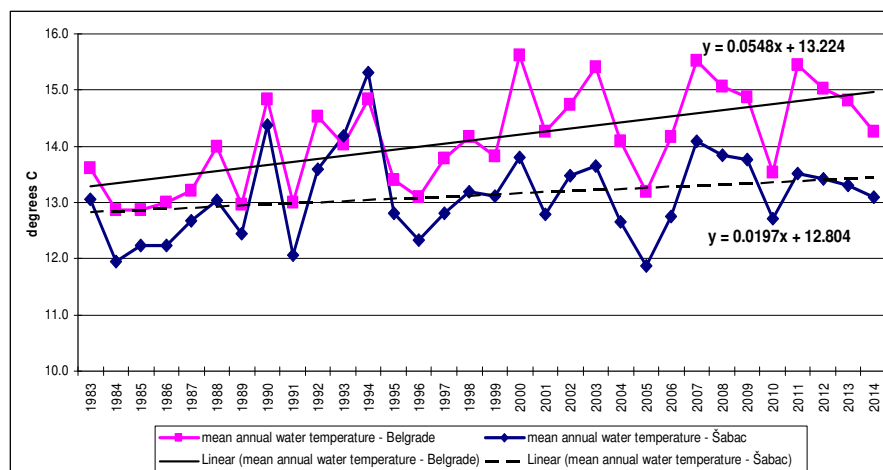
At Belgrade meteorological station, statistically significant increasing trends in surface air temperature (1983-2014) were recorded for June, July, November, summer and year ( $p=0.01$ ), as well as for August and spring ( $p=0.05$ ). Statistically significant increasing trends in surface air temperature were also recorded for the hiatus period: July, December, autumn and year ( $p=0.05$ ). Statistically insignificant decrease trends were determined only February and May.

**Table 4.** The surface air temperature trends: meteorological station Beograd

Surface Air Temperature Beograd	Periods	
	1983-2014	1998-2014
	Trend (°C/ per year)	
January	0.0403	0.0735
February	0.0581	-0.099
March	0.0734	0.0471
April	0.0532	0.0679
May	0.0385	-0.0103
June	0.1069**	0.0338
July	0.0825**	0.1137*
August	0.0748*	0.0686
September	0.0287	0.139
October	0.0491	0.0135
November	0.1337**	0.1765
December	0.0379	0.1968*
Winter	0.037	0.0359
Spring	0.055*	0.0349
Summer	0.0881**	0.0721
Autumn	0.0705**	0.1096*
Year	0.0648**	0.0684*

\* - significant at 0.05; \*\* - significant at 0.01;

Mean annual water temperature trends for hydrological stations Šabac and Belgrade are shown in Figure 1.



**Figure 1.** Trends of mean annual water temperature - hydrological stations Šabac and Belgrade



## DISCUSSION

The results are in compliance with the IPCC Report [1], which means that in most of the cases they point to the slowing down of the increase in river water temperature and surface air temperature. It is interesting that there has been a hiatus at the global scale despite the continuous increase in CO<sub>2</sub> [2].

The differences in the results for Šabac and Belgrade can also be seen, both for hydrological and meteorological stations. The analysis of the data from hydrological station Belgrade showed some statistically significant increasing trends, and decreasing trends were recorded in a smaller number in comparison to Šabac station. The increase in the surface air temperature at Belgrade station was also more intensive compared to Šabac station. The results can be explained by anthropogenic influences, above all by the fact that Belgrade is an urban heat island (UHI) much more than Šabac. Similarly, other researchers [9] recorded more intensive increase in the temperature of big cities in comparison to smaller ones.

However, more detailed researches that use extended databases are required for more precise conclusions. The problem with incomplete databases should also be solved.

There has been an apparent hiatus in temperature increase on the global level. According to the IPCC models, the main cause for the temperature growth is the increase in CO<sub>2</sub> and other GHG gases. However, some authors predict significant decrease in the temperature at the global scale in the following decades [12].

## CONCLUSION

At hydrological station Šabac, statistically significant water temperature trends have not been recorded. For the period 1983-2014 the trends were positive, with negative trends being recorded only for September and October. In the hiatus period (1998-2014) negative trends were recorded for February, March, May, June, August, spring and summer. For surface air temperature (Šabac) all trends in the period 1983-2014 were positive. Statistically significant increasing trends were recorded for July, summer and year ( $p=0.01$ ), as well as for November and autumn ( $p=0.05$ ). In the hiatus period the trend was statistically significant ( $p=0.05$ ) only for December, and negative trends were recorded for February, May, June, August, spring and summer.

At hydrological station Belgrade, all water temperature trends were positive in the period 1983-2014. Statistically significant trends were for: November and year ( $p=0.01$ ), January, April, July, December and all seasons ( $p=0.05$ ). In the hiatus period, the trends were not statistically significant and negative values were recorded for February, March, May, June, spring and summer. Surface air temperature in Belgrade also had increasing trends in the 1983-2014 period, and statistically significant trends were recorded for June, July, November, summer, autumn and year ( $p=0.01$ ), as well as for August and summer ( $p=0.05$ ). In the hiatus period statistically significant increasing trends were determined for: July, December, autumn and year ( $p=0.05$ ). Statistically insignificant decreasing trends were recorded only for February and May.

According to the results, a more intensive increase of water temperature and air temperature occurs in Belgrade. The reason, among other factors, lies in anthropogenic influences (urban heat island). The results are in compliance with the IPCC allegation on the existence of hiatus in the increase of global temperature.

### **Acknowledgements**

*The work is a part of the project 47007 III funded by the Ministry of Education, Science and Technological Development of the Republic of Serbia.*

### **REFERENCES**

1. Intergovernmental Panel on Climate Change (IPCC), [https://www.ipcc.ch/pdf/assessment-report/ar5/wg1/WG1AR5\\_SPM\\_FINAL.pdf](https://www.ipcc.ch/pdf/assessment-report/ar5/wg1/WG1AR5_SPM_FINAL.pdf)
2. [https://climexp.knmi.nl/data/imaunaloa\\_f.dat](https://climexp.knmi.nl/data/imaunaloa_f.dat)
3. Webb, B. W., Nobilis, F., 1994, Water Temperature Behaviour in the River Danube during Twentieth Century, *Hydrobiologia*, 291(2), 105-113
4. Zweimuller, I., 2007, Temperature Increase in the Austrian Danube – Causes and Consequences, *Geophysical Research Abstracts*, 9, 11359
5. Pekarova, P., Halmova, D., Miklanek, P., Onderka, M., Pekar, J., Skoda, P., 2008, Is the Water Temperature of the Danube River at Bratislava, Slovakia, Rising? *Journal of Hydrometeorology*, 9(5), 1115-1122
6. Kaushal, S. S., Likens, G. E., Jaworski, N. A., Pace, M. L., Sides, A. M., Seekell, D., Belt, K. T., Secor, D. H., Wingate, R. L., 2010, Rising stream and river temperatures in the United States, *Frontiers in Ecology and the Environment*, 8(9), 461-466
7. Lovász, G., 2012, Water temperatures of the Danube and Tisza Rivers in Hungary, *Hungarian Geographical Bulletin*, 61(4), 317-325
8. Orr, H. G., et al., 2015, Detecting changing river temperatures in England and Wales, *Hydrological Processes*, 29(5), 752-766
9. Bonacci, O., Trninić, D., Roje-Bonacci, T., 2008, Analysis of the Water Temperature Regime of the Danube and its Tributaries in Croatia, *Hydrological Processes*, 22(7), 1014-1021
10. Republic Hydrometeorological Service of Serbia, Belgrade, Serbia, [http://www.hidmet.gov.rs/ciril/hidrologija/povrsinske\\_godisnjaci.php](http://www.hidmet.gov.rs/ciril/hidrologija/povrsinske_godisnjaci.php)
11. Republic Hydrometeorological Service of Serbia, Belgrade, Serbia, [http://www.hidmet.gov.rs/ciril/meteorologija/klimatologija\\_godisnjaci.php](http://www.hidmet.gov.rs/ciril/meteorologija/klimatologija_godisnjaci.php)
12. Abdussamatov, H. (2015). Current Long-Term Negative Average Annual Energy Balance of the Earth Leads to the New Little Ice Age, *Thermal Science*, 19, Suppl. 2, S279-S288



## ATMOSPHERIC POLLUTERS RELEASED FROM INDUSTRIAL PLANTS. FACTORS OF RISK PERTAINING TO CANCER

Biserka Dimishkovska<sup>1\*</sup>, N. Dimishkovski<sup>2</sup>, J. Dimishkovski<sup>3</sup>

<sup>1</sup>“Ss.Cyril and Methodius” University, Institute of Earthquake Engineering and Engineering Seismology, Skopje, REPUBLIC OF MACEDONIA

<sup>2</sup>“Ss.Cyril and Methodius” University, Faculty of Economics, Skopje, REPUBLIC OF MACEDONIA

<sup>3</sup>“Ss.Cyril and Methodius” University “, Faculty of Mechanical Engineering, Skopje, REPUBLIC OF MACEDONIA

\**biserka@pluto.izis.ukim.edu.mk*

### ABSTRACT

Transportation, dispersion, settlement, accumulation, chemical reactions and release of pollutants can affect human health, vegetation and other elements of the ecosystem. The main path of exposure to the effects of atmospheric pollutants is through inhalation. Presented further will be the transportation and the paths of effect of the atmospheric pollutants like: sulfuric dioxide, nitrogen oxides, particles, traces of metals and organic substances. The lead and zinc smeltery in Veles, R. Macedonia will be studied as a polluter of the atmosphere.

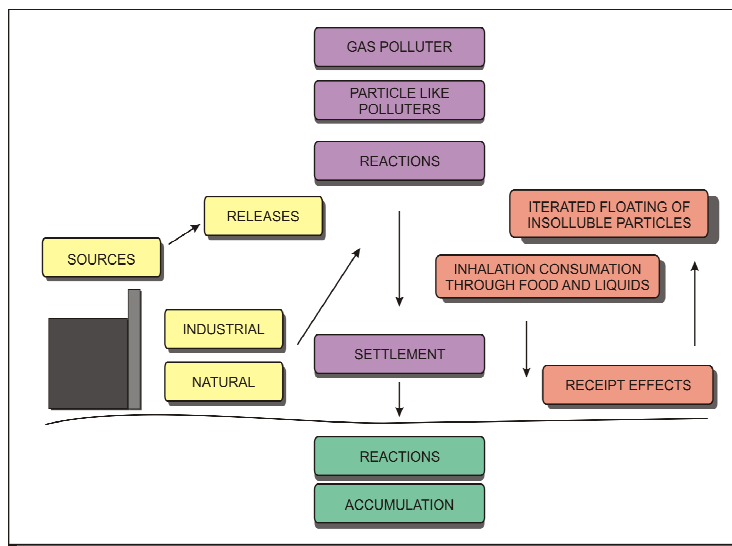
The risk factor associated with annual pollution with arsenic, lead and cadmium was analyzed and defined. The average risk factors related to exceeding mortality due to pollution with sulfuric dioxide and particles of materials were also computed. Given these values of risk factors, the effect of the pollutants upon the human health in the Veles area was easily proved. The measured quantities of these pollutants were twice higher than the allowed ones. Based on these values and using a probabilistic approach, the individual risk for occurrence of cancer and exceeding mortality was computed.

**Key words:** human environment, atmospheric pollutants, industrial plants, risk factors, effects upon health.

### INTRODUCTION

The description of the transportation and the paths of effects of atmospheric pollutants are presented in Fig. 1.

Considerable effects upon the environment can also be exerted by many atmospheric pollutants during their release. These could be: sulphuric dioxide, nitrogen oxides, particles, traces of metals, organic substances, etc. More concretely, we have investigated the pollutants that could be released from the lead and zinc smeltery “ZLETOVO” in Veles, the Republic of Macedonia.



**Figure 1.** Transportation and paths of effects of atmospheric pollutants

The data on releases from the smeltery transmitted through the air will be presented further in this paper. The dispersion of harmful matter can be long term (years) and short term (for example, 24 hours). The enclosed diagrams show the dispersion of the harmful matter during the release, i.e., dispersion of lead and cadmium as long term concentrations in the air.

The consideration of the effect upon health caused by the pollutants is mainly based on data from the WHO Instructions for Air Quality [1,7].

The atmospheric effects along with the climatic, meteorological factors, the configuration of the terrain, the population, the cultural habits, the industrial compounds, affect the health status and the mortality of the population. The urban distribution, the inappropriate industrial facilities and other factors potentially affect the health of the population. Chronic respiratory diseases are present among the population equally throughout all the months of the year. In addition to these diseases, atmospheric effects double many other chronic diseases. Important for the occurrence of these diseases are also the decennial pollutions caused by industrial plants, gases released from vehicles, frequent occurrence of fog, bad circulation of air with absence of winds, etc.

The relation between the concentration in the air and the toxic effect is usually evaluated with difficulty wherefore consideration is given to the main and most important path of intoxication, i.e., consumption of toxic substances through food or liquids (for example, Cd, Pb). [3].

Risk assessments have been made based on a realistic scientific judgement, whereas the dispersion of lead and cadmium has been computed according to the Gauss' model of dispersion.

## RISK FACTOR TECHNIQUE

Approximate risk factors (risk pertaining to exposure to some concentration in a unit of time) are used in the computations of the potential effects upon human health.

The risk factors pertaining to occurrence of cancer have been considered for the population affected by the lead and zinc smeltery "ZLETOVO", which is at a distance of 2 km from the centre of Veles in the Republic of Macedonia. Veles is situated in a small valley along the Vardar river flow, at an altitude of 175 metres. The town has 60 000 inhabitants, representing 3,2% of the total population in the Republic of Macedonia. The lead and zinc smeltery is situated north of the town, in a terrain at an average altitude of 175 metres. It uses the Imperial Smelting technology and can produce a maximum of 105 000 tons of zinc and lead annually (out of which 38 000 tons of lead).

The air quality in the town of Veles is affected by SO<sub>2</sub> and cadmium dust in concentrations that are ten times higher than the maximum allowed. The same is the case with the defined quantities of lead and cadmium pollution. The lead and cadmium content in the vegetables and fruits exceeds the allowable limits in some raisings for more than ten times (75 times more lead and 90 times more cadmium in the green salad and spinach). Large concentrations have also been found in the fodder (clover and hay) which leads to the conclusion that harmful metals have also entered the food chain of animals and people.

The extensive pollution has affected the health of the population, whereat an increase of the morbidity rate in some respiratory diseases from 634% in 1988 to 986% in 1992 has been observed. The index of increase of respiratory diseases is 178,7% annually. A higher level of lead in blood and changes of urine has been observed among the examined persons and particularly among the children. This factor of risk pertaining to cancer disease as the heaviest disease caused by polluters is presented in Table 2.

**Table 2.** Risk factors pertaining to cancer

POLLUTERS	RISK FACTOR RF (cases.µg/m3 per annum)
ARSENIC, As	8*10 <sup>-5</sup>
LEAD, Pb	10*10 <sup>-5</sup>
CADMIUM, Cd	8*10 <sup>-5</sup>

The average risk factors pertaining to excessive mortality for particles of sulphur dioxide are given in Table 3 [13, 11, 6, 10].

**Table 3.** Average risk factors

POLLUTERS	EXCESSIVE MORTALITY (cases µg/m3 per annum)
SULPHURIC DIOXIDE, SO <sub>2</sub>	~ 5*10 <sup>-6</sup>
MATERIAL PARTICLES	~ 10 <sup>-5</sup>

The effects upon health that contribute to the annual exposure might not refer to a particular year, but could be distributed throughout the life time of the individual. For each hazardous material, an average risk factor has been selected. The effect of the Zletovo lead and zinc smeltery upon different locations (which are at a certain distance from it) can be computed by multiplying the concentration (Table 4) in respect to the population by the time of exposure and the factor of risk pertaining to health. The results of the measurements performed for the smeltery are presented in Table 4.

**Table 4.** Lead, cadmium and sulphur dioxide emission in the air in  $\mu\text{g}/\text{m}^3$  (MDK: 0.7  $\mu\text{g}/\text{m}^3$  lead; 0.03  $\mu\text{g}/\text{m}^3$  cadmium; 50  $\mu\text{g}/\text{m}^3$  sulphur dioxide)

AREA	LEAD	CADMIUM	SULPHUR DIOXIDE	
	MIN./MAX.	MIN./MAX.	ANNUAL AVERAGE	MAX.
METEOROLOGI-CAL STATION	4.45 - 6.64	0.00 - 0.89	193	681
TEKE	0.44 - 5.39	0.00 - 4.67	118	804
BASINO VILLAGE	0.00 - 0.92	0.00 - 0.04	39	684
GRADSKO (VELES)	0.00 - 0.19	0.00 - 0.00	64	405

#### COMPARISON WITH THE VALUES GIVEN IN THE INSTRUCTIONS

The adverse effects (non-cancerous risks) have been treated by comparison of the concentration of the pollutants with the values given in the instructions. Adverse effects can involve diseases, death, etc. The typical values given in the instructions [1] are given in Table 5.

**Table 5.** Values given in the instructions

POLLUTERS	CONCENTRATIONS ACCORDING TO INSTRUCTIONS $\mu\text{g}/\text{m}^3$	
	ANNUALY	DAILY
CADMIUM, Cd	0.01-0.02	
SULPHURIC MONOXIDE, CO		10000(8h)
MATERIAL PARTICLES	50	120
SULPHUR DIOXIDE, SO <sub>2</sub>	50	120

Analysing Table 4 and Table 5, it can be observed that the sulphur dioxide level at TEKE is 118  $\mu\text{g}/\text{m}^3$  while according to the instructions, it is 50  $\mu\text{g}/\text{m}^3$  per annum, the difference being twice bigger. The same is with the cadmium.

#### APPLICATION OF MODEL

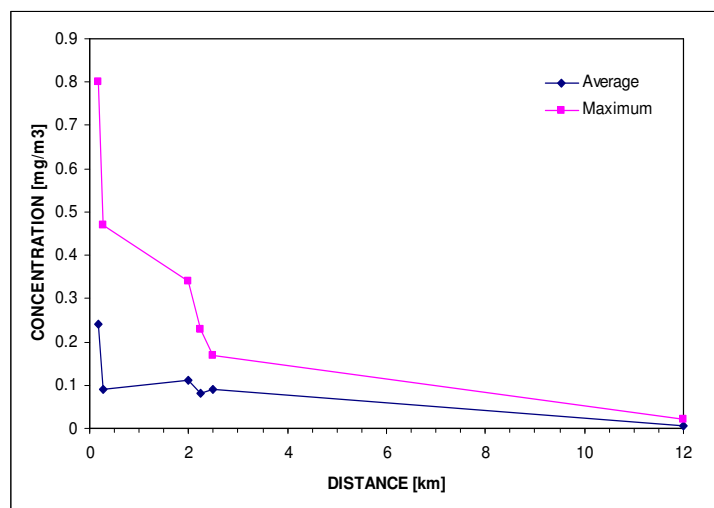
The model, which is the subject of discussion and comparison, is presented with dispersion of propagation of the lead and cadmium for a certain height of release and for long term average concentrations presented in Fig. 2 and Fig. 3.

The computed approximate risk values are given in Table 6. The individual risk pertaining to cancer at a distance of 1 km amounts to  $10^{-4}$  annually, while the individual risk pertaining to excessive mortality amounts to  $10^{-2}$  annually, [2]. For the Zletovo smeltery location, it has been estimated that most of the adverse effects upon health occur at a distance of 0.5 to 100 km. The computed number of cancer cases can be about 3, while the value for the excessive mortality due to the annual releases can be about 100. The evaluated risk pertaining to excessive occurrence of diseases is 10-30 times higher, as shown also by the statistics of persons affected by diseases in the town of Veles.

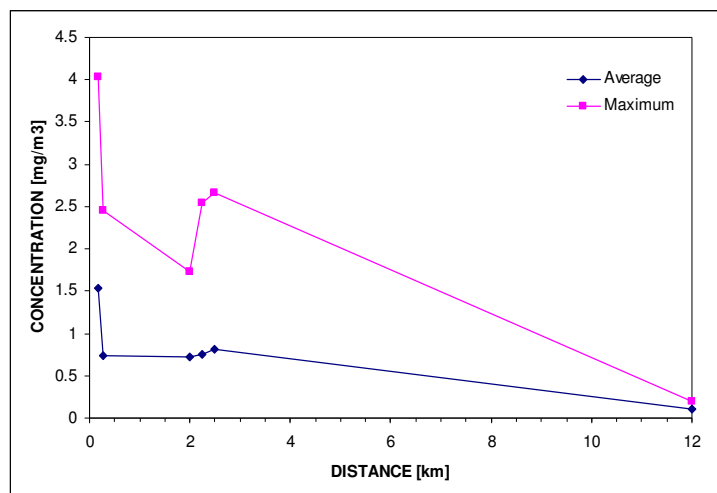
**Table 6.** Individual (at a distance of 1 km) and collective assessments of risk related to annual releases

	ASSESSMENT OF INDIVIDUAL RISK		EFFECT UPON HEALTH OVER SURFACE OF 0.5 TO 100 km	
	CANCER	EXCEEDING MORTALITY	CANCER	
LEAD AND ZINC FACTORY	0.00003	0.01	3	100

In the examples presented below, it can be observed that the effective height of release is 60 metres, which means releases from a not so high chimney. If the releases had been higher, the concentrations around the source would have been decreased.



**Figure 2.** Cadmium producing facility – release height  $h_e = 60$  m. - long term average concentrations



**Figure 3.** Lead producing facility – release height  $h_e = 60$  m. – long term average concentrations

### CONCLUSIONS

The non-ferrous metallurgy is known as the biggest polluter of the eco-system with heavy metals: lead, cadmium, arsenic as well as emission of gases containing oxides of sulphur, nitrogen and carbon.

The classical pyro-metallurgical procedures involving zinc and lead represent technologies that don't provide acceptable protection of the human environment. Such procedures are used in the Zletovo smeltery whose production facilities produce over 20 elements that are harmful for the living beings.

The pollution is mostly due to the character and the performances of the technology and the processing technique as well as the quality of the raw materials and the materials used to achieve certain production goals. From ecological aspect, the lead represents the most problematic metal although it is not the main production metal in the smeltery compound that uses the Imperial Smelting technology. It is toxic in the metal form and in the form of compounds. The lead compounds are the most harmful for the living organisms when they reach the respiratory and the digestive tract. Only organic compounds, among which the most harmful is tetraethyl lead (anti detonating additive in petrol) can pass through the skin.

The investigations have proved that the human organism consumes about 3 mg of lead weekly through food, [8]. The maximum allowed concentration of lead in food is 40 ppm. The lead vapour causes decay of the human organism. Permanent inhaling of lead causes damage to the central nervous system as well as malfunction of the kidneys and strong pain in the stomach. In conditions of intoxication, the metal is deposited in the bones by 10 mg of lead daily.



The intoxication with cadmium causes malfunction of the lungs and kidney insufficiency. The toxicity is manifested by the property of the cadmium to replace the zinc in the proteins which causes damage to the cells, [9]. The adverse effect of cadmium is even bigger in presence of selenium and lead.

Knowing the danger from the presence of lead, cadmium, sulfur dioxide and other particles originating from the Zletovo lead and zinc smeltery in Veles presented through the parameters analyzed in the previous chapters, it can be concluded that Veles and its wider surrounding are facing a big ecological threat. Therefore, based on the emission of certain pollutants from the smeltery, the risk factors pertaining to occurrence of these pollutants on an annual basis as well as the risk pertaining to excessive lethality have been computed.

So, it can be concluded that the pollution from the non-ferrous metallurgy, i.e., the smeltery depends on the character and the performances of the technology and the processing technique as well as the quality of the raw materials and materials used for certain production goals.

The disturbance of the ecological equilibrium has reached such a level that has made impossible the harmonization of the natural systems maintaining the living world with the needs of the considered industrial facility. In this case, the preventive protection has ceased to have technical-technological sense wherefore measures for temporary or permanent stoppage of the production of the existing smeltery have been taken, [5].

## REFERENCES

1. WHO Regional Office for Europe Air Quality Guidelines for Europe, WHO Regional Publications, European Series, Copenhagen, No. 23, 1987.
2. Bayer A., Kaul A., Reiners Chr., Fischer G., The German Risks Study, Accident Consequence Model and Results of the Study, Nuclear Technology, pp.59-78, 1982.
3. Eisenberg, N.A., Lynch C. J., Breeding R., Vulnerability Model, a Simulation System for Assessing Damage Resulting from Marine Spills, Nat. Tech. Inf. Service Rep. AD-A015-245, Springfield. 1975.
4. Emission Controls in Electricity Generation and Industry, Organization for Economic Cooperation and Development (OECD) and International Energy Agency (IEA), Paris, pp.72-81, 1988.
5. Finney D.J. Probit analysis, Cambridge University Press, London, pp.37-43, 1971.
6. Hamilton L.D. Comparative Risks from Different Energy Systems: Evolution of the Methods of Studies, Nuclear Safety 24(2), pp.155-164, 1983.
7. Hosker R.P.Jr. Estimates of Dry Deposition and Plume Depletion over Forests and Grassland, International Atomic Energy Agency and World Meteorological Organization, IAEA-S, pp.181-187, 1973.
8. Human Reliability Associates, Practical Techniques for Assessing and Reducing  
  1. Human Error in Industry, Course notes, Manchester, England, pp. 109-116, 1988
  9. International Nuclear Fuel Cycle Evaluation (INFCE), Report of Working Group 7, Waste Management and Disposal, International Atomic Energy Agency, pp.288-293, 1980.



## METHODOLOGY FOR IMPACT ASSESSMENT OF HEATING PLANT ON THE ENVIRONMENT – EXAMPLE

Saska Sekulic\*, K. Simeonov

University of Nis, Faculty of Occupational Safety, Nis, SERBIA

\**saskapan@gmail.com*

### ABSTRACT

In the law system of the Republic of Serbia, the assessment of project impacts on the environment is performed for projects that are planned and realized in a certain area where a pollution can be caused, or projects which represent a risk to human health. This area is regulated by the Law for the assessment of environmental impacts ("Off. Gazette of RS" no. 135/04 and 36/09) and other regulations.

In this paper the subject project of Environmental Impact Assessment on the environment is the assessment of possible impacts from a heating plant, whose parameters are taken as empirical, since the aim of the paper is to present the methodology of environmental impact assessment of the subject project under the legislation of the Republic of Serbia.

**Key words:** impact assessment, heating plant, environment, pollution, emissions.

### INTRODUCTION

The assessment of environmental impacts is a preventive measure to protect the environment based on the elaboration of assessment documents, and for analyzing the quality and sensitivity of the environmental factors in a certain area and their mutual influences.

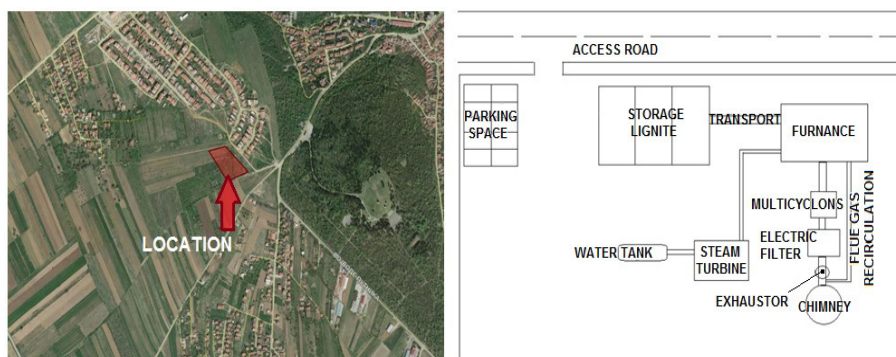
The impact assessment study of the project on the environment aims to review the potential impacts and changes in the environment, which can be caused by the activities of the subject project at a certain location, in order to prevent potentially harmful effects, eliminate and minimize them, and reduce them to the by the Law prescribed boundaries, which are acceptable from the environmental and sustainability aspect.

The study is done in accordance with the order for the contents of the environmental impact assessment (Official Gazette of the Republic of Serbia, No.69 / 2005) and the decision for determining the scope and the content of the assessment of environmental impact. The purpose of the study is to evaluate the quality of the existing state of the environment in the area where the subject plant is, to define and quantify the impacts and potential impacts in the case of using the full capacity, and eventually do a complement of the protection measures and define the environmental monitoring.

The subject project of the environmental impact assessment studies is a heating plant for which assessment empirical data were. The characteristic of this impact assessment is the integrated approach to the environmental protection, which means that instead of a partial analysis of the heating plants operation or activities in one segment of the environment there are considering all aspects of interaction (direct, indirect, short term, long term). The environment impact assessment of the subject project will be made by using the methodology of the Republic of Serbia, where it will be shown the type and amount of emitted gas, water and other liquid and gaseous waste materials, observed by technological units including air emissions, discharges to surface and ground water recipients, disposal to land, noise, vibration, heat, radiation (ionizing and non-ionizing) and others.

### DESCRIPTION AND LOCATION OF THE SUBJECT PROJECT

The subject location is located in Minova settlement which belongs to the city municipality Palilula, located about 3 km of air line from the center of Niš. The heating plant is located in the southwestern part of the settlement; at 43 ° 18'21,01 " north latitude and 21 ° 51'53,79 " east longitude. The total area of the complex is about 9800 m<sup>2</sup>. Figure 1. shows the respective location and the layout of the heating plant.



**Figure 4.** Location and situation plan of Heating plants (autors source)

Palilula Municipality is located in the southern part of the city of Niš and includes a narrow part of the city with includes 15 rural settlements. The Palilula Municipality is a natural and geographical combination of lowland (in the basin of the river Nišava and South Morava) and mountainous terrains. The municipality covers an area of 117.37 km<sup>2</sup>, and has about 72 165 inhabitants.

The nearest residential houses are located about 30 to 50m away from heating plant, in the northeast direction. The river Nišava is located on the north side of heating plant about 1.7 km away; and abot 3km away on the same side is the city airport. On the north side at a distance of 1.1km is the railway. Residential houses can be seen on the northwest side of the complex at a distance of about 300m. On the eastern side is the

Memorial Park Bubanj located at a distance of about 250 m. At about 300km southeast of subject location can be seen residential areas, while on the southwest side agricultural areas are located. At 4.3km southwest of the subject location the South Morava river is located.

At the subject location is provided for the construction of the combustion plant which will use lignite as fuel. The subject project for the environmental impact assessment is the Heating plant (medium combustion plant - from 1 to 50 MWth). For the purposes of implementing the planned project it is necessary to perform previous works and pretreatments on location, which includes construction works like excavations (for foundation), removing excess soil, temporary storage of building materials, installation of electricity and water needed for construction works. All activities during the site preparations for the implementation of the project should be done with the use of environmental protection measures.

The cauldron room is located in the hall, which is made of steel with dimensions of 30 m × 70 m, what is also the position of the main axis of the bearing steel structures. In front of the cauldron room a storage space for lignite and a conveyor belt for insertion of coal into the furnace grate is foreseen, while behind the cauldron room a space is provided to set up multi-cyclones, electrostatic precipitators, chimneys and systems for flue gas recirculation. Across the storage room for lignite a water tank and steam turbines are located.

## THE METHODOLOGY

The methodological approach and content of the impact assessment are defined by the Law for the environmental impact assessment ("Off. Gazette of RS" no. 135/04 and 36/09) and the Ordinance for the content of environment impact assessment studies ("Off. Gazette of RS" no. 69/05).

During the work of the boiler room and the combustion of energy resources, waste products of combustion are generated, which contains carbon dioxide and water vapor, sulfur dioxide, nitrogen dioxide, fly ash and soot, which are ejected into the atmosphere. Also, noise and vibration are generated, as well as waste water and other types of waste. To assess the impact on the environment of heating plant it is necessary to consider all of these mentioned side effects. For the purposes of this study a assessment of the impacts of waste products of combustion will be done considering that empirical data was taken and that the project was not implemented.

### The evaluation of shares of the technological process - waste products of combustion

To evaluate the impact of long-term and short-term shares of technological procedures which cause substance discharges in the air, a simplified calculation method can be used separately for each substance. For the calculation of the share of the technological process ( $PC_{air}$ ) the following formula is applied:

$$PC_{air} = DF_{long-term/short-term} \cdot Rfi \text{ } [\mu\text{g}/\text{m}^3]. \quad (1)$$

where is:

$DF_{long-term/short-term}$  - dispersion factor [ $\mu\text{g}\cdot\text{m}^3/\text{g}\cdot\text{s}$ ],  $RR_i$  - mass flow of the expected compound [ $\text{g}/\text{s}$ ]. Short-term share of the technological procedure is relating to the emissions per hour, and long-term share of the technological procedure relating to the annual emissions. The dispersion factor is shown in Table 1.

**Table 1.** Dispersion factors

Effective height of emission [m]	Dispersion factors [ $\mu\text{g}\cdot\text{m}^3/\text{g}\cdot\text{s}$ ]	
	Long term: Max. annual average	Short term: Max. flow per hour
0	148	3900
10	32	580
20	4.6	161
30	1.7	77
50	0.52	31
70	0.24	16
100	0.11	8.6
150	0.048	4.0
200	0.023	2.3

A linear interpolation is recommended for chimneys whose height is different than shown in the table or in the case when the value of the effective height is between two values given in the table.

Total planned concentration (PEC) are calculated according to the following formula:

$$PEC_{air} = PC_{air, long-term/short-term} + C_{fi} \left[ \frac{\mu\text{g}}{\text{m}^3} \right] \quad (2)$$

where is:

$C_{fi}$  - the concentration of the expected substance from the ambient air (FON concentration) [ $\frac{\mu\text{g}}{\text{m}^3}$ ]

Coefficients of the environment are calculated according to the following formula:

$$EQ_{matter, long-term/short-term} = \frac{PC_{matter, long-term/short-term}}{ELV_{long-term/short-term}} \quad (3)$$

where is:

$EQ_{matter}$  – reference environmental criterion - coefficients. Reference criteria, particularly those  $EQ_{matter}$  who are legally obliged, are often expressed on different time bases. Conversion factors for different averaging periods are shown in Table 2.

**Table 2.** Conversion factors of different averaging periods for air emissions

To assess:	Multiply the value of one hour with:
15 min	1.34
8 hours	0.7
24 hours	0.59

The cumulative total environmental impact is calculated according to the following formula:

$$EQ_{air} = EQ_{matter1} + EQ_{matter2} + \dots + EQ_{matter n} \quad (4)$$

### THE RESULTS OF THE EVALUATION OF THE SHARE OF THE TECHNOLOGICAL PROCESS

For a better insight into the results, it is necessary to describe the characteristics of the emitters and the cauldron shown in Table 3.

**Table 3.** The characteristics of the emitters and the cauldron

Physical chimney height: $h = 50$ [m]	Mass flow:
Chimneys hatch: $d = 2,5$ [m]	Solid particles: $RR_{part} = 7,56$ [g/s]
The temperature of the output gases: $t_g = 155$ [°C,]	Nitrogen oxides: $RR_{NO_2} = 1,12$ [g/s]
The temperature of the ambient air: $t_v = 4$ [°C ]	Carbon monoxide: $RR_{CO} = 0.03$ [g/s]
Expiration speed: $\vartheta_g = 2,2$ [m/s]	Sulfur dioxide: $RR_{SO_2} = 14,63$ [g/s]
Power of the cauldron: $P = 4,5$ [MWth]	Elemental composition energy source - lignite,
Wind speed at the anemometers height: $\vartheta_a = 2$ [m/s]	C - 41 %, H - 6,8 %, O - 15,4 %, N - 0,6 %, S - 1,2 %, A - 11%, W - 24 %.
Satnovs parameter: $m = 0,25$	

Expected pollutants:

1. Powdery substance (Part)
2. Carbon monoxide (CO)
3. Nitrogen oxides (NO<sub>x</sub>)
4. Sulfur dioxide (SO<sub>2</sub>)

Since the value of the effective height is between two values given in the table from which we take the dispersion factor we do a linear interpolation.

Linear interpolation for long-term share:

$$y = y_a + \frac{(x - x_a)(y_b - y_a)}{(x_b - x_a)} = 0.24 + \frac{(95.9 - 70)(0.77 - 0.24)}{(100 - 70)} = 0.127$$

$$\Rightarrow DF_{long-term} = 0.127 \left[ \frac{\mu g / m^3}{g / s} \right]$$

Linear interpolation for short-term share:

$$y - y_a + \frac{(x - x_a)(y_b - y_a)}{(x_b - x_a)} - 16 + \frac{(95.9 - 70)(8.6 - 16)}{(100 - 70)} - 9.61 \rightarrow DF_{short-term}$$

$$= 9.61 \left[ \frac{\mu g / m^3}{g / s} \right]$$

The share of the technological process  $PC_{air}$  is determined according to the formula (1) on which base are obtained the results shown in Table 4.

**Table 4.** The share of the technological process  $PC_{air}$

Substances	Long-term share $\left[\frac{\mu g}{m^3}\right]$	Short-term share $\left[\frac{\mu g}{m^3}\right]$
Powdery substances $Part$	0.96	72.56
Carbon monoxide $CO$	0.0038	0.29
Nitrogen dioxide $NO_2$	0.14	10.76
Sulfur dioxide $SO_2$	1.86	140.59

Total anticipated concentrations (PEC) are calculated according to the formula (2), on which base are obtained the results shown in Table 5.

**Table 5.** Total anticipated concentrations (PEC)

Substances	$C_{fpart} \left[\frac{\mu g}{m^3}\right]$	Long-term share $\left[\frac{\mu g}{m^3}\right]$	Short-term share $\left[\frac{\mu g}{m^3}\right]$
Powdery substances $Part$	35	35.96	107.56
Carbon monoxide $CO$	100	100.0038	100.29
Nitrogen dioxide $NO_2$	40	40.14	50.76
Sulfur dioxide $SO_2$	50	51.86	190.59

According to the Regulation on ELVs of pollutants in the air for Serbia, for medium plants for combustion on solid fuels shown in Table 6. Through the conversion factor for pollutants for 24h each ELV is multiplied by 0.59 (see table 2.), whose results are also shown in Table 6.

**Table 6.** ELVs of pollutants in the air for medium plants for combustion on solid fuels and results for 24h each ELV

substances	$ELV_{hour} \left[\frac{\mu g}{m^3_N}\right]$	$ELV_{daily} \left[\frac{\mu g}{m^3_N}\right]$
Powdery substances	$20 \cdot 10^3$	$11.8 \cdot 10^3$
Carbon monoxide	$150 \cdot 10^3$	$88.5 \cdot 10^3$
Nitrogen dioxide	$150 \cdot 10^3$	$88.5 \cdot 10^3$
Sulfur dioxide	$350 \cdot 10^3$	$206.5 \cdot 10^3$

Coefficients of the environment are calculated according to the formula (3), on which base are obtained the results shown in Table 7.

**Table 7.** Coefficients of the environment

Substances	EQ Long-term share $\left[\frac{m^2}{m^3}\right]$	EQ Short-term share $\left[\frac{m^2}{m^3}\right]$
Powdery substances $P_{art}$	$8.14 \cdot 10^{-5}$	$3.63 \cdot 10^{-3}$
Carbon monoxide $CO$	$4.2 \cdot 10^{-5}$	$1.93 \cdot 10^{-5}$
Nitrogen dioxide $NO_2$	$1.58 \cdot 10^{-5}$	$7.17 \cdot 10^{-5}$
Sulfur dioxide $SO_2$	$9 \cdot 10^{-5}$	$4.02 \cdot 10^{-4}$

By adding long-term and short-term environmental coefficients for each expected substance a long-term ie short-term is obtained for the cumulative total impact on the environment. The cumulative total environmental impact is calculated according to the formula (4) on which base are obtained the shown results.

$$EQ_{air, long-term} = EQ_{long-term}^{Part} + EQ_{long-term}^{CO} + EQ_{long-term}^{NO_2} + EQ_{long-term}^{SO_2}$$

$$= 9.2 \cdot 10^{-5}$$

$$EQ_{air, short-term} = EQ_{short-term}^{Part} + EQ_{short-term}^{CO} + EQ_{short-term}^{NO_2} + EQ_{short-term}^{SO_2}$$

$$= 4.1 \cdot 10^{-3}$$

## DISCUSSION

The subject coal-fired cauldron with nominal capacity of 4.5 MW will have no impact on the quality of surface and groundwater. The work of the heating plant will not significantly affect the air quality, given that the project documentation provides a solution (Installation of multi-cyclones) which provided that emissions into the atmosphere stay below the permitted ELVs, which can be concluded from the results. Considering the the characteristics of the cauldron technological process it can be concluded that sometimes the noise level can be increased. During the cauldron work vibrations may occurred wich are mainly of local character, they can't be transferred to the ground, so it will not have an impact on the environment. During the cauldron work it does not come to the broadcasts of radiations. Solid waste is mainly generated during the previous works for the project construction where occurs rubble, pieces of concrete, metal and the like.

Noise measurements will be carried out in accordance with by law prescribed regulations at the request of the competent authority and citizens complaints. Those waste will be temporarily disposed within the heating plant on a space reserved for it and then to the nearest landfill. During the performance of previous works excess soil may occurs that will be disposed of at a local landfill where it is used as inert cover. During the combustion in the heating plant waste materials can be generated like coal ash and slag. The ash and slag will also be temporarily disposed within the factory and then transported to the landfill. During the cauldron work no industrial waste water is generated, only sanitary waste water from the facility washing. This water is discharged into the drain in the floor which are connected to the sewerage installation under the



floor cauldron room. The existing method of removing waste water does not threat the environment. Given that it only comes to the generation of sanitary waste water a monitoring of the wastewater quality is not necessary.

## CONCLUSION

The aim of this work was to present the methodology for environment impact assessment for a specific project. A special review was to present the calculation of the evaluated shares of the technological process, ie the estimates of combustion waste products, considering that empirical data were used. The shown calculation is used for the environmental impact assessing, more precisely in the preparation of EIA. The calculation methodology itself is easily applicable. Using the presented methods as a result we obtain quantitative data which give access to all the components that are potential polluters.

## REFERENCES

1. Zakon o zaštiti životne sredine („Sl. glasnik RS” br. 135/04, 36/09, 72/09 i 43/11);
2. Zakon o proceni uticaja na životnu sredinu („Sl. glasnik RS” br. 135/04 i 36/09);
3. Zakon o upravljanju otpadom („Sl. glasnik RS” br. 36/09 i 88/10);
4. Zakon o zaštiti vazduha („Sl. glasnik RS” br. 36/09);
5. Zakon o zaštiti od buke u životnoj sredini („Sl. glasnik RS” br. 36/09 i 88/10);
6. Zakon o vodama („Sl. glasnik RS” br. 30/10);
7. Pravilnik o sadržini studije o proceni uticaja na životnu sredinu („Sl. glasnik RS” br. 69/05);
8. Pravilnik o postupku javnog uvida, prezentaciji i javnoj raspravi o Studiji o proceni uticaja na životnu sredinu („Sl. glasnik RS” br. 69/05);
9. Pravilnik o dozvoljenim količinama opasnih i štetnih materija u zemljištu i vodi za navodnjavanje i metodama njihovog ispitivanja („Sl. glasnik RS” br. 23/94);
10. Uredba o graničnim vrednostima emisija zagađujućih materija u vazduh („Sl. glasnik RS” br. 71/10);
11. [http://www.mzoip.hr/doc/stavljanje\\_postrojenja\\_izvan\\_pogona\\_1.pdf](http://www.mzoip.hr/doc/stavljanje_postrojenja_izvan_pogona_1.pdf) (pristup 20.04.2016.)



## ROOF STRATA STRESS AND STRAIN INVESTIGATION WITH A VIEW TO EXPLORE TERRAIN SUBSIDENCE ABOVE THE MINING SITE AT POBRĐE BORATE ORE DEPOSIT

Darko Drmanac

University of Pristina, Faculty of Technical Sciences, Kosovska Mitrovica, SERBIA

*darkodrmanac19@yahoo.com*

### ABSTRACT

This paper presents methods and devices for stress and strain measurement for the purpose of exploration of undermined terrain subsidence, above the excavation site, *in the caving zone*, at the “Pobrđe“ borate ore deposit. Presented herein is a research necessary for the investigation of geomechanical properties and creation of parameter prediction model of undermined terrain subsidence, as well as examination of dependence between the terrain subsidence dynamics and the damage of buildings thereon.

**Key words:** terrain subsidence, stresses, strains, underground excavation.

### INTRODUCTION

The Pillar “V” mining method or “Funnel-shaped excavation” will be applied in the borate ore excavation at the “Pobrđe“ borate ore deposit. The principle of the mining method is excavation of ore body in the dip-slip direction with retreat mining and hanging wall caving. This Pillar-room method “V“ towards the deposit includes exploitation blocks consisting in construction of corridors along the length of the deposit of 40-100m.

Before beginning the excavation, and during the Pillar “V” method, it is necessary to undertake a preparation of the excavation field under mining-geological conditions of the mine's pit “Pobrđe“. The preparation usually consists in construction of basic corridors along the length of the ore body. The distance range between the basic corridors is 25 to 30m, i.e. 25 to 30m away from the working above it. Connecting of corridors is done through rod production.

After the excavation process, there is a void left, which allows for the caving of the rock mass due to establishing of natural balance. The ensuing roof strata caving may lead to terrain subsidence.

During the underground borate ore excavation, certain geomechanical processes start appearing in the roof strata, which is observed through changes, such as: cracking of borate seam immediate to the mining site and weakening of its physico-

mechanical properties, stratification and relatively intensive hanging wall caving, permeability increase of several laying masses, with occurrence of local and general depression funnel, formation of faults and cracks from the excavation area vertically or inclined upwards to the surface, sinking and subsidence on the terrain surface, with vertical and much smaller, horizontal, surface shifts and strains, as well as damages and changes in the basic structure of building construction on the surface of the terrain.

### TERRAIN SURFACE SUBSIDENCE PARAMETERS

The shape, size and progression of terrain surface strain depend on several mining and geological factors, such as: physico-mechanical and structural properties of the hanging wall, the sink depth, poteness and incline of coal layer and accompanying sediments, mining method and shape and dimensions of the excavation site, terrain surface appearance, etc. The coal layer excavation is followed by the caving and full movement of the roof strata downwards, which on the terrain surface is seen through occurrence of subsidence bed. Terrain surface subsidence  $W$ , at an arbitrary distance  $x$  from the centre of the subsidence bed, can be expressed as:

$$W = W_0 \cdot e^{-h^2 \cdot x^2}$$

where:  $W_0$  – the subsidence in the centre of the subsidence bed and  $h$  – parameter dependent on the seam depth and roof strata properties.

The basic subsidence parameters, calculated according to different theories, are: maximum subsidence size, subsidence coefficient, vertical and horizontal movements, curvature radius, specific elongations and shortenings, and the terrain subsidence velocity. However, all those calculations mostly exclude geomechanical properties of the roof strata.

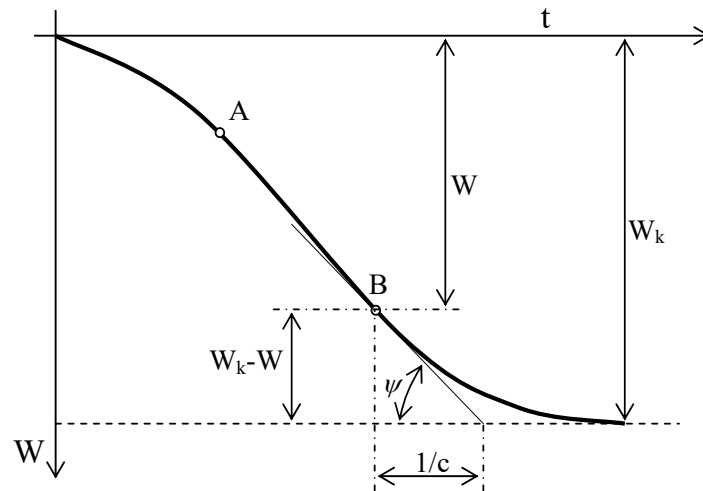
The velocity of strain development on the terrain surface can be expressed by formula:

$$W = W_k \cdot (1 - e^{-c \cdot t})$$

where:  $W$  – momentary subsidence  $t$ ,  $W_k$  – final subsidence and  $c$  – subsidence velocity coefficient, dependent on the hanging wall properties.

With known subsidence velocity of a point in the terrain, the subsidence velocity coefficient can be determined (Figure 1). From tangent line  $tg \psi$  to the subsidence velocity curve, in the point B, a subsidence velocity coefficient is calculated based on the formula:

$$\frac{1}{c} = \frac{W_k - W}{tg \psi}$$



**Figure 1.** Determining subsidence velocity coefficient

After a while, the equilibrium is established in the massif. The surface movements may be slow and long-lasting, with a possibility of sudden sinking of the terrain.

Multilateral investigations, analytical and experimental methods, laboratory and “in situ” observations, conducted during the last decade in the field of rock-mechanics and terrain surface protection, have led to the development of new theories and hypotheses. Their basis is defining the stress state round mining rooms and under very complex lithological conditions.

#### **METHODS AND DEVICES FOR STRESS AND STRAIN MEASUREMENT**

For strain measurement, i.e. a change in distance between two reference points in any direction, on the contours of pit rooms and deep in the rock massif, various extensometer constructions are used. Ribbon extensometers are mostly used for the measurement of rooms profile deformation. It is most commonly used for the subsidence of the ceiling of underground rooms and for pit shoring deformations. Mechanical and magnetic borehole extensometers are used for rapid and precise measurement of the massif strains.

The stress state on the contours of underground rooms and deep in the rock massif can be determined in several ways, by using appropriate equipment and devices.

For the room contour stress measurement, the three sets of methods are mostly used, i.e: complete stress relief methods, partial stress relief methods and the methods for restoring the former stress state.

The complete and partial stress relief methods are based on stress change determination, on the basis of determined strains between bench marks and elasticity

modulus of the rock mass.

In the immediate vicinity of a room's lateral slash, the stress vanishes, and the previous stress state is determined by measuring the slash deformations.

The methods of restoring the former stress state by using hydraulic pillow blocks do not require familiarity with the elasticity modulus of the rock mass, by which the precision of the investigated results is increased.

For stress measurement in the depth of the rock massif, the following methods are used:

- methods based on rock massif strain measurement or pressure by means of devices placed in boreholes (core discharge (Overcoring) method and borehole strain gauge method),
- methods with hydraulic capsules (Hydrofracture), and
- acoustic methods.

In strain gauge-based methods, by means of electro-resistant measurement bands, strains of certain rock mass parts are determined (discharged core on the bottom or on the walls of the borehole).

Overcoring has been undertaken for many decades. It involves creating a hole, placing some device that measures strains or dimensions in the hole, and then drilling over the top of that hole to relieve the stress and thus cause a dimension change. This dimension change is measured and so is the rock modulus and Poisson's Ratio. By the use of mathematical formulae it is possible to calculate the magnitude and directions of the stresses existing in the rock.

For evaluation of stress in particular direction, elasticity parameters, Young's elasticity modulus and Poisson's coefficient should be determined. The sample is obtained through the core's breaking off from the borehole, and then it is subjected to laboratory examination. By means of electro-resistant measurement bands, which in a special operation are glued onto the bottom of the borehole, i.e. onto the polished face of a core, the core discharge-caused strains are measured.

Discharging methods are relevant only for strong and medium-strong rock mass which deforms elastically, whereas these methods are not fitting for ductile and loose rocks.

The method has until recently been restricted to measurements in short boreholes that are preferably dry. The reasons for this are the need to get information out of the borehole and the use of adhesives to glue strain gauges to the borehole wall. Several overcore devices exist that use the gluing technique. The United States Bureau of Mines developed a recoverable overcore cell known as the USBM borehole deformation cell that measured six radial deformations of a borehole which practically converted to three diametral measurements. This cell could only be used to establish the stress field perpendicular to the borehole. All these devices relied upon a cable to measure the change in strain with the overcore process.

Methods of lateral borehole deformation gauge refer to measurement of the borehole diameter reduction by means of special electro-resistant, electro-inductive and electromagnetic devices. Strains are observed through time and the length of the borehole.

The hydrofracture method of stress measurement involves straddling a section of a borehole with packers and pumping a fluid into the borehole with sufficient pressure to fracture the rock. This is intended to occur in the axis of the borehole. Pressure is permitted to drop off and a crack closure pressure detected. The crack opening pressure is also measured by raising the fluid pressure again until the flow increases indicating crack opening. The values of stress may be theoretically derived from these pressures and the direction determined by the measurement of crack orientation. The problem with the technique is that the method relies upon scalar measurements to derive a stress tensor. In practical terms the determination of the actual stress values is significantly less certain than those derived from overcoring.

Acoustic methods for the rock massif stress state determination refer to spreading velocity measurement of elastic waves through the rock massif. Isotropic rock medium has pertinent dependences between the spreading velocity of length- and cross-wise waves and the rock mass elasticity parameters.

### DEVELOPMENT OF TERRAIN SUBSIDENCE AND STRAIN PROCESS

Knowing geomechanical properties of the roof strata and observing stress-strain state in the hanging wall is particularly important for studying massif shifts and terrain surface deformation during an underground coal excavation. The course and size of the massif strain are especially affected by pressure resistance, tightening and bending, as well as by parameters of shear resistance and rheological characteristics of rocks. The most significant geological factors are layer depth, roof strata depth, layer incline and structural-tectonic massif proportions.

If the hanging wall is built of thick and compact rocks, the strain process course is longer, and the subsidence bed is sprawled over larger area. If it is built of weak rocks (marl and clay) the strains set in fast, the subsidence bed has a smaller range with smaller horizontal shifts (Figure 2). The subsidence process also depends on time, which is explained by rheological properties of the rock massif. The shifting process is very slow in the excavation of coal seams, lasting for years.

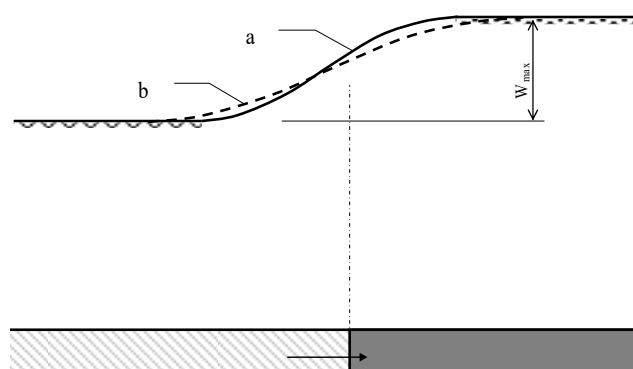


Figure 2. Surface subsidence on: a) compact and potent rocks; b) weak rocks

The terrain subsidence (the most prominent subsidence, vertical and horizontal shifts, range angle excavation impact on terrain surface, bed profile curvature and terrain subsidence velocity) parameters may be predicted with various precision and accuracy degrees, and the methods used are: profile functions, impact functions, numerical methods and physical models. All the mentioned techniques have a common task – to evaluate terrain subsidence parameters, as a result of the underground mining of mineral resources.

The terrain surface subsidence may appear only if the excavation belt width exceeds determined values. The fundamental concept of all terrain subsidence prediction methods includes this minimum width relation to the depth of coal seam, the caving angle (Figure 3).

Analytically, the problems related to terrain surface strains, under the impact of mining of horizontal and gently reclin ed seams in regular excavations, are much easier to solve than those related to steep deposits with non-systematic excavation.

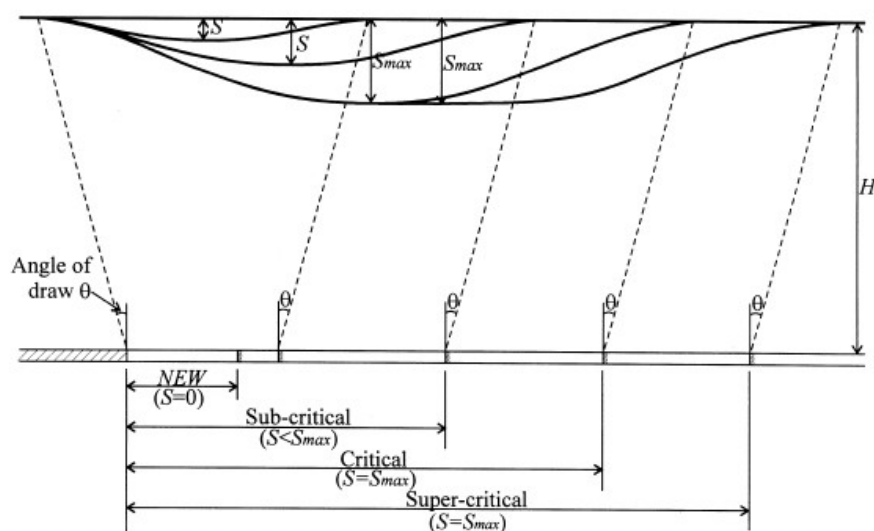


Figure 3. Pattern of subsidence spreading

## CONCLUSION

Studying geomechanical processes in the roof strata and subsidence and deformation of terrain surface due to underground excavation of borate ore at the “Pobrđe” ore deposit, requires field research through which geomechanical properties of coal and hanging wall are determined. It is also necessary to observe, by using appropriate devices, changes of stress-strain state in some parts of the subsiding hanging wall, and in different excavation stages. The investigations concerned represent a basis for designing an evaluation model for terrain subsidence parameters and dynamics and for a risk of damages to surface buildings.

The undermined terrain subsidence above the underground mine brings about damages and changes in the basic structure of construction of residential and industrial buildings, transportation lines or agricultural soil.

#### **REFERENCES**

1. P. Jovanović, Rock-mechanics basics in mining operations, Belgrade, 1969;
2. M. Stević, Rock and soil mechanics, Tuzla, 1991.
3. E. Hoek, Rock Engineering, [www.rockscience.com](http://www.rockscience.com)
4. [www.slopeindicator.com](http://www.slopeindicator.com)





## THE IMPACT OF “POBRĐJE” BORATE ORE MINING ON THE ENVIRONMENT

Darko Drmanac<sup>1\*</sup>, M. Ignjatovic<sup>2</sup>, V. Cvetkovic<sup>3</sup>, M. Dogandzic<sup>4</sup>

<sup>1</sup>Faculty of Technical Sciences, Kosovska Mitrovica, SERBIA

<sup>2</sup>Bor, SERBIA

<sup>3</sup>Coal mine “Ibarski rudnici” Baljevac, SERBIA

<sup>4</sup>The underground mine “Crnac” Leposavic, SERBIA

\*[darkodrmanac19@yahoo.com](mailto:darkodrmanac19@yahoo.com)

### ABSTRACT

In the Jarandol basin the deposit of borates is found in the form of sedimentary products in the Pobrđe and Piskanja. Considering the fact that the borate ore has not been mined on the territory of Serbia, some solutions for environmental protection are presented in this paper.

**Key words:** underground mining, borate ore, degraded soil, environment.

### INTRODUCTION

The Tertiary Jarandol basin is located in the valley of the river Ibar, about 14 km north of the town of Raska. The Jarandol basin is elongated in the W-NW-E-SE direction. The river Ibar divides it into two areas: the eastern Piskanja area with the Piskanja borate ore deposit, and the western, in the strict sense, Jarandol area with the carbonaceous Jarandol horizon, the borate ore deposit Pobrđe, as well as the boron mineralisation in Raspopovići. The Pobrđe borate ore deposit is located at about 1,6 km to the west of Baljevac mining community, and is connected to it by an asphalt road. In terms of geographical location, Pobrđe ore deposit is a part of Raška municipality. The Figure 1 shows the geographical location and traffic connection of Pobrđe ore deposit with regional places. Pobrđe ore deposit has great benefits in terms of traffic connection with regional places. At 4,5 km, in the south-east, a railway station is located in the village Josanicka Banja, and a standard-gauge railway Beograd–Kraljevo–Skoplje.

### POBRĐJE ORE DEPOSIT WITH ITS GEOLOGICAL COMPOSITION, GENESIS AND TECTONICS

According to the research that has been conducted so far, the deposit in Pobrđe covers an area of 40 ha, with a mineral paragenesis comprising two minerals: colemanite

(boro-calcite –  $\text{Ca}_2\text{B}_6\text{O}_{11} \times 5\text{H}_2\text{O}$ ) and haulite (calcium silico-borate –  $\text{Ca}_2\text{B}_5\text{SiO}_9(\text{OH})_5$ ). The borate minerals appear in the clastic-carbonate and volcano-sedimentary sequence, formed of finelaminar and medium-grained tuffaceous sandstone with tuff-alevrolite, marl and shale. The carbonates of the sequence (dolomitic limestone, marl and shale) present alternate bedding. The ore layer comprising colemanite and haulite is syngenetic in its genesis, formed within neogene sediments. With regard to its genesis, it belongs to younger Volcanism, that is volcanic gases (fumarole) and hydrothermal deposits, whose composition had high amounts of boron. The central part of the deposit is, according to the last research, highly disrupted and folded. Besides the assumed faults as vertical layers, smaller anticlines and synclines are present, with their axes descending to the south and south-east.

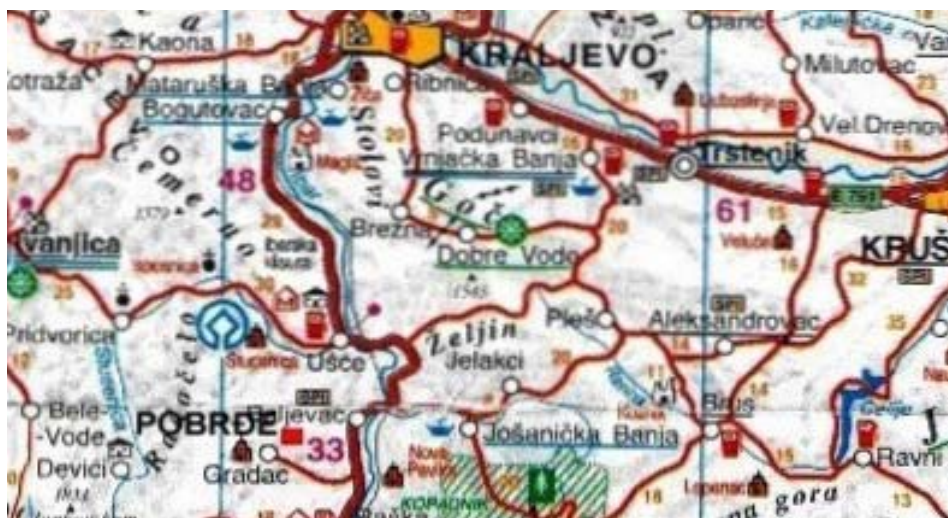


Figure 1. Geographical location and traffic connection

### HYDROGEOLOGY OF THE POBRĐE ORE DEPOSIT

The research conducted by „Geozavod – Beograd“ has established basic hydrogeological characteristics of the ore deposit, and they are represented by the following types of aquifers: compact aquifer, located in the alluvial area of the river Ibar, where the water level is dependent on the level of the river. Karst aquifer, observed in the Tertiary limestone, and present in smaller amount in the deposit itself, but can bear the mine's groundwater and fracture aquifers, which are present within basalt conglomerates, andesite and serpentine.

Waterless terrain represents, conditionally, the largest part of the basin. During the mining operations, a smaller water inflow has been observed, and it appears in the mining operations as dripping water with the amount of 20 m<sup>3</sup>/sec. The Pobrđe stream flows through the northern part of the deposit. The most of the deposit is located to the stream's right, in the south-west.

## **THE ENVIRONMENT IN THE IMMEDIATE AND DISTANT SURROUNDINGS OF THE POBRĐE DEPOSIT**

### ***Pollution sources***

For more than 80 years, the company „Ibarski rudnici kamenog uglja“, Baljevac, has been mining coal in this area. They transport coal from the Jarandol pit by means of an aerial tramway, as well as from the open pit Tadenje. In the process of wet separation, coal washing is conducted in Tadenje, as well as depositing slag waste, obtained by spontaneous combustion of waste, which is then used for production of building materials.

### ***Population density***

In the area of the Pobrđe deposit, the population is mostly comprised of rural households straggling on local hills, and located in the mining community of Baljevac. The company “Ibarski rudnici kamenog uglja (The Ibar hard coal mines)”, including the Pobrđe deposit, is based in that town.

### ***Water management facilities***

There are no water management facilities in the surroundings of the Pobrđe deposit. The dam Gazivode on the river Ibar, 103 km away, is the closest water management facility to the Pobrđe deposit.

### ***Important cultural property***

In the surroundings of the Pobrđe deposit there are not any objects representing cultural property, such as monasteries, churches, historical monuments and so on.

### ***Water supply***

Regarding water supply, the mining community of Baljevac are provided with water partly from the town of Raska Water Works, which has a water intake structure in the drainage gallery Brvenica from the former pit of the magnesite deposit Trnava, and they supply the rest of water from their own Water Works, whose water intake structure is located above Jošanička Banja in Đorov Most. The households far away from the asphalt road take water from their wells and the village's spring tapping. The water drawn from the river Ibar, which is necessary for the separation process at “Ibarski rudnici” has been marked as industrial water.

### ***Climatic conditions***

The data obtained from the meteorological stations “Beoce“, “Studenica“, “Vranovina“ “Ušće“ and “Priboj Selo“ have been used for the analysis of climatic characteristics of the surroundings. The area of the mine Pobrđe is characterized by temperate continental climate. The immediate vicinity of mountain Kopaonik has an obvious influence on the climate. Medium annual quantity of sediment is about 630 mm. Long and cold winters are characteristic for this area, with short and hot summers. May and June are the season with the highest average monthly precipitation, whereas the

minimum precipitation is characteristic for February and March, that is for the end of winter period.

#### ***Flora and Fauna***

Mountainous regions are characteristic for incidence of flora and fauna. Of deciduous species, there are mostly hard deciduous oak and beech, and of fruit crops plums and raspberries. In this area, all sorts of vegetables and cereal do well, and people grow them for their own needs. Regarding the fauna, pheasants and rabbits are found widespread on terrain, and large livestock and sheep are grown as domestic animals. The exuberant vegetation has been climatised to the existing geochemical conditions. No rare plants and animals have been observed in the vicinity or surroundings of the deposit.

#### ***Agricultural soil***

The agricultural soil belongs in the V-VIII rank of less fertile soil, and is of the podzol soil group formed on sandstone.

### **RECOMMENDED MEASURES FOR ENVIRONMENTAL PROTECTION**

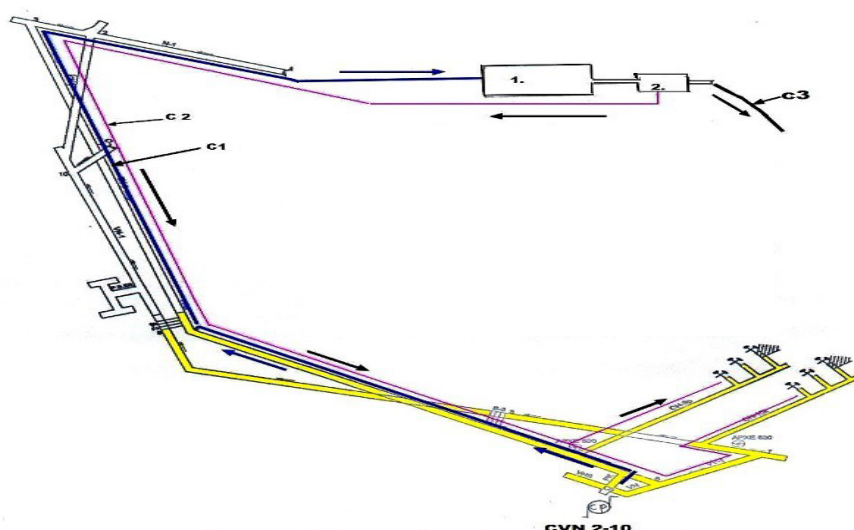
#### ***Protection of water streams***

The explorations conducted on the ore solubility in water have shown that the ore dissolves in water, so the issue of environmental protection would need to be addressed promptly. It is a favourable characteristic that the deposit does not contain heavy metals, such as mercury and arsenic. Boron presents inclination towards the elements H, O, Na, Ca, Mg and Si, whereas it forms soluble compounds with the elements H, O, Na, and non-soluble ones with the elements Ca, Mg and Si. This feature of boron should be used in exploitation and ore processing of mineral borates for solutions for protecting the environment.

According to the main project of opening and mining of the borate ore in the Pobrđe ore deposit, a construction of a Main pump chamber has been envisaged for the lowest point of HS – 1 (haulage slope). Special mining rooms (collection pits) are found in the main pump chamber. Those collection pits take in all the groundwater from mining rooms. According to prospective measuring, collection pits for potential groundwater inflow have been designed, and they are constructed with a dip angle to allow for the sedimentation of solid matters. Pump aggregates CVN 2-10 (centrifugal multistage pump with electric motor) are placed in the pump chamber. Through an intake well, the pump aggregates pump water and take it to the surface, that is to the absorption pool No 1. The absorption pool No 1 is connected with the absorption pool No 2 through bypass.

Protecting the environment from exploitation of borate ore includes: Collection pits in the pool No 1 will be provided with lime for the formation of boron insoluble compounds, which is deposited in the tranquil part of the collection pit, as well as in the other half of the pool No 1. The water cleaned from the calcium-borate sediment flows, by means of the bypass, to the pool No 2, where gravity-influenced water returns to

underground rooms to be used as technical water for mine drilling and sprinkling of the means of transport, while carrying out the ore. That is how the airborne hovering dust is lowered, and the water surplus is let into water streams as refined water. The deposited calcium-borate is washed and placed in special packaging as raw material for production of agricultural fertilizers. Linear diagram of pit water movement is shown in Figure 2. It is necessary to conduct chemical analysis during the process of depositing and prior to water letting from the reservoir to water streams.



**Figure 2.** Linear diagram of underground mine water movement: 1- pool water from the cave, 2- pool for clean water, C1- pipeline for mine drainage, C2- pipeline for water that is returned to the mine, C3- pipeline for clean water

### *Soil protection*

Considering the soil properties and mining-geological conditions, the soil should be protected. Damage of the terrain surface, in the form of settling, is not expected considering the depth of depression during the pit mining, but the settling is expected for the reasons of opening of the mining rooms.

### *Waste disposal*

The waste, carried outside of the pit by using conveyors with rubber strips to waste bunkers, is then transported by lorries to the waste heap in Piskanja, 2 km away from the Pobrđe ore deposit. The waste heap is located between the river Ibar in the north, the building materials factory in the south and the sedimentation chamber for small classes of coal in the south-west.

According to the thorough urban planning of the Raška municipality, this area has been defined as industrial property, for it already includes a tip head for coal separation. The Republic committee for energy, industry and construction made a

decision on 03-09-1987, No 02 310-169 87, which approves the application of conducted operations and constructed facilities, in accordance with "Supplementary mining project of waste disposal from the "Ibarski rudnici" separation". Fertile soil and agricultural crops are not found in the area envisaged for waste disposal from the Pobrđe borate ore deposit.

An embankment of 3 m in height and 11 m in width has been put up towards the river Ibar, with a rim road 4 m wide, as well as another embankment 4,6 m-7,1 m in height, and 11 m in width. The purpose of the canal is to protect the river bank and to allow for the drainage of surface waters. In the direction of the sedimentation chambers for small classes of coal, on the other side of the tip head, it has been protected with an embankment 6 m high and 9 m wide. A 30-cm thick bentonite clay layer will cover the terrain surface for waste disposal, after which the PVC foil is lined. The waste heap shall be contoured with a drainage channel, and its purpose is collection of atmospheric water drawn to free sedimentation chambers, used during the coal separation. Lime is also added to sedimentation chambers in order to obtain insoluble boron carbonates. Considering the atmospheric precipitation and large volume of sedimentation chambers, the water collected in the sedimentation chambers will disappear through natural evaporation. The mass deposited will be collected and packed in bags, and transported for agricultural purposes. A 15-cm thick bentonite clay layer will cover the surface between the waste heap and rim channel, as well as the rim channel itself. The clay is applied to the base in thin layers.

The analyses of the waste conducted by "Poljoprivredni fakultet – Beograd (Faculty of agriculture, Belgrade)", point to a possibility of its use for plants, as well as having an application in agriculture. Contributing to such an occurrence is the fact that waste does not contain heavy metals. According to the above-mentioned, the deposited waste will also be explored and used for the production of boron-containing fertilizers. In mineral fertilizers industry, the boron from the waste would be added to NPK fertilizers, producing a new type of fertilizers (NPK+B).

#### ***Air protection***

During ore mining, the mining fields at the pit, mining equipment and transit roads all become significant sources of dust. Safeguards were set up against the dust's negative impact in the "Dust emission measurements, Subject: Dust emission measurement of contaminating matter during borate ore mining in the air of mining rooms of the Pobrđski potok deposit, in Baljevac". The report was presented in 2000, composed by "Institut za zaštitu na radu, Novi Sad (Institute for occupational safety)". Based on the above-mentioned report, these measures are applied: wet drilling, sprinkling at transfer points, and wearing of gas masks by workers in certain positions. Run-of-mine ore is transported from the railway station in covered containers. These measures provide a complete health safety of workers, as well as protecting the air.

## **CONCLUSION**

The operations in a future borate ore mining at the Pobrđe ore deposit will have a certain impact on the environment. Significant manifestation of harmful influence on water, air, soil and surrounding population is not expected under normal conditions of the technological process of mining execution. Due to a designed low annual capacity, contemporary mining techniques, the application of the latest equipment, and the described safeguards, there are but insignificant associated effects in terms of environmental pollution. Therefore, it can be concluded that the borate ore mining fulfils the required conditions regarding the protection of environment.

## **REFERENCES**

1. D. Đukanović, "GRP of opening and mining of borate ore at the Pobrđe ore deposit - Ibarski rudnici kamenog uglja-Baljevac", Biro za projektovanje i razvoj- Beograd (Planning and Development Office, Belgrade), 2008
2. Stanković, I. Marčetić, M. Jovanović, "A study on Environmental Impact Assessment of borate ore mining at the Pobrđe ore deposit, Baljevac", "dekonta" Belgrade 4/2009
3. Branković, "The impact of borate minerals on the surroundings in the process of exploitation and preparation of borate ore from the mine Pobrđe", Institute for technology of nuclear and other mineral raw materials, Belgrade, 1997
4. V. Ličina, "The application of borate ore waste as slow-working chemical fertilizers", Faculty of agriculture, Belgrade, 2005
5. "A report on dust emission measurement, Subject: Dust emission measurement of contaminating matter during borate ore mining in the air of mining rooms of the Pobrđski potok deposit in Baljevac", Insitute for occupational safety, Novi Sad, 2000
6. D. Zečević, M. Ivković, M. Popović, "Some gained experience in borate ore mining at the Pobrđe ore deposit, Committee of underground exploitation of mineral deposits – Journal Mining Engineering 2/2009



## RECLAMATION OF MINE WASTE DUMP IN ANTHRACITE MINE „VRSKA CUKA“-AVRAMICA

Savo Perendic<sup>1\*</sup>, J. Sokolovic<sup>2</sup>, B. Stakic<sup>1</sup>, D. Ciric<sup>1</sup>

<sup>1</sup>JPPEU, RA „Vrska Cuka“ Avramica, Avramica bb, 19341 Grljan, SERBIA

<sup>2</sup>University of Belgrade, Technical Faculty in Bor, V.J. 12, 19210 Bor, SERBIA

\* [savo.perendic@jppeu.rs](mailto:savo.perendic@jppeu.rs)

### ABSTRACT

Anthracite mine “Vrska Cuka” is producing coal used in wastewater treatment. Disposal of dry mine waste material from underground works degraded an area which needs to be reclaimed to its primary category.

**Key words:** anthracite, mine waste, degraded soil, ecology.

### INTRODUCTION

Anthracite mine “Vrska Cuka” is using modified Room and Pillar as mining method. Mined out areas are backfilled with caved in material above the coal. Byproduct of mine works is barren material deposited outside of the mine. Disposal of mine waste affects geodiversity, biodiversity, and topography on the surface. According to the Law on Environmental Protection remediation and reclamation of degraded land is required.

Mine waste generated from production is disposed in the area above Avramicki potok according to Technical Project for disposal of dry mine waste from Anthracite mine “Vrska Cuka”-Avramica [1]. Mine waste capacity is 785,000 cubic meters [2].

### LOCATION AND SOIL CHARACTERISTICS IN THE STUDY AREA

Soil samples were collected from following locations:

1. Waste dump Avramicki potok,
2. Humus disposing-borrowing area located at Coal processing facility “Grljan”.

Waste Dump area Characteristics:

1. Avramicki potok dump is graded and partially grass overgrown, especially at dump slopes.
2. Land use surrounding dump area is generally rural consisting of meadows and woodland.



### **Soil and land categorisation**

According to results based on field and earlier pedological studies (Pedology map of Timok region) location No.1 is mainly covered in variously eroded vertisol based on marl, while location No.2 is generally alluvium contrasted by Diluvium deposits. Mining as well as waste disposal area is categorized as low fertility class land (V to VIII class) according to country legalization.

Climate in the area indicates moderate humidity with low oxidation process resulting in lighter color of "A" soil horizon.

Soil contain humus ranging between 2% and 3%, Nitrogen (N<sub>2</sub>) up to 0.08%, low content of dissolving phosphorus and moderate Potassium oxide (K<sub>2</sub>O). Portal surrounding area and undistributed areas on the top of mining activities are also low fertile land combining broken sandstone, clay and clayey sandstone.

Degraded land is covered with solid waste landfill contains "Deepsole" material mainly consisted from sandstone, clayey coal, clay, quartz sandstones, as well as various types of clay different by level of decomposition and infill material. New generated waste mixture is crushed native rock mainly represented by clay. That type of soil using melioration techniques easily can be cultivate and seeded.

### **Mechanical characteristic of soil and waste material**

Results from mechanical sampling are presented with clay solids in fraction smaller than 0.002 mm in diameter varying between 31% and 39%. From agronomic perspective, it is ideal content of clay within that fraction. Anyway, nature of those materials (sandstone and clay by genesis) in bigger fraction can produce constrains for wider choice of vegetation which is planned to be researched in Reclamation project.

Texture of samples mainly falls under clayey loams. Virgin soils according to geotechnical classification are different from waste material mostly due to lack of rock solid structure.

### **Chemical characteristic of soil and contents of biogenic macro elements**

All samples were subjected to analyses on alkalinity, carbon, humus, and total nitrogen content and to easily accessible minerals represented in nitrogen, phosphorus, and potassium.

Samples from mine waste landfill are highly carbonated with low alkaline reaction. Humus and total nitrogen values are between modest and medium. Easily accessible elements are medium for phosphorus, high for potassium, and low for nitrogen.

Native surface structure is represented with carbonless soil without acid, medium humus and potassium and low nitrogen and phosphorus.

Samples from disposed waste material are high and very high in carbonates, neutral in alkalinity with high content in humus and total nitrogen. Content for easily accessible components is moderate for nitrogen, medium for phosphorus and very high for potassium.

Native land around landfill Avramicki potok is lime less with low alkalinity, with medium humus and total nitrogen content and with low value of easily accessible nitrogen, phosphorous and potassium.

### Contents of easily available forms of calcium and magnesium in soil

Table 1 shows results for easily accessible contents of calcium and magnesium [3]. Samples from locations No.1 and location No.2, especially for processed waste material are very high in easily accessible calcium compared to native topsoil surrounding coal processing facility. Easily accessible magnesium is high in samples from both disposals, while shows optimal value in native soils. Anyway, relations between Ca and Mg are wider in landfill samples pointing on possible inaccessibility with some crops who requires higher content of magnesium.

**Table 1.** Easily available content of calcium and magnesium in soils

Sample	Ca	Mg	Ca/Mg
	mg/100g		mmoleq/100g
Solid waste landfill Avramicki potok			
1.	2635,0	141,0	11,3:1
2.	2052,8	126,8	9,8:1
3.	1428,1	96,6	9,0:1
4.	950,5	36,5	15,7:1
5.	2320,1	120,6	11,7:1
6.	4542,4	159,8	17,2:1

### Contents of biogenic microelements in soil

Table 2 shows results of easily accessible microelements including iron, manganese, copper, cobalt, zinc, and boron [3].

**Table 2.** Easily accessible microelements in soil

Sample	Fe	Mn	Cu	Co	Zn	B
	%	mg/kg				
Solid waste landfill Avramicki potok						
1.	20,8	7,5	7,0	1,55	2,80	1,58
2.	24,3	6,7	9,7	1,20	2,55	1,68
3.	21,0	6,3	8,1	1,91	2,55	1,60
4.	18,8	69,5	3,4	2,11	0,34	1,08
5.	48,1	10,5	1,4	1,44	2,61	2,06
6.	50,7	9,8	1,2	1,64	2,90	2,32

Sampling results shows values between threshold and remediation limits suitable for grass seeds. Higher value of easily accessible boron can be traced in waste dump compared to samples originated from native ground.

### Contents of heavy metals in soils

Table 3 shows contamination on heavy metals in soils including nickel, chrome, lead, cadmium, fluorine, selenium, arsenic. Samples were taken, to determine amount of neutralization works needed [3].

**Table 3.** Contamination with heavy metals

Sample	Pb	Ni	Cr	Cd	As	F
	mg/kg					
Solid waste landfill Avramicki potok						
1.	16,7	15,1	9,2	0,04	18,1	230
2.	15,9	14,1	8,9	0,05	11,5	255
3.	14,1	11,4	7,4	0,05	16,0	216
4.	22,9	27,2	29,3	0,05	8,0	220
5.	10,0	5,4	6,7	0,00	15,1	240
6.	10,2	5,3	5,6	0,00	21,0	252

Analysis shows low content of heavy metals below threshold level in both type of soil. Only higher content, but still below threshold level indicates contamination with arsenic and fluorine in waste material. Those results encourage relatively cheap reclamation of landfilled waste material.

### SOLUTION FOR MELIORATION OF THE TOPSOIL AND LAND

According to Pedology-agrochemical, study degraded areas by mining activities of Anthracite mine "Vrska Cuka" few facts can be highlighted from technical and biological reclamation perspective:

1. Grading of freshly dumped waste material with or without tiny humus layer cover-recommended thickness ranging between 0.2 and 0.3 meters.
2. Relatively low fertility of waste material, especially low humus, nitrogen and phosphorus at Avramicki potok and partially on humus borrowing location, must be solved with melioration and fertilizing techniques, which are integral part of future biological reclamation project.
3. Considering low level of contamination after reclamation of parcels, there will be no constrains for seeding cultures suitable for livestock feeding even without investment in humus covering the area.
4. Due to nature of the rock in waste dump after grading there will no steep slopes and possibility of erosion will be brought to minimum value.

### RECLAMATION OF MINE WASTE LANDFILL

After technical treatment of waste dump, which include grading rolling, plowing, seeding a grass mixture on slopes and top berms, can decrease humus application of layers above wasteland. These are well known facts gained from previous

experience on the same type of soils, with applicable agricultural techniques is the cheapest and the most successful way for reclamation. Skeletal structure of the waste dump (mostly sandstones) within few year of prescribed treatment will decrease amount of barren rock especially with rock ability to decompose.

The main reason for this type of land reclamation is composition of soil (lower than IV class) and is not the appropriate for growing up other vegetation then suggested.



**Figure 1.** Solid waste landfill Avramicki potok [3]

### **Technical land reclamation**

Grading will be done on active landfill up to projected capacity. Possible locations for new landfill waste dump will be considered if needed.

Heavy civil engineering machinery will be used for grading a solid waste dump. Work will be consisted of leveling horizontal and angling slopes.

Stability of slopes is at 36 degrees according to the nature of waste material, and there is no need additional grading. Bulldozer is used for grading the dumpsite and backhoe will be used for digging dewatering drains. The same machinery will be used for grading humus as a top layer over the waste material.

Land reclamation will be finished with humus located on cadastral parcel No. 2654/1 where solid landfill Grljan is located on. Thickness of humus layer is recommended to be 0.6 meters.

The maintain good quality of cover for mine waste dump, up to one meter of humus is removed as top soil and piled on the same location. Transportation of humus to waste dump is by trucks loaded by pile loader.

### **Biological land reclamation**

The selection of crops and conditions for their formation and selection of basic types within the biological aspects of reclamation was made on the basis of preliminary physico-chemical analysis of tailings and degraded land, manifested and expected microclimate conditions, as well as the final geometry of the tailings.

For successfully realizing of the biologically reclamation, in addition to past experience, were used observations of spontaneously developed form of vegetation on tailings, as well as natural conditions favorable for it. Special requirements in the selection of basic vegetation types, is their flexibility in terms of submission of local conditions, as well as current maintenance.

#### ***Parameters for tree selection and planting technology***

For forming a tree line on the edges of landfill waste dump, Black pine (*Pinus nigra*) is chosen as the most appropriate species. Black Pine does not require Black pine is considered as one of the invasive species due to low requirement on soil and grows on elevation between 150m and 450 m associated with oak tree mostly on southern areas of hills and grows on limestone-sandy ground. Black Pine is resistant to frost as well as to drought, temperature range is between minus 30 and plus 50 degrees centigrade. As autochthonous specie, Black pine can be found on nearby locations with a similar soil characteristic and height (Kraljevica Zajecar).

Slopes will be planted with acacia, mostly due to low planting cost. Acacia doesn't require additional fertilization of parcels and plants are cheaper in comparison to black pine. Acacia is also well spread in the area and one of the invasive species. This factor guarantees success in planting on low cost.

#### ***Parameters for grass selection and sowing technology***

For reclamation purposes following combination of grass seeds are chosen: common sainfoin, orchard grass, red fescue, yellow trefoil, mentha pulegium.

For the successful grass seeding, it is necessary to fill the area with the layer thickness of 0.3 m of humus. Humus will be brought for the surface of actual dumpsite. For the dumpsite Grljan the process of peeling fertile soil is already finished, and peeling from the rest of surfaces is about to commence as required. Peeled layer of fertile ground is piled on nearby location and after a month or so it is transferred to the area planned for reclamation. According to analysis, waste material is low in fertility, it is necessary to apply manure in the amount of 20 tones per hectare. Manuring the area will significantly decrease failure of biological reclamation of degraded surface. Also significant amount of fertilizers need to be lay on the area. Estimated amount is 400 kg per hectare, and recommended mixture is NPK.

Seeding is expected to commence in early spring. A seed needs to be split on equal halves. Primary direction of seeding is longitudinal, and the second is latitudinal with the same amount of seeds. When grass grown up to the height of 5cm it is

necessary to apply fertilizers, UREA is the most applicable mixture, with estimated amount of 150 kg per hectare.

### **CONCLUSION**

Reclaimed areas even if look small are playing crucial role with its location to nearby villages who provides its economic existence by keeping livestock. With procedures as suggested within a short period of time difference between reclaimed parcels and native land will be neutralized. The area is also popular among beekeepers, so seeding mentha pulegium will be benefit to honey production, as this herb is contributing with 220 kg of pollen and nectar by hectar of this culture.

### **REFERENCES**

1. Dizdarević, S. et al. (1998) Technical project solid landfill waste material generated with mine development in coal seam „Mala Čuka,, Anthracite mine „Vrška Čuka,, Avramica, Belgrade, Serbia.
2. Stakić, B. et al. (2006) Mine reserves and resources „Mala Čuka,, Avramica.
3. Đukanović, D. (2015) Project of reclamation for degraded soil in Anthracite mine „Vrška Čuka,, Avramica, Belgrade, Serbia.



## THE PLACE THE MASS MEDIA IN PREVENTION OF OBESITY

Liljana Sokolova<sup>1\*</sup>, K. Berenji<sup>1</sup>, Z. Prijic<sup>2</sup>, N. Djokic<sup>3</sup>

<sup>1</sup>College of Professional Studies in Education of teachers and trainers,  
Subotica, SERBIA

<sup>2</sup>Doctor of biotechnical sciences, Republican inspector, Sombor, SERBIA

<sup>3</sup>Master Graphic Engineering Design, Sombor, SERBIA

\*[liljanasokolova@yahoo.com](mailto:liljanasokolova@yahoo.com)

### ABSTRACT

The assessment of nutritional status, personal attitude towards health and environmental effects, are crucial. *The goal:* to find out who and how the media present in everyday life and can influence the formation of lifestyle. *Methods:* A pool of the adult population of the municipality Sombor; statistics. *Results:* The sample consisted of 648 respondents. The most common medium is TV-73.52%, 32.27% internet, printing 26.94%, 22.07% radio. Over-weight patients was 36.99%, 23.59% obesity. Men and respondents from rural areas, have a higher BMI. Topics on nutrition follows 56.3%. Their behavior for reasons of health, change is 46.12%. *Conclusion:* The media can influence the behavior of individuals and serve ciljanhi in the implementation of preventive actions.

**Key words:** MAS Media, prevention, behavior, health, body mass index (BMI).

### INTRODUCTION

Many people eat in order, to dispel the bad feelings (frustration, boredom, insecurity, anger, sadness); food is often used as a substitute for something that is lost (the love, work), like smoking and drinking. About 30% of people with a BMI above the level of obesity, has a phase of overeating (binge eating disorder). Society demands a beautiful, slender individuals, and obese is therefore discriminated against for various occupations, she feels undesirable, depressed, eat more, but because of their appearance, becomes even more depressed again and comfort found in food (vicious circle).

Long-term or chronic exposure to stress, produces low voltage, as in the case of people who suffer from it, there is a real danger that, by reducing anxiety overeat, become obese. This kind of behavior, that type of reaction, can and learn from someone from the environment. (1)

Recent studies have shown that the perception of the body looks, an important factor in weight control and may be influenced by culture and ethnicity. Gualdi-Russo in 2012 in his study of cross-section presented the results of the assessment of the relationship between Italian immigrants - maternal and child perception of body image.

(2) This theme have studied and confirmed the influence of the environment, and El-Sayed, 2011, Padgett 2003 Classen 2010 timesha 2012 and many others. (3,4,5,6) Definitely, a positive perception of the environment is associated with higher levels of physical activity and reduced obesity. (7)

In different environments, cultures and time there are different ideals of good looks. Fuller people have long been regarded as a symbol of health and wealth. Testifying to various sculptures of ancient civilizations, the Greek Caryatid, Egyptian sphinx and many paintings. Ritual food intake is related to the joyous moments (ceremony, celebration, expression of hospitality), as well as the sad moments Wilsgaard T 2005 (8)

Knowing the relationship of environmental factors and obesity, is important information for interventions related panepidemije obesity. (1)

### **TARGET**

Get to knowledge if the mass media and which, are represented in the daily life of the population and can they affect the formation of a lifestyle.

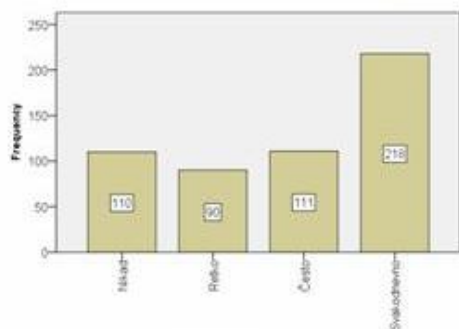
### **METHOD**

During 2012 in Sombor and surrounding villages surveyed concerning the use of Mas media or TV, radio, press and the Internet with a focus on the themes of health. We have used the questionnaire from the context of research "Factors that determine body mass index in adult population of Serbia," or bar The National Project "Development of Health in Serbia" and the study "The state of health of population in Serbia in 2006 and 2013. From the statistical analysis was performed using descriptive statistics, Hi-square test and ANOVA.

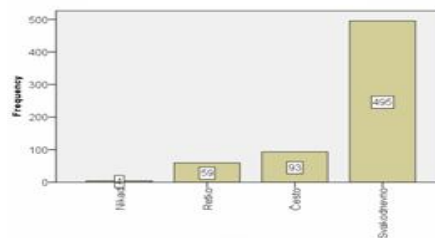
### **RESULTS**

Of the total surveyed 688 respondents, 38.9% are women and 69.1% men. Most, 43.6% from 20 to 39 years, followed by 34.8% between the ages of 40 to 59 years, 13.7% from 19 to 29 years and 20.6% of 60 to 79 years. Of these, 27.3% live in rural areas, and 72.7% in the city. Every day watching TV 76.0% of respondents, radio 30.2%, 33.9% and 41.2% Press internet. Topics on health monitors 47.4% of respondents regularly, 46.0% sometimes. 85.0% of respondents thought that food is responsible for obesity, 76.9% to the great influence of physical activity, smoking 36.4%, 41.5% alcohol, 68.6% thinks a great impact on obesity has stress. At 33.1% of media influence to change habits and behavior. 13.2% of them think that the lack of medical enlightenment most important reason of illness Serbian population. Among the topics that they would like to listen to the media the most common are: proper nutrition, obesity, diet food, nutrition of young children, diabetes, prevention of obesity, way of preparing dishes. One of them is interested in all topics related to nutrition. 81.6% think it is not necessary education on obesity through the media. The largest number among those surveyed, over 50% have secondary education, about 20% high.

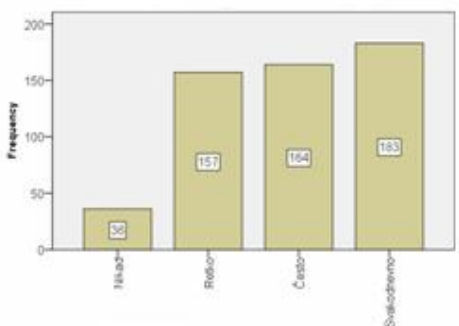




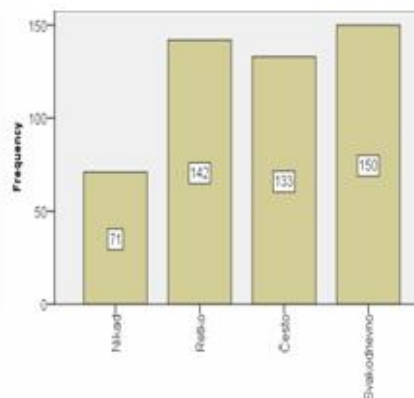
**Figure 1.** Through which the public media to inform - internet



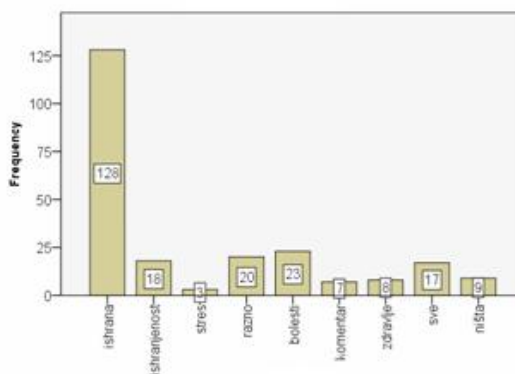
**Figure 2.** Through which the media to inform - TV



**Figure 3.** Through which the public media to inform- press



**Figure 4.** Through which the public media to inform - radio



**Figure 5.** Topics of health

**Table 1.** Frequency of topics on health which are monitored through the media  
**Descriptives**

	N	Mean	Std. Deviation	Std. Error	95% Confidence Interval for Mean		Minimum	Maximum
					ITM Indeks Telesne Mase - TM [kg]/TV [m]2	Upper Bound		
1 diet	126	26,3618	4,18837	,37313	25,6233	27,1003	18,22	38,06
2 nutritional	17	28,7456	4,03043	,97752	26,6733	30,8178	22,86	37,18
3 stress	3	24,7935	,80316	,46370	22,7983	26,7886	24,22	25,71
4 various	20	25,5882	4,71887	1,05517	23,3797	27,7967	18,59	36,57
5 diseases	23	26,7110	5,91715	1,23381	24,1522	29,2697	18,87	44,81
6 comment	7	26,2881	3,41801	1,29189	23,1269	29,4492	22,49	31,28
7 health	7	25,0742	4,89600	1,85051	20,5462	29,6023	20,31	31,86
8 all	17	24,2831	3,28964	1,79786	22,5918	25,9745	19,10	31,83
9 nothing	4	28,8539	3,70472	1,85236	22,9589	34,7489	24,66	32,65
Total	224	26,3327	4,39329	,29354	25,7542	26,9112	18,22	44,81

Test of Homogeneity of Variances

BMI Body mass index – TM [kg]/TV [m]2

Levene Statistic	df1	df2	Sig.
1,430	8	215	,185

ANOVA test

BMI Body mass index - TM [kg]/TV [m]2

	Sum of Squares	df	Mean Square	F	Sig.
Between Groups	228,502	8	28,563	1,507	,156
Within Groups	4075,619	215	18,956		
Total	4304,121	223			

**DISCUSSION**

Recent studies have shown that the perception of the body looks, an important factor in weight control and may be influenced by culture and ethnicity. (3,4,5,6) The role of the media in creating a model of beauty and health is undeniable. It is therefore of utmost importance timely and accessible education on health, prevention of disease and the disease itself through the media, but it is also of great importance through which media and which age group will offer this training.

According to our research, the most common media television and internet. Hereby the following topics mostly about beauty and health, mostly by young people. Persons with Low Self-Esteem, often feel unhappy, but obesity is a factor that is usually located at the root of many cases of Low Self-Esteem. (9) Obesity affects the self-perception of children entering adolescence, especially girls. (10) Whether overweight or have a distorted perception of the law itself, have significantly changed the media. Kruger also believes that obesity is a social stigma that can be managed and rehabilitated through the media. (11)

The most frequent topics of health, which are monitored media related to nutrition. Respondents who monitored about health topics via the Internet have a lower BMI than those who do not use the Internet for information on health, this difference was highly statistically are significant. ( $P < 0.001$ ) (Sokolova)  
The highest average BMI have interviewed who would not like anything to monitored about health topics through the media (12,13), followed by those who would like to follow the theme of nourishment (12,14) and illness (15,16). No statistically significant differences in the BMI index value in each category on the topic of health that respondents would like to accompany ( $p > 0.05$ ).

### **CONCLUSION**

Respondents who prate about health topics through the media, have a lower BMI. They are educated and want to know more on how to preserve health, their behavior will be governed by whose advice provided to the media. The media are an effective method to implement targeted preventive actions and the promotion of healthy lifestyles.

### **REFERENCES**

1. Sokolova L. Factors that determine body mass index among the adult population in Serbia, Doctoral Dissertation
2. Robinett-Weiss N, Hixson ML, Keir B, Sieberg J. The Metropolitan Height-Weight Tables: perspectives for use. *J Am Diet Assoc.* 1984;84(12):1480-1.
3. El-Sayed AM, Galea S. Maternal immigrant status and high birth weight: implications for childhood obesity. *Ethn Dis.* 2011;21:47–50.
4. Padgett J, Biro FM. Different shapes in different cultures: body dissatisfaction, overweight, and obesity in African-American and Caucasian females. *J Pediatr Adolesc Gynecol.* 2003;16:349–354.
5. Classen TJ. Measures of the intergenerational transmission of body mass index between mothers and their children in the United States, 1981–2004. *Econ Hum Biol.* 2010;8:30–43
6. Timesh D, Francisco DC, Robert HG, Liam S, Jaime JM. Body Mass Index and Self-Perception of Overweight and Obesity in Rural, Urban and Rural-to-Urban Migrants: PERU MIGRANT Study. *PLoS ONE* 2012;7(11): e50252
7. Poortinga W., Perceptions of the environment, physical activity, and obesity; *Soc Sci Med.* 2006;63(11):2835-46.

8. Wilsgaard T, Jacobsen BK, Arnesen E. Determining lifestyle correlates of body mass index using multilevel analyses. 1979-2001. *American journal of epidemiology* 2005; 162(12):1179-88.
9. Andrea E. Bombak. The Contribution of Applied Social Sciences to Obesity Stigma-Related Public Health Approaches. *J Obes.* 2014;2014:267286
10. Franklin J, Denyer G, Steinbeck KS, Caterson ID, Hill AJ. Obesity and risk of low self-esteem: a statewide survey of Australian children. *Pediatrics.* 2006 Dec;118(6):2481-7.
11. Kruger HS, Steyn NP, Swart EC, Maunder EM, Nel JH, Moeng L, Labadarios D. Overweight among children decreased, but obesity prevalence remained high among women in South Africa, 1999-2005. *Public Health Nutr.* 2012;15(4):594-9
12. Lee SA. Prevalence of obesity and correlations with lifestyle and dietary factors in Chinese men. *Obesity* 2008; 16 (6):1440-7.
13. Bowman SA. Television-viewing characteristics of adults: correlations to eating practices and overweight and health status. *Preventing Chronic Disease* 2006; 3(2):38.
14. Scali J, Siari S, Grosclaude P, Gerber M. Dietary and socio-economic factors associated with overweight and obesity in a southern French population. *Public Health Nutrition* 2004; 7(4):513-22.
15. Hanson KL, Sobal J, Frongillo EA. Gender and marital status clarify associations between food insecurity and body weight. *The journal of nutrition* 2007; 137(6):1460-5.
16. Jørgensen ME, Borch-Johnsen K, Bjerregaard P. Lifestyle modifies obesity-associated risk of cardiovascular disease in a genetically homogeneous population. *Am J Clin Nutr* July 2006;84(1):29-36



## ASSESSMENT OF ECOLOGICAL RISK INDEX AND NON-CANCEROUS HAZARD INDEX IN PLAYGROUNDS AND PARKS IN NORTHERN AREA OF MONTENEGRO

Boban Mugosa<sup>1\*</sup>, D. Djurovic<sup>1</sup>, M. M. Vrvic<sup>2</sup>

<sup>1</sup>Institute of Public Health of Montenegro Dzona Dzeksona bb,  
20000 Podgorica, MONTENEGRO

<sup>2</sup>University of Belgrade, Faculty of Chemistry, Studentski trg 12-16,  
11000 Belgrade, SERBIA

\**boban.mugosa@ijzcg.me*

### ABSTRACT

The main objectives of this study were: (1) to investigate heavy metals content (Pb, Cd, Cu and Zn) in the soil samples of parks and kindergarten playgrounds in northern area of Montenegro, and (2) to calculate environmental risk index (RI) and non-cancerous Hazard index (HI). The obtained data showed that 50% of investigated locations were Pb contaminated, while only two locations had Cd and Zn higher than maximum allowed concentrations. There was no Cu pollution. Locations in Nikšić and Pljevlja showed considerable ecological risk. Non-cancerous HI values at all locations for all metals were below 1.

**Key words:** heavy metals, ecological risk index, Hazard index.

### INTRODUCTION

Soil pollution by toxic heavy metals poses significant environmental problem worldwide [1]. In many developing countries intense industrialization and urbanization contribute to heavy metal pollution of surface soils [2-4]. Heavy metals are naturally present in soil, but they can be found also as a result of pollution from different sources such as: industry (power plants and iron, non-ferrous industries, electronic, steel and chemical industries), agriculture (sewage sludge, fertilizer such as phosphates, irrigation with polluted waters, usage of pesticide containing heavy metals), fossil fuels combustion, waste incineration, smelters and road traffic. Also in the natural environment long-range transport of atmospheric pollutants can contribute to increase metal content, degrade soil quality, reduce crop yield and the quality of agricultural products, negatively impact to human and animals health, and the total ecosystem [5,6]. The heavy metals Cd, Zn, Pb, Cu and Hg are assumed to have anthropogenic origin while chromium, nickel and arsenic are usually from natural sources [7]. Urban soils in parks and playgrounds polluted with heavy metals can increase human health risk due to oral soil ingestion, inhalation of fugitive particulates and volatiles, and

dermal contact, especially for children and senior citizens who are most susceptible [8-11]. The most vulnerable population to metal poisoning are young children because this is the period of maximal brain development and growth, and differentiation [12]. The central nervous system can be damaged by heavy metals and they may act as cofactors in other diseases [12]. Due to children's hand-to-mouth habit, oral ingestion is a critical pathway of exposure for children and it is important to determine and evaluate heavy metals content in parks and playgrounds soils to quantify the various exposure risk levels [13,14]. Soil pollution has been considered as a very good diagnostic tool of environmental contamination that impact human health [15,16]. Many studies have been reported on metals contamination in urban soils around the world focused on metals contamination in playground soil that can pose human health risk [17-19]. The main objectives of this study were: (1) to investigate heavy metals content (Pb, Cd, Cu and Zn) in soil samples of parks and kindergarten playgrounds in northern area of Montenegro, and (2) to calculate environmental risk index (RI) and non-cancerous Hazard index.

## MATERIALS AND METHOD

Pseudo total content of four heavy metals, Pb, Cd, Cu and Zn in soil samples from public parks, playgrounds and kindergartens from northern area of Montenegro has been showed in this paper. Sampling was conducted during period September-November 2015. Twenty five soil samples were taken from eight municipalities in northern part of Montenegro. This samples included all public parks and kindergarten playgrounds in investigated area. Surface soil samples (0-20cm) were taken with stainless trowel after removing stones and foreign objects and transferred to the laboratory in plastic bags. Samples, approximately 500g-1000g consisting of three sub samples, were taken and mixed to obtain bulk composite sample for each playground. There was no specific sampling design. Sampling was performed at exposed soil near by playgrounds equipment, swings, slides, etc. Soil samples were prepared by microwave acid digestion (ETHOS 1) in *agua regia* according to the manufacture instructions. Before digestion samples were dried, gently crushed and sieved to 2mm and 1g was weighted for analysis. Content of heavy metals was determined by ICP-OES (Spectro Arcos) (inductively coupled plasma-optical emission spectroscopy) technique. Analytical grade chemicals were used through the study without any further purification. For calibration standard preparation MilliQ - Ultra Pure deionized water was used. Mix of Pb, Cd, Cu and Zn working analytical solutions were prepared after serial dilution of stock reference solution containing 1000 mg L<sup>-1</sup> of each element (LGC-ICP-OES stock solution) in a gradient as needed. For determination of accuracy and precision certified reference material ERM-CC141 (loam soil) was used for checking the obtained data. The recovery for all heavy metals Pb, Cd, Cu and Zn 85-110 %. Precision as a relative standard deviation of triplicate measurement was less than 5 % for all investigated elements. Calculation of ecological risk index (RI) was used for evaluation of soil quality. The potential ecological risk index (RI) is defined as a sum of the risk factors (Eq. 1). Hakanson and Yang suggested RI represents heavy metals toxicity and

environment response to all four risk factors (Pb, Cd, Cu and Zn) in playgrounds soil [20,22].

$$RI = \sum E_r \quad \text{where } E_r \text{ is ecological risk factor (Eq.2)} \quad (1)$$

$$E_r = T_i \cdot C_f \quad (2)$$

$$C_f = C_i / B_i \quad (3)$$

$T_i$  is the toxic-response factor for a given substance, and  $C_f$  is the contamination factor. The  $T_i$  values of heavy metals are defined by Håkanson  $C_i$  is metal concentration in analysed soil sample, and  $B_i$  is reference value such as the background level, average crust level, national criteria, baseline level, etc [22]. Non-carcinogenic hazard index (HI) was calculated to evaluate potential children health risk from contaminated location (Eq.4). All inputs for calculation of non-carcinogenic HI are defined by US EPA [23,24].

$$HI_{exP} = \sum HQ_{exP} \quad (4)$$

## RESULTS AND DISCUSSION

Descriptive statistics of element contents in soil samples (minimum and maximum, as well as the means, median and standard deviations) of all contents for four measured heavy metals in the investigated urban parks and playgrounds soil samples is shown in Table 1. The content of Cu did not exceed maximum allowed concentration (MAC) values prescribed by National Regulations, Pb content was higher at 50% of all investigated locations, Zn and Cd were higher at one location in Nikšić and Pljevlja, respectively [25].

**Table 1.** Total contents and descriptive statistics of elements in urban parks soil samples, this study ( $\text{mg kg}^{-1}$ )

Element	Pb	Cd	Cu	Zn
MAC	50	2	100	300
Min	2.94	0.19	6.85	15.17
Max	134.74	2.18	77.84	301.38
Mean	50.67	0.63	35.55	126.70
Median	50.39	0.89	33.63	119.55
SD*	31.92	0.60	17.20	71.09

\*SD-standard deviation

Results for RI are presented in Figure 1. To describe the RI the following terminology was used:  $RI < 150$ , low risk;  $150 \leq RI < 300$ , moderate;  $300 \leq RI < 600$ , considerable;  $RI \geq 600$ , very high. Based on RI value the examined locations were low to moderate risk, except to locations in Nikšić and Pljevlja, near by industrial facilities,





## CONCLUSION

The content of Cu did not exceed MAC values prescribed by National Regulations. Pb content was higher at 50% of all investigated locations as results of industry and traffic vicinity. Zn and Cd were higher at one location in Nikšić and Pljevlja, respectively, as a result of industry impact. Based on the result for RI it can be concluded that almost all investigated soil samples showed low to moderate pollution, except two locations where RI was considerable. The main contributor to RI is from the most toxic elements, Cd and Pb. Pollution from Cd has a long accumulation history and can expose very strong ecological risk to ecosystem and human health. This data provide enough evidence about soil pollution at some locations in northern area of Montenegro and it is very good documented that the presence of heavy metals in environment can cause various types of health problems. Non-cancerous HI values for all four investigated metals at all locations were  $< 1$ , that means there is no risk for children health at this moment. It is necessary to perform some kind of remediation from Pb at the contaminated sites because further pollution can caused human health problems. Monitoring of Pb content in soil is of great importance because of its negative effects on children central nervous system and developmental disorders, especially during long period of exposure.

### *Acknowledgement*

*The authors wish to thank the Ministry of Science and Ministry of Health of Montenegro for financial support through Project No. 03-401*

## REFERENCES

1. Alloway BJ, Heavy metals in soils, 2nd ed. Blackie Academic and Professional, London, (1995).
2. Mireles F., Davila J.I., Pinedo J.L., Reyes E., Speakman R.J., Glascock M.D., Assessing urban soil pollution in the cities of Zacatecas and Guadalupe, Mexico by instrumental neutron activation analysis. *Microchem J.* 103,158–164 (2012).
3. Wei B, Yang L A review of heavy metal contaminations in urban soils, urban road dusts and agricultural soils from China. *Microchem J.* 94, 99–107 (2010).
4. Yaylalı-Abanuz G., Heavy metal contamination of surface soil around Gebze industrial area, Turkey. *Microchem J.* 99,82–92 (2011).
5. European Environmental Agency, Soil pollution by heavy metals. Europe's environment the Dobris assessment. Luxembourg: Office des Publications; 676 (1995).
6. Nagajyoti P.C., Lee K.D., Sreekanth T.V.M., Heavy metals, occurrence and toxicity for plants: a review. *Environ Chem Lett*, 8,199–216 (2010).
7. Ljung K., Selinus O., Otabong E., Metals in soils of children's urban environments in the small northern European city of Uppsala, *Science of the Total Environment* 366, 749-759 (2006).

8. Okorie A., Entwistle J., Dean J.R., The application of in vitro gastrointestinal extraction to assess oral bioaccessibility of potentially toxic elements from an urban recreational site. *Appl Geochem.* 26,789–96 (2011).
9. Schmidt CW. Lead in air adjusting to a new standard. *Environ Health Perspect* 118:A76–9, (2010).
10. Siciliano S.D., James K., Zhang G.Y., Schafer A.N., Peak J.D., Adhesion and enrichment of metals on human hands from contaminated soil at an Arctic urban brown field. *Environ.Sci.Technol.* 43,6385–90 (2009)
11. Li H.B., Yu S., Li G.L., Deng H., Luo X.S., Contamination and source differentiation of Pb in park soils along an urban–rural gradient in Shanghai. *Environ. Pollut.* 159,536–44 (2011).
12. Faiz, Y., Tufail, M., Tayyeb Javed, M., Chaudhry, M.M., Siddique, N., Road dust pollution of Cd, Cu, Ni, Pb and Zn along Islamabad Expressway, Pakistan. *Microchemistry Journal* 92, 186-192,(2009).
13. Guney M., Zagury G.J., Dogan N., Onay T.T., Exposure assessment and risk characterization from trace elements following soil ingestion by children exposed to playgrounds, parks and picnic areas. *J. Hazard. Mater.* 182,656–64 (2010).
14. Ljung K., Oomen A., Duits M., Selinus O., Berglund M. Bioaccessibility of metals in urban playground soils. *J Environ Sci Health A Tox Hazard Subst Environ Eng.* 42,1241–50 (2007).
15. Abrahams, P.W., Soils: their implications to human health. *Sci. Tot. Environ* 29, 1–32 (2002).
16. Yay, O.D., Alagha, O., Tuncel, G., Multivariate statistics to investigate metal contamination in surface soil. *J. Environ. Manage* 86, 581–594 (2008).
17. Yay, O.D., Alagha, O., Tuncel, G., Multivariate statistics to investigate metal contamination in surface soil. *J. Environ. Manage* 86, 581–594, (2008).
18. Rawat M., Ramanathan A.L., Subramanian V., Quantification and distribution of heavy metals from small-scale industrial areas of Kanpur city, India. *J. Hazard. Mater.* 172, 1145–1149 (2009).
19. De Miguel, E., Iribarren, I., Chacón, E., Ordoñez, A., Charlesworth, S., Risk based evaluation of the exposure of children to trace elements in playgrounds in Madrid (Spain). *Chemosphere* 66, 505-513 (2007).
20. Yang, Z., Wang, Y., Shen, Z., Niu, J., Tang, Z., Distribution and speciation of heavy metals in sediments from the mainstream, tributaries, and lakes of the Yangtze River catchment of Wuhan, China. *J. Hazard. Mater.* 166, 1186–1194 (2009).
21. Yang, Z., Wang, Y., Shen, Z., Niu, J., Tang, Z., Distribution and speciation of heavy metals in sediments from the mainstream, tributaries, and lakes of the Yangtze River catchment of Wuhan, China. *J. Hazard. Mater.* 166, 1186–1194 (2009).
22. Martin, J. M., Meybeck, M., Elemental mass-balance of material carried by major world rivers. *Mar. Chem.* 7, 173–206 (1979).
23. US EPA (United States Environmental Protection Agency). Risk Assessment Guidance for Superfund. Human Health Evaluation Manual. EPA/540/1-89/002,

- vol. I. Office of Solid Waste and Emergency Response. 1989. Available from: <http://www.epa.gov/superfund/programs/risk/ragsa/index.htm>.
24. US EPA (United States Environmental Protection Agency). Exposure Factors Handbook. EPA/600/P-95/002F. Washington, DC: Environmental Protection Agency, Office of Research and Development; 1997.
  25. Official Gazette of Republic of Montenegro Rulebook of allowed concentrations of hazardous and dangerous substances in soil and methods for determination, No. 18/97, (1997).



## TOXICOVIGILANCE – WHAT DOES IT TELL US?

Danijela Lukic<sup>1\*</sup>, Lj. Torovic<sup>1,2</sup>, S. Bijelovic<sup>1,2</sup>

<sup>1</sup>Institute of Public Health of Vojvodina, Novi Sad, SERBIA

<sup>2</sup>University of Novi Sad, Faculty of Medicine, SERBIA

\**danijela.lukic@gmail.com*

### ABSTRACT

The toxicovigilance approach is used for the detection, identification and validation of clinical adverse events occurring in more susceptible population sub-groups exposed to chemicals. The objective of this paper is to give a brief overview of acute poisonings in Serbia and to identify the main causes and affected population over 2010-2014 period, based on the data published by the Serbian National Poison Control Center. There were 25791 cases of acute poisoning. A total of 20772 patients were examined and 3815 of them were hospitalized. The most common causes for observation and treatment were: ethyl alcohol, drugs, substances of abuse, gases, corrosives, pesticides and mushrooms.

**Key words:** Toxicovigilance, Poisoning, Chemicals, Environment.

### INTRODUCTION

The massive expansion in the availability and use of chemicals, including pharmaceuticals, during the past few decades has led to increasing awareness of the risks to human health posed by exposure to those chemicals.(1)

Tens of thousands of man-made chemicals are currently in common use throughout the world, and between one and two thousand new chemicals appear on the market each year. In industrialized countries, there may be at least one million commercial products that are mixtures of chemicals, and the formulation of up to one-third of these may change every year. A similar situation exists in the rapidly industrializing developing countries. Even in the least developed regions, there is growing use of agrochemicals such as pesticides and fertilizers, of basic industrial chemicals, particularly in small-scale rural cottage industries, and of household and other commercial products, as well as pharmaceuticals. Moreover, each country has a variety of natural toxins to which its population may be exposed.(1)

Every individual is exposed to toxic chemicals, through environmental and food contamination. In some instances, people may be subjected to massive, or even fatal, exposure through a chemical disaster or in a single accidental or intentional poisoning. Between these two extremes exists a wide range of intensity of exposure, which may result in various acute and chronic toxic effects. Such effects clearly lie in the public

health domain, particularly in cases of chemical contamination of the environment that may result in exposure of an unsuspecting public.(1)

The global incidence of poisoning is not known. It may be speculated that up to half a million people die each year as a result of various kinds of poisoning, including poisoning by natural toxins.

Because of that, the International Programme on Chemical Safety (IPCS) was established in 1980 as a collaborative programme of the International Labour Organisation (ILO), the United Nations Environment Programme (UNEP), and the World Health Organization (WHO) in order to provide assessments of the risks to human health and the environment posed by chemicals, so that all countries throughout the world might develop their own chemical safety measures. The IPCS provides guidance on the use of such assessments and seeks to strengthen the capacity of each country to prevent and treat the harmful effects of chemicals and to manage emergencies involving chemicals. IPCS works on prevention and treatment of poisoning is undertaken in collaboration with the World Federation of Associations of Clinical Toxicology Centers and Poison Control Centres and its member associations.

The aims of the European Commission (EC) in the field of poison control are similar to those of the IPCS and many activities are undertaken jointly by the two bodies. The principal toxic risks that exist in any country may be readily identified by surveys of hospital accident and emergency wards, forensic departments, and rural hospitals in agricultural areas. The growing incidence of poisoning from accidental exposures to chemicals, and recent examples of acute poisoning in local populations as a result of industrial and transport accidents involving chemicals have highlighted the importance of countries having special programmes for poison control and, in particular, the facilities for diagnosis, treatment, and prevention of poisoning.(1)

So, countries have to set structured toxicovigilance systems and it is anticipated that in the future, national and international initiatives will help bridging this gap in our knowledge of the toxicity of many chemicals and commercial products to human beings. Toxicovigilance is the active process of identifying and evaluating the toxic risks existing in a community and evaluating the measures taken to reduce or eliminate them.(2)

The general approach of toxicovigilance comprehends the effective exposure, authentication, and follow-up of clinical adverse events associated with poison exposure in human beings by means of house-hold, intentional or unintentional, occupational or environmental chemicals, and products.(2)

#### **Scope of toxicovigilance**

Toxicovigilance is considered likely to examine series of standardized clinical case reports for the determination of hazard recognition and risk assessment. It allows particular follow-up of sub-groups (e.g., children, cultural, life-style factors) of the general population. The toxicovigilance approach is used for the detection, identification, and validation of clinical adverse events occurring in more susceptible sub-groups.(3)

It consists of providing the emergency services with the means of prevention and management of poisoning. It is used for the detection of unknown safety poison information. It helps in the identification of risk factors and quantifying the risks. (4)

Toxicovigilance plays a main role in order to decrease both mortality and morbidity from poisoning. It improves in the diagnosis, prevention, and management of poisoning. Poisoning is one of the most common causes of nonfatal accidents that occurs at home. Prescriptions, non- prescriptions and illegal use of drugs are one of the most common sources of serious poisonings and poison related deaths. Other common sources of poisons include gases, household products, agricultural products, plants, industrial chemicals and foods (particularly certain species of mushrooms). Toxicovigilance promotes understanding, education, and training in toxicovigilance and its effective communication to the public.

#### **Role of poison information centers in toxicovigilance**

Poison information centres have a fundamental role in partnership with others, in toxicovigilance and prevention. Toxicovigilance consists of the active observation and evaluation of toxic risks and phenomena in the community - an activity that should result in measures aimed to reduce or remove risks. Thus, its main goal is prevention.(1)

The role of poison information centres in toxicovigilance includes:

- identifying serious poisoning risks in the local community, and the substances, circumstances, and population groups involved;
- identifying changes in the incidence of poisoning, (e.g. different substances of abuse, application of new pesticides, and seasonal variations in the incidence of poisoning, such as carbon monoxide poisoning from heating appliances);
- monitoring the toxicity of commercial products, such as household, industrial, and agricultural chemicals, as well as pharmaceuticals (by any route of administration), for acute, medium-term, and chronic effects, with particular regard to new products and formulations;
- monitoring the toxic effects of drug overdosage;
- identifying substances that cause significant morbidity and mortality, and specific effects on target organs (e.g. high incidence of renal insufficiency, fetal malformations);
- reporting to health authorities and other relevant bodies situations that demand preventive or corrective action, and, where appropriate, calling an alert;
- monitoring the effectiveness of preventive measures.(1)

Preventive measures for both individual and multiple cases of poisoning should be established on the basis of the available data on high-risk factors, particularly the circumstances, the substances involved, and the potential victims.(1)

A centre could initiate its preventive activities by reporting information on toxic hazards, identified by toxicovigilance, to those with the authority to take appropriate action, and by giving information and advice to those involved in health

education. Further preventive activities could include educational campaigns, producing educational material, and planning, in partnership with others, the implementation and evaluation of preventive measures.(1)

#### **Serbian National Poison Control Centre**

In Former Federal Republic of Yugoslavia, in 1997, National Poison Control Centre (NPCC) was established as a state institution with the task “to organize and provide preventive care measures for poisoning, provide information on the effects of poisons, medical help measures in case of poisoning and eliminate the effects of poisoning”. Now, NPCC is referent institution which medical services for acute poisonings, prevention and treatment, detection of chemical substances in biological materials, water, soil and air, education in the fields of clinical toxicology and toxicological chemistry, as well as scientific research in the fields of toxicology and pharmacology.(5)

In addition to the treatment of acute poisoning and providing information related to the toxicity of chemical substances, both for the medical staff and for general public, permanent task of the NPCC is in the field of toxicovigilance – identification of changes in the incidence of poisoning, seasonal variations in the incidence of poisoning, evaluation of efficacy and safety of antidotes, storage and supply of antidotes, and report health and other relevant factors on the necessary measures.(5)

NPCC now has Clinic for Emergency and Clinical Toxicology and Institute for Toxicology and Pharmacology and it also has Mobile toxicological-chemical team, which is activated in the case of larger chemical accidents. Clinic for Emergency and Clinical Toxicology, the only specialized institution for acute poisoning treatment in the country consists of: Department for reanimation and triage, Department for intensive care and Toxicology Information Department. Institute for Toxicology and Pharmacology consists of two organizational units: department for toxicological chemistry and Department for experimental toxicology and pharmacology. (5)

Department for Toxicology Information is equipped with a self-made “on-line” computer data base which contain data on: toxic substances and preparations on the market, manufacturers and distributors of chemical substances including places of manufacture and storage in the Republic of Serbia and cases of acute self-poisoning, occupational and accidental poisoning which are registered in the Republic of Serbia. Working time is 24 hours, 7 days a week. (5)

The objective of this paper was to give a brief overview of acute poisonings in Serbia and to identify the main causes and affected population over 2010-2014 period, based on the annual reports published by the Serbian National Poison Control Center (5-9).

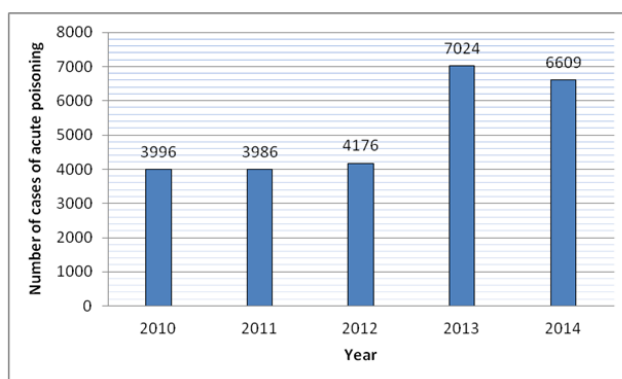
#### **MATERIAL AND METHOD**

Data of number of registered cases of acute poisoning, calls in the Toxicology Information Department, examined and hospitalized patients, causes of poisoning,

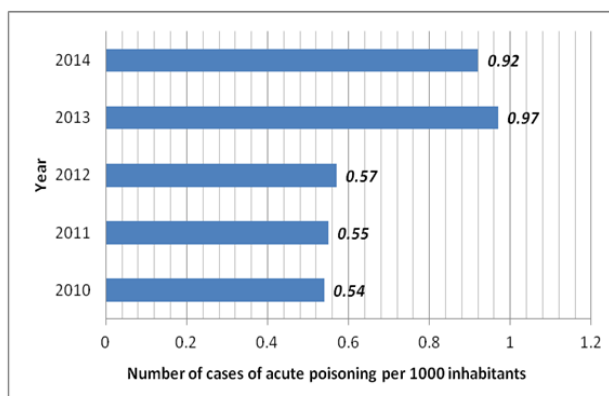
patients age and gender are taken from five Annual Reports of NPCC (2010, 2011, 2012, 2013 and 2014 Annual Reports) (5-9). Data are summarized and shown on tables and graphs.

## RESULTS AND DISCUSSION

Number of registered cases of acute poisoning over five year period and their frequency in relation to the total number of inhabitants of Republic of Serbia are shown on the Graph 1 and Graph 2.



**Graph 1.** The number of registered cases of acute poisoning and frequency over the period 2010-2014



**Graph 2.** The number of cases of acute poisoning per 1000 inhabitants over the period 2010-2014



Number of inhabitants in Republic of Serbia (available data from web site of the Republic Institute for Statistics) ranged from 7320807 in 2010 to 7186862 in 2014. From presented data it could be observed that number of cases of acute poisoning is 1.7-fold higher in the last two years compared to 2010-2012 period. The numerous calls from medical workers and citizens were registered in the Toxicology Information Department. The structure and total numbers of calls are presented in Table 1 (5-9).

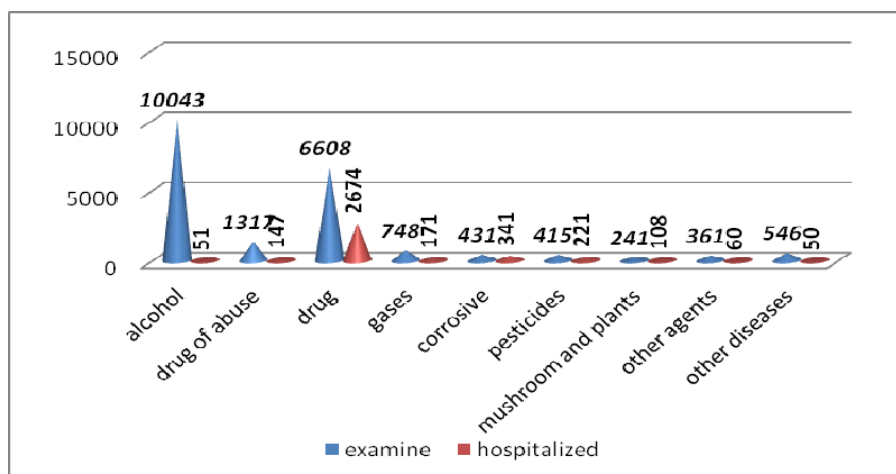
**Table 1.** The structure and total number of calls over 2011-2014 period

		2011	2012	2013	2014	Total
Adults	Calls from the doctors	247	230	302	292	1071
	Calls from the citizens	37	42	130	98	307
Children	Calls from the pediatrician	212	160	287	262	921
	Calls from the citizens	27	14	53	43	137
<b>TOTAL</b>		<b>523</b>	<b>446</b>	<b>772</b>	<b>694</b>	<b>2435</b>

Over the reviewed period, a total of 2435 calls were received. Calls related to presumed poisoning in adults had a share of 57% (in total 1378 calls; 1071 calls from doctors and 307 calls from citizens). Slightly lower number of calls, 1058, were related to suspected intoxication in children. Calls from citizens were relatively less represented (total for both population categories: 444, 18.2%) in relation to total number of received calls.

During the five-year period, 20772 patients were examined by the physician in Department for reanimation and triage (DRT) of NPCC and 3815 (18.5%) of them were admitted for hospital treatment in the Clinic for Emergency and Clinical Toxicology. The most common reasons for arriving to DRT were the suspicion on the abuse of psychoactive substances: alcohol and drugs of abuse and self-poisoning by drugs, corrosive agents and pesticides. Less common reason for arriving was the accidental exposure.

The most common reason for observation and treatment was ethyl alcohol with 10043 examinations, in total. Agents that followed were drugs (6608 examinations), substances of abuse (1317 examinations), gases (748 patients), corrosives (431 patients), pesticides (415 patients) and mushrooms and plants (241 patient). The number of hospitalized patient was much smaller than the number of examined patients. Numbers of examined and hospitalized patients were displayed on the Graph 3 (5-9).



**Graph 3.** The total number of examined and hospitalized patients

The highest percentage of patient examined and hospitalized were poisoned with corrosive agents (341 of 431, 79.1%) and pesticides (221 of 415, 53.2%). The lowest percentage of hospitalized patients was for patients poisoned with alcohol, only 0.5% of total number of examined patients. Percentage of hospitalization by other causes of poisoning was mushroom and plants, drugs, gases and drugs of abuse followed by 44.8%, 40.5%, 22.9% and 11.2%, respectively. These figures show that these groups of toxic agents led to serious poisoning which required hospitalization of patients.

The most common reason for hospitalization was self-poisoning by psychoactive drugs, corrosive substance (hydrochloric acid, acetic acid, sodium hydroxide, bleaching agents), and pesticides (organophosphorus insecticides and herbicides), accidental poisoning (fire gases, chlorine fumes from household products and carbon monoxide) and, much rarer, psychoactive substances abuse (heroin).

According to gender and age structure, of the total number of examined patients (20772 patients), there were 8167 females (39.3%) and 12605 males (60.7%). The majority examined patient (17040) were in group of 19 – 65 years of age, 2019 (10.6%) were younger than 18 years and only 330 (1.7%) were older than 65 years. In the group of hospitalized patients, 2336 females (61.1%) and 1487 (38.9%) males were admitted on hospital treatment. According to the age structure of hospitalized patients, there were 189 (6.5%) persons younger than 18 years, 2243 from 19-65 years (76.7%), while 491 (16.85) were older than 65 years. This means that the majority of examined and hospitalized persons belong to working population.

Over period 2010-2014, there were 150 cases of patients with lethal outcome, whose death was to some extent connected with causative agents. The most prominent causative death agents were corrosive agents and drugs.

## **CONCLUSION**

National Poison Control Centre represents a national resource to collate and monitor poisoning exposure cases and it has a fundamental role, in partnership with others, in toxicovigilance and prevention. Because the poisoning is significant cause of morbidity and mortality in the Republic of Serbia, the centre initiates preventive activities by reporting information on toxic hazards, identified by toxicovigilance, to those with the authority to take appropriate actions, and by giving information and advice to those involved in health education. Preventive activities should include carefully planned educational campaigns, supported by appropriate educational material, in partnership with other stakeholders, and implementation and evaluation of preventive measures.

## **REFERENCES**

1. World Health Organization Geneva, Guidelines for poison control, WHO Library Cataloguing in Publication Data Guidelines for poison control, 1. Poisoning - prevention & control 2. Poison control centers 3. Guidelines, ISBN 92 4 1544872 (NLM Classification: QV 600) 1997.
2. World Health Organization.int. Geneva: International programme on chemical safety.[Updated2010March23].Availablefrom:[http://www.who.int/ipcs/publications/training\\_poisons/guidelines\\_poison\\_control/en/index1.html](http://www.who.int/ipcs/publications/training_poisons/guidelines_poison_control/en/index1.html) [Last accessed on 2016 May 15]
3. Haines JA, Berlin A, Govaerts M, Van der Venne MT, Roche L. Report of the survey of poison control centres and related toxicological services 1984- 1986. *J ToxicolClinExp* 1988; 8: 305-81.
4. Ravali A., Sahithi A., Naveena B., Prunvitha N., Mounika K., Raju A., Chandra S., A review on toxicovigilance, *European Journal of Pharmaceutical and Medical Research*, *ejpmr*, 2016,3(3): 142-145.
5. Annual report of the National Poison Control Centre, Military Medical Academy, Belgrade, 2014. Issued: July, 2015. Available from: <http://www.vma.mod.gov.rs/godisnjak-ckt2014.pdf> [Last accessed on 2016 May 15]
6. Annual report of the National Poison Control Centre, Military Medical Academy, Belgrade, 2010. Issued: July, 2011. Available from: <http://www.vma.mod.gov.rs/godisnjak-ckt2014.pdf> [Last accessed on 2016 May 15]
7. Annual report of the National Poison Control Centre, Military Medical Academy, Belgrade, 2011. Issued: October, 2012. Available from: <http://www.vma.mod.gov.rs/godisnjak-ckt2014.pdf> [Last accessed on 2016 May 15]
8. Annual report of the National Poison Control Centre, Military Medical Academy, Belgrade, 2012. Issued: May, 2013. Available from: <http://www.vma.mod.gov.rs/godisnjak-ckt2014.pdf> [Last accessed on 2016 May 15]
9. Annual report of the National Poison Control Centre, Military Medical Academy, Belgrade, 2013. Issued: March, 2014. Available from: <http://www.vma.mod.gov.rs/godisnjak-ckt2014.pdf> [Last accessed on 2016 May 15]



## INFLUENCE OF TEMPERATURE ON OBTAINING BIOLOGICALLY ACTIVE CELLULOSIC FIBERS WITH BOUND CEPHALEXIN

Pero Sailovic\*, B. Rodic Grabovac, R. Djudjic

University of Banja Luka, Faculty of Technology, Vojvode Stepe Stepanović 73,  
Banja Luka, Republic of Srpska, BOSNIA AND HERZEGOVINA

\**pero.sailovic@unibl.rs*

### ABSTRACT

The influence of temperature on the cephalixin binding on oxidized cellulose (OC) was investigated in this paper, with the aim of obtaining the biologically active cellulose fiber. The drug binding was performed on the OC samples with different content of carboxyl groups, in the cephalixin water solution concentration of  $c=3,4 \cdot 10^{-3}$  mol/L at temperatures  $T=22 \pm 1^\circ\text{C}$ ,  $T= 32^\circ\text{C}$  and  $T= 40^\circ\text{C}$ , while the desorption was performed in physiological solution at the same temperatures. The amounts of bound and released antibiotic were determined spectrophotometrically in UV range. It was established that the amount of bound drug depends significantly on the sorption temperature, with the optimal binding of the antibiotic at  $T = 32^\circ\text{C}$ .

**Key words:** cephalixin, oxidized cellulose, biologically active fiber, the influence of temperature on the drug binding.

### INTRODUCTION

The use of biomedical materials with controlled drug delivery in the last few decades was significantly increased. The biologically active materials represent different types of materials which are compatible with human tissue and /or biological phenomena. The biologically active fibers for topical application [1-3], which are widely used in medicine, are obtained by drug binding on the polymer matrix with different structures.

The drug binding on the polymer carrier with different chemical bonds provides continuous, targeted drug delivery in the optimal concentration and at controlled rate during a longer period, which increases the effectiveness of a treatment [4-7].

Cellulose is one of the most commonly used natural polymers for obtaining biologically active fibers [8,9] due to anionic nature, nontoxicity, biocompatibility and biodegradability.

In this paper oxidized cellulose (OC) was used as polymer carrier for the obtaining biologically active material. OC was obtained by selective oxidation of primary hydroxyl groups with the aim of introduction carboxyl groups suitable for the physical and chemical drug binding[10].

On oxidized cellulose was bound cephalixin (Figure 1), which belongs to the first-generation of cephalosporins and acts as bactericide against grampositive and gramnegative bacteria[11]. In water solution, cephalixin exists in the form of zwitterion, which is in equilibrium with neutral form, and depending on pH, it can be in the form of cation or anion.

The aim of this paper was obtaining biologically active cellulosic material by bonding cephalixin on oxidized cellulosic bandage and investigation of the influence of temperature sorption on the amount of bonded and released antibiotic. In the paper is investigated the influence of antibiotic structure and functional groups of oxidized cellulose on the amount of bound antibiotic.

## MATERIALS AND METHODS

Calico bandage with woven edges (Saniteks Velika Kladusa, 100% cotton, 20 threads / cm<sup>2</sup> ) was used for obtaining oxidized cellulose. The oxidation process was performed with the mixture of HNO<sub>3</sub>/H<sub>3</sub>PO<sub>4</sub> 2:1 (by volume) and 1,43 % NaNO<sub>2</sub> (by weight) at room temperature (25 ±1 °C) during 14, 18 and 36 hours with constant stirring [12]. The content of carboxyl groups of the oxidized cellulose bandage was determined by using the modified calcium acetate method [13]. The carboxyl groups content was calculated as follows:

$$\% \text{COOH} = \frac{N \cdot V \cdot 45}{\text{mass weight (mg)}}$$

where N is solution concentration (0,1 mol/L); V is the volume (ml) NaOH used in titration of the sample and corrected for the consumption of blanks

Desorption of the bound cephalixin from the oxidized cellulose was performed in the physiological solution (0,95% NaCl) under static conditions. Samples with the bound antibiotic were immersed in physiological solution (bath module 1:100 ) at room temperature (20±1°C), T= 32°C and T= 40°C. Desorption process lasted 24 hours with occasional stirring. The samples were taken after 1, 2, 3, 4 and 24 hours.

Amounts of bound and desorbed antibiotic from the oxidized cellulose fiber were determined by using UV-VIS spectrophotometer Perkin Elmer model Lambda 25, at the wavelength of  $\lambda_{\text{max}}$  262 nm characteristic for cephalixin.

## RESULTS AND DISCUSSIONS

Modified cellulose fiber was obtained by selective oxidation of cellulose bandage with the mixture of HNO<sub>3</sub>/H<sub>3</sub>PO<sub>4</sub> 2:1 and 1,43 % NaNO<sub>2</sub> during 12, 24 and 48 hours. The effects of the oxidation process on the content of carboxyl groups were given in Table 1.

**Table 1.** The effects of oxidation duration on the content of carboxyl groups of the oxidized cellulose fiber

The reaction system HNO <sub>3</sub> /H <sub>3</sub> PO <sub>4</sub> /NaNO <sub>2</sub> (2:1:1.4, v/v/%w)	
Temperature: 22 ± 1 °C	
Oxidation duration (h)	The content of COOH %
14	6,19
18	6,96
36	9,52

Carboxyl groups formed by selective oxidation of cellulose bandage in combination with cellulose hydroxyl groups represent good bases for the binding of antibiotic cephalixin.

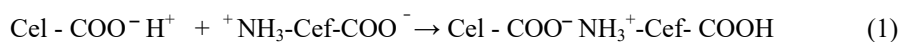
### Cephalixin sorption

The sorption results presented in Table 2. show that the initial amount of bonded cephalixin, recorded after 2 minutes, increases until fifth minute, and then decreases to the lowest value 15 minutes after the beginning of the sorption process. During immersion of OC in antibiotic solution in the first 5 minutes, as a result of fiber wetting and absorbing of liquid, it was recorded initial decline of drug concentration in solution. Initially loosely bound cephalixin molecules on OC are released and after 15 minutes it was recorded reduction of bound antibiotic. After this time, ionic and hydrogen bonds are gradually formed between drug molecules and OC, and the amount of bound antibiotic increases during 24 hours.

**Table 2.** The amount of cephalixin bonded to OC (mg/g), at temperatures T=22±1°C, T= 32°C i T= 40°C, bath module 1:200,

Cephalixin sorption duration (min)	Temperature, T=22 ± 1°C			Temperature, T=32°C			Temperature, T=40°C		
	6,19 % COOH	6,96 % COOH	9,52 % COOH	6,19 % COOH	6,96 % COOH	9,52 % COOH	6,19 % COOH	6,96 % COOH	9,52 % COOH
2	1,73	4,13	13,87	2,93	4,28	16,33	3,74	4,74	5,14
5	4,94	6,80	15,57	7,25	8,63	27,50	5,17	6,29	6,49
15	4,10	5,06	12,28	6,84	4,03	27,17	5,01	3,44	4,29
30	5,48	11,35	16,38	8,52	17,85	28,34	6,61	5,25	6,80
24h	5,86	12,82	16,94	9,96	38,73	31,80	20,95	4,84	8,09

In its structure cephalixin has primary amino group and carboxyl group, and it exists in water solutions in the form of zwitterion, which is in equilibrium with neutral molecule. During sorption process pH value decreases below pH 4 [14], which effects the lowering of OC carboxyl group dissociation (pK<sub>a</sub>≈4) [15]. From the other side, it allows cephalixin transition from zwitterion (pI=4,71) to cation form, whose sorption is energetically more favorable [16] and which can form ionic bond with polycarboxylate ion of OC, as it is shown with reaction (1).



Also, carboxyl group of antibiotic is capable for interaction with OC carboxyl groups via hydrogen bonds, whereby form dimers[8]. Maximum amount of bonded cephalixin (38,73 mg/g) after 24 hours was achieved on OC with 6,96% COOH groups at T=32°C. At the same temperature there was increase in the amount of bonded drug on all other OC samples, in comparison to the sorption results at T=22±1°C. With a further raising of temperature to T= 40°C, there was increase in the amount of bonded drug only for OC sample with the lowest content of COOH groups, while the amount of bonded drug on OC samples with 6,96% and 9,52 % COOH groups were drastically reduced. This temperature influence on drug bonding is explained by action of various factors, such as drug structure, pH value in solution during sorption[14] and increase in the temperature degradation of oxidized cellulosic fiber with the higher COOH content[17]. During sorption at the highest temperature OC samples with higher COOH content do not bind significant amount of drug, because elevated temperature shift chemical equilibrium in the direction of drug release.

### Cephalexin desorption

From the cephalexin desorption data shown in table 3 it can be seen that after 24 hours in physiological solution OC released relatively small amount of bound antibiotic. The release rate is highest in the first 4 hours, after which is significantly slowed.

In all desorption temperature regimes, the highest percentage of bound drug (26,3%, 38,03% and 41,28 %, respectively) is released from sample with the lowest COOH group content. In absolute values, the largest amount of drug is released from sample which has bound the highest amount of drug (OC with 6,96% COOH groups) during 24h hours at T= 32°C.

**Table 3.** The amount of released cephalexin from OC (mg/g), in 0,95% NaCl, at T=22±1°C, T= 32°C and T= 40°C, bath module 1:100

Cephalexin sorption duration (h)	Temperature, T=22 ± 1°C			Temperature, T=32°C			Temperature, T=40°C		
	6,19 % COOH	6,96 % COOH	9,52 % COOH	6,19 % COOH	6,96 % COOH	9,52 % COOH	6,19 % COOH	6,96 % COOH	9,52 % COOH
1	1,24	1,43	1,53	2,81	7,10	5,14	6,94	0,78	1,14
2	1,34	1,54	1,84	2,85	7,75	5,62	7,16	0,81	1,18
3	1,38	1,59	1,88	2,97	8,88	5,77	7,33	0,83	1,23
4	1,45	1,65	1,98	3,51	8,98	6,20	7,47	0,85	1,25
24	1,54	1,78	2,11	3,79	9,59	6,98	8,65	0,89	1,31

### CONCLUSION

Based on the obtained results for all three investigated temperatures and all carboxyl contents of OC bandages, optimal temperature for cephalexin sorption is T= 32°C. The highest level of drug exhaustion during sorption at this temperature showed OC sample with 6,96 % carboxyl group that has bound 38,73 mg/g. Raising the

temperature up to  $T=40^{\circ}\text{C}$  does not lead to increase of bound antibiotic, except for OC sample with lowest carboxyl group content.

Since the binding was performed in water solution at pH values that do not provide optimal dissociation of OC carboxyl group and amino group conversion in cation form suitable for ionic bonding, sufficient amounts of bound drugs were obtained.

Antibiotic desorption from OC is the fastest in the first 4 hours, after which drug release significantly slows. On this way, sustained release of small amounts of antibiotic from oxidized cellulosic bandage during 24 hours may provide prolonged antimicrobial activity.

## REFERENCES

1. Rodić Grabovac B., Đudić R., Topalić-Trivunović LJ., Balaban M., Antimikrobno djelovanje modifikovanog celuloznog vlakna sa vezanim cefaleksin monohidratom, *Glasnik hem. teh. i ek. RS* 6, 1-9, 2012
2. Rodić Grabovac B., Đudić R., Ilišković N., Vezivanje anestetika i antibiotika na karboksimetilcelulozu, *Hem. Ind.* 61, 203-207, 2007
3. Rodić Grabovac B., Đudić R., Sailović P., The obtaining of materials with antibacterial activity by bonding of cefazoline on modified cellulosic bandage, *Contemp. Mater. V-2*, 222-227, 2014
4. Buchenska J., S., Tazbir J., Sobolewska E., Antibacterial Poly (ethileneteraphthalate) Yarn Containing Cephalosporin Type Antibiotic, *FIBERS & TEXTILES in Eastern Europe*, 11, 41-47, 2003
5. Škundrić P., Medović A., Kostić M., Jovanović R., Popović B., Biološki-aktivna vlakna, dobijanje i primjena, *Hemijska vlakna* 4, 37-47, 1996
6. Vuorio M., Manzanares J. A., Murtomaki L., Hirvonen J., Kankkunen T., Kontturi K., Ion-exchange fibers and drugs: a transient study, *Journal of Controlled release* 91, 439-448, 2003
7. Medović A., Škundrić P., Kostić M., Pajkić-Lijaković I., The mathematical model of insulin desorption from the bioactive, fibrous artificial store, *J. Biomed. Mater. Res.* 79, 635-642, 2006
8. Sailović P., Uticaj strukture antibiotika iz reda cefalosporina na proces adsorpcije i desorpcije na oksidovanom celuloznom vlaknu u formi zavoja. Magistarski rad, Tehnološki fakultet, Univerzitet u Banjaluci, 2013.
9. Škundrić P., Kostić M., Medović A., Praskalo J., Biološki aktivna vlakna na bazi modifikovanih polisaharida, *Glasnik hem. teh. i ek. RS* 48, 93-103, 2008
10. Đudić R., Sailović P., Rodić Grabovac B., Rudić B., Uticaj koncentracije rastvora cefaleksina na sorpciju na modifikovano celulozno vlakno, *Glasnik hem. teh. i ek. RS*, 19-23, 2015
11. Zappala A. F., Holl W. W., Post A., *Analytical Profiles of Drug Substances Volume 4*, Edited by Klaus Florey, The Squibb Institute for Medical Research New Brunswick, New Jersey, 1-20, 1975
12. Kumar V., Yang T.,  $\text{HNO}_3/\text{H}_3\text{PO}_4\text{-NaNO}_2$  mediated oxidation of cellulose-preparation and characterization of bioabsorbable oxidized celluloses in high yields and with different levels of oxidation, *Carbohydrate Polymer* 48, 403, 2002



13. U. S. Pat. (United States Pharmacopeia 23/National Formulary 18) (1995) Oxidized cellulose p. 318
14. Rodić Grabovac B., Prilog proučavanju hemijskog modifikovanja vlakana u cilju dobijanja medicinskog tekstila sa terapeutskim djelovanjem. Doktorska disertacija, Tehnološki fakultet, Univerzitet u Banjaluci, 2009.
15. Kankkunen T., Controlled transdermal drug delivery by iontophoresis and ion-exchange fiber, Academic dissertation, Department of Pharmacy, University of Helsinki, 31, 2002
16. Zimmitsky D. S., Yurkshtovich T. L., Bychovsky P. M., Adsorption of Zwitterionic Drugs on Oxidised Cellulose from Aqueous and Water/Alcohol Solutions, *J. Phys. Chem.*, 108, 1781
17. Domb A. J., Kost J., Wiseman D., *Handbook of Biodegradable Polymers*, Academic publishers imprint, Amsterdam, 345, 1997



## **IMPACT OF CARBON MONOXIDE ON THE ENVIRONMENT AND HUMAN HEALTH**

**Angelica Calamar<sup>\*</sup>, G. A. Gaman, D. Pupazan, M. Kovacs, S. Simion**

National Institute for Research and Development in Mine Safety and Protection to  
Explosion – INSEMEX Petroșani, 32-34 G-ral Vasile Milea Street, Postcode: 332047,  
Petroșani, Hunedoara County, ROMANIA

*\*insemex@insemex.ro*

### **ABSTRACT**

The paper presents methods of assessment and testing carbon monoxide imissions in the environment, both in protected adjacent areas located in the vicinity of commercial agents constituted as sources of pollution and in road traffic. The question of health, in places where due to intense industrial activity or heavy traffic there are significant concentrations of CO that affect population's health, it is also approached.

Importance of the paper resides in the fact that population's prolonged exposure to pollution caused by gas emissions, leads to alterations in health of the population, also significantly contributing to climate change.

**Key words:** pollution, impact, environment, health, carbon monoxide.

### **INTRODUCTION**

Concerns about environmental protection, commonly called ambient, prevalently require clearing several issues including those regarding air quality. In this case, special importance is given to obtaining information on local, regional and global quality of air. But all this requires an assessment of inspection and monitoring possibilities of air pollutant's disturbance and propagation agents in each region depending on level of industrial development and specific topographic and climatic conditions.

Atmosphere pollutants vary depending on their nature, concentration and duration of their action on the human body, thus causing serious consequences. Medical and ecology specialists have established a direct link between environmental degradation and increasing number of people suffering from allergies, asthma, cancer and other diseases. Primary pollutants that have negative impact on human health are: nitrogen oxides, sulfur dioxide, ground-level ozone, carbon monoxide, formaldehyde, phenols, particulate matter (PM10 and PM 2.5).

Carbon monoxide pollution comes mainly from incomplete combustion of fossil fuels, creating a negative impact on the environment and human health.

Monitoring the impact of air pollution on human health and the environment, measuring and assessing ambient air quality in fixed measurement points as well as maximum permissible limits for gases are imposed in Romania by Law no. 104/2011 and STAS 12574/87. This law transposes Directive 2008/50/EC of the European Parliament and of the Council of 21 May 2008 on ambient air quality and cleaner air for Europe.

Law 104/2011 on ambient air quality provides national measures on defining and establishing objectives for air quality designed to avoid and prevent negative events and reduce their harmful effects on human health and the environment but also assessing air quality throughout the country on the basis of common methods and criteria established at European level. The law makes provisions for obtaining information on air quality to support the fight against air pollution and discomfort caused by it as well as for long-term monitoring of trends and improvements resulting from measures taken at national and European level [4].

To control environmental pressures, contributions (royalties) and taxes are required from polluting organizations of each pollutant emitted into the environment. Usually these instruments are implemented in accordance with environmental agreements /authorizations and emissions standards, which allow ensuring, at minimum cost, observation of imissions standards (environmental quality). I would say that such taxes partially offset the social costs that polluters are not paying.

In the context presented, the question that arises is not to indefinitely increase the volume of these costs, but to be in line with the level of pollution admitted by the state of the art technology. In Romania, at present, there is no question of maintaining a certain level of environmental quality –feature specific to pollution optimum - but on the contrary, it is necessary to cover the line towards the proposed or determined limit of allowed pollution levels according to established criteria.

So, at present, it is necessary to objectively determine the level of pollution as well as intermediate levels along with their implications for economic restructuring. This implies introducing two expenditure components for environmental protection [1].

- Annual expenses for confuting pollution ( $C_{ppm}$ ), which, during transition periods may be viewed as investments to increase environment's assimilation capacity, respectively increasing its quality level;

- Annual expenses for preventing environmental pollution ( $C_{cpm}$ ), meaning investments at pollution sources for framing noxae emitted by them within limits imposed by standards.

Amount of annual pollution prevention expenditure  $C_{ppm}$ , must be equivalent to a reduction of raw emissions, so the net emission is lower than environment assimilation capacity growth due pollution control expenditure ( $C_{ppm}$ ).

## **MEASUREMENT METHODS FOR MONITORING CARBON MONOXIDE (CO)**

Main sources of carbon monoxide pollution are combustion processes (internal combustion engines), industrial processes (power plants), forest fires, agricultural burnings, fires.

The methods available to measure CO in ambient air range from fully automated methods using non-dispersive infrared technique and gas chromatography, to simple manual semi quantitative methods using detector tubes.

a. Dispersive infrared photometry

CO has a characteristic infrared absorption close to 4.6  $\mu\text{m}$ . Therefore, the absorption of infrared radiation by the CO molecule can be used to measure the concentration of CO in the presence of other gases. NDIR method is based on this principle. Non dispersive infrared systems have several advantages: are not sensitive to flow, do not require wet chemicals, are reasonably independent of changes in ambient air temperature, being sensitive to wide ranges of concentration and having short response time can be operated by non-technical staff [1].

b. Flame ionization gas chromatograph

CO can be measured either in samples of ambient air, collected every few minutes, either in air from captured samples, stored under pressure in inert cans. CO in air samples is dry, pre-concentrate, reduced to methane and detected by flame ionization (GC-FID).

c. Release of mercury

This technique involves reaction with warm mercuric oxide to produce elemental mercury and is available on sale. The method is sensitive to temperature and pressure. Continuous operation requires the removal of interference from sulfur dioxide, hydrogen and hydrocarbons. Successful continuous operation has been reported for a response time of 20s and detection limits close to 20 ppb. As a GC detector, releasing mercury (GC-ML) provides high sensitivity without interference inherent to continuous measurements. Air samples are collected in glass containers and injected into a gas two columns chromatograph. CO is then [5] detected by a detector of mercury oxide reduction. The system is linear from 10 ppb to more than 1,000 ppb, has a detection limit of less than 10 ppb and the reported uncertainty of approximately 2%.

d. Tunable laser diode spectroscopy

Tunable diode lasers (TDL) produce IR radiation with a line width which is narrow, compared with the usual absorption lines of atmospheric gases. IR radiation absorption by a single 4.6  $\mu\text{m}$  band-width rotation line can be exploited to measure CO with high accuracy, fast response and without interference; focus on a narrow spectral region provides high selectivity. The air samples are measured on opened routes through ambient air or by extraction of air samples through an orifice into a gas cell kept at a pressure well below ambient pressure. The radiation from a TDL is modulated on a very narrow wavelength area so that the absorption of CO produces an alternative current signal. The atmosphere is measured by the catalytic oxidation of CO to CO<sub>2</sub>. TDLS based tools are faster and more sensitive with a ordinary detection limit of a few parts per billion and a response time of a few seconds. This method has drawbacks for long-term monitoring, because of the high cost and the need for a skilled operator for on field measurements [3].

e. Fluorescence resonance

CO fluorescence resonance in ultraviolet vacuum was used for an extremely sensitive and fast response device. Atmospheric CO absorbs radiation in the range of 150 nm from a radio frequency discharge lamp, and fluorescence from the excited CO is detected by a photomultiplier tube. The lamp generates plasma in a continuous stream of CO<sub>2</sub> in argon. Fluorescence chamber pressure should be maintained between 7 and 9 mbar air to balance the interference between oxygen and the signal from CO. Recent improvements have reduced the detection limit to 3 ppb for a response time as short as a few seconds. High sensitivity and small size of the instrument make it appropriate for aeronautics measurements [3].

f. Other analysis methods

Color change induced by the reaction of a solid or liquid dates back to J. B. S. Haldane (1897-1898). Examples include silver colored solution method, NIST colorimetric gel, indicator tube for length of colored area and front analysis [8, 9]. The electrochemical technique represents another analysis method having a high specificity and a very good resolution. Electrochemical sensors operate by measuring the current of a small fuel cell and due to their small size and power needs, were used considerably in research studies of interior and exposure, reporting an accuracy of 0.2 to 2 ppm.

Directive 2008/50/EC establishes dispersive infrared spectroscopy as reference method for the measurement of carbon monoxide. SR EN 14626: 2012 - "Ambient air - Standard method for measurement of carbon monoxide by non-dispersive infrared spectroscopy" is the document indicating a method of continuous measurement for determining the concentration of CO present in ambient air based on the measuring principle of non dispersive infrared spectroscopy (NDIR) also preferred by international regulations [2].

European directives do not exclude other measurement methods, if they prove to be equivalent in performance to the NDIR analyzer.

This analyzer uses the method of absorption of non dispersive radiant energy in the infrared radiation spectrum which is based on the following principle: polyatomic gases absorb radiant energy in the infrared spectrum selectively, in different wavelength bands characteristic to each substance. In this way both the concentration of CO as well as CO<sub>2</sub> and HC can be measured. CO and CO<sub>2</sub> absorb infrared radiation at a wavelength of 4,7μm and 4,3μm.

NDIR analyzer measures the absorption at a given wavelength and compares the result with the absorption of standard gases. This analyzer performs a comparative not an absolute measurement, depending to a large extent on the quality of pure gas mixture.

## **CO POLLUTION SOURCES AND EFFECTS ON THE HUMAN BODY**

Main sources of carbon monoxide emission in the atmosphere are transport, domestic heating and industrial processes based on combustion, presence of gas being linked to fuels combustion in an insufficient amount of air, road, air and rail traffic, industrial processes producing iron and steel, petroleum refining [1].

The maximum limit approved by both the European Union and the World Health Organization is 10 mg/m<sup>3</sup> each 8 hours, also provided by Law 104/2011.

Large urban centers have the disadvantage of heavy traffic, which results in high concentrations of emissions. Depending on the engine equipping a car (gasoline or diesel) exhaust gases contain chemicals in different proportions.

One of pollutants resulting from exhaust gases is carbon monoxide, due to incomplete combustion, regardless of engine type (gasoline, diesel).

Mainly, increased CO emission occurs when combustion is incomplete, as it happens in the first few minutes of vehicle motor operation or when air and fuel mixture is imbalanced. It was found that about 80% of the carbon monoxide emission for 20 minutes of engine functioning occurs within the first 2 minutes of its operation.

Experiments showed that the total weight of carbon monoxide in car exhaust gases is up to 11%.

Certainly, there are other sources of carbon monoxide pollution leading to more or less increased concentration of this gas in the atmosphere, respectively coal burning, wood burning, waste burning, and fires in forest areas.

Carbon monoxide is not distributed homogeneously in the atmosphere, its concentration being variable especially at low altitudes, where, being a gas heavier than air and depending also on relief morphology and abundance of pollution sources may have different distributions.

The mechanism of carbon monoxide removal from atmosphere is not well understood. If at altitudes higher than 100 km oxidation of CO to carbon dioxide may occur, in lower Earth atmosphere this phenomenon does not occur as intense and presumably lead role in CO bonding is played by a number of microorganisms capable of using this gas as an energy source (chemosynthesis microorganisms).

Ground specific bacterial species belonging to the genera *Bacillus*, *Clostridium*, *Bacterium* etc., are able to effectively use large amounts of carbon monoxide either by oxidizing it to carbon dioxide or by using carbon for synthesis of methane or other organic substances specific to bacterial metabolism. The important role of microorganisms in removal of atmospheric CO has been proven experimentally. It is estimated that bacteria present in a volume of 1m<sup>3</sup> can absorb in the range of one hour up to 17 mg carbon monoxide, at an atmospheric concentration of 1cm<sup>3</sup> to 1m<sup>3</sup> of air [1].

### **IMPACT ON PUBLIC HEALTH**

Air pollution is a major environmental risk to health. Numerous scientific studies have linked air pollution to the following effects on population health [7]:

- effects on the respiratory system, causing or aggravating respiratory illnesses, decrease in lung function, increased frequency and severity of respiratory symptoms such as coughing and difficulty breathing or increased susceptibility to respiratory infections;
- effects on the cardiovascular system;
- effects on the nervous system, affecting learning, memory and behavior;
- effects on the reproductive system; cancer.

Some of these effects may even lead to premature death. Sensitive people such as elder people, children and people with pre-existing heart disease and lung disease or diabetes, present the greatest health risks because of air pollution.

Carbon monoxide is a gas with reducing properties, very slightly soluble in water, which has an asphyxiating action on the body. Smokers have a higher CO burn in the body compared to non-smokers. Individuals who are indoors may be exposed to high levels of CO coming from incomplete burning in heating or cooking stoves. CO enters the body by inhalation and is absorbed directly by the blood stream.

The toxic effect of CO on the body is determined by reaction of CO with blood hemoglobin (Hb). Typically, hemoglobin in blood operates as a carrier system, carrying oxygen in the form of oxyhemoglobin (O<sub>2</sub>Hb) from lungs to cells and CO<sub>2</sub> in the form of CO<sub>2</sub>Hb from cells to lungs. The normal concentration of COHb in blood is 0.5%. Prolonged exposure to humans or animals to CO can produce morphological changes at the level of the heart and brain. Brief exposure to low concentrations of CO produces effects on the central nervous system, vascular and respiratory systems.

Population segments most affected by carbon monoxide exposure are: children, elder people, people having respiratory and cardiovascular diseases, anemic people and smokers.

Symptoms of carbon monoxide poisoning are headache, fatigue, dizziness, visual disturbances, vomiting, fainting, coma and even death.

## **CONCLUSIONS**

- Carbon monoxide pollution comes mainly from incomplete combustion of fossil fuels, creating a negative impact on the environment and human health.
- Monitoring the impact of air pollution on human health and the environment, measuring and assessing ambient air quality in fixed measuring points as well as maximum limits established for gases values are provided by Law no. 104/2011 and STAS 12574/87.
- The main sources of carbon monoxide pollution are combustion processes (internal combustion engines), industrial processes (power plants), forest fires, agricultural fires, fires.
- Assessment of atmosphere carbon monoxide pollution level can also be performed using a portable gas analyzer based on the principle of non dispersive infrared spectroscopy and measured atmospheric concentrations are compared with the permissible limits in order to determine compliance level and the impact associated with businesses and road traffic.
- Prolonged exposure to humans or animals to CO can produce morphological changes at the level of the heart and brain. Brief exposure to low concentrations of CO produces effects on the central nervous system, vascular and respiratory systems.
- Increased air pollution is the main factor that determines changes in climatic stability both locally and globally.
- By coordinating actions at local, regional and national level, achieved through a strategy that seeks to protect atmosphere for sustainable development of society

by social and economic instruments, continuous long term improvement of life quality and environment quality can be achieved.

- Successful decrease of air pollution requires international cooperation. Given the long-range transport of pollutants and the relationship between air pollution and climate change, decisions at international level are required, regarding the objectives on climate change and air quality that can ensure that implementation of policies on climate change and air pollution will provide increased benefits to society.

## REFERENCES

1. Călămar A. (2016) - Extinderea domeniului de competență al laboratorului de mediu privind determinarea de monoxid de carbon din mediul inconjurator (imisii), Program Nucleu (PN 16 43 01 16)
2. Directive 2008/50/CE on ambient air quality and cleaner air for Europe
3. Ionel I., Popescu F. (2009) – Research and development in environment protection. Analysis of air quality in Timisoara
4. Law 104/2001 on ambient air quality
5. Simpozionul „Impactul Acquis-ului comunitar asupra echipamentelor și tehnologiilor de mediu - ACQUISTEM“, ediția a VIII-a 28 - 29 iulie 2011, Stația ICPE Agigea
6. Simpozionul „Impactul Acquis-ului comunitar asupra echipamentelor și tehnologiilor de mediu - ACQUISTEM“, ediția a VIII-a 28 - 29 iulie 2011, Stația ICPE Agigea
7. Ștefan S., Radu C., Belegante L., (2013), Analysis of air quality in two sites with different local conditions, *Environmental Engineering and Management Journal*, 12, 371-379.
8. USEPA (1991), „Pollution Prevention 1991: Progress on Reducing Industrial Pollutants” U.S.EPA, EPA 21P- 3003, October
9. USEPA (1991), „Pollution Prevention Research Needs”, ORD Report to Congress





## SETAE FROM PINE PROCESSIONARY MOTH AND BROWN-TAIL MOTH CAUSE ALERGIES IN HUMANS AND ANIMALS

Milka Glavendekic<sup>1\*</sup>, G. Nakic<sup>2</sup>, D. Kaseric<sup>3</sup>, V. Popovic<sup>3</sup>

<sup>1</sup>University of Belgrade, Faculty of Forestry, Belgrade, SERBIA

<sup>2</sup>Public Enterprise „Srbijašume“, Forest Unit Bujanovac, SERBIA

<sup>3</sup>Public Enterprise „Srbijašume“, Forest Unit Priboj, SERBIA

\*[milka.glavendekic@sfb.bg.ac.rs](mailto:milka.glavendekic@sfb.bg.ac.rs)

### ABSTRACT

Pine processionary moth (PPM) (*Thaumetopoea pityocampa* Denis & Schiffermüller (Lepidoptera: Notodontidae)) is one of species which is expanding its range due to changed climate conditions. In Serbia PPM was found in Forest Unit Bujanovac in 2011 and in May, 2016 it moved 4km from the locality where it was observed for the first time. Brown tail moth *Euproctis chrysorrhoea* L. (Lepidoptera: Erebidae) outbreaks were recorded in the Western Balkans from 2012. Severe defoliation was studied in Forest Unit Priboj and Novi Pazar. Both species produce urticating hairs and cause cutaneous reactions and respiratory distress in humans and animals.

**Key words:** Pine processionary moth, Brown tail moth, forest pest, allergens, urticating hairs (setae).

### INTRODUCTION

Pine processionary moth from ancient times was considered as a violent poison. In the XVI<sup>th</sup> century it was on the list of poisonous animals [1]. It originates from northern Africa to southern Europe, from Atlantic coast to the western part of Turkey. PPM is well known forest pest in Mediterranean and Sub-Mediterranean region. In former Yugoslavia it was recorded in Dalmatia, Montenegro and at AP Kosovo and Metohija in the vicinity of city Peć. During late 1990s PPM was observed in the Paris basin and it was one of the first signs of expansion of the natural range due to winter warming. In early 2000s it was confirmed an expansion in latitude and elevation [2]. During the last 1970s PPM was observed at Mt. Prokletije, in the locality Žare at an elevation of 1,100 m. An outbreak occurred at that locality in 1996-1997 [3]. PPM is oligophagous on *Pinus* spp., *Cedrus atlantica*, *C. deodara*, and some species belonging to the genera *Abies*, *Larix* and *Pseudotsuga*. It occurs on isolated trees and stand edges. It could cause severe defoliations in pine forests. The eggs are laid in batches on pine needles or twigs and covered by scales. Initially larvae feed on current-year needles near the oviposition sites. Soon after they move to old ones. Larvae build silk tents after they hatch from the eggs. They leave tents when they move to more sun-exposed parts of the crown, so they could change 2-3 tents before overwintering. Caterpillars leave trees in head-to-tail processions to search for suitable sites in soil for cocoon spinning. Contact

with setae (urticating hairs) can provoke oral, skin and eye damage which are most of the time benign. In some cases it leads to allergic reactions up to anaphylactic shock.

## MATERIAL AND METHOD

The research on biology and ecology of PPM and brown tail moth has been conducted in forests of Public Enterprise "Srbijašime". Sex pheromone monitoring of PPM was carried out from 2009-2015 in Forst Unit Bujanovac at 8 localities in pine forest (Fig.1). Besides distribution it was studied egg parasitism as well. Distribution of the recent outbreak and ecology of brown tail moth were studied in Forest Unit Priboj and Novi Pazar (Fig. 2). Evidence of cutaneous reactions of employ of Forest Enterprise "Srbijašime" was observed.



Figure 1. Rujan 6a, the first record of PPM



Figure 2. Defoliation of browntail moth

## RESULTS AND DISCUSSION

Monitoring of mail flight was conducted from July, 2016 till the end of September 2015. Flight period of mails was recorded in 2010 from July to the first decade of September. Monitoring in 2015 was conducted from the first decade of July and last mail was captured at September, 28<sup>th</sup>. Larval development in 2010 started at the end of August and tents were observed in the third decade of September. In 2015 larval development was delayed for almost one month. The first tents were observed in the third decade of October. Larvae were feeding at the beginning of November, 2015 (Fig. 3 A-C). If we compare abundance of caught mails in pheromone traps in 2010 and 2015, it is evident that population is increasing. Almost two times more mails were caught in 2015.

**Table 1.** Sex pheromone monitoring of PPM in Forest Unit Bujanovac and private forests from 2009-2015

NO.	FOREST UNIT	LOCALITY / MANAGEMENT UNIT	ELEVATION (m)
1	Bujanovac	V. Trnovac, M.U.Trnovačka reka 19/a	646
2	Bujanovac	Rajince, M.U. Preševo, 147a	589
3	Bujanovac	Rajince, M.U. Preševo, 150a	533
4	Bujanovac	Crnotince, M. U. Preševo, 129a	482
5	Bujanovac	M.U. Rujan, 11/a	563
6	Bujanovac	M. U. Rujan, 6a	601
7	private forest	K. M. Spančevac	733
8	private forest	K. M. Trejak	727

Natural enemies follow pests and in the research area so far is recorded egg parasitoid *Ooencyrtus pityocampae* (Hymenoptera: Encyrtidae). The level of parasitism was very low. This is poliphagous parasitoid and due to the literature its efficacy is lower compared to specialist *Baryscapus servadeii* (Hymenoptera: Eulophidae). In the period 1996-1997 at the locality Žare an outbreak was suppressed by high egg parasitism of *B. servadeii* [4].

PPM larvae from the third instar develop urticating setae (Fig. 3-D). The length of setae is 0.2mm and they are situated in groups on the dorsal part of the abdomen. If larvae are disturbed, setae are actively released and can cause severe allergic reactions to humans and animals [5]. Cutaneous reactions among employ in Forest Unit Bujanovac were not observed so far and there is no evidence that residents asked for help at local health clinics (Fig. 3-E). Veterinary service in Bujanovac rural and urban area did not report so far any health problem on local sheep, goat, cattle populations or dogs attending infected area (Fig. 3-F). Veterinary practitioners were not aware of the risk of allergies. They got an information from forest specialist that forest pest with urticating setae could cause allergies in wild and domestic animals. When education for local residents and professionals was organized in the vicinity of Bujanovac, it was attended by local residents, nurses, forest professionals, agricultural professionals and biologist dealing with environmental protection in Bujanovac Municipality. No one practitioner from veterinary field attended the course. An epidemiological survey among Veterinary's Clinic in France revealed that the most affected animals are dogs (74.3%), whilst cattle (3.5%), horses (8.6%) and cats (9.5%) were less affected. Main symptoms of envenomation by the processionary larva in dog is strong inflammation and a swelling of the oral mucosa of the lips and tongue. Respiratory impairment can also be reported if dust loaded with irritating hairs reach the respiratory tract. This is leading to inflammation of the nasal mucosa, rhinitis and bronchitis. [5]. In some cases affected cattle stop eating, separate themselves from the herd and some animals could die.

In Forest Unit Priboj there was in 2014 an area of 834, 67 ha totally defoliated due to the browntail moth outbreak. It was a culmination phase of the outbreak. Thousands of moths were attracted by light and entered suburb of the city Priboj. Residents in rural and urban area were disturbed and asked for help on local clinics. Cutaneous reactions among employ of Forest Unit Priboj were observed from 2011, but serious reactions were more frequent in 2014. Severe defoliation was in Management Unit Badnjak, departement 60. In the following years was significant decrease of the population. Survey in May, 2016 revealed latency of browntail moth at this locality. Cutaneous reactions of animals were not reported.

In Forest Unit Novi Pazar it is likely that browntail moth outbreak started in 2013 and the culmination was in 2015. Residents in affected forest area reported health problems from cutaneous reactions to respiratory disturbances among children population.



**Figure 3.** Pine processionary moth- autumn nest (A), nest - detail (B), young larvae without setae (C), larvae with setae (D), erythematous rash (E), sheep and goats in affected forests (F)



The browntail moth caterpillar has tiny (0.15 mm) urticating hairs (setae) that cause skin rash (dermatitis). Residents may develop dermatitis from direct contact with the caterpillar or indirectly from contact with airborne hairs. The hairs become airborne from either being dislodged from the living or dead insect (caterpillar or adults) or they come from cast skins when the caterpillar molts. Most people affected by the hairs develop a localized rash that lasts for a few hours up to several days. Some sensitive individuals could suffer severe rash that lasts for several weeks. The rash results from both a chemical reaction to a toxin in the setae and a physical irritation because of embedded setae in the skin. Respiratory distress from inhaling the hairs has been reported and can be serious. Toxin is stable and remains a hazard for many years.



**Figure 4.** Browntail moth – female with egg cluster (A), young larva (B)

PPM and browntail moth should be monitored as it is regulated for other forest pests. For forest professionals and residents in affected areas there is high risk both from allergies caused by PPM caterpillars and browntail moth. It would be recommended to avoid reactions to PPM larvae: humans and animals should avoid heavily infested areas in March-May and especially on windy days and in May when the larvae descend in processions from the trees. Keep children away if larva processions are seen, don't touch them or disturb. Do not collect cones or wood from infested forest. In communities close to infested trees avoid to dry clothes outdoors in months when larvae are urticating (March – May). Occupational exposure related to forest employ when working in infested forests, precautionary measures are essential. Leave as small an area of skin exposed as possible and wear appropriate clothing and footwear. If exposure is high protective goggles or a mask is needed. Patients allergic to larvae should not work in infested forests. Doctors and veterinary practitioners should become familiar with PPM and browntail moth related diseases. Correct diagnosis and appropriate information that emphasizes precautionary measures will reduce health risk in humans and animals. Prognosis of envenomation by PPM larvae in animals can be severe, although in many cases reactions are mild. It depends on the intensity of contacts with irritating hairs. Fatal cases are rare, although they are not excluded.

## CONCLUSION

Pine processionary moth expands its range due to climate change. It is spreading from 2009-2016 in pine forests in Forest Unit Bujanovac. From the first report of tents in 2011, it expanded its range for more than 4 km forward. Forest is used by local residents and domestic animals are feeding in infested forests. There is not so far reported allergic reaction of residents and domestic animals to PPM caterpillars.

Outbreaks of browntail moth were reported from 2014-2016 in Forest Unit Priboj and Novi Pazar. Occupational exposure was reported from 2011 in Forest Unit Priboj. Residents suffer mainly from skin rash and they develop dermatitis from direct contact with the caterpillar or indirectly from contact with airborne hairs. In April and May symptoms mainly occur. All developmental stages of browntail moth could distribute toxic setae. Residents in affected forest area reported respiratory disturbances among children population.

Precautionary measures are needed in affected areas. For PPM is important to avoid contact with larvae from third to fifth instar. Doctors and veterinary practitioners should become familiar with PPM and browntail moth related diseases. Correct diagnosis and appropriate information will reduce health risk in humans and animals.

## REFERENCES

1. Roques A., A. Battisti: Pine Processionary Moth, a Species Known Since the Ancient Times. In: Roques A. (ed.) *Processionary Moths and Climate Change: an Update*. Springer, Dordrecht, 1-13, 2015.
2. Battisti A., Stastny M., Netherer S., Robinet C., Schopf A., Roques A., Larson S.: Expansion of geographic range on the pine processionary moth caused by increased winter temperatures. *Ecological Applications*, 15, p. 2084-2096, 2005.
3. Roques A., Rousselet J., Avcı M., Avtzi D. N., Basso A., Battisti A., Ben Jamaa M. L., Bensidi A., Berardi L., Berretima W., Branco M., Chakali G., Çota E., Dautbašić M., Delb H., El Alaoui El Fels M. A., El Mercht S., El Mokhefi M., Forster B., Garcia J., Georgiev G., Glavendekić M. M., Goussard F., Halbig P., Henke L., Hernández R., Hódar J. A., Ipekdal K., Jurc M., Klimetzek D., Laparie M., Larsson S., Mateus E., Matošević D., Meier F., Mendel Z., Meurisse N., L. Mihajlović, Mirchev P., Nasceski S., Nussbaumer C., Paiva M.-R., Papazova I., Pino J., Podlesnik J., Poirot J., Protasov A., Rahim N., Sánchez Peña G., Santos H., Sauvard D., Schopf A., Simonato M., Tsankov G., Wagenhoff E., Yart A., Zamora R., Zamoum M., and Robinet C.: Climate Warming and Past and Present Distribution of the Processionary Moths (*Thaumetopoea* spp.) in Europe, Asia Minor and North Africa. In: Roques A. (ed.) *Processionary Moths and Climate Change: an Update*. Springer, Dordrecht, pp 81-161, 2015.
4. Mihajlović Lj., Roganović D.: Parasitoids of eggs of *Thaumetopoea pityocampa* Schiff. (Lepidoptera: Thaumetopoeidae) at the area of Metohija

- (Serbia, Yugoslavia). In Simpozijum entomologa Srbije 1997, 2-4 October 1997, Goč, Zbornik rezimea (Abstract book) (p.34), 1997 [in Serbian].
5. Moneo I., Battisti A., Dufour B., Carcia-Ortiz, J.C., Gonzales-Munoz M., Moutou F., Paolucci P., Toffolo E.P., Riviere J., Rodriguez-Mahillo A.-I., Roques A., Roques L., Vega J.M., Vega J.: Medical and Veterinary Impact of the Urticating Processionary Larvae. In: Roques A. (ed.) *Processionary Moths and Climate Change: an Update*. Springer, Dordrecht, pp 359-410, 2015.

This page is intentionally left blank



## AUTORS' INDEX

---

### A

---

Aksic, M.	391
Alagic, S.	245
Aleksic, J.	507
Aleksic, V.	177
Alivojvodic, V.	282, 288, 643, 657
Andjelovic, I.	302
Andjus, S.	61, 66
Andric, S.	354
Anicic, O.	718
Antonijevec, D.	507
Antonijevec, M. M.	231, 449
Apostolovski Trujic, T.	97
Arsenovic, B.	368
Arsic, N.	778
Arslan, H.	117
Atanackovic, A.	61, 66
Avramovic, Lj.	334

### B

---

Babic, B.	617
Babic, V.	740, 792
Baisui, H.	334
Balanovic, Lj.	696
Basic, A.	631
Basic, Z.	547
Beljic, C.	148
Berenji, K.	835
Bijelovic, S.	848
Bjelovic, Z.	177
Bobic, S.	585
Bodroza, D.	407
Bognar, C.	564
Borota, M.	747
Boskovic Rakocevic, Lj.	551, 558
Bozhinovska, E.	760
Bozic, A.	282, 288, 643, 657
Brandmajer, T.	754
Brcaninovic, M.	732
Budinski Simendic, J.	177

Bukumiric, N.	282, 288, 643, 657
Bunic, S.	398
Busatlic, I.	128
Busatlic, N.	128
Buvac, K.	33

### C

---

Calamar, A.	109, 862
Canak Atlagic, J.	61, 66
Caprita, A.	590, 596
Caprita, R.	590, 596
Cekerevac, M.	258, 430
Cibulic, V.	156, 212, 421
Ciric, D.	828
Cocic, M.	265
Cuculovic, A.	55
Cuculovic, R.	55
Cvetanovski, V.	91
Cvetkovic, A.	449
Cvetkovic, V.	821

### D

---

Denic, M.	185
Dervisevic, A.	238
Dervisevic, I.	238
Devic, S.	265
Dimishkovska, B.	799
Dimishkovski, J.	799
Dimishkovski, N.	799
Dimitrijevic, S. B.	327
Dimovic, S.	442
Djarmati, S.	288, 643
Djikanovic, V.	61, 66
Djokic, N.	835
Djordjevic, D.	470
Djudjic, R.	856
Djukic, D.	378
Djuknic, J.	61, 66
Djuric, M.	391
Djurovic, D.	122, 841

Djurovic, V.	378
Dobrnjac, S.	133
Dogandzic, M.	821
Domazet, M.	354
Domjan, V.	778
Dragulovic, S. S.	327
Dramicanin, M. D.	533
Draskovic, G.	571
Drazic, G.	507
Drmanac, D.	814, 821
Ducic, V.	740, 792
Durkalic, D.	603

## E

Erb, M.	564
Erceg, T.	177, 293

## F

Fedajev, A.	603
Filipovic, D.	675, 682

## G

Gaidukov, E. N.	349
Gaman, G. A.	109, 862
Gardic, V.	321
Gavrilovic, Z.	44
Glavendekic, M.	869
Glisic, I.	551, 558
Gluscevic, B.	148
Gonzalez, M. A.	501
Grekulovic, V.	696
Gucer, S.	117
Gudzic, N.	391
Guleryuz, G.	117
Gutic, K.	732
Gvozdenac, S.	378, 564, 571

## H

Haga, K.	334
Haracic, N.	128
Husic, H.	732

## I

Ignjatovic, M.	821
Ilic, B.	538
Ilic, Lj.	688
Ilic, M.	61, 66
Ilic, M.	521
Ilic, M. S.	610
Ilic, R.	551, 558
Ivanov, S.	216
Ivanovic, A. T.	327
Ivanovic, B.	368
Ivanovic, S. Z.	327

## J

Jacimovski, S.	192, 201
Jelic, I.	442, 507
Jonovic, R.	334
Jovanovic, B.	84, 91
Jovanovic, I.	277, 302, 308
Jovanovic, M.	515
Jovic, B.	71
Jovic, M.	442
Jovic, S.	718

## K

Kalinovic, J.	97
Kalinovic, T.	97
Karanac, N.	33
Karpati, Zs.	564
Kaseric, D.	869
Kekez Kljajic, A.	711
Kizek, J.	482
Knezevic, D.	378
Knezevic, J.	71
Knezevic, V.	19
Kocic, B.	521
Kolesnikov, A. V.	349
Kolesnikov, V. A.	349
Komadinic, V.	726
Kongoli, F.	32
Korac, M.	785
Kovacs, M.	109, 862
Kracun-Kolarevic, M.	61, 66
Krakovsky, I.	293
Krnjajic, S.	538
Krstic, I.	313
Krstic, M.	740, 792

Krstic, S.	327
Kulic, G.	245
Kulina, M.	558

## L

Lazarevic, V.	313
Lazarevska, D.	772
Lazic, B.	740, 792
Lazic, D.	133
Lazic, G.	77, 414
Lazic, L.	482
Leovac, S.	354
Levi, Z.	133, 407
Lopicic, Z.	223, 437
Lovrenic Jugovic, M.	482
Lukic, D.	585, 848
Luž, D. M.	663
Lutovac, S.	148
Lutynski, A.	162, 477
Lutynski, M.	104, 477, 501
Lutynska, S.	104

## M

Magdalinovic, S.	277, 302, 308, 327
Majstorovic, J.	785
Malinovic, B. N.	398
Malinovic, T.	398
Malnar, M.	245
Manasijevic, S.	726
Mandic, L.	378
Mandic, M.	464
Mandic, N.	245
Manjencic, D.	293
Maric, M.	449
Marinkovic, D.	77
Marinkovic, M.	688
Marinkovic, N.	61, 66
Marjanovic, M.	571
Markovic, A. D.	610
Markovic, D.	384, 391
Markovic, I.	216
Markovic, V.	61, 66
Markovic, Z.	272, 277, 321
Masic, S.	533
Masic, S.	547
Medic, M.	533
Merdic, N.	128
Micic, V.	177

Mihajlovic, M.	223, 437
Mihajlovic, V.	638
Mikic, M.	302, 308
Mikusova, E.	626
Miladinovic, S.	192, 201
Milanovic, D.	277, 302, 308, 321
Milanovic, M. M.	610
Milenkovic, M.	740, 792
Miletic, A.	293
Milic, S. M.	231
Milincic, M.	682
Miljkovic, D.	77, 414
Milojevic	585
Miodragovic, G.	
Milojkovic, J.	223, 437
Milosavljevic, A.	526
Milosavljevic, J.	97
Misic, M.	515
Mitev, T	760
Mitovski, A.	696
Mladenovic, S.	457
Momcilovic, N.	362
Mrazovac Kurilic, S.	156, 212
Mugosa, B.	122, 841
Muhamedagic, S.	128

## N

Nakic, G.	869
Neskovic, S.	578
Nestorovic, S.	55
Nikolic, A.	754
Nikolic, E.	754
Nikolic, I.	122
Nikolic, V.	61
Nikolic Bujanovic, Lj.	258, 430
Nuric, A.	141, 732
Nuric, S.	141, 732

## O

Ognjanovic, S.	341
Otasevic, S.	521

## P

Pajic, D.	457
Pantic, D.	703
Pantovic, K.	327
Pantovic, M.	169, 526

Pantovic, R.	185, 253, 277, 302, 321, 334
Paunovic, M.	61, 66
Paunovic, G.	551, 558
Pavelkic, V.	169
Pavlicevic, J.	177
Pavlov, A.	760
Pavlovic, M. G.	169
Pavlovic, M. M.	169
Pecelj, M.	682
Pejic, B.	391
Pejovic, B.	718
Penavin Skundric, J.	133, 407
Perendic, S.	828
Petric, I.	507
Petrovic, B.	521
Petrovic, D.	308
Petrovic, J.	223, 437
Petrovic, J.	334
Petrovic, M.	223, 437
Petrovic, S.	277, 302, 308
Petrovic Mihajlovic, M. B.	231
Petrovic Pantic, T.	464
Petrushevska, S.	772
Pezo, L.	754
Pilic, B.	293
Pinteala, G.	650
Polavder, S.	156, 421
Popovic, B.	564
Popovic, M.	414
Popovic, N.	61, 66
Popovic, T.	71
Popovic, V.	869
Praunseis, Z.	490
Presburger Ulnikovic, V.	156, 421
Prijic, Z.	835
Prosen, H.	341
Pupazan, D.	862
Putic, S.	282, 533

## R

Radicevic, R.	293
Radisa, R.	726
Radojevic, A.	97
Radojicic, V.	245
Radovanovic, M. B.	231
Radovanovic, R.	192
Radovic, V.	538
Rakic, S.	711

Rakocevic, T.	747
Rakovic, M.	61, 66
Rancic, B.	521
Rancic, N.	521
Raspopovic, N.	711
Ristanovic Ponjavic, I.	457
Ristic, I.	293
Ristic, R.	384, 391
Riznic, D.	603
Rodic Grabovac, B.	856
Rusmirovic, J.	282

## S

Sackarska, K.A.	760
Sailovic, P.	856
Samardzic, I.	675
Samolov, K.	464
Saric, M.	354
Sarkocevic, Z.	515
Sava, C.	650
Savic, Lj.	718
Savkovic, S.	785
Secerov, V.	675
Sekularac, G.	384, 391
Sekulic, S.	806
Serbula, S.	97
Setrajcic, J.	192
Seven Erdemir, U.	117
Shibayama, A.	334
Simeonov, K.	806
Simic, A.	747
Simion, S.	109, 862
Simonovic, A. T.	231
Sladojevic, S.	407
Sljivic Ivanovic, M.	442
Slomski, P.	501
Smelcerovic, M.	470
Smiciklas, I.	11, 442
Sokic, M.	696
Sokolova, L.	835
Sokolovic, J.	321, 828
Sostaric, T.	223, 437
Stakic, B.	828
Staletovic, N.	156, 212, 421
Stamenkovic, G.	61
Stamenkovic, U. S.	216
Stamenovic, M.	282, 288, 643, 657
Stanisavljevic, M.	313
Stankovic, M.	48

Stanojlovic, R.	321
Starac, M.	341
Stavretovic, N.	33, 670
Stefanovska, I.	760
Stevanovic, J.	169
Stevanovic, Z.	334
Stirbanovic, Z.	272, 277, 321
Stojadinovic, D.	778
Stojadinovic, S.	185, 253
Stojanovic, D.V.	1
Stojanovic, Dj.	19, 703
Stojanovic, M.	223, 437
Stojcetovic, B.	515
Stolic, P.	526
Stolic, S.	526
Strainovic, G.	272, 321
Strbac, N.	696
Strbac, O.	40, 44
Szczepanski, J.	501

## T

---

Tanasic, Lj.	177
Tanaskovic, A.	457
Tanaskovic, S.	378, 564, 571
Tanikic, D.	253
Tasic, Z. Z.	231
Tilinger, S.	33
Todorovic, B.	84, 414
Tokalic, R.	148
Tomic, M.	258, 430
Tomic, M.	464
Tomkova, E.	626
Tomovic, J.	61, 66
Torovic, Lj.	585, 848
Toth, L.	109
Trbic, G.	675
Trifunovic, M.	156, 212, 421
Trumic, B. T.	327
Tubic, B.	61, 66

## U

---

Urosevic, D.	334
Urosevic, S.	470

## V

---

Varga, A.	482
Vasiljevic, B.	61, 66
Vasiljevic, Lj.	133
Velickovic, M.	631, 703
Veljkovic, Z.	464
Veselinovic, D.	55
Vidanovic, N.	148
Vranic, N.	354
Vrvic, M. M.	841
Vucanovic, M.	40
Vujacic, V.	754
Vujcic, I.	533
Vukasinovic, J.	362
Vukoje, I.	533
Vukosavljevic, V.	551

## Z

---

Zdravkovic, M.	258, 430
Zenunovic, J.	141
Zikic, M.	185, 253
Zivkovic, D.	696
Zivkovic, M.	253
Zoric, K.	61, 66

---

**AUTHORS ARE RESPONSIBLE FOR THE  
CONTENT AND LANGUAGE OF THEIR  
ARTICLES**

---



**ISBN 978-86-6305-043-3**