

Palladium(ii) ortho-cyano-aminothiophenolate (ocap) complexes

Al-Jibori, Subhi A.; Al-Janabi, Ahmed S.; Irzoqi, Ahmed A.; Abdullah, Ali I.A.; Basak-Modi, Sucharita; Orton, Georgia R.F.; Ghosh, Shishir; Wagner, Christof; Hogarth, Graeme

DOI:

[10.1039/d2dt02681c](https://doi.org/10.1039/d2dt02681c)

License:

Creative Commons: Attribution-NonCommercial (CC BY-NC)

Document Version

Publisher's PDF, also known as Version of record

Citation for published version (Harvard):

Al-Jibori, SA, Al-Janabi, AS, Irzoqi, AA, Abdullah, AIA, Basak-Modi, S, Orton, GRF, Ghosh, S, Wagner, C & Hogarth, G 2022, 'Palladium(ii) ortho-cyano-aminothiophenolate (ocap) complexes', *Dalton Transactions*, vol. 51, no. 47, pp. 18136-18142. <https://doi.org/10.1039/d2dt02681c>

[Link to publication on Research at Birmingham portal](#)

General rights

Unless a licence is specified above, all rights (including copyright and moral rights) in this document are retained by the authors and/or the copyright holders. The express permission of the copyright holder must be obtained for any use of this material other than for purposes permitted by law.

- Users may freely distribute the URL that is used to identify this publication.
- Users may download and/or print one copy of the publication from the University of Birmingham research portal for the purpose of private study or non-commercial research.
- User may use extracts from the document in line with the concept of 'fair dealing' under the Copyright, Designs and Patents Act 1988 (?)
- Users may not further distribute the material nor use it for the purposes of commercial gain.

Where a licence is displayed above, please note the terms and conditions of the licence govern your use of this document.

When citing, please reference the published version.

Take down policy

While the University of Birmingham exercises care and attention in making items available there are rare occasions when an item has been uploaded in error or has been deemed to be commercially or otherwise sensitive.

If you believe that this is the case for this document, please contact UBIRA@lists.bham.ac.uk providing details and we will remove access to the work immediately and investigate.

Cite this: *Dalton Trans.*, 2022, **51**,
18136

Palladium(II) *ortho*-cyano-aminothiophenolate (ocap) complexes†

Subhi A. Al-Jibori,^{*a} Ahmed S. Al-Janabi,^{id a} Ahmed A. Irzoqi,^b Ali I. A. Abdullah,^c Sucharita Basak-Modi,^d Georgia R. F. Orton,^e Shishir Ghosh,^{d,e} Christof Wagner^f and Graeme Hogarth^{id *e}

A series of Pd(II) complexes containing *ortho*-cyano-aminothiophenolate (ocap) ligands have been prepared and their molecular structures elucidated. Hg(II) ocap complexes, [Hg(SC₆H₃XN(C≡N))] (X = H, Me) (**1**), react with Na₂S to afford HgS and Na₂[ocap] which reacts *in situ* with K₂[PdCl₄] to afford palladium ocap complexes [Pd(SC₆H₃XN(C≡N))] (2). A second route to these coordination polymers has also been developed from reactions of 2-aminobenzothiazole (abt) complexes, *trans*-PdCl₂(abt)₂ (**3**), with NaOH. We have not been able to crystallographically characterise coordination polymers **2**, but addition of PPh₃, a range of phosphines and cyclic diamines affords mono and binuclear complexes in which the ocap ligand adopts different coordination geometries. With PPh₃, binuclear [Pd(μ-κ²-ocap)(PPh₃)₂] (**4**) results, in which the ocap bridges the Pd₂ centre acting as an S,N-chelate to one metal centre and binding the second *via* coordination of the cyanide nitrogen. In contrast, with diphosphines, Ph₂P(CH₂)_nPPh₂ (n = 1–4), mononuclear species predominate as shown in the molecular structures of Pd(κ²-ocap)(κ²-Ph₂P(CH₂)_nPPh₂) (**5–7**; n = 1–3). With 2,2'-bipy and 1,10-phen we propose that related monomeric chelates Pd(κ²-ocap)(κ²-bipy) (**9**) and Pd(κ²-ocap)(κ²-phen) (**10**) result but we have been unable to substantiate this crystallographically. Addition of HgCl₂(phen) to **9a** (generated *in situ*) affords heterobimetallic Pd(κ²-phen)(μ-κ²,κ¹-ocap)HgCl₂(κ²-phen) (**11**), in which Hg(II) is coordinated through the ring sulfur.

Received 16th August 2022,
Accepted 10th November 2022

DOI: 10.1039/d2dt02681c

rsc.li/dalton

1. Introduction

Amides are widely used ligands in coordination chemistry, being able to stabilise both high and low-valent metal centres by varying the degree of metal–ligand interaction by virtue of being able to participate in metal–ligand π-bonding.^{1–3} In general they are relatively easily prepared *via* the deprotonation of secondary amines and in this way a large range of metal–amide complexes have been developed especially at high-

valent metal centres *via* metathesis reactions. However, closer inspection reveals that these are almost exclusively those with alkyl or trimethylsilyl-substituents and examples with electron-withdrawing groups are, in comparison, rare.⁴ The cyanide group has a unique set of chemical and physical properties. Thus, along with being electron-withdrawing, its linear nature makes it sterically non-demanding, it has the ability to take part in π-bonding in either a donor or acceptor capacity and is also able to coordinate to secondary metal centres. As far as we are aware, cyanide-substituted amines and amides remain virtually unexplored.⁵

In contrast, *ortho*-aminothiophenolate complexes (SC₆H₄NH) are relatively common,^{6–12} being accessible from the double deprotonation of 2-aminothiophenol, *N*-substituted variants remain virtually unknown. In extensive studies, Wieghardt has shown that the *ortho*-aminothiophenolate ligand is redox-active being able to stabilise coordinated metals in a range of oxidation and spin states,⁶ while related *ortho*-phenylenediamido (RNC₆H₄NR) ligands are also capable of redox behaviour.^{13–15} A key component of this redox activity is the ability of the ligand to delocalise charge, being able to do this even with the non-participating proton on nitrogen. Thus, the ability to delocalise developing negative charge onto a cyanide

^aDepartment of Chemistry, College of Science, University of Tikrit, Tikrit, Iraq^bDepartment of Chemistry, College of Education, University of Tikrit, Tikrit, Iraq^cDepartment of Chemistry, College of Science, University of Salahaddin, Erbil, Iraq^dDepartment of Chemistry, University College London, 20 Gordon Street, London WC1H 0AJ, UK^eDepartment of Chemistry, King's College London, Britannia House, 7 Trinity Street, London SE1 1DB, UK^fInstitute für Chemie, Martin-Luther-Universität, Halle-Wittenberg, Kurt-Mothes-Str. 2, D-06120 Halle, Germany†Electronic supplementary information (ESI) available: All experimental methods and characterising data, along with details of the X-ray crystallographic structure determinations. CCDC 2114230, 2114233, 2114234, 2181464 and 2201775. For ESI and crystallographic data in CIF or other electronic format see DOI: <https://doi.org/10.1039/d2dt02681c>

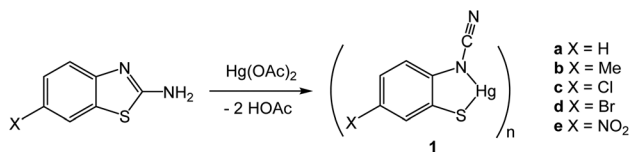

Scheme 1 Synthesis of [Hg(ocap)]_n (**1a–e**) upon dehydrogenative ring-opening of 2-aminobenzothiazoles upon addition of Hg(OAc)₂.

substituent suggests that these species will show a rich redox chemistry, potentially providing low energy pathways for oxidation state changes during catalysis.

We recently reported the high yield synthesis of a series of Hg(II) *ortho*-cyano-aminothiophenolate (ocap) complexes, [Hg{SC₆H₃XN(C≡N)}]_n (**1a–e**) (Scheme 1) resulting from the simple addition of 2-aminobenzothiazole and substituted derivatives to mercuric acetate in warm EtOH.^{16,17} These contain the previously unreported ocap ligand and result from loss of hydrogen and sulfur–carbon bond scission. While they have limited solubility in common organic solvents, addition of phosphines affords a series of soluble derivatives in which the ocap ligand was shown to be highly versatile, three different binding modes (A–C) being shown crystallographically,^{16,17} while a fourth (D) was proposed for **1a–e** (Chart 1).

In seeking to develop the chemistry of highly delocalised redox-active ocap ligands we sought a route to late transition metal derivatives, especially Pd(II), as we reasoned that such

complexes were potential oxidation catalysts. Herein we provide details of the successful application of this strategy which allows access to Pd(II)-ocap complexes, which in analogy with the mercury complexes can adopt different binding modes.

2. Results and discussion

2.1 Synthesis of coordination polymers [Pd{SC₆H₃XN(C≡N)}]_n (**2a–b**)

Stirring [Hg{SC₆H₃XN(C≡N)}]_n (**1a–b**)^{16,17} with a slight excess of Na₂S in a water–EtOH mixture for *ca.* 1 h resulted in formation of a black precipitate, assumed to be HgS. This was removed by filtration and to the resulting yellow solution, which we assume to contain Na₂[ocap] but have made no attempt to confirm, we added K₂[PdCl₄] in EtOH and refluxed this mixture for *ca.* 3 h. This resulted in formation of a red-brown solid which was isolated by filtration to give [Pd{SC₆H₃XN(C≡N)}]_n (**2a–b**) (Scheme 2). We have also developed a second route to **2a–b** which avoids the use of mercury. Thus, reaction of K₂[PdCl₄] with 2-aminobenzothiazoles affords simple substitution complexes, *trans*-PdCl₂(2-abt)₂ (**3a–b**), **3a** being previously prepared and crystallographically characterised.¹⁶ Refluxing basic solutions of **3a–b** resulted in the slow formation of **2a–b**. Thus, after heating **3a** for 4 h, **2a** was isolated in *ca.* 71% yield, and while slightly lower than the mercury route (95%) it does negate the use of toxic mercury salts.

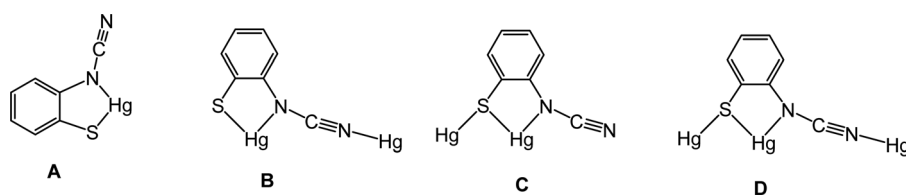
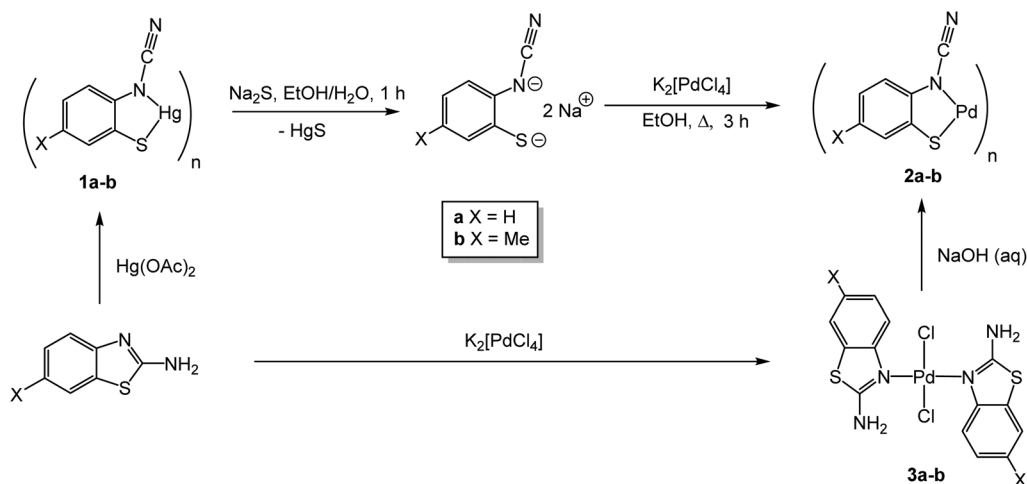

Chart 1 Binding modes (A–D) of the *ortho*-cyano-aminothiophenolate (ocap) ligand.



Scheme 2 Synthetic routes to [Pd(ocap)]_n (**2a–b**).



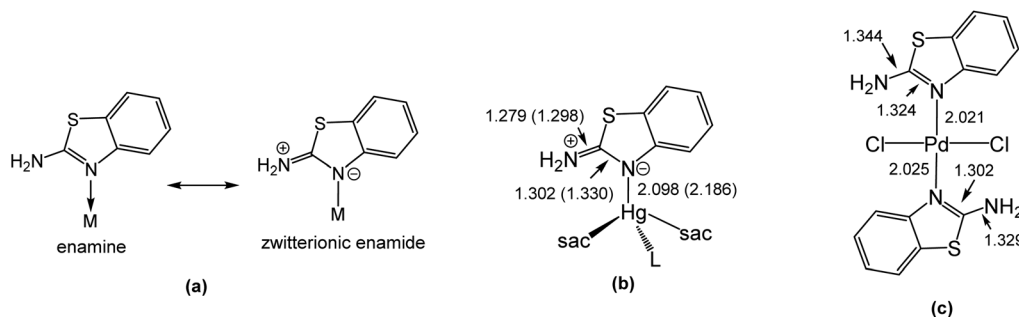

Chart 2 (a) Enamine and zwitterionic resonance hybrids of coordinated abt, (b) important bond lengths in $\text{Hg}(\text{sac})_2(\text{abt})\text{L}$ (L = MeOH, dmsO (brackets)),²⁰ (c) important bond lengths in $\text{trans-PdCl}_2(2\text{-abt})_2$ (**3a**) which has two crystallographically inequivalent abt ligands.¹⁹

Complexes **2a–b** have poor solubility in common organic solvents suggesting they are coordination polymers (or oligomers) in a similar fashion to **1a–e**.¹⁶ Unfortunately, we have been unable to obtain suitable crystalline forms of either **1a–e** or **2a–b** to unequivocally confirm this. Complexes **2a–b** are sparingly soluble in dmsO, which we associate with the partial breakdown of the polymeric structure to afford dmsO adducts $[\text{Pd}\{\text{SC}_6\text{H}_3\text{XN}(\text{C}\equiv\text{N})\}(\text{dmsO})_x]$, and this allowed us to record ^1H and $^{13}\text{C}\{^1\text{H}\}$ NMR data for these adducts.

We have previously investigated the formation of **1a** from reaction of 2-aminobenzothiazole (abt) and $\text{Hg}(\text{OAc})_2$,¹⁸ a transformation which occurs without added base. Thus, upon coordination, neutral enamine and zwitterionic enamide forms (Chart 2a) are accessible and at the Lewis acidic Hg(II) centre (Chart 2b) there is an obvious shortening of the C–NH₂ bond suggesting a significant degree of zwitterionic enamide form. In contrast in **3a** (Chart 2c) the two crystallographically inequivalent abt ligands have longer C–NH₂ bonds suggestive of the enamine form. Nevertheless, these protons must still be acidic such that upon addition of base deprotonation results in activation leading to eventual C–N bond scission and ring-opening, the mechanism of which has been probed at Hg(II).¹⁷

2.2 Reaction with PPh₃: synthesis of $[\text{Pd}(\mu\text{-}\kappa^2, \kappa^1\text{-ocap})(\kappa^1\text{-PPh}_3)_2]$ (**4**)

Given the relative insolubility of coordination polymers **2a–b** and our previous success in breaking down the analogous Hg(II) complexes **1a–b** upon addition of phosphines,^{16,17} we attempted to prepare mononuclear square planar complexes of the type $\text{Pd}(\kappa^2\text{-ocap})(\text{PPh}_3)_2$ via addition of 2 equivalents of PPh₃ to **2a–b** in refluxing CHCl_3 . However, in no instance did we generate such mononuclear complexes, but rather dimeric $[\text{Pd}(\mu\text{-}\kappa^2, \kappa^1\text{-ocap})(\text{PPh}_3)_2]$ (**4a–b**) resulted, being isolated as red-brown crystalline solids in good yields (Scheme 3).

Formation of a dimeric product was confirmed through the X-ray structure of **4a** details of which are given in Fig. 1 and Table 1. The two crystallographically inequivalent Pd(II) centres are square-planar, each being bound by a single PPh₃ ligand and bridged by two ocap ligands. Each of the latter act as an N,S-chelate to one Pd centre coordinating with bite angles of 84.75(10) and 85.27(10)° at Pd(1) and Pd(2) respectively. The

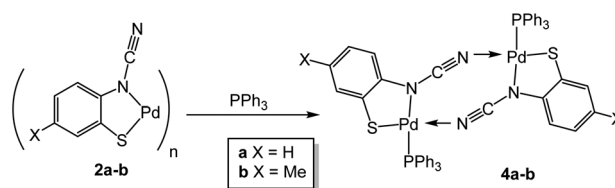

Scheme 3 Reactions of **2** with PPh₃.

final coordination site is taken up by the nitrogen of the cyanide group, which lies *trans* to sulfur. Thus each ocap ligand acts in a tridentate $\mu\text{-}\kappa^2, \kappa^1$ manner, donating a total of 6 electrons, four to one, and two to the second, Pd(II) centre. The central 8-membered Pd₂N₄C₂ ring is not flat but rather is bowl-like, with the phenyl rings of the *ortho*-aminothiophenolate moieties lying on the same side and extending the bowl-like structure. Spectroscopic data are in accord with the solid-state structure. Each shows a singlet resonance in the $^{31}\text{P}\{^1\text{H}\}$ NMR spectrum and the cyanide is seen as a strong peak between 2162–2169 cm^{-1} in the IR spectrum. As mentioned above, heating **4a–b** with excess PPh₃ did not result in scission of the binuclear structure. Thus, we suggest that in coordination polymers **2a–b**, the substructure seen in **4a** likely is adopted the polymeric network being completed by further coordination of sulfur, which is lost upon addition of PPh₃.

2.3 Reactions with diphosphines, $\text{Ph}_2\text{P}(\text{CH}_2)_n\text{PPh}_2$ ($n = 1\text{--}4$): synthesis of $\text{Pd}(\kappa^2\text{-ocap})\{\kappa^2\text{-Ph}_2\text{P}(\text{CH}_2)_n\text{PPh}_2\}$ (**5–8**)

Given the dimeric structure of **4a–b** we reasoned that a chelating diphosphine may be capable of displacing the metal-bound cyanide group with concomitant formation of a mononuclear chelate. We first considered the small bite angle diphosphine, 1,1'-bis(diphenylphosphino)methane (dppm), which while often found to bridge two metal centres, is also a good chelate ligand.²⁰ Indeed, heating a solution of dppm and a red suspension **1a–b** in CHCl_3 for 2 h led to the slow formation of a clear red solution, which after cooling to room temperature and partial evaporation of solvent gave **5a–b** as orange and brown crystalline solids respectively in good yields (Scheme 4).



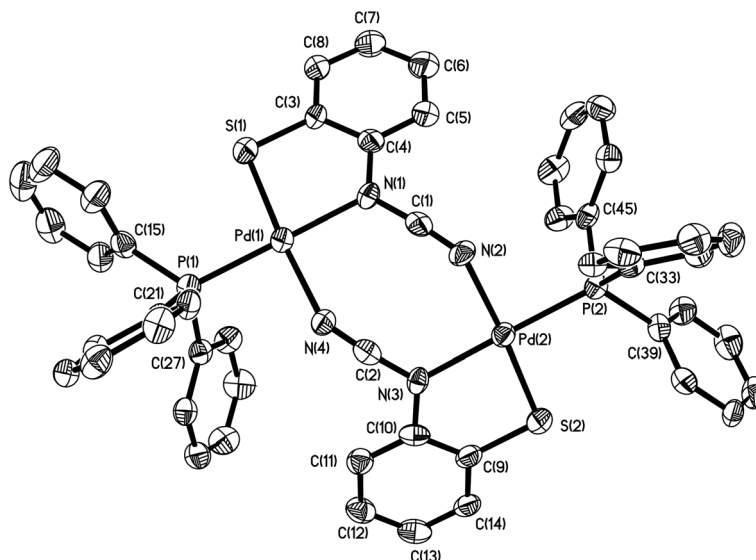
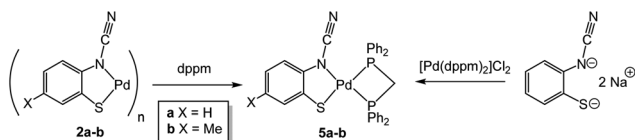

Fig. 1 Molecular structure of **4a** with thermal ellipsoids at the 50% level and hydrogen atoms omitted for clarity.

Table 1 Selected bond lengths (Å) and angles (°) for palladium ocap complexes

	4a	5a	6a	7b	11
Pd–S	2.2221(14) & 2.2233(14)	2.2818(8)	2.2949(7)	2.3141(18)	2.2334(13)
Pd–N	2.047(4) & 2.058(4)	2.041(2)	2.0655(19)	2.084(6)	2.018(4)
Pd–N≡C	2.039(4) & 2.047(4)				
Pd–P (<i>trans</i> S)		2.2744(8)	2.2969(6)	2.2976(19)	
Pd–P (<i>trans</i> N)	2.2118(14) & 2.2157(14)	2.2217(9)	2.2358(6)	2.255(2)	
Pd–N (bipy)					2.082(4) & 2.017(4)
N–C	1.275(6) & 1.282(6)	1.299(4)	1.288(3)	1.341(10)	1.304(6)
C≡N	1.160(6) & 1.165(6)	1.147(4)	1.185(3)	1.152(10)	1.157(6)
S–Pd–N	84.71(11) & 85.25(11)	84.79(8)	84.96(6)	84.87(15)	84.31(12)
P–Pd–P		72.96(3)	85.36(2)	91.20(7)	
N–Pd–N	91.19(15) & 91.19(15)				80.83(17)



Scheme 4 Synthesis of Pd(κ^2 -ocap)(κ^2 -dppm) (**5**).

The structure of **5a** was elucidated using X-ray crystallography, the details of which are given in Fig. 2 and Table 1. The complex contains a single square planar Pd(II) centre which is coordinated to a dppm-chelate and a κ^2 -ocap ligand, forming bite angles of 72.98(3) and 84.79(7)° respectively. The latter is in accord with those found in **4a** showing that de-coordination of the cyanide does not affect ligand binding. Complexes **5a–b** could also be prepared in similar yields upon heating $[\text{Pd}(\kappa^2\text{-dppm})_2]\text{Cl}_2$ and the yellow filtrate, believed to be $\text{Na}_2[\text{ocap}]$ formed upon addition of Na_2S to **1a–b**. Solution NMR data support the solid-state structure two phosphorus centres are inequivalent, and this is confirmed in solution as seen by a pair of doublets ($J_{\text{PP}} = 99$ Hz) at -45.5 and -28.6 (d, J 99 Hz) in

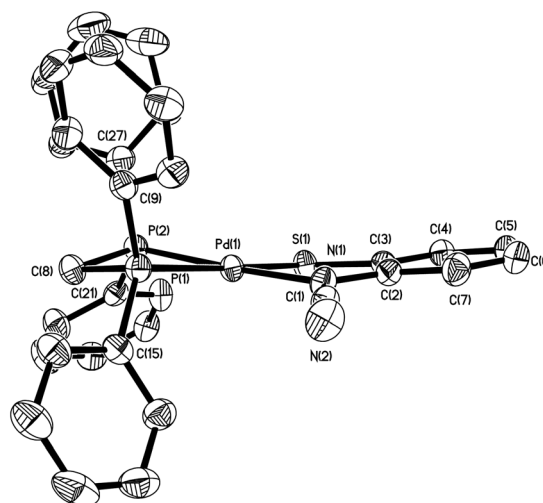

Fig. 2 Molecular structure of **5a** with thermal ellipsoids at the 50% level and hydrogen atoms omitted for clarity.

the $^{31}\text{P}\{^1\text{H}\}$ NMR spectrum. The two Pd–P bond lengths are very similar, that lying *trans* to sulfur being slightly longer [by ca. 0.05 Å].



Following on from the unexpected isolation of dpmm-chelate complexes **5**, we next explored reactions of **1** with the more flexible diphosphines, $\text{Ph}_2\text{P}(\text{CH}_2)_n\text{PPh}_2$ ($n = 2-4$) anticipating that related chelate complexes would result. This is indeed the case with red-brown dppe, dppp and dppb complexes **6-8** respectively being isolated in good yields (*ca.* 60–90%) upon addition of the diphosphines to **2** in EtOH (Scheme 5). The dppe complexes, $\text{Pd}(\kappa^2\text{-ocap})(\kappa^2\text{-dppe})$ (**6a-b**), are also accessible in comparable yields following reaction of $\text{Na}_2[\text{ocap}]$ with $[\text{Pd}(\text{dppe})_2]\text{Cl}_2$. Spectroscopic data are in full accord with the proposed structures, the chelating nature of the diphosphine being confirmed by the observation of a pair of doublets in the $^{31}\text{P}\{^1\text{H}\}$ NMR spectra with J_{PP} couplings of *ca.* 29 Hz (dppe) and 53 Hz (dppp), which do not vary significantly with substituent X. More unexpected were the J_{PP} values of 44.5 and 29.0 Hz for the dppb complexes **8a** and **8b** respectively. It is not clear why these vary to such a large extent but suggests that the precise geometry, especially the P–Pd–P bond angle is flexible for this large diphosphine.

Molecular structures of **6a** and **7b** (Fig. 3) were confirmed by crystallographic studies. While bond lengths and angles are generally very similar to those in **5a** (Table 1), the bite angle of the diphosphine varies. Thus, in **6a** and **7b** the P–Pd–P bond angles of $85.36(2)^\circ$ and $91.20(7)^\circ$ respectively are *ca.* 12–19° larger than that in **5a**, highlighting the flexibility of the $\text{Pd}(\kappa^2\text{-ocap})$ moiety to support a range of diphosphine ligands. While we have been unable to crystallographically characterise **8a-b**, the phosphorus–phosphorus coupling constants are indicative of chelate formation.

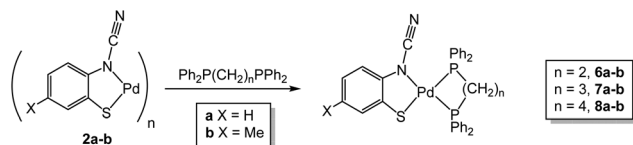

Scheme 5 Synthesis of $\text{Pd}(\kappa^2\text{-ocap})(\kappa^2\text{-Ph}_2(\text{CH}_2)_n\text{PPh}_2)$ (**6-8**).

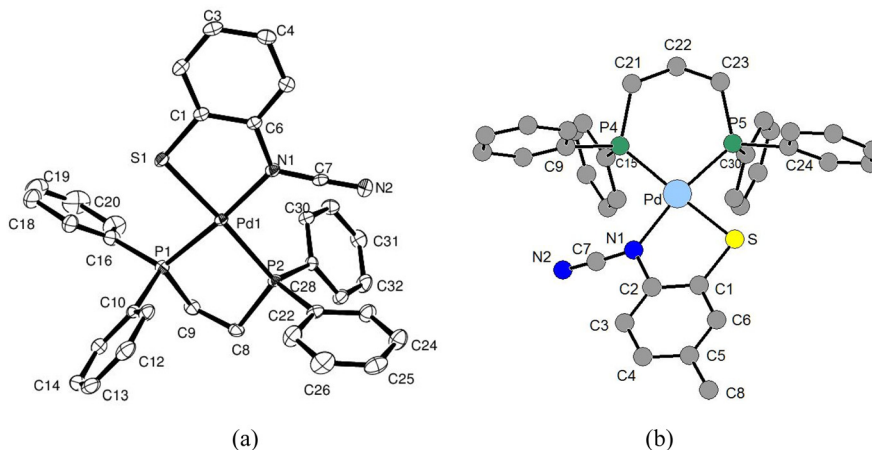

Fig. 3 Molecular structures of (a) **6a** and (b) **7b** with hydrogen atoms omitted for clarity.

2.4 Reactions with 2,2'-bipy and 1,10-phen: synthesis of $\text{Pd}(\kappa^2\text{-ocap})(\kappa^2\text{-bipy})$ (**9**) and $\text{Pd}(\kappa^2\text{-ocap})(\kappa^2\text{-phen})$ (**10**)

Reactions of **2** with cyclic diamines, 2,2'-bipyridine (bipy) and 1,10-phenanthroline (phen) also lead to formation of mononuclear chelate complexes, namely $\text{Pd}(\kappa^2\text{-ocap})(\kappa^2\text{-bipy})$ (**9a-b**) and $\text{Pd}(\kappa^2\text{-ocap})(\kappa^2\text{-phen})$ (**10a-b**) upon heating in CHCl_3 (Scheme 6). Products were isolated as solids in good yields following simple filtration and washing, and NMR and analytical data are in full accord with the proposed formulations. Unfortunately, we have been unable to grow X-ray quality crystals of any of these complexes to confirm their mononuclear nature.

2.5 Synthesis of bimetallic $\text{Pd}(\kappa^2\text{-phen})(\mu\text{-}\kappa^2, \kappa^1\text{-ocap})\text{HgCl}_2(\kappa^2\text{-phen})$ (**11**)

Following our inability to fully characterise **9-10** in the solid state, we added one equivalent $\text{HgCl}_2(\kappa^2\text{-phen})$ ²¹ to **9a** prepared *in situ*. This gave a red-brown solid and a red filtrate, slow evaporation of which led to the isolation of well-formed crystals suitable for X-ray diffraction, the results of which are shown in Fig. 4 and Table 1. The complex is heterobimetallic $\text{Pd}(\kappa^2\text{-phen})(\mu\text{-}\kappa^2, \kappa^1\text{-ocap})\text{HgCl}_2(\kappa^2\text{-phen})$ (**11**), which co-crystallises with three molecules of CHCl_3 . The $\text{Pd}(\kappa^2\text{-phen})(\mu\text{-}\kappa^2, \kappa^1\text{-ocap})$ sub-unit is as expected and contains a square planar Pd (ii) centre ligated by phenanthroline and ocap chelates with bite angles of $80.83(17)^\circ$ and $84.31(12)^\circ$ respectively. The sulfur of the ocap ligand is also bound to the Hg(ii) centre [$\text{Hg}(1)\text{-S}(1)$ 2.6113(15) Å] which adopts a distorted square-based pyramidal coordination geometry. Thus, the two chlorides remain *cis* [$\text{Cl}(1)\text{-Hg}(1)\text{-Cl}(2)$ $100.63(6)^\circ$] and subtend angles of $99.64(5)^\circ$ and $113.03(5)^\circ$ with the $\text{S}(1)\text{-Hg}(1)$ vector, while mercury-bound phenanthroline is also distorted out of the plane [$\text{S}(1)\text{-Hg}(1)\text{-N}(5)$ $94.33(5)^\circ$, $\text{S}(1)\text{-Hg}(1)\text{-N}(6)$ $106.38(5)^\circ$] and the bridging sulfur brings the two metal ions into relatively close contact [$\text{Hg}(1)\cdots\text{Pd}(1)$ 3.482(2) Å]. As might be anticipated, the two phenanthrolines are approximately parallel to one another and there is also a stacking of individual molecules with the chloroform molecules weakly binding to either side of the stack.



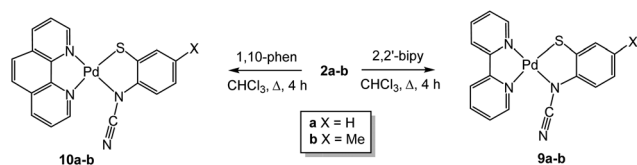

Scheme 6 Synthesis of Pd(κ^2 -ocap)(κ^2 -bipy) (**9**) and Pd(κ^2 -ocap)(κ^2 -phen) (**10**).

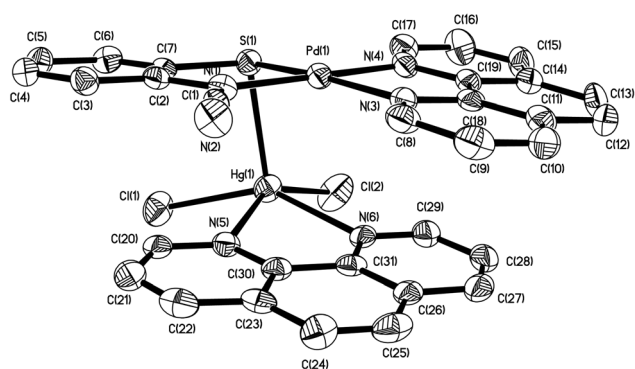

Fig. 4 Molecular structure of **11** with thermal ellipsoids at the 50% level and hydrogen atoms omitted for clarity.

We have been unable to collect NMR data for **11** due to its insolubility in all common solvents and this suggests that the bulk material is also comprised of **11** since **10a** is soluble in dmsO. This (in part) supports our view that coordination polymers **1–2** are held together by M–S–M interactions in the solid-state. It is also noteworthy that while in **11** the cyanide remains uncoordinated, in PPh₃ derivatives **4a–b**, sulfur is bound to a single metal centre, while the cyanide is metal-bound. Possibly the relatively soft Hg(II) centre favours sulfur coordination, although the π -stacking of the phenanthrolines may also lead to this form being favoured.

3. Summary and conclusions

We have reported here the synthesis of the first examples of Pd(II) *ortho*-cyano-aminothiophenolate (ocap) complexes. In many respects the chemistry is similar to that found at Hg(II) centres.^{16,17} Thus, both [Hg{SC₆H₃XN(C≡N)}]_n (**1**) and [Pd{SC₆H₃XN(C≡N)}]_n (**2**) are coordination polymers, showing low solubility in common organic solvents. They are soluble in dmsO, but likely this leads to a breakdown of the polymeric structure to afford M(ocap)(dmsO)_n. The polymeric structure is broken down upon addition of PPh₃. For palladium this leads to formation of dimeric complexes in which the Pd₂ centre is held together by secondary coordination of the cyanide. Thus, the ocap ligand acts as binds *via* mode **B** (Chart 1) and we have found that even addition of excess PPh₃ does not lead to scission of this bond. With the small bite-angle diphosphine, dppm, cyanide binding is released, and simple mononuclear

square planar complexes are formed, as is the case for the more flexible diphosphines, while similar behaviour is also believed to occur in 2,2'-bipyridine and 1,10-phenanthroline adducts. Such small Pd(II) complexes may have potential as oxidation catalysts and we are actively investigating this and also their electrochemical properties to understand the nature of the electronic delocalisation. While in the phosphine adducts, sulfur is bound only to a single metal centre, addition of HgCl₂(κ^2 -phen) to **10a** affords an unexpected bimetallic complex in which the two metal centres are bridged by sulfur. Thus, in the crystallographically characterised complexes reported herein, the ocap ligand displays three coordination modes, something previously noted at the Hg(II) centre.^{16,17} These results show that this ligand type is coordinatively flexible and given its expected electronic delocalisation, a rich chemistry is anticipated. Aspects of the redox chemistry of palladium and other ocap complexes is currently under study in our laboratories and will be reported in due course.

Conflicts of interest

There are no conflicts of interest.

Acknowledgements

We thank the University of Tikrit and King's College London for partial support of this work. S. B.-M. thanks Erasmus Mundus for a Postdoctoral Fellowship, S. G. thanks the Commonwealth Scholarship Commission for the award of a Commonwealth Scholarship and G. R. F. O. thanks King's College London for PhD funding.

References

- 1 D. C. Bradley and M. H. Chisholm, *Acc. Chem. Res.*, 1976, **9**, 273–280.
- 2 M. D. Fryzuk and C. D. Montgomery, *Coord. Chem. Rev.*, 1989, **95**, 1–40.
- 3 O. Clement, B. M. Rapko and B. P. Hay, *Coord. Chem. Rev.*, 1998, **170**, 203–243.
- 4 M. S. Driver and J. F. Hartwig, *J. Am. Chem. Soc.*, 1997, **119**, 8232–8245.
- 5 (a) R. J. Crutchly and M. L. Naklicki, *Inorg. Chem.*, 1989, **28**, 1955–1958; (b) R. J. Crutchly, *Coord. Chem. Rev.*, 2001, **219–221**, 125–155; (c) T. Ramana, P. Saha, M. Das and T. Punniyamurthy, *Org. Lett.*, 2010, **12**, 84–87.
- 6 (a) S. R. Presow, M. Ghosh, E. Bill, T. Weyhermüller and K. Wieghardt, *Inorg. Chim. Acta*, 2011, **374**, 226–239; (b) P. Ghosh, E. Bill, T. Weyhermüller and K. Wieghardt, *J. Am. Chem. Soc.*, 2003, **125**, 3967–3969; (c) P. Ghosh, A. Begum, E. Bill, T. Weyhermüller and K. Wieghardt, *Inorg. Chem.*, 2003, **42**, 3208–3215; (d) S. Sproules and K. Wieghardt, *Coord. Chem. Rev.*, 2010, **254**, 1358–1382.



- 7 J. Vincente, M. T. Chicote, M. D. Bermudez, P. G. Jones, C. Fittschen and G. M. Sheldrick, *J. Chem. Soc., Dalton Trans.*, 1986, 2361–2366.
- 8 (a) D. Sellman, S. Emig, F. W. Heinemann and F. Knoch, *Angew. Chem., Int. Ed. Engl.*, 1997, **36**, 1201–1203; (b) D. Sellman, S. Emig and F. W. Heinemann, *Angew. Chem., Int. Ed. Engl.*, 1997, **36**, 1734–1736.
- 9 K. Sorasaenee, J. R. Galán-Mascarós and K. R. Dunbar, *Inorg. Chem.*, 2002, **41**, 433–436.
- 10 J. C. Noveron, M. M. Olmstead and P. K. Mascharak, *Inorg. Chem.*, 1998, **37**, 1138–1139.
- 11 (a) W.-F. Liaw, N.-H. Lee, C.-M. Chen, G.-H. Lee and S.-M. Peng, *J. Am. Chem. Soc.*, 2000, **122**, 488–494; (b) W.-F. Liaw, C.-M. Lee, G.-H. Lee and S.-M. Peng, *Inorg. Chem.*, 1998, **37**, 6396–6398; (c) W.-F. Liaw, C.-K. Hsieh, G.-Y. Lin and G.-H. Lee, *Inorg. Chem.*, 2001, **40**, 4468–4475.
- 12 A. Majumber and S. Sarkar, *Inorg. Chim. Acta*, 2009, **362**, 3493–3501.
- 13 M. M. Khusniyarov, K. Harms, O. Burghaus, J. Sundermeyer, B. Sarkar, W. Kaim, J. van Slageren, C. Duboc and J. Fiedler, *Dalton Trans.*, 2008, 1355–1365.
- 14 M. M. Khusniyarov, T. Weyhermueller, E. Bill and K. Wieghardt, *J. Am. Chem. Soc.*, 2009, **131**, 1208–1221.
- 15 R. Zhang, Y. Wang, Y. Zhao, C. Redshaw, I. L. Fedushkin, B. Wu and X.-J. Yang, *Dalton Trans.*, 2021, **50**, 13634–13650.
- 16 S. A. Al-Jibori, A. A. Irzoqi, E. G. H. Al-Saraj, A. S. Al-Janabi, S. Basak-Modi, S. Ghosh, K. Merzweiler, C. Wagner, H. Schmidt and G. Hogarth, *Dalton Trans.*, 2015, **44**, 14217–14219.
- 17 S. A. Al-Jibori, A. A. Irzoqi, A. S. M. Al-Janabi, A. I. A. Al-Nassiry, S. Basak-Modi, S. Ghosh, C. Wagner and G. Hogarth, *Dalton Trans.*, 2022, **51**, 7889–7898.
- 18 (a) E. J. Gao, L. Liu, M. C. Zhu, Y. Huang, F. Guan, X. N. Gao, M. Zhang, L. Wang, W. Z. Zhang and Y. G. Sun, *Inorg. Chem.*, 2011, **50**, 4732–4741; (b) S. A. Al-Jibori, A. T. Habeeb, G. H. H. Al-Jibori, N. A. Dayaaf, K. Merzweiler, C. Wagner, H. Schmidt and G. Hogarth, *Polyhedron*, 2014, **67**, 338–343.
- 19 S. A. Al-Jibori, Z. S. Afandi, K. Merzweiler, C. Wagner, H. Schmidt, S. Basak-Modi and G. Hogarth, *Polyhedron*, 2014, **81**, 442–449.
- 20 R. J. Puddephatt, *Chem. Soc. Rev.*, 1983, **12**, 99–127.
- 21 G. J. Sutton, *Aust. J. Chem.*, 1959, **12**, 637–642.

