

Intelligent data analysis in an automated system of input control of raw materials on a continuous process line for the production of meat products

*Boris Kapovsky*¹, *Pavel Plyasheshnik*^{2,*}, and *Victoria Stefanova*²

¹V.M. Gorbатов Federal Research Center for Food Systems of Russian Academy of Sciences, 109316 Moscow, Russia

²Federal State Budgetary Educational Institution of Higher Education Russian Biotechnological University, 125080 Moscow, Russia

Abstract. The article considers conditions for partial grinding of a frozen meat block in case of detection of extraneous inclusion in it by the raw material input control system. The processing of raw materials occurs on an automated in-line production line for meat products using a single-stage chopping process. The authors stipulate a continuous inspection of all meat blocks with full automation of control operations. Localization of the layer of meat containing inclusion solves the trajectory problem of moving the block of raw materials in the guiding planes of the single-stage chopper with the establishment of a mandatory safe chopping zone. The analysis helps to determine the boundaries of the safety zone. When solving the trajectory problem, the authors accept the assumption of a rectilinear trajectory of movement of a block of meat during its single-stage chopping. The foundation of this presumption stems from a research study of the energy usage of the drive of the raw material cutting mechanism in the working mode. The calculation of estimates of numerical characteristics of the experimental distribution of power consumption of the electric motor drive of the cutting mechanism allows to judge about the reduction of dynamic loads in the technological system "shredder - meat block" causing deviations from the plane-parallel motion of the meat block, because of rigid fixation of the block in the cutting zone. Using the control system reduces the risks of using substandard raw materials within its competence while maintaining the productivity of the technological line.

1 Introduction

Production control over the compliance of manufactured products with standards, technical regulations and conditions must be implemented to ensure the quality and safety of food products. Technical requirements for frozen meat blocks show the inadmissibility of extraneous inclusions in them, which can get into the further technological processing of raw materials. Continuous inspection of all meat blocks will require full automation of control

* Corresponding author: plyasheshnik@rambler.ru

operations in the conditions of in-line production. Thus, the creation of automated production control of frozen meat blocks is an urgent task for the meat industry.

Developed in "V.M. Gorbатов Federal Research Center for Food Systems of Russian Academy of Sciences" intellectual system of the automated input control of the frozen meat raw materials is intended for completing technological lines of flow production of meat products. It is supposed that the mentioned technological lines realize one-stage milling of block frozen meat by the milling method. The proposed control system can be used in the production of minced meat for the production of sausages, semi-finished products, baby food, as well as canned food.

Figure 1 shows the scheme of the automated control system of frozen meat raw materials on technological lines of continuous action.

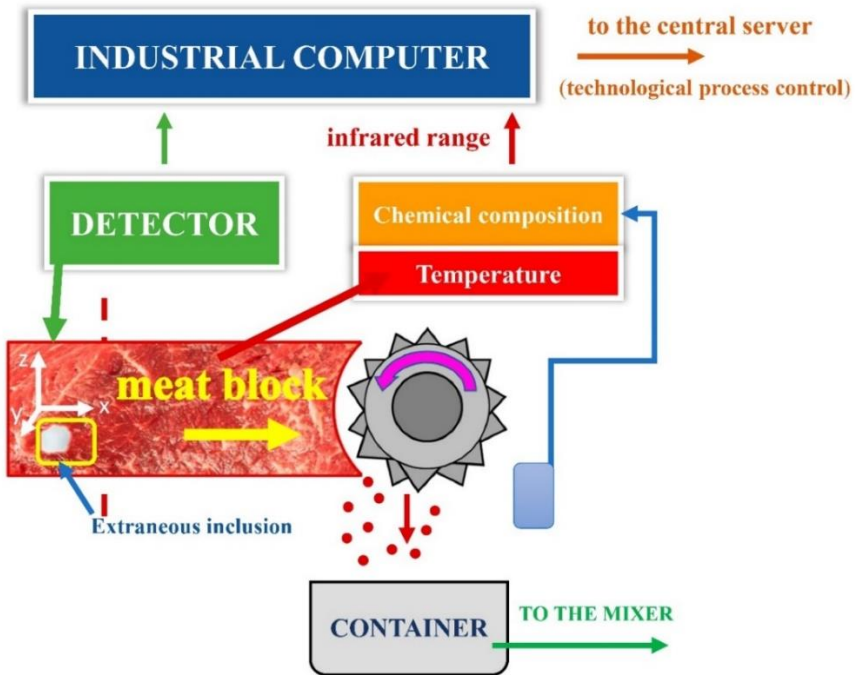

Fig. 1. Scheme of the automated control system of frozen meat raw materials on technological lines of continuous action.

The industrial computer controls the system. An information network connects it to a higher hierarchical level of control. The functioning of the internal control system must solve three production control tasks:

- detection of extraneous inclusions in the raw material;
- in case of detection of an extraneous inclusion, determines its position in a specified coordinate system for partial grinding of a frozen meat block to the location of the extraneous inclusion with the specified distance ("safety zone") from the chopper cutting body, which eliminates the possibility of the object getting into further technological processing of raw materials
- temperature control of raw materials in the shredding area in order to maintain meat shredding.

The operation algorithm of the internal control system provides for the solution of production control tasks:

- Remotely, in the infrared range, measures the temperature of the meat in the contact zone of the cutter with the cutting surface of the meat block. The temperature in the center of the block is equal to the storage temperature of the raw material in the freezer before cutting.
- Remotely, in the infrared range (spectral interval 1100 - 1650 nm), it measures the chemical composition of the shredded meat (protein, fat, moisture). They sent the data to the central computer to control the mixing of minced meat of a given nutritional value in the mincing machine.
- The control computer that completes the internal control system calculates the temperature of the meat layer next to the contact area with the chopper working tool as the average temperature of the raw material along the arc of cutting, considering the heat input for the "ice - water" phase transition. Using the temperature measurement data and the predictive adaptive model, the computer calculates a short-term prediction of the processed meat temperature. Referring to the archive of optimal values of mode parameters of the raw material cutting process, formed for different temperature conditions, the control computer forms commands for the actuators of the chopper actuators to maintain raw material cutting.
- The detector, which completes the internal control system and operates in the X-ray range, detects extraneous inclusions in the raw material according to standard specifications (glass splinters, metal particles, solid mineral particles, some types of plastics and rubber blends, calcined bones). Extraneous inclusion detection is image recognition using modern neural network technologies. Inclusion image texture (gradation of grayscale in a monochrome image of an inclusion), descriptive features (perimeter of a figure, area of a figure, non-roundness of a figure, bending energy) are used to generate and describe the features of an extraneous inclusion in the raw material. The object's features must undergo selection in order to reduce computational complexity. The processing of the feature vectors includes removing outliers and normalizing them before selection. A multilayer neural network with an architecture is suitable for constructing a classifier. A function of synoptic weights and thresholds is introduced as the criterion of the classifier network, for which an optimization problem should be solved [1].
- New principle of control system response to extraneous inclusion detection. The system allows partial processing of a raw material block in the presence of an extraneous inclusion. For this purpose, we introduce a coordinate system similar to the one used in modern CNC machines (machining centers). Then the system solves the trajectory problem of meat block movement with observance of obligatory "safety zone" which excludes the risk of an extraneous inclusion getting into the further technological processing of the crushed raw material. The internal control system can not only establish the fact of presence of an extraneous inclusion but also determine its location in the coordinate system for further localization.

To localize the layer of meat with an extraneous inclusion, during the operation of the automated in-line production line of meat products using a single-stage grinding, it is necessary to monitor the time-varying coordinate in a coordinate system - the position of the raw material block, or the position of the pusher of the chopper feed mechanism. These two options are identical in the case under consideration. Such control is to prevent arbitrary movement of the block of raw materials with a detected extraneous inclusion in order to maintain a safe distance from it to the rotating working tool of the chopper. Such problems are trajectory problems in machine tool engineering, and their solutions determine the movements of the machine tool or part. This article offers an analytical solution to the trajectory problem of moving a block of meat with extraneous inclusion in the technological system "chopper - frozen meat block".

The purpose of the study is to determine the zone of safe layer-by-layer grinding of frozen meat block in case of detection of extraneous inclusion in it by the means of the input control system of raw materials. The aim of the study is to determine analytically the condition of

localization of the meat layer containing an extraneous inclusion, assuming a rectilinear motion of raw material block in the guiding planes of a single-stage chopper.

2 Materials and methods

In single-stage chopping of frozen meat blocks (second-grade beef) the industrial analyzer-recorder ASM-3192 measured and recorded the total (three phases) active power consumed by the electric motor of the cutting mechanism drive of the chopper designed by V.M. Gorbatov Federal Research Center for Food Systems of Russian Academy of Sciences in the working mode.

We determined the estimates of numerical characteristics (mathematical expectation and mean square deviation) of statistical samples of values of total active power (three phases) consumed by the electric drive of the cutting mechanism of the chopper in the operating mode got because of the experiment by the method of moments [2].

We developed the coordinate orientation in the technological system "chopper - frozen meat block" under modern material cutting theory and with the design principles of modern numerically controlled machining centers [3, 4].

When solving the trajectory problem, we accepted the assumption of the rectilinear movement of the frozen meat block in the guiding trough of the chopper.

3 Results and discussion

To illustrate the task set in the research, let us present the scheme of internal control system operation to detect extraneous inclusions in a block of frozen raw materials (Figure 2). When an extraneous inclusion is detected in a block of raw material, the computer determines the size of the block, which can be triggered without risk of the specified inclusion getting into the product of grinding. This possibility exists in connection with the sequential triggering of the frozen meat block by the milling method at the speed of the block feeding into the grinding zone, corresponding to fractions of a millimeter per tooth of the cutter. The layer of meat containing an extraneous inclusion (part of the raw material block with an extraneous inclusion - figure 2) is not subject to shredding and has the dimensions regulated by the technological documentation.

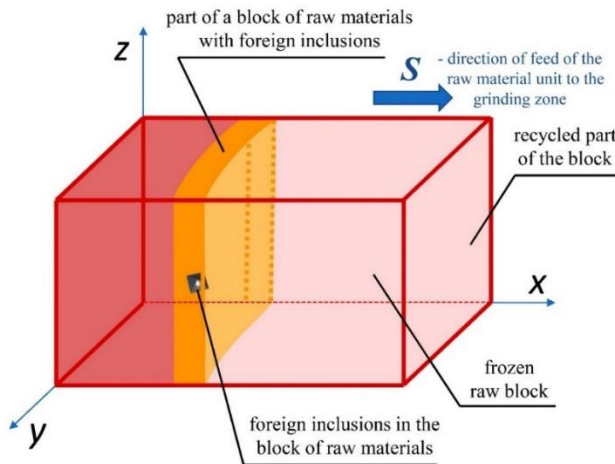

Fig. 2. Scheme of operation of the internal control system for the detection of extraneous inclusions in the frozen raw material block.

When designing the internal control system, it is advisable to orient the rectangular coordinate system relative to the stationary (without progressive motion along the coordinate axes) shaft of the chopper, located horizontally with the fixed cutting tool. This will allow the intelligent control system to set in an explicit (digital) form the coordinates of the detected extraneous inclusion in the raw material block and update them in real time when the block moves in the chopper guide chute. When the distance between the shredder's shaft rotation axis and the extraneous inclusion specified in the technological documentation is reached, the command for stopping the drive of the mechanism of feeding and rejecting the unconditioned raw material to the bottom conveyor or to the storage tank is triggered [5].

To solve the trajectory problem of moving the frozen meat block, it is necessary to determine the nature of the trajectory of this movement, as the method of solving this problem depends on it. We must consider the deviation of the block from the rectilinear movement in the guiding planes at loose fixing of the block of meat in the trough, or at heating the meat and sliding of the block on the contact surfaces of the chopper. The main reasons for deviation from the rectilinear trajectory are peculiarities of dynamics of chopping frozen meat block by the milling method.

We refer the single-stage chopping unit to a milling machine when it is completed with cutters of original design and geometry, and setting different cutting modes for chopping frozen meat blocks. Machine tool, tool, machine tool attachment and part in the machine tool building form a closed system, which is called a technological system (TS). The part is a block of frozen meat, placed in the guiding trough of the machine. TS is an elastic structure, the stiffness of which is determined by the parameters of the system elements.

In an elastic system, there are certain dependencies between the acting forces and the deformations that these forces cause. Figure 3 shows the components P_x , P_y , P_z of the cutting force acting on the meat block from the side of the cutter completing the chopper.

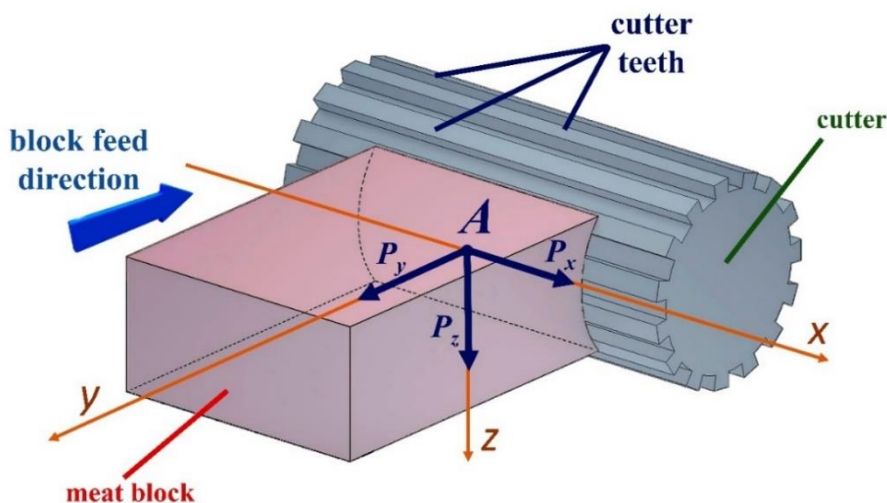

Fig. 3. Components of cutting force.

The main cutting force component P_z determines the useful work of generating new surfaces in grinding the raw material. The component P_y acts against the block feed into the grinding zone, while the longitudinal component P_x loads the bearing unit. The cutting force component P_z deforms the lower plane of the machine's guide chute, which, as a first approximation, can be thought of as a bending deformation. Force P_z causes forced oscillations in TS, the occurrence of which is caused by the principle of processing of frozen meat raw materials - milling. At the inlet and outlet of the cutter blade from the meat block

there are periodic changes of the cutting force because of the variable area of the cut layer of meat and the bending-twisting deformation of the drive system of the unit and TS. Cutting in and out can be critical modes of operation for the chopper's cutting drive system as the load on the transmission elements changes rapidly during these processes. During plunge-cutting the specified load does not increase instantaneously, but linearly. The rapid reduction in the cross-section of the layer of cut meat and the removal of the load characterise the withdrawal of the groundbreaking from the raw material. If the amplitude of the vibration velocity exceeds the average rotational speed of the chopper shaft, the gaps in the chopper cutting mechanism are opened, which leads to increased loads on the cutter teeth and tool wear. The load on the transmission elements and the drive motor has an impulse (shock) character, which can cause deviations from the rectilinear trajectory of movement of the meat block. Cutting modes, cutter diameter and number of teeth, type of cutting tool, strength characteristics of the meat raw material and other factors determine these loads.

We note, besides the forced oscillations in TS, the self-oscillations in the system, which not only external disturbing forces can cause. The auto-oscillation process can be with unevenness of cutting of raw material, periodic change of the moment of resistance to grinding caused by structural and textural heterogeneity of the raw material, etc. The source of energy required to maintain self-oscillation in TS is the drive motor of the plant's cutting mechanism.

Four types of undesirable dynamic phenomena in the TS of the shredder:

- transients when the cutter is plunging into the meat block, leading to overloads due to pulsed load application;
- transients during load removal, i.e. when the cutter tooth leaves the meat block, which may lead to non-linear oscillations of the transmission elements of the cutting mechanism drive of the installation;
- resonance processes in the drive because of the periodic load $M(t)$, where M is the moment of resistance to chopping, t - time;
- self-oscillations in the electromechanical part of the drive.

To reduce the impact of undesirable dynamic phenomena in machine tool construction, we can apply structural and technological measures when designing TS. For example, increase the bending stiffness of shafts by reducing the spans and positioning the gears of the mechanical gears closer to the supports. Increase the rigidity of gear to shaft connections. Connect fixed gears to shafts by spring expander rings, eliminating contact slackness of shaft-hub connection when the polar and equatorial moment of inertia of the shaft cross-section increases. To reduce dynamic stresses in TS, we can apply uniform milling technology, ensuring:

- an integer ratio of milling width to axial tooth pitch of the cutter;
- constancy of the total width of the layer to be cut by all cutter teeth working at the same time;
- constancy of the total cross-sectional area of all milled layers.

Structural measures can reduce dynamic loads in TS "shredder - frozen meat block". The movement of the block of raw materials in shredding is plane-parallel motion, i.e. the trajectory of the block movement is a straight line. This simplifies the solution of the above planned trajectory problem. Consider from the standpoint of reducing the dynamic loads in TS the modernization of the design of the guide chute of a single-stage shredder, developed in V.M. Gorbатов Federal Research Center for Food Systems of Russian Academy of Sciences.

Figures 4 and 5 show a general view of the chopper guide chute design before the retrofit.

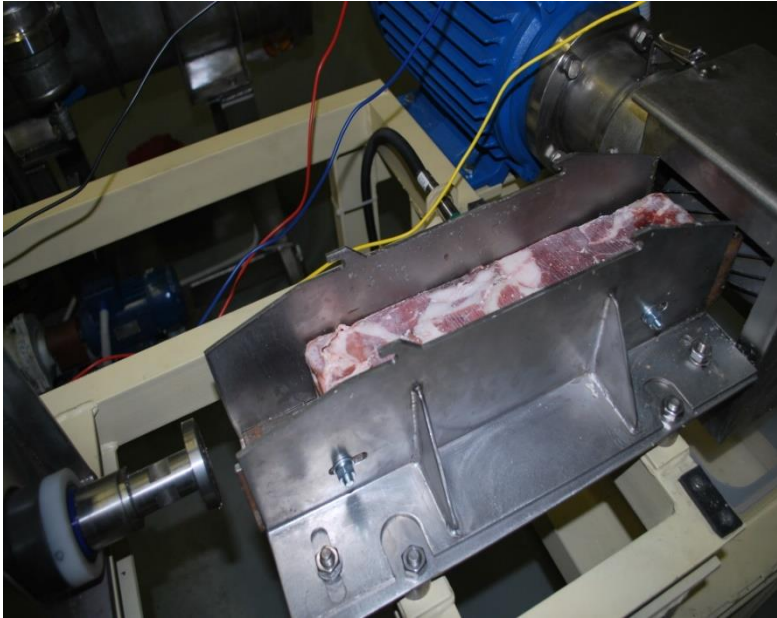

Fig. 4. General view of the chopper guide chute structure before retrofitting (top cover removed).

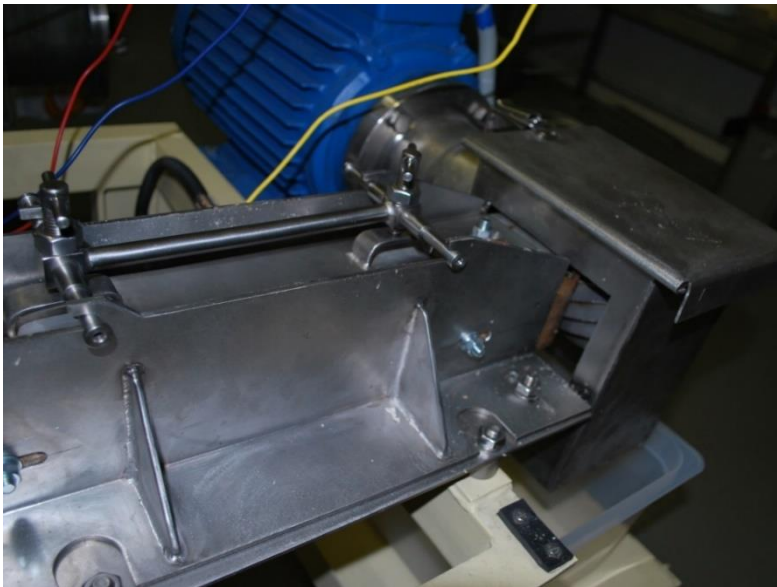

Fig. 5. General view of the chopper guide chute design before retrofitting (with top cover with two clips).

Figure 6 shows a general view of the chopper guide chute design after retrofitting.

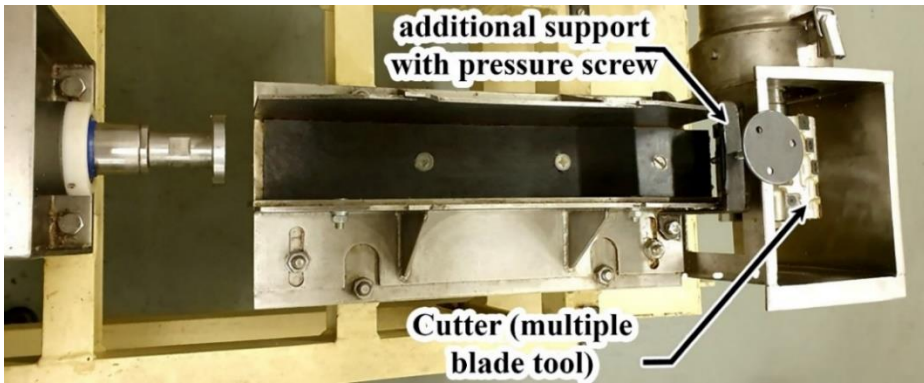

Fig. 6. View of the guide chute of the single-stage shredder after modernization (with an additional third upper hold-down in the cutting zone; top cover removed).

The chopper guide chute designs prior to retrofitting follow the loading pattern of the chute lower guide plane when the meat block is positioned on it in two cases:

- initial position, the moment the chopper is switched on (figure 7);
- end position, corresponding to the moment of chopping almost 2/3 of the experimental block of frozen meat (figure 8).

We will consider the bottom guide plane of the gutter as a double-supported beam with a protruding cantilever. The joints between the hinged supports and the girder correspond to the bolt connections between the guide plane and the bottom of the chute.

Let us make the following assumptions:

- only bending deformations of the guide plane;
- the position of the upper clamps corresponds to the position of the lower bolt connections;
- horizontal displacements of the guiding plane are zero;
- external forces that bend the beam are assumed to be concentrated;
- the vertical component of the cutting force applies to the edge of the flesh block (to the edge of the guide plane) without considering the formation of the cutting surface that mates with the cylindrical side surface of the cutter.

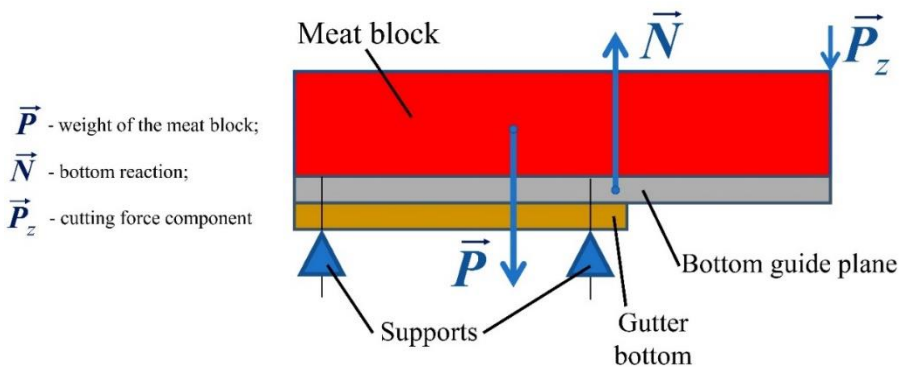

Fig. 7. Scheme No. 1 of loading the bottom guide plane of the chute.

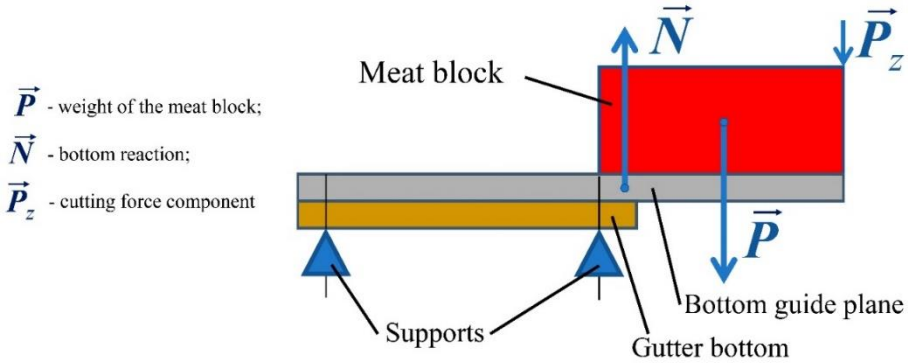

Fig. 8. Scheme No. 2 of loading the bottom guide plane of the chute.

Let us determine the bending of the cantilevered part of the beam at the extreme position of the meat block on it. When performing chopping on the experimental unit (chopper) in this position of the butcher block we note the maximum dynamic loads in TS, having a character of impact. Let's simplify the calculation task. Since it is important to determine the deformations in the system directly in the chopping zone that affect the quality of the chopped material, let's assume that the part of the beam located to the left of the clamp is stationary, pinched (Figure 9). The vertical component of cutting force P_z without considering the weight of the meat block bends the beam. Reaction of the bottom N of the chute of the installation, acting on the guiding plane, we consider as the concentrated force, applied in the middle of the contact area from the end of the chute bottom to the extreme right bolt connection of the chute bottom. This force also bends the beam.

As the vertical component of the cutting force is impulsive in milling, the rapid changes in time characterize the deformation of the girder at the end point of the console. The impulse load acts on the milling cutter and therefore on the motor shaft of the cutting mechanism drive of the machine. We can decompose the time-variable function into a Fourier series:

$$M(t) = M_0 + \sum_{k=1}^{+\infty} M_k \cos(k\omega + \varphi_k) \quad (1)$$

where M – electromagnetic motor torque;
 t – time;
 k – the number of the harmonic;
 $k\omega$ – circular frequency of the k -th harmonic;
 φ_k – initial phase of the k -th harmonic;
 M_k – amplitude of the k -th harmonic.

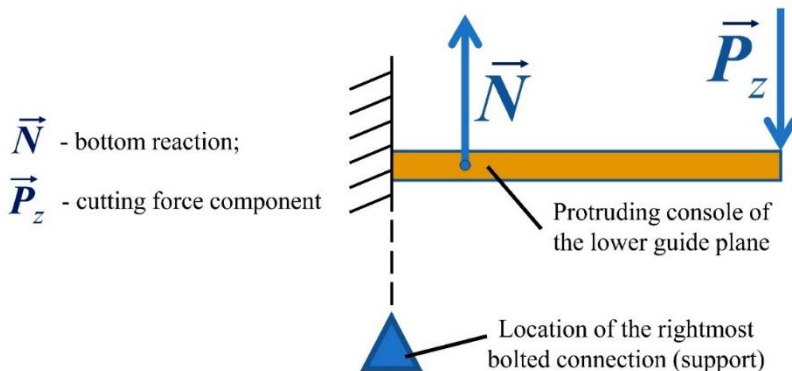

Fig. 9. Scheme No. 3 of loading the bottom guide plane of the chute.

From the basic equation of motion of the drive

$$M = M_s + J_{\Sigma} \frac{d\omega}{dt} \quad (2)$$

where M - the electromagnetic torque of the drive motor;
 M_s - static moment of resistance;
 J_{Σ} - total moment of inertia applied to the motor shaft;
 ω - speed of rotation;
 t - time,

it follows that at each moment the drive motor, being in the linear part of its mechanical characteristic (without exceeding its overload capacity) develops an electromagnetic moment which balances the static and dynamic load on its shaft. Considering the pulse nature of the load, part of the harmonic components of the load torque (second and higher harmonics) cause the components of the drive motor's electromagnetic torque. Since the useful work in the formation of new surfaces in the grinding of raw materials is made by the main (first) harmonic component of the electromagnetic moment [6], the higher harmonics cause higher electricity consumption for non-productive costs, including the oscillations in TS, reducing the efficiency of the whole installation.

In order to reduce the dynamic loads in the TS, we changed the design of the guide chute of the single-stage chopper, as shown in Figure 6. An additional (third) support with a clamping screw was installed in the cutting zone.

We accept the idealization that the additional upper clamp and bolt connection are located precisely at the end of the chute bottom. Assume that the bottom guide plane is stationary to the left of the specified bolted connection. Figure 10 shows the beam loading diagram in this case.

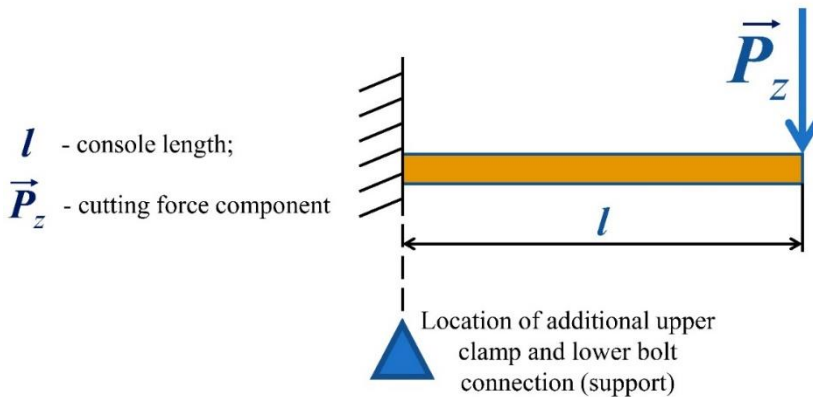

Fig. 10. Scheme No.4 of loading the bottom guide plane of the chute.

The diagram does not contain a moment (reaction) in the termination. It is known from mechanics of materials that the deflection of a beam at the point of application of bending force P_z is determined as:

$$\Delta = \frac{P_z * l^3}{3EI} \quad (3)$$

where P_z – the cutting force component;
 l - the cantilever length;
 EI - bending stiffness of the beam;
 Δ - deflection of the beam at the point where P_z force is applied.

The deformation (deflection) of the girder depends on its length to the embedment point. The installation of additional support (upper clamp and lower bolt connection) reduces the length of the cantilever, reducing the deformation of the lower guide plane. Reduced deformation in the elastic TS and deviations from the rectilinear path of movement of the meat block during its shredding, reduces the impulse load on the drive motor of the shredder cutting mechanism. This makes milling block frozen meat smooth and less energy-consuming.

The analysis confirms the experimental data. Figure 11 shows a histogram of the numerical distribution of the measured values of the total (three phases) active power consumed by the cutting mechanism electric motor in the operating mode before upgrading the chopper guide chute design, and Figure 12 shows a similar histogram after upgrading. Data row 1 corresponds to the average power values in the set measuring ranges, kW, and data row 2 to the number of power measurements falling within the set measuring ranges.

Considering the experimental data as a statistical sample, we can calculate the numerical characteristics of the experimental distribution by the method of moments [2]: N_{cp}^* - estimate of the average value of the total (three phases) active power consumed by the cutting mechanism electric drive of the shredder, included in the statistical sample, σ^* - estimate of the mean square deviation from the sample mean.

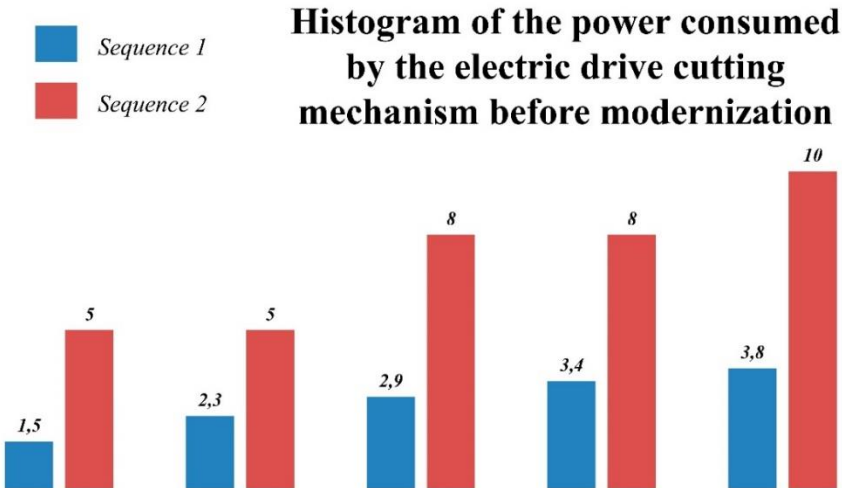

Fig. 11. Numerical distribution histogram of the measured values of total (three phases) active power, kW, consumed by the cutting mechanism drive in operating mode before the retrofit.

The estimates of the numerical characteristics of the experimental distributions are: $N_{cp}^* = 3.07$ kW; $\sigma^* = 0.789$ kW, for the power histogram in Figure 11; $N_{cp}^* = 2.44$ kW; $\sigma^* = 0.230$ kW, for the power histogram in Figure 12. The comparison of the calculated data seems to be correct, as these data are got for equipping the shredder with the same cutter in the same raw material cutting mode. Other shredding conditions are identical, including raw material temperature.

Comparison of the estimates of the numerical characteristics of the experimental power distributions allows us to conclude that placing an additional support in the cutting zone reduces the energy requirements for grinding raw materials (by over 20%), and reduces the average square deviation (by 3 times), which has a positive effect on the quality of the minced meat because of a reduction of dynamic loads in the TS.

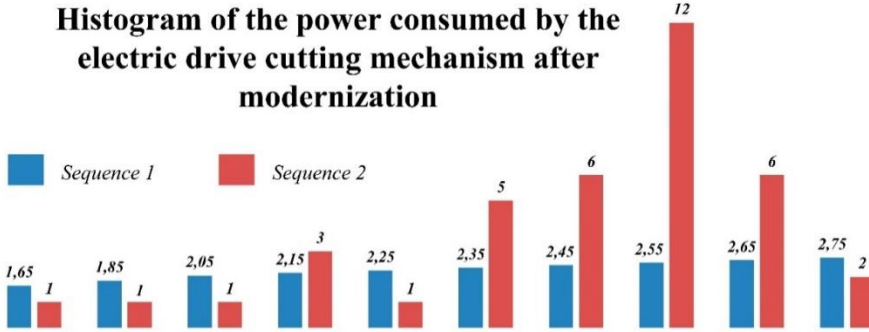

Fig. 12. Numerical distribution histogram of measured values of total (three phases) active power, kW, consumed by cutting mechanism electric drive in operating mode after modernization.

We can conclude that the adopted design measures have made it possible to reduce dynamic loads in TS during the grinding of raw materials, affecting the deviation of the trajectory of frozen meat block movement from a straight line. This makes it possible to allow strictly straight block movement along the guiding planes, without lateral and vertical displacements. Figure 13 shows a diagram of such movement. Such an assumption seems justified, as a structural solution for rigid fixing of the frozen raw material block in the guide chute of the chopper is a prerequisite for obtaining homogeneous chopped raw material in terms of the characteristic size.

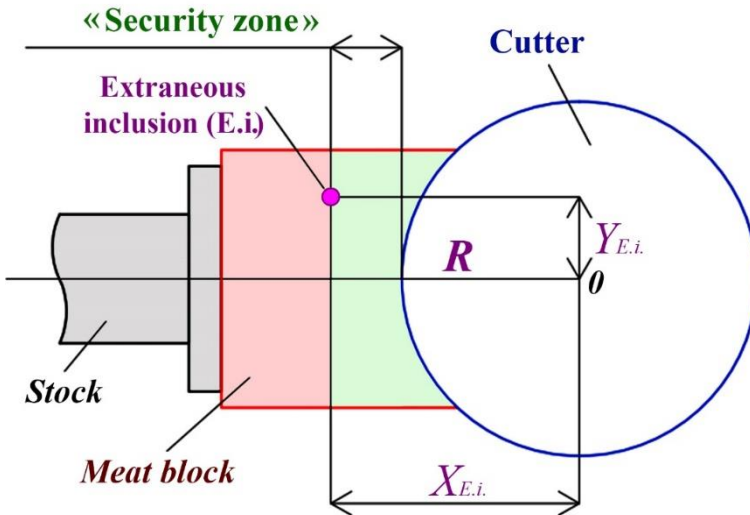

Fig. 13. Flow scheme of the raw material block.

The internal monitoring system determines the coordinates of the extraneous inclusion ($x_{e.i.}, y_{e.i.}$) in an XOY coordinate system, fixed in relation to the shredder shaft on which the multi-blade tool is fixed. While shredding a block of raw material to the location of the extraneous inclusion, we must observe the "safety zone" (figure 13) defined in the technological documentation. The following formula can determine the size of this zone:

$$x_{s.z.} = x_{e.i.} - R \tag{4}$$

where $x_{s.z.}$ - the width of the safety zone along the x-axis;
 $x_{e.i.}$ - the coordinate of the extraneous inclusion as determined by the internal control system;

R - the outside radius of the cutter (multi-blade tool) determined by the chopper's working tool specifications.

In order to comply with the "safety zone", the conditions for controlling the position of the moving parts of the "shredder - raw material block" system must be defined. Here, the raw material block can be regarded as an inertial mass. When issuing a command to stop the shredding process in order to locate the unconditioned part of the frozen raw material block, the possibility of inadmissible movement of the inertial mass of the specified electromechanical system must be excluded. Such movement can lead to an arbitrary reduction of the set safety zone limits.

When precise positioning of the actuator is implemented, its first step is because of the intrinsic response time of the switching device t_a in the actuator control circuitry. Because of this lag, the electric motor is not disconnected from the mains and the actuator continues to move at the speed ω_{int} at which it was approached at the time the stop command was issued. Distance (counting from the rotor angle of the electric motor):

$$\varphi' = \omega_{int} * t_a \tag{5}$$

φ' - distance.

After the time t_a has elapsed, the shredder feeder motor is disconnected from the mains and a mechanical brake (brake shoes) can be applied. The second stage of the stopping process begins. The kinetic energy stored in all the moving masses of the system is spent in overcoming the static drag forces on the path φ'' :

$$J_{\Sigma} \frac{\omega_{int}^2}{2} = (M_S + M_T) \varphi'' \tag{6}$$

where J_{Σ} - total moment of inertia;

M_S, M_T - static drag torque and braking torque applied to the shaft of the shredder feed motor;

φ'' - distance.

Limits of movement of the raw material block in the guide box of the single-stage shredder in the angular dimension:

$$\varphi = \varphi_{avg} \pm \Delta\varphi_{max} \tag{7}$$

where φ_{avg} - average distance at a precise stop;

$\Delta\varphi_{max}$ - maximum positioning error or maximum stopping inaccuracy.

It is not practical to apply the precise positioning of the chopper feeder push rod. The feeder drive operates on a "stop" at the moment of stopping - the raw material block is in tight contact on the cutting surface with the shredder tool (figure 14)..



Fig. 14. The contact area between the raw material to be processed and the shredder's working tool (the meat block is moved away from the cutter for clarity).

The condition for guaranteeing compliance with the «safety zone»:

$$\varphi_{s.z.} \gg \varphi \quad (8)$$

where $\varphi_{s.z.}$ - the width of the "safety zone" in the angular displacement of the shaft of the electric motor driving the shredder feeder;

φ - limits of movement of the block of raw materials in the guide chute of the single-stage shredder in the angular dimension.

The condition (8) solves the trajectory problem of moving the block of frozen raw materials during its one-stage chopping in compliance with the obligatory localization of extraneous inclusion detected by the internal control system.

We note that traditional incoming inspection systems for block frozen raw materials in the meat processing industry involve rejecting the entire block if extraneous inclusion is detected in it. Part of the block in this case can be crushed, and the raw material (figure 2) is removed automatically from the feeding conveyor of the automated line. The layer of meat containing extraneous inclusions is removed, for example, with a hand-held cutting tool (saw), counting the thickness of the layer from the characteristic concave cutting surface (figure 14) left by the shredder's cutting shaft on the raw material block, under the specified size of this thickness specified in the technological documentation.

4 Conclusion

The intelligent incoming raw material inspection system in automated in-line production lines for meat products will intensify the technological process of finished product production. The full automation of control functions under the control of an industrial computer does not provide for the use of unproductive manual labour and excludes the possibility of finding extraneous inclusions in raw materials arriving for processing. Application of such a control system reduces risks of use of substandard raw materials within its competence. A distinctive feature of the proposed internal control system is the possibility of processing a block of raw materials containing extraneous inclusions to the location of an identified inclusion. Such control system functioning allows to save raw materials, evenly load the technological equipment completing the automated line and also simplifies the procedure of rejection of substandard part of the raw material block. We need to guarantee

that a "safety zone" is in place to forbid a quantity of raw material with an unrelated inclusion from continuing to undergo technological processing. Installing an additional support in the shredding area results in reduced energy consumption for the frozen meat cutting process because of rigid attachment of the block of raw materials along the entire length of the chopper guide chute. Such fastening makes it possible to consider the movement of the block of raw materials in the guiding planes of the chopper as plane-parallel, without lateral and vertical displacements. This simplifies the solution to the coordinate problem of finding an extraneous inclusion in a block of raw materials in the dynamics of its single-stage chopping with the mandatory observance of the safety zone. The solution of the coordinate problem should be used in the control's development computer software of the internal control system that complements the automated production lines for in-line production of meat products.

References

1. R. Gonzalez, R. Woods, Digital Image Processing (Technosfera, 2005)
2. E.S. Wentzel, L.A. Ovcharov, Theory of Probability and Its Engineering Applications (Nauka, Moscow, 1988)
3. P.I. Yascheritsyn, E.E. Feldstein, M.A. Kornievich, Theory of cutting (New knowledge, Minsk, 2006)
4. Ya.L. Lieberman, L.N. Gorbunova, Journal "Machines and Tools" **8**, 2-5 (2021)
5. Foss Analytics, <http://www.foss.ru/industry-solution/products/meatmaster>
6. M.P. Belov, V.A. Novikov, L.N. Rassudov, Automated electric drive of typical production mechanisms and technological complexes (Publishing Center "Academy", Moscow, 2004)
7. Y. Altintas, *Manufacturing Automation* (Cambridge University Press, Cambridge, UK, 2000)
8. A. Ast, S. Braun, P. Eberhard, U. Heisel, Annals of the CIRP **56(1)**, 379-382 (2007)
9. C. Pislaru, D. G. Ford, G. Holroyd, J. of Systems and Control Engineering **I (218(2))**, 111-120 (2004)