

UTILIZING WASTE HEAT FROM THE REFRIGERATION CYCLE BY USING A TWO-STAGE HEAT EXCHANGER

*Safaa M. Ali

Maathe A. Theeb

Mechanical Engineering Department, College of Engineering, Mustansiriyah University, Baghdad, Iraq

Submitted 16/10/2021

Accepted in revised form 11/12/2021

Published 1/5/2022

Abstract: Refrigeration, and air conditioning systems are designed to transport heat from internal spaces or products and discard it into the surrounding. Refutation of heat might happen in a straight line to the air, as in the case of most conventional units of air-source, or to water flowing from a cooling tower. This heat is of a "low-grade diversity", it still signifies wasted energy. According to the viewpoint of energy conservation, it would be necessary to regain this heat in a serviceable form. In this research, a practical study aims to collect the heat emitted from the cooling condenser by 35% and exploit it in heating hot water for domestic purposes, in addition to other uses, including reducing the consumption of electrical energy as a result of exploiting and collecting waste heat, from cooling devices using a system consisting of two types of helical heat exchangers and two stages. The first stage consists of a tube-in-tube helical exchanger and the second stage includes a tube-in-shell heat exchanger using R410A refrigerant. The EES engineering equation solving program was used to solve the numerical equations that are used to solve problems related to thermodynamics, due to its high accuracy in solving equations, extracting values and graphs, and calculating the performance coefficient of the COP to obtain better efficiency for the work of the system, as it was found that the higher the temperature. As a result of increasing the flow rate of deionized water, the percentage of performance coefficient of COP has increased to 15%, which should range from (12.5-40) %, which leads to an increase in the efficiency of the system.

Keywords: *COP, cost-benefit analysis, waste heat recovery, tube-in-tube helical heat exchanger.*

1. Introduction

The annual consumption of electrical energy is increasing day by day due to the increasing demand for air conditioners. Therefore, it requires developing an efficient system for these devices using energy-saving systems by increasing the performance of this system. The purpose of these devices is to develop a multi-use cooling device that combines air conditioning and hot water generation by collecting the excess heat from the cooling device at one time. The harvest temperature may be beneficial in a complementary method as it can be used to recover heat from the condenser for heating purposes as it uses the technique of cooling air and water to condense the heat, this system delivers not only cooling nonetheless hot water too. It is a system used to recover the harvested heat in the air conditioning system, and it is mainly used to recover the waste heat from the condenser, where the heat harvesting device can be used directly or indirectly, but in this research

*Corresponding Author: safaaaltomah@gmail.com

the heat is recovered indirectly. When the ideal cooling cycle linked with the waste heat recovery unit, it has two roles, there are increasing the performance factor (C.O.P) and achieving lower costs as the rejected heat to the surrounding environment is recovered and used for heating. The heat recovery device is designed to be a superheated device, so that in the design stage the heat stored in the vapor of the coolant preheated in the pressure stage is not heated above the evaporative temperature under typical conditions. They are used in the industry on a large scale for heating and cooling purposes for many industrial processes, where there is a thermal current that is exhausted or wasted in energy, so heat exchangers are utilized to recovering the excess heat and use it in various processes. This process saves a lot of money in the industrial field, whereas if other resources were used, it would be costlier and harmful to the environment.

Bahaulddin K. Roomi [1] presented a theoretical and experimental study aimed at collecting the waste heat from the air conditioner and preserving the energy generated from the air conditioning system by calculating the condensation rate after the compressor stage of a type refrigerant (R410A). The design of the heat exchanger tube-shell type has been used to recover the waste heat from the split type air conditioner (1TR) and linking it in the outside unit amid the condenser and the compressor to heat the water and increasing the performance factor (COP) of the cooling cycle used. Two kinds of coil (conventional and fins) were used in the heat exchanger in an attempt to persuade the waste heat absorption in the tap water and found a rise in the performance factor ranging from (12.50% to 40.0%) and that the outside water temperature reaches a variance of (12)°C, as well as in the analysis of the cost and return in the payback period (PP) and the net present value.

This system was hoped save electricity consumption units for hot water production in the recovery period of about (17.5 and 11.7) months for the helical coil and conventional heat exchanger respectively.

Satish Maurya [2] presented an analytical study on the use of the vapor pressure cooling system as this system captures most of the cooling field, whether industrially or locally, and found that the amount of heat rejected by this system is very high and is removed to the atmosphere as waste. The using of this waste heat to run another cooling system that needed a low temperature such as a simple ejector cooling system, where he suggested a combined cycle to take advantage of this waste heat and improve the joint efficiency of a vapor compression cooling plant and concluded that the performance factor can be increased to 50% by combining the ejector and VCC. Also, additional cooling can be obtained by using the rejected temperature, which is at a low temperature, by a cooling plant operating at 7TR steam pressure and utilizing Freon F-12 as working material in the VCC plant. It was found that the main benefit of the collective plant's work is to reduce the fiscal and economic sides, the earnings in terms of savings are considerably superior. One of the costs of assessment as it doesn't require the need to operate the cooling system using the ejector.

Prabhanjan, Ragbavan and Kennic [3] conducting a study whose purpose was to make a comparison between the use of the helically coiled heat exchanger and another with a straight tube of similar dimensions for heating water, as well as making a comparison between this study and other similar studies in terms of continuous heat flow and constant wall temperature. The results showed that the heat transfer coefficient increases with the helically coiled heat exchanger matched to the straight exchanger and that the

rise in the volumetric flow rate doesn't affect the walls of the heat exchanger.

Jadhav and Lele [4] theoretically discussed the application of waste heat recovery using the heat pipe heat exchanger, where it was concluded that the heat exchanger system of heat pipes in the air conditioning system to recover the waste heat achieves significant savings in electrical energy, and this system was applied in different climatic zones. It is recommended to use the heat pipe heat exchanger to save energy from the air conditioning system, as the difference in the input characteristics such as the outside air retrieval, the temperature and the quantity in addition to the compressor energy consumption and the number of operating hours of the system. Where the temperature of the recovered air was imposed at 23 degrees Celsius and the amount of the outside air is $1\text{m}^3/\text{sec}$ and compressor power 1 kW/ton and 6 rows for the heat pipe heat exchanger and the annual energy saving was revealed due to the use of many rows of the heat exchanger. It also required making an additional payment for the used fluid by calculating the pressure drop, the recovery time for heat and the energy consumption of the fan.

Parmar and Jain [5] worked on recovering the waste heat from the condenser of the refrigeration system by using a heat exchange between the compressor and the condenser. It was found that there is an improvement in the thermal performance factor (COP) of about 68.83% and the highest temperature cannot be observed without comparing the water condition with the forced circulation of water, whose temperature reaches $(54.5)^\circ\text{C}$. Through the water room, this work is of great value for the local design of the joint research work model with the optimum utilization of the waste heat.

Kaushik [6] presented a study on heat recovery using a Canopus heat exchanger amid the

pressure and the condenser, which restores the waste heat of the evacuated steam from the condenser vapor compression cooling system and makes use it by increasing the temperature of the outside water, which increases the heat from the cooling condenser. He studied the effect of mass flow rate on the recovery of heat and the distribution of it on the condenser, and the effect of operating temperatures in the condenser and evaporator for the incoming water temperature, and the effects of the ideal operation to restore the possible waste heat. The heat recovery factor and the temperature of the outside water were obtained. Parameter of heat recovery of the order 2.00 and 40.0% of the heat of the condenser over a Canopus heat exchanger for representative.

Abu-Mulaweh [7] developed and designed a system for recovering heat from a window air conditioner using a heat pump, as he designed two types of heat exchangers, one of which was helical and the other was of the concentrated type, and then modified in the air conditioning scheme. Also, studied the presentation of this scheme, as the results showed that the concentrated heat exchanger gives hot water at 45 degrees Celsius. This is when using the theoretical siphon to circulate the water through the heat exchanger, eliminating the need for the pump completely. To achieve this, the heat exchangers were linked to a water storage tank, once the water is heated by the extremely hot coolant in the heat exchanger, the hot water flows upwards done a connecting tube to at the topmost of the water tank, and at the similar time the cold water flows from the bottommost of the tank inside the heat exchanger conditions and running a model using R-500, R-717, R-12, R-22.

2.Theoretical Analysis

Theoretical analysis serves are assessing the performance of the heat exchangers and their work, such as the model thermal performance of

the heat exchangers used, whether the helical tube (tube in tube) and (shell in tube) used to recover the waste heat from the refrigeration condenser of air conditioners. The performance factor for the cooling cycle is calculated through the equation

$$COP_{conv} = \frac{q_{sc}}{W} \quad (1)$$

To obtain hot water as a result of collecting the rejected heat from the cooling system, use heat exchangers and increase the necessary temperature from the refrigeration cycle and the performance parameter of the refrigeration cycle with the additional heat recovery unit [8]

$$COP_{HE} = \frac{(q_{sc} + q_{HE})}{W} \quad (2)$$

3-Design Process

When designing a system for recovering waste heat from an air conditioner, we must take into account many of the basic conditions for the design as:

- 1- Working hours of the cooling device during the day
- 2- Cooling capacity
- 3- The type of frequency of the current
- 4- The temperature of the water entering the tubes during the daytime operation of the air conditioner
- 5- The amount of hot water required for daily consumption
- 6- Design advantage

The type of metal used is rust-resistant and has a thick, seamless tube that has a high heat stress resistance. On the other hand, applications requiring welding are typical applications that do not need maintenance, such as high pressure, high temperature, low flow of multi-phase liquids and vapor condensation. This type of exchanger is designed to achieve the similar quantity of hot water via using (120 liters of water per day at a temperature of 45°C) when the

cooling system works for two hours during the months of April and October, as shown in the fig.1.



Fig. (1 a). Shell and tube

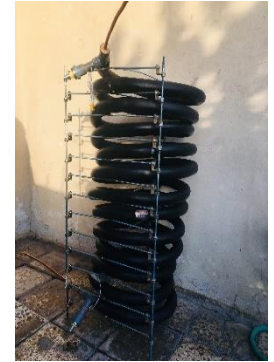

Fig. (1 b). Tube in tube

4. The physical model of The Thermal Recovery System

The system consists of two stages that include two types of heat exchangers. The first is a tube in a tube, the inner tube is of copper material with a diameter of (9.53 mm), a thickness of (0.61) and a length of (14200 mm). The number of tube turns is 12 coils, the diameter of one roll is (390 mm) through which the refrigerant passes (R 410 a), while the outer tube of the heat exchanger is of a diameter (18.72 mm) any type of rubber tube can be used through which deionized water passes. The outer tube of the first heat exchanger, through which the deionized water passes, is connected with the inner tube of the second heat exchanger to transfer heat to the normal water (tap water) located in the second exchanger, which is collected in a special tank to collect the hot water obtained through the system. The second heat exchanger, which is composed of a spiral tube and a casing made of (UPVC) material, which has a length of (64 cm) and a diameter of (22 cm), as well as the inner tube of copper material, which has a diameter of (9.53 mm) and a length of (8 meters) and the number of its turns is (17 turns). Both exchangers are insulated with an insulating material to maintain the pipes as well as to maintain the water

temperature. The refrigerant R410A was used as a liquid gas to transfer heat during the turbulent discharge process and change the state to a mixture of (vapor-liquid) after it was in a state of vapor. As well as the use of non-ionic liquid water heat transfer with laminar flow during the heating process as shown in the fig.2

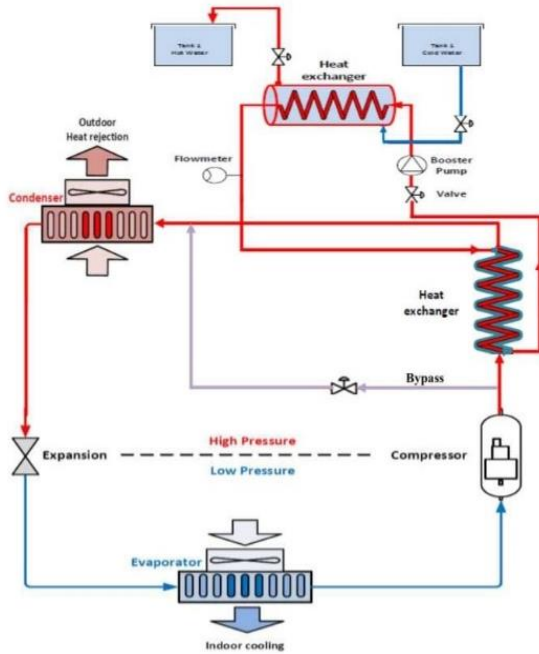

Figure 2. Refrigeration cycle two stages with heat recovery unit

5. Boundary Conditions

5.1. Inlet Deionized Water

Ion-free water enters into the first heat exchanger, type tube in a tube through a valve with a diameter of 15 mm at a temperature (30°C) and the velocity to the water mass flow rate is shown according to the following table:

1 LPM	0.09 m/s
1.5 LPM	0.14 m/s
2 LPM	0.18 m/s
2.5 LPM	0.235 m/s
3 LPM	0.27

Ion-free water passes through the outer tube of this exchanger, which has been preheated through the R410A refrigerant, which passes into

the inner tube of the exchanger, and upon heating the deionized water, the water moves to the second exchanger, which is of the tube and shell type, through which the tap water is heated to (45°C) . It is located in the second exchanger which is assembled in a tank for using.as shown in the Fig .(4)

5.2. Inlet Refrigerant Gas

The used refrigerant R410A, which passes through the inner copper helical tube of the first exchanger, has a flow rate of 0.04 kg / sec and the average temperature of the refrigerant entering the spiral tube (69) °C through which the heat is transferred to the deionized water for the duration of the flow procedure. The coolant is removed from the first heat exchanger after the heat is transferred to the deionized water at a temperature of 30, to be transferred to the condenser again in the refrigeration cycle.

5.3. Walls

The outer walls of both exchangers were insulated with an insulating jacket to prevent heat transfer from the pipes during the water heating process as well as not to be affected by the external conditions.

6. Experimental Work

To achieve the experimental study, the assembly system device was designed and constructed as shown in the fig.3.

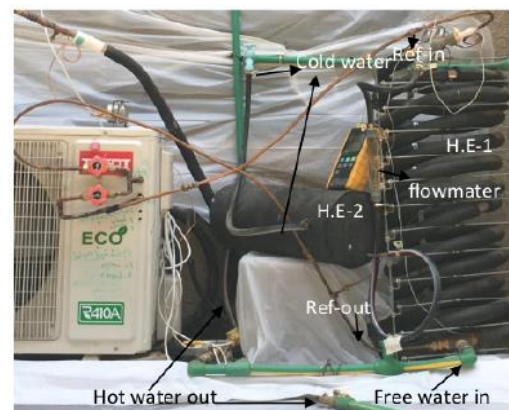

Figure 3. Photograph of test

The system includes two types of spiral heat exchangers that operate in two stages to collect the excess heat energy of 2-ton refrigeration device and a type of R410a that work as part of the refrigeration system as they were positioned amid the compressor and condenser in the external unit of the refrigeration device. In order to calculate the surface area of the heat exchanger and the coil, the temperature must be imposed to estimate the extent of the difference in temperature to obtain the outside temperature using the ΔT_{LM} law, taking into account that the outside temperature of the cold liquid may exceed the temperature of the liquid escaping from the counter-flow heat exchanger. [9]

$$\Delta T_1 = T_{ref. in} - T_{w.out} \quad (3)$$

$$\Delta T_2 = T_{ref. out} - T_{w.in} \quad (4)$$

$$\Delta T_{LM} = \frac{\Delta T_1 - \Delta T_2}{\ln \frac{\Delta T_1}{\Delta T_2}} \quad (5)$$

The length of the helical coil tube

$$l = \frac{Ahc\pi}{do} \quad (6)$$

The number of the turns according to the shell diameter was used as coil diameter 150 mm

$$n = \frac{l}{\pi Dc} \quad (7)$$

The rate of heat transfer in the heat exchanger is calculated [10], [11]

$$q = U Ahc \Delta T_{LM} \quad (8)$$

To conserve energy, the heat absorbed via the water is relied upon, which is equal to the heat that the coolant rejects

$$\dot{m}_w C_p \Delta T_w = U Ahc \Delta T_{LM} \quad (9)$$

$$Ahc = \frac{\dot{m}_w C_p \Delta T_w}{U \Delta T_{LM}} \quad (10)$$

The heat transferred is calculated by the steady flow rate and outlet, inlet temperatures of the circulated water in the shell side [12]

$$Q_w = \dot{m}_w C_p (T_{w.out} - T_{w.in}). \quad (11)$$

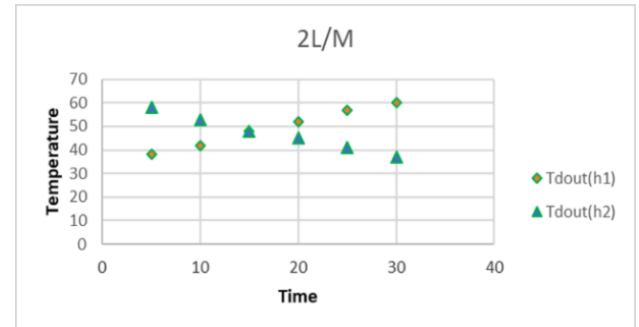

Figure 4. Distribution of outlet temperatures in the first and the second heat exchanger with respect to deionized water

7. Results and Discussions

Two types of spiral heat exchangers were designed, which were connected in two stages amid the compressor and the condenser of the external unit of the refrigeration system. To the second stage, where it passes through the inner tube of the second exchanger, which is of a shell-and-tube type, for the purpose of transferring heat from the refrigerant through deionized water to the second exchanger to heat the normal tap water (30°C) that passes between the inner tube and the outer shell of the second exchanger as shown in the fig.(5). The amount of water entering is controlled by a valve before the heat exchanger. Also, the deionized water passes in this cycle through a water flow meter to calculate the amount of water entering into the first exchanger, which through this quantity is controlled by the COP performance factor. As the water amount increases, the performance coefficient rises and the temperature of the hot water used for domestic purposes in addition to other uses increases. 11 thermocouples of type K were used, distributed to all parts of the system and the refrigeration cycle, to measure the

temperatures, whether for the heat exchangers, condenser and compressor. The EES engineering equation solving program was also used to solve the numerical equations to obtain the required results and charts, including the (P-H) diagram as shown in fig. (7) and (COP) charts as shown in fig. (5) and the comparison charts between the results practical

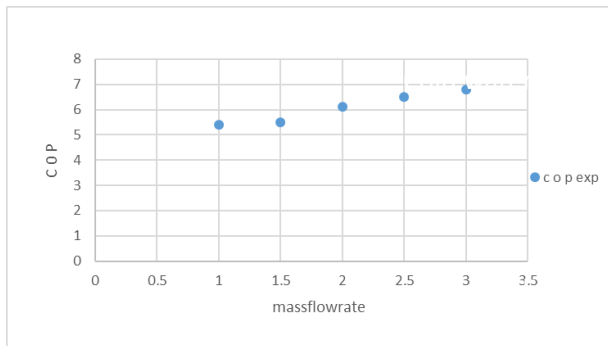

Figure 5. Coefficients of Performance

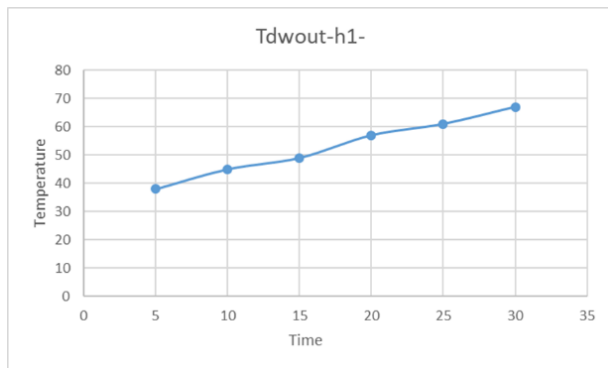

Figure 6. Water Outlet Temperature

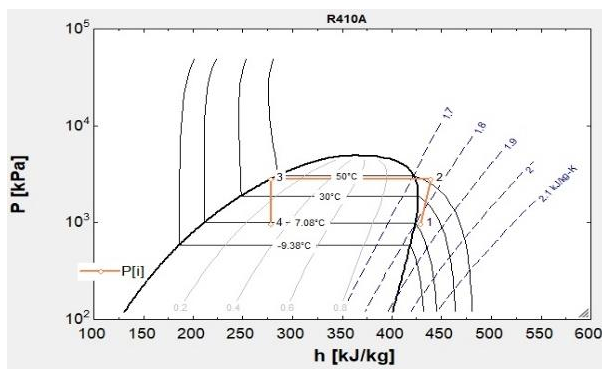

Figure 7. R410A Pressure-Enthalpy diagram

8. Conclusion

This research was a theoretical and practical study for the use of two types of coil heat exchangers to recover excess heat from the cooling condenser for a separate type of air conditioner, and the following results were achieved:

- Using a tube-in-a-tube heat exchanger in the first stage for the purpose of withdrawing the coolant’s heat in a larger proportion, due to the increase in the surface area of the inner tube through which the coolant passes and converting it to deionized water, which in turn transfers it to the second exchanger to heat the normal tap water.
- Deionized water is water that has been treated from all impurities and mineral substances, but at the same time it is considered a substance that slowly corrodes copper tubes unless the pH is controlled and an anti-corrosion is added.
- Increasing the Coefficients of Performance (COP) to (15% and 24%) as a result of the increase in the flow rate of the mass of deionized water, which led to an increase in the temperatures of the outside hot water.
- The use of the excess heat collection system leads to a reduction in the consumption of electrical energy during a period of four months (April, May, September and October).

NOMENCLATURE

- H coefficient of heat transfer ($W/m^2 \cdot K$)
- W power consumption (W)
- D tube diameter (mm)
- A area (m^2)
- \dot{m} mass flow rate (kg/s)
- U overall heat transfer coefficient ($W/m^2 \cdot K$)
- T temperature ($^{\circ}C$)
- CP specific heat at constant pressure (kJ/kg. K)

Abbreviations

F	refrigerant R410A
hc	helical coil
C	cross-section
HE	heat exchanger
sc	space cooling
in	Inlet
out	Outlet
W	water
Tdwout	deionized water out
Tdwin	deionized water in

Acknowledgements

The authors wish to thank Mustansiriyah University (www.uomustansiriyah.edu.iq) and in particular College of Engineering for the use of facilities in their labs.

Conflict of interest

The author confirms that there is no conflict of interest in publication of this article.

9. References

1. Roomi, B.K., Theeb, M.A. (2020) "Experimental and theoretical study of waste heat recovery from a refrigeration system using a finned helical coil heat exchanger" *Heat Transfer*, 49(6), pp. 3560–3574.
2. Satish K. M., Awasthi S. "Waste Heat Recovery: An Analytical Study of Combined Ejector and Vapour Compression Refrigeration System". Department of mechanical engineering, D.S.Inst. of Tech. And Mgmt, Ghaziabad, India Department of mechanical engineering, IIMT College of Engineering, Greater Noida, India.
3. D. G. Prabhanjan, G. S. V. Raghavan, and T. J. Rennie, (2002) "Comparison of heat transfer rates between a straight tube heat exchanger and a helically coiled heat exchanger," *International Communications in Heat and Mass Transfer*, vol. 29, no. 2, pp. 185–191.
4. Jadhav and Lele M. M. (2015). "Theoretical energy saving analysis of air conditioning system using heat pipe heat exchanger for Indian climatic zones," *Eng. Sci. Technol. An Int. J.*, Vol. 18, No. 4, pp. 669–673.
5. Parmar and Jain R. K. (2017). "Waste Heat Recovery System by Using Water Chamber in Between Compressor and Condenser," *Int. J. Res. Appl. Sci. Eng. Technol.*, vol. V, No. IX, pp. 447–457.
6. S. C. Kaushik and M. Singh, (1995) "Feasibility and design studies for heat recovery from a refrigeration system with a canopus heat exchanger," *Heat Recovery Systems and CHP*, vol. 15, no. 7, pp. 665–673.
7. Abu-Mulaweh H. I. (2006). "Design and performance of a thermosiphon heat recovery system," *Appl. Therm. Eng.*, Vol. 26, No. 5–6, pp. 471–477.
8. W. Roetzel, X. Luo, and D. Chen, (2020) "Optimal design of heat exchangers," *Design and Operation of Heat Exchangers and their Networks*, Elsevier, pp. 191–229.
9. S. Becker, (2014) "Foundations of Heat Transfer. Von F. P. Incropera, D. P. Dewitt, T. L. Bergman, A. S. Lavine," *Chemie Ingenieur Technik*, vol. 86, no. 3, Wiley, pp. 395–396.
10. Klein S.A. and Nellis G.F. (2012), *Mastering EES, F-Chart Software*, Box 44042 Madison, WI 53744.
11. Ji J., Chow T. T., Pei G., Dong J., and He W. (2003). "Domestic air-conditioner and integrated water heater for subtropical climate," *Appl. Therm. Eng.*, Vol. 23, No. 5, pp. 581–592, 2003.

12. Bahaulddin K. Rommi, Maathe A. Theeb (2021). “Experimental and numerical study of inserting an internal hollow core to finned helical coil tube-shell heat exchanger”, *Journal of Engineering and Sustainable Development*, Vol.25, No.1, pp.1-14.