

## Article

# Tailings Filtration: Water Jet Spray Cleaning of a Blinded Iron Ore Filter Cloth

Bernd Fränkle <sup>1,\*</sup> , Maximilian Stockert <sup>1</sup>, Thien Sok <sup>2</sup>, Marco Gleiß <sup>1</sup> and Hermann Nirschl <sup>1</sup>

<sup>1</sup> Institute of Mechanical Process Engineering and Mechanics, Karlsruhe Institute of Technology, 76131 Karlsruhe, Germany

<sup>2</sup> FLSmidth Inc., Salt Lake City Operations, Midvale, UT 84047, USA

\* Correspondence: bernd.fraenkle@kit.edu

**Abstract:** The global growth in demand for raw materials is leading to a continuous increase in the mining of ores and thus to an expanding volume of tailings to be stored. To ensure safer storage and an optimized recovery of process water, the tailings slurry is often thickened followed by filtration in filter presses and dry stacking. However, an increasing blinding effect during the time of operation requires cleaning or replacement of the filter media. Cloth washing using spray nozzles is a possible solution, but there is insufficient quantitative data published on the performance. For this reason, this article examines the cleaning of an iron ore cloth from tailings filtration by continuous water spraying. Water flux, spray time and direction (front- and back-wash) variation were investigated by evaluating cleaning performance using flow resistance measurement and comparison to the unused and industrially used state where blinding has occurred. Sufficient cleaning and achieving the flow rate of the unused cloth is possible. However, excessive spray cleaning should be avoided, as damage to the fibers may occur. Spray cleaning can be stated to be economically reasonable since a water demand of  $2.5 \text{ m}^3 \text{ m}^{-2}$  and an energy consumption of  $6.5 \text{ kWh m}^{-2}$  is necessary for a sufficient regeneration. Furthermore, the spray cleaning is assumed to cost USD  $6 \text{ m}^{-2}$ , which is approximately similar to replacing the fabric but reduces plastic waste.

**Keywords:** tailings filtration; recessed plate filter press; filter media; filter cloth; water spray washing; nozzle jet cleaning; regeneration; mineral processing



**Citation:** Fränkle, B.; Stockert, M.; Sok, T.; Gleiß, M.; Nirschl, H. Tailings Filtration: Water Jet Spray Cleaning of a Blinded Iron Ore Filter Cloth. *Minerals* **2023**, *13*, 416. <https://doi.org/10.3390/min13030416>

Academic Editors: Kirsten Claire Corin and Malibongwe Manono

Received: 8 February 2023

Revised: 10 March 2023

Accepted: 13 March 2023

Published: 15 March 2023



**Copyright:** © 2023 by the authors. Licensee MDPI, Basel, Switzerland. This article is an open access article distributed under the terms and conditions of the Creative Commons Attribution (CC BY) license (<https://creativecommons.org/licenses/by/4.0/>).

## 1. Introduction

For a modern way of life, the products that are needed originate in the mining of ores. For example, electric vehicles require a non-negligible amount of nickel and copper contained in their batteries [1]. As a result, the mining of minerals is constantly growing. Drawing the big picture, the mining cycle can be divided into exploration, evaluation, exploitation, mineral processing and reclamation [2]. Thereby, the aim of mineral processing is the separation and concentration of valuable minerals from unusable rock. In terms of process technology, this is usually achieved by crushing associated with froth flotation or leaching [3]. In most cases, the valuable minerals represent only a low percentage of the mined rock, e.g., 30% for iron ore and 1% for copper ore [4]. Therefore, the enormously large mass flows of solids remain as residues referred to as tailings [5]. Furthermore, nearly all of the process water is included in the tailings slurry, increasing the mine waste volume even more. Normally, this suspension of fine-grained rock gets pumped into large settling ponds, which have to be secured by dams. Due to regular dam failures and a low recycling rate of the process water, methodologies for thickening this suspension were developed during the 20th century [6]. If the tailings disposal is conducted as a paste or even as a filter cake, safer storage, recovery of the majority of the process water and reduction in land footprint is possible [7].

The filtration and dumping of ore residues are referred to as dry stacked tailings. Often, recessed plate filter presses performing filtration by means of plastic filter media

are used for this purpose. These ensure the dewatering of slurries containing particles that are too small for vacuum filtration or an increase in clay mineral content that is unfavorable for filtration caused, for example, by a change in the ore body [8]. In one mine only, several large recessed plate filter presses are operated in a parallel arrangement to handle the enormous mass flows (e.g., 7 for a 100.000 t/day tailings application [6]). Each filter media has a lifetime of several thousand filtration cycles before it has to be changed due to abrasive wear or blinding [9]. Blinding is a ubiquitous and undesired side-effect during cake filtration using filter media describing the permanent adhering of particles inside a cloth or nonwoven fabric reducing its permeability and increasing its pressure drop, referred to as filter media flow resistance [10–12]. This results in several negative effects concerning the filtration apparatus performance: if a defined filtrate volume is specified (for filter presses this corresponds to a specified residual moisture of the filter cake), the filtration time will be extended; if the cycle time is fixed, the filtrate volume will be reduced and the filter cake will have a higher water content, respectively. In any case, a performance reduction and an increase in energy consumption will occur. The operator of the filtration plant is forced to define a tolerable limit value for the necessity of a filter media replacement. Conversely, this means that extending the possible service life of the fabric increases energy and resource efficiency based on the reduction of wear material in terms of the filter medium and plant downtime. Especially in the mining industry with a continuous large mass flow, performance decrease of the filtration equipment and downtimes are very critical, as they quickly affect the overall processing in the concentrator plant and thus represent a bottleneck.

A successful filter media cleaning faces the challenge of blinding, improves technical plant availability and reduces spare part costs. Therefore, in addition to systems for a quick change of filter media, suppliers usually offer nozzle-cleaning systems for cloth washing [13–15]. The following advantages of spray washing are the main reasons for their implementation:

- The washing properties are very flexible and adjustable for each specific application. In detail, this means fluid velocity and pressure, distance between nozzle and surface as well as an impinging angle [16].
- Easy implementation and reduced hazard potential compared to chemical cleaning, which is also present [17,18]. Thereby, the chemical properties of the filter media plastics are an additional limiting factor [19–21].

Due to these benefits and its prevalence in the industry, nozzle cleaning can be considered the standard for tailings filtration application. However, industrially used systems are currently based on the experience of operators and suppliers, and there is hardly any data published in the mining sector. The mining company Outotec gives a pressure of 1 MPa to 3 MPa as a rough guide for cleaning particles trapped between fibers, and 5 to 10 MPa for cleaning precipitated or slimy solids [14].

Since intra-cloth contamination is a complex interaction of particle to fiber adhesion [22], particle to particle cohesion [11] and form closure (e.g., in multifile fibers) [23], these recommendations are insufficient. In addition, the complex geometry of the filter cloths and locally varying flow properties enhance the difficulty of cleaning [16]. Food and pharmaceutical engineering are areas where nozzle cleaning of filter media is scientifically studied, mainly for the reason that fabric contamination is a problematic point concerning the hygienic design of the process chain [24]. However, the cleaning behavior is stated as strongly dependent on the cleaning application [16]. Therefore, a direct transfer of specific solutions to the mining sector is not possible. The aim of this article is to improve the understanding of filter cloth water jet cleaning for iron ore tailings filtration by investigating the parameters flux, spray time and jet orientation, which are known as very important for the cleaning effectivity as well as water and energy consumption [16]. Therefore, the evaluation focuses on the following aspects. These parameters are of great industrial and scientific relevance:

- Permeability regeneration (flow resistance reduction);
- Water and energy consumption (ecological and economic benefit).

This article focuses on the regeneration of tailings filtration filter cloths from the processing of iron ore. In general, iron ore processing is well understood and broadly investigated, for example, in terms of iron mineral concentration by mechanical enrichment or flotation due to increasing demand and decreasing ore grades [25,26]. Besides increasing the amount of residues, the necessity of processing low-grade ores drives innovative process design [27]. In addition, iron ore tailings gain more and more importance, as they are produced in large annual quantities all over the world [28]. Their relevance is also indicated by the large number of re-use applications that are being studied, such as usage in adsorbents, batteries, geopolymers, mortar and concrete, pigments and several more [28]. In addition, a previous study showed that the investigated filter fabric of iron ore tailings had low effectiveness in chemical cleaning and, therefore, another cleaning option is necessary.

## 2. Materials and Methods

After a detailed description of the tailings from an iron ore mine used in the study, as well as the associated filter fabric, this section explains the experimental setup of the nozzle cleaning as well as the evaluation methodology of the fabric permeability in a pressure nutsch.

### 2.1. Iron Ore Tailings

Samples of tailings from an iron ore mine in Asia were provided by FLSmidth. These were first characterized by means of SEM images and a particle measurement by laser diffraction (HELOS & QUIXEL, Sympatec, Clausthal-Zellerfeld, Germany). Table 1 shows the scanning electron microscope (SEM) image of these tailings at a thousandfold magnification and gives characteristic values of the particle size distribution (PSD), which were measured in a previous publication [29]. The broadness of the distribution and the high fraction of small particles in the lower micrometer range is typical for tailings [30–33].

**Table 1.** SEM image (1000×) and characteristic PSD excerpts of the iron ore tailings.

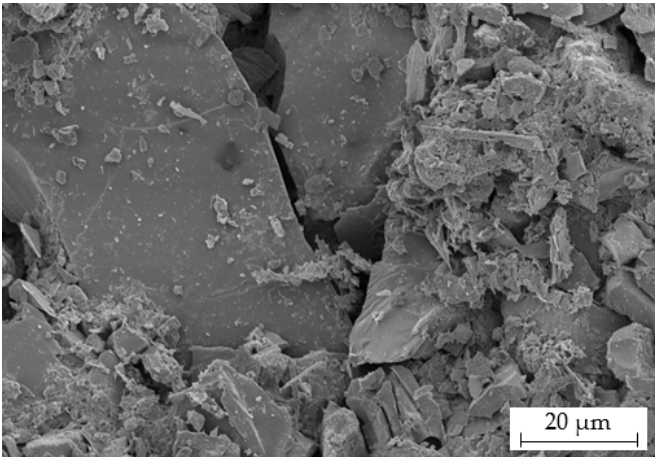
Characteristics	Iron Ore Tailings
SEM image	
$x_{10,3}/\mu\text{m}$	7.2 [29]
$x_{50,3}/\mu\text{m}$	38.2 [29]
$x_{90,3}/\mu\text{m}$	120.8 [29]

### 2.2. Filter Cloth

In addition to the tailings, FLSmidth provided used filter cloths from the same mine and the corresponding unused version. The blinded cloth had run approximately 1000 filtration cycles. A color image taken with a laser scanning microscope (LSM) of the unused version at tenfold magnification is shown in Table 2 as well as further specifications. The structure of the polypropylene cloth is a twill weave made of monofil weft fibers and multifil warp fibers; the latter dominate on the surface. This cloth was part of a previous chemical cleaning investigation in which the flow resistance of the unused and the industrially used (blinded) version was measured [29].

**Table 2.** Color image (10×) of the unused cloth state taken with an LSM and characteristics.

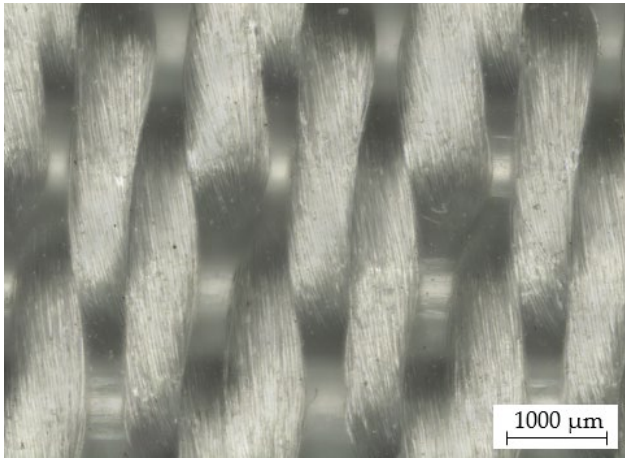
Characteristics	Iron Ore Tailings Filter Media
LSM image	
Material	Polypropylen
Weave type	Twill
Fiber type	Monofil and multifil
Unused flow resistance/m <sup>-1</sup>	4.3 ± 0.1 × 10 <sup>8</sup> [29]
Used flow resistance/m <sup>-1</sup>	2.4 ± 1.9 × 10 <sup>11</sup> [29]

### 2.3. Spray Nozzle Jet Cleaning of Iron Ore Tailings Filter Cloth Samples

The contamination of the industrially used fabric from tailings filtration of an iron ore mine after approximately 1000 filtration cycles is shown in Figure 1. It is visible that both the voids between the fibers and the interior of the multifilament fibers are completely blocked with particles. In order to regenerate the resulting additional flow resistance, these must be removed, overcoming the adhesion of particles to the fibers, particle–particle cohesion and form closure.

Table 3 shows the elemental composition measured by energy dispersive X-ray spectroscopy (EDX) of the particles adhering to the uncleaned cloth and the weight-based composition. This is in the range of the values in the literature for various mine sites [28].

**Table 3.** EDX analysis of adhering particles for the used filter cloth based on weight.

Element	Si	Al	Fe	K	Ca	Mn	Other
Adhering particles/μg cm <sup>-2</sup>	769	100	1402	60	52	137	1117
Ratio/%	31	4	56	2	1	5	31

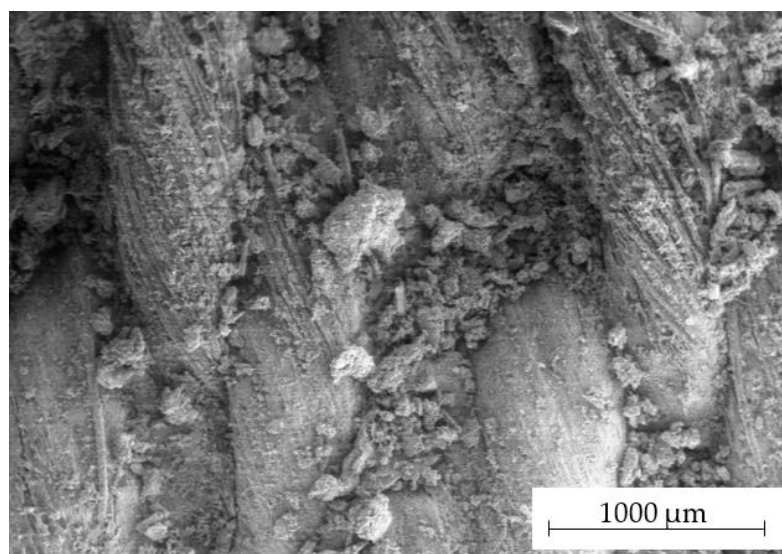

**Figure 1.** SEM image (85×) of the industrial used (blinded) iron ore tailings filter cloth surface showing the blocked particles between and within the fibers.

For the nozzle cleaning tests, circular filter media samples out of the industrially used cloths of the iron ore mine were prepared and sprayed, as shown in Figure 2, which can be used after cleaning for a permeability determination in a pressure nutsch. First, specimens with a diameter of 75 mm were cut from the 2 m × 2 m tailings filter fabric. In the next step, these were sealed at the edge with liquid rubber, corresponding to the size encountered by the cleaning jet to adjust flux. This was followed by the assembly and the cleaning of the cloth using the nozzle test setup.



**Figure 2.** Methodology of permeability test samples preparation including jet cleaning.

The test setup consisted of a positive displacement pump (axial piston pump with three pistons of a high-pressure cleaner (Kärcher HD 6/15 C Plus, Alfons Kärcher, Winnenden, Germany) and a 60° full cone nozzle (4906041YCE000, Lechler, Metzingen, Germany). A full cone nozzle was selected since it provides a uniform distribution of the liquid and the impinging area respective to the impinging impact is well defined in comparison to a flat nozzle [34]. An impinging angle of 90° was selected since this ensures a uniform flux distribution at the entire impinging area for a full cone nozzle [34]. Furthermore, flatter impinging angles reduce the impact force according to Werner et al. [35].

Measurements determined a constant flow rate of tap water at a value of  $7.5 \pm 0.1$  L/min ( $1.25 \pm 0.02 \cdot 10^{-4} \text{ m}^3\text{s}^{-1}$ ) with a water temperature of  $12.5 \pm 0.1$  °C at a pressure of  $1.6 \pm 0.1$  MPa. The measured electrical power requirement for this setup is  $1.19 \pm 0.02$  kW. The full cone nozzle has a diameter of 2.05 mm at its narrowest point, which corresponds to an average velocity of  $38 \pm 1 \text{ m s}^{-1}$  ( $\text{Re} = 6.4 \pm 0.1 \times 10^4$ ) in this part of the nozzle. For the variation of the volumetric flux impinging on the filter sample, the impingement

area of the cone was calculated based on the geometric data and the distance between the nozzle and filter media sample was adjusted. According to Werner et al., the cleaning distance should be within the core area of a jet or slightly above [16]. The core area apex is system-dependent but as a rule of thumb a distance-nozzle-diameter (DND) ratio of 5 can be assumed [36]. In addition, too small distances may inhibit cleaning due to a back flux. Therefore, as boundary values, a minimum impact diameter of 10 mm was chosen (DND ratio 4.2). As a maximum impinging diameter, 50 mm was set since this is the diameter of the pressure nutsch used for permeability determination. Within the range of the distance between the nozzle and cloth from 8.7 to 43.3 mm, the flux and, therefore, the jet force respective jet-impinging pressure changes drastically. Table 4 gives a schematic illustration of the geometric relations using a cross-cut, positions of the test samples and resulting characteristics.

**Table 4.** Characteristics of the full cone nozzle, filter cloth sample positions and impinging areas.

Characteristics	Test Setup			
Schematic illustration				
	Impinging diameter/mm	10	14	22
Distance/mm	8.7	12.1	19.1	43.3
DND ratio	4.2	5.9	9.3	21.1
Impinging area/mm <sup>2</sup>	79.2	153.3	382.0	1963.5
Flux/m <sup>3</sup> s <sup>-1</sup> m <sup>-2</sup>	1.59	0.81	0.33	0.06

It is not possible to predict from which side cleaning will be more effective [16]. For this reason, the variation of the flux and the spray time were carried out for a spraying from the front (cake side) as well as from the back. It should be noted that in industrial applications, only front-wash would be possible without disassembling the cloths and, thus, significantly lower downtime. However, spraying from the front possibly involves the risk of transporting particles deeper into the filter medium [37].

The setup shown in Figure 3 was used to position the specimen. The sample holder consisted of a support plate, backing cloth and a frame for clamping. The support plate, attached to a stand, has a cavity in the area behind the specimen, which is equipped with drainage channels for water passing through to the bottom and air inlet channels at the top. A coarse metal square mesh (mesh size 2 mm, wire diameter 1 mm) was used as a backing cloth. The clamping frame fixed the specimen and the backing cloth to the support plate and had an inner diameter of 60 mm and an angled transition to ensure the possibility of jet flow off to the side. This is essential for the displacement of dirt particles removed during spraying and absorbed in the cleaning fluid.

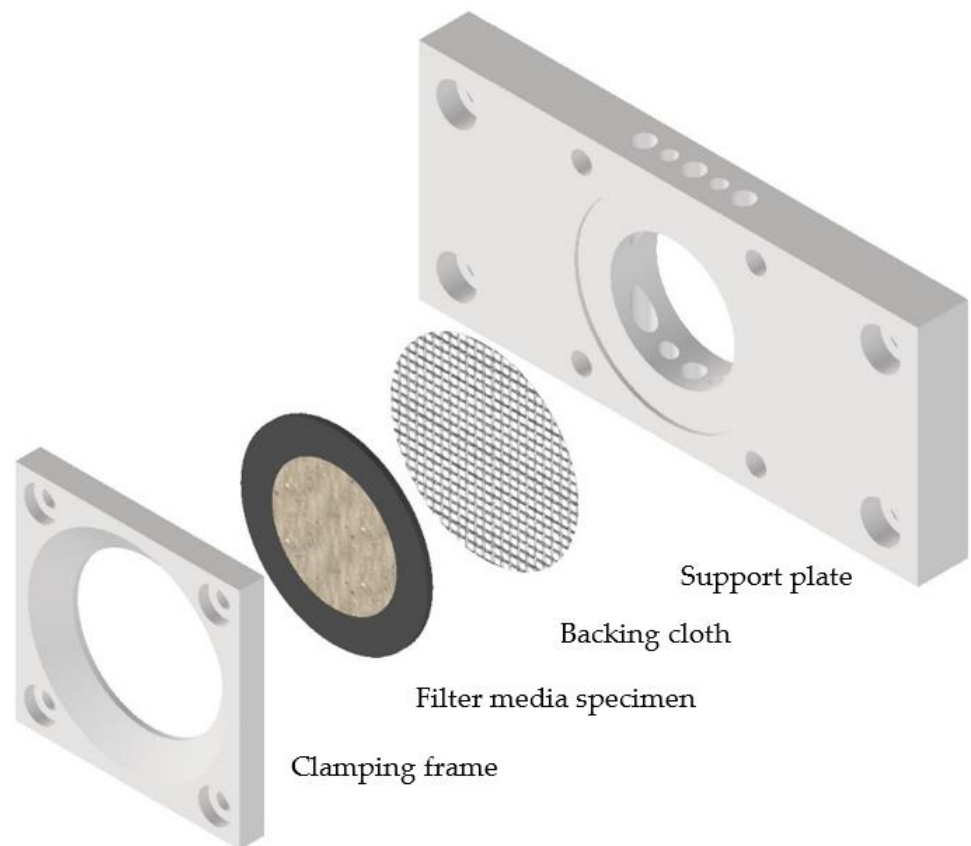

**Figure 3.** Design of the sample holder of the nozzle test station consisting of a support plate onto which the filter media sample and a backing cloth are fixed with a clamping frame.

#### 2.4. Evaluation of the Cleaning Performance

As a quantitative measurement to evaluate the cleaning performance, flow tests using a pressure nutsch according to VDI standard 2762 developed for lab filtration were performed. In the nutsch, the filter medium is fixed between a funnel at the bottom and a cylinder [38]. The cylinder can be closed and pressurized with compressed air. Clear water was filled in the cylinder above the medium and conveyed through the sample by applying a slight overpressure. By measuring the permeation of water gravimetrically at the fixed pressure, the filter medium clear water flow resistance  $R_{M, clear\ water}$  can be calculated using an adapted version of Darcy's law (Equation (1)).  $R_{M, clear\ water}$  is dependent on the flow area  $A$ , the measured mass flow  $\dot{m}$ , the density of the fluid  $\rho_{Fluid}$ , the applied pressure difference  $\Delta p$  and the dynamic viscosity of the fluid  $\eta_{Fluid}$ . This resistance is the reciprocal value to the permeability of the fabric.

$$R_{M, clear\ water} = \frac{A}{\dot{m}} \cdot \rho_{Fluid} \cdot \frac{\Delta p}{\eta_{Fluid}} \quad (1)$$

Furthermore, the ratio of the resulting mass flow through the cleaned sample to the mass flow of the used fabric according to Equation (2) is used to discuss the cleaning effect.

$$Flow\ ratio = \frac{\dot{m}_{M, cleaned}}{\dot{m}_{M, used}} = \frac{R_{M, used}}{R_{M, cleaned}} \quad (2)$$

The flow ratio allows a final labeling of the cleaning parameter combinations and is based on a threshold value for the improvement of the flow to a certain ratio. Based on this, the selection of an optimal parameter combination can then be evaluated to reduce the demand of spray water. For this purpose, the theoretical area-specific water demand  $V_{Water, area\ specific}$  is calculated by multiplying spray flux and spray time  $t_{Cleaning}$ . In addi-

tion, there is a factor that considers the necessary overlapping of several nozzles during surface cleaning (Equation (3)). The Lechler company specifies an overlap of the impinging surfaces of  $\frac{1}{4}$  to  $\frac{1}{3}$  [34]. Here, the conservative factor of  $\frac{1}{3}$  is used.

$$V_{Water, area\ specific} = \frac{3}{2} \cdot Flux_{Cleaning} \cdot t_{Cleaning} \quad (3)$$

Based on the measurement of the electrical power demand of the test setup including one nozzle  $P_{Electric, single\ nozzle}$  in operation, the overlap factor for a multiple nozzle application, the cleaned area by one nozzle  $A_{Cleaning, single\ nozzle}$  and spray time, the calculation of the required electrical energy for cleaning per square meter  $E_{Electric, area\ specific}$  is carried out according to Equation (4).

$$E_{Electric, area\ specific} = P_{Electric, single\ nozzle} \cdot \frac{1}{\frac{2}{3} \cdot A_{Cleaning, single\ nozzle}} \cdot t_{Cleaning} \quad (4)$$

### 3. Results and Discussion

For nozzle cleaning from the front (cake side) as well as from the back, the filter media flow resistances measured by means of flow-through tests are presented in this chapter and compared with the industrially used (blinded) and unused conditions. Originally, the apparatus used to perform the tests was developed for filtration tests instead of permeability tests. From these, important parameters are obtained for the design of a filter apparatus, primarily the filter cake resistance and the filter medium resistance. The latter is not the same as the pure flow resistance. The filter media resistance is the resistance including the first particle layer of the filter cake, which forms the particle bridges that then act as a filter media themselves. However, the measurement of the filter medium resistance based on filtration tests is not suitable for the specification of the state of blinding or its regeneration as the effect of bridging prevents quantification [29]. Therefore, permeability tests are necessary. In this article, a t-distribution of the parameter resistance is assumed and, in addition to the estimate of the mean value, the range of the 50% confidence level is given. Moreover, a listing and evaluation of the area-specific requirement of water for cleaning, calculated from the resistance values is carried out. Furthermore, electric energy demand per square meter is determined as well as approximated cleaning costs. Finally, an optical investigation of different cleaning states is carried out.

#### 3.1. Front-Wash Cleaning Performance and Water Demand

The filter media flow resistance data achieved by front-washing for the different spray times are plotted over the flux in Figure 4. As a reference, the unused and used state of the cloth is given as a dot-dashed and a dashed line and the mean values are exemplarily connected to illustrate the cleaning performance tendency for the lowest spray time. Starting at the value of the industrially used blinded cloth at  $2.43 \times 10^{11} \text{ m}^{-1}$ , the flow resistance is drastically decreasing for each investigated spray time and the lowest flux ( $0.06 \text{ m}^3 \text{ m}^{-2} \text{ s}^{-1}$ ) ranging between  $1 \times 10^9 \text{ m}^{-1}$  and  $1 \times 10^{10} \text{ m}^{-1}$ . However, the value for the filter media resistance for the unused state ( $4.33 \times 10^8 \text{ m}^{-1}$ ) is not reached. At higher flux values, differences resulting from the various spray times are more pronounced. Concerning the shortest spray time of 5 s, there is only a slight improvement and values do not fall below  $1 \times 10^9 \text{ m}^{-1}$  at a flux of  $0.33 \text{ m}^3 \text{ m}^{-2} \text{ s}^{-1}$  and over. In contrast, higher spray times starting from 30 s reach resistances in the range of the unused cloth. This quantitatively shows that it is possible to clean the iron ore tailings blinding in the multifile fiber cloth using a water full cone nozzle jet from the front. Furthermore, it can be stated that the cleaning performance is more dependent on flux than on spray time.



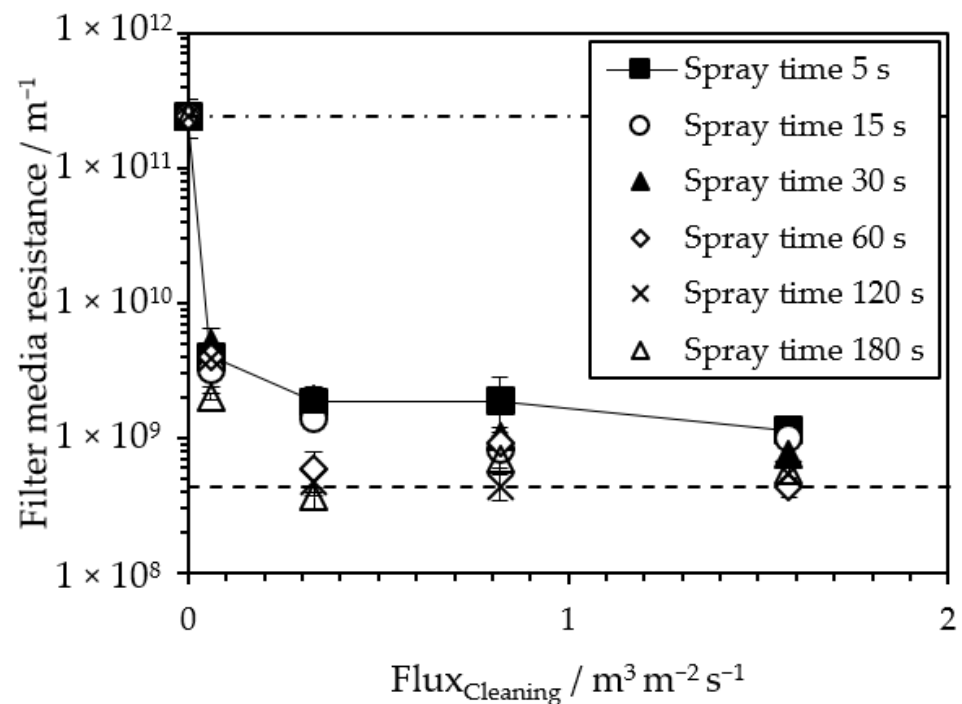

**Figure 4.** Filter media flow resistance after front-wash cleaning for the different spray times over flux. Blinded (after 1000 filtration cycles) and unused state are depicted as a reference with a dot-dashed and a dashed line.

Of great interest to operators and suppliers of filter presses is ensuring adequate cleaning at the lowest possible cost. Therefore, a cleaning parameter combination has to be determined by combining a low enough filter media flow resistance at low water consumption. To give a guideline, a resistance threshold of the resistances must be determined at first. This can be achieved by means of the flow ratio. Therefore, two aspects must be considered: First, complete cleaning of the blinded cloth and thus the production of the flow rate of the unused condition is very costly and not reasonable. A low number of adhering particles supports the formation of particle bridges at the beginning of filtration and, thus, reduces the turbidity impact at the beginning of cake filtration. Second, the flow ratio of the unused to the industrially used cloth state is 560. For this reason, further evaluation of the cleaning performance assumes that an improvement of the flow rate by a factor of 100 compared to the blinded condition is targetable. This refers to a filter media flow resistance of  $2.43 \times 10^9 \text{ m}^{-1}$ . Table 5 shows all parameter combinations of the cleaning study with a colored background showing whether the cleaning resulted in a flow resistance above this threshold (red) or below (green). The listed value is the theoretical water demand per square meter calculated from flux and spray time. It can be observed that there is a region of low flux and low spray times where cleaning performance is insufficient. Furthermore, the successful cleaning parameter combination having the lowest water demand of  $2.5 \text{ m}^3$  is highlighted, which results from a 5 s spray time using a flux of  $0.33 \text{ m}^3 \text{ m}^{-2} \text{ s}^{-1}$  and including the overlap factor for a multiple nozzle setup. Reaching a good effect at short spray times is beneficial in an additional manner: it will keep the down time as low as possible. The water requirement of  $2.5 \text{ m}^3$  is not insignificant but the water might be recovered in the process.

**Table 5.** Water demand per square meter for all front-wash cleaning parameter combinations. The color background is based on the cleaning performance. A cleaning performance above the threshold of a one-hundred-fold increase in flow in relation to the blinded cloth is marked in green and insufficient regeneration in red. Highlighted in dark green is the successful combination with the lowest water demand.

		Spray Time/s					
		5	15	30	60	120	180
Flux/m <sup>3</sup> m <sup>-2</sup> s <sup>-1</sup>	0.06	0.5 m <sup>3</sup> m <sup>-2</sup>	1.4 m <sup>3</sup> m <sup>-2</sup>	2.9 m <sup>3</sup> m <sup>-2</sup>	5.7 m <sup>3</sup> m <sup>-2</sup>	11.5 m <sup>3</sup> m <sup>-2</sup>	17.2 m <sup>3</sup> m <sup>-2</sup>
	0.33	2.5 m <sup>3</sup> m <sup>-2</sup>	7.4 m <sup>3</sup> m <sup>-2</sup>	14.8 m <sup>3</sup> m <sup>-2</sup>	29.6 m <sup>3</sup> m <sup>-2</sup>	59.2 m <sup>3</sup> m <sup>-2</sup>	88.8 m <sup>3</sup> m <sup>-2</sup>
	0.81	6.1 m <sup>3</sup> m <sup>-2</sup>	18.3 m <sup>3</sup> m <sup>-2</sup>	36.5 m <sup>3</sup> m <sup>-2</sup>	73.1 m <sup>3</sup> m <sup>-2</sup>	146.2 m <sup>3</sup> m <sup>-2</sup>	219.2 m <sup>3</sup> m <sup>-2</sup>
	1.59	11.9 m <sup>3</sup> m <sup>-2</sup>	35.8 m <sup>3</sup> m <sup>-2</sup>	71.6 m <sup>3</sup> m <sup>-2</sup>	143.2 m <sup>3</sup> m <sup>-2</sup>	286.5 m <sup>3</sup> m <sup>-2</sup>	429.7 m <sup>3</sup> m <sup>-2</sup>

3.2. Back-Wash Cleaning Performance and Water Demand

Cleaning performance for back-wash is shown with the filter media flow resistance data in Figure 5. Analogous to the front-wash results, values for the different spray times are plotted over the flux including a dot-dashed and a dashed line of the blinded and unused state of the investigated tailings filter cloth as a reference. Again, the mean values of the shortest spray time are exemplarily connected to illustrate cleaning performance tendency. While there is a reduction in resistances for all spray times at the lowest flux, it is not as effective in this cleaning orientation as in the front-wash scenario. Furthermore, these values are subject to greater uncertainties. The values of the lowest flux (0.06 m<sup>3</sup> m<sup>-2</sup> s<sup>-1</sup>) are between 1 × 10<sup>9</sup> m<sup>-1</sup> and 1 × 10<sup>11</sup> m<sup>-1</sup>. Although a further decrease with a higher flux can be observed, only a few regeneration parameter combinations reach values below 1 × 10<sup>9</sup> m<sup>-1</sup>. In terms of tendency, the curves are flatter. Furthermore, the highest flux in combination with spray times of 60 s to 180 s achieves resistances in the range of the unused filter medium and, thus, a complete cleaning. These are fewer combinations than with the front-wash. In conclusion, cleaning from the back with the jet of the full cone nozzle is lower in efficiency than the front-wash for the blinded iron ore filter media investigated.

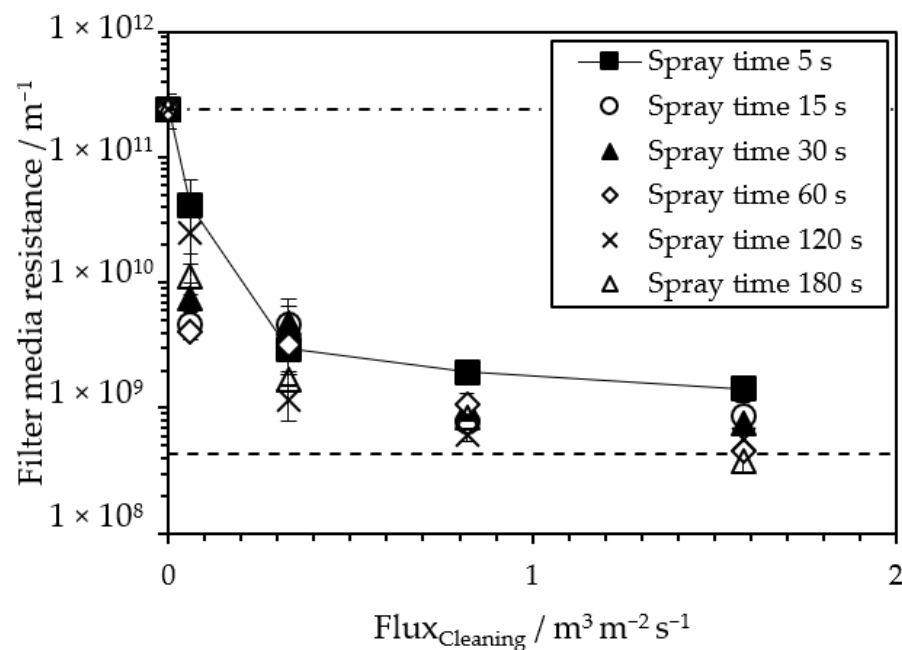

**Figure 5.** Filter media flow resistance after back-wash cleaning for the different spray times over flux. Blinded (after 1000 filtration cycles) and unused state are depicted as a reference with a dot-dashed and a dashed line.

This difference to front-wash can also be seen by considering the water demand per square meter calculated using Equation (3) in Table 6. The region in which an increase in flow by at least a factor of 100 is achieved is smaller compared to front-wash. Therefore, it includes combinations of higher flux and longer spray time for back-wash. The lowest water demand for sufficient cleaning reaching the threshold of  $2.43 \times 10^9 \text{ m}^{-1}$  is  $6.1 \text{ m}^3 \text{ m}^{-2}$  including the overlap factor. This results from a flux of  $0.33 \text{ m}^3 \text{ m}^{-2} \text{ s}^{-1}$  and a spray time of 5 s.

**Table 6.** Water demand per square meter for all back-wash cleaning parameter combinations. The color background is based on the cleaning performance. A cleaning above the threshold of a one-hundred-fold increase in flow in relation to the blinded cloth is marked in green and insufficient regeneration in red. Highlighted in dark green is the successful combination with the lowest water demand.

		Spray Time/s					
		5	15	30	60	120	180
Flux/ $\text{m}^3 \text{ m}^{-2} \text{ s}^{-1}$	0.06	0.5 $\text{m}^3 \text{ m}^{-2}$	1.4 $\text{m}^3 \text{ m}^{-2}$	2.9 $\text{m}^3 \text{ m}^{-2}$	5.7 $\text{m}^3 \text{ m}^{-2}$	11.5 $\text{m}^3 \text{ m}^{-2}$	17.2 $\text{m}^3 \text{ m}^{-2}$
	0.33	2.5 $\text{m}^3 \text{ m}^{-2}$	7.4 $\text{m}^3 \text{ m}^{-2}$	14.8 $\text{m}^3 \text{ m}^{-2}$	29.6 $\text{m}^3 \text{ m}^{-2}$	59.2 $\text{m}^3 \text{ m}^{-2}$	88.8 $\text{m}^3 \text{ m}^{-2}$
	0.81	6.1 $\text{m}^3 \text{ m}^{-2}$	18.3 $\text{m}^3 \text{ m}^{-2}$	36.5 $\text{m}^3 \text{ m}^{-2}$	73.1 $\text{m}^3 \text{ m}^{-2}$	146.2 $\text{m}^3 \text{ m}^{-2}$	219.2 $\text{m}^3 \text{ m}^{-2}$
	1.59	11.9 $\text{m}^3 \text{ m}^{-2}$	35.8 $\text{m}^3 \text{ m}^{-2}$	71.6 $\text{m}^3 \text{ m}^{-2}$	143.2 $\text{m}^3 \text{ m}^{-2}$	286.5 $\text{m}^3 \text{ m}^{-2}$	429.7 $\text{m}^3 \text{ m}^{-2}$

### 3.3. Electric Energy Demand

The electric energy demand per square meter was calculated for each combination of spray time and flux according to Equation (4) and is shown in Table 7. Concerning the threshold of sufficient cleaning for a flow rate improvement of 100, this results in a requirement of  $6.5 \text{ kWh m}^{-2}$  for front-wash and  $16.1 \text{ kWh m}^{-2}$  for back-wash. However, this is based on a parallel operation of full cone nozzles and one pump per nozzle and, therefore, the starting point of an optimization by an adapted pump selection.

**Table 7.** Electric energy demand per square meter for all cleaning parameter combinations. Highlighted are the successful combination with the lowest water demand for front- and back-wash.

		Spray Time/s					
		5	15	30	60	120	180
Flux/ $\text{m}^3 \text{ m}^{-2} \text{ s}^{-1}$	0.06	1.3 $\text{kWh m}^{-2}$	3.8 $\text{kWh m}^{-2}$	7.6 $\text{kWh m}^{-2}$	15.2 $\text{kWh m}^{-2}$	30.3 $\text{kWh m}^{-2}$	45.5 $\text{kWh m}^{-2}$
	0.33	6.5 $\text{kWh m}^{-2}$	19.6 $\text{kWh m}^{-2}$	39.1 $\text{kWh m}^{-2}$	78.3 $\text{kWh m}^{-2}$	156.5 $\text{kWh m}^{-2}$	234.8 $\text{kWh m}^{-2}$
	0.81	16.1 $\text{kWh m}^{-2}$	48.3 $\text{kWh m}^{-2}$	96.6 $\text{kWh m}^{-2}$	193.3 $\text{kWh m}^{-2}$	386.5 $\text{kWh m}^{-2}$	579.8 $\text{kWh m}^{-2}$
	1.59	31.6 $\text{kWh m}^{-2}$	94.7 $\text{kWh m}^{-2}$	189.4 $\text{kWh m}^{-2}$	378.8 $\text{kWh m}^{-2}$	757.6 $\text{kWh m}^{-2}$	1136.4 $\text{kWh m}^{-2}$

### 3.4. Calculation of Cleaning Costs

The calculation of the cleaning price refers to data from Kruyswijk, who estimated a water price of  $\text{EUR } 2 \text{ m}^{-3}$  and an electric energy price of  $\text{EUR } 0.1 \text{ kWh}^{-1}$  for the comparison of processing tailings as a paste and dry stacking in 2021 [39]. Furthermore, a USD to EUR exchange rate of 1/1 is assumed. Combining water and electric energy prices, the cleaning of the blinded iron ore tailings filtration cloth by using a front-wash costs approximately  $\text{USD } 6 \text{ m}^{-2}$  for parallel operation of full cone nozzles and one pump per nozzle with the condition to increase the flow rate at least by a factor of 100. The cleaning costs presented refer to the operating costs (Opex) without the procurement of the equipment (Capex). However, a cost reduction would be possible by improving pump selection. Moreover, the consideration is strongly dependent on the specification of the required cleaning efficiency, i.e., increase in volume flow compared to the blinded state. The assumption of a factor of 100 as a threshold must be verified on a pilot plant. Furthermore, the prices for electricity, water and filter fabric have to be considered depending on the application and its location in order to be able to evaluate the economic efficiency. As a result, filter cloth spray washing

is competitive to the replacement of the fabric at mid two-digit USD  $m^{-2}$  range. In addition, reduction of plastic waste by lifetime increase is a further benefit of spray cleaning instead of cloth change.

### 3.5. Optical Investigation

During the first seconds of the spray cleaning, absorption of adhering particles by the impinging water jet was observed. The water draining to the side had an increased turbidity corresponding to the same color as the tailings. For this reason, collected wash water should be processed before reuse.

Figure 6 shows SEM images with  $80\times$  magnification of the cloths regenerated using different cleaning combinations. In addition, selected pores at the crossing points of the fibers are pictured in detail ( $350\times$ ).

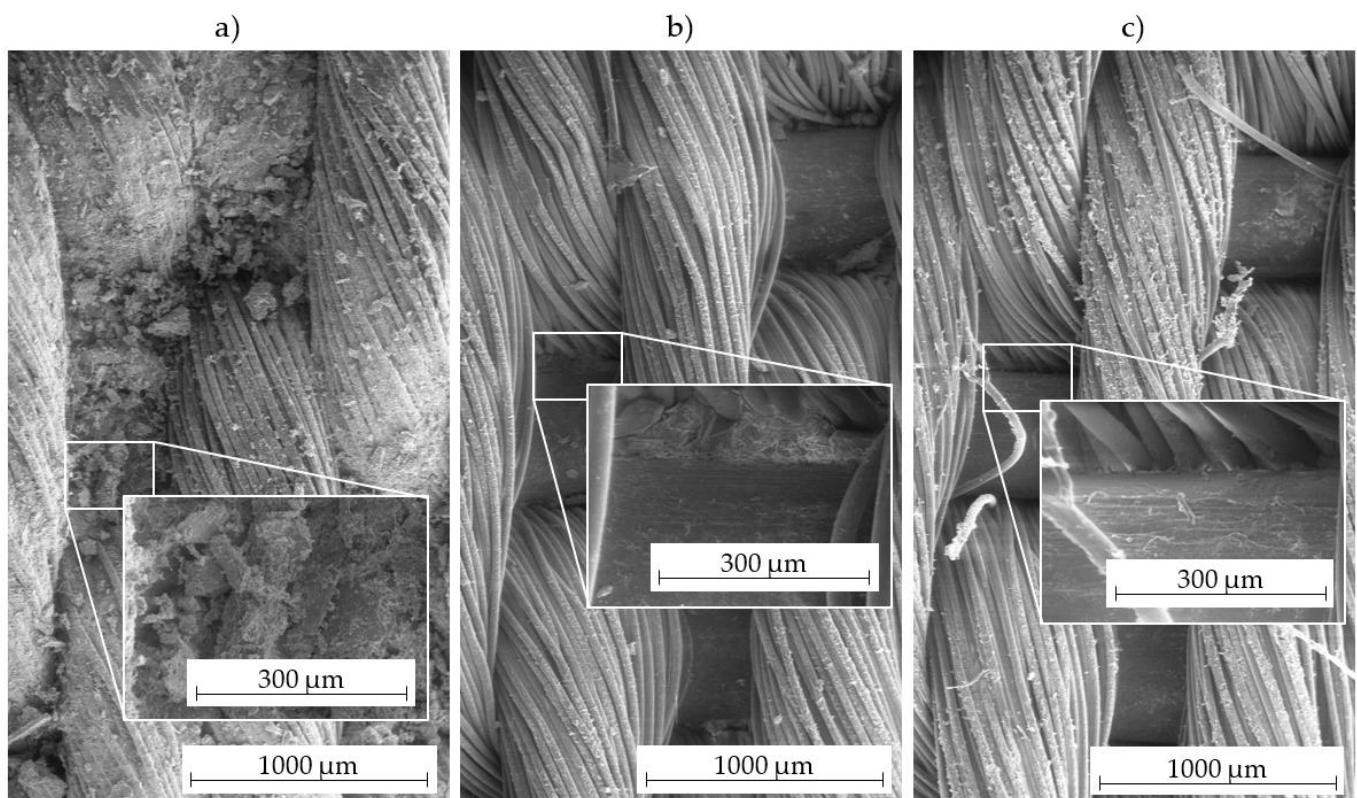

**Figure 6.** SEM images ( $80\times$ ) of different filter cloth states. (a) Insufficient cleaning resulting in a resistance of  $3.24 \times 10^{10} m^{-1}$ . (b) Threshold cleaning (resistance  $2.20 \times 10^9 m^{-1}$ ). (c) Excessive cleaning causing the fraying of multifile fibers (resistance  $1.94 \times 10^8 m^{-1}$ ).

Figure 6a shows an insufficient back-wash cleaning at the shortest spray time (5 s) and lowest flux ( $0.06 m^3 m^{-2} s^{-1}$ ) resulting in a resistance value of  $3.24 \times 10^{10} m^{-1}$ . A large number of particles can be seen in the pores where the fibers cross and inside the multifile fibers. Therefore, the appearance is slightly browner compared to the other specimens. The sample in the middle (Figure 6b, front-wash, flux  $0.06 m^3 m^{-2} s^{-1}$ , spray time 180 s) has a lower but still visible load of solids. Especially within the multifile fibers, there is a reduction. With a resistance of  $2.20 \times 10^9 m^{-1}$ , this specimen is just below the assumed threshold for successful cleaning of  $2.43 \times 10^9 m^{-1}$ . Figure 6c shows an image of a sample with a very intensive cleaning (front-wash, flux  $1.59 m^3 m^{-2} s^{-1}$ , spray time 180 s, resistance  $1.94 \times 10^8 m^{-1}$ ). While only a few adhering particles can be seen, short pieces of protruding filament fibers are noticeable. This indicates excessive mechanical stress by the jet and an incipient undesirable destruction respective fraying of the multifile

fibers. It can be emphasized that intensive cleaning, therefore, has a negative effect on the fabric.

#### 4. Conclusions

Due to the increasing mining of minerals, safe storage of the residues, for example by dry stacking, is necessary. The filter cloths of the filter presses used in this process become blinded and have to be replaced or regenerated in order to maintain economical operation. Therefore, a large number of filter press suppliers in the mining sector offer nozzle cleaning as an add-on device for their apparatuses. However, the regeneration of filter cloth blinding using nozzles is based on general experience and not yet quantified by structured experiments. Investigations of continuous full cone nozzle cleaning on an iron ore tailings cloth have shown that the flux of the impinging jet, the spray time and the spray direction have decisive influences. A higher flux increases the cleaning effect significantly, whereas extended spray time results only in a slight improvement. Furthermore, a front-wash is more effective than a back-wash. Care must be taken in the design of the cleaning system to avoid damaging the fabrics by excessive force.

Front-wash cleaning with a flux of  $0.33 \text{ m}^3 \text{ m}^{-2} \text{ s}^{-1}$  and a spray time of 5 s achieves a hundredfold filter media flow rate compared to the blinded state. This is equivalent to a water demand of  $2.5 \text{ m}^3 \text{ m}^{-2}$  and electric energy demand of  $6.5 \text{ kWh m}^{-2}$ . Theoretical considerations of water and energy requirements show that the costs of nozzle cleaning ( $\text{USD } 6 \text{ m}^{-2}$ ) are in the same range as those of fabric replacement. Therefore, jet cleaning and reusing are beneficial since they save a large amount of plastic waste. Furthermore, the possibility of successful cleaning of the blinding has an impact on the fabric selection. In particular, abrasion resistance increases in importance.

**Author Contributions:** Conceptualization, B.F.; methodology, B.F.; investigation, B.F. and M.S.; data curation, B.F. and M.S.; writing—original draft preparation, B.F.; writing—review and editing, B.F.; visualization, B.F.; supervision, T.S., M.G. and H.N.; funding acquisition, H.N. All authors have read and agreed to the published version of the manuscript.

**Funding:** This research was funded by FLSmidth.

**Institutional Review Board Statement:** Not applicable.

**Informed Consent Statement:** Not applicable.

**Data Availability Statement:** Not applicable.

**Acknowledgments:** The authors would like to thank all students and colleagues who have contributed to the successful completion of this work. Special thanks for support go to Michael Madsen, James Chaponnel, Scott Reddick, Dave Hanfland, Paul McCurdie, Todd Wisdom, Brent Stokes and Steve Ware from FLSmidth. The regular meetings and critical discussions have contributed significantly to the success of the work. This work was sponsored by FLSmidth. We acknowledge support from the KIT-Publication Fund of the Karlsruhe Institute of Technology.

**Conflicts of Interest:** The funders had no role in the design of the study; in the collection, analyses, or interpretation of data; in the writing of the manuscript, or in the decision to publish the results.

#### References

1. Revuelta, M.B. *Mineral Resources—From Exploration to Sustainability Assessment*; International Publishing AG: Cham, Switzerland, 2017.
2. ICM. 2022. Available online: <https://www.icmm.com/website/publications/pdfs/environmental-stewardship/2020/global-industry-standard-on-tailings-management.pdf> (accessed on 12 March 2023).
3. Wills, B.A.; Finch, J.A. *Wills' Mineral Processing Technology—An Introduction to the Practical Aspects of Ore Treatment and Mineral Recovery*, 8th ed.; Elsevier Ltd. (Butterworth-Heinemann): Oxford, UK, 2015.
4. Mortimer, C.E.; Müller, U. *Das Basiswissen der Chemie*, 9th ed.; Thieme: Stuttgart, Germany, 2007.
5. Concha, A.F. *Solid-Liquid Separation in the Mining Industry*; Springer International Publishing: Cham, Switzerland, 2014.
6. Jewell, R.J.; Fourie, A.B. *Paste and Thickened Tailings—A Guide*, 3rd ed.; Australian Centre for Geomechanics: Perth, Australia, 2015.

7. Morrill, J.; Personius, P.; Sampat, P.; Lapointe, U.; Kneen, J.; Turgeon, R.; Harkinson, R.; Maest, A.; Chambers, D.; Emerman, S.; et al. *Safety First—Guidelines for Responsible Mine Tailings Management*, 2nd ed.; Earthworks, MiningWatch Canada and London Mining Network: Washington, DC, USA, 2020.
8. Micronics. MICRONICS' New Mine-XLL™ Filter Cloth Delivers over 10,000 Cycles in Select Mineral Processing Applications. 2020. Available online: <https://www.micronicsinc.com/de/filtration-news/new-mine-xll-mining-filter-cloth/> (accessed on 16 November 2022).
9. Wisdom, T. Maintaining high availability and low operational costs for filtered tailings facilities. In Proceedings of the 22nd International Conference on Paste, Thickened and Filtered Tailings—Paste 2019, Cape Town, South Africa, 8–10 May 2019; Australian Centre for Geomechanics: Perth, Australia, 2019.
10. Rushton, A. Effect of Filter Cloth Structure on Flow Resistance, Bleeding, Blinding and Plant Performance. *Chem. Eng.* **1970**, *273*, 88–94.
11. Weigert, T.; Ripperger, S. Effect of Filter Fabric Blinding on Cake Filtration. *Filtr. Sep.* **1997**, *34*, 507–510. [[CrossRef](#)]
12. Buchwald, T.; Peuker, U. Evaluation of filter media that can be used in automatic filters. In *Filtration and Separation Technologies International Edition*; Vulkan-Verlag GmbH: Essen, Germany, 2022.
13. AFP2525 Automatic Filter Press Flyer. 2021. Available online: <https://www.flsmidth.com/-/media/brochures/brochures-products/filtration/pressure-filters/afp2525-automatic-filter-press-flyer.pdf> (accessed on 2 January 2022).
14. Palmer, J.; Outotec. Palmer Practical Solutions for Mine tailings—Webinar—Part 2. 2020. Available online: [http://public2.brighttalk.com/resource/core/270553/part-2---practical-solutions-for-mine-tailings\\_601265.pdf](http://public2.brighttalk.com/resource/core/270553/part-2---practical-solutions-for-mine-tailings_601265.pdf) (accessed on 14 May 2020).
15. Aqseptence Diemme Filtration—GHT5000F Domino. 2023. Available online: <https://www.diemmefiltration.com/filterpress-for-sludge/filter-press-ght-5000f-domino/> (accessed on 2 January 2023).
16. Werner, R.A.; Geier, D.U.; Becker, T. The Challenge of Cleaning Woven Filter Cloth in the Beverage Industry—Wash Jets as an Appropriate Solution. *Food Eng. Rev.* **2020**, *12*, 520–545. [[CrossRef](#)]
17. Micronics Engineered Filtration Group Chemical Cleaning of Filter Cloth for Optimal Filter Press Performance. 2023. Available online: <https://www.micronicsinc.com/de/filtration-news/chemical-cleaning-filter-cloth/> (accessed on 2 January 2023).
18. Universal. Universal Filtration & Pumping Solutions—Acid Cleaning. 2020. Available online: <http://automaticfilterpress.com/acid-cleaning/> (accessed on 5 January 2020).
19. Bremus, H.-J. Einsatzkriterien für textile Filtermedien. *Chem. Ing. Tech.* **1981**, *53*, 433–438. [[CrossRef](#)]
20. Horrocks, A.; Anand, S. *Handbook of Technical Textiles*; Woodhead Publishing Ltd: Cambridge, United Kingdom, 2000.
21. Anlauf, H. Filtermedien zur Kuchenfiltration—Schnittstelle zwischen Suspension und Apparat. *Chem. Ing. Tech.* **2007**, *11*, 1821–1831. [[CrossRef](#)]
22. Wu, S.; Rongrong, C.; Zhang, L. Research progress on the cleaning and regeneration of PM2.5 filter media. *Particuology* **2021**, *57*, 28–44. [[CrossRef](#)]
23. Möller, R.-S.; Nirschl, H. Adhesion and cleanability of surfaces in the baker's trade. *J. Food Eng.* **2016**, *194*, 99–108. [[CrossRef](#)]
24. Stahl, S.; Siggelkow, S.; Nirschl, H. A Microbiological Test Method to Determine the Cleanability of Filter Media in Solid-Liquid-Separation Applications. *Eng. Life Sci.* **2007**, *7*, 136–142. [[CrossRef](#)]
25. Srivastava, M.P.; Pan, S.K.; Prasad, N.; Mishra, B. Characterization and processing of iron ore fines of Kiriburu deposit of India. *Int. J. Miner. Process.* **2001**, *61*, 93–107. [[CrossRef](#)]
26. Kapiamba, K.F.; Kimpiab, M. The effects of partially replacing amine collectors by a commercial frother in a reverse cationic hematite flotation. *Heliyon* **2021**, *7*, e06559. [[CrossRef](#)] [[PubMed](#)]
27. Srivastava, U.; Kawatra, S.K. Strategies for processing low-grade iron ore minerals. *Miner. Process. Extr. Metall. Rev.* **2009**, *30*, 361–371. [[CrossRef](#)]
28. Carmignano, O.R.; Vieira, S.S.; Teixeira, A.P.C.; Lameiras, F.S.; Brandão, P.R.G.; Lago, R.M. Iron Ore Tailings: Characterization and Applications. *J. Braz. Chem. Soc.* **2021**, *32*, 1895–1911. [[CrossRef](#)]
29. Fränkle, B.; Morsch, P.; Nirschl, H. Regeneration Assessments of Filter Fabrics of Filter Presses in the Mining Sector. *Miner. Eng.* **2021**, *168*, 106922. [[CrossRef](#)]
30. Davies, M. Filtered Dry Stacked Tailings—The Fundamentals. In Proceedings of the Tailings and Mine Waste, Vancouver, BC, Canada, 6–9 November 2011.
31. Wang, C.; Harbottle, D.; Liu, Q.; Xu, Z. Current state of fine mineral tailings treatment: A critical review on theory and practice. *Miner. Eng.* **2014**, *58*, 113–131. [[CrossRef](#)]
32. Kaswalder, F.; Fritzke, I.; Cavalli, D.; Bassi, A. High Capacity Dewatering Plants. In Proceedings of the 23rd International Conference on Paste, Thickened and Filtered Tailings—Paste 2020, Santiago, Chile, 2–6 November 2020.
33. Mamghaderi, H.; Gharabaghi, M.; Noaparast, M. Optimization of role of physical parameters in the filtration processing with focus on the fluid flow from pore. *Miner. Eng.* **2018**, *122*, 220–226. [[CrossRef](#)]
34. Lechler. Lechler GmbH—Spray Nozzles and Accessories. 2020. Available online: [https://www.lechlerusa.com/fileadmin/media-usa/Literature/Catalog/CATALOG\\_501.pdf](https://www.lechlerusa.com/fileadmin/media-usa/Literature/Catalog/CATALOG_501.pdf) (accessed on 25 January 2023).
35. Werner, R.A.; Schappals, L.; Geier, D.U.; Becker, T. Pulsed forward flushes as a novel method for cleaning spent grains-loaded filter cloth. *Food Sci. Technol.* **2022**, *57*, 4575–4585. [[CrossRef](#)]
36. Guha, A.; Barron, R.M.; Balachandar, R. An experimental and numerical study of water jet cleaning process. *J. Mater. Process. Technol.* **2011**, *211*, 610–618. [[CrossRef](#)]

37. Rushton, A.; Ward, A.S.; Holdich, R.G. *Solid-Liquid Filtration and Separation Technology*, 2nd ed.; Wiley-VCH: Weinheim, Germany, 2000.
38. VDI. *Filtrierbarkeit von Suspensionen: Bestimmung des Filterkuchenwiderstands*; VDI: Düsseldorf, Germany, 2010.
39. Kruyswijk, J.B. The balance between energy and water preservation in the deposition of dry tailings in wet climates. In *Proceedings of the 24th International Conference on Paste, Thickened and Filtered Tailings—Paste 2021*, Perth, Australia, 21–23 September 2021; Australian Centre for Geomechanics: Perth, Australia, 2021.

**Disclaimer/Publisher’s Note:** The statements, opinions and data contained in all publications are solely those of the individual author(s) and contributor(s) and not of MDPI and/or the editor(s). MDPI and/or the editor(s) disclaim responsibility for any injury to people or property resulting from any ideas, methods, instructions or products referred to in the content.