

# Long-term radionuclide retention in the near field: collaborative R&D studies within EURAD focusing on container optimisation, mobility, mechanisms and monitoring

Marcus Altmaier<sup>1\*</sup>, Johan Bertrand<sup>2</sup>, Sergey Churakov<sup>3</sup>, and Nikitas Diomidis<sup>4</sup>

<sup>1</sup> Karlsruhe Institute of Technology (KIT), Institute for Nuclear Waste Disposal (INE), PO Box 3640, 76021 Karlsruhe, Germany

<sup>2</sup> ANDRA, 1-7 rue Jean-Monnet, 92298 Châtenay-Malabry Cedex, France

<sup>3</sup> Paul Scherrer Institut (PSI), Laboratory for Waste Management (LES), OFLA/203, Forschungsstrasse 111, 5232 Villigen PSI, Switzerland

<sup>4</sup> NAGRA, Hardstrasse 73, PF 280, 5430 Wettingen, Switzerland

Received: 14 April 2022 / Received in final form: 25 July 2022 / Accepted: 8 August 2022

**Abstract.** Within EURAD, targeted collaborative research activities are performed to further deepen understanding regarding the long-term behaviour of key components in the repository near-field, assess specific radionuclide retention processes as well as developing methods for monitoring safety relevant parameters of repository systems. The ambition of the four EURAD Workpackages (WPs) – CONCORD, FUTURE, CORI, MODATS – presented here, is to investigate topics to meet implementation needs and contribute to Safety Cases in Europe at the highest level of scientific excellence. Work is fully integrated into the EURAD concept, emphasizing interactions between different WPs, involvement of End Users, assuring the link to national programmes and contributing to overarching features like Knowledge Management, Training and Education, or European Integration. Comprehensive initial State-of-the-Art reports were prepared by the WPs or currently under development and are available at the EURAD website. The technical/scientific work performed in the four WPs - CONCORD, FUTURE, CORI, MODATS – is discussed in this contribution.

## 1 Introduction

In the development phase of each of the four EURAD Workpackages (WPs) CONCORD, FUTURE, CORI and MODATS, presented here, topics were jointly identified by Waste Management Organisations (WMOs), Research Entities (REs) and Technical Support Organisations (TSOs) which could be significantly advanced by a joint research effort performed at the European level. Within the integrated research concept in EURAD, each WP focusses on specific important sub-topics. CONCORD contributes to the optimization of container performance and of its assessment and evaluates novel container materials. FUTURE investigates the transport and retention mechanisms of radionuclides and provides mechanistic models for reactive transport simulations in real clays and crystalline rocks necessary for performance assessment studies. CORI research improves understanding of the role of organics and their influence on radionuclide migration in cement-based systems with high organics inventories, being mainly relevant to L/ILW waste disposal. MODATS works to consolidate the implementation strategy for monitoring

systems by developing methods through which confidence can be demonstrated in the data acquired and benefits derived for repository implementation.

In this overview paper, examples from the ongoing research programs in CONCORD, FUTURE, CORI and MODATS are used to highlight research tools, strategy and results in each work package. The research is put into context by stating the motivation and fundamental technical/scientific challenges driving the WPs, as well as indicating potential relevance of the studies in view of potential applications in repository programs and the Nuclear Waste Disposal Safety Case.

## 2 CONCORD – Optimisation of SF/HLW container performance and the tools available for its assessment

The containers (or canisters) for the disposal of spent fuel and high-level waste are the only barrier providing absolute containment of radionuclides for a certain period of time in the overall multi-barrier disposal system of a deep geological repository. As such, the duration of

\* e-mail: [marcus.altmaier@kit.edu](mailto:marcus.altmaier@kit.edu)

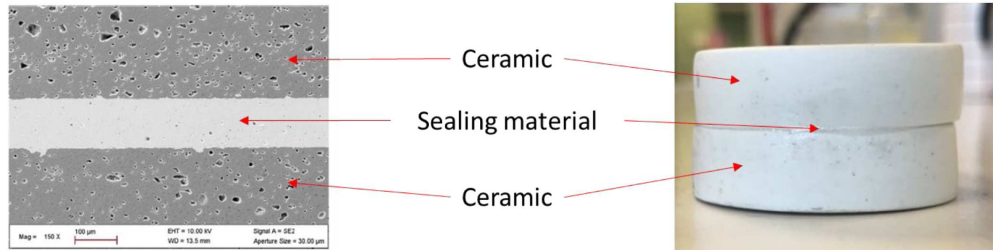

**Fig. 1.** SEM micrograph of the interfaces between the seal and the ceramic parts (left) and photo of a sealing test (right). (Courtesy of I. Cornu and F. Rossignol, IRCER, Université de Limoges).

their primary barrier function depends on the time until they breach or their lifetime. SF/HLW disposal containers have been developed to varying degrees of maturity in many national programmes. Primarily, existing canister concepts have been either steel-based or dual material concepts based on an outer copper shell or coating and inner cast iron or steel structure. In several instances, detailed performance assessments supporting Safety Cases have been done, demonstrating that manufacturing long-lived SF/HLW disposal containers is feasible and can satisfy the safety-related requirements. In parallel, there is widespread interest in repository component optimisation. The systematic exploration of novel materials, while placing existing solutions in a broader context, can provide a solid state-of-the-art for the pursuit of container optimisation according to geologic, inventory and regulatory environments of each national programme. Furthermore, an improved ability to predict container lifetimes can reduce conservatism and support future Safety Cases.

The goal of WP ConCorD (Container Corrosion under Disposal conditions) is to explore the potential of container optimisation, focusing on long-term performance. Another goal is to improve available performance assessment tools, thus making canister lifetime prediction more accurate and robust. More specifically, ConCorD aims to:

- explore the performance optimisation potential of novel container materials and design within the engineered barrier system.
- Deepen the understanding of coupled interfacial processes influencing container performance under repository-relevant conditions, with a focus on:
  - irradiation-accelerated corrosion,
  - microbially-influenced corrosion,
  - corrosion during nearfield transients.
- Improve performance assessment by demonstrating a mechanistic understanding of relevant processes and developing accurate and robust predictive models.

## 2.1 Novel materials

The main goal is to explore the potential of novel materials and processes for optimising long-term container performance. After the first selection of the most promising materials, experimental studies contribute to understanding corrosion/degradation processes. The ongoing work is organised according to two main types of materials: ceramic and metallic materials.

For containers made of bulk ceramics, silica-alumina and silicon carbide are the most promising material options. The key properties for long-term performance are fracture toughness and leaching/alteration, while the key step in manufacturing is the final seal. Within ConCorD, the materials (core-shell ceramic glasses) and processes (microwave heating) for sealing silica-alumina containers are studied (see Fig. 1). The leaching properties of the seals are determined as well as the evolution of the mechanical properties of the assemblies before and after leaching in porewater. SiC doped with Cr is assessed as a bulk canister material, with a primary focus on determining the microstructure and physico-chemical properties of these new ceramic composites. Ceramics can also be employed as thin films acting as corrosion barriers to protect an underlying metallic substrate. In this application, a critical parameter for long-term performance would be the absence of porosity and defects. Research is focused on developing TiO<sub>2</sub> and CrN coatings deposited by physical vapour deposition (PVD). Corrosion tests can support material selection and validation of the application of ceramic coatings for SF/HLW containers.

In the field of metals, the focus is on implementing innovative solutions for metallic anti-corrosion coatings and optimised bulk metallic options. For metallic coatings, Ti, Cr and Cu obtained by PVD and novel copper/alumina composite coatings deposited by cold spray are developed and studied. The novelty of metallic/ceramic composite is the ability to use nitrogen as carrier gas and the expectation of decreased porosity and improved adhesion. For all coatings, deposition parameters optimisation is followed by corrosion studies performed in repository-relevant conditions. For bulk metals, the focus is on optimising bulk copper alloys for the KBS-3 concept and, more specifically, on the effect of impurities on corrosion properties. The uptake and diffusion of hydrogen and its interactions with the matrix and the possibility of micro-galvanic corrosion due to impurities are studied. The relationship between hydrogen diffusion into the matrix, creep rate, and SCC crack growth is assessed by complementary experimental testing and molecular dynamics (MD) simulations.

## 2.2 Corrosion under irradiation

The research done within ConCorD assess whether irradiation influences the corrosion of canister materials under disposal conditions. To reach this goal, it is necessary to identify the critical parameter that determines

the irradiation-induced material degradation. Once this is identified, appropriately designed irradiation-corrosion experiments under representative disposal conditions mimicking different periods of the typical repository evolution are performed.

For the identification of the critical irradiation parameter, experiments in simplified model systems that cover 4 orders of magnitude in dose rate leading to total doses spanning 2 orders of magnitude are ongoing. The experiments include unirradiated controls and explore carbon steel, copper and, to a limited extent, novel container materials. To complement the simple bulk solution environments, experiments are conducted in the presence of compacted bentonite, with different degrees of saturation, and over a range of temperatures. The expected outcome will be a definitive statement regarding the relative importance of dose rate and total dose on the corrosion behaviour of canister materials over various environmental conditions.

As a second step, conditions representative of the repository will be explored. More specifically, the potential influence of (i) the type of bentonite used, (ii) the nature of the irradiation source, (iii) the effect of saturation, and (iv) the dose rate at which there is no significant effect of irradiation.

### 2.3 Microbial effects on corrosion

The main goal is to elucidate the role of microbes in corrosion in the context of nuclear waste disposal. Sulfate-reducing bacteria have long been the focus of this type of investigation as their activity is expected to release sulfide. But a more comprehensive approach that includes molecular tools to probe the microbial community and targeted cultivation is needed, along with carefully designed experiments to isolate specific factors and document their impact on microbial activity and the resulting corrosion.

In particular, the topics addressed are: (i) how irradiation controls microbial survival in bentonite, (ii) the fundamental mechanisms underlying the dry threshold density that inhibits microbial activity, and (iii) the role of  $O_2$  persistence in the inhibition of the growth of sulfate-reducing bacteria in bentonite.

Previous work on irradiation and microorganisms (for instance, in MIND) has focused on the role of irradiation in changing the bioavailability of organic carbon in refractory compounds. In ConCorD, the goal is to evaluate the role of multiple stressors (including irradiation) on the activity and viability of microorganisms in bentonite. The aim is not necessarily to identify a survivability threshold but rather to decipher how repository conditions will impact the potential microbial generation of sulfide in bentonite. Of particular interest is the impact of dose rate vs. total dose on microbial activity and survival. The experimental system consists of compacted bentonites in which metal coupons are embedded and subjected to long-term low-dose or short-term high-dose irradiation. This work will allow the integration of the impact of irradiation on bentonite and on the corrosion of that microbial community. These experiments integrate microbial community

characterisation with the characterisation of the bentonite pre- and post-irradiation.

Furthermore, bentonite characteristics and their impact on microbial activity are tackled. It is well established that dry density correlates with microbial survival in bentonite, but the underlying mechanism constraining microbial activity is not well understood. Thus, several systematic experiments are carried out with varying dry densities. A cell containing compacted bentonite is exposed to  $H_2$ , and the bentonite microbial biomass is measured through a DNA concentration proxy to establish the dry density threshold at which no growth occurs. In addition, the particle size distribution will be varied for the same dry density to test the hypothesis that pore size distribution is a determinant of microbial growth. Characterisation of the rate of metal corrosion and the change in the microbial community will provide an understanding of the role of dry density in corrosion.

Previous work has shown that compacted bentonite exposed to an anoxic environment for several years still harbours a majority of viable aerobes while no sulfate-reducing bacteria are detected by molecular tools. Thus, the hypothesis is that oxygen persists in the pore space and/or on the surface of bentonite, allowing for the persistence of aerobes and inhibiting the growth of anaerobes such as sulfate-reducing bacteria. The goal is to evaluate the role of  $O_2$  in shaping microbial activity in bentonite. Bentonite that has undergone various treatments and in which metallic coupons are embedded can be deployed in situ. The bentonite pre-treatments will result in varying amounts of residual  $O_2$ , thus presumably impacting the growth of anaerobic microorganisms.

### 2.4 Corrosion under transients

As the durability of waste containers is strongly related to the evolution of the environmental conditions during the repository lifecycle, work is dedicated to corrosion during redox, hydraulic, and thermal nearfield transients. Those transients lead to chemo-mechanical interactions between the container material or coating (if present), corrosion products and buffer. The effect of evolving redox potential, chemical conditions, temperature, bentonite saturation and gas evolution, both in laboratory and in-situ, are the main key processes studied to address existing uncertainties and provide relevant experimental data to adequately account for these processes in performance assessment. The experiments are focused on the effect of representative processes, where at least one parameter can change with time. A systematically coordinated approach by the various partners allows the exploration of a wide range of conditions and container materials.

### 2.5 Integration

The main goal of this activity is the synthesis of the newly acquired knowledge into a form applicable for container performance assessment considering the specific needs of the Safety Cases developed by implementors. This will be based on the experimental evidence acquired in the research activities described above and the

modelling of the experimental observations of processes occurring at the container-oxide-buffer interface. This will demonstrate a mechanistic understanding of ongoing processes and support container lifetime predictions for traditional and novel materials. Integrating the experimental outputs leads to developing coupled models considering transient thermo-hydro-mechanical-chemical-biological phenomena at a relevant scale. This will be a supporting tool when integrating the container as a barrier in performance assessments, especially when addressing the relevant timescales and the probabilistic nature of the involved phenomena.

Further development of existing modelling frameworks will enable coupling geochemical models, solute transport, water radiolysis, heat transfer, variable saturation, microbial activity, and electrochemistry. They can be used to rationalise the data generated within the project with the intent to increase the system understanding of the interface between bentonite barriers and metals in a geological disposal framework.

Finally, to ensure that ConCorD outputs are useful for performance assessment performed by implementors, research output will be integrated with the broader scientific basis and the ongoing treatment of container degradation in performance assessment. The focus is on providing the technical steer and evaluating the implications highlighted by the coupled modelling activities described above using technical literature and considering how the relevant processes are treated in Safety Cases.

### 3 FUTURE – research towards fundamental understanding of radionuclide transport in crystalline and argillaceous rocks

The radiological impact of a repository is one of the central criteria for the safety assessment of repository systems. Reduced mobility of the radionuclides in porous media due to the tortuosity of the transport path and the strong interaction of radionuclides with mineral surfaces are the main pillars contributing to repository safety [1]. Low permeability argillaceous and crystalline rocks are considered appropriate geological formations for the deep underground disposal of spent fuel and high-level radioactive waste in several European countries. The work package FUTURE deals with radionuclide retention and transport in repository systems, with particular emphasis on processes and in situ conditions relevant for the near and far-field repository for high-level waste. Many disposal concepts foresee the disposal of high-level waste and spent fuel in thick-wall cast-iron casks surrounded by clay-rich buffer material. It is anticipated that corrosion processes in the repository nearfield will make an important contribution to the evolution of the in situ conditions in the repository nearfield at the time scale relevant for the corrosion-induced breaching of disposal casks followed, eventually, by the release of the radionuclides due to interaction with pore water. The scope of the work package FUTURE is specifically tuned to address these aspects from different research perspectives.

To address the safety relevant aspects of radionuclide retention, work-package FUTURE is thus organised into two main tasks: (1) MOBILITY, comprising work on diffusion-dominated mobility of radionuclides in compacted clay and the transport mechanism of radionuclides in crystalline rock, including reversible and irreversible sorption phenomena (2) REDOX, comprising work on redox reactivity of radionuclides on mineral surfaces. In particular, the surface-mediated redox reactions on iron oxides and Fe-rich minerals formed during corrosion processes are investigated.

Based on already available knowledge obtained in the past for the simplified “model” systems, the FUTURE project seeks fundamental insights into the impact of chemical boundary conditions and the role of microstructures on radionuclide speciation and mobility in “real” clay rocks as well as crystalline rocks. FUTURE aims at the quantitative and mechanistic understanding of the impact of (i) specific surface properties of materials (diffusive double layer, surface potential), (ii) the role of grain boundaries, (iii) the effect of water saturation, content and chemistry (pH, ionic strength) as well as (iv) the impact of pore size variability and heterogeneity on the mobility of chemical species. Our study delivers a refined understanding of the relation between fracture/pore structures and transport as well as the feedback of mineral reactions (dissolution/precipitation, clogging) on pore structure and connectivity. Eventually, the project closes knowledge gaps regarding sorption reversibility, uptake mechanisms (adsorption vs. incorporation, precipitation), sorption competition and surface diffusion. Particular focus is aimed at fundamental understanding and thus reducing uncertainties of surface-induced (heterogeneous) redox processes with regard to coupled sorption and electron transfer interface reactions governing the retention of redox-sensitive radionuclides at Fe(II)/Fe(III) bearing mineral surfaces.

#### 3.1 Chemical analogy and transferability of data from compacted to dispersed systems

Safety assessment scenarios considering pore water interaction with spent nuclear fuel indicate that  $^{226}\text{Ra}$  can become a main contributor to the total dose after  $10^4$ – $10^5$  years of waste disposal. Retention of  $^{226}\text{Ra}$  is often considered by co-precipitation or recrystallisation of Ba-sulfate minerals. It can be expected, however, that  $^{226}\text{Ra}$  is also absorbed by smectite minerals. Due to a limited number of experimental data, Ba is often used as a chemical analogue for  $^{226}\text{Ra}$ . To test the chemical analogy of Ba with respect to sorption behaviours of  $^{226}\text{Ra}$  on montmorillonite, a parallel set of experiments were carried out for Ba and  $^{226}\text{Ra}$  systems [2]. The experimental sorption isotherms obtained at fixed pH and ionic strength, as well as the pH edges at varying ionic strength, indicate that the assumption of the chemical analogy of  $^{226}\text{Ra}$  and Ba does not always hold for sorption on montmorillonite. Available experimental data could be modelled by a combination of cation exchange reactions which dominate the uptake in a broad range of chemical conditions, and a surface complexation reaction



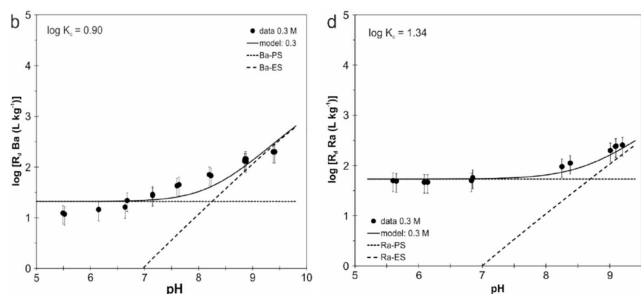

**Fig. 2.** Experimental and modelling results for pH-dependent sorption edges of Ba (left, b) and  $^{226}\text{Ra}$  (right, d) on *Na-SWy-2* in 0.3 M NaCl background electrolyte. Ra/Ba-PS = planar sites; Ra/Ba-ES = edge sites (modified after Klinkenberg et al. [2]).

on the amphoteric edge sites, which need to be considered to obtain the best-fit surface complexation constant at high ionic strength and high pH (Fig. 2).

Further ongoing research is focused on evaluating the interplay between the sorption and co-precipitation in reactive transport diffusion experiments conducted in compacted pure minerals and clay rocks (Opalinus and Callovo-Oxfordian Clays).

### 3.2 Role of particle orientation, porosity and mobility

Connectivity and geometry of pore space are critical factors controlling the diffusive mobility of radionuclides in clay samples. In the recent study [3], the role of the inter-particle and interlayer porosities, as well as the effect of the preferred particle orientation on water diffusion, was investigated by the combination of X-ray scattering and numerical pore-scale transport simulations using synthetic porous media representative for dual-porosity clayey rocks. Vermiculite was selected as an experimental proxy as it allows clear discrimination between the antiparticle and interlayer porosities thanks to the absence of osmotic swelling. Through diffusion and pulsed gradient spin, echo attenuation measurements by the nuclear magnetic resonance of protons were used to probe water mobility. At the same time, the orientation of the particles was quantified by X-ray scattering analysis. Experimental diffusion measurements were conducted for Na-vermiculite samples (swelling clay) and Na-kaolinite particles (non-swelling clay mineral) having only inter-particle porosities. The experimental measurements were used to test a model for Brownian dynamics with virtual porous media representative for the real clay samples. For the range of porosities investigated, a good agreement was observed between measured and simulated water mobility. The obtained results confirmed the pivotal role of the preferential particle orientation on the water dynamics in clayey media through an important reduction of overall water mobility between the isotropic and anisotropic samples. The obtained data also showed that for the same total porosity, the presence of interlayer porosity and associated nano-confinement led to a logical reduction in the pore diffusion coefficient of water. Moreover, the com-

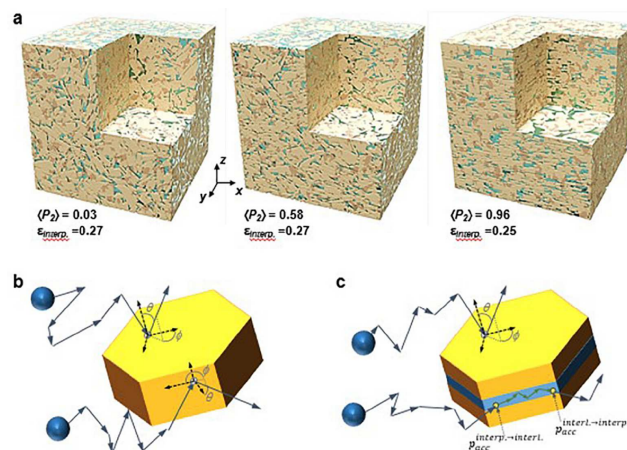

**Fig. 3.** (a) Development of synthetic porous media with similar interparticle porosity but different degree of anisotropy for particle orientation described by order parameter (i.e.,  $\langle P_2 \rangle$  order parameter). Illustration of Brownian dynamics characteristic to water in a Na-kaolinite (b) and Na-vermiculite (c). In contrast to interlayer, free kaolinite transport in vermiculite takes place in the intra-particle space and the interlayer (modified after Asaad et al. [3]).

puted results revealed that the anisotropy in water diffusion could be directly predicted based on the degree of particles' preferred orientation, irrespective of the total or the distribution of the different porosity types (Fig. 3).

### 3.3 Methodological development in high-resolution spectroscopy

X-ray absorption near edge structure (XANES) spectroscopy is a valuable tool for characterisation of chemical speciation of radionuclides. The spectroscopic technique allows for the identification of oxidation states and provides insight into the electronic structure, and coordination of ions in solution, in crystal structure or at the mineral-fluid interface. High metal loadings are often necessary to obtain EXAFS spectra with a sufficiently high signal-to-noise ratio (S/N). Poor data quality at low loading is often challenging for studies on actinides due to low solubility limits. A significant effort has been made to push the detection limits of the synchrotron-based measurements. Recently, it became possible to measure Np M5-edge HR-XANES spectra of a sample with  $\sim 1$  mg Np/g illite (1 ppm) [4]. These concentrations are up to several thousand times lower than typical Np loadings on mineral surfaces investigated by X-ray absorption spectroscopy. A newly designed cryogenic configuration enables sampling temperatures as low as  $141.2 \pm 1.5$  K and is shown to be successful at preventing beam-induced changes in the Np oxidation state (Fig. 4).

### 3.4 Retention by solid solutions

Dissolution-precipitation reactions in porous media change the availability of pore space for the transport

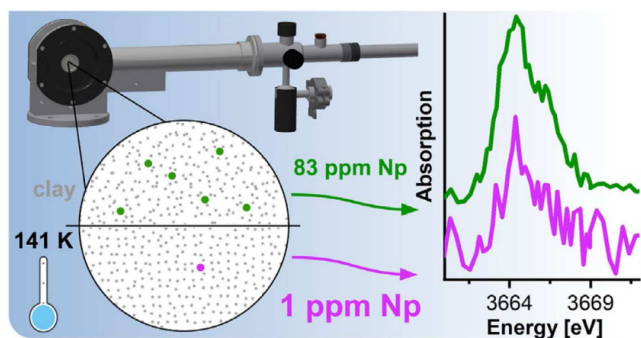
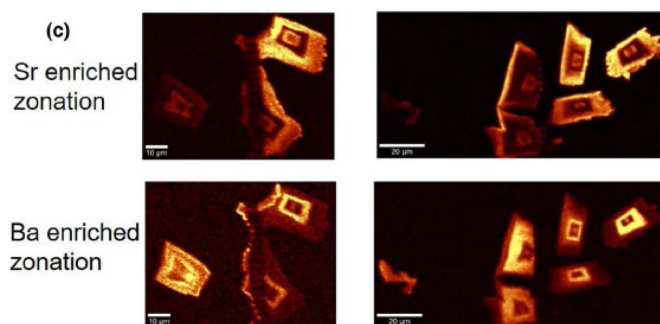

**Fig. 4.** M5-edge HR-XANES spectra of Np absorbed on illite at  $(83 \pm 2 \text{ ppm})$  and  $(1.24 \pm 0.04 \text{ ppm})$  loading recorded at  $141.2 \pm 1.5 \text{ K}$  at newly developed setup at ACT station of the CAT-ACT beamline at the KIT Light Source (adapted after Schacherl et al. [4]).

of solutes as well as contribute to the retention and release of radionuclides. Recent studies indicate that crystallisation pathway and its mechanism in porous media may substantially deviate from the behaviour observed in bulk macroscopic solutions with a high liquid to solid ratio. In particular, the nucleation rate and saturation depend strongly on the pore dimensions, surface energy of mineral-fluid interface and transport regime of solute. With the recent development of in-operando microfluidic experiments and reactive transport modelling, it has become feasible to gauge the driving forces of transport-coupled geochemical processes. With the help of a “lab-on-a-chip” experiment, nucleation and growth of oscillatory-zoned  $(\text{Ba},\text{Sr})\text{SO}_4$  crystals in a microfluidic reactor (Fig. 5) were investigated by combining laboratory experiment and numerical reactive transport simulations [5]. Analysis of the obtained results suggests that the composition of the nucleating phases can be well described by classical nucleation theory, whereas the oscillatory zoning is controlled by the interplay of diffusion-limited transport of solutes and the nucleation kinetics.

#### 4 CORI – research to improve understanding of cement-organic-radionuclide interactions

The work package CORI in EURAD improves the knowledge of the organic release issues, which can accelerate the radionuclide migration in the context of the post-closure phase of geological repositories for ILW and LLW/VLLW, including surface/shallow disposal. CORI addresses topics in the context of cement-organic-radionuclide interactions. Organic materials are present in some nuclear waste and as admixtures in cement-based materials and can potentially influence the performance of a geological disposal system, especially in the context of L/ILW disposal. This potential effect of organic molecules is caused by the formation of complexes in solution with radionuclides of interest (actinides and lanthanides, but also other metal cations like Ni) which can potentially increase the



**Fig. 5.** Chemical zoning in Barite-Celestite solid solution crystallised diffusion controlled microfluidic experiment (modified after Poonoosamy et al. [5]).

radionuclide solubility and/or decrease radionuclide sorption. Organic substances require increased attention since a significant quantity exists in the waste and the cementitious materials, with a large degree of chemical diversity. Cement-based materials will be degraded with time in the context of waste disposal, inducing a large range of alkaline pH conditions according to their degradation stage. Alkaline pH provides specific conditions under which the organics can degrade, which contributes to increasing their potential impact on repository performance. CORI does not study related topics like microbial degradation of organics, bituminised waste, iron corrosion in cementitious environments, the conditioning of waste in cement materials or studies on natural organics present in certain host rocks. Studies primarily targeting deriving new thermodynamic data for databases are not included, although it is acknowledged that complete and reliable thermodynamic data and databases are essential. These topics may provide input to define future joint research projects.

CORI research builds up systematically on three main topics (tasks) increasing in the number of components and hence complexity, (i) organics degradation, (ii) organics-cement interactions, and (iii) radionuclides-organics-cement interactions. The research progress in these areas, together with selected highlights to exemplify scientific and technical methodology, is discussed in the following. The initial State-of-the-Art document prepared by CORI is available [6].

##### 4.1 Organics degradation

Focus is put on the characterisation of soluble organic species generated by radiolytic and hydrolytic degradation of selected organics (PVC, cellulose, resins, superplasticisers). Studies also include the analysis of the degradation/stability of small organic molecules such as carboxylic acids. Determination of degradation rates of polymeric materials and small molecular weight molecules are also performed.

Currently, work in CORI is mainly focused on the characterisation of materials as well as the hydrolytic/radiolytic degradation experimental program. Several partners have finished irradiation experiments, and the

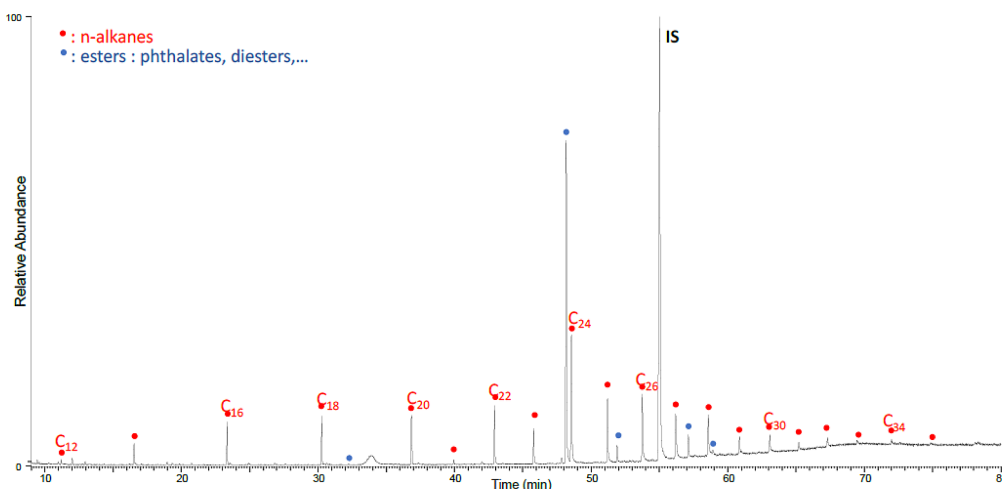

**Fig. 6.** GC-MS spectra of a PVC industrial sample (PVC 1), indicating the presence of alkanes among the additives (courtesy of Le Milbeau et al. [ISTO/BRGM]).

first results of the radiolytic degradation of cellulose and PCE on the related gas production are available. The characterisation of organic species released in solution has been started for cellulose and PAN resins. For PAN, rather slow hydrolytic degradation kinetics were observed.

An example is shown from the studies performed on PVC materials by ISTO/BRGM. The analysis of the initial products was conducted by ISTO/BRGM by combining chemical analyses, XRD, GC-MS and  $^1\text{H}$  NMR. For the pure phases, the results are consistent with the theoretical properties and compositions. For the industrial PVC products, the analyses reveal the presence of several additives; in the case of PVC1, the presence of both n-alkanes (average C number: 22), phthalates (DEHP, DINP) and adipates (2-ethylhexyl adipate) was detected (see Fig. 6) and calcite identified by XRD.

The main results from organics degradation studies are expected for the last two years of CORI and will be documented in the final SOTA document to be prepared by CORI.

## 4.2 Organic-cement interactions

Studies focus on investigating the mobility of selected organic molecules in cement-based materials. Assessment of the mobility of organic molecules includes studies on retention and transport properties. Organics are selected in view of expected relevance and include small  $^{14}\text{C}$  bearing molecules as identified in the previous EC-funded project CAST. Both retentions on individual cement phases and actual cementitious systems are investigated. Analysing the fate of the organics in cementitious environments is a key requirement for understanding and modelling the radionuclide behaviour in single and complex systems.

Sorption properties are measured for various organic molecules (formate, acetate, oxalate, adipate, glutaric acid, butyric acid derivatives, phthalate, citrate, gluconate, isosaccharinic acid (ISA), EDTA, NTA and superplasticiser materials) by the CORI partners. Sorption tests

are performed on HCP with various cement types. Some studies investigated surface properties, particularly the zeta potential, on pure solid phases such as C-S-H, ettringite or portlandite. The information on surface properties can help to understand the sorption mechanism from a phenomenological point of view.

Figure 7 presents the zeta potential evolution as a function of ISA concentration measured by CIEMAT (Spain). In the range of ISA concentration ( $<10^{-3}$  M), the impact of ISA on zeta potential seems not to be significant, in particular for portlandite and ettringite, for which the sorption was found almost zero.

In addition, EDTA, NTA, citrate, gluconate and other low molecular weight organics, such as formate and acetate, are studied in CORI. The general trend points out the notable sorption of EDTA and Gluconate in the cement-based materials, while the low molecular weight organics are weakly sorbed. Selected sorption measurements are performed with selected superplasticisers: polycarboxylate, modified melamine, and polycarboxylate ether (PCE). First tests showed significant sorption on HCP and C-S-H, respectively.

Studies in CORI also include diffusion or electrodiffusion tests for evaluating the transport properties of the various organic molecules in cement-based materials. As the diffusion process is very slow and experiments ongoing, no results are presented at present.

## 4.3 Radionuclide-organic-cement interactions

Processes of radionuclide retention and migration are studied in the ternary system, containing cement and organics, but also radionuclides. The role of organic molecules on the transfer properties of radionuclides is investigated through retention and transport experiments, covering a range of experimental conditions. Selected radionuclides cover a range of chemical characteristics and redox states relevant to the expected conditions in L/ILW disposal.

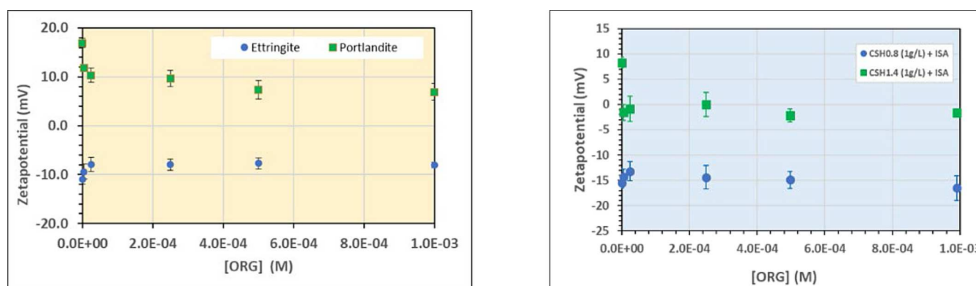

**Fig. 7.** Zeta potential measurements as a function of ISA concentration ( $[ORG]$ ) on portlandite and ettringite (left) and C-S-H ( $C/S = 0.8$  and  $1.4$ ) (right). (courtesy of Missana et al. [CIEMAT]).

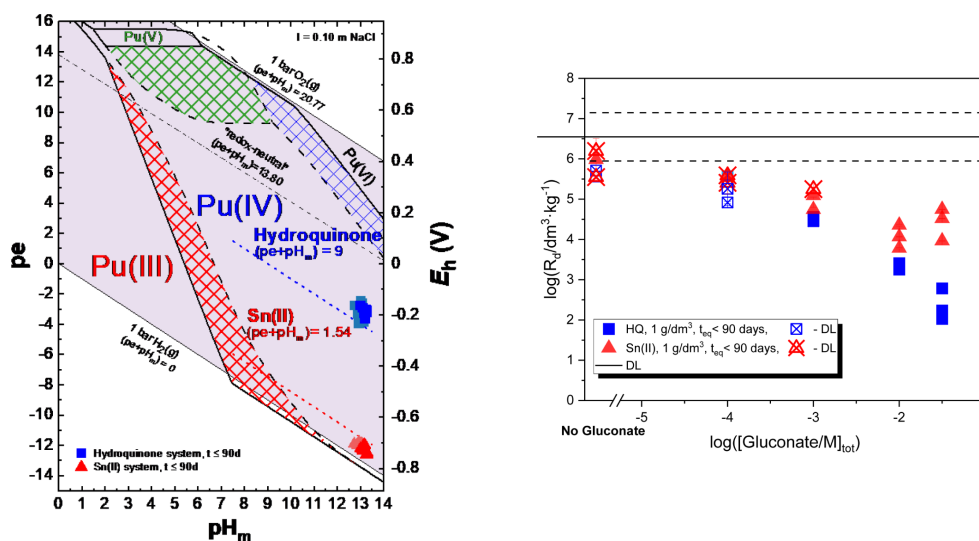

**Fig. 8.** Left: experimental ( $pe + pH_m$ ) values determined for the Pu samples containing hydroquinone (HQ, blue symbols) or Sn(II) (red symbols) as redox buffers. Right:  $R_d$  values determined for the uptake of Pu by C-S-H 1.4 in the absence and presence of gluconate at  $pH = 13.3$ . All experiments performed at  $S:L = 1 \text{ g dm}^{-3}$ . DL stands for detection limit (courtesy of R. Guidone et al. Empa (Switzerland) and KIT (Germany)).

The main radionuclides of interest are U(VI), Ni(II), Pb(II), as well as An(III/IV) and their inactive chemical homologues. The experimental programme is comprehensive and includes studies on solubility/speciation, retention and transport studies in different cement minerals (CSH, CASH, AFm, portlandite) and hardened cement pastes in different degradation stages. Some partners perform selected experiments using the reference cement material (RCM) prepared in CORI. The organics analysed by the different organisations consider a variety of ligands, including chelating agents like EDTA, gluconate (GLU), NTA; cellulose degradation products as isosaccharinic acid (ISA) or homologues; ion exchange resins (IER) or representative degradation products (GTA, HIBA, HBA); carboxylic acids, formate (FOR), citrate (CIT), adipate (ADI), dioctyl adipate (DOA), phthalate (PHT), dioctyl terephthalate (DOTP), Tri methyl amine (TrMeA) and organic cement additives as superplasticisers (SPs).

Figure 8 shows studies by Empa (Switzerland) and KIT (Germany). The impact of gluconate on the uptake of Pu by C-S-H phases was investigated in the presence of hydroquinone (HQ) and Sn(II), which buffer the redox conditions at  $(pe + pH_m) \approx 9$  and  $\approx 1.5$ . As shown on

the left of Figure 8, Pu(IV) is expected to prevail in the mildly reducing conditions set by HQ (blue squares in the figure), whereas the very reducing conditions imposed by Sn(II) result in  $(pe + pH_m)$  values close to the borderline Pu(IV)/Pu(III) calculated in the absence of gluconate.

The right side of Figure 8 shows that the uptake of Pu by C-S-H decreases at  $[GLU]_{tot} \geq 10^{-4} \text{ M}$ , in line with data previously reported for Th(IV). This observation supports the formation of stable ternary or quaternary complexes  $(Ca-)Pu-OH-GLU$  in the aqueous phase. The differences observed for the uptake in systems containing HQ or Sn(II) as redox buffers underpin that the reduction of Pu(IV) to Pu(III) is also feasible in hyperalkaline systems and highlights the need to undertake experiments with plutonium beyond the use of redox-stable analogues such as Th(IV) or Eu(III).

Systems analysed in CORI by the different organisations in radionuclide transport and diffusion studies include several types of hardened cement pastes (HCP). Several degradation stages are investigated, using both through-diffusion (TD) and in-diffusion (ID) tests. The organic ligands and radionuclides match those discussed above.



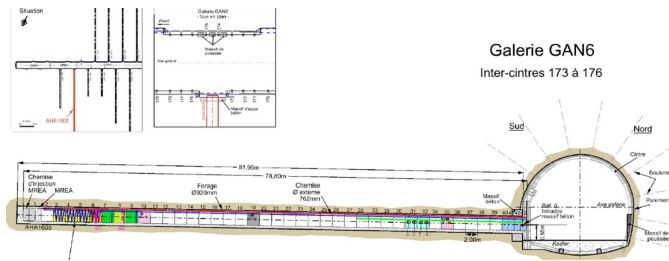

**Fig. 9.** Scheme of the AHA1605 in situ HLW disposal cell demonstrator in Bure URL (Andra).

#### 4.4 CORI expected impact

The specific new scientific results from WP CORI provide new quantitative and qualitative data and process understanding to support RWMD implementation needs and safety. CORI will perform a systematic evaluation of its impact at the end of the project, in close exchange with the CORI User Group and WMOs.

Issues of interest at the repository scale related to *implementation needs* are (i) improved scientific basis for the Safety Case for L/ILW waste repositories featuring relevant organics content, (ii) co-disposal of waste: support decisions regarding the question of whether or not a mix of various wastes (organics, soluble salts, exothermic waste) can be foreseen, (iii) optimisation of vault design in view of limitations on interactions between the vaults regarding their content. CORI provides information on the organic plume by characterising the transfer behaviour in cement-based materials and contributes to the optimization of concrete formulations as regards the potential effect of superplasticisers on radionuclide transfer properties. Regarding *safety*, there are likewise several implications related to (i) characterising the effect of the organic plume on the behaviour of radionuclides in terms of solubility (limitation of solubility increase), (ii) assessing sorption (limitation of retention decrease) in terms of  $K_d$  values, and (iii) analysing the retention of potentially  $^{14}\text{C}$ -bearing organic molecules (determined in CAST project) in cementitious environments in the case of specific wastes. CORI research reduces the uncertainties in the current knowledge (mainly based on  $K_d$  values) and improves the knowledge of the known organic molecules present in degradation solutions (not considered so far) with their complexing properties. This contributes to a better understanding of the impact of the organic inventory on nuclide mobility (geological and surface repositories).

## 5 MODATS – MOnitoring equipment and DAta Treatment for Safe repository operation and staged closure

The successful implementation of geological disposal of radioactive waste relies on the technical aspects of a sound safety strategy and scientific and engineering excellence, as well as on societal aspects such as stakeholder acceptance and confidence/trust. A key argument in interna-

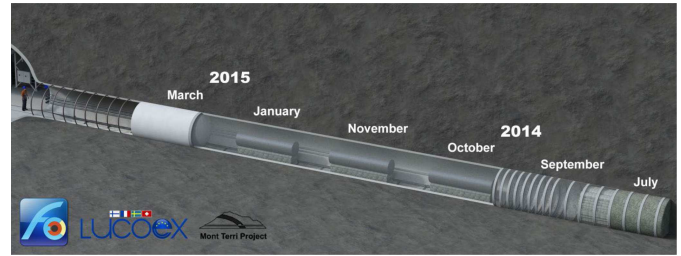
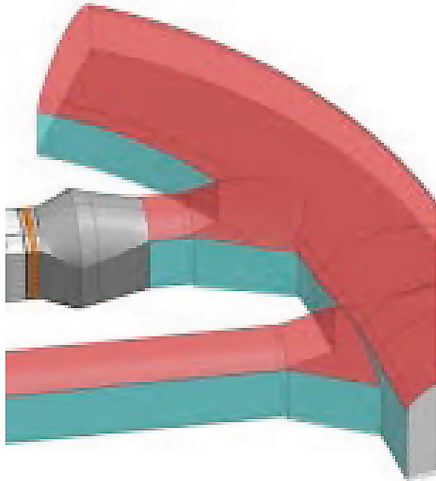

**Fig. 10.** Full-scale Emplacement (FE) Experiment at the Mont Terri URL (Nagra).

tional guidance and national programmes has been that monitoring can significantly contribute to both technical and social aspects of successful repository implementation. Monitoring is a broad subject, and monitoring within a radioactive waste management programme can encompass many different objectives and activities. These objectives and activities include technical and non-technical aspects. Repository monitoring is a more narrow discipline within this wider context and is related to monitoring the features, events and processes (FEPs) affecting the behaviour of a geological disposal facility.

MODATS is working to consolidate the implementation strategy for monitoring systems by developing methods through which confidence can be demonstrated in the data acquired and benefits derived from repository implementation. To develop this ambition, the WP undertakes R&D in data acquisition, data management and presentation, and the use of data in system understanding. This R&D is supported by information from existing case studies, including five reference experiments:

- **AHA1605 (Andra)**, (see Fig. 9): AHA1605 is an in situ HLW disposal cell demonstrator in Andra's Bure underground research laboratory (URL) dedicated to the demonstration and evaluation of the monitoring system for the HLW disposal cells in Cigeo. The experiment was installed in mid-2019. In this demonstrator, 80 m of the liner is instrumented in order to prove Andra's capacity to monitor thermo-mechanical and chemical parameters of a complete HLW disposal cell.
- **FE (Nagra)** (see Fig. 10): the Full-scale Emplacement (FE) Experiment at the Mont Terri URL simulates aspects of the construction, waste emplacement, backfilling and early-stage evolution of an SF/HLW repository tunnel in a clay-rich formation (Opalinus Clay), using heaters in place of SF/HLW canisters. The heating of the experiment commenced in December 2014. The entire experiment implementation and the post-emplacement THM evolution are monitored using several hundred sensors. Some monitoring of gas concentration is also undertaken. The sensors are distributed in the nearfield and the host rock, on the tunnel lining, in the buffer and tunnel plug, and on the heaters. FE is underpinned by extensive THM modelling, several years of monitoring data and a database of monitoring results.
- **POPLU (POSIVA)** (see Fig. 11): the POPLU experiment is a full-scale test of a possible design of a disposal tunnel end plug component of the disposal concept



**Fig. 11.** Schematic representation of a full-scale test of a possible design of a disposal tunnel end plug component by the POPLU experiment (Posiva).

for the spent fuel repository in Olkiluoto (Finland) and Forsmark (Sweden). The plug was constructed in 2015, and pressurisation commenced in January 2016. The POPLU experiment was extensively monitored to detect a range of thermo-hydro-mechanical processes.

- **Prototype Repository (SKB)** (see Fig. 12): the Prototype Repository is a full-scale field experiment in crystalline rock at a depth of 450 m in the Äspö Hard Rock Laboratory. The experiment aims to simulate conditions largely relevant to the Swedish/Finnish KBS-3V disposal concept for spent nuclear fuel. The 64 m long experimental tunnel contains six deposition holes and many full-scale copper canisters surrounded by an MX-80 bentonite buffer. The test tunnel was divided into two separate sections. The inner section, with four deposition holes, has been operated since 2001 and the outer section, with two deposition holes, since 2003. Each section was backfilled with a mixture of bentonite (30% by weight) and crushed rock (70% by weight) and finally sealed by reinforced concrete dome plugs. The outer part of the experiment was dismantled during 2010–2011.
- **PRACLAY (EURIDICE)** (see Fig. 13): the PRACLAY experiment is a large-scale experiment designed to study the impact of the heat generated by high-level waste on the host clay formation. It also looks at how excavation affects the behaviour of the clay. The experiment is located in the HADES URL (Mol, Belgium) in a dedicated 40 m long gallery simulating a waste disposal gallery. Heating started at the end of 2014 following construction, ventilation and saturation phases. The target temperature (80 °C at the gallery lining extrados) was reached nine months later and is planned to last for (at least) 10 years. In addition, a gallery seal allows for maintaining the hydraulic boundary conditions. The focus is on the behaviour of the host clay. The most important parameters monitored are temperature and pore water pressure. Numerical modelling complements the experimental part.

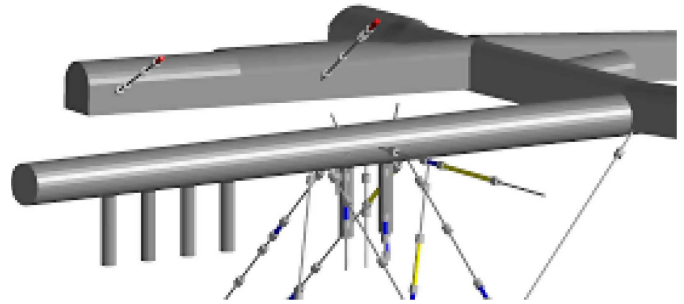

**Fig. 12.** The Prototype Repository is a full-scale field experiment in crystalline rock at a depth of 450 m in the Äspö Hard Rock Laboratory (SKB).

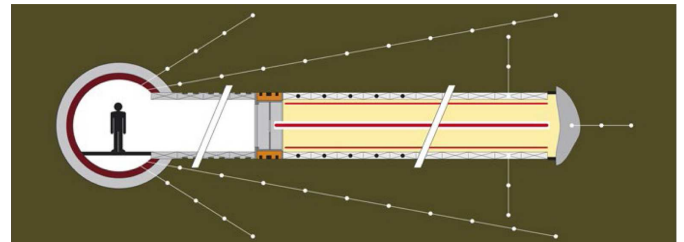

**Fig. 13.** Schematic representation of the PRACLAY experiment located in the HADES URL (EURIDICE).

### 5.1 Data treatment for increased confidence in repository monitoring

The overarching goals of monitoring a radioactive waste repository are to provide information to support decision-making and to strengthen understanding of some aspects of system behaviour. Based on the reference experiments, MODATS wants to address methods to collect, treat and analyse data that will strengthen system understanding, especially since repository monitoring will be spatially and temporally limited. Repository monitoring also presents challenges related to evaluating multi-modal data, i.e. data that is measured by different sensors, resulting in a range of independent parameters, at different locations and at varying spatial and temporal sampling. These data need to be evaluated in a coherent way that considers the specifics of sensors and their spatial relationships and allows for the identification of anomalies related to sensor ageing and malfunction, outside influences, and deviations of the repository system from expected behaviour. MODATS wants to consolidate the implementation strategy for monitoring systems in repository facilities by developing methods through which confidence can be demonstrated in the acquired data and its analysis and benefits derived from repository implementation (see Fig. 14).

### 5.2 Novel and optimised monitoring technology for repository monitoring

The requirements for sensing methods to monitor waste repositories are quite unique. Monitoring must not interfere with EBS integrity and not

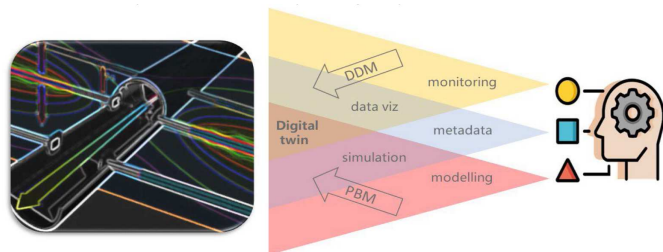

**Fig. 14.** Schematic visualisation of the repository monitoring strategy developed in MODATS with the data-driven model (DDM) and the physics-based model (PBM).

jeopardise the long-term safety of a repository. The MoDeRn Project successfully developed and analysed the capabilities of monitoring technologies for future repository use in the fields of measurement techniques and probes, data transmission methods and energy supply (see [7]). The Modern2020 project accelerated the technological development of a tailored system for geological disposal in a way that was not seen before in order to move from the state-of-the-art to the proof of concept and demonstration phase. With this ambition, Modern2020 explored a large number of innovative methods and techniques for developing useful tools and assessing the monitoring strategies in an appropriate way.

New and emerging sensing methods may change the paradigm of monitoring waste repositories. To push forward what is possible in terms of monitoring, it is crucial to stay abreast with the technological development to apply and adapt emerging technologies to waste repository monitoring and develop new technologies suitable for the specific requirements of repository monitoring. In addition, we develop new methods that extract signals from the data through signal processing, joint inversion schemes and other techniques specific to the monitoring methods. In Task 3 of MODATS, the following actions are ongoing:

- research and further develop innovative sensors and geophysical techniques to measure and infer parameters that are difficult to obtain for long-term monitoring.
- Develop and qualify optical sensors to get them ready to be used in the initial phase of the development of the geological disposal for temperature and strain measurement.
- Develop methods to investigate the impact of monitoring technology on the performance of a range of disposal systems.

## 6 Conclusion

Besides the scientific and technical results and progress discussed above for each of the WPs, general aspects regarding the expected impact of the research performed in CONCORD, FUTURE, CORI, and MODATS are discussed in the following.

The key impact of the research will be the generation of new scientific information. Results provide an improved

technical basis for the Nuclear Waste Disposal Safety Case. This includes new qualitative and quantitative data characterising the various systems studied and, in most cases, also significantly improves the scientific process and system understanding. Combining the most advanced complementary of state-of-the-art analytical and spectroscopic tools, key information is derived on a molecular level and up-scaled for performance assessment studies. All WPs include modelling of results and offer potential links to further modelling activities in EURAD and beyond. New materials are tested and evaluated regarding performance and potential usability, and detailed concepts for monitoring repository evolution are developed, evaluated and tested. All the new information generated in CONCORD, FUTURE, CORI and MODATS will support the member states regarding decision-making and planning within their respective national programs.

To ensure high visibility and usability of the research performed in the WPs presented in this contribution, a dynamic dissemination strategy is realised both on a European and international level. The target is to provide information and scientific arguments to support activities contributing to the final disposal of nuclear waste, explicitly addressing different stakeholders. The technical/scientific results are first made available as open access peer-reviewed publications. Results also feed into the State-of-the-Art documents defined as public deliverables in all four WPs, which are currently available in the initial form at the EURAD website for download. The WPs are actively contributing to knowledge management tools established in EURAD, for instance, by authoring State-of-Knowledge documentation, contributing to the population of the WIKI information system currently established or organising joint training events and workshops. The EURAD KM strategy offers a new quality of dissemination to ensure long-term access to the scientific and technical results generated in technical WPs like CONCORD, FUTURE, CORI, and MODATS.

The experimental and modelling work by the EURAD WPs presented here is, to a significant extent, performed by young researchers and within Ph.D. theses. This contributes to the availability of highly trained specialists for implementers, regulators and research entities throughout Europe. EURAD contributes to European integration by bringing together experts from several European member states. The involvement of experts coming from countries at very different stages of implementation likewise poses a positive achievement, for instance, in view of sharing expertise and resources in Europe and integrating new member states.

## Acknowledgements

The authors want to thank all the respective WP partners, Task Leaders, User Group members and the EURAD PMO for the successful joint collaborative effort.

## Conflict of interests

The authors declare that they have no competing interests to report.

## Funding

The projects described in this paper have received funding from the European Union's Horizon 2020 research and innovation programme under grant agreement No. 847593.

## Data availability statement

This overview article has no associated data generated to be disclosed.

## Author contribution statement

All authors have contributed equally to this publication. N. Diomidis has prepared the section on CONCORD, S. Churakov the section on FUTURE, M. Altmaier the section on CORI and J. Bertrand the section on MODATS.

## References

1. S.V. Churakov, W. Hummel, M. Marques Fernandes, Fundamental research on radiochemistry of geological nuclear waste disposal, *CHIMIA Int. J. Chem.* **74**, 1000 (2020).
2. M. Klinkenberg, F. Brandt, B. Baeyens, D. Bosbach, M. Marques, Adsorption of barium and radium on montmorillonite: A comparative experimental and modelling study, *Appl. Geochem.* **135**, 105117 (2021)
3. A. Asaad, F. Hubert, E. Ferrage, T. Dabat, E. Paineau, P. Porion, S. Savoye, B. Gregoire, B. Dazas, A. Delville, E. Tertre, Role of interlayer porosity and particle organization in the diffusion of water in swelling clays, *Appl. Clay Sci.* **207**, 106089 (2021)
4. B. Schacherl, C. Joseph, P. Lavrova, A. Beck, C. Reitz, T. Pruessmann, D. Fellhauer, J. Lee, K. Dardenne, J. Rothe, H. Geckeis, T. Vitova, Paving the way for examination of coupled redox/solid-liquid interface reactions: 1 ppm Np adsorbed on clay studied by Np M5-edge HR-XANES spectroscopy, *Anal. Chim. Acta* **1202**, 339636 (2022)
5. J. Poonosamy, M. Mahrous, E. Curti, D. Bosbach, G. Deissmann, S.V. Churakov, T. Geisler, N. Prasianakis, lab-on-a-chip approach integrating in-situ characterization and reactive transport modelling diagnostics to unravel (Ba, Sr)SO<sub>4</sub> oscillatory zoning. *Scientific Reports* **11**, 23678, *Anal. Chim. Acta* **1202**, 339636 (2022)
6. CORI SOTA, The initial State-of-the-Art report prepared by CORI in EURAD is available at: <https://www.ejp-eurad.eu/publications/eurad-deliverable-31-cori-sota-cement-organic-radionuclide-interactions-content-lilw> (2021)
7. MoDeRn, State of Art Report on Monitoring Technology. MoDeRn Project Deliverable D2.2.2 (2013)

**Cite this article as:** Marcus Altmaier, Johan Bertrand, Sergey Churakov, and Nikitas Diomidis. Long-term radionuclide retention in the near field: collaborative R&D studies within EURAD focusing on container optimisation, mobility, mechanisms and monitoring, *EPJ Nuclear Sci. Technol.* **8**, 27 (2022)