

UNIVERSIDAD COMPLUTENSE DE MADRID
FACULTAD DE CIENCIAS MATEMÁTICAS
DEPARTAMENTO DE GEOMETRÍA Y TOPOLOGÍA



ON THE DYNAMICS OF HOMEOMORPHISMS AROUND FIXED POINTS
IN LOW DIMENSIÓN

SOBRE LA DINÁMICA DE HOMEOMORFISMOS EN TORNO A PUNTOS
FIJOS EN DIMENSIÓN BAJA

TESIS DOCTORAL DE:

LUIS HERNÁNDEZ CORBATO

BAJO LA DIRECCIÓN DE:

FRANCISCO ROMERO RUIZ DEL PORTAL

Madrid, 2013

**On the dynamics of homeomorphisms
around fixed points in low dimension**

**Sobre la dinámica de homeomorfismos
en torno a puntos fijos en dimensión baja**

Memoria presentada para optar al grado
de Doctor en Ciencias Matemáticas por

Luis Hernández Corbato



Dirigida por D. Francisco Romero Ruiz del Portal
Departamento de Geometría y Topología
Facultad de Ciencias Matemáticas
Universidad Complutense de Madrid

Madrid, 2013

Agradecimientos

Las primeras líneas están dedicadas a mi director de tesis, Paco. Le agradezco sus orientaciones y consejos, tanto los matemáticos como los que se alejan de la ciencia, las innumerables discusiones en la pizarra y todo el empeño que ha puesto en la tarea de guiarme durante estos años. Su dedicación y pasión por las matemáticas son ejemplares y han sido fundamentales para que este barco llegara a buen puerto. Me siento privilegiado por toda la atención y el apoyo que me ha prestado.

Es menester dar las gracias al Departamento de Geometría y Topología y a la Facultad de Matemáticas de la Universidad Complutense. No sólo han cubierto todas las necesidades básicas que un estudiante de doctorado puede precisar sino que me han permitido disfrutar de mis primeras experiencias como docente universitario. Al Ministerio le debo agradecer la beca FPU que me concedieron para realizar esta tesis y gracias a la cual he subsistido durante cuatro años.

Quiero agradecer a Patrice concederme la oportunidad de ir a París, al Institut de Mathématiques de Jussieu. Sus grandes cualidades tanto humanas como matemáticas han hecho que aprender y trabajar con él haya sido una experiencia fantástica. Mis estancias en París bajo su tutela han sido claves para el desarrollo de la tesis. Mi tercera y última estancia predoctoral, en Río, fue también muy enriquecedora. Desde aquí doy las gracias a Andrés y a Enrique por su cercanía, disposición y voluntad.

Creo que es buen momento para recordar a quienes estuvieron involucrados en mis primeros e inocentes pasos dentro de esta ciencia, hace ya algunos años. Por ello, además de a mis padres, quiero expresar mi gratitud, entre otros, a María, Josep, Marco, Merche y Joaquín.

Gracias a todos mis amigos por los muchos buenos ratos que hemos disfrutado durante este tiempo, en las situaciones más variopintas: molestando en algún despacho, en los seminarios de lectura, compartiendo un café de superhéroe, en un agujero de gusano, viendo un partido, tomando unas raciones, unas cañas, unas pizzas, jugando a la pocha o a lo que tocara o simplemente comentando la jugada. Mención especial para aquellos que están o han estado fuera, y que en sus visitas me han acompañado. Es precisamente lejos de casa cuando más se agradece la compañía y por eso quiero aquí acordarme de todos los buenos amigos con los que compartí vivencias tanto en París como en Río, gracias a los cuales se me hicieron más llevaderas las estancias.

A mis padres y hermano, gracias por vuestra paciencia, comprensión y por estar siempre ahí cuando he necesitado ayuda. Gracias también a mi tía y abuelas por vuestro cariño.

Tengo la suerte de haber podido recorrer este largo camino muy bien acompañado. Laura, gracias por soportarme y por tu apoyo incondicional.

Contents

Summary	i
Resumen	xi
1 Rotation numbers for planar attractors	1
1.1 Introduction	1
1.2 Preliminaries	4
1.2.1 Rotation number	4
1.2.2 Denjoy homeomorphisms	5
1.2.3 Prime end theory	8
1.3 Setting and previous results	10
1.4 Example of maps with irrational rotation number	11
1.5 Irrational rotations do not appear on prime ends	19
1.6 About the existence of periodic points	23
1.6.1 Partial converse result	23
1.6.2 Counterexample to the conjecture	26
2 Fixed point index and the Conley index	31
2.1 Introduction	31
2.1.1 Algebraic invariants in dynamical systems	31
2.1.2 Statement of the results	33
2.1.3 Fixed point index results	39
2.2 Preliminaries	40
2.2.1 Fixed point index	40
2.2.2 Shift equivalence	43
2.2.3 Permutation endomorphisms	46
2.2.4 Acyclic continua	48
2.2.5 Isolating blocks and filtration pairs	49
2.2.6 Conley index and Lefschetz-Dold Theorem	52
2.2.7 Attractors, repellers and nilpotence	54
2.3 Fixed point index for continuous maps in \mathbb{R}^2	57
2.3.1 Statement of the theorem	57
2.3.2 Splitting and nilpotence arguments	59
2.3.3 Characterization of fixed point index sequences	61
2.3.4 Realization of all possible sequences	64
2.4 Some questions around discrete Conley index theory	65

2.4.1	Around the definition	65
2.4.2	Another approach to the discrete Conley index	71
2.4.3	On the connectedness of $\overline{N \setminus L}$	73
2.4.4	Duality	77
2.5	Main results	81
2.5.1	Statement of the key theorem and proofs	81
2.5.2	A toy model: a radial case	83
2.5.3	Realizing all possible sequences $\{i(f^n, p)\}_{n \geq 1}$	85
2.5.4	Proof I: Construction of a suitable pair	87
2.5.5	Proof II: Nilpotence	89
2.5.6	Proof III: Definition of φ , description of $\tilde{f}_{*,1}$	90
2.5.7	Proof IV: Introducing the stable set	91
2.5.8	Proof V: Gathering all dynamical information closer to the unstable set	92
2.5.9	Proof VI: Higher-dimensional homological decomposition	93
2.6	Further remarks	95
2.7	Local zeta function	97

Summary

Introduction

The work on celestial mechanics by Henri Poincaré in the end of the 19th century was the starting point of the theory of dynamical systems. Even though in its origin it was developed as a branch of the study of differential equations, this theory quickly gained interest by itself. On the one hand, there exist a great amount of evolutive processes whose description does not adjust to the language of differential equations, though the notion of dynamical system is broad enough to encompass them. On the other hand, analytical methods developed to study differential equations proved to have limited scope and geometrical and topological techniques appeared out of necessity for the study of dynamics. During the 20th century, the work of renowned mathematicians contributed to raise the importance of dynamical systems and made connections with other areas of mathematics.

This work belongs to the area of topological dynamics, as most of our discussions are purely topological. As a rule of thumb, dynamics subject of study are not smooth, nor we care about whether they preserve a measure. The type of evolution followed by our systems is discrete and time independent. In other words, we consider autonomous dynamical systems generated by the iteration of a map. As one of the simplest possible kinds of evolution, it provides more freedom for the dynamics and, in return, more difficulties for its study. Although the title of our work is vague on purpose, we restrict virtually all our discussion to dimensions 2 and 3, where topological obstructions prevent the existence of certain discrete dynamics.

In dimension 1, discrete dynamical systems have trivial descriptions as long as the generating map is invertible or, equivalently, they are time reversible. Otherwise, their behavior may be very complicated, as an example see the bifurcation diagram of the quadratic family of maps in the unit interval. There is a wide literature dealing with dynamics generated surfaces homeomorphisms. Several techniques which are specific to dimension 2 have been successfully applied to obtain powerful results. Perhaps one of the first results in this direction is the so-called Brouwer's Lemma of translation arcs [Br12, Br84]. It states that for planar orientation-preserving homeomorphisms, the existence of a recurrent point implies that of a fixed point. In particular, any periodic orbit "encloses" a fixed point, much alike an invariant circle bounds a closed disk which always contains a fixed point, by Brouwer's fixed point Theorem. Prime end theory, used in the first chapter of this dissertation, is another example of a planar technique employed in the study of surface dynamics. Understanding the dynamics, even in the case of flows, becomes much more difficult in dimension 3 and higher, as the topology of

the phase space does not pose so many restrictions.

The task of studying a particular dynamical system in great detail is typically twofold. First, a careful selection of pieces of the dynamics are examined locally. Then, one has to specify how these pieces are glued to compose the global picture. Some of the great contributions by Morse, Smale or Conley to dynamical systems share this motivation. For the local study, typically one starts with neighborhoods of fixed points, periodic orbits or other minimal sets, as they are dynamically indecomposable pieces. For example, in the discrete case, hyperbolic fixed points of diffeomorphisms have trivial local dynamics, as Hartman-Grobman's Theorem implies the map is locally conjugate to a linear map in a neighborhood of the fixed point. However, in a more general setting the task of classifying local dynamics often becomes hard, either because of a rich structure of the sets (e.g. horseshoes, whose dynamics require a symbolic description) or because of the lack of smoothness or hyperbolicity of the dynamics. Let us stress that only in the most simple cases the local study leads to a full knowledge of the possible dynamics. An example of such a classification is the one of circle homeomorphisms by Poincaré.

Since obtaining a complete classification in dynamics, and in mathematics in general, is usually an unrealistic goal, one aims to develop tools to distinguish between different objects as finely as possible. Often, one searches for suitable invariants so that if they are not equal for the objects being compared we automatically deduce that the objects are different. Our work focus on three invariants of topological nature which are assigned to some kind of invariant sets and are related to their local dynamical behavior. It should be stressed that we are not interested in describing the dynamics within the invariant set but in a neighborhood of it. In fact, some of these invariants are more suitably defined for small neighborhoods of the invariant sets than for the invariant set themselves. This is the case of the fixed point index and the Conley index, center of our discussion in Chapter 2. Furthermore, both indices satisfy a continuation property which implies they are invariant under small perturbations of the dynamics.

Objectives

The main purpose of this work was to study some features of the local behavior of discrete dynamical systems generated by homeomorphisms around fixed points in \mathbb{R}^2 and \mathbb{R}^3 . In the first part, we deal with attracting fixed points in the plane of a particular class of homeomorphisms, denoted \mathcal{H}_0 , and we aim to make a link between the rotation number associated to the attracting point and the existence of periodic orbits. Thus, we study whether the rotation number somehow links local and global dynamical behavior. In the second part, we focus on the fixed point index of orientation-reversing homeomorphisms of \mathbb{R}^3 . There seems to exist a connection between the pattern followed by the index of fixed points which are isolated as invariant sets for orientation-preserving homeomorphisms and the one of orientation-reversing homeomorphisms in one dimension higher. Since the former is well understood in dimension 2, our objective was to study the latter and examine whether this link between dimension 2 and 3 exists.

The dynamics around an attracting fixed point of a planar homeomorphism has a very simple description. Kérékjarto [Ke34] showed that it is conjugate to that of one of the maps $z \mapsto \frac{1}{2}z$ or $z \mapsto \frac{1}{2}\bar{z}$, defined in $\mathbb{C} \sim \mathbb{R}^2$. The basin of attraction U of the fixed point

is a simply connected domain in the plane whose boundary may have a very complicated structure, possibly not locally connected at any point. Prime end theory, developed by Carathéodory [Ca13], provides a nice compactification of the region of attraction with a circle such that the planar homeomorphism naturally induces a homeomorphism h^* in the circle of prime ends of U , \mathbb{P} . Then, the rotation number of h^* is associated to the attracting fixed point and denoted $\rho(h, U)$. The notation includes the region U and not the point p as the rotation number is defined in general for any simply connected invariant domain U , regardless of whether it is the basin of attraction of a fixed point. The first article which shares this technique is due to Birkhoff [Bi32]. Note that the rotation number $\rho(h, U)$ is a topological invariant.

Poincaré's classification of circle homeomorphisms shows how the classical rotation number, for circles, is related to the existence of periodic orbits. For planar homeomorphisms h and simply connected domains U , it was already noticed by Cartwright and Littlewood in [CL54] that $\rho(h, U)$ and the existence of periodic orbits in the boundary of U are not trivially linked. Additional hypothesis are needed in order to obtain a connection between the two notions. For instance, see [CL54], if the map is area-preserving a rational rotation number implies the existence of periodic points in ∂U . There are several results in the literature in this direction, for instance [AY92, BG91, BG92, BaK98]. In the reverse direction some results have been recently obtained in [KLN12]. Examples of maps and basins with irrational $\rho(h, U)$ can be found in [Ha82, W91, Mat13]. In our work, we require the homeomorphism to be dissipative and the region U to be unbounded. As a consequence, there is a repelling fixed point at ∞ and there are orbits connecting ∞ with the attracting fixed point. The class of homeomorphisms satisfying the previous hypothesis is denoted \mathcal{H}_0 . The case $\rho(h, U) \in \mathbb{Q}$ was studied in [OR11], where the authors obtained the following result:

Theorem 1 (Ortega-Ruiz del Portal). *Any map $h \in \mathcal{H}_0$ with $\rho(h, U) \in \mathbb{Q}$ has at least one periodic orbit outside U .*

In view of the previous theorem, it is natural to wonder whether the rotation number characterizes the existence of periodic orbits outside U .

Question 2. *Does $\rho(h, U) \notin \mathbb{Q}$ imply that there is no periodic orbit in $\mathbb{R}^2 \setminus U$?*

The study of the irrational case is the task we face in the first part of this work. It involves the construction of a family of examples, understanding the induced dynamics in the prime ends given by $h^* : \mathbb{P} \rightarrow \mathbb{P}$ and then giving an answer to the previous question.

The fixed point index is another topological invariant that appears frequently in discrete dynamical systems. It is a measure of the multiplicity of a fixed point. Perhaps the most important feature of this local index is formulated in Lefschetz Theorem: the sum of the indices of the fixed points of a map of a finite polyhedron is a global topological invariant of the map and the homology of the ambient space, the Lefschetz number. In the continuous case, dynamics of flows instead of maps, the link between local indices and global topology is even more clear from the Poincaré-Hopf Theorem, which states that the sum of the indices of the equilibrium points is the Euler characteristic of the space. Notice that in the discrete case, besides from the topology of the ambient space, we need some information about the map to define the invariant. This kind of extra

requirement is key also to understand the gap between continuous and discrete versions of the Conley index.

The fixed point index is particularly simple for hyperbolic fixed points, it is equal to -1 or 1 , and can be computed in some other situations. Consequently, it has been used as a way to ensure the existence of fixed or periodic points of a map, or estimate their number, in terms of the topology of the phase space, for instance in [SS74, Fr77, CMY83, BB92, FL100, MW07, GL108]. However, we are not interested in global results but in how the index of a single fixed point behaves. It is well-known that the fixed point indices of a map and its iterates satisfy some congruences, called in the literature Dold's relations or congruences [Do83]. However, already in dimension 2 the index of a fixed point of a homeomorphism f may attain any integer value so we have to add some extra hypothesis. If the fixed point p is assumed to be isolated, not only within the set of fixed points but as an invariant set, its fixed point index exhibits some restrictions. Le Calvez and Yoccoz [LY97], in the orientation-preserving case, and later Ruiz del Portal and Salazar [RS02], in the orientation-reversing case, proved that

$$i(f, p) \leq 1 \tag{1}$$

and gave also a precise description of the sequence $\{i(f^n, p)\}_{n \geq 1}$. It is worth noting that Bonino [Bo02] proved that the previous inequality holds for orientation-reversing homeomorphisms even if the fixed point is not isolated as an invariant set. The knowledge of the index allows to infer features of the local dynamics, see for example [L99] and [RS05]. On a side note, an index which refines fixed point index and makes a connection between local and global dynamics has been defined by Le Roux in [LR10].

In view of (1) and the perception that the behavior of the index for orientation-reversing homeomorphisms in \mathbb{R}^3 may be connected with the behavior in the planar case, we aimed to prove, or disprove, the following conjecture:

Conjecture 3. *If f is an orientation-reversing homeomorphism in \mathbb{R}^3 and p is a fixed point isolated as an invariant set, then*

$$i(f, p) \leq 1.$$

It was already proved in [LRS10] that the sequence $\{i(f^n, p)\}_{n \geq 1}$ is always periodic for homeomorphisms of \mathbb{R}^3 , regardless of the orientation of f . Besides, any periodic sequence which satisfies Dold's congruences is realizable as the fixed point index sequence of an isolated fixed point of an orientation-preserving homeomorphism of \mathbb{R}^3 .

The assumption on the isolation of the fixed point as an invariant set allows to use Conley index to encapsulate the local dynamics around the fixed point. This technique have been previously successfully applied in [Fr99, LY, RS02, LRS10] to compute the fixed point index in different settings. The first author who pointed out the relationship with the discrete Conley index was Mrozek [Mr89]. Basically, the fixed point index is the Lefschetz number of any index map that represents the homological (or cohomological) discrete Conley index.

This interpretation of the fixed point index in terms of the Conley index allows to examine previous works from another perspective. For example, the results on the fixed point index of planar homeomorphisms were ultimately describing the behavior of the first discrete Conley index in that setting. The problem which appears in higher dimensions

is that the next Conley indices are more difficult to describe. A little help is provided by the duality for the discrete Conley index which was first proved by Szymczak [Sz98].

Theorem 4. *Given an isolated invariant set X of a homeomorphism f in \mathbb{R}^d and an integer $0 \leq r \leq d$, the r -cohomological discrete Conley index of X for f is dual (up to sign) to the $(d - r)$ -cohomological discrete Conley index of X for f^{-1} .*

Therefore, a complete description of the first Conley index for homeomorphisms of \mathbb{R}^3 also describes the second one, of codimension 1. As a consequence, we may deduce fixed point index results in dimension 3.

Although the fixed point index sequence of isolated fixed points in the plane is characterized for homeomorphisms, describing its behavior for continuous maps is still an open problem. In [GNR11] some partial results have been obtained, but the arguments are apparently flawed so it was still legitimate to ask:

Question 5. *Is there any characterization for the fixed point index sequence $\{i(f^n, p)\}_{n \geq 1}$ of fixed points isolated as invariant sets for continuous maps in \mathbb{R}^2 ?*

Results

The first chapter of this dissertation deals with the class \mathcal{H}_0 of dissipative orientation-preserving planar homeomorphisms with an attracting fixed point whose basin of attraction is unbounded. Most of the results in the chapter are already published in [HOR12].

Since we study the case in which the rotation number $\rho(h, U)$ is irrational, the first step is to show that the subfamily of such homeomorphisms is not empty. In particular, we prove that for every Denjoy map ϕ of the circle with irrational rotation number ω , there exists a homeomorphism $h \in \mathcal{H}_0$ such that the induced map in the prime ends of U , $h^* : \mathbb{P} \rightarrow \mathbb{P}$, is conjugate to ϕ and, in particular, $\rho(h, U) = \omega$. Section 1.4 introduces two families of homeomorphisms which are qualitatively quite different. The dynamics described by the first family presents a region of attraction U which has disconnected boundary in \mathbb{R}^2 and such that the point at ∞ is (infinitively) accessible from U . The basins U of the second family have connected boundary in \mathbb{R}^2 and the point at ∞ is not accessible from them. The dynamics induced in the set of prime ends is, in all the examples presented, a Denjoy map. As we prove in Section 1.2.2 this is not a mere coincidence:

Theorem 6. *Assume that $h \in \mathcal{H}_0$ and the rotation number $\rho(h, U)$ is irrational. Then, the induced map $h^* : \mathbb{P} \rightarrow \mathbb{P}$ is a Denjoy homeomorphism.*

Once the dynamics in the prime ends has been examined, we are ready to address Question 2: on whether the existence of periodic orbits in $\mathbb{R}^2 \setminus U$ implies $\rho(h, U) \in \mathbb{Q}$ or, equivalently, if an irrational $\rho(h, U)$ implies the non-existence of other periodic orbits than the fixed point in U . A partial positive answer is proved in Section 1.6:

Theorem 7. *Assume ∞ is accessible from U and $\rho(h, U) \notin \mathbb{Q}$. Then, there are no periodic orbits in $\mathbb{R}^2 \setminus U$.*

Nevertheless, in general, the answer to Question 2 is negative. The last pages of the chapter show how to define a map $h \in \mathcal{H}_0$ with irrational rotation number and a fixed point outside U . This counterexample can be easily generalized to have an arbitrary prescribed number of fixed and periodic points. The construction starts with a radial definition of the map which is then twisted in an area-preserving fashion. This last modification ensures that the basin of attraction of the fixed point is still unbounded while providing many fixed points outside it. Finally, the point at ∞ is transformed into a local repeller to ensure dissipativity. A more general family of different counterexamples has been found simultaneously by Matsumoto [Mat13].

The second chapter of this text deals with fixed point index and Conley index. Most of the results are contained in [HCR13]. Conjecture 3 was found to be true and we managed to prove the following theorem:

Theorem 8. *Suppose that f is a local orientation-reversing homeomorphism of \mathbb{R}^3 and p a fixed point isolated as an invariant set. Then,*

$$i(f, p) \leq 1.$$

Furthermore, we give a complete characterization of the fixed point index sequences $\{i(f^n, p)\}_{n \geq 1}$ under the previous hypothesis: they are periodic, satisfy Dold's congruences and agree with some inequalities which only involve the odd terms of the sequence. The proof of this characterization involves the construction of an orientation-reversing homeomorphism of S^2 having a prescribed number of periodic orbits.

From Theorem 8 we obtain a remarkable corollary:

Corollary 9. *There are no orientation-reversing minimal homeomorphisms of \mathbb{R}^3 .*

In general, the problem about the existence of minimal homeomorphisms is open. Partial answers are known. For instance, any 2-sphere with finitely many punctures does not admit minimal homeomorphisms, see [Ha92, LY97]. On the contrary, it was proved in [FH77] that there exist minimal homeomorphisms in any manifold over which S^1 acts freely, such as n -torus or odd spheres. As far as we know, Corollary 9 is the first result which addresses some particular case in \mathbb{R}^n for $n > 2$.

The fact that the invariant set under study is a fixed point is not essential. In fact, in our arguments we mainly use that the invariant set is trivial from a homological point of view. Therefore, in most of the results we can replace the fixed point p by an invariant acyclic continua X . In Chapter 2 the results are stated in maximum generality.

The intermediate arguments and results which allow to prove Theorem 8 are interesting on their own. Despite the statement involves only fixed point index, its proof truly belongs to Conley index theory. In this work we take the approach of Franks and Richerson [FR00] to define the discrete Conley index. Other former approaches are contained in [RS88, Mr90, Sz95]. Given any isolated invariant set X , there exist a filtration pair (N, L) which can be used to encapsulate the local dynamics around X in the following sense:

- $N \setminus L$ isolates X and f induces a map $\bar{f} : N/L \rightarrow N/L$, called index map, which is locally conjugate to f in a neighborhood of X .

The index map \bar{f} induces an action in the relative homology groups

$$\bar{f}_* : H_*(N, L, \mathbb{Q}) \rightarrow H_*(N, L, \mathbb{Q})$$

whose Leray reduction is independent of the choice of pair (N, L) . The r -th homological discrete Conley index of X (for f) is defined as the equivalence class of linear maps up to conjugation of their Leray reductions which contains \bar{f}_r and is denoted $h_r(f, X)$. Applying Lefschetz-Dold Theorem to the map \bar{f} as in [Mr89] we obtain

$$i(f, X) = \sum_{r \geq 0} (-1)^r \text{trace}(h_r(f, X))$$

and the same formula holds if we replace f by f^n . This equation shows how bounds on the trace of the homological indices may lead to prove an inequality for the fixed point index.

Firstly, we obtain a description of the first homological discrete Conley index, $h_1(f, X)$. Its behavior is very similar to the linearization of a permutation. We prove a formula for the traces of its iterates, which encloses all the information about the spectrum except the multiplicity of 0.

Theorem 10. *Let f be a local map of \mathbb{R}^d and X an isolated invariant acyclic continuum which is not a repeller. There exists a finite set J and a map $\varphi : J \rightarrow J$ such that, for $n \geq 1$,*

$$\text{trace}(h_1(f^n, X)) = -1 + \#\text{Fix}(\varphi^n).$$

In particular, $\text{trace}(h_1(f, X)) \geq -1$. Note that this result does not assume that the dynamics is invertible. The map $\varphi : J \rightarrow J$ codifies the way the connected components of L , neighborhood of the exit set of the N , are permuted by the action of f . This action dominates the behavior of higher dimensional homological indices in the following sense: if $u : V \rightarrow V$ is a representative of $h_r(f, X)$, $r > 1$, there exists a decomposition of V in vector subspaces which are permuted by u in an equivalent way as the action of φ . In particular, we obtain the following theorem:

Theorem 11. *Let f be a local map of \mathbb{R}^d and X an isolated invariant acyclic continuum which is not a repeller. If $\text{trace}(h_1(f, X)) = -1$ then $\text{trace}(h_r(f, X)) = 0$ for any $r > 1$.*

Note the previous two theorems and the duality for the discrete Conley index are enough to prove Theorem 8. All the proofs of these results are contained in Section 2.5.

A great amount of technical issues had been solved throughout the proofs. One of the most remarkable ones concerns connectedness. In principle, given a filtration pair (N, L) , the set $\overline{N \setminus L}$ is not necessarily connected even if the invariant set X is connected. Denote S the connected component of $\overline{N \setminus L}$ that contains the connected invariant set X . The dynamics also induces an index map, \tilde{f} , in the quotient space $\tilde{N}/(\tilde{N} \setminus \tilde{S})$, and it is natural to wonder about the relationship between the maps \bar{f} and \tilde{f} . In the proof of Theorem 10, we show that the spectra of their induced actions in the relative homology groups are equal, except for the eigenvalue 0. However, we managed to generalize the previous observation for homeomorphisms, the maps \bar{f} and \tilde{f} are shift equivalent in the sense of [FR00].

An easy corollary of Theorem 10 is the characterization of the possible fixed point index sequences realized by isolated fixed points of continuous local maps in \mathbb{R}^2 . However, we present in Section 2.3 an almost self-contained proof which uses a simple version of the techniques which lead to Theorem 8.

Theorem 12. *Let f be a local map of \mathbb{R}^2 and p a fixed point isolated as an invariant set which is not a repeller. Then,*

$$i(f, p) \leq 1$$

and the sequence $\{i(f^n, p)\}$ is periodic.

As in the case of Theorem 8, the general statement of this result provides a complete characterization of the possible fixed point sequences, which, besides periodic, must satisfy some inequalities.

Conclusions

The topological study of the dynamics created by homeomorphisms of the class \mathcal{H}_0 initiated in [OR11] has been successfully concluded in this work. It is not surprising that only Denjoy maps can appear in the prime end dynamics, as if the dynamics were minimal there would be points in the boundary of U whose positive orbit goes close to ∞ and that is prevented by the dissipativity. The answer given to Question 2 has not been fully satisfactory. One would like to establish a two-way bridge between existence of periodic points in $\mathbb{R}^2 \setminus U$ and rationality of the rotation number of $\rho(h, U)$, for $h \in \mathcal{H}_0$. However, the final outcome is not unexpected, as one typically needs additional hypothesis to relate a periodic behavior in the prime ends with periodic orbits for the dynamics. Thus, it seems plausible that adding some extra hypothesis would make the question have a positive answer. A very frequent hypothesis which apparently fits well in our framework is asking the map to be area contracting. Notice that the basin of an attracting fixed point of an area contracting map is automatically unbounded. This question is partially related to the Markus-Yamabe conjecture, whose original statements in the continuous and discrete case have already been solved [MY60, BL96, CE⁺95], but some of its versions are still open.

The content of the second part of the thesis has filled some gaps in the knowledge of the fixed point indices of fixed points isolated as invariant sets for maps in \mathbb{R}^d . In Section 2.6 of Chapter 2 we define an example of an isolated fixed point of an orientation-reversing homeomorphism of \mathbb{R}^4 with unbounded fixed point index sequence. An orientation-preserving example had been already introduced in [LRS10]. As dimension increases, not many restrictions for the fixed point index sequence sequences are expected. The same conclusion applies for continuous maps, after the characterization found in the plane it is clear that an analogous result will not hold in dimension 3.

Some of the ideas which appear in Chapter 2 may be applied in other settings. Theorem 10, which was a first step towards the proof of Theorem 8, is interesting on its own as it is the first result which describes with precision the homological Conley index. Another interesting point to notice is the geometrical meaning of the inequality of Theorem 8. One may think of the gap between -1 and the trace of the first homological index as the number of branches of the local unstable set that are invariant by the

dynamics, provided they are properly defined. Under this interpretation, from Theorems [10](#) and [11](#) we deduce that for locally defined homeomorphisms in \mathbb{R}^3 either a stable or an unstable branch, to say the least, are invariant. This statement is a very surprising, yet very informal, statement which may have subsequent applications in arguments of global nature.

Resumen

Introducción

Los trabajos sobre mecánica celeste de Henri Poincaré al final del siglo XIX fueron el punto de partida de la teoría de sistemas dinámicos. Aunque en su origen creciera como una rama del estudio de las ecuaciones diferenciales, esta teoría rápidamente ganó interés por sí misma. Por un lado, existe una gran cantidad de procesos evolutivos cuya descripción no se ajusta al lenguaje de las ecuaciones diferenciales, pero el concepto de sistema dinámico es suficientemente amplio como para englobarlos. Por otro lado, se comprobó que los métodos analíticos desarrollados para el estudio de las ecuaciones diferenciales tenían una aplicación limitada y surgieron por necesidad técnicas geométricas y topológicas para el estudio de la dinámica. Durante el siglo XX, el trabajo de importantes matemáticos contribuyó al crecimiento de los sistemas dinámicos y consiguió conectarlos con otras áreas de las matemáticas.

Este trabajo se encuadra en el área de la dinámica topológica, dado que la mayoría de nuestras consideraciones son puramente topológicas. Como norma general, las dinámicas sujetas a estudio no son diferenciables, ni tampoco es relevante si conservan alguna medida. El tipo de evolución que presentan nuestros sistemas es discreto e independiente del tiempo. En otras palabras, consideramos sistemas dinámicos autónomos generados por la iteración de una aplicación. Al ser una de las formas más simples de evolución posibles, permite más libertad para la dinámica y, como consecuencia, ésta es más difícil de estudiar. Aunque el título de esta memoria es deliberadamente vago, prácticamente toda la discusión se ciñe a dimensiones 2 y 3, donde surgen obstrucciones topológicas que impiden la existencia de ciertas dinámicas.

En dimensión 1, los sistemas dinámicos discretos tienen descripciones triviales cuando la función que los genera es invertible o, equivalentemente, son reversibles en el tiempo. En otro caso, su comportamiento puede ser muy complicado, para muestra obsérvese el diagrama de bifurcación de la familia cuadrática de aplicaciones definidas en el intervalo unidad. Existe una amplia literatura sobre dinámica generada por homeomorfismos de superficies. Algunas técnicas propias de dimensión 2 se han aplicado con éxito para obtener potentes resultados. Quizá uno de los primeros resultados en este sentido es el Lema de Brouwer sobre arcos de traslación [Br12, Br84]. Prueba que para homeomorfismos del plano que conservan orientación la existencia de un punto recurrente implica la existencia de un punto fijo. En particular, cualquier órbita periódica “encierra” un punto fijo, de la misma manera que una circunferencia invariante limita un disco que contiene un punto fijo, por el Teorema del punto fijo de Brouwer. La teoría de finales primos, usada en el primer capítulo de esta memoria, es otro ejemplo de técnica propia

del plano que se utiliza con éxito en el estudio de la dinámica en superficies. Comprender la dinámica, incluso en el caso de flujos, se torna mucho más complicado en dimensión 3 y superior, puesto que la topología del espacio de fases no impone tantas restricciones.

La tarea de describir con detalle un cierto sistema dinámico suele dividirse en dos. Primero, se hace un estudio local de algunas partes de la dinámica. Luego, hay que especificar cómo esas partes se pegan para obtener el retrato global. Algunas de las mejores contribuciones de Morse, Smale o Conley al estudio de los sistemas dinámicos compartieron esta motivación. Para el estudio local, típicamente uno comienza con entornos de puntos fijos, órbitas periódicas u otros conjuntos minimales, dado que son indivisibles desde el punto de vista dinámico. Por ejemplo, en el caso discreto, los puntos fijos hiperbólicos de difeomorfismos presentan una dinámica local trivial, ya que por el Teorema de Hartman-Grobman la función es conjugada a una aplicación lineal en un entorno del punto fijo. Sin embargo, en un contexto más general la tarea de clasificar las dinámicas locales es a menudo difícil, ya sea por una estructura rica del conjunto invariante (p.ej. herraduras, cuya dinámica precisa una descripción simbólica) o por la falta de diferenciabilidad o hiperbolicidad de la dinámica. Es conveniente subrayar que sólo en las situaciones más sencillas un estudio local completo permite describir todas las posibles dinámicas. Ejemplo de una clasificación así es la de homeomorfismos de la circunferencia, obra de Poincaré.

Dado que obtener una clasificación completa en dinámica, y en matemáticas en general, suele ser prácticamente una utopía, los esfuerzos se centran en desarrollar herramientas que permitan distinguir entre objetos diferentes de la manera más precisa posible. En muchas ocasiones, se buscan invariantes adecuados de manera que si son distintos para los objetos que se comparan entonces automáticamente se deduce que dichos objetos son diferentes. Nuestro trabajo se centra en tres invariantes de naturaleza topológica que se asignan a ciertos tipos de conjuntos invariantes y miden algunos aspectos de sus dinámicas locales. Es conveniente destacar que no estamos interesados en describir la dinámica dentro del conjunto invariante sino en una vecindad suya. De hecho, alguno de estos invariantes se definen de forma más adecuada para entornos de los conjuntos invariantes que para los propios conjuntos invariantes. Éste es el caso del índice de punto fijo y el índice de Conley, centro de nuestra discusión en el Capítulo 2. Además, ambos índices satisfacen una propiedad de continuación que implica que son invariantes bajo perturbaciones de la dinámica.

Objetivos

El principal propósito de este trabajo es estudiar ciertos aspectos del comportamiento local de sistemas dinámicos generados por homeomorfismos alrededor de puntos fijos en \mathbb{R}^2 y \mathbb{R}^3 . En la primera parte, trabajamos con puntos fijos atractivos en el plano para una familia de homeomorfismos, denotada \mathcal{H}_0 , y pretendemos establecer una conexión entre el número de rotación asociado al punto fijo atractivo y la existencia de órbitas periódicas. Por tanto, se investiga si el número de rotación asocia de alguna manera un comportamiento local con la dinámica global. En la segunda parte, nos centramos en el índice de punto fijo de homeomorfismos de \mathbb{R}^3 que invierten orientación. Parece que existe una conexión entre el patrón que sigue el índice de puntos fijos aislados como conjuntos

invariantes de homeomorfismos que conservan orientación y el de homeomorfismos que invierten orientación en una dimensión superior. Dado que el comportamiento de los primeros se conoce bien en dimensión 2, nuestro objetivo es estudiar los segundos y decidir si este vínculo entre dimensiones 2 y 3 existe.

La dinámica alrededor de un punto fijo atractivo de un homeomorfismo del plano tiene una descripción muy simple. Kérékjarto [Ke34] probó que es conjugada a la de una de las aplicaciones $z \mapsto \frac{1}{2}z$ o $z \mapsto \frac{1}{2}\bar{z}$, definidas en $\mathbb{C} \sim \mathbb{R}^2$. La cuenca de atracción U del punto fijo es un dominio simplemente conexo del plano cuya frontera puede tener una estructura muy complicada, por ejemplo puede no ser localmente conexa en ningún punto. La teoría de finales primos, desarrollada por Carathéodory [Ca13], proporciona una compactificación de la región de atracción con una circunferencia de manera que el homeomorfismo del plano induce un homeomorfismo h^* en la circunferencia de finales primos de U , \mathbb{P} . Entonces, se asocia el número de rotación de h^* al punto fijo atractivo y se denota $\rho(h, U)$. La notación incluye la región U y no el punto p puesto que el número de rotación está definido en general para cualquier dominio simplemente conexo e invariante, sea o no la cuenca de atracción de un punto fijo. El primer artículo que desarrolla esta idea fue obra de Birkhoff [Bi32]. Notemos que el número de rotación $\rho(h, U)$ es un invariante topológico.

La clasificación de Poincaré de homeomorfismos de la circunferencia muestra cómo el número de rotación clásico, para circunferencias, está relacionado con la existencia de puntos periódicos. Para homeomorfismos del plano h y dominios simplemente conexos U , Cartwright y Littlewood en [CL54] destacaron que $\rho(h, U)$ y la existencia de órbitas periódicas en la frontera de U no están ligados de manera directa. Se necesita alguna hipótesis extra para establecer una conexión entre ambos. Por ejemplo, véase [CL54], si la aplicación conserva área un número de rotación racional implica la existencia de órbitas periódicas en ∂U . En la literatura se pueden encontrar varios resultados en esta dirección, por ejemplo [AY92, BG91, BG92, BaK98]. En el sentido contrario algunos resultados han sido recientemente obtenidos en [KLN12]. Ejemplos de aplicación y cuencas de atracción con $\rho(h, U) \notin \mathbb{Q}$ pueden encontrarse en [Ha82, W91, Mat13]. En nuestro trabajo, pedimos al homeomorfismo que sea disipativo y a la región U que no sea acotada. Como consecuencia, tenemos un punto fijo repulsivo en ∞ y aparecen órbitas que conectan ∞ con el punto fijo atractivo. La familia de homeomorfismos que satisfacen las hipótesis anteriores se denota \mathcal{H}_0 . El caso $\rho(h, U) \in \mathbb{Q}$ fue estudiado en [OR11], donde los autores obtuvieron el siguiente resultado:

Teorema 1 (Ortega-Ruiz del Portal). *Cualquier homeomorfismo $h \in \mathcal{H}_0$ con número de rotación $\rho(h, U) \in \mathbb{Q}$ tiene por lo menos una órbita periódica fuera de U .*

A la vista del teorema anterior, es natural preguntarse si el número de rotación caracteriza la existencia de órbitas periódicas fuera de U .

Pregunta 2. *Supongamos que $\rho(h, U) \notin \mathbb{Q}$, ¿existen necesariamente órbitas periódicas en $\mathbb{R}^2 \setminus U$?*

El estudio del caso irracional es la tarea que llevamos a cabo en el primer capítulo de este trabajo. Comprende la construcción de una familia de ejemplos, entender la dinámica inducida en los finales primos dada por $h^* : \mathbb{P} \rightarrow \mathbb{P}$ y, entonces, dar una respuesta a la pregunta anterior.

El índice de punto fijo es otro invariante topológico que aparece con frecuencia en sistemas dinámicos discretos. Mide la multiplicidad de un punto fijo. Quizá la característica más importante de este índice local viene recogida en el Teorema de Lefschetz: la suma de los índices de los puntos fijos de una aplicación definida en un poliedro finito es un invariante topológico global de la aplicación y la homología del espacio, el número de Lefschetz. En el caso continuo, donde la dinámica viene representada por un flujo y no generada por una aplicación, el vínculo entre índices locales y topología global es incluso más claro a la vista del Teorema de Poincaré-Hopf, que dice que la suma de los índices de los puntos de equilibrio es la característica de Euler del espacio. Nótese que en el caso discreto, además de la topología del espacio ambiente se necesita información sobre la aplicación para establecer el invariante. Este tipo de requisito adicional es clave también para entender el salto entre las versiones continua y discreta del índice de Conley.

El índice de punto fijo es particularmente simple para puntos fijos hiperbólicos, es igual a -1 o 1 , y puede ser calculado en otras muchas situaciones. Como consecuencia, se ha utilizado como una forma de asegurar la existencia de puntos fijos o periódicos de una dinámica discreta, o simplemente estimar su número, en términos de la topología del espacio de fases, por ejemplo en [SS74, Fr77, CMY83, BB92, FL100, MW07, GLI08]. Sin embargo, no estamos interesados en resultados de naturaleza global sino en cómo se comporta el índice de un único punto fijo. Los índices de puntos fijos de una aplicación y sus iteradas satisfacen unas congruencias, que en la literatura se conocen por relaciones o congruencias de Dold [Do83]. Sin embargo, ya en dimensión 2 el índice de un punto fijo de un homeomorfismo f puede alcanzar cualquier valor entero, por lo que tenemos que añadir ciertas hipótesis para que la cuestión cobre interés. Si el punto fijo p se supone aislado, no solamente entre los puntos periódicos sino también como conjunto invariante, su índice de punto fijo presenta ciertas restricciones. Le Calvez y Yoccoz [LY97], en el caso en que el homeomorfismo conserva orientación, y, posteriormente, Ruiz del Portal y Salazar [RS02], en el caso en que invierte orientación, demostraron que

$$i(f, p) \leq 1 \tag{2}$$

y caracterizaron también la sucesión $\{i(f^n, p)\}_{n \geq 1}$. Destaquemos que Bonino [Bo02] demostró que la desigualdad anterior es válida para homeomorfismos que invierten orientación incluso cuando el punto fijo no es aislado como conjunto invariante. El conocimiento sobre el índice permite deducir características de la dinámica local, véase por ejemplo [L99] y [RS05]. Mencionemos también que un índice que refina al índice de punto fijo y establece una conexión entre dinámica local y global fue definido por Le Roux en [LR10].

A la vista de (2) y con la intuición de que el comportamiento del índice para homeomorfismos que invierten orientación en \mathbb{R}^3 puede estar conectado con el comportamiento en el caso planar, queríamos probar, o refutar, la siguiente conjetura:

Conjetura 3. *Si f es un homeomorfismo de \mathbb{R}^3 que invierte orientación y p es un punto fijo aislado como conjunto invariante entonces*

$$i(f, p) \leq 1.$$

En [LRS10] se demostró que la sucesión de índices $\{i(f^n, p)\}_{n \geq 1}$ es siempre periódica para homeomorfismos de \mathbb{R}^3 , sin importar la orientación de f . Además, cualquier

sucesión periódica que satisface las congruencias de Dold se puede realizar como sucesión de índices de un punto fijo aislado de un homeomorfismo de \mathbb{R}^3 que conserva orientación.

La hipótesis de que el punto fijo sea aislado como conjunto invariante permite utilizar el índice de Conley para encapsular la dinámica local alrededor del punto fijo. Esta técnica ha sido previamente empleada con éxito en [Fr99, LY, RS02, LRS10] para calcular el índice de punto fijo en diferentes situaciones. El primer autor que formuló la relación con el índice discreto de Conley fue Mrozek [Mr89]. Básicamente, el índice de punto fijo es el número de Lefschetz de cualquier aplicación índice (en inglés, index map) que represente el índice homológico (o cohomológico) discreto de Conley.

Esta interpretación del índice de punto fijo en función del índice de Conley permite ver desde otra perspectiva trabajos anteriores. Por ejemplo, los resultados sobre índices de punto fijo para homeomorfismos del plano describen, en última instancia, el especial comportamiento del primer índice discreto de Conley en esa situación. El problema que aparece en dimensiones superiores es que los siguientes índices de Conley son más difíciles de describir. Una pequeña ayuda viene dada por la dualidad para el índice discreto de Conley que fue probada por Szymczak [Sz98].

Teorema 4. *Dado un conjunto invariante X de un homeomorfismo f localmente definido en \mathbb{R}^d y $0 \leq r \leq d$, el índice r -cohomológico discreto de Conley de X para f es dual (salvo signo) al índice $(d - r)$ -cohomológico discreto de Conley de X para f^{-1} .*

Por tanto, una descripción completa del primer índice de Conley para homeomorfismos de \mathbb{R}^3 también describe el segundo, de codimensión 1. Como consecuencia, podremos deducir resultados sobre índice de punto fijo en dimensión 3.

A pesar de que la sucesión de índices de puntos fijos aislados en el plano está completamente caracterizada para homeomorfismos, la descripción de su comportamiento para funciones continuas sigue siendo un problema abierto. En [GNR11] algunos resultados parciales han sido obtenidos, pero parece que el argumento contiene un error así que es legítimo preguntarse:

Pregunta 5. *¿Se pueden caracterizar las sucesiones de índices de punto fijo $\{i(f^n, p)\}_{n \geq 1}$ de puntos fijos aislados como conjuntos invariantes para aplicaciones continuas en \mathbb{R}^2 ?*

Resultados

El primer capítulo de esta memoria trata sobre la familia \mathcal{H}_0 de homeomorfismos del plano disipativos, que conservan orientación y que tienen un punto fijo atractivo cuya cuenca de atracción no es acotada. La mayor parte de los resultados contenidos en el capítulo han sido recogidos en [HOR12].

Dado que estudiamos el caso en que el número de rotación $\rho(h, U)$ es irracional, el primer paso es mostrar que la subfamilia de tales homeomorfismos no es vacía. En particular, probamos que para cada homeomorfismo de Denjoy ϕ de la circunferencia con número de rotación ω existe un homeomorfismo $h \in \mathcal{H}_0$ tal que la aplicación inducida en los finales primos de U , $h^* : \mathbb{P} \rightarrow \mathbb{P}$, es conjugada a ϕ y, en particular, $\rho(h, U) = \omega$. La Sección 1.4 contiene dos familias de homeomorfismos que son cualitativamente bastante diferentes. La dinámica de la primera familia presenta una cuenca de atracción U cuya

frontera en \mathbb{R}^2 no es conexa y tal que el punto de ∞ es (infinitamente) accesible desde U . Las regiones U de la segunda familia tienen frontera conexa en \mathbb{R}^2 y el punto de ∞ no es accesible desde ellas. La dinámica inducida en el conjunto de finales primos es, en todos los ejemplos presentados, un homeomorfismo de Denjoy. No se trata de una simple casualidad según se demuestra en la Sección 1.2.2:

Teorema 6. *Supongamos que $h \in \mathcal{H}_0$ y el número de rotación $\rho(h, U)$ es irracional. Entonces, la aplicación inducida $h^* : \mathbb{P} \rightarrow \mathbb{P}$ es un homeomorfismo de Denjoy.*

Una vez se ha analizado la dinámica de los finales primos, estamos listos para responder a la Pregunta 2, sobre si la existencia de órbitas periódicas en $\mathbb{R}^2 \setminus U$ implica que $\rho(h, U) \in \mathbb{Q}$ o, equivalentemente, si un irracional $\rho(h, U)$ impide la existencia de otras órbitas periódicas aparte del punto fijo de U . Una respuesta parcial afirmativa se prueba en la Sección 1.6:

Teorema 7. *Supongamos que ∞ es accesible desde U y $\rho(h, U) \notin \mathbb{Q}$. Entonces, no hay órbitas periódicas en $\mathbb{R}^2 \setminus U$.*

No obstante, en general, la respuesta a la Pregunta 2 es negativa. Las últimas páginas del capítulo están dedicadas a definir un homeomorfismo $h \in \mathcal{H}_0$ con número de rotación irracional y un punto fijo fuera de U . Este contraejemplo puede ser fácilmente generalizado para tener un número arbitrario prescrito de puntos fijos y órbitas periódicas. La construcción comienza con una dinámica radial que es posteriormente retorcida de manera que esta deformación haya conservado áreas. Esta última modificación asegura que la cuenca de atracción del punto fijo sigue siendo no acotada a la vez que consigue crear puntos fijos fuera de ella. Finalmente, el punto de ∞ se transforma en un repulsor local para conseguir disipatividad. Una familia más general de homeomorfismos ha sido encontrada simultáneamente por Matsumoto [Mat13].

El segundo capítulo de este texto trata sobre el índice de punto fijo y el índice de Conley. La mayor parte de los resultados están contenidos en [HCR13]. La Conjetura 3 se demostró cierta así que hemos sido capaces de probar el siguiente teorema:

Teorema 8. *Sea f un homeomorfismo local de \mathbb{R}^3 que invierte orientación y p un punto fijo aislado como conjunto invariante. Entonces,*

$$i(f, p) \leq 1.$$

Además, se caracterizan las sucesiones de índices de punto fijo $\{i(f^n, p)\}_{n \geq 1}$ que pueden realizarse bajo tales hipótesis: son aquellas sucesiones periódicas que satisfacen las congruencias de Dold y cumplen una serie de desigualdades que sólo involucran a los términos impares de la sucesión. La prueba de esta caracterización se sirve de la construcción de un homeomorfismo de S^2 que invierte orientación y tiene un número prescrito de órbitas periódicas.

A partir del Teorema 8 se deduce el siguiente interesante corolario:

Corolario 9. *No existen homeomorfismos minimales de \mathbb{R}^3 que inviertan orientación.*

En general, el problema sobre la existencia de homeomorfismos minimales está abierto. Sólo se conocen algunas respuestas parciales. Por ejemplo, una 2-esfera salvo una cantidad finita de puntos no admite homeomorfismos minimales, véase [Ha92, LY97]. Por

otro lado, en [FH77] se demuestra que existen homeomorfismos minimales en cualquier variedad sobre la que S^1 actúe libremente, como los toros de cualquier dimensión o las esferas de dimensión impar. Hasta donde llega nuestro conocimiento, el Corolario 9 es el primer resultado de este tipo en \mathbb{R}^n para $n > 2$.

La hipótesis de que el conjunto invariante bajo estudio sea un punto fijo no es completamente imprescindible. De hecho, en la argumentación sólo se suele utilizar que el conjunto invariante es trivial desde el punto de vista homológico. Por tanto, en la mayoría de resultados se puede sustituir el punto fijo p por un continuo acíclico invariante X . En el Capítulo 2 los enunciados se presentan con la máxima generalidad.

Los argumentos y resultados intermedios que permiten demostrar el Teorema 8 son interesantes por sí mismos. A pesar de que el teorema versa únicamente de índice de punto fijo, su prueba verdaderamente pertenece a la teoría del índice de Conley. En este trabajo tomamos la aproximación de Franks y Richeson [FR00] para definir el índice de Conley discreto. Otras aproximaciones, históricamente anteriores, pueden encontrarse en [RS88, Mr90, Sz95]. Dado un conjunto invariante X , existe un par de filtración (N, L) que puede usarse para encapsular la dinámica local alrededor de X en el siguiente sentido:

- $N \setminus L$ aísla X y f induce una aplicación $\bar{f} : N/L \rightarrow N/L$, llamada aplicación índice (en inglés, index map), que es localmente conjugada a f en un entorno de X .

La aplicación índice \bar{f} induce una acción en los grupos relativos de homología

$$\bar{f}_* : H_*(N, L, \mathbb{Q}) \rightarrow H_*(N, L, \mathbb{Q})$$

cuya reducción de Leray es independiente de la elección del par (N, L) . Así surge la definición de índice r -homológico discreto de Conley de X (para f), es la clase de equivalencia de aplicaciones lineales salvo conjugación de sus reducciones de Leray que contiene a \bar{f}_r , que se denota $h_r(f, X)$. Aplicando el Teorema de Lefschetz-Dold a la función \bar{f} como en [Mr89] obtenemos

$$i(f, X) = \sum_{r \geq 0} (-1)^r \text{trace}(h_r(f, X))$$

y la misma fórmula es válida si sustituimos f por f^n . Esta ecuación muestra cómo estimaciones sobre la traza de los índices homológicos pueden probar una desigualdad para el índice de punto fijo.

Primero, obtenemos una descripción del primer índice homológico discreto de Conley, $h_1(f, X)$. Su comportamiento es muy similar a la linealización de una permutación. Demostramos una fórmula para las trazas de sus iterados, que recoge toda la información sobre el espectro salvo la multiplicidad del 0.

Teorema 10. *Sea $f : U \subset \mathbb{R}^d \rightarrow f(U) \subset \mathbb{R}^d$ continua y X un continuo acíclico invariante aislado que no es un repulsor. Entonces, existe un conjunto finito J y una aplicación $\varphi : J \rightarrow J$ tales que, para todo $n \geq 1$,*

$$\text{trace}(h_1(f^n, X)) = -1 + \#\text{Fix}(\varphi^n).$$

En particular, $\text{trace}(h_1(f, X)) \geq -1$. Nótese que este resultado no necesita que la dinámica sea invertible. La aplicación $\varphi : J \rightarrow J$ codifica la manera en la que las

componentes conexas de L , entorno del conjunto de salida de N , son permutadas por la acción de f . Esta acción gobierna el comportamiento de los índices homológicos superiores en el siguiente sentido: si $u : V \rightarrow V$ es un representante de $h_r(f, X)$, $r > 1$, existe una descomposición de V en subespacios vectoriales que son permutados por u de manera equivalente a como lo haría φ . En particular, obtenemos el siguiente teorema:

Teorema 11. *Sea $f : U \subset \mathbb{R}^d \rightarrow f(U) \subset \mathbb{R}^d$ continua y X un continuo acíclico invariante aislado que no es un repulsor. Si $\text{trace}(h_1(f, X)) = -1$ entonces $\text{trace}(h_r(f, X)) = 0$ para cualquier $r > 1$.*

Se puede observar que los anteriores dos teoremas y la dualidad del índice discreto de Conley son suficientes para demostrar el Teorema 8. Todas las pruebas de estos resultados están contenidas en la Sección 2.5.

Una gran cantidad de complicaciones técnicas han tenido que ser resueltas en las demostraciones. Una de las más importantes concierne temas de conexión. En principio, dado un par de filtración (N, L) , el conjunto $\overline{N \setminus L}$ no es necesariamente conexo, incluso aunque el conjunto invariante X lo sea. Denotemos S la componente conexa de $\overline{N \setminus L}$ que contiene al conjunto conexo invariante X . La dinámica también induce una cierta aplicación índice, \tilde{f} , en el espacio cociente $N/(\overline{N \setminus S})$, y es natural preguntarse por la relación entre las aplicaciones \bar{f} y \tilde{f} . En la prueba del Teorema 10, demostramos que los espectros de sus respectivas acciones inducidas en los grupos de homología relativa son iguales, a excepción del autovalor 0. Sin embargo, hemos conseguido generalizar la observación previa para homeomorfismos, las aplicaciones \bar{f} y \tilde{f} son equivalentes shift en el sentido de [FR00].

Un fácil corolario del Teorema 10 es la caracterización de las posibles sucesiones de índices de punto fijo de puntos fijos aislados de aplicaciones continuas localmente definidas en \mathbb{R}^2 . No obstante, presentamos en la Sección 2.3 una demostración prácticamente autocontenida que usa una versión simple de las técnicas que permiten probar el Teorema 10.

Teorema 12. *Sea $f : U \subset \mathbb{R}^2 \rightarrow f(U) \subset \mathbb{R}^2$ continua y p un punto fijo aislado como conjunto invariante que no es un repulsor. Entonces,*

$$i(f, p) \leq 1$$

y la sucesión $\{i(f^n, p)\}$ es periódica.

Al igual que para el Teorema 8, el enunciado más general de este resultado proporciona una caracterización completa de las sucesiones posibles, que además de periódicas deben satisfacer ciertas desigualdades.

Conclusiones

El estudio topológico de las dinámicas generadas por homeomorfismos de la clase \mathcal{H}_0 iniciado en [OR11] ha sido completado con éxito en este trabajo. No es sorprendente que sólo homeomorfismos de Denjoy puedan aparecer en la dinámica de los finales primos, porque si la dinámica fuera minimal habría puntos de la frontera de U cuya órbita

positiva se acercaría al punto de ∞ , contradiciendo la disipatividad del sistema. Sin embargo, la respuesta a la Pregunta 2 no ha sido plenamente satisfactoria. Se pretendía descubrir una dependencia total de la existencia de puntos periódicos en $\mathbb{R}^2 \setminus U$ en función de la racionalidad del número de rotación de $\rho(h, U)$, para $h \in \mathcal{H}_0$. No obstante, el resultado final no es inesperado, ya que uno generalmente necesita hipótesis extra para relacionar un comportamiento periódico en los finales primos con órbitas periódicas para la dinámica. Por consiguiente, parece razonable que añadiendo alguna hipótesis extra la pregunta pueda tener una respuesta afirmativa. Una hipótesis frecuente en la literatura y adecuada para nuestro contexto es pedir a la aplicación que conserve área. Nótese que la cuenca de un punto fijo atractivo de una aplicación que conserva área es automáticamente no acotada. Esta cuestión está parcialmente relacionada con la conjetura de Markus-Yamabe, cuyos enunciados originales en el caso continuo y discreto han sido ya resueltos [MY60, BLI96, CE⁺95], pero de la que alguna versión sigue abierta.

El contenido de la segunda parte de la tesis ha completado algunas lagunas en el conocimiento del índice de punto fijo de puntos fijos aislados como conjuntos invariantes para aplicaciones continuas y homeomorfismos en \mathbb{R}^d . En la Sección 2.6 del Capítulo 2 se construye un ejemplo de un punto fijo aislado de un homeomorfismo que invierte orientación de \mathbb{R}^4 con una sucesión de índices de punto fijo no acotada. Un ejemplo que conserve orientación había aparecido ya en [LRS10]. A medida que aumenta la dimensión, no se puede esperar que la sucesión de índices de punto fijo presente muchas más restricciones. La misma conclusión se aplica a aplicaciones continuas, tras la caracterización encontrada en el plano se advierte que un resultado análogo no será cierto en dimensión 3.

Algunas de las ideas que aparecen en el Capítulo 2 podrían ser aplicables a otros contextos. El Teorema 10, que es un primer paso en la prueba del Teorema 8, es interesante por sí mismo ya que es el primer resultado que describe con precisión el índice homológico de Conley. Otro punto interesante es el significado geométrico de la desigualdad del Teorema 8. Se puede pensar en la diferencia entre -1 y la traza del primer índice homológico como el número de ramas del conjunto inestable local que son invariantes por la dinámica, si es que éstas están bien definidas. Bajo esta interpretación, por los Teoremas 10 y 11 se deduce que para homeomorfismos locales de \mathbb{R}^3 que invierten orientación o bien una rama estable o una rama inestable, al menos, es invariante. Este enunciado es bastante sorprendente a la par que poco formal, pero podría tener aplicaciones futuras en argumentos de naturaleza global.

Chapter 1

Rotation numbers for planar attractors

1.1 Introduction

This chapter deals with the study of some particular discrete dynamics in the plane, generated by the iteration of a homeomorphism $h : \mathbb{R}^2 \rightarrow \mathbb{R}^2$. The class of homeomorphisms \mathcal{H}_0 object of this work satisfies two local properties which are linked by the dynamics. Every $h \in \mathcal{H}_0$ has a local attractor, which will be assumed to be a fixed point placed at the origin, denoted 0 , and a local repelling fixed point, the point at ∞ . This last hypothesis is called dissipativity and can be reformulated without making explicit mention to ∞ , the point used to compactify \mathbb{R}^2 in order to obtain the 2-sphere S^2 . The connection between these local dynamics is given by the fact that the basin of attraction of 0 and the basin of repulsion (attraction for h^{-1}) of ∞ must meet. Both basins are very simple from the topological point of view as they are always simply connected domains.

The discrete dynamics induced in the region of attraction U of an attracting fixed point is trivial. It is a classical result from Kerékjarto [Ke34] (see also [BoK98]) that the restriction of the map to the region U is conjugate to one of the following planar homeomorphisms

$$z \mapsto \frac{1}{2}z \quad \text{or} \quad z \mapsto \frac{1}{2}\bar{z},$$

depending on whether h preserves or reverses orientation. However, the dynamics induced in the boundary of U may be very difficult as a consequence of the possibly bad topological properties of ∂U . If we consider U as subset of S^2 and denote $\partial_{S^2}U$ its boundary in the 2-sphere, the set $\partial_{S^2}U$ is a compact connected set whose local behavior can be wild, for instance it may not be locally connected in any point (e.g. a pseudo-circle [Ha82]).

A way to supply a nice boundary to an open simply connected subset U of S^2 is given by prime end theory. This theory, developed by Carathéodory about a century ago [Ca13], compactifies the region U adding a set $\mathbb{P}(U)$ called the set of prime ends of U . With the topology that arises naturally from its construction, the set of prime ends is homeomorphic to a circle and $U \sqcup \mathbb{P}(U)$ is homeomorphic to a closed disk. Standard references for the proofs are [Ma82, Po92]. Any homeomorphism h of S^2 which leaves U invariant then induces a homeomorphism, denoted h^* , in the set of prime ends $\mathbb{P}(U)$. Since h^* is a circle homeomorphism it has an associated rotation number, which is a real

number up to integer translation or, in other words, an element of \mathbb{R}/\mathbb{Z} and depends only on h and U . Thus, it is possible to associate a rotation number to every attracting fixed point or, more generally, to every open simply connected invariant planar domain in the fashion we have just described. The first author to establish such link was Birkhoff [Bi32]. Our work tries to extract dynamical consequences from this rotation number in our class \mathcal{H}_0 of planar homeomorphisms.

The boundary of U , either as a subset of S^2 or as a subset of the plane, is left invariant under h as well. The natural question is how to relate the dynamics induced by h in ∂U with the one induced in the “ideal” boundary of U , that is, the prime ends of U . The first work which contained results in this direction is due to Cartwright and Littlewood, see [CL54]. The most celebrated theorem therein, proved using arguments involving prime ends and rotation numbers, is the following:

Theorem 1.1.1 (Cartwright - Littlewood). *Let h be a orientation-preserving plane homeomorphism which leaves a continuum K invariant. If $S^2 \setminus K$ is simply connected then K contains a fixed point.*

Bell [Be76] proved that the result also holds in the orientation-reversing case. In general, as noted in [CL54], a rational $\rho(h, U)$ does not imply the existence of periodic points in ∂U and the converse statement does not hold either. However, extra hypothesis on the map or the region make the statements hold. For example, in an area-preserving setting, there are periodic points in the boundary of U provided that the rotation number is rational. This result was also proved by Cartwright and Littlewood in [CL54]. Similar type of results, obtaining periodic points from a rational rotation number, have been proved by several authors [AY92, BG91, BG92, BaK98]. In the setting this work is conducted, Ortega and Ruiz del Portal showed in [OR11] that periodicity in the set of prime ends imply the existence of periodic orbits in $\mathbb{R}^2 \setminus U$.

The converse statement wonders whether the existence of periodic points enforces the rotation number to be rational. In general this is not true and neither does it hold for our particular setting unless we add some extra hypothesis. A counterexample and a partial positive answer are explained in Section 1.6. Another counterexamples have been found simultaneously by Matsumoto [Mat13]. A very celebrated example of a diffeomorphism and a basin whose induced map in the prime ends is conjugate to an irrational rotation was discovered by Handel [Ha82]. In this example, the boundary of the basin is a pseudo-circle, hence not locally connected at any point. For more examples of homeomorphisms h with $\rho(h, U) \notin \mathbb{Q}$ we refer the reader to [W91]. Recently, in [KLN12] Koropecki, Le Calvez and Nassiri have shed some light on how the induced dynamics in the boundary of U looks like if the rotation number is irrational and the map satisfies some non-wandering hypothesis in a neighborhood of ∂U , which is guaranteed if, for instance, the map is area-preserving. As a corollary, they prove that for planar homeomorphisms there can not exist periodic points in the boundary of U provided the map satisfies this extra hypothesis.

A very important question in dynamics is to determine which conditions make a local attractor become automatically a global attractor. For homeomorphisms $h : \mathbb{R}^d \rightarrow \mathbb{R}^d$ with an attracting fixed point p , the global attraction of p is characterized by the following properties

$$h \text{ is dissipative and } \text{Rec}(h) = \{p\},$$

where $\text{Rec}(h)$ denotes the set of recurrent points of h . In low dimensions the characterization is even easier. For $d = 1$, $\text{Rec}(h) = \{p\}$ can be replaced by $\text{Fix}(h^2) = \{p\}$, and this statement also holds for planar orientation-reversing maps, see [OR11]. Bonino proved in [Bo04] that for planar orientation-reversing homeomorphisms the existence of a k -periodic orbit for $k > 2$ implies the existence of a 2-periodic orbit, hence in this setting $\text{Fix}(h^2) = \{p\}$ is equivalent to $\text{Per}(h) = \{p\}$. In Section 1.4 we construct examples of orientation-preserving homeomorphisms $h \in \mathcal{H}_0$ such that its unique periodic point is the attracting fixed point, showing that in the orientation-preserving setting the absence of extra periodic points does not imply global attraction. Of course, in these examples $\text{Rec}(h)$ contains more points than just p , it will contain a Cantor set.

An important conjecture concerning local and global stability was formulated by Markus and Yamabe [MY60].

Conjecture 1.1.2 (Markus-Yamabe). *Let $F : \mathbb{R}^d \rightarrow \mathbb{R}^d$ be a C^1 map such that for every $x \in \mathbb{R}^d$ the Jacobian of F at x has all its eigenvalues with negative real part. If $F(p) = 0$, then p is a global attractor of the system $\dot{x} = F(x)$.*

Several works addressed this conjecture, which is trivially true in the 1-dimensional case. An affirmative answer was given for the planar case [Gu95], whereas for $d \geq 3$ counterexamples, with even a polynomial map F , have been found [BL96]. It is natural to pose the same question in the discrete setting:

Question 1.1.3 (Discrete Markus-Yamabe). *Let $f : \mathbb{R}^d \rightarrow \mathbb{R}^d$ be a C^1 map such that $f(0) = 0$ and for every $x \in \mathbb{R}^d$ the Jacobian of F at x has all its eigenvalues with modulus less than 1. Then, is 0 a global attractor of the dynamics generated by f ?*

In general, the answer is affirmative only for $d = 1$, see [CGM99], where it is also proved that for polynomial maps the answer is affirmative for $d = 2$. In an attempt to ensure the global attraction of the origin one may add extra hypothesis. In this context it is natural to consider dissipativity but this condition is still not sufficient, see [AGG07]. Another suitable hypothesis can be the existence of an orbit connecting ∞ to 0 or, in other words, the unboundedness of the region of attraction U . Notice that the set of orientation-preserving planar homeomorphisms fulfilling the previous hypothesis consists of the maps in \mathcal{H}_0 which satisfy the condition on the eigenvalues of the Jacobian.

This chapter is organized as follows. The next section is devoted to give a brief account on rotation number, Denjoy maps and prime ends. In Section 1.4 we construct two families of homeomorphisms $h \in \mathcal{H}_0$ such that h^* is an arbitrary Denjoy map. They exhibit different regions of attraction U while sharing angular behavior. Then, we show that irrational rotations can not appear in the dynamics of \mathbb{P} . This theorem is the content of Section 1.5. Finally, we discuss whether the existence of periodic orbits outside U imply that $\rho(h, U)$ is rational. A partial result is proved adding the hypothesis that ∞ is accessible from U , but an example included later shows that the general result is not true. Most of the results presented in this chapter are contained in an already published article [HOR12].

1.2 Preliminaries

1.2.1 Rotation number

The concept of rotation number was introduced by Henri Poincaré in the 19th century in his work about celestial mechanics. It measures the mean angular velocity of the orbit of a point under the action of a map in the circle. The dynamical properties of maps in the circle are intimately linked to its rotation number, as described by a classification theorem which is included below.

Although in this subsection we only write S^1 to denote the circle, in the ensuing subsections $\mathbb{T} = \mathbb{R}/\mathbb{Z}$ is more frequently used. The natural group operation in \mathbb{T} is induced by the sum in \mathbb{R} and denoted $+$ as well.

Let $f : S^1 \rightarrow S^1$ be an orientation-preserving homeomorphism and $F : \mathbb{R} \rightarrow \mathbb{R}$ one of it lifts to the universal cover. Assume the covering projection $p : \mathbb{R} \rightarrow S^1$ has the explicit form $p(x) = e^{2\pi ix}$.

Definition 1.2.1. *Let $x \in \mathbb{R}$. The rotation number of f is*

$$\rho(f) = \lim_{n \rightarrow +\infty} \left\{ \frac{F^n(x) - x}{n} \right\} + \mathbb{Z}.$$

Several remarks must be made after the definition.

- In this work we consider the rotation number as an element of the quotient $\mathbb{T} = \mathbb{R}/\mathbb{Z}$, whereas sometimes in the literature it is defined as the number in the interval $[0, 1)$ belonging to the equivalence class. The projection of a number $\theta \in \mathbb{R}$ onto \mathbb{T} will be denoted $\bar{\theta} = \theta + \mathbb{Z}$.
- The definition does not depend neither on x nor in F . If we take $x < y < x + k$, the order is preserved $F^n(x) < F^n(y) < F^n(x) + k$ for any $n, k \in \mathbb{Z}$. This implies that the mean velocities of x and y are the same. The independence on the lift follows from the fact that any two lifts differ by an integer translation.
- Note that if f has a fixed point then $\rho(f) = \bar{0} = 0 + \mathbb{Z}$. This explains why the rotation number does not give any information for orientation-reversing circle homeomorphisms, it would be equal to $\bar{0}$ because they always present at least two fixed points.

The existence of a periodic orbit, of period q , implies that the rotation number is rational, more precisely a fraction $p/q + \mathbb{Z}$ where $\gcd(p, q) = 1$. The integer p determines the relative position of the points $\{\theta, f(\theta), \dots, f^{q-1}(\theta)\}$ of the periodic orbit in the circle. It is equal to the relative position of the points $\{0 + \mathbb{Z}, \frac{p}{q} + \mathbb{Z}, \dots, \frac{(q-1)p}{q} + \mathbb{Z}\}$ in \mathbb{T} or, equivalently, the relative position of the points $\{1, e^{2\pi p/q}, \dots, e^{2\pi(q-1)p/q}\}$ in S^1 .

Clearly, the rotation number is a topological invariant. Furthermore, it is invariant under topological semiconjugacy, i.e., if $h : S^1 \rightarrow S^1$ is a continuous surjective map and

$$f \circ h = h \circ g$$

then $\rho(f) = \rho(g)$. The reader may find this property not surprising after the observation made in the previous paragraph, at least for the rational case.

The following theorem goes back to the work of Poincaré and Denjoy [De32] and classifies the dynamical behavior of circle orientation-preserving homeomorphisms in terms of the rotation number.

Theorem 1.2.2 (Classification of circle homeomorphisms). *Let $f : S^1 \rightarrow S^1$ be an orientation-preserving homeomorphism.*

- Assume $\rho(f) = p/q + \mathbb{Z} \in \mathbb{Q} + \mathbb{Z}$, with $\gcd(p, q) = 1$. Then, f has at least one q -periodic orbit and every other periodic orbit must have period q as well. Additionally, every forward and backward orbit converges to a periodic orbit.
- Assume $\rho(f) \notin \mathbb{Q} + \mathbb{Z}$. There are two possibilities:
 - If there exists a dense orbit then f is topologically conjugate to an irrational rotation, hence every orbit is dense.
 - Otherwise, there exists an invariant Cantor set C which is the unique minimal set of S^1 (it does not contain any non-trivial proper and closed invariant subset) and such that every positive and negative orbit converges to C .

The maps which belong to the last of these types, having irrational rotation number and an invariant Cantor set, are called *Denjoy homeomorphisms*, *Denjoy maps* or *Denjoy counterexamples*. One very important property of them is that they cannot be very regular, there do not exist Denjoy maps of class C^2 , or even C^1 with derivative of bounded variation. The first proof of this classical result can be found in the original article of Denjoy [De32].

1.2.2 Denjoy homeomorphisms

In this subsection we will try to give a complete description of Denjoy maps. We review results obtained by Markley in [Ma70]. The notations are taken from Markley's original work.

For a real number θ its associated element of $\mathbb{T} = \mathbb{R}/\mathbb{Z}$ is denoted $\bar{\theta}$ or just θ for simplicity. The natural sum in \mathbb{T} is also denoted $+$. Let us define a distance in \mathbb{T} . Given two points of \mathbb{T} , $\bar{\theta}_1$ and $\bar{\theta}_2$, its distance is

$$d(\bar{\theta}_1, \bar{\theta}_2) = \text{dist}_{\mathbb{R}}(\theta_1 - \theta_2, \mathbb{Z}),$$

where $\text{dist}_{\mathbb{R}}$ indicates the distance from a point to a set on the real line. Closed arcs will be denoted by greek letters α, β, \dots and the corresponding open arcs will be $\dot{\alpha}, \dot{\beta}, \dots$. Given $\eta \in \mathbb{R}$ we consider the rotation $R_\eta : \mathbb{T} \rightarrow \mathbb{T}$, $R_\eta(\bar{\theta}) = \overline{\theta + \eta}$. Two sets S_1 and S_2 in \mathbb{T} are congruent ($S_1 \equiv S_2$) if $R_\eta(S_1) = S_2$ for some $\eta \in \mathbb{R}$.

We have chosen to work on the space \mathbb{T} , but all figures will be sketched on the unit circle

$$S^1 = \{z \in \mathbb{C} : |z| = 1\}.$$

Given a Cantor set C in \mathbb{T} , we split it into the accessible and inaccessible sets,

$$C = A \cup I, \quad A \cap I = \emptyset.$$

The complement of C can be described as

$$\mathbb{T} \setminus C = \bigcup_{k=0}^{\infty} \dot{\alpha}_k$$

where $\{\alpha_k\}_{k \geq 0}$ is a family of pairwise disjoint closed arcs dense in \mathbb{T} . The accessible set A is composed by the end points of all α_k . The reader may keep in mind that A consists of the points of C which are accessible from $\mathbb{T} \setminus C$ in the 1-dimensional analogue of what will be described in the next subsection. A Cantor function associated to C is a continuous function $\mathcal{P} : \mathbb{T} \rightarrow \mathbb{T}$ satisfying

$$\mathcal{P}(\bar{\theta}_1) = \mathcal{P}(\bar{\theta}_2) \Leftrightarrow \bar{\theta}_1 = \bar{\theta}_2 \text{ or } \bar{\theta}_1, \bar{\theta}_2 \in \alpha_k \text{ for some } k \geq 0.$$

To visualize this type of maps we collapse every arc α_k into a point in such a way that the cyclic order is preserved. It is not hard to prove that \mathcal{P} is onto and $\mathcal{P}(A)$ is a

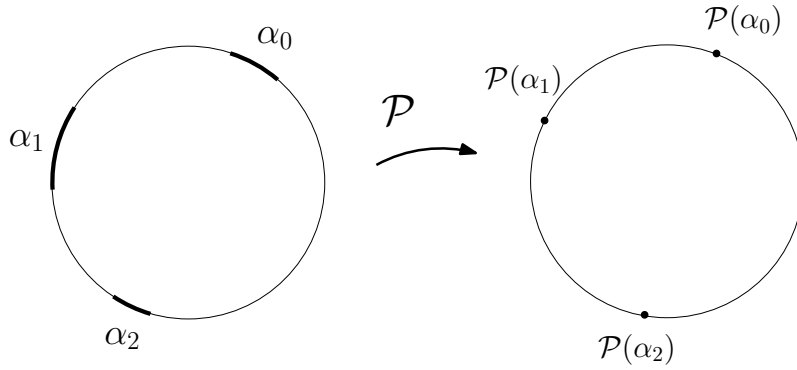

Figure 1.1: Example of Cantor function.

countable and dense subset of \mathbb{T} .

A Denjoy map is an orientation-preserving homeomorphism $\phi : \mathbb{T} \rightarrow \mathbb{T}$ having an irrational rotation number and not conjugate to a rotation. From now on the rotation number of ϕ will be $\bar{\omega}$, with $\omega \in \mathbb{R} \setminus \mathbb{Q}$. Since ϕ is not conjugate to R_ω we know that there exists a Cantor set $C = C_\phi$ contained in \mathbb{T} which is minimal for ϕ and attracts all orbits, in the future and in the past. Moreover there exists a Cantor function \mathcal{P} associated to C_ϕ and such that $\mathcal{P} \circ \phi = R_\omega \circ \mathcal{P}$. A key fact for the classification of Denjoy maps is the uniqueness of this \mathcal{P} up to rotations.

Lemma 1.2.3. *Assume that \mathcal{P}_1 and \mathcal{P}_2 are Cantor functions associated to C_ϕ and such that*

$$\mathcal{P}_i \circ \phi = R_\omega \circ \mathcal{P}_i, \quad i = 1, 2.$$

Then there exists $\eta \in \mathbb{R}$ such that $\mathcal{P}_2 = R_\eta \circ \mathcal{P}_1$.

Proof. After composing with a rotation we can assume that $\mathcal{P}_1(\alpha_0) = \mathcal{P}_2(\alpha_0)$. Let us prove that \mathcal{P}_1 and \mathcal{P}_2 coincide in this case.

The invariance of C under ϕ implies that the iterated arcs $\phi^n(\alpha_0)$ must become a sub-family of $\{\alpha_k\}_{k \geq 0}$. We employ the notation

$$\alpha_{\sigma(n)} = \phi^n(\alpha_0), \quad n \in \mathbb{Z}$$

and notice that

$$\mathcal{P}_i(\bar{\theta}) = \mathcal{P}_i(\phi^n(\alpha_0)) = R_\omega^n(\mathcal{P}_i(\alpha_0)), \quad i = 1, 2$$

whenever $\bar{\theta} \in \alpha_{\sigma(n)}$. Thus $\mathcal{P}_1 = \mathcal{P}_2$ on the set $\bigcup_{n \in \mathbb{Z}} \alpha_{\sigma(n)}$. Since this set is invariant under ϕ , its closure must contain C . Therefore \mathcal{P}_1 and \mathcal{P}_2 coincide on C and the conclusion follows from the definition of Cantor function. \square

Given $\phi, C = A \cup I$ and \mathcal{P} as before, we notice that $\mathcal{P}(A)$ is a non-empty, countable set satisfying $R_\omega(\mathcal{P}(A)) = \mathcal{P}(A)$. This set is not uniquely determined by ϕ , but the previous result implies that the class of congruence of $\mathcal{P}(A)$ is unique. Two sets in the circle are said to be congruent if they differ by a rotation. In general, given two Denjoy maps ϕ_1 and ϕ_2 which are topologically conjugate, Lemma 1.2.3 implies that $\mathcal{P}_1(A_1)$ and $\mathcal{P}_2(A_2)$ are congruent. In [Ma70] it is proved that the converse is also valid and so the rotation number $\bar{\omega}$ and the class of congruence of $\mathcal{P}(A)$ are sufficient to classify Denjoy maps. Actually the paper [Ma70] contains a complete topological description of Denjoy maps: given $\omega \in \mathbb{R} \setminus \mathbb{Q}$ and $M \subset \mathbb{T}$ with $M \neq \emptyset$, M countable and $R_\omega(M) = M$, there exists a Denjoy map ϕ with rotation number $\bar{\omega}$ and such that $\mathcal{P}(A) = M$.

It must be noticed that Markley originally worked with $\mathcal{P}(I)$ instead of $\mathcal{P}(A)$. These are obviously equivalent invariants but we find more intuitive to think in terms of the countable set $\mathcal{P}(A)$. The above discussions will be illustrated with the intuitive construction of one of the simplest Denjoy maps. The standard construction appearing in textbooks such as [AP92] corresponds to a set $\mathcal{P}(A)$ composed by a unique orbit of R_ω , say

$$\mathcal{P}(A) = \{\overline{\varphi + n\omega} : n \in \mathbb{Z}\}$$

with $\varphi \in [0, 1)$. Let us discuss the case of two orbits

$$\mathcal{P}(A) = \{\overline{\varphi + n\omega} : n \in \mathbb{Z}\} \cup \{\overline{\psi + n\omega} : n \in \mathbb{Z}\}$$

with $\varphi, \psi \in [0, 1)$, $\varphi < \psi$. We start with a Cantor set C in \mathbb{T} and split the family of arcs $\{\alpha_k\}_{k \geq 0}$ in two sub-families $\{\beta_{n,\varphi}\}_{n \in \mathbb{Z}}$ and $\{\beta_{n,\psi}\}_{n \in \mathbb{Z}}$ satisfying

$$\begin{aligned} \phi(\beta_{n,\varphi}) &= \beta_{n+1,\varphi}, & \phi(\beta_{n,\psi}) &= \beta_{n+1,\psi}, \\ \mathcal{P}(\beta_{n,\varphi}) &= \overline{\varphi + n\omega}, & \mathcal{P}(\beta_{n,\psi}) &= \overline{\psi + n\omega}, \end{aligned}$$

and such that the cyclic order is preserved by ϕ and \mathcal{P} ,

To finish this section we generalize the previous procedure and describe how to label the family of arcs $\{\alpha_k\}_{k \geq 0}$ according to the dynamics. Assume now that ϕ is an arbitrary Denjoy map and $C = A \cup I$ and \mathcal{P} have the obvious meanings. The set $\mathcal{P}(A)$ being countable and invariant under R_ω , it can be described as a disjoint union of orbits of R_ω . Let us pick exactly one point in each of these orbits to obtain a family of points

$$\{\overline{\varphi_\lambda} : \lambda \in \Lambda\}$$

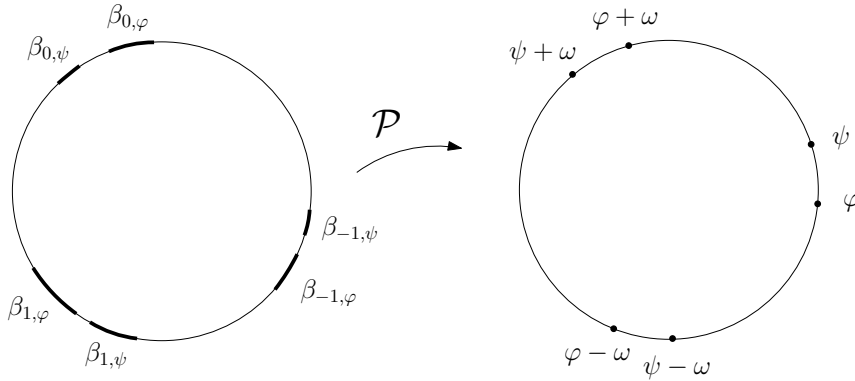

Figure 1.2: Cantor function constructed.

where $\overline{\varphi_\lambda} \in \mathcal{P}(A)$, Λ is a non-empty countable set and

$$\mathcal{P}(A) = \{\overline{\varphi_\lambda + n\omega} : \lambda \in \Lambda, n \in \mathbb{Z}\}.$$

Moreover $(\lambda, n) \mapsto \overline{\varphi_\lambda + n\omega}$ is one-to-one. Notice that in the previous example Λ had two elements. Define $\beta_{n,\lambda} = \mathcal{P}^{-1}(\overline{\varphi_\lambda + n\omega})$. Then the family of arcs $\{\beta_{n,\lambda}\}_{n \in \mathbb{Z}, \lambda \in \Lambda}$ coincides with $\{\alpha_k\}_{k \geq 0}$ and the identity

$$\phi(\beta_{n,\lambda}) = \beta_{n+1,\lambda}$$

holds.

1.2.3 Prime end theory

Prime end theory was developed by the greek mathematician Constantin Carathéodory [Ca13] in the beginning of the 20th century while studying boundary behavior of conformal maps. The theory was originally developed using tools from complex analysis. A standard reference is the book of Pommerenke [Po92]. However, a purely topological approach is possible, we refer the reader to an article of Mather [Ma82]. There are several other references, for instance [CLo66, Mil06]. A simply connected open subset U of the plane is conformally equivalent, hence homeomorphic, to the open unit disk by the Riemann mapping Theorem. Nevertheless, the boundary of U may be very wild, for instance, not locally connected, which prevents any conformal map $f : \mathbb{D} = \{z \in \mathbb{C} : |z| < 1\} \rightarrow U$ to be continuously extended to $\mathbb{D} \cup S^1$. The idea behind prime end theory is to compactify the region U with an ideal boundary, homeomorphic to S^1 .

The identification $S^2 = \mathbb{R}^2 \cup \{\infty\}$ is done without explicit mention. As a consequence, for a planar set U we can consider its boundary as a subset of the plane, denoted ∂U , or its boundary as a subset of the 2-sphere, denoted $\partial_{S^2} U$. As a general rule, when it is not absolutely clear from the context the topological operations int , cl and ∂ have a subindex that indicates the ambient space in which the operation takes place.

Let U be a simply connected open subset of S^2 . The boundary of U in S^2 is denoted $\partial_{S^2} U$, we save ∂U to denote the boundary of a planar set U as a subset of \mathbb{R}^2 . Notice that $\partial_{S^2} U$ corresponds to ∂U except when U is unbounded and $\partial_{S^2} U = \partial U \cup \{\infty\}$. A *cross-cut* c of U is the image of an arc $\gamma : (0, 1) \rightarrow U$ which can be extended to a Jordan

arc $\bar{\gamma} : [0, 1] \rightarrow \bar{U}$ such that their two end points are different points in $\partial_{S^2}U$. It is clear that a cross-cut splits U in two regions that are open topological disks as well. Fix a point q in U . A *chain of cross-cuts* is a sequence $\{c_n\}_{n \geq 0}$ of cross-cuts such that, if we denote V_n to the connected component of $U \setminus c_n$ not containing q , the sets $\{V_n\}_{n \geq 0}$ are nested and $\bar{c}_n \cap \bar{c}_m = \emptyset$ for any $n \neq m$. A chain $\{c_n\}$ is said to *divide* another chain $\{c'_n\}$ of cross-cuts if for any positive integer n there exists m such that $V_m \subset V'_n$. Two chains that mutually divide each other are *equivalent*. It is easy to check that this defines an equivalence relation. On a side note, notice that the point q is an artificial device and becomes unnecessary once we make a choice for V_0 .

Now, we are ready to define prime ends. A *prime end* is an equivalence class of chains of cross-cuts, denoted by \mathfrak{p} , such that any chain which divides an element of \mathfrak{p} belongs to \mathfrak{p} . It can be proved that every prime end contains a chain $\{c_n\}$ of cross-cuts such that $\text{diam}_{S^2}(c_n) \rightarrow 0$ as $n \rightarrow +\infty$, where the diameter is computed with the spherical metric in S^2 . Conversely, any chain of cross-cuts whose size tend to 0 defines a prime end, hence it is possible to define prime ends using only this type of chains.

The set of prime ends of U will be denoted $\mathbb{P} = \mathbb{P}(U)$ and the set $U^* = U \sqcup \mathbb{P}$ is called the *prime end compactification* of U . A basis of the topology of this set is given by the open sets of U together with the sets V which are connected components of $U \setminus c$ for some cross-cut c . The fundamental and classical result of this theory, which goes back to Carathéodory, is that \mathbb{P} is homeomorphic to a circle and U^* is a topological closed disk.

Given a chain of crosscuts $\{c_n\}$ contained in a prime end \mathfrak{p} , let $\{V_n\}$ the nested sequence of connected components of $U \setminus c_n$ as in the definition. The *impression* of \mathfrak{p} , is

$$I(\mathfrak{p}) = \bigcap_{n \geq 0} \bar{V}_n.$$

Evidently, the definition does not depend on the sequence $\{c_n\}$ of cross-cuts chosen. Since \mathfrak{p} is a prime end, $I(\mathfrak{p})$ is contained in $\partial_{S^2}U$. A *principal point* of \mathfrak{p} is a point $p \in \partial_{S^2}U$ such that there exists $\{c_n\}$ in \mathfrak{p} with $\lim_n c_n = \{p\}$. Note that a compactness argument shows that any prime end has at least one principal point. The set of principal points is called *principal set* and denoted $\Pi(\mathfrak{p})$. Both the impression and the principal set are compact and connected subsets of $\partial_{S^2}U$. Observe that the principal set is always contained in the impression.

Let us show that a dense subset of prime ends truly correspond to points in the boundary of U . A point $a \in \partial_{S^2}U$ is *accessible* from U provided that it is the end point of a closed arc contained in $U \cup \{a\}$. It is easy to construct a chain of crosscuts of U which tends to such a , hence it defines a prime end whose principal set is reduced to the $\{a\}$. The set of accessible points is dense in U and the prime ends defined by them are dense in \mathbb{P} as well.

Suppose now that we are given a homeomorphism $h : S^2 \rightarrow S^2$ which leaves a simply connected open set U invariant. The topological nature of the prime end construction implies that h induces a map $h^* : \mathbb{P} \rightarrow \mathbb{P}$ in the set of prime ends of U . Additionally, it is not difficult to check that h^* is a homeomorphism. Therefore, the restricted homeomorphism $h|_U : U \rightarrow U$ extends to a homeomorphism in the prime end compactification U^* of U . Since \mathbb{P} is homeomorphic to a circle, we can associate a rotation number to h and U defined by $\rho(h, U) := \rho(h^*)$. Birkhoff, well aware of the work of Carathéodory, was the first author to work with the rotation number assigned to a planar domain. In his article

[Bi32], he defined a planar continuum K separating S^2 in two connected components U^i and U^e and a homeomorphism $h : S^2 \rightarrow S^2$ leaving K, U^i and U^e invariant and such that $\rho(h, U^i) \neq \rho(h, U^e)$.

Let us include a small lemma which involves prime end dynamics to illustrate the previous definitions.

Lemma 1.2.4. *In the previous setting, if a is an accessible fixed point and $\gamma \subset U \cup \{a\}$ is a closed arc, a an end point of γ , such that $h(\gamma) \subset \gamma$ or $\gamma \subset h(\gamma)$ then $\rho(h, U) = 0$.*

Proof. In general, if the arc γ defines an accessible prime end \mathfrak{p}_a then the arc $h(\gamma)$ defines $h^*(\mathfrak{p}_a) \in \mathbb{P}$. The hypothesis imply that $h(\gamma)$ is equal to γ in a neighborhood of the boundary of U , hence both arcs define the same prime end and we conclude that $\mathfrak{p}_a = h^*(\mathfrak{p}_a)$, so $\rho(h, U) = 0$. \square

1.3 Setting and previous results

The aim of this section is to introduce the class of planar homeomorphisms this work deals with and the results obtained by Ortega and Ruiz del Portal in [OR11] and which are completed by the results we present in the subsequent sections of this chapter.

Let \mathcal{H}_0 be the class of orientation-preserving planar homeomorphisms h which satisfy the following hypothesis:

- h is dissipative,
- the origin, denoted 0 , is an attracting fixed point and
- its region of attraction, U , is an unbounded subset of \mathbb{R}^2 .

A brief discussion about the hypothesis is pertinent. The notion of dissipative system is common in physics and is used when energy gradually decreases. In the field of dynamical systems and, more precisely, in the planar and discrete setting the definition is the following:

Definition 1.3.1. *A homeomorphism $h : \mathbb{R}^2 \rightarrow \mathbb{R}^2$ is said to be dissipative if there exists a positively invariant compact set W such that every positive orbit is eventually contained in W .*

A set W is said to be positively invariant under a map h if $h(W) \subset W$. We refer the reader to [Hal88] and [Le48] for information about dissipativity in a more general setting. This concept can be reformulated in different ways but the one we are most interested in makes a connection with stability. Any planar homeomorphism h can be extended to a homeomorphism of S^2 , also denoted h , by fixing the point at ∞ . Then, h is dissipative if and only if ∞ is an attracting fixed point for h^{-1} or, in other words, ∞ is a repelling fixed point for h .

Definition 1.3.2. *Let h be a planar homeomorphism and p a fixed point. Then p is attracting or is an attractor if it has a basis of positively invariant neighborhoods and is contained in the interior of*

$$U = \{x \in \mathbb{R}^2 : \lim_{n \rightarrow +\infty} h^n(x) = p\}.$$

The set U is called region of attraction, or basin of attraction, of p .

As a consequence of the definition, there exists a basis of neighborhoods $\{V_n\}$ of p such that $h(V_n) \subset \text{int}(V_n)$. It is standard and easy to check that the region of attraction of an attracting fixed point is always invariant under h , open and simply connected.

The unboundedness of U required for the maps in the class \mathcal{H}_0 is of absolute importance. It guarantees the existence of orbits which belong, at the same time, to the region of attraction U of the origin for h and also to the region of attraction of ∞ for h^{-1} , or region of repulsion of ∞ . Thus, the dissipativity property enforces some restrictions over the dynamics in the boundary of U and in the set of prime ends \mathbb{P} of U as well. Note that for area-contracting maps the unboundedness of U is guaranteed, otherwise U would be an invariant subset with finite area.

Once we have described our setting, the main question to solve is the following:

Is the rotation number $\rho(h, U)$ connected with the existence of periodic orbits for h ?

The case in which the rotation number is rational is discussed in [OR11], where the following result is proved.

Theorem 1.3.3 (Ortega - Ruiz del Portal). *Let h be a dissipative orientation-preserving homeomorphism of the plane which leaves invariant an open simply connected proper set $U \subset \mathbb{R}^2$. If, in addition,*

$$\rho(h, U) = 0$$

then h has a fixed point in $\mathbb{R}^2 \setminus U$.

Note that if $\rho(h, U) = \frac{p}{q}$ then $\rho(h^q, U) = 0$ hence h^q has a fixed point in $\mathbb{R}^2 \setminus U$, so h has a periodic point in $\mathbb{R}^2 \setminus U$. The previous theorem addresses one direction of the question giving a positive answer. It is left to see whether the existence of a periodic point in $\mathbb{R}^2 \setminus U$ implies that the rotation number is rational. Equivalently, we have to investigate whether an irrational rotation number prevents the existence of periodic points outside U . This question is discussed in Section 1.6.

In the rational case, the dynamics induced in the circle of prime ends is somehow unique. It has a number of periodic orbits, with the same period, such that every other orbit tends both in the future and in the past to a periodic one. This is the first item of the Classification Theorem 1.2.2. However, in the irrational case there exist two possibilities that are qualitatively very different. In Section 1.5 we prove that irrational rotations do not appear or, equivalently, no orbit can be dense for the induced dynamics in \mathbb{P} .

1.4 Example of maps with irrational rotation number

Maps in the class \mathcal{H}_0 which realize any rational number as rotation number $\rho(h, U)$ are easy to construct. As an example consider $h = R \circ \phi_1$, where R is the rotation of angle $\pi/2$ and ϕ_1 is the time 1 map associated to the flow $\{\phi_t\}$ indicated in Figure 1.3.

The region of attraction is the whole plane except for the four points a_1, \dots, a_4 and the orbits attracted by them. The space of prime ends is described in Figure 1.4. The induced map h^* has two 4-cycles, the attractor $\{a_1, a_2, a_3, a_4\}$ and the repeller $\{\infty_1, \infty_2, \infty_3, \infty_4\}$. The rotation number is $\frac{1}{4}$. Note that if we replace R by R^{-1} , the rotation of angle $-\pi/2$, the rotation number will be $\frac{3}{4}$.

The purpose of this section is to present some maps in \mathcal{H}_0 with irrational rotation number. In particular, we will prove the following result:

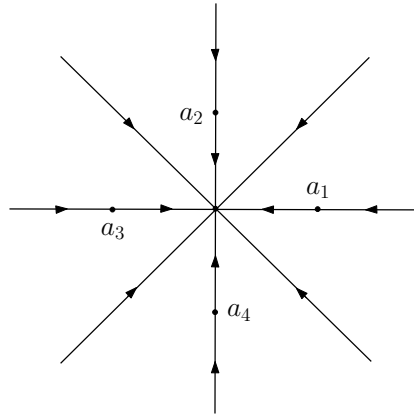

Figure 1.3: Flow $\{\phi_t\}_{t \in \mathbb{R}}$.

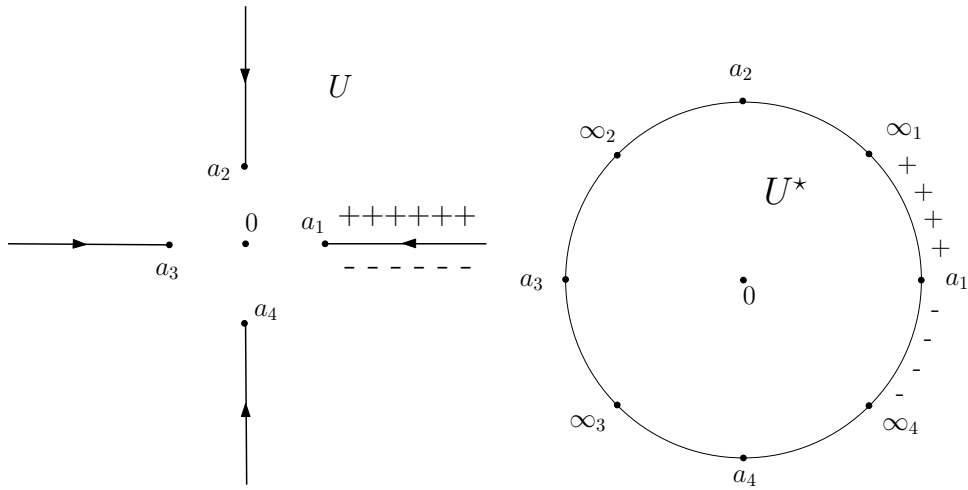

Figure 1.4: Region U (left) and its prime end compactification U^* (right).

Proposition 1.4.1. *Given $\omega \in \mathbb{R} \setminus \mathbb{Q}$ and a Denjoy map ϕ , there exists $h \in \mathcal{H}_0$ with rotation number $\rho(h, U) = \bar{\omega}$ and such that h^* is topologically conjugate to ϕ .*

Actually, for every ω we will exhibit two examples in which the regions U are significantly different. Before we start with the construction we need a technical lemma.

Lemma 1.4.2. *Given a Denjoy map ϕ with minimal Cantor set C , there exists a continuous function $\Omega : \mathbb{T} \rightarrow \mathbb{R}$ satisfying*

- (i) $0 \leq \Omega(\theta) \leq \frac{1}{2}$ for each $\theta \in \mathbb{T}$,
- (ii) $\Omega^{-1}(0) = C$,
- (iii) the series $\sum_{n \geq 0} \Omega(\phi^n(\theta))$ and $\sum_{n \leq 0} \Omega(\phi^n(\theta))$ are divergent if $\theta \in \mathbb{T} \setminus C$.

Proof. It is enough to prove the result for some map $\hat{\phi}$ conjugate to ϕ . Following Section 1.2.2 we consider the double sequence of arcs $\{\beta_{n,\lambda}\}_{n \in \mathbb{Z}, \lambda \in \Lambda}$ such that $\mathbb{T} \setminus C$ is the disjoint union of the open arcs $\dot{\beta}_{n,\lambda}$ and $\phi(\beta_{n,\lambda}) = \beta_{n+1,\lambda}$. For convenience we assume that Λ is a subset of $\mathbb{N} \setminus \{0\}$. After lifting the arcs $\beta_{n,\lambda}$ and $\beta_{n+1,\lambda}$ to compact intervals of \mathbb{R} , we consider the unique homeomorphism $A_{n,\lambda} : \beta_{n,\lambda} \rightarrow \beta_{n+1,\lambda}$ whose lift is an increasing affine map. In particular,

$$\frac{\text{dist}_{\mathbb{T}}(A_{n,\lambda}(\theta), C)}{\text{length}(\beta_{n+1,\lambda})} = \frac{\text{dist}(\theta, C)}{\text{length}(\beta_{n,\lambda})} \quad \text{if } \theta \in \beta_{n,\lambda}. \quad (1.1)$$

Next we define the modification of ϕ ,

$$\hat{\phi}(\theta) = \begin{cases} \phi(\theta) & \text{if } \theta \in C \\ A_{n,\lambda}(\theta) & \text{if } \theta \in \beta_{n,\lambda}. \end{cases}$$

It can be proved that $\hat{\phi} : \mathbb{T} \rightarrow \mathbb{T}$ is an orientation-preserving homeomorphism. Since ϕ and $\hat{\phi}$ coincide in C the new map is also a Denjoy map with the same rotation number. Possibly the two maps do not coincide in the interior of the arcs $\beta_{n,\lambda}$ but

$$\phi(\beta_{n,\lambda}) = \hat{\phi}(\beta_{n,\lambda}).$$

This implies that if $\mathcal{P} : \mathbb{T} \rightarrow \mathbb{T}$ is a Cantor function associated to C with $\mathcal{P} \circ \phi = R_\omega \circ \mathcal{P}$, then $\mathcal{P} \circ \hat{\phi} = R_\omega \circ \mathcal{P}$ is also valid. As a result, Markley's invariant $\mathcal{P}(A)$ is common to ϕ and $\hat{\phi}$ and these maps are conjugate. Define

$$\Omega(\theta) = \begin{cases} 0 & \text{if } \theta \in C \\ \frac{1}{\lambda(|n|+1)} \frac{\text{dist}_{\mathbb{T}}(\theta, C)}{\text{length}(\beta_{n,\lambda})} & \text{if } \theta \in \beta_{n,\lambda}. \end{cases} \quad (1.2)$$

We are going to check that this function satisfies the conditions of the lemma when ϕ is replaced by $\hat{\phi}$. The conditions (i) and (ii) are obvious. Notice that $0 \leq \Omega \leq \frac{1}{2}$ everywhere. To check (iii) we pick any point θ_0 in some arc $\beta_{N,\lambda}$. Using the property (1.1) several times we arrive at

$$\frac{\text{dist}_{\mathbb{T}}(\hat{\phi}^n(\theta_0), C)}{\text{length}(\beta_{N+n,\lambda})} = \frac{\text{dist}_{\mathbb{T}}(\theta_0, C)}{\text{length}(\beta_{N,\lambda})}, \quad n \in \mathbb{Z}.$$

Consequently,

$$\Omega(\hat{\phi}^n(\theta_0)) = \frac{|N|+1}{|N+n|+1} \Omega(\theta_0).$$

This proves (iii) since $\sum \Omega(\hat{\phi}^n(\theta_0))$ leads to the harmonic series whenever $\theta_0 \in \dot{\beta}_{N,\lambda}$.

To complete the proof we must check the continuity of Ω at each point of \mathbb{T} . This is obvious for points lying in some open arc $\dot{\beta}_{n,\lambda}$. Let us take a point θ in C and a sequence $\{\theta_r\}$ converging to θ , we must prove that $\Omega(\theta_r) \rightarrow 0$. Since Ω vanishes on C it is sufficient to consider sequences in the complement $\mathbb{T} \setminus C$, say $\theta_r \in \dot{\beta}_{n(r),\lambda(r)}$ for each r . If θ is in the inaccessible set I then the length of the arcs $\beta_{n(r),\lambda(r)}$ has to go to zero and so

$$\max\{|n(r)|, \lambda(r)\} \rightarrow +\infty \text{ as } r \rightarrow +\infty.$$

In consequence

$$\Omega(\theta_r) \leq \frac{1}{2\lambda(r)(|n(r)| + 1)} \rightarrow 0.$$

This proves the continuity at points in I . When θ is in A , the accessible set, it is convenient to discuss the continuity from each side of the point. The point θ being an end point of some $\beta_{n,\lambda}$, the continuity from the side of this arc is automatic. From the other side the continuity is discussed as in the inaccessible case. \square

The proof of Proposition 1.4.1 involves an explicit construction of h based on ϕ and the function Ω given by the previous lemma. We define h in polar coordinates θ and ρ . The same notation will be employed for a function defined on \mathbb{T} and its lift defined on \mathbb{R} . Define $h : \mathbb{R}^2 \rightarrow \mathbb{R}^2$ by

$$(\theta, \rho) \mapsto (\phi(\theta), R(\theta, \rho))$$

where $R : \mathbb{T} \times [0, +\infty) \rightarrow [0, +\infty)$ is the function such that $R(\theta, \cdot)$ is piecewise linear, with corner points at $\rho = \frac{1}{2}$ and $\rho = 1$ and satisfying

$$\begin{aligned} R(\theta, 0) = 0, \quad R(\theta, \frac{1}{2}) = \frac{1}{4}, \quad R(\theta, 1) = 1 - \Omega(\theta) \\ \frac{\partial R}{\partial \rho}(\theta, \rho) = \frac{1}{2} \text{ if } \rho > 1. \end{aligned}$$

For later computations it is convenient to present R more explicitly,

$$R(\theta, \rho) = \begin{cases} \frac{1}{2}\rho & \text{if } \rho \leq \frac{1}{2} \\ (\frac{3}{4} - \Omega(\theta))(2\rho - 1) + \frac{1}{4} & \text{if } \frac{1}{2} < \rho \leq 1 \\ \frac{1}{2}\rho + \frac{1}{2} - \Omega(\theta) & \text{if } \rho > 1 \end{cases}$$

It is easy to prove that h is an orientation-preserving homeomorphism with $h(0) = 0$. To prove the dissipativity it is sufficient to invoke the inequality

$$R(\theta, \rho) \leq \frac{1}{2}\rho + \frac{1}{2} \text{ if } \rho \geq 1.$$

It implies that every disk $\rho \leq r$ with radius $r > 1$ is mapped into its interior. Moreover every orbit in \mathbb{R}^2 is attracted (uniformly on compact sets) by any of these disks.

Similarly, the inequality

$$R(\theta, \rho) < \rho \text{ if } 0 < \rho < 1$$

can be employed to prove that the origin is attracting and the open disk $\rho < 1$ is contained in U . Indeed, it is possible to give an exact description of the region of attraction. We claim that

$$U = \mathbb{R}^2 \setminus \{(\theta, \rho) : \theta \in C, \rho \geq 1\}. \quad (1.3)$$

Assume first that (θ_0, ρ_0) is a point with $\theta_0 \in C$ and $\rho_0 \geq 1$ and let $\{(\theta_n, \rho_n)\}$ be the corresponding orbit. The invariance of C under ϕ implies that $\Omega(\theta_n) = 0$ for each n and so

$$\rho_{n+1} = \frac{1}{2}\rho_n + \frac{1}{2}, \quad n \in \mathbb{Z}.$$

This implies that ρ_n decreases to 1 as $n \rightarrow +\infty$ and so (θ_0, ρ_0) is not in U . To prove the reversed inclusion in (1.3) we take an orbit $\{(\theta_n, \rho_n)\}$ with $\theta_0 \notin C$ and prove that some iterate must enter into the disk $\rho < 1$. This is sufficient to guarantee that (θ_0, ρ_0) is in U . Assuming by contradiction that $\rho_n \geq 1$ for each $n \geq 0$ one is lead to

$$\rho_{n+1} = \frac{1}{2}\rho_n + \frac{1}{2} - \Omega(\theta_n) \leq \rho_n - \Omega(\theta_n), \quad n \geq 0.$$

Consequently,

$$\rho_n \leq \rho_0 - \sum_{k=0}^{n-1} \Omega(\phi^k(\theta_0))$$

and so ρ_n should become negative for large n . This argument completes the proof of (1.3).

Now, it is clear that $h \in \mathcal{H}_0$ since U is an unbounded subset of \mathbb{R}^2 with $U \neq \mathbb{R}^2$. Our next task is to describe the space of prime ends $\mathbb{P} = \mathbb{P}(U)$. The boundary of U in the Riemann sphere $S^2 = \mathbb{R}^2 \cup \{\infty\}$ is composed by the rays $\{(\theta, \rho) : \rho \geq 1\}$ with $\theta \in C$ together with the point at infinity. The set of points in $\partial_{S^2}U$ that are accessible from U is $A_1 \cup A_2 \cup \{\infty\}$ with

$$A_1 = \{(\theta, 1) : \theta \in C\}, \quad A_2 = \{(\theta, \rho) : \theta \in A, \rho > 1\}.$$

Every prime end is obtained via an arc tending to one of these points. The prime ends associated to A_1 satisfy

$$\Pi(\mathfrak{p}_1) = \{(\theta, 1)\} \text{ and } I(\mathfrak{p}_1) = \{(\theta, r) : r \geq 1\} \cup \{\infty\}.$$

Recall that $\Pi(\mathfrak{p}_1)$ is the set of principal points and $I(\mathfrak{p}_1)$ is the impression of \mathfrak{p}_1 . Prime ends associated to A_2 satisfy

$$\Pi(\mathfrak{p}_2) = I(\mathfrak{p}_2) = \{(\theta, \rho)\}.$$

Finally, we denote $\infty_{n,\lambda}$ the prime end associated to the chain of cross cuts

$$C_k = \{(\theta, k) : \theta \in \beta_{n,\lambda}\}, \quad k = 1, 2, \dots$$

Notice that $\Pi(\infty_{n,\lambda}) = I(\infty_{n,\lambda}) = \{\infty\}$.

Once we understand the structure of \mathbb{P} we can describe the dynamics of h^* . Given an arc $\beta_{n,\lambda}$ with end points $a = a_{n,\lambda}, b = b_{n,\lambda}$, we consider the arc $\hat{\beta}_{n,\lambda}$ in \mathbb{P} having end points at the corresponding prime ends \hat{a}, \hat{b} and passing through $\infty_{n,\lambda}$. Figure 1.6 illustrates this definition.

We know that $\phi(\beta_{n,\lambda}) = \beta_{n+1,\lambda}$ and this implies that $h^*(\hat{\beta}_{n,\lambda}) = \hat{\beta}_{n+1,\lambda}$. Let \mathfrak{p}_θ denote the prime end with principal point $(\theta, 1)$ and $\theta \in C$. Then

$$\hat{C} = \{\mathfrak{p}_\theta : \theta \in C\}$$

is a Cantor set invariant under h^* . From here it is easy to conclude that h^* is a Denjoy map with rotation number ω . To prove the conjugacy of h^* and ϕ it is sufficient to compute Markley's invariant for h^* . Let $\mathcal{P} : \mathbb{T} \rightarrow \mathbb{T}$ be a Cantor function associated to ϕ , so that $\mathcal{P} \circ \phi = R_\omega \circ \mathcal{P}$. Define

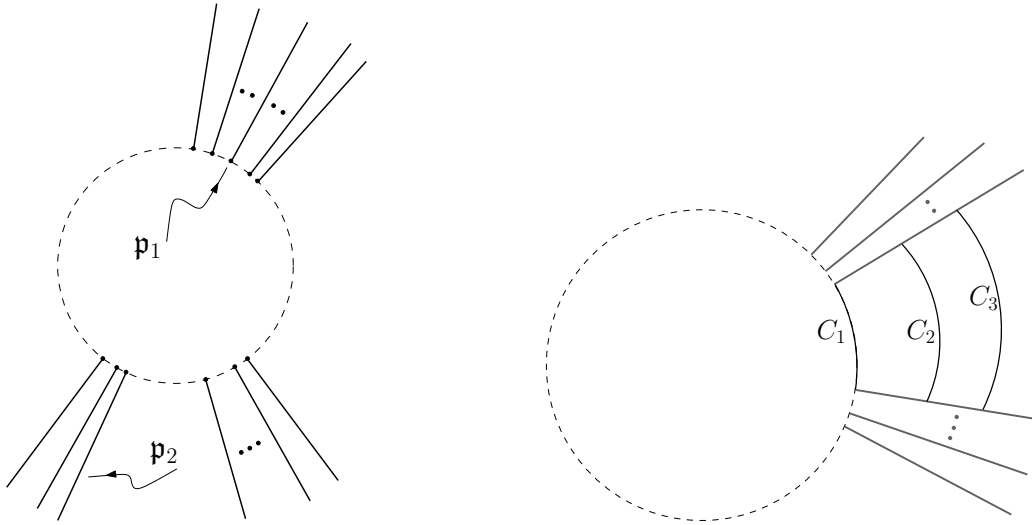

Figure 1.5: Description of the prime ends of U .

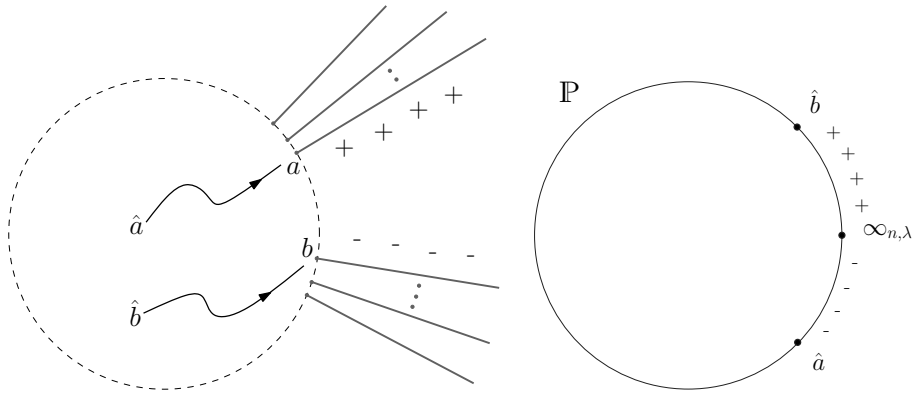

Figure 1.6: Prime ends \hat{a}, \hat{b} and $\infty_{n,\lambda}$.

$$\mathcal{P}^* : \mathbb{P} \rightarrow \mathbb{T}, \quad \mathcal{P}^*(\mathbf{p}) = \begin{cases} \mathcal{P}(\theta) & \text{if } \Pi(\mathbf{p}) = \{(\theta, r)\} \\ \mathcal{P}(\beta_{n,\lambda}) & \text{if } \mathbf{p} = \infty_{n,\lambda} \end{cases}$$

This is a Cantor function associated to \hat{C} with $\mathcal{P}^* \circ h^* = R_\omega \circ \mathcal{P}^*$. The accessible set $\hat{A} = \{\mathbf{p}_\theta : \theta \in A\}$ is mapped by \mathcal{P}^* onto $\mathcal{P}^*(\hat{A}) = \mathcal{P}(A)$ and so the conjugacy follows. The proof of Proposition 1.4.1 is now complete.

It is interesting to notice that h has no periodic orbits (apart from the origin) and that ∞ is accessible from U . The boundary in \mathbb{R}^2 of the region of attraction has uncountably many connected components. This is consistent with Theorem 10 in [OR11]. There it is proved that if ∞ is accessible from U and ∂U has a finite number of components then there is a periodic orbit in $\mathbb{R}^2 \setminus U$.

We will construct a new homeomorphism $h_{new} \in \mathcal{H}_0$ in the conditions of Proposition

1.4.1 and such that the region of attraction U_{new} has a connected boundary in \mathbb{R}^2 . Moreover, the point of infinity will not be accessible from U_{new} . This modification will be obtained by imposing that the number of iterations a point $(\theta, \rho) \in U$ needs to enter the open unit disk is bounded for an angle θ fixed. Thus, for any $\theta \notin C$ only a segment of the ray with angle θ will be contained in the region of attraction of 0.

We start again with the Denjoy map ϕ and the function Ω given by Lemma 1.4.2. The sets

$$F_+ = \bigcup_{\substack{n \geq 0 \\ \lambda \in \Lambda}} \beta_{n,\lambda} \cup C, \quad F_- = \bigcup_{\substack{n < 0 \\ \lambda \in \Lambda}} \beta_{n,\lambda} \cup C$$

are closed in \mathbb{T} . To justify this it is enough to recall that C is the limit set of any orbit of ϕ . The function Ω vanishes on $F_+ \cap F_- = C$ and so the function

$$\Omega_{new}(\theta) = \begin{cases} \Omega(\theta) & \text{if } \theta \in F_- \\ 0 & \text{if } \theta \in F_+ \end{cases}$$

is continuous. Replacing Ω by Ω_{new} the construction of h can be repeated and a new map

$$h_{new}(\theta, \rho) = (\phi(\theta), R_{new}(\theta, \rho))$$

$$h_{new} : \theta_1 = \phi(\theta), \quad \rho_1 = R_{new}(\theta, \rho)$$

is obtained. Notice that $R_{new}(\theta, 1) = 1$ for every $\theta \in F_+$. As before, it can be proven that $h_{new} \in \mathcal{H}_0$, the only essential differences being in the region of attraction of 0. We claim that it can be described as

$$U_{new} = \{(\theta, \rho) : \rho < \sigma(\theta)\}$$

where $\sigma : \mathbb{T} \rightarrow \mathbb{R}$ is a function satisfying

$$\sigma \geq 1 \text{ everywhere and } \sup_{\mathbb{T}} \sigma = +\infty.$$

This implies that U_{new} is a proper and unbounded subset of \mathbb{R}^2 and so $h_{new} \in \mathcal{H}_0$.

We find σ in several steps. First notice that $\Delta = \{(\theta, \rho) \in \mathbb{R}^2 : \rho < 1\}$, the open unit disk, is contained in U_{new} . Next, we prove that

$$U_{new} \cap \{\theta \in F_+\} \subset \Delta. \tag{1.4}$$

This is a consequence of the positive invariance under h_{new} of the set

$$M = \{(\theta, \rho) : \theta \in F_+, \rho = 1\}.$$

The inclusion $h_{new}(M) \subset M$ is proved using $\phi(F_+) \subset F_+$, $\Omega = 0$ on F_+ and the definition of h_{new} .

After having checked (1.4) we must analyze $U_{new} \cap \{\theta \in F_-\}$. Consider the arcs

$$\gamma_{n,\lambda} = h_{new}^n(\beta_{0,\lambda} \times \{1\}), \quad n \in \mathbb{Z}, \quad \lambda \in \Lambda.$$

The previous discussions imply that $\gamma_{n,\lambda} = \beta_{n,\lambda} \times \{1\}$ if $n \geq 0$. For negative n the arcs $\gamma_{n,\lambda}$ have the same end points as $\beta_{n,\lambda} \times \{1\}$ but the open arcs $\dot{\gamma}_{n,\lambda}$ are contained in $\{\rho > 1\}$.

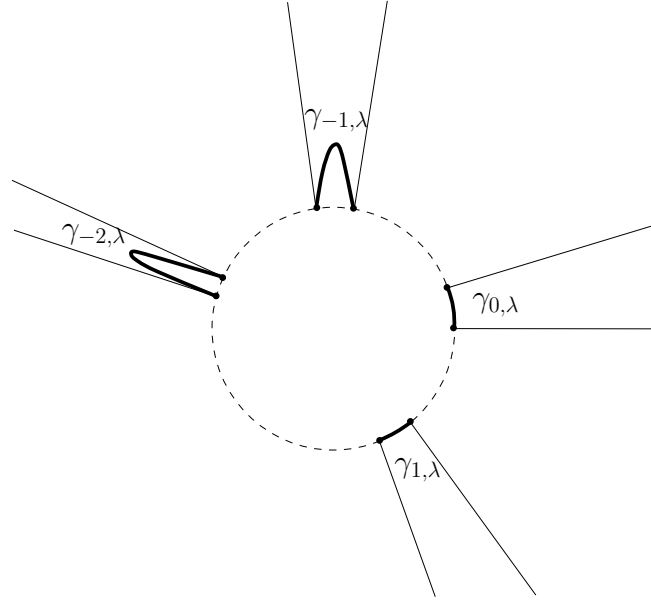
Figure 1.7: Arcs $\gamma_{n,\lambda}$.

Going back to the definition of h_{new} we observe that every orbit $\{(\theta_n, \rho_n)\}$ with $\theta_0 \in \beta_{0,\lambda}$ and $\rho_0 = 1$ satisfies

$$\rho_{n+1} = \frac{1}{2}\rho_n + \frac{1}{2} - \Omega_{new}(\theta_n), \quad n < 0.$$

This recurrence leads to an explicit parametrization of the arc $\gamma_{n,\lambda}$ as $\rho = \sigma_{n,\lambda}(\theta)$ with

$$\sigma_{n,\lambda}(\theta) = 1 + \sum_{k=0}^{|n|-1} 2^{k+1} \Omega_{new}(\phi^k(\theta)), \quad \theta \in \beta_{n,\lambda}.$$

Note that the previous expression is valid for every integer n .

Finally, we can define σ as

$$\sigma(\theta) = \begin{cases} \sigma_{n,\lambda}(\theta) & \text{if } \theta \in \beta_{n,\lambda}, n < 0, \lambda \in \Lambda \\ 1 & \text{if } \theta \in F_+. \end{cases}$$

To prove that σ is unbounded it is sufficient to fix some $\lambda \in \Lambda$ and $\theta \in \dot{\beta}_{0,\lambda}$ and notice that, for negative n , by Lemma 1.4.2

$$\sigma(\phi^n(\theta)) \geq 1 + 2 \sum_{h=0}^{|n|-1} \Omega(\phi^{-h}(\theta)) \rightarrow +\infty \text{ as } n \rightarrow -\infty.$$

Evidently, σ is continuous in every open arc $\beta_{n,\lambda}$. Moreover, σ attains its minimum in every point of the Cantor set C . It follows that σ is lower semi-continuous.

To describe ∂U_{new} we apply the following lemma dealing with domains whose boundary is a ‘‘Cantorian sun’’.

Lemma 1.4.3. *Let C be a Cantor set in \mathbb{T} and $\sigma : \mathbb{T} \rightarrow [1, \infty)$ a lower semi-continuous function that is continuous at each point in $\mathbb{T} \setminus C$ and satisfies*

$$\sigma(\theta_*) = 1, \quad \limsup_{\theta \rightarrow \theta_*} \sigma(\theta) = +\infty$$

at each $\theta_* \in C$. Then

$$U = \{(\theta, \rho) : \rho < \sigma(\theta)\}$$

is an open and simply connected subset of \mathbb{R}^2 with connected boundary given by

$$\partial U = \{(\theta, \sigma(\theta)) : \theta \in \mathbb{T}\} \cup \{(\theta, \rho) : \theta \in C, \rho \geq 1\}.$$

The proof of this lemma is straightforward and we do not give the details. However it remains to check that the function σ defining U_{new} satisfies the conditions of the lemma. The only delicate point is to prove that

$$\limsup_{\theta \rightarrow \theta_*} \sigma(\theta) = +\infty \quad \text{for each } \theta_* \in C.$$

This is more or less a repetition of a previous argument. We fix $\lambda \in \Lambda$ and $\theta \in \dot{\beta}_{0,\lambda}$. Since the point θ_* is in the α -limit set of $\{\phi^n(\theta)\}$, there exists a sequence of integers $\tau(n) \rightarrow -\infty$ and such that $\phi^{\tau(n)}(\theta) \rightarrow \theta_*$. We know that $\sigma(\phi^{\tau(n)}(\theta)) \rightarrow +\infty$ and so the claim is proved.

Now we have a complete knowledge of the domain U_{new} and it is easy to describe the space of prime ends. In this case there is a natural bijection between prime ends and accessible points of $\partial_{S^2} U_{new} = \partial U_{new} \cup \{\infty\}$. Each prime end is defined via the radial arc

$$\Gamma_\theta : t \in [0, 1] \mapsto (\theta, t\sigma(\theta)).$$

Since h_{new} transforms Γ_θ into an arc equivalent to $\Gamma_{\phi(\theta)}$ we deduce that h^* is conjugate to ϕ . Notice that ∞ is not an accessible point of $\partial_{S^2} U$ in this family of examples, unlike the previous construction.

1.5 Irrational rotations do not appear on prime ends

It is easy to construct homeomorphisms with an attractor such that the map induced on prime ends is a rotation. As an example consider the time 1 map $h = \phi_1$ associated to the flow $\{\phi_t\}_{t \in \mathbb{R}}$ defined by

$$\dot{\theta} = \omega, \quad \dot{\rho} = \frac{\rho(\rho - 1)(2 - \rho)}{1 + \rho^2}$$

with $\omega \in \mathbb{R}$. The map h is dissipative since every orbit enters the ball $\rho \leq 2 + \varepsilon$ as the derivative of ρ is strictly negative outside it. Furthermore, the origin is attracting and the region of attraction is the disk $\rho < 1$. It is easy to show that h^* is topologically conjugate to R_ω . In this section we prove that this cannot occur if h is in the class \mathcal{H}_0 and $\omega = \rho(h, U) \in \mathbb{R} \setminus \mathbb{Q}$.

Theorem 1.5.1. *Assume that $h \in \mathcal{H}_0$ and the rotation number $\rho(h, U)$ is irrational. Then, the induced map $h^* : \mathbb{P} \rightarrow \mathbb{P}$ is a Denjoy homeomorphism.*

In this subsection we present two proofs of this theorem. The first one appears in [HOR12] and essentially relies in the fact that if the orbit of a cross-cut is composed of pairwise disjoint arcs then h^* is not an irrational rotation. The idea for the second proof is that if the orbit of the prime end defined by an accessible point $a \in \partial U$ is dense in \mathbb{P} then the orbit of a is dense in ∂U as well.

We need some preliminaries before the first proof. Let us state a result on General Topology taken from [Ma82].

Lemma 1.5.2. *Let X be a connected topological space and let A and B be open and connected subsets of X such that the boundaries ∂A and ∂B are connected and satisfy*

$$\partial A \neq \emptyset, \quad \partial B \neq \emptyset, \quad \partial A \cap \partial B = \emptyset.$$

Then one of the following alternatives holds:

$$(i) X = A \cup B \quad (ii) \text{cl}_X A \subset B \quad (iii) \text{cl}_X B \subset A \quad (iv) \text{cl}_X A \cap \text{cl}_X B = \emptyset.$$

Note that we denote $\text{cl}(A), \text{cl}_X A$ the closure of A and its closure in the relative topology of X , respectively. For the proof we refer to [Ma82].

Let γ be a cross-cut of U with end points a, b and denote V one of the components of $U \setminus \gamma$. The set

$$\tilde{V} = \{\mathfrak{p} \in \mathbb{P} : \mathfrak{p} \text{ divides } V\}.$$

is an open arc in \mathbb{P} . The closure of \tilde{V} is a closed arc whose end points, \mathfrak{p}_a and \mathfrak{p}_b , are the accessible prime ends determined by γ . Denote the closure $\alpha_V = \text{cl}_{\mathbb{P}}(\tilde{V})$ and notice that α_V is a proper arc since its end points are different.

Lemma 1.5.3. *Using the previous notations, assume that $h \in \mathcal{H}_0$ and there exists a crosscut γ in U with*

$$h^k(V) \subset V$$

for some $k \in \mathbb{Z} \setminus \{0\}$. Then $\rho(h, U)$ is rational.

Proof. Since h is a homeomorphism, \mathfrak{p} divides V whenever $h^*(\mathfrak{p})$ divides $h(V)$. In consequence $h^*(\tilde{V}) = \widetilde{h(V)}$ or, more generally,

$$(h^*)^k(\tilde{V}) = \widetilde{h^k(V)}.$$

The assumption $h^k(V) \subset V$ implies that $\widetilde{h^k(V)} \subset \tilde{V}$. Hence $(h^*)^k(\tilde{V}) \subset \tilde{V}$ and, taking closures, $(h^*)^k(\alpha_V) \subset \alpha_V$. Brouwer fixed point Theorem in 1 dimension implies that h^* has a periodic point. From the classification of circle homeomorphisms in Theorem 1.2.2 we conclude that $\rho(h, U)$ is a rational number of the type $\frac{n}{k}$. \square

We are ready to prove the main result.

First proof of Theorem 1.5.1. The proof will consist in finding an open set G in \mathbb{P} with

$$G \neq \emptyset, \quad (h^*)^k(G) \cap G = \emptyset \quad \text{if } k \in \mathbb{Z} \setminus \{0\}.$$

This is not possible if all orbits are recurrent, as it is the case in an irrational rotation. To construct G we proceed by steps.

Step 1. Construction of a crosscut γ in U with $\dot{\gamma} \cap h^k(\dot{\gamma}) = \emptyset$ if $k \in \mathbb{Z} \setminus \{0\}$.

In the following we will work with the extension of the map h to the Riemann sphere with $h(\infty) = \infty$. Recall that the map being dissipative is equivalent to ∞ being a repeller, that is an attracting fixed point for h^{-1} . Let W denote the region of repulsion of ∞ for h ,

$$W = \{x \in S^2 : h^n(x) \rightarrow \infty \text{ as } n \rightarrow -\infty\}.$$

Equivalently, W is the basin of attraction of ∞ for the map h^{-1} . Then, W is a simply connected open subset of S^2 and the restriction of h to W , $h_W : W \rightarrow W$, is topologically conjugate to the dilation $\mathbb{C} \rightarrow \mathbb{C}$, $z \mapsto 2z$ (see [Ke34] and [BoK98] for more details). Since W is a neighborhood of ∞ and U is unbounded, these two sets must have a non void intersection. Let x_0 be a point in $W \cap U$. Using that h_W is a topological dilation we can find an arc $\Gamma \subset W$ with end points at x_0 and ∞ and such that $\Gamma \subset h(\Gamma)$. It will be convenient to employ the natural ordering in Γ having the minimum at x_0 and the maximum at ∞ . In particular, an open sub-arc of Γ can be expressed as an interval $(a, b)_\Gamma$ with $a < b$, $a, b \in \Gamma$. Since Γ lies inside W it is easy to describe the backward dynamics of h on Γ . Given any $y_0 \in \Gamma \setminus \{\infty\}$, the sequence $y_n = h^n(y_0)$ satisfies $y_n \in \Gamma$ if $n \leq 0$ and

$$y_0 < y_{-1} < y_{-2} < \dots < y_n < \dots \rightarrow \infty \text{ as } n \rightarrow -\infty.$$

We claim that Γ is not contained in U , for otherwise we could apply Lemma 1.2.4 to deduce that the rotation number vanishes.

Let us fix some $y_0 \in \Gamma \setminus U$. Since both orbits $y_n = h^n(y_0)$ and $x_n = h^n(x_0)$ converge to ∞ as $n \rightarrow -\infty$, there exist two negative integers N and M such that $y_0 < x_N < y_M$. Let J be the connected component of $\Gamma \cap U$ containing x_N .

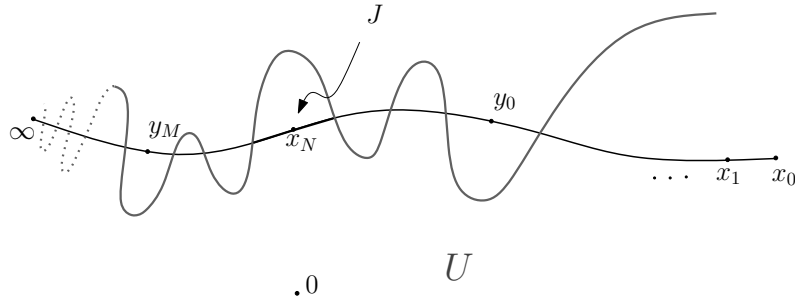

Figure 1.8: Arc Γ in Step 1.

Since y_0 and y_M are not in U , the set J must be an open sub-arc of Γ with end points a and b , $y_0 \leq a < x_N < b \leq y_M$. Moreover, $a, b \in \partial U$. This arc has the important property

$$J \cap h^k(J) = \emptyset \text{ if } k < 0.$$

To check this notice that $J = (a, b)_\Gamma$ and $h^k(J) = (h^k(a), h^k(b))_\Gamma$. Since $a < h^k(a)$ and $b < h^k(b)$, a non-empty intersection would imply that $h^k(a)$ belongs to J . This is not possible since J is contained in U . The goal of the first step is achieved taking $\gamma = J \cup \{a, b\}$. Notice that $J \cap h^k(J) = \emptyset$ is equivalent to $J \cap h^{-k}(J) = \emptyset$ and also that the origin cannot belong to γ . From now on V is the connected component of $U \setminus \gamma$ with $0 \notin V$.

Step 2. $V \cap h^k(V) = \emptyset$ if $k \in \mathbb{Z} \setminus \{0\}$.

We apply Lemma 1.5.2 with $X = U, A = V$ and $B = h^k(V)$. Then $\partial A = \dot{\gamma}$ and $\partial B = h^k(\dot{\gamma})$. The condition $\partial A \cap \partial B = \emptyset$ follows from Step 1. Let us eliminate the first three alternatives. The alternative (i) cannot hold because the origin is not in $V \cup h^k(V)$. Assume now that (ii) or (iii) holds, then either $h^{-k}(V) \subset V$ or $h^k(V) \subset V$. Then we could apply Lemma 1.5.3 to conclude that ρ is rational. In conclusion (iv) must hold and so the claim of Step 2 is valid.

Step 3. $\tilde{V} \cap (h^*)^k(\tilde{V}) = \emptyset$ if $k \in \mathbb{Z} \setminus \{0\}$.

Let \mathfrak{p} be a prime end in \tilde{V} . Then every sequence of crosscuts defining \mathfrak{p} must eventually enter into V . This means that $V_n \subset V$ for large n . If \mathfrak{p} would also belong to $(h^*)^k(\tilde{V}) = \widetilde{h^k(V)}$ then the sequence of crosscuts should also enter into $h^k(V)$, meaning that $V_n \subset h^k(V)$ for large n . Since we know that $V \cap h^k(V) = \emptyset$ such a prime end cannot exist.

The proof is complete since we can take $G = \tilde{V}$. □

Now, we include a second proof which is even more transparent. It needs a basic result from prime end theory: an accessible point of the boundary of U defines a prime end.

Second proof of Theorem 1.5.1. Since h is dissipative, the positive orbit of every point in \mathbb{R}^2 is bounded. A standard argument shows that this is equally true for compact sets, i.e. for every compact in the plane $K, \bigcup_{n \geq 0} h^n(K)$ is bounded.

Let us argue by contradiction. Assume h^* is not a Denjoy homeomorphism. By the classification of circle homeomorphisms, Theorem 1.2.2, every positive orbit of h^* is dense in \mathbb{P} . Take an accessible point $a \neq \infty$ of the boundary of U and a closed arc γ connecting 0 to a with $\gamma \subset U \cup \{a\}$. It defines a prime end denoted \mathfrak{p}_a . Since γ is compact, the set

$$\Gamma = \bigcup_{n \geq 0} h^n(\gamma)$$

is bounded.

Let η be a cross-cut of U, V the connected component of $U \setminus \eta$ which does not contain 0 and

$$\tilde{V} = \{\mathfrak{p} \in \mathbb{P} : \mathfrak{p} \text{ divides } V\}.$$

The positive orbit of \mathfrak{p}_a by h^* is dense in \mathbb{P} . In particular, there exists $k \geq 0$ such that $(h^*)^k(\mathfrak{p}_a) \in \tilde{V}$. The arc $h^k(\gamma)$ connects 0 to $h^k(a)$ and lies in $U \cup \{h^k(a)\}$, so $h^k(a)$ is an accessible point adherent to V and we deduce that $h^k(\gamma) \cap \eta \neq \emptyset$. Therefore, Γ meets any cross-cut of U . However, this is certainly impossible as U is unbounded and, evidently, there exist cross-cuts of U which do not meet the bounded set Γ . □

Remark 1.5.4. Both proofs lead to a result slightly more general than Theorem 1.5.1.

“Let $h : \mathbb{R}^2 \rightarrow \mathbb{R}^2$ be an orientation-preserving, dissipative homeomorphism with $h(0) = 0$. Let U be a proper, unbounded and simply connected open subset of \mathbb{R}^2 with $0 \in U$ and $h(U) = U$. Assume that $\rho(h, U)$ is irrational, then $h^ : \mathbb{P} \rightarrow \mathbb{P}$ is a Denjoy homeomorphism.”*

Notice that 0 is not necessarily an attractor and U may contain more periodic points.

1.6 About the existence of periodic points

1.6.1 Partial converse result

Given a homeomorphism h of the plane the set of periodic points is

$$\text{Per}(h) = \{x \in \mathbb{R}^2 : h^n(x) = x \text{ for some } n \neq 0\}.$$

It was proved in [OR11] that every h in \mathcal{H}_0 with rational rotation number has periodic points in $\mathbb{R}^2 \setminus U$. The examples constructed in Section 1.4 with irrational rotation number satisfy $\text{Per}(h) = \{0\}$. Unfortunately, this property does not give a characterization of $\rho(h, U) \in \mathbb{R} \setminus \mathbb{Q}$ in the class \mathcal{H}_0 . In Subsubsection 1.6.2 we will construct a homeomorphism in \mathcal{H}_0 with irrational rotation number and a fixed point outside U . The idea will be to twist the previous examples, which had a product structure. However, if we impose an extra condition on the region of attraction we obtain the desired characterization. The additional assumption is the following: the point of infinity is accessible from the region of attraction. Notice that this condition holds for the first example in Section 1.4 but not for the second one.

Theorem 1.6.1. *Let h be a map in \mathcal{H}_0 such that ∞ is accessible from U . Then the following statements are equivalent:*

- (i) $\rho(h, U)$ is irrational.
- (ii) $\text{Per}(h) = \{0\}$.

For the proof we need a preliminary result on dynamics in \mathbb{T} .

Lemma 1.6.2. *Assume that $\phi : \mathbb{T} \rightarrow \mathbb{T}$ is an orientation-preserving homeomorphism with irrational rotation number and let B be a compact subset of \mathbb{T} with $B \subset \phi(B)$. In addition assume that there exists some $\theta \in \mathbb{T}$ such that B is contained in the closed arc with end points θ and $\phi(\theta)$. Then B is the empty set.*

Proof. By a contradiction argument assume that B contains at least one point, say $\theta \in B$. Then B also contains the backward orbit $\{\phi^n(\theta)\}_{n \leq 0}$ and the α -limit set $L_\alpha(\theta)$. Here we have used that B is negatively invariant and compact. If $L_\alpha(\theta) = \mathbb{T}$ we have reached already a contradiction because B is contained in an arc. From now on we assume that $L_\alpha(\theta)$ is a Cantor set. Let γ be the arc with end points θ and $\phi(\theta)$ such that $\dot{\gamma} \cap B = \emptyset$. Then $\phi(\dot{\gamma}) \cap \phi(B) = \emptyset$ implying that $\phi(\dot{\gamma}) \cap B = \emptyset$. In general,

$$\dot{\gamma}_n \cap B = \emptyset, \quad n \geq 0,$$

where $\gamma_n = \phi^n(\gamma)$. The arcs γ_n and γ_{n+1} have a common end point, namely $\phi^{n+1}(\theta)$, and so $\Gamma = \bigcup_{n \geq 0} \gamma_n$ is a connected subset of \mathbb{T} . We claim that $\Gamma \neq \mathbb{T}$. Indeed $\Gamma \cap B$ is at most countable while B is uncountable since it contains a Cantor set. At this point we can say that Γ is homeomorphic to an interval of \mathbb{R} (closed, open or half-open) and $\phi(\Gamma) \subset \Gamma$. Taking some point $\varphi \in \Gamma$ we notice that $\{\phi^n(\varphi)\}_{n \geq 0}$ must converge to some point in the closure of Γ . This point should be fixed and we arrive to contradiction since we are assuming that the rotation number is irrational. \square

Proof of Theorem 1.6.1. (ii) \Rightarrow (i) This is a consequence of Proposition 2 in [OR11]. If (i) does not hold then $\rho = \frac{m}{n} \in \mathbb{Q}$ and so the map h^n satisfies $h^n(U) = U$ and $\rho(h^n, U) = 0$. Then h^n has a fixed point in $\mathbb{R}^2 \setminus U$ and so (ii) does not hold. Notice that we do not need to assume that ∞ is accessible from U in the previous argument.

(i) \Rightarrow (ii) By a contradiction argument assume that y_0 is a fixed point in $\mathbb{R}^2 \setminus U$. In principle the contradiction argument would begin with a periodic point in $\mathbb{R}^2 \setminus U$ but then we can replace h by h^N for suitable N . We structure the proof by steps.

Step 1. There exist two arcs γ_0 and γ_1 going from 0 to ∞ and satisfying

- $\gamma_i \setminus \{\infty\} \subset U$, $i = 0, 1$.
- $\gamma_0 \cap \gamma_1 = \{0, \infty\}$.
- Let ∞_0 and ∞_1 be the prime ends determined by γ_0 and γ_1 , then $h^*(\infty_0) = \infty_1$.

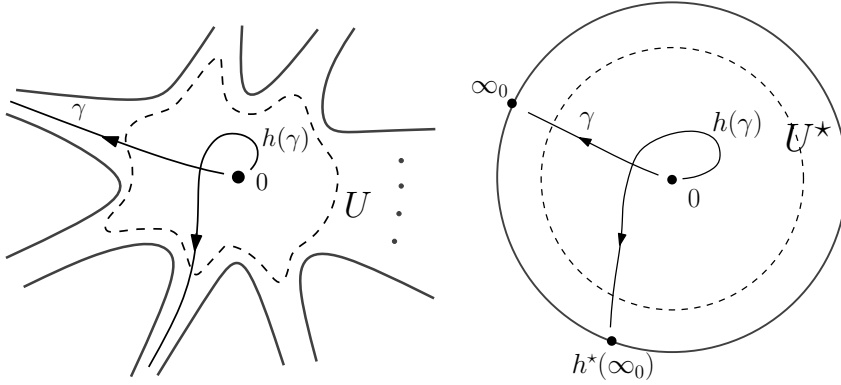

Figure 1.9: Arcs $\gamma, h(\gamma)$ in U .

By assumption, ∞ is accessible from U so there is an arc γ going from 0 to ∞ such that $\gamma \setminus \{\infty\} \subset U$. This arc determines a prime end, say $\infty_0 \in \mathbb{P}$. From (i) we know that ρ is irrational so h^* has not fixed point. In particular $h^*(\infty_0) \neq \infty_0$ and $h^*(\infty_0)$ is the prime end determined by the arc $h(\gamma)$. In general the arcs γ and $h(\gamma)$ cannot be chosen as γ_0 and γ_1 since it could occur that they have some crossings, as it is indicated in the Figure 1.9.

The arcs in U^* defined as $(\gamma \setminus \{\infty\}) \cup \{\infty_0\}$ and $(h(\gamma) \setminus \{\infty\}) \cup \{h^*(\infty_0)\}$ connect the origin to ∞_0 and $\infty_1 := h^*(\infty_0)$ respectively. Since these two points of \mathbb{P} do not coincide, it is possible to find a disk centered at the origin of U^* such that the two arcs do not meet outside the disk. Going back to U via the Riemann map we find a topological disk $\Delta \subset U$ with $0 \in \text{int}(\Delta)$ and $[\gamma \cap h(\gamma)] \setminus \{\infty\} \subset \text{int}(\Delta)$. Denote γ^∞ and $h(\gamma)^\infty$ the connected components of $\gamma \cap (S^2 \setminus \Delta)$ and $h(\gamma) \cap (S^2 \setminus \Delta)$, respectively, which contain ∞ .

The arcs γ and $h(\gamma)$ can be modified into new arcs γ_0 and γ_1 from 0 to ∞ , contained in $U \setminus \{\infty\}$ and such that

- $\gamma_0 \cap (S^2 \setminus \Delta) = \gamma^\infty$,
- $\gamma_1 \cap (S^2 \setminus \Delta) = h(\gamma)^\infty$,

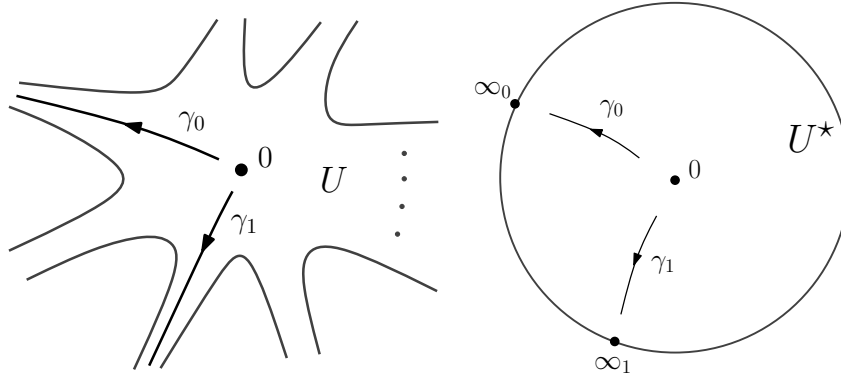

Figure 1.10: New arcs γ_0, γ_1 constructed in *Step 1*.

- $\gamma_0 \cap \gamma_1 = \{0, \infty\}$.

By construction these arcs determine the same prime ends as γ and $h(\gamma)$. See Figure 1.10.

Step 2. The set $A = (\gamma_0 \cup \gamma_1) \setminus \{\infty\}$ decomposes \mathbb{R}^2 , as well as U , in two connected components

$$\mathbb{R}^2 \setminus A = \Lambda_1 \cup \Lambda_2, \quad U \setminus A = \Omega_1 \cup \Omega_2.$$

Moreover, $\Omega_i = \Lambda_i \cap U$, $i = 1, 2$.

The Jordan curve $J = \gamma_0 \cup \gamma_1$ splits S^2 in two components Λ_1 and Λ_2 . Thus,

$$\mathbb{R}^2 \setminus A = S^2 \setminus J = \Lambda_1 \cup \Lambda_2.$$

Looking at the arc $A \cup \{\infty_0, \infty_1\}$ of U^* we observe that also U is split by A in two components Ω_1 and Ω_2 . The Jordan-Schönflies Theorem applied to the Jordan curve J implies that $\Lambda_i \cap U \neq \emptyset$ for $i = 1, 2$. The sets Ω_i are connected and contained in $\mathbb{R}^2 \setminus A$. Perhaps after labelling the sets again we get the inclusions $\Omega_i \subset \Lambda_i$, $i = 1, 2$. An easy argument now shows that Ω_i is indeed the intersection of Λ_i and U .

Step 3. There exists a continuum K connecting the fixed point y_0 and U and satisfying

$$h^{-1}(K) \subset K, \quad K \cap [\gamma_0 \cup \gamma_1] = \emptyset.$$

The restriction of h to the region of attraction U is topologically conjugate to the contraction $\mathbb{C} \rightarrow \mathbb{C}$, $z \mapsto \frac{1}{2}z$. Hence we can find a topological disk D_0 with

$$D_0 \subset U, \quad 0 \in \text{int}(D_0), \quad h(D_0) \subset \text{int}(D_0).$$

Similarly we know that the restriction of h to the region of repulsion W of ∞ is conjugate to the dilation $z \mapsto 2z$. This allows us to find a second topological disk D_∞ disjoint with D_0 and satisfying

$$D_\infty \subset W, \quad \infty \in \text{int}_{S^2}(D_\infty), \quad D_\infty \subset h(\text{int}_{S^2}(D_\infty)),$$

where $\text{int}_{S^2}X$ denotes the interior of X as a subset of the 2-sphere.

The points in D_0 are attracted by the origin as $n \rightarrow +\infty$ while the points in D_∞ come from ∞ . This implies that the fixed point y_0 cannot be in any of the two disks. The set

$$\tilde{K} = \bigcap_{j \geq 0} h^j(\mathbb{R}^2 \setminus \text{int}_{S^2}(D_\infty))$$

is an invariant continuum connecting 0 and y_0 .

Let K_0 be the component of $\tilde{K} \setminus \text{int}(D_0)$ containing y_0 . This set is negatively invariant and connects y_0 and U but it could meet the arc $\gamma_0 \cup \gamma_1$. To exclude this possibility we consider a negative iterate $K = h^{-N}(K_0)$ with N large enough. We claim that this continuum satisfies all the required properties. Since K_0 is a continuum connecting y_0 to ∂D_0 , then K connects y_0 to $h^{-N}(\partial D_0)$, a subset of U . The property of negative invariance is inherited from K_0 . To prove that K does not intersect $\gamma_0 \cup \gamma_1$ we observe that the compact set $\tilde{K} \cap (\gamma_0 \cup \gamma_1)$ is contained in U and so it is uniformly attracted by the origin. We select N so that $h^N(\tilde{K} \cap (\gamma_0 \cup \gamma_1))$ lies inside $\text{int}(D_0)$. This excludes the possibility of having a point x in $K \cap (\gamma_0 \cup \gamma_1)$, for otherwise $y = h^N(x)$ should lie simultaneously in K_0 and $\text{int}(D_0)$.

Step 4. The set

$$B = \text{cl}_{U^*}(K \cap U) \cap \mathbb{P}$$

is non-empty, compact and negatively invariant under h^ .*

From the previous step we know that $K \cap U \neq \emptyset$ and also $K \cap \partial U \neq \emptyset$. Since K is a continuum we can find a sequence $z_n \in K \cap U$ accumulating on ∂U . The accumulation points of $\{z_n\}$ in U^* must belong to \mathbb{P} . This shows that B is non-empty. This set is obviously compact and due to the negative invariance of K under h ,

$$h^*(B) = \text{cl}_{U^*}(h(K) \cap U) \cap \mathbb{P} \supset B.$$

Conclusion. We are ready to arrive at a contradiction. The continuum K must be included in one of the components of $\mathbb{R}^2 \setminus A$, say Λ_1 . Then $K \cap U \subset \Lambda_1 \cap U = \Omega_1$ and all the prime ends in B are inside the arc $\alpha_{\Omega_1} = \text{cl}_{\mathbb{P}}(\tilde{\Omega}_1)$ determined by the crosscut A . This arc has ∞_0 and $\infty_1 = h^*(\infty_0)$ as end points and, according to Lemma 1.6.2, the set B should be empty. This is against Step 4. \square

1.6.2 Counterexample to the conjecture

In this subsection we present an example of a map $h \in \mathcal{H}_0$ having a fixed point outside U . The main idea in the construction, working with an area-preserving twist map was suggested, by Patrice Le Calvez. It shows that the condition $\rho(h, U) \notin \mathbb{R} \setminus \mathbb{Q}$ is not sufficient to guarantee that $\text{Per}(h) = \{0\}$. We need the following technical lemma.

Lemma 1.6.3. *Let $\omega \in \mathbb{R} \setminus \mathbb{Q}$. There exists a Denjoy map ϕ with rotation number $\bar{\omega}$ and an orientation-preserving homeomorphism h of the cylinder given by*

$$(\theta, r) \mapsto (\phi(\theta) + g_0(\theta, r), g_1(\theta, r))$$

for some continuous maps $g_0, g_1 : \mathbb{T} \times \mathbb{R} \rightarrow \mathbb{R}$ which satisfies the following properties:

- (i) $g_1(\theta, r) < r$ for any $\theta \in \mathbb{T}$ and $r < 0$ or $r \geq R$, for some constant $R > 0$.

(ii) $g_1(\theta, 0) \leq 0$ and the inequality is strict for some $\theta \in \mathbb{T}$.

(iii) h does not expand area in the upper semi-cylinder, that is, for any open subset $U \subset \mathbb{T} \times (0, +\infty)$

$$\text{Area}(h(U)) \leq \text{Area}(U).$$

(iv) h has a fixed point.

(v) $g_0(\theta, r) = 0$ provided that $r \leq 0$.

The proof of the lemma is momentarily postponed.

Denote e^- the lower end of the cylinder, it is adherent to $\mathbb{T} \times (-\infty, 0]$. The set $(\mathbb{T} \times \mathbb{R}) \cup \{e^-\}$ with the appropriate topology defined by the end compactification is homeomorphic to \mathbb{R}^2 . Assume that $0 \in \mathbb{R}^2$ corresponds to e^- . It follows from (i) or (ii) that the homeomorphism h from Lemma 1.6.3 fixes e^- so it fixes e^+ as well and, since in the angular coordinate h is defined by the orientation-preserving map ϕ , we deduce that h is orientation-preserving. Consequently, it induces an orientation-preserving planar homeomorphism, denoted h as well, which fixes the origin.

First, we need to show that $h : \mathbb{R}^2 \rightarrow \mathbb{R}^2$ belongs to \mathcal{H}_0 . From (i) in Lemma 1.6.3 we deduce that h is dissipative and 0 is an attracting fixed point. Moreover, the basin of attraction $U \subset \mathbb{R}^2$ of the origin contains the open unit disk. The second property implies that U meets the upper semi-cylinder. Denote $W = (U \setminus \{0\}) \cap (\mathbb{T} \times (0, +\infty))$. Since the lower semi-cylinder is positively invariant by h , the upper semi-cylinder is backward invariant and we obtain $W \subset h(W)$. Thus, the area condition implies that W must have infinite area. In particular, W is unbounded and so is U . Notice that h has a fixed point different from 0 so it is left only to check that the rotation number is $\bar{\omega}$.

In this case the prime end compactification of U is more difficult to describe. However, every point $(\theta, 1) \in \mathbb{R}^2$ is an accessible point of ∂U for $\theta \in C$, the Cantor set of ϕ . Each of these points define a prime end which will be denoted \mathfrak{p}_θ . The set $\{\mathfrak{p}_\theta : \theta \in C\}$ is a Cantor set in $\mathbb{P} = \mathbb{P}(U)$ which is invariant under h^* because the subset $C \times \{1\}$ of the unit circle is invariant by h . This allows to conclude that h^* is a Denjoy homeomorphism and its rotation number is $\bar{\omega}$.

Proof of Lemma 1.6.3. Firstly, we need to define a suitable Denjoy homeomorphism ϕ . It is well-known that there are some restrictions for the lengths of the intervals obtained after blowing up a orbit, recall Subsection 1.2.2, if we require the Denjoy map to be C^1 . More precisely, the quotient of the lengths between consecutive intervals must tend to 1. However, for any irrational η there exist Denjoy counterexamples of class C^1 with rotation number $\bar{\eta}$. Moreover, it is possible to choose the map so that the normalized Lebesgue measure of the Cantor set is any number in $[0, 1)$. See Section I.2 in [MS93] for more information. Let ϕ be a C^1 Denjoy diffeomorphism such that $\rho(\phi) = \bar{\omega}$ and C has null Lebesgue measure. Assume, without loss of generality, that ϕ is C^∞ in $\mathbb{T} \setminus C$, the derivative of ϕ never vanishes and $\phi'(\theta_0) = 1$ for some $\theta_0 \notin C$.

The homeomorphism will be constructed following a series of steps.

Step 1: Let us start with a map of $\mathbb{T} \times \mathbb{R}$ defined by

$$(\theta, r) \mapsto \left(\phi(\theta), \frac{r}{\phi'(\theta)} \right).$$

Note that the map is C^∞ in the cylinder except for the set

$$A = \{(\theta, r) : \theta \in C\}$$

which has null Lebesgue measure. Since the Jacobian at every point outside A is well-defined and equals 1 we can conclude that the map is area-preserving as a map of the cylinder. It is easy to check that it is a homeomorphism.

Now consider the matrix $\begin{pmatrix} 1 & 1 \\ 0 & 1 \end{pmatrix}$. It corresponds to an isometry of the plane so if we compose its induced action in the cylinder with our previous map we obtain an orientation and area-preserving homeomorphism

$$(\theta, r) \mapsto \left(\phi(\theta) + \frac{r}{\phi'(\theta)}, \frac{r}{\phi'(\theta)} \right).$$

Step 2: Note that the previous homeomorphism has many fixed points. A point (θ, r) is fixed if and only if

$$\theta = \phi(\theta) + \frac{r}{\phi'(\theta)}, \quad r = \frac{r}{\phi'(\theta)}$$

or, equivalently,

$$\phi'(\theta) = 1 \text{ and } r = \theta - \phi(\theta) + k \text{ for some integer } k.$$

Thus, there is $r_0 \in (0, 1)$ such that (θ_0, r_0) is fixed.

Step 3: Let us modify the previous map in the lower semi-cylinder in order to obtain a homeomorphism of the form

$$(\theta, r) \mapsto (\phi(\theta) + g_0(\theta, r), g_3(\theta, r))$$

such that for any θ and $r \leq 0$, $g_0(\theta, r) = 0$ and $g_3(\theta, r) = 2r$. Note that g_0 and g_3 are continuous as their definitions on both semi-cylinders coincide in $\mathbb{T} \times \{0\}$. This implies that the positive orbit of every point in the lower semi-cylinder tends to e^- , making the origin an attracting fixed point for the induced plane homeomorphism.

Step 4: In order to make h dissipative we have to modify g_3 . Take a constant $M \geq 2 \cdot \max\{\frac{1}{\phi'(\theta)} : \theta \in \mathbb{T}\}$ and $s : \mathbb{R} \rightarrow \mathbb{R}$ a piecewise linear map defined as $s(r) = 1 + \frac{r-1}{M}$ if $r \geq 1$ and $s(r) = r$ otherwise. Then, if $r \geq 1$

$$s \circ g_3(\theta, r) = s\left(\frac{r}{\phi'(\theta)}\right) = 1 + \frac{\frac{r}{\phi'(\theta)} - 1}{M} \leq 1 + r/2 - 1/M.$$

Thus, for large R , $g_2(\theta, r) = s \circ g_3(\theta, r) < r$ provided $r \geq R$. After replacing g_3 by g_2 the map is still an orientation-preserving homeomorphism of the cylinder but it is no longer area-preserving in the upper semi-cylinder. However, the definition of s ensures that the map does not expand area in it. Thus, (i) and (iii) are now satisfied.

Step 5: Finally, we need to make a small modification again in the second coordinate so that there is some point of $\mathbb{T} \times \{0\}$ which is mapped into the interior of the lower semi-cylinder and (ii) holds. Notice that $g_2(\theta, 0) = 0$ for any θ . Consider the vertical translation given by a map $t : \mathbb{T} \rightarrow [0, 1)$ such that t vanishes in C and in θ_0 but it is not null everywhere. Define $g_1(\theta, r) := g_2(\theta, r) - t(\theta)$. The vertical translation does not

affect the properties concerning area and keeps intact the fixed point. Then, the cylinder homeomorphism

$$(\theta, r) \mapsto (\phi(\theta) + g_0(\theta, r), g_1(\theta, r_1))$$

satisfies all the properties in the statement. □

Note that it is not difficult to modify the lemma so that the homeomorphism has a prescribed finite number of periodic orbits. Simultaneously, Matsumoto has presented another more general example in the form of a non-trivial attractor-repeller map in S^2 which is contained in the preprint [Mat13]. For every pair $\omega, \omega' \in \mathbb{R}$, an orientation-preserving homeomorphism h of S^2 is defined. The map h has two fixed points which are attracting for h and h^{-1} , respectively, and their associated rotation numbers are $\bar{\omega}$ and $\bar{\omega}'$. Additionally, it has orbits which go from the repelling fixed point to the attracting one, making the setting as the one contained in this work. Thus, if we set $\omega \in \mathbb{Q}$ then there will always be periodic points apart from the two fixed points already mentioned even though ω' is irrational.

Chapter 2

Fixed point index and the Conley index

2.1 Introduction

2.1.1 Algebraic invariants in dynamical systems

The main objective of this chapter is to study the dynamics of a discrete dynamical system around a fixed point. Most of our considerations will be restricted to low dimensions, namely 2 and 3, where there appear some topological obstructions in the local behavior of maps in the neighborhood of an invariant set. The invariant set X , typically a fixed point, is required to be isolated as an invariant set, which means that X is the largest invariant set in one of its neighborhoods. This condition implies that it is possible to isolate the invariant set and focus in a local dynamics whose largest invariant set is exactly X . Our work examines two algebraic invariants of this local dynamics: fixed point index and discrete homological Conley index. These invariants are models of how algebraic topology may be used in the study of dynamical systems. The fixed point index is an integer whereas the discrete Conley index is, up to an equivalence relation, an automorphism over a graded vector space. It is important to remark that the fixed point index can be computed in terms of the discrete Conley index. Unfortunately, it is typically not easy to compute this latter invariant. In fact, successful descriptions will be given just for grades 0 and 1 of the discrete Conley index.

The continuous map which generates the discrete dynamical system will only be assumed to be a homeomorphism for some results in dimension 3, whose proof needs the use of a duality result valid only for invertible maps. No further regularity will be imposed in this text as the study is purely topological.

A very important property which is shared by the fixed point index and the Conley index is the continuation property. A compact set N is called *isolating neighborhood* if the largest invariant subset contained in it lies in its interior. A sufficiently small neighborhood of an isolated invariant set X is always an isolating neighborhood. Let N be an isolating neighborhood for a map f_0 and $X = \text{Inv}(f_0, N)$ the largest invariant set contained in N . If the dynamics inside N is perturbed through an homotopy of maps $\{f_t\}_{t=0}^1$ then none of the indices will be modified as long as $\text{Inv}(f_t, N)$ lies in the interior of N . This statement is even stronger for the fixed point index: if no fixed point crosses

the boundary of N then the fixed point index of N remains invariant,

$$i(f_0, N) = i(f_1, N).$$

By definition, $i(f_0, N)$ is also the fixed point index of the largest f_0 -invariant set of N hence it is equal to $i(f_0, X)$. Consequently, we obtain the fixed point index information $i(f_1, N)$ concerning the fixed points of $\text{Inv}(f_1, N)$ without possibly having a clue in how it looks like. For example, we could deduce that it is not empty and contains at least one fixed point provided that we had $i(f_0, X) \neq 0$. The Conley index behaves quite similarly, if $\text{Inv}(f_t, N) \subset \text{int}(N)$ for any time t , then the Conley index remains invariant. That means that the Conley index of X for the original map is equal to the Conley index of the $\text{Inv}(f_1, N)$ for the dynamics generated by the map f_1 . Again, we may have started with a map f_0 whose dynamics is easy and finished with a local dynamics which is yet to describe but, at least, we got a complete knowledge of its Conley index. In particular, if the Conley index was originally non trivial the invariant set of f_1 will be non-empty. This last remark, that a non-trivial Conley index implies that the invariant set is non-empty is called *Ważewski property*.

In certain sense, the Conley index can be considered to be defined for isolating neighborhoods and not for isolated invariant sets. Although a given invariant set may be destroyed by small perturbations of the map, the notion of isolating neighborhood is robust and the Conley index is left invariant.

The fixed point index is an integer which measures algebraically the number of fixed points counted with multiplicity. It will be rigorously defined in Subsection 2.2.1 using the well-known notion of degree of a map. The definition of the Conley index is much more involved. Charles Conley introduced firstly the index for flows in [Co78] but it wasn't until the works of Robbin-Salamon, in [RS88], and Mrozek, in [Mr90], when the Conley index was properly defined in the discrete setting. In this work we use the approach of Franks and Richeson, see [FR00], to introduce the index in Section 2.2. The basic tool of the Conley index is a compact pair (N, L) , whose properties and terminology varies slightly among the different but equivalent definitions, such that $N \setminus L$ isolates an invariant set X , in the sense of the previous paragraph, and that the flow ϕ or the map f induces a flow/map

$$\bar{\phi}/\bar{f} : N/L \rightarrow N/L.$$

The induced dynamics in the quotient space is a local model of the dynamics around X . Roughly speaking, the set L contains all the points which the dynamics sends outside of the compact neighborhood N of X . As a result, in the quotient N/L the basepoint $[L]$ attracts every orbit whose destination was to exit N . Furthermore, since X is separated from L the local induced dynamics around X coincides with the original one.

In the discrete setting, we can apply Lefschetz-Dold Theorem to the map \bar{f} provided the quotient space N/L is not very badly-behaved, it is sufficient that N and L are compact polyhedra. It yields that

$$i(\bar{f}) = \Lambda(\bar{f}),$$

where $i(\bar{f})$ stands for the fixed point index of \bar{f} and $\Lambda(\bar{f})$ for the Lefschetz number of \bar{f} . It will be shown that the Lefschetz number of \bar{f} only depends on the discrete Conley index of X , this was first pointed out by Mrozek in [Mr89]. On the other side, the only

fixed points of \bar{f} are the basepoint $[L]$ and the ones contained in the isolated invariant set X . Thus, $i(\bar{f}) = i(\bar{f}, [L]) + i(\bar{f}, X)$ and, since $[L]$ is a local attractor of \bar{f} its fixed point index is 1 and the maps f and \bar{f} are conjugate around X , we obtain

$$i(f, X) = \Lambda(\bar{f}) - 1.$$

To sum up, we are able to compute the fixed point index of X in terms of an algebraic invariant which only depends in the discrete Conley index of X and f . Our goal is then to extract enough information from the Conley index in order to obtain explicit computations or, at least, some bounds for $i(f, X)$.

This chapter is organized as follows. In the following subsection the list of results covered by the text is presented together with a brief discussion, introduction of some notions and some corollaries with proofs. The final subsection of the introduction makes an overview of some results about fixed point index and how the results proved in this chapter fit in the theory. Some preliminary algebraic, dynamical and topological concepts, including discrete Conley index, are introduced in Section 2.2. An independent discussion of the planar results, which can be also deduced as a corollary of Theorem 2.1.1, is the content of Section 2.3. It may be seen as an easier setting where the arguments involved in the proof of Theorem 2.5.1 work as well. The next section is fully devoted to discrete Conley index. A brief discussion of the pairs involved in the definition is followed by a more geometrical approach to the index and its duality. Some questions concerning connectedness are discussed as well. The first subsection of Section 2.5 is committed to state Theorem 2.5.1, which allows to prove Theorems 2.1.1, 2.1.2 and the first part of Theorem 2.1.8. The proof of our results for a particular radial case is the content of Subsection 2.5.2 and the second half of Theorem 2.1.8 is proved right afterward. The final six subsections of Section 2.5 include the proof of Theorem 2.5.1. Some additional remarks about fixed point index are contained in Section 2.6. Finally, our results allow to describe precisely the local zeta function in some cases, as will be explained in Section 2.7. A great part of the content of this chapter is included in [HCR13].

2.1.2 Statement of the results

Our work deals with a local study of isolated invariant sets of maps defined in a Euclidean space. An invariant set X is *isolated* if it is the largest invariant subset contained in a compact neighborhood of X . In particular, all isolated invariant sets are compact. In addition, we restrict our considerations to maps defined in an open subset of \mathbb{R}^d and whose image lies in \mathbb{R}^d as well. These maps will be called *local maps*. If the map is a homeomorphism we will say it is a *local homeomorphism*. Please note that we have redefined the concept of local homeomorphism, as in the literature this term is commonly used as a generalization of the notion of covering map. The local nature of our work makes all the results presented in the article equally valid if we replace \mathbb{R}^d by an arbitrary manifold. Despite a study of the dynamics of a map around a fixed point was at first the objective of this work, for most of our results we simply assume that the compact isolated invariant set is connected and *acyclic*, i.e., all its Čech rational homology groups are trivial for $r \geq 1$. Of course, fixed points and *cellular* compacta, that is, compact sets having a basis of neighborhoods composed of closed balls, or more generally trivial shape continua (see [MS82, DS78] for information about shape theory)

are particular cases of acyclic continua. A remarkable fact, see [SG08], is that a trivial shape continuum of a closed 3-manifold is an isolated invariant set for a flow if and only if it is cellular. In the discrete case, this characterization is no longer true as proved by Sánchez-Gabites in Example 4.4 of [SG11].

An important and successful topological invariant used in dynamical systems is the Conley index. For a complete introduction to the theory we refer to [MM02]. In this work, the dynamics is generated by the iteration of a map, it is discrete. Our considerations mainly focus in the homological discrete Conley index, which will be here provided with rational coefficients. It associates to an isolated invariant set X and a map f an equivalence class, $h(f, X)$, of graded linear endomorphisms of vector graded spaces over \mathbb{Q} which contains, up to conjugation, exactly one automorphism. If we restrict our considerations to grade r , we obtain the r -homological discrete Conley index, $h_r(f, X)$. As will be shown later, all the maps contained in the equivalence class $h_r(f, X)$ have equal traces, so the obvious definition $\text{trace}(h_r(f, X))$ makes sense and, as a matter of fact, a great part of the contents of this article deals with this invariant.

Another very important invariant this work deals with is the fixed point index, which associates to a map f and a point or, more generally, a set X an integer $i(f, X)$. It illustrates the aim of many topological invariants appearing in dynamical systems, if the fixed point index of a set is non-zero then it contains fixed points. The fixed point index $i(f, X)$ is an algebraic measure of the set of fixed points of a map f in X . The definition requires the set X to have a compact neighborhood U such that $\text{Fix}(f) \cap (U \setminus X) = \emptyset$, which will be always the case if X is an isolated invariant set. Then, the fixed point index is defined as the Brouwer degree of the map $\text{id} - f$ restricted to U . We will approach this invariant through the more powerful tools of Conley index. Fixed point index is coarser than discrete homological Conley index, as the following equation shows:

$$i(f, X) = \sum_{r \geq 0} (-1)^r \text{trace}(h_r(f, X)). \quad (2.1)$$

This Lefschetz-like formula provides information about the fixed point index of an isolated invariant set once we estimate the traces of its discrete homological Conley indices.

An isolated invariant set X of a local map f is also invariant under f^n , for any positive integer n . It is immediate to prove that X is isolated for f^n as well. One may wonder about the relationship between the homological Conley indices $h(f, X)$ and $h(f^n, X)$. Not surprisingly, the n -th power of an endomorphism contained in the class $h(f, X)$ belongs to the equivalence class $h(f^n, X)$. Therefore, once we obtain an element of $h(f, X)$, hence of every $h_r(f, X)$ for $r \geq 0$, we can use Equation (2.1) to compute, not only the fixed point index $i(f, X)$, but the fixed point index of any positive iterate of f at X , $i(f^n, X)$. This generalization of Equation (2.1) is proved in Subsection 2.2.6 and reads as follows,

$$i(f^n, X) = \sum_{r \geq 0} (-1)^r \text{trace}(h_r(f^n, X)). \quad (2.2)$$

An invariant set X of a local map f of \mathbb{R}^d is an *attractor* (resp. a *repeller*) if it is the largest backward (forward) invariant subset contained in a neighborhood of X . The discrete homological Conley indices are very easy to describe in these cases, provided that X is an acyclic continuum. If X is an attractor, for any positive integer n , $h_0(f^n, X)$

is represented by the identity map over \mathbb{Q} and all higher homological indices $h_r(f^n, X)$ are trivial, they contain the zero automorphism. The map will be assumed to be a homeomorphism in the discussion about repellers, otherwise the description will not be as accurate. For repellers the only non-trivial index is $h_d(f^n, X)$ and it is represented by the map $s : \mathbb{Q} \rightarrow \mathbb{Q}$ defined by $s(x) = d(f)^n x$, where $d(f)$ equals 1 if f preserves orientation and -1 if f reverses orientation. The details of this description can be found in Subsection 2.2.7. Equation (2.2) then shows that the fixed point index, $i(f^n, X)$, of an attractor and a repeller are 1 and $(-1)^d d(f)^n$, respectively, as is well-known.

The first result presented in the article deals with the 1-homological index.

Theorem 2.1.1. *Let f be a local map of \mathbb{R}^d and X an isolated invariant acyclic continuum which is not a repeller. The trace of the first homological discrete Conley index satisfies*

$$\text{trace}(h_1(f, X)) \geq -1.$$

Furthermore, there exists a finite set J and a map $\varphi : J \rightarrow J$ such that, for $n \geq 1$,

$$\text{trace}(h_1(f^n, X)) = -1 + \#\text{Fix}(\varphi^n).$$

The proof of this theorem follows from a combinatorial description of the first homological discrete Conley index, which will be expressed in terms of a map φ defined over the finite set of connected components of a neighborhood of the exit set of an isolating neighborhood of X . The precise statement is the first part of Theorem 2.5.1 of Subsection 2.5.1, some combinatorial ideas are essential part of its proof, which is the content of the final six subsections of Section 2.5. For higher dimensional homological indices the intuition would be to think that homology classes are permuted when φ does not fix any element. This idea will be formalized as follows: there exists, for every $r > 1$, a decomposition in direct summands of a vector space which can be used to compute the r -homological discrete Conley index such that the index map permutes the summands in an equivalent way as φ does. Then, we obtain the following theorem:

Theorem 2.1.2. *Let f be a local map of \mathbb{R}^d and X an isolated invariant acyclic continuum which is not a repeller. If $\text{trace}(h_1(f, X)) = -1$ then $\text{trace}(h_r(f, X)) = 0$ for any $r > 1$.*

The previous two theorems focus in the behavior of the first homological index. A direct application of the local Lefschetz formula expressed by Equation (2.2) and Theorem 2.1.1 is the following corollary:

Corollary 2.1.3. *Let f be a local map of \mathbb{R}^2 and X an isolated invariant acyclic continuum which is not a repeller. Then,*

$$i(f, X) \leq 1.$$

As a matter of fact, we obtain a more precise description which is the content of Theorem 2.1.6. A self-contained proof of this result will be given in Section 2.3. This index inequality was already known for fixed points and homeomorphisms, see [LY97] or [RS02].

In principle, no further applications can be carried into higher dimensions. A bit of help in this direction is provided by a duality result between Conley indices, which is valid

only for homeomorphisms. Given an isolated invariant set X of a local homeomorphism f of \mathbb{R}^d , certainly also isolated as an invariant set for f^{-1} , and $0 \leq r \leq d$, the $(d-r)$ -index of X and f is dual, up to sign, to the r -index of X and f^{-1} :

$$h_{d-r}(f, X) \cong d(f) \cdot (h_r(f^{-1}, X))^*. \quad (\text{Szymczak's duality})$$

The sign $d(f)$ is -1 or 1 depending on whether f reverses or preserves orientation. This duality was first stated by Szymczak in [Sz98] for the discrete Conley index. For the sake of completeness, we include in Subsection 2.4.4 a short proof of this duality which uses a new point of view explained in Subsection 2.4.2 which makes it closer to the original Conley index, which was defined for flows. The reader may check that the homological indices of attractors and repellers, which have been previously described, agree with Szymczak's duality. Note that a repeller is an attractor for the map f^{-1} .

As a corollary of this duality and Theorems 2.1.1 and 2.1.2, we obtain the following inequality in dimension 3.

Corollary 2.1.4. *Suppose that f is a local orientation-reversing homeomorphism of \mathbb{R}^3 and X is an isolated invariant acyclic continuum. Then,*

$$i(f, X) \leq 1.$$

Proof. In the case X is either an attractor or a repeller, the fixed point index is equal to 1 or $-d(f)$, respectively, and the inequality holds. Otherwise, in Subsection 2.2.7 we will show that all r -indices are trivial for $r = 0$ and $r \geq 3$. Furthermore, Szymczak's duality and Theorem 2.1.1 yield that $\text{trace}(h_2(f, X)) = -\text{trace}(h_1(f^{-1}, X)) \leq 1$. It follows from (2.1) that

$$i(f, X) = -\text{trace}(h_1(f, X)) + \text{trace}(h_2(f, X)) \leq 2.$$

Theorem 2.1.2 shows that this bound is never attained, if the first term is 1 then the second one vanishes. Therefore, we conclude that $i(f, X) \leq 1$. \square

Another easy corollary of Theorems 2.1.1 and 2.1.2 gives a sufficient condition for existence of fixed points in terms of the trace of the homological discrete Conley index.

Corollary 2.1.5. *Let f be a local homeomorphism of \mathbb{R}^d and X an isolated invariant acyclic continuum. If (at least) one of the following alternatives hold:*

- $\text{trace}(h_1(f, X)) = -1$,
- f preserves orientation and $\text{trace}(h_{d-1}(f, X)) = -1$
- or f reverses orientation and $\text{trace}(h_{d-1}(f, X)) = 1$,

then $i(f, X) = 1$ and, in particular, X contains a fixed point.

Proof. Theorem 2.1.2 implies that only one possibility may hold at the same time. Second and third alternatives are equivalent, by Szymczak's duality, to $\text{trace}(h_1(f^{-1}, X)) = -1$, hence it is enough to prove the statement for the first hypothesis.

Assume X is not an attractor, in Subsection 2.2.7 we will see that $h_0(f, X)$ is trivial and, by Theorem 2.1.2, $\text{trace}(h_r(f, X)) = 0$ for all $r > 1$. Equation (2.1) then leads to

$$i(f, X) = -\text{trace}(h_1(f, X)) = 1.$$

Notice that for a repeller duality yields that $\text{trace}(h_d(f, X))$ is not trivial. Thus, none of the original hypothesis can be satisfied by a repeller provided $d > 1$.

For attractors the index result is well-known, a proof is included in Subsection 2.2.7. However, again, if $d > 1$ none of the hypothesis of this corollary can be satisfied because only the 0-Conley index has nontrivial trace, see Proposition 2.2.20. \square

The restriction expressed by Corollaries 2.1.3 and 2.1.4 is reflected in the possible sequences of integers that can be realized as the sequence of fixed point indices $\{i(f^n, p)\}_{n \geq 1}$ of a fixed point p , isolated as an invariant set, of a local map of \mathbb{R}^2 and a local orientation-reversing homeomorphism of \mathbb{R}^3 , respectively. It is well-known that any such sequence must satisfy some general relations, called Dold's congruences, see [Do83], which will be briefly explained in Subsection 2.2.3, where we will also introduce the normalized sequences σ^k . As a hint, let us say that every sequence $I = \{I_n\}_{n \geq 1}$ can be expressed uniquely as a formal linear combination of the normalized sequences, $I = \sum_{k \geq 0} a_k \sigma^k$, and it satisfies Dold's congruences if and only if all the coefficients a_k are integers.

A brief exposition on the results known about the fixed point index for homeomorphisms is contained in Subsection 2.1.3. Here we limit ourselves to describe the new results proved in this work.

In the planar case, the behavior of the fixed point index had been already completely described for homeomorphisms and fixed points isolated as invariant sets. However, our techniques allow to address the question if homeomorphisms are replaced by continuous maps. The following result is a trivial corollary of Equation 2.2 and Theorem 2.1.1 and it generalizes Corollary 2.1.3. A self-contained proof of this result is given in Section 2.3. It basically uses analogous dynamical ideas to the ones that lead to the proof of 2.1.1 but they become much simpler in the planar setting.

Theorem 2.1.6. *Given a sequence $I = \{I_n\}_{n \geq 1} = \sum_{k \geq 1} a_k \sigma^k$, there exists a local map f of \mathbb{R}^2 with a fixed point p isolated as an invariant set and such that $I = \{i(f^n, p)\}_{n \geq 1}$ if and only if*

- *the coefficients a_k are integers,*
- *there are finitely many non-zero a_k ,*
- *$a_1 \leq 1$ and $a_k \leq 0$ for all $k > 1$.*

In dimension 3, for homeomorphisms it is known that the sequence $\{i(f^n, p)\}_{n \geq 1}$ must be periodic, no matter whether the orientation is reversed or not, see [LRS10]. We include an alternative proof of this result which follows from Theorem 2.1.1 and Szymczak's duality.

Corollary 2.1.7. *Let f be a local homeomorphism of \mathbb{R}^3 and X an isolated invariant acyclic continuum. Then, the sequence $\{i(f^n, X)\}_{n \geq 1}$ is periodic.*

Proof. If X is an attractor, the sequence $\{i(f^n, X)\}_{n \geq 1}$, is constant equal to 1; if X is a repeller and f preserves orientation, it is constant equal to -1 ; if X is a repeller and f reverses orientation, one has $i(f^n, X) = (-1)^{n+1}$. Assume now that X is neither an attractor nor a repeller and f preserves orientation. Using Szymczak's duality we obtain $\text{trace}(h_2(f^n, X)) = \text{trace}(h_1(f^{-n}, X))$. By Theorem 2.1.1, there exist two maps $\varphi : J \rightarrow J$

and $\varphi' : J' \rightarrow J'$, with J, J' finite sets, such that $\text{trace}(h_1(f^n, X)) = -1 + \#\text{Fix}(\varphi^n)$ and $\text{trace}(h_1(f^{-n}, X)) = -1 + \#\text{Fix}((\varphi')^n)$. Note that the sequences $\{\#\text{Fix}(\varphi^n)\}_{n \geq 1}$ and $\{\#\text{Fix}((\varphi')^n)\}_{n \geq 1}$ are periodic. Substituting in equation (2.2) we get that

$$i(f^n, X) = -\text{trace}(h_1(f^n, X)) + \text{trace}(h_2(f^n, X)) = -\#\text{Fix}(\varphi^n) + \#\text{Fix}((\varphi')^n),$$

and the conclusion follows. The same formula holds for even iterates in the orientation-reversing case, whereas if n is odd one has

$$i(f^n, X) = 2 - \#\text{Fix}(\varphi^n) - \#\text{Fix}((\varphi')^n).$$

This computation is also straightforward. \square

The additional restrictions expressed by Corollary 2.1.4 and, more subtly, by Theorems 2.1.1 and 2.1.2 on the fixed point index sequence $\{i(f^n, p)\}_{n \geq 1}$ produce the following theorem.

Theorem 2.1.8. *Given a sequence $I = \{I_n\}_{n \geq 1} = \sum_{k \geq 1} a_k \sigma^k$, there exists an orientation-reversing local homeomorphism f of \mathbb{R}^3 with a fixed point p isolated as an invariant set and such that $I = \{i(f^n, p)\}_{n \geq 1}$ if and only if*

- the coefficients a_k are integers,
- there are finitely many non-zero a_k ,
- $a_1 \leq 1$ and $a_k \leq 0$ for all odd $k > 1$.

In Subsection 2.5.1 we will prove the necessity condition, which holds for any isolated invariant acyclic continuum X . However, the example constructed in Subsection 2.5.3 to prove sufficiency can not be easily extended to acyclic continua which do not admit any neighborhood U such that $U \setminus X$ is homeomorphic to $S^2 \times \mathbb{R}$.

Corollary 2.1.4 has a nice dynamical application to minimal homeomorphisms. A map is *minimal* if there are no proper invariant sets. The question of existence of minimal homeomorphisms was raised by Ulam and is one of the problems contained in the ‘‘Scottish Book’’, see [Ma81]. Fathi and Herman proved in [FH77] that every manifold over which S^1 acts freely, for example any odd-dimensional sphere, admits minimal homeomorphisms. On the contrary, the description of the sequences of fixed point indices of the iterates of a map led Le Calvez and Yoccoz to prove the non-existence of minimal homeomorphisms in the finitely-punctured 2-sphere, see [LY97]. Despite Theorem 2.1.8 does not apparently provide enough insight in the question for orientation-reversing homeomorphism in the finitely-punctured 3-sphere, Corollary 2.1.4 is sufficient to address this question for the case of orientation-reversing homeomorphisms in \mathbb{R}^3 .

Corollary 2.1.9. *If f is a fixed point free orientation-reversing homeomorphism of \mathbb{R}^3 , then for every compact set $K \subset \mathbb{R}^3$ there exists an orbit of f disjoint from K . In particular, there are no minimal orientation-reversing homeomorphisms of \mathbb{R}^3 .*

Proof. Denote \bar{f} the extension of f to S^3 , leaving the point at ∞ fixed. Since ∞ is the unique fixed point of \bar{f} , we deduce from Lefschetz-Dold Theorem that $i(\bar{f}, \infty) = 2$, the Lefschetz number of \bar{f} . Corollary 2.1.4 then implies that ∞ is not isolated as an invariant set and the conclusion follows. \square

2.1.3 Fixed point index results

The purpose of this section is to give an overview on what was known about the fixed point index of isolated fixed points and to show how the results contained in this work fit in the theory. Theorems 2.1.6 and 2.1.8 show some obstructions appearing in the fixed point index in low dimensions. They give a complete description in some particular cases of the fixed point index sequence of fixed points isolated as invariant sets and, more generally, of isolated invariant acyclic continua. Additionally, as a corollary of the results here presented we obtained a very simple proof of Corollary 2.1.7, which was the main theorem of [LRS10]. As said before, our results just deal with fixed points which are isolated as invariant sets.

There seems to exist a connection between the behavior of the fixed point index of orientation-preserving local homeomorphisms in \mathbb{R}^d and that of orientation-reversing local homeomorphisms in \mathbb{R}^{d+1} . In dimension 1, a fixed point p of an orientation-preserving homeomorphism $f : \mathbb{R} \rightarrow \mathbb{R}$ isolated in the set $\text{Fix}(f)$ is necessarily an isolated invariant set, the fixed point index can take the values -1 , 0 or 1 and the sequence $\{i(f^n, p)\}_{n \geq 1}$ is constant. The indices -1 , 0 and 1 correspond to the cases where the fixed point is repelling, attracting on one side and repelling in the other and attracting, respectively. A fixed point of an orientation-reversing homeomorphism is always isolated in the set of fixed points (but not necessarily an isolated invariant set) and its index is 1 .

In dimension 2, one can construct, for every $l \in \mathbb{Z}$, a local orientation-preserving homeomorphism having a fixed point p such that $i(f, p) = l$. See Figure 2.1 in Subsection 2.2.1 for examples of fixed points of planar homeomorphisms with different indices. However, if one supposes that $\{p\}$ is an isolated invariant set, it was proven by Le Calvez and Yoccoz in [LY97] that $l \leq 1$. More precisely, if p is neither a sink nor a source there exist two integers $q \geq 1$ and $r \geq 1$ such that the sequence of indices of iterates can be written

$$\{i(f^n, p)\}_{n \geq 1} = \sigma_1 - r\sigma_q. \quad (2.3)$$

The work made by Le Calvez and Yoccoz involves an impressive deep analysis of the local dynamics around the fixed point. Franks introduced Conley index techniques in [Fr99] to get a short proof of the inequality $i(f, p) \leq 1$ and of the fact that the sequence $\{i(f^n, p)\}_{n \geq 1}$ takes periodically a non-positive value. Some restrictions appear in the orientation-reversing case, the index of an isolated fixed point only can take the values -1 , 0 or 1 , as was shown by Bonino in [Bo02]. His result only requires the point to be isolated in $\text{Fix}(f)$. Notice the similarity with the 1-dimensional formula. In the case where the fixed point is an isolated invariant set, the description can be sharpened. Ruiz del Portal and Salazar, see [RS02], used Conley index techniques to prove (2.3) and to state an analogous formula in the orientation-reversing case: there exist $e \in \{-1, 0, 1\}$ and $r \geq 0$ such that

$$\{i(f^n, p)\}_{n \geq 1} = e\sigma_1 - r\sigma_2, \quad (2.4)$$

provided that p is neither a sink nor a source (the same approach was taken, at least in the orientation-preserving case, in the unpublished article [LY]).

In dimension 3, one can construct, for every $l \in \mathbb{Z}$, a local orientation-preserving or reversing homeomorphism having a fixed point p such that $i(f, p) = l$ and $\{p\}$ is an isolated invariant set. The first obstruction appears when we consider the fixed point index sequence. If the fixed point is an isolated invariant set, it is known that

the sequence of fixed point indices $\{i(f^n, p)\}_{n \geq 1}$ is periodic, see [LRS10]. No further restrictions appear in the orientation-preserving case. However, it seemed plausible that the orientation-reversing case would exhibit some particular behavior connected to the planar orientation-preserving case. This was the motivation for this work. Corollary 2.1.4 and, more precisely, Theorem 2.1.8 show the extra restrictions which appear in the orientation-reversing case in dimension 3. In particular, the index is always less than or equal to 1, as occurred for orientation-preserving planar homeomorphisms. Nevertheless, the behavior of the sequence of fixed point indices of the iterates is different in both cases, it is much more rigid in the planar case. Indeed, in dimension 2, the map φ that appear in Theorem 2.5.1 will have to preserve or reverse a cyclic order depending whether f preserves or reverses the orientation. In the first case, all periodic points have the same period, in the second case φ has at most two fixed points and the other periodic points of φ have period 2. In dimension 3, any permutation can be realized by the map φ .

Our considerations stop at dimension 4, point at which not even the boundedness of the sequence $\{i(f^n, p)\}_{n \geq 1}$ can be guaranteed in our setting. An example of an orientation-preserving homeomorphism of \mathbb{R}^4 with a fixed point isolated as an invariant set and such that its fixed point sequence is unbounded is included in [LRS10]. In Section 2.6 an analogous construction in the orientation-reversing case is described. Thus, the fixed point index sequence in dimension 4 is not bounded in general. In particular, the linking between behavior in the orientation-preserving case and the orientation-reversing case in one dimension higher is valid only up to dimension 3.

The discussion contained in this work is purely topological. Notable restrictions appear if we assume some regularity on the map f . Shub and Sullivan proved in [SS74] that the sequence $\{i(f^n, p)\}_{n \geq 1}$ is bounded if f is C^1 and not necessarily invertible. Notice that the sequence is well-defined if and only if p is isolated in the set of fixed points of f^n for every $n \geq 1$, which is slightly weaker than being isolated in $\text{Per}(f)$. A full description of the sequence $\{i(f^n, p)\}_{n \geq 1}$ in terms of the spectrum of $Df(p)$ was given by Chow, Mallet-Paret and Yorke in [CMY83] and also by Babenko and Bogatyĭ in [BB92]. The complete list of patterns the fixed point index sequence follows and examples for each of them can be found in [BB92], for dimension 2, and in [GN06], for dimension 3.

2.2 Preliminaries

2.2.1 Fixed point index

Let f be a local map of \mathbb{R}^d and p a fixed point of f , $f(p) = p$. The *fixed point index* of f at p , $i(f, p)$, is an integer which measures the multiplicity of p as a fixed point. This multiplicity would be computed as the degree of a suitable map. Before we proceed with the precise definition, note that we restrict our considerations to maps defined in Euclidean spaces but the definition can be extended to more general spaces such as locally compact ANRs (absolute neighborhood retracts). We refer the reader to [Do72, GD03, JM05] for more general definitions of the fixed point index, several versions of Lefschetz Theorem and results from fixed point theory.

Given a local map f of \mathbb{R}^d and an open set U contained in the domain of definition of f , the *degree* of the map f at U , $\deg(f, U)$, is an integer which counts the number of

zeroes of f within U with multiplicity. The definition also requires the set $f^{-1}(0) \cap U$ to be compact. Hereafter we use 0 to refer to the origin of \mathbb{R}^d . The degree of a map was first defined by Brouwer and is sometimes referred to as *Brouwer degree*. In the case that the map f is C^1 and 0 is a regular value for f , that is, the differential Df_x at every $x \in f^{-1}(0)$ is regular, the computation of the degree is straightforward:

$$\deg(f, U) = \sum_{x \in f^{-1}(0) \cap U} \operatorname{sgn}(\det(Df_x)).$$

In particular, the degree of the identity map in a neighborhood of 0 is 1 . The most important property of the degree is that it is an homotopy invariant. If $\{f_t\}_{t \in [0,1]}$ is an homotopy between the maps f_0 and f_1 such that $f_t^{-1}(0) \cap U$ is compact for every $t \in [0, 1]$ then $\deg(f_0, U) = \deg(f_1, U)$. When the open set U coincides with the domain of definition of f we will simply write $\deg(f)$ and called it the degree of f . Notice that this number is well-defined provided that $f^{-1}(0)$ is compact.

There is a homological equivalent definition of the degree. Fix an orientation of the Euclidean space \mathbb{R}^d , which subsequently induces an orientation in U , and consider the map induced by f in the relative homology groups

$$f_* : H_d(U, U \setminus f^{-1}(0)) \rightarrow H_d(\mathbb{R}^d, \mathbb{R}^d \setminus 0).$$

Let $\alpha_{f^{-1}(0)}$ and α_0 be the generators of each of the homology groups corresponding to the choice of orientation. Then, it can be deduced that $f_*(\alpha_{f^{-1}(0)}) = \deg(f, U)\alpha_0$. This formula serves as an equivalent definition of the degree as well.

Now, we move into the definition of the fixed point index. Note that a fixed point of a local map f of \mathbb{R}^d is a pre-image of 0 under the map $\operatorname{id} - f$. Given an open subset U of the domain of definition of f such that $\operatorname{Fix}(f) \cap U$ is compact, the fixed point index of f at U is defined as

$$i(f, U) = \deg(\operatorname{id} - f, U).$$

When U is the domain of definition of f we simply write $i(f)$ for the (fixed point) index of the map f . Note that we require the fixed point set to be compact. If we consider a fixed point p isolated among the set of fixed points of f , $\operatorname{Fix}(f)$, the index of f at p is defined as

$$i(f, p) = i(f, U)$$

for any open neighborhood U of p such that $U \cap \operatorname{Fix}(f) = \{p\}$. Again, it is possible to give a homological definition of the fixed point index using its counterpart definition of the degree. More importantly, the invariance under homotopy still holds: if $\{f_t\}_{t \in [0,1]}$ is an homotopy such that $\operatorname{Fix}(f_t) \cap U$ is compact for every $t \in [0, 1]$ then $i(f_0, U) = i(f_1, U)$.

Let us include some examples to illustrate the definition of the fixed point index. First, consider for any $\lambda \neq 1$ the map $s_\lambda : \mathbb{R} \rightarrow \mathbb{R}$ defined by $s_\lambda(x) = \lambda x$. The origin is the unique fixed point of s_λ . The map $\operatorname{id} - s_\lambda$ is C^1 and its derivative in 0 is equal to $1 - \lambda$, in particular it does not vanish. Thus

$$i(s_\lambda, 0) = \deg(\operatorname{id} - s_\lambda, 0) = \operatorname{sgn}(1 - \lambda) = \pm 1.$$

Also worth noting is that if we consider λ' to be a small perturbation of λ then $i(s_{\lambda'}, 0) = i(s_\lambda, 0)$. This equality is valid as long as $|\lambda' - \lambda| < |1 - \lambda|$.

Let p be a fixed point and D be a closed ball centered at p such that $f(\partial D) \subset \text{int}(D)$ and the positive orbit of every point in D tends to p . Clearly, this is the case when p is an attracting fixed point. Let U be a small open neighborhood of D such that $\text{Fix}(f) \cap U = \{p\}$ as well. Consider an homotopy $\{f_t\}_{t \in [0,1]}$, $f_t : U \rightarrow \mathbb{R}^d$, which connects $f_0 = f$ to f_1 which takes constant value $x_0 \in U$. Moreover, we can choose the homotopy such that $\text{Fix}(f_t) \cap U \subset D$ so $\text{Fix}(f_t)$ is compact. Therefore,

$$i(f, p) = i(f_0, U) = i(f_1, U) = i(f_1, p) = \deg(\text{id} - f_1, p) = 1$$

because the identity map has degree 1 at the origin. This computation will be generalized in Proposition 2.2.20.

Next example shows that any positive integer l can be the fixed point index of a homeomorphism in the plane. Identify $\mathbb{R}^2 \sim \mathbb{C}$ and let $f(z) = z + z^l$ be a holomorphic map. The only fixed point of f is 0. Its fixed point index is equal to $i(f, 0) = \deg(g, 0)$, where $g(z) = z - f(z) = -z^l$. This degree can be easily checked to be equal to l via a perturbation argument. Let U be the open unit disk. All fixed points of the maps $g_\epsilon(z) = \epsilon - z^l$ are contained in U if $\epsilon < 1$. Therefore, via homotopy we deduce that $\deg(g, 0) = \deg(g_0, U) = \deg(g_{1/2}, U)$. It suffices to note that the map $g_{1/2}$ has exactly l zeroes in U and, since it is holomorphic and its zeroes are regular (non-vanishing derivative), the degree of $g_{1/2}$ at each zero is 1. In fact, any regular zero of a holomorphic map has degree 1. If $g = (u, v)$ is holomorphic and $g'(z) \neq 0$ then

$$\det(Dg_z) = \det \begin{pmatrix} u_x & u_y \\ v_x & v_y \end{pmatrix} = \det \begin{pmatrix} u_x & u_y \\ -u_y & u_x \end{pmatrix} = u_x^2 + u_y^2 > 0,$$

by the Cauchy-Riemann equations. The geometrical explanation to this is that a holomorphic map at a regular point is locally an orientation-preserving diffeomorphism, hence its degree must be 1 and not -1.

In Figure 2.1 some examples of fixed points in the plane are exhibited. Arrows in the pictures describe a flow in \mathbb{R}^2 with a singularity. Considering the time- t map of the flow we obtain an orientation-preserving homeomorphism with a fixed point, which is isolated as a fixed point. In the example on the left there is a point of index 2, the discrete dynamics is conjugate to the one generated by the map $f(z) = z + z^2$. Notice that the fixed point is not isolated as an invariant set, in any neighborhood of the point there are full orbits of the map. This observation agrees with the results about the fixed point index of planar homeomorphisms. In the middle picture, a point of index 0 is drawn. As a general fact, such a fixed point is “removable” in the sense that we can find a homotopy supported in a small neighborhood of the point from the original map to a fixed point free map.

The picture on the right of Figure 2.1 is certainly the most interesting one. The fixed point is clearly isolated as an invariant set. Using the definition it is not difficult to see that $i(f^n, p) = -3$ for any $n \neq 0$. Denote R the rotation of angle $\pi/2$ and S the symmetry about the horizontal axis. A straightforward computation shows that, for $n > 0$, $i((R \circ f)^n, p) = -3$ only if $n \equiv 1 \pmod{4}$ and is equal to 1 otherwise. The same formula holds if we replace f by f^{-1} . For the symmetry S we obtain $i((S \circ f)^n, p) = 1$ for odd $n \geq 1$ and $i((S \circ f)^n, p) = -3$ for even $n \geq 2$. However, if we replace f by f^{-1} the indices differ in the odd positions: $i((S \circ f^{-1})^n, p) = -1$ for odd $n \geq 1$ and $i((S \circ f^{-1})^n, p) = -3$ for even $n \geq 2$.

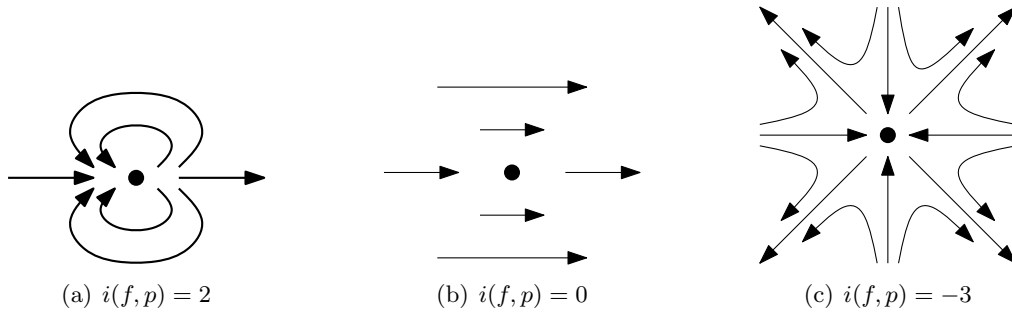

Figure 2.1: Fixed points of planar homeomorphisms.

Finally, let us conclude this subsection with probably the most remarkable result involving fixed point index. Under some hypothesis, it is possible to relate the local fixed point indices of the fixed points of a map with the topology of the ambient space and the global action of the map. It can be thought as a discrete analogue of Poincaré-Hopf Theorem, which states that the sum of the indices of the singular points of a vector field in a manifold is equal to its Euler characteristic. This discrete counterpart was discovered by Lefschetz in the 1920s and named after him, Lefschetz fixed point Theorem. It states that the sum of the local fixed point indices of the fixed points (if finite) of a self-map of a finite polyhedron is equal to the Lefschetz number of the map. In the literature it is often referred to as Lefschetz-Hopf Theorem, as Hopf gave a different and simple proof valid for arbitrary polyhedra shortly after Lefschetz's work was published. Credit for the extension of the definition of fixed point index and Lefschetz Theorem to ANRs goes to Dold and also to Granas.

Theorem 2.2.1 (Lefschetz-Dold). *Let $f : X \rightarrow X$ be a continuous map over a compact ANR X . Then,*

$$i(f, X) = \Lambda(f)$$

where $\Lambda(f)$ denotes the Lefschetz number of f .

A proof of this result can be found for instance in [Do72, GD03, JM05].

2.2.2 Shift equivalence

In this work, we present the approach taken by Franks and Richeson in [FR00] to introduce the discrete Conley index. The key concept to understand their work is shift equivalence, which will be firstly defined for an arbitrary category.

Definition 2.2.2. *Let \mathcal{K} be a category and Y, Y' two objects of \mathcal{K} . Consider the endomorphisms $g : Y \rightarrow Y$ and $g' : Y' \rightarrow Y'$. Then, g and g' are said to be shift equivalent provided that there exist morphisms $a : Y \rightarrow Y'$ and $b : Y' \rightarrow Y$ and an integer $m \geq 0$ such that*

- $a \circ g = g' \circ a$, $b \circ g' = g \circ b$,
- $b \circ a = g^m$ and $a \circ b = (g')^m$.

It is not difficult to check that the notion of shift equivalence is an equivalence relation. The idea behind this definition is to put in the same class all endomorphisms whose “cores” are conjugate, where “core” means the largest automorphism obtained as a restriction of an endomorphism. As a motivation, assume g and g' are bijective and shift equivalent. Then, if we define $h = a \circ g^{-m} = (g')^m \circ a$ we obtain that $h^{-1} = b$ and h is a conjugation between g and g' , as it satisfies $h^{-1} \circ g' \circ h = g$. Conversely, if h is a conjugation then $a = h$ and $b = h^{-1}$ provide a shift equivalence between g and g' . The previous intuition will be formalized once we move onto the following particular cases.

Firstly, consider a very simple setting, the category formed by finite sets and maps between them.

Definition 2.2.3. *Given a finite set J and a map $\varphi : J \rightarrow J$, denote $\text{gim}(\varphi)$ the largest invariant subset of J under φ . Then, we define the permutation induced by φ as the restriction of φ to the subset $\text{gim}(\varphi)$, and denote it by $\mathcal{L}(\varphi)$.*

Shift equivalence here only makes differences within the induced permutations, as the following proposition shows.

Proposition 2.2.4. *Two finite maps $\varphi : J \rightarrow J$ and $\varphi' : J' \rightarrow J'$ are shift equivalent if and only if their induced permutations are conjugate.*

Proof. After the definition of shift equivalence we proved that this notion is equivalent to conjugation provided that the endomorphisms are bijective. Therefore, we just need to show that a finite map is shift equivalent to its induced permutation.

The set J being finite, there exists n_0 such that $\varphi^{n_0}(J) = \text{gim}(\varphi)$. Then, define $a = \varphi^{n_0} : J \rightarrow \text{gim}(\varphi)$ and let $b : \text{gim}(\varphi) \rightarrow J$ be the inclusion map. It is easy to check that a and b provide a shift equivalence between φ and $\mathcal{L}(\varphi)$. \square

The category of finite-dimensional vector spaces and linear endomorphisms has a richer structure in which shift equivalence will be completely described as well. As shown previously, for linear automorphisms it is equivalent to conjugation. Before we prove the characterization, we need to introduce several definitions concerning linear endomorphisms. We stick our considerations to vector spaces over \mathbb{Q} . Let H be a finite-dimensional vector space and $u : H \rightarrow H$ an endomorphism. The *generalized kernel* of u , $\text{gker}(u)$, is the set of vectors which are eventually mapped onto 0, that means

$$\text{gker}(u) = \bigcup_{n \geq 0} \ker(u^n).$$

The *generalized image* of u , $\text{gim}(u)$, is the largest invariant subspace of H under u ,

$$\text{gim}(u) = \bigcap_{n \geq 0} \text{im}(u^n).$$

It is well known (and easy to check) that there exists an integer n_0 such that

$$\ker(u) \subsetneq \ker(u^2) \subsetneq \cdots \subsetneq \ker(u^{n_0}) = \ker(u^{n_0+1})$$

and

$$\text{im}(u^{n_0+1}) = \text{im}(u^{n_0}) \subsetneq \cdots \subsetneq \text{im}(u^2) \subsetneq \text{im}(u)$$

and that one has

$$\text{gker}(u) = \ker(u^n), \quad \text{gim}(u) = \text{gim}(u^n)$$

for every $n \geq n_0$. The subspaces $\text{gker}(u)$ and $\text{gim}(u)$ are obviously positively invariant. The restriction of u to the subspace $\text{gim}(u)$ is called in the literature *Leray reduction* and will be denoted $\mathcal{L}(u)$. It is easy to prove that

$$H = \text{gker}(u) \oplus \text{gim}(u).$$

This decomposition gives a synthetic description of u : on one hand, the restriction of u to $\text{gker}(u)$ is nilpotent, and on the other hand, the restriction of u to $\text{gim}(u)$, that is, its Leray reduction $\mathcal{L}(u)$ is an automorphism. Observe that $u|_{\text{gker}(u)}$ being nilpotent, its trace is 0 and

$$\text{trace}(u) = \text{trace}(\mathcal{L}(u)).$$

Observe also that for any $n \geq 1$ one has

$$\text{gker}(u^n) = \text{gker}(u), \quad \text{gim}(u^n) = \text{gim}(u), \quad \mathcal{L}(u^n) = \mathcal{L}(u)^n,$$

hence

$$\text{trace}(u^n) = \text{trace}(\mathcal{L}(u)^n).$$

This remark shows that the Leray reduction of a linear endomorphism determines its trace and the trace of its iterates. More importantly, Leray reduction characterizes the shift equivalence class of a linear endomorphism.

Note that for linear endomorphisms in finite-dimensional vector spaces we have that $\text{gim}(u) = \text{im}(u^{n_0})$ for some positive integer n_0 , as happened for finite maps. The argument presented in Proposition 2.2.4 can also be applied to prove that a linear endomorphism is shift equivalent to its Leray reduction. Since Leray reductions are automorphisms, hence bijective, the next proposition follows.

Proposition 2.2.5. *Two endomorphisms $u : G \rightarrow G$, $v : H \rightarrow H$ are shift equivalent if and only if their Leray reductions are conjugate.*

As a consequence, linear shift equivalent endomorphisms have equal traces. This trivial observation together with the following proposition show how some trace computations will be done in this work.

Lemma 2.2.6. *Let H be a finite-dimensional vector space and $u : H \rightarrow H$ an endomorphism. We suppose that:*

- F is a subspace that is invariant under u and included in its generalized kernel.
- G is a subspace that is invariant under u and that contains both F and $\text{gim}(u)$.

Then, the naturally induced endomorphism $\hat{u} : G/F \rightarrow G/F$ is shift equivalent to u . In particular, their traces are equal.

Proof. Since F and G are invariant under u , the map \hat{u} is well-defined and $\hat{u}(x + F) = u(x) + F$ for any $x \in G$. It follows that, for any $n \geq 0$, $\hat{u}^n(x + F) = u^n(x) + F$, hence $\text{gim}(\hat{u}) = \text{gim}(u) + F$. The projection map $\pi : G \rightarrow G/F$ induces an isomorphism between $\text{gim}(u)$ and $\text{gim}(\hat{u})$ because $\text{gim}(u) \cap F \subset \text{gim}(u) \cap \text{gker}(u) = \{0\}$. Since $\pi \circ u|_G = \hat{u} \circ \pi$, we deduce that $\pi|_{\text{gim}(u)}$ is a conjugation between $\mathcal{L}(u)$ and $\mathcal{L}(\hat{u})$. \square

Clearly, any linear endomorphism and its Leray reduction have the same non-zero complex eigenvalues, counted with multiplicity. Therefore, the spectra, except for the eigenvalue 0, of linear endomorphisms is invariant under shift equivalence. However, two linear automorphisms having equal spectra are not always conjugate because their Jordan canonical forms may differ. Thus, the following definition is slightly weaker than shift equivalence.

Definition 2.2.7. *Two endomorphisms $u : G \rightarrow G$ and $v : H \rightarrow H$ are spectrum equivalent if they have the same non-zero complex eigenvalues, counted with multiplicity, or, equivalently,*

$$\text{trace}(u^n) = \text{trace}(v^n)$$

for every positive integer n .

2.2.3 Permutation endomorphisms

We now introduce a class of maps which will help us to describe the first homological discrete Conley index. The definition has a truly combinatorial taste, as the idea behind it will be to describe combinatorially the dynamics around an isolated invariant acyclic continuum.

Definition 2.2.8. *A permutation endomorphism $u : H \rightarrow H$ is an endomorphism for which there exists a map $\varphi : J \rightarrow J$ over a finite set J , where $\#J = \dim(H)$, and a basis $\{e_j\}_{j \in J}$ of H such that $u(e_j) = e_{\varphi(j)}$. If the map φ is bijective we say u is a permutation automorphism.*

Once we move onto higher homological indices the notion of permutation endomorphism is too rigid, but a generalization of it will serve us to describe them.

Definition 2.2.9. *An endomorphism $u : H \rightarrow H$ is dominated by a finite map $\varphi : J \rightarrow J$ if there exists a decomposition $H = \bigoplus_{j \in J} H_j$ such that $u(H_j) \subset H_{\varphi(j)}$ for every $j \in J$.*

Observe that if u is dominated by a fixed-point free finite map φ , then $\text{trace}(u) = 0$. This trivial remark indicates the way we will prove Theorem 2.1.2.

In the computations, reduced homology groups will naturally appear. As a consequence, permutation endomorphisms do not exactly provide the required description of the first homological index and we need to include the following definition.

Definition 2.2.10. *A reduced permutation endomorphism (automorphism) is obtained from a permutation endomorphism (automorphism) $u : H \rightarrow H$ associated to a basis $\{e_j\}_{j \in J}$ and a map $\varphi : J \rightarrow J$ by taking the restriction v of u to $\ker(\delta)$ where $\delta : H \rightarrow \mathbb{Q}$ is the linear form that sends each e_j to 1.*

As u and v are completely determined by φ , up to conjugacy, we will sometimes say that φ defines the permutation endomorphism u and the reduced permutation endomorphism v .

Proposition 2.2.11. *The reduction v of a permutation endomorphism u satisfies*

$$\text{trace}(v^n) = \text{trace}(u^n) - 1,$$

for every $n \geq 1$.

Proof. Consider a basis of $\ker(\delta)$ and a vector e_j which extends it to a basis of H . Then, for every $n \geq 1$, $\delta(u^n(e_j)) = 1$, hence $u^n(e_j) - e_j \in \ker(\delta)$ and the formula for the traces follows. \square

The final part of this section is devoted to show how the traces of permutation endomorphisms and its iterates can be computed. We will deduce that this sequence of traces satisfies the so-called Dold's congruences, which were first introduced in [Do83].

Definition 2.2.12. A sequence of integers $I = \{I_n\}_{n \geq 1}$ is said to satisfy Dold's congruences if, for every $n \geq 1$,

$$\sum_{k|n} \mu(n/k) I_k \equiv 0 \pmod{n}.$$

The Möbius function μ assigns to each natural number n a value $-1, 0$ or 1 , depending on its prime decomposition. If a factor appears at least twice in the prime decomposition then $\mu(n) = 0$, otherwise $\mu(n) = (-1)^s$, where s is the number of prime factors of n . Dold's congruences can be described in a more elementary way. Consider the following normalized sequences $\sigma^k = \{\sigma_n^k\}_{n \geq 1}$, where

$$\sigma_n^k = \begin{cases} k & \text{if } n \in k\mathbb{N} \\ 0 & \text{otherwise.} \end{cases}$$

Every sequence $I = \{I_n\}_{n \geq 1}$ can be written as a formal combination of normalized sequences, $I = \sum_{k \geq 1} a_k \sigma^k$. A sequence I satisfies Dold's congruences if and only if all coefficients a_k are integers. As observed by Babenko and Bogaty, see [BB92], a sequence satisfying Dold's congruences is periodic if and only if it can be written as a finite combination of normalized sequences. An equivalent definition of Dold's congruences is given by the following lemma:

Lemma 2.2.13. A sequence $I = \{I_n\}_{n \geq 1}$ satisfies Dold's congruences if and only if there exist maps φ and φ' such that

$$I_n = \#\text{Fix}(\varphi^n) - \#\text{Fix}((\varphi')^n).$$

Proof. If a_k denotes the number of k -periodic orbits of a map φ it is clear that

$$\#\text{Fix}(\varphi^n) = \sum_{k|n} k \cdot a_k$$

and it follows that

$$\{\#\text{Fix}(\varphi^n)\}_{n \geq 1} = \sum_{k \geq 1} a_k \sigma^k$$

satisfies Dold's congruences. From their definition we obtain that these congruences preserve addition and integer multiplication, hence the sequence $\{\#\text{Fix}(\varphi^n) - \#\text{Fix}((\varphi')^n)\}_{n \geq 1}$ also satisfies Dold's relations.

Conversely, if $I = \sum_{k \geq 1} a_k \sigma^k$ then define φ with exactly a_k orbits of period k for every $a_k > 0$ and φ' with $-a_k$ orbits of period k for every $a_k < 0$. \square

Let us conclude this section with the following result whose proof is straightforward:

Proposition 2.2.14. *Let u be a permutation endomorphism defined by a finite map φ . Then, the sequence $\{\text{trace}(u^n)\}_{n \geq 1}$ is equal to the sequence $\{\#\text{Fix}(\varphi^n)\}_{n \geq 1}$, where $\#\text{Fix}(\varphi^n)$ denotes the number of fixed points of φ^n . In addition, it satisfies Dold's congruences.*

2.2.4 Acyclic continua

The class of compact subsets of \mathbb{R}^d to which our results apply is that of acyclic continua. In the literature, the term acyclic is often used to call sets such that all its reduced homology groups vanish. Since we deal with general compact sets, the more appropriate homology theory for our setting is Čech homology and we will say that a set K is *acyclic* if $\check{H}_r(K) = 0$ for all $r \geq 1$. All the homology groups appearing in this work are equipped with rational coefficients.

The following proposition gives an alternative definition of acyclic continuum, which is the one we will use later.

Proposition 2.2.15. *A continuum $K \subset \mathbb{R}^d$ is acyclic if and only if for every neighborhood U of K , there exists another neighborhood $V \subset U$ of K such that the inclusion-induced maps $H_r(V) \rightarrow H_r(U)$ are trivial for every $r \geq 1$.*

Proof. Let us prove sufficiency first. Inductively, construct a basis of neighborhoods $\{U_n\}_{n \geq 1}$ of K such that the inclusion-induced maps $H_r(U_{n+1}) \rightarrow H_r(U_n)$ are trivial for all $n, r \geq 1$. The continuity property of Čech homology implies that $\check{H}_r(K)$ is isomorphic to the inverse limit of the inverse system formed by the groups $\{H_r(U_n)\}_{n \geq 1}$ together with the linear maps $p_{m,n} : H_r(U_m) \rightarrow H_r(U_n)$, for $m \geq n$, induced by inclusion. Since all these maps are trivial by assumption, the inverse limit is zero and all Čech homology groups are trivial for $r \geq 1$, hence K is acyclic.

Conversely, take a basis of neighborhoods $\{U_n\}_{n \geq 1}$ of K composed of compact polyhedra. Since K is acyclic, $\varprojlim H_r(U_n) = 0$. Given any $n \geq 1$, consider the nested sequence $\{\text{im}(p_{m,n})\}_{m \geq n}$ of vector subspaces of $H_r(U_n)$ and denote their intersection A_n . Since $H_r(U_n)$ is finite dimensional, there exists $n_0 \geq n$ such that $\text{im}(p_{n_0,n}) = A_n$. For every $k \geq m \geq n$ we have that $p_{k,n} = p_{k,m} \circ p_{m,n}$, hence the subspaces A_n are mapped onto each other, that is, $p_{m,n}(A_m) = A_n$ for every $m \geq n$. Thus, for a given $x \in A_n$ it is possible to construct a sequence $\{x_m\}_{m \geq n}$ such that $x_n = x$ and $p_{m+1,m}(x_{m+1}) = x_m$ for any $m \geq n$. As a consequence, if any $A_n \neq \{0\}$ the inverse limit of the sequence $\{H_r(U_n)\}_{n \geq 1}$ can not be trivial. Therefore, for any n one can find n_0 so that $\text{im}(p_{n_0,n}) = \{0\}$, that is, the map $p_{n_0,n} : H_r(U_{n_0}) \rightarrow H_r(U_n)$ is the zero map. After taking the maximum of a finite set of bounds, we can assume the latter holds for every $r \geq 1$. For every element U of $\{U_n\}_{n \geq 1}$ we have proved that there is another element of the sequence, V , such that $H_r(V) \rightarrow H_r(U)$ is trivial for every $r \geq 0$. Since $\{U_n\}_{n \geq 1}$ is a basis of neighborhoods of K , the proof is finished. \square

The previous proposition shows that the isomorphism between $\check{H}_r(K)$ and the trivial group extends to an isomorphism between the pro-group formed by the groups $H_r(U_n)$ and the inclusion-induced maps and the zero pro-group, for any basis of open neighborhoods $\{U_n\}_{n \geq 1}$ of K . This ultimately comes from the fact that, since we use rational coefficients, the sequence $\{H_r(U_n)\}_{n \geq 1}$ satisfies the Mittag-Leffler condition. This result was first proved, in a more general setting, in [Ke76] (see also [MS82]).

Finally, note that in the plane a continuum is acyclic if and only if it is cellular. Take a sequence of compact neighborhoods $\{W_n\}_{n \geq 1}$ of $K \subset \mathbb{R}^2$ which are manifolds with boundary. Assume that K is acyclic and, without loss of generality, that the inclusions $W_{n+1} \subset W_n$ are homologically trivial. Then, it is possible to find D_n , a topological disk, such that $W_{n+1} \subset D_n \subset W_n$. The nested sequence $\{D_n\}_{n \geq 1}$ has also limit K , hence K is cellular.

2.2.5 Isolating blocks and filtration pairs

Our aim in this subsection is to introduce some topological notions that are necessary to describe discrete Conley index theory. Throughout this text we will often work with the relative topology of closed subsets of \mathbb{R}^d or, more generally, manifolds with boundary N . Given two subsets $A \subset B$ of N such that B is closed, \bar{A} will denote the closure of A , $\text{int}(A)$ and $\text{int}_B(A)$ the interior of A and its interior relative to B and $\partial A = \bar{A} \setminus \text{int}(A)$ and $\partial_B A = \bar{A} \cap (\bar{B} \setminus A) = \bar{A} \setminus \text{int}_B(A)$, the boundary and relative boundary of A , respectively.

Let M be a d -manifold without boundary. A *regular decomposition* (M_1, M_2) of M is a pair of d -submanifolds with boundary such that $M_1 \cup M_2 = M$ and $\partial M_1 = \partial M_2$. Similarly, a regular 2-decomposition (N_1, N_2) of a d -manifold with boundary N is a pair of d -manifolds with boundary such that there exist regular decompositions $(M_{1,1}, M_{1,2})$ of ∂N_1 and $(M_{2,1}, M_{2,2})$ of ∂N_2 satisfying

$$N_1 \cup N_2 = N, \quad N_1 \cap N_2 = M_{1,2} = M_{2,1}.$$

In that case $\partial N = M_{1,1} \cup M_{2,2}$ and every connected component of $N_1 \cap N_2$ defines an element of the group $H_{d-1}(N, \partial N)$. We will need also the notion of regular 3-decomposition (N_1, N_2, N_3) of N . It consists of a triple of d -manifolds with boundary such that there exists a regular decomposition $(M_{1,1}, M_{1,2})$ of ∂N_1 , a regular decomposition $(M_{3,2}, M_{3,3})$ of ∂N_3 , a regular decomposition $(M_{1,3}, M_{2,2})$ of ∂N_2 and a partition $M_{1,3} = M_{1,2} \sqcup M_{2,3}$ in open and closed submanifolds such that

$$N_1 \cup N_2 \cup N_3 = N, \quad N_1 \cap N_2 = M_{1,2} = M_{2,1}, \quad N_2 \cap N_3 = M_{2,3} = M_{3,2}, \quad N_1 \cap N_3 = \emptyset.$$

In that case $\partial N = M_{1,1} \cup M_{2,2} \cup M_{3,3}$ and every connected component of $M_{1,3}$ defines an element of $H_{d-1}(N, \partial N)$.

A pair (N, L) of compact subsets of \mathbb{R}^d is said to be *regular* if N is a d -manifold with boundary and $(N \setminus L, L)$ is a regular 2-decomposition of N . Similarly, a triple (N, L, L') is *regular* provided that $(N \setminus L, L \setminus L', L')$ is a regular 3-decomposition of N . Note that for a regular pair (N, L) the quotient space N/L is guaranteed to be a compact metric ANR, see Chapter IV in [Hu65]. Consequently, there exists a natural isomorphism, $\tilde{H}_*(N/L) \sim H_*(N, L)$, between reduced and relative homology groups.

Next, we define some dynamical concepts. Let f be a local map of \mathbb{R}^d and N a compact set included in its domain. Denote $\text{Inv}^m(N)$ the set of points $x \in N$ such that there exists $\{x_n\}_{-m}^m \subset N$ with $x_0 = x$ and $f(x_n) = x_{n+1}$ for any $-m \leq n < m$. The compact sets $\text{Inv}^m(N)$ are nested and satisfy $f(\text{Inv}^{m+1}(N)) \subset \text{Inv}^m(N)$. The largest subset A of N which is invariant by f , that is $f^{-1}(A) = A$, is denoted $\text{Inv}(f, N)$. A point $x \in N$ belongs to $\text{Inv}(f, N)$ if and only if there is a complete solution of f through x , that is, there exists $\{x_n\}_{-\infty}^{\infty} \subset N$ such that $x_0 = x$ and $f(x_n) = x_{n+1}$. Since we work in

a locally compact setting, we have that

$$\text{Inv}(f, N) = \bigcap_{m \geq 0} \text{Inv}^m(N).$$

See [FR00] for a proof. In case we work with homeomorphisms existence of complete solutions is guaranteed by the invertibility of the map and the compactness argument is unnecessary. Notice that if the map is one-to-one

$$\text{Inv}^m(N) = \bigcap_{n=-m}^m f^{-n}(N) \quad \text{and} \quad \text{Inv}(f, N) = \bigcap_{n=-\infty}^{\infty} f^{-n}(N).$$

The *stable set* of f in N , $\Lambda^+(f, N)$, consists of the set of points of N whose forward orbit remains in N ,

$$\Lambda^+(f, N) = \bigcap_{n \geq 0} f^{-n}(N).$$

Similarly, the *unstable set* $\Lambda^-(f, N)$ of f in N is defined as

$$\Lambda^-(f, N) = \bigcap_{n \geq 0} f^n(N).$$

It coincides with the set of points of N for which there exists a complete past solution $\{x_n\}_{-\infty}^0$ such that $x_0 = x$, only because we work in a locally compact setting. Of course, the largest subset of N invariant under f satisfies

$$\text{Inv}(N) = \Lambda^+(f, N) \cap \Lambda^-(f, N).$$

It is worth noting that the stable and unstable sets are compact.

In the case $\text{Inv}(N) \subset \text{int}(N)$, we say that N is an *isolating neighborhood*. A compact invariant set X for which there exists an isolating neighborhood N such that $\text{Inv}(N) = X$ is called an *isolated invariant set*. Note that for any isolating neighborhood N of X we have $X = \Lambda^+(f, N) \cap \Lambda^-(f, N)$. Recall that if X has a compact neighborhood N such that $\bigcap_{n=-\infty}^{\infty} f^n(N) = X$ or $\bigcap_{n=-\infty}^{\infty} f^{-n}(N) = X$ then X is called an attractor or a repeller, respectively. Finally, a compact set N which presents no interior “discrete tangencies”, i.e.

$$f^{-1}(N) \cap N \cap f(N) \subset \text{int}(N)$$

is called an *isolating block*. Notice that every isolating block is also an isolating neighborhood. It is known that every isolated invariant set admits a fundamental system of neighborhoods which are isolating blocks, see for example [Ea89]. From the definition, we see that if N' is close enough to N then N' is also an isolating block. Thus, isolating blocks can be chosen to be d -manifolds with boundary. Now, we introduce a concept which is due to Franks and Richeson, see [FR00].

Definition 2.2.16. *A pair of compact sets (N, L) is a filtration pair for the invariant set X provided N and L are the closure of their interiors and the following properties are satisfied:*

1. $\overline{N \setminus L}$ is an isolating neighborhood of $X = \text{Inv}(\overline{N \setminus L})$.

2. L is a neighborhood of the exit set of N , $N^- = \{x \in N : f(x) \notin \text{int}(N)\}$.
3. $f(L) \cap \overline{(N \setminus L)} = \emptyset$.

This is the object which will be most used throughout this work as it serves to define the discrete Conley index. The following proposition, based in the robustness of the definition of filtration pair, shows that it can always be assumed to satisfy nice local properties.

Proposition 2.2.17. *Regular filtration pairs (N, L) exist for any isolated invariant set X .*

Proof. Let N be an isolating block for X which is also a d -manifold with boundary. Define $N^- = \{x \in N : f(x) \notin \text{int}(N)\}$. Clearly, $f(N^-) \cap N \subset \partial N$ and that implies, since N is an isolating block, that for every $x \in f(N^-) \cap N$ its image is $f(x) \notin N$. Consequently, the compact sets $f(N^-)$ and $N \setminus N^-$ are disjoint.

Therefore, if we consider a small neighborhood L of N^- in N , we clearly have that $f(L) \cap \overline{(N \setminus L)} = \emptyset$ and also that $N \setminus L$ is an isolating neighborhood of X . Choosing L to fit in a regular pair (N, L) , we obtain the desired regular filtration pair for X . \square

Additionally, this proof shows that it is possible to find regular filtration pairs as close to X as required.

One of the main difficulties which we have encountered in the realization of this work is the lack of results concerning the topology of isolating blocks and filtration pairs. Intuition says that it should be possible to assume that their topologies are similar to the topology of the isolated invariant set. However, no result in this direction is known for dimension larger than 2. For $d = 2$, homeomorphisms and a fixed point, it is known [RS02] that there are isolating blocks that are closed disks and it is possible to choose a filtration pair (N, L) so that N is also a closed disk and L is a finite union of disks.

Example 2.2.18. Let $d > k > 0$ two positive integers. Denote $N = [-1, 1]^d$ the closed unit d -cube in $\mathbb{R}^d = \mathbb{R}^k \oplus \mathbb{R}^{d-k}$. For any $0 < t \leq 1$, define the subsets

$$L_t^- = \{x \in \mathbb{R}^k : t \leq \|x\| \leq 1\} \times \mathbb{R}^{d-k} \quad \text{and} \quad L_t^+ = \mathbb{R}^k \times \{y \in \mathbb{R}^{d-k} : t \leq \|y\| \leq 1\}$$

of N . Evidently, N, L_t^- and L_t^+ are d -manifolds with boundary for any $0 < t < 1$. Define $l_t^- = \{x \in \mathbb{R}^k : \|x\| = t\} \times \mathbb{R}^{d-k}$ and $l_t^+ = \mathbb{R}^k \times \{y \in \mathbb{R}^{d-k} : \|y\| = t\}$. For $0 < t < 1$, the sets l_t^- and l_t^+ are the boundaries of L_t^- and L_t^+ with respect to N , respectively.

First, let us show that (N, L_t^-) is a regular pair. The sets L_t^- and $\overline{N \setminus L_t^-}$ meet at $l_t^- = \{\|x\| = t\} \times \mathbb{R}^{d-k}$. Consider

$$M_t^* = (\{\|x\| = 1\} \times \mathbb{R}^{d-k}) \cup \{t \leq \|x\| \leq 1\} \times \{\|y\| = 1\}, \quad M_t = \{\|x\| \leq t\} \times \{\|y\| = 1\}.$$

Notice that (M_t^*, l_t^-) is a regular decomposition of ∂L_t^- and (l_t^-, M_t) is a regular decomposition of the boundary of $\overline{N \setminus L_t^-}$ as well. Consequently, (N, L_t^-) is a regular pair. A similar argument shows that (N, L_t^+) is a regular pair as well.

Fix $1 < s < t < 0$. The triple (N, L_t^-, L_s^-) is regular. Firstly, notice that L_s^- is disjoint to $\overline{N \setminus L_t^-}$. Regular decompositions of ∂L_s^- and $\partial(\overline{N \setminus L_t^-})$ are given by

(M_s^*, l_s^-) and (l_t^-, M_t) , respectively. A suitable decomposition of the boundary of the set $\overline{L_t^- \setminus L_s^-} = \{t \leq \|x\| \leq s\} \times \mathbb{R}^{d-k}$ is defined by $(M_t^* \cap M_s, l_t^- \cup l_s^-)$.

Now, let A be a $d \times d$ matrix and consider the dynamics generated by the linear map $f(z) = Az$ in \mathbb{R}^d . Assume A is diagonal, hyperbolic and real and in the first k of the diagonal of A lie all its eigenvalues with modulus greater than 1. It is easy to check that $\{0\}$ is the unique bounded invariant set, so any neighborhood of the origin is an isolating neighborhood of $\{0\}$. Take $t > 1/\lambda$, where λ is the largest eigenvalue in modulus of A . Then, the pair (N, L_t^-) is a filtration pair. Clearly, if $(x', y') = f(x, y)$ and $\|x\| \leq t$ then $\|x'\| \leq \lambda t < 1$. Additionally, we have that $\|x'\| > \|x\|$ and $\|y'\| < \|y\|$. As a consequence, $f(\overline{N \setminus L_t^-}) \subset \text{int}(N)$ and $f(L_t^-)$ does not meet $\overline{N \setminus L_t^-}$. Notice that the previous inequalities prove that N is an isolating block. In an analogous fashion can be shown that (N, L_t^+) is a regular filtration pair for f^{-1} as long as A is invertible and $t < \lambda'$, where λ' is the smallest eigenvalue in modulus of A .

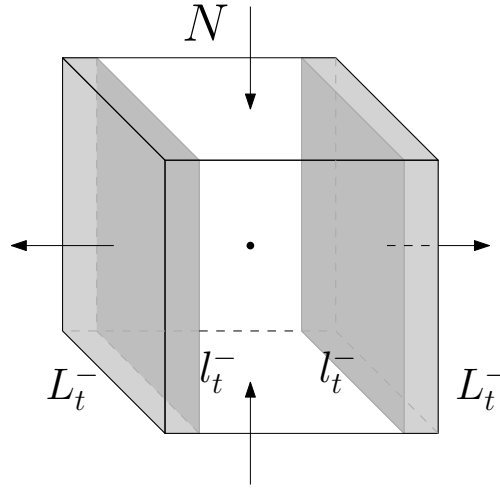

Figure 2.2: Example 2.2.18 with $k = 1$ and $d = 3$.

2.2.6 Conley index and Lefschetz-Dold Theorem

Let f be a local map of \mathbb{R}^d and X an isolated invariant set. Consider a regular filtration pair (N, L) for X . Denote $\pi : N \rightarrow N/L$ the projection onto the quotient space N/L that sends every point $z \in N \setminus L$ onto itself and every point $z \in L$ onto the point $[L]$. The definition of filtration pair allows to define a continuous map $\bar{f} : N/L \rightarrow N/L$ that fixes the basepoint $[L]$ and sends every point $z \in N \setminus L$ onto $\pi(f(z))$. Notice that we have implicitly identified $N/L - [L] \sim N \setminus L$. The induced basepoint preserving map \bar{f} , which seems to depend strongly in the choice of filtration pair turns out to ultimately depend only on the invariant set X , up to shift equivalence. The notion of shift equivalence was defined in Subsection 2.2.2 and applies to the category \mathbf{Top}_* , whose objects are pointed topological spaces and the morphisms are continuous base-preserving maps. The importance of shift equivalence is highlighted by the following theorem.

Theorem 2.2.19 (Franks-Richerson). *All maps \bar{f} arising from filtration pairs (N, L) of X are shift equivalent.*

The *discrete Conley index* of X is defined as the shift equivalence class of the map \bar{f} . For a complete proof of this theorem we refer the reader to [FR00].

We could have also considered the induced maps $\bar{f}_{*,r} : \tilde{H}_r(N/L) \rightarrow \tilde{H}_r(N/L)$ in the reduced homology groups with rational coefficients. Then, all possible endomorphisms $\bar{f}_{*,r}$ are shift equivalent, in other words, their Leray reductions $\mathcal{L}(\bar{f}_{*,r})$ are conjugate. The shift equivalence class of $\bar{f}_{*,r}$ is called *r-homological discrete Conley index of X* and denoted $h_r(f, X)$.

Mrozek [Mr89] was the first to point out that the information about the fixed point index of an isolated invariant set is contained in its Conley index. Apply Lefschetz-Dold Theorem 2.2.1 to the map $\bar{f} : N/L \rightarrow N/L$. Note that N and L are compact manifolds with boundary so, in particular, compact metric ANRs and so is their quotient N/L (see [Hu65] Chapter IV). From the definition of filtration pair we get that \bar{f} is locally constant at $[L]$, hence $i(\bar{f}, [L]) = 1$, and f and \bar{f} are locally conjugate around $X = \text{Inv}(\overline{N \setminus L})$. Lefschetz-Dold Theorem 2.2.1 yields

$$\Lambda(\bar{f}) = i(\bar{f}, N/L) = 1 + i(f, X),$$

where $\Lambda(\bar{f})$ denotes the *Lefschetz number* of \bar{f} , defined as the alternate sum of the traces of the maps induced by \bar{f} in the singular homology groups $H_r(N/L)$, $r \geq 0$. A similar equation can be deduced for any iterate of f . For $n \geq 1$,

$$\Lambda((\bar{f})^n) = 1 + i(f^n, X). \quad (2.5)$$

This last equation requires some clarification. Despite the pair (N, L) is not a filtration pair, in general, for X and the map f^n , we can define a map $\bar{f}^n : N/L \rightarrow N/L$ by fixing the basepoint $[L]$ and sending $x \in N \setminus L$ to $[L]$ if any of its first n forward images lies in L and to $f^n(x)$ otherwise. It is not difficult to see that $\bar{f}^n = (\bar{f})^n$, hence Equation (2.5) results from applying Lefschetz-Dold Theorem to the map \bar{f}^n .

We will estimate the fixed point indices $i(f^n, X)$ by examining the Lefschetz numbers, $\Lambda((\bar{f})^n)$. More concretely, we would like to compute the traces of the finite-dimensional linear maps

$$(\bar{f}_{*,r})^n : \tilde{H}_r(N/L) \rightarrow \tilde{H}_r(N/L), \quad 0 \leq r \leq d.$$

Expanding the definition of $\Lambda((\bar{f})^n)$ we obtain

$$\Lambda((\bar{f})^n) = 1 + \sum_{r=0}^d (-1)^r \text{trace}((\bar{f}_{*,r})^n) = 1 + \sum_{r=0}^d (-1)^r \text{trace}(h_r(f^n, X)), \quad (2.6)$$

where the extra 1 makes up for the small gap between the reduced and singular homology groups at grade 0. Note that all higher homology groups of N/L are trivial because N and L are d -manifolds with boundary. The notion of trace of $h_r(f, X)$ is well-defined because traces are invariant under shift equivalence. Substituting equation (2.6) into (2.5), we obtain equation (2.2),

$$i(f^n, X) = \sum_{r=0}^d (-1)^r \text{trace}(h_r(f^n, X)). \quad (2.2)$$

2.2.7 Attractors, repellers and nilpotence

Attractors and repellers are friendly objects to work with as their dynamics are easier to describe. Recall that a compact invariant set X is called an *attractor* (resp. *repeller*) provided it has a neighborhood W such that $X = \bigcap_{n \geq 0} f^n(W)$ (resp. $X = \bigcap_{n \geq 0} f^{-n}(W)$). As we work in a locally compact setting we will assume that W is compact. Notice that in both cases W is an isolating neighborhood of X .

The fact that an isolating neighborhood of an attractor or a repeller can be assumed to be forward or backward invariant, respectively, can be deduced from its definition. Assume X is an attractor and $k > 0$ is large enough so that $N := \bigcap_{n \geq 0} f^n(W) \subset \text{int}(W)$. Then,

$$f(N) = \bigcap_{n \geq 1} f^n(W) = \bigcap_{n \geq 0} f^{n+1}(W) = N \cap f^{k+1}(W) \subset N.$$

Thus, N is a forward invariant isolating neighborhood of X . A similar construction can also be carried out for repellers in order to obtain a backward invariant neighborhood of X .

Consider an attracting fixed point p and a compact isolating neighborhood N of p which is forward invariant, $f(N) \subset N$. Clearly, $\{p\} = \bigcap_{n \geq 0} f^n(N)$. One may wonder to what extent the topology of N is trivial as that of a point. The following well-known proposition points out that the homological information is trivialized by the dynamics. In the proof we present here, we follow the work of Richeson and Wiseman in [RW02].

Proposition 2.2.20 (Richeson-Wiseman). *Let f be a local map in \mathbb{R}^d , p an attracting fixed point and N a compact isolating neighborhood such that $f(N) \subset N$ and $\text{Inv}(N) = \{p\}$. Assume additionally that N is a manifold. Then, $i(f, p) = i(f, N) = 1$.*

Proof. Let B a closed ball contained in N centered at p . The forward orbit of any point eventually lies in B . A compactness argument then shows that there exists a positive integer n such that $f^n(N) \subset B$. Denote $f_{*,k} : H_k(N, \mathbb{Q}) \rightarrow H_k(N, \mathbb{Q})$ the map induced by f in the k -homology group of N with rational coefficients. Then, the map $f_{*,k}^n$ factors through the group $H_k(B, \mathbb{Q})$, which is trivial for $k > 0$ and isomorphic to \mathbb{Q} for $k = 0$. Consequently, for $k > 0$ the map $f_{*,k}^n$ is trivial so $f_{*,k}$ is nilpotent and has zero trace. For $k = 0$, the map $f_{*,0}$ eventually sends every element $[N_i]$ to $[N_0]$, where $[N_i]$ and $[N_0]$ denote the 0-cycles associated to the connected components N_i and N_0 of N and N_0 contains p . Therefore, $\text{trace}(f_{*,0}) = 1$.

Lefschetz Theorem applied to the restriction of f to N yields that

$$i(f, p) = i(f, N) = \sum_{k \geq 0} (-1)^k \text{trace}(f_{*,k}) = \text{trace}(f_{*,0}) = 1.$$

□

As remarked by the authors, the previous theorem also holds if we replace the point by an acyclic continuum. Furthermore, the regularity hypothesis which asks N to be a manifold can be dropped in view of the following lemma.

Lemma 2.2.21. *Let N be a compact isolating neighborhood of X such that $f(N) \subset N$. Then, there exists a compact manifold N' , as close to N as desired, that is an isolating neighborhood such that $\text{Inv}(N') = X$ and $f(N') \subset \text{int}(N')$.*

Proof. Here we use the routine of adding “bubbles” which will be thoroughly exploited in Subsection 2.4.1. For any point $x \in N$, let $n(x)$ be the largest integer such that $f^{n(x)}(x)$ belongs to ∂N or 0 if it never happens. It is well defined because the forward orbit of every $x \in N$ tends to p . Since N is an isolating neighborhood, $m = \max_{x \in N} n(x) < \infty$. For any $1 \leq k \leq m$ let A_k be a subset of ∂N composed of the points $x \in \partial N$ such that there exists $y \in N$ with $y, f(y), \dots, f^k(y) = x$ contained in N . Note that $A_1 \neq \emptyset$ unless $f(N) \subset \text{int}(N)$. Evidently, the sets A_k are compact and nested, $f(A_{k+1}) \subset A_k$ and $f(A_1) \subset \text{int}(N)$. Consider compact neighborhoods V_k of A_k such that $f(V_{k+1}) \subset V_k$ and $f(V_1) \subset \text{int}(N)$. Then, $N' = N \cup V_1 \cup \dots \cup V_m$ is an isolating neighborhood of X and $f(N') \subset \text{int}(N')$. Since this last condition is open we can modify N' slightly and assume additionally that it is a manifold with boundary. \square

Therefore, an attracting fixed point, or more generally an acyclic continua, always has a forward invariant compact neighborhood N which is a manifold. We can assume further that N is connected by considering only the connected component which contains the invariant set X .

Note that if $f(N) \subset \text{int}(N)$ then N is an isolating block and (N, \emptyset) is a filtration pair for X . The traces of the homological Conley indices for X and f have already been computed in Proposition 2.2.20. They remain invariant if we replace f by f^n for any positive integer n . The only one of them which is non-zero is

$$\text{trace}(h_0(f^n, X)) = 1,$$

for any $n > 0$. Substituting in Equation 2.2 we obtain $i(f^n, X)$ as it was concluded in Proposition 2.2.20.

Let us replace now attractors by repellers. Following a similar argument as the one contained in Lemma 2.2.21, it is always possible to construct a connected isolating neighborhood N of X such that $f(\partial N) \cap N = \emptyset$. Note that this property implies that N is contained in the interior of $f(N)$. Without loss of generality assume that N is a manifold with boundary.

Unfortunately, if f is not a homeomorphism not much can be said about the fixed point index of a repeller. Nevertheless, in the plane the description is not difficult, as the next proposition shows.

Proposition 2.2.22. *Let f be a local map in \mathbb{R}^2 , p a fixed point and N an isolating neighborhood of p such that $N \subset f(N)$. Then, there exists an integer $d \neq 0$ such that $i(f^n, p) = d^n$ for any $n \geq 1$.*

Proof. Assume without loss of generality that N is manifold with boundary and a connected neighborhood of p such that $f(\partial N)$ lies outside N . Now, collapse each connected component of ∂N to a point and denote \widehat{N} the quotient space. Note that \widehat{N} is homeomorphic to the 2-sphere. Since each $\lambda \in \pi_0(\partial N)$ is a Jordan curve, it bounds an open disk which does not meet N . The map f naturally induces a map $\widehat{f} : \widehat{N} \rightarrow \widehat{N}$ for if $f(x) \notin \text{int}(N)$ then $\widehat{f}(x)$ corresponds to the connected component of ∂N which bounds the closed disk of $S^2 \setminus \text{int}(N)$ to which $f(x)$ belongs. Since every closed disk of $S^2 \setminus \text{int}(N)$ is sent inside a unique connected component of $S^2 \setminus N$, the map \widehat{f} is well-defined. Clearly, \widehat{f} is conjugate to f in a neighborhood p . Moreover, the set $F = \{q_1, \dots, q_m\}$ composed of

the points which correspond to the components of ∂N is a local attractor and, additionally, \widehat{f} is locally constant at F . However, if the largest \widehat{f} -invariant subset of F consists of more than one point we arrive at a contradiction. Assume $m > 1$ and choose $k > 0$ so that $\widehat{f}_{|F}^k = \text{id}_{|F}$. Every point q_i is an attracting fixed point for \widehat{f}^k and the basins of attraction defined are disjoint open subsets of \widehat{N} . Then, there exists $x \neq p$ in N such that $\pi(x)$ does not belong to any basin of attraction of q_i , where $\pi : N \rightarrow \widehat{N}$ denotes the projection map. This implies that the full orbit of $\pi(x)$ under \widehat{f} is contained in $\widehat{N} \setminus F$ or, equivalently, $x \in \text{Inv}(f, N)$. Since $x \neq p$ we deduce that $m = 1$ and $F = \{q_1\}$. Since q_1 is attracting, Lefschetz Theorem yields that

$$1 + i(f^n, p) = i(\widehat{f}^n) = \Lambda(\widehat{f}^n) = 1 + d(\widehat{f})^n,$$

where $d(\widehat{f})$ denotes the degree of the map $\widehat{f} : \widehat{N} \rightarrow \widehat{N}$ as a map of the 2-sphere. Note that $d \neq 0$ because the fact that $N \subset f(N)$ implies that \widehat{f} is onto. The conclusion trivially follows. \square

If we restrict our considerations to local homeomorphisms in \mathbb{R}^d , the fixed point index and Conley index can be completely described. The following result shows that we can always choose suitable filtration pairs for X .

Proposition 2.2.23 (Proposition 3 in [LRS10]). *Let f be a local homeomorphism in \mathbb{R}^d and X an isolated invariant continuum. There exists a regular filtration pair (N, L) for X which satisfies the following conditions.*

1. *If X is neither an attractor nor a repeller, one may suppose that N is connected, L is not empty and that no bounded component of $\mathbb{R}^d \setminus L$ is included in N .*
2. *If X is a repeller, one may suppose that N is connected, L is not empty and that there exists a unique bounded component of $\mathbb{R}^d \setminus L$ included in N and this component includes X .*
3. *If X is an attractor, one may suppose that N is connected and L is empty.*

As an aside, notice that the previous work carried out in this subsection shows that the result for attractors obtained in Proposition 2.2.23 is also valid for local maps, not just for homeomorphisms.

Applying the last proposition to X , a repeller, we obtain a filtration pair (N, L) which satisfies $H_d(N/L) \sim \mathbb{Q}$ and, as a consequence,

$$\text{trace}(h_d(f^n, X)) = d(f)^n.$$

By connectedness of N/L , we obtain that $\text{trace}(h_0(f^n, X)) = 0$. This result agrees with Szymczak's duality, which will be described in Subsection 2.4.4. Applying this duality we obtain $\text{trace}(h_r(f^n, X)) = \text{trace}(h_{d-r}(f^{-n}, X))$ and, since a repeller for f is an attractor for f^{-1} , the previous computations show that $\text{trace}(h_r(f^n, X)) = 0$ for any $0 < r < d$. Finally, we obtain that $i(f^n, X) = (-1)^d d(f)^n$, which agrees with the well-known formula for repelling fixed points.

These computations prove Theorem 2.1.1 for attractors and also for repellers provided f is a homeomorphism. Simply set, for repellers in $d > 1$ and attractors, φ to be the

identity map in a set consisting of one or two points, respectively. In the remaining case, a repeller in dimension $d = 1$, define φ as the identity in a two-element set if f preserves orientation and as the permutation that swaps the elements if f reverses orientation. The hypothesis of Theorem 2.1.2 are never satisfied for these particular invariant sets. Theorem 2.1.8 also follows easily, as we have shown that the sequence $\{i(f^n, p)\}_{n \geq 1}$ is equal to $\sigma^1 - \sigma^2$ for repellers when f is a local orientation-reversing homeomorphism of \mathbb{R}^3 and to σ^1 otherwise.

In the case f is a homeomorphism and X is neither an attractor nor a repeller, by Proposition 2.2.23 we can assume also that N is connected, L is not empty and $H_d(N/L)$ is trivial. Consequently, $\text{trace}(h_0(f^n, X)) = 0$ and $\text{trace}(h_d(f^n, X)) = 0$. However, no further assumptions on the topology of the filtration pair (N, L) can be made. Equation (2.2) simplifies into

$$i(f^n, X) = \sum_{r=1}^{d-1} \text{trace}(h_r(f^n, X)). \quad (2.7)$$

In particular, for local homeomorphisms of \mathbb{R}^3 we will need just to examine the maps $\tilde{f}_{*,1}$ and $\tilde{f}_{*,2}$ in order to compute $i(f^n, X)$.

2.3 Fixed point index for continuous maps in \mathbb{R}^2

The work contained in this section is intended to illustrate the techniques and results obtained in this chapter in a quite pleasant framework. The main result is Theorem 2.3.1, where we prove a characterization for the fixed point index sequence of a fixed point of a planar map which is isolated as an invariant set. The complete analysis of the first discrete homological Conley index contained in Theorem 2.1.1 is enough to prove this result. It suffices to apply Equation 2.7 for the particular case $d = 2$. However, we present a proof of Theorem 2.3.1 which does not use the more sophisticated arguments used later in this chapter but a rougher version of them. Furthermore, we feel that in \mathbb{R}^2 it is easier to understand the geometrical and dynamical ideas of our work.

Recall from Subsection 2.2.4 that a planar continuum K is acyclic if and only if it is cellular. It is well-known [Br60] that the quotient \mathbb{R}^2/K is homeomorphic to \mathbb{R}^2 . Therefore, fixed points can be replaced by acyclic invariant continua in all this section and the results remain valid.

2.3.1 Statement of the theorem

In Subsection 2.1.3 we learned that the fixed point index and, more generally, the fixed point index sequence of a fixed point isolated as an invariant set of a planar homeomorphism is completely understood. General formulas for the fixed point sequences were proved in [LY97] and [RS02]. Recall from Equations 2.3 and 2.4 that

$$\{i(f^n, p)\}_{n \geq 1} = \sigma_1 - r\sigma_q \quad \text{and} \quad \{i(f^n, p)\}_{n \geq 1} = e\sigma_1 - r\sigma_2$$

for orientation-preserving and orientation-reversing homeomorphisms, respectively, and for some $e \in \{-1, 0, 1\}, r, q \geq 1$. The previous formulas exclude the trivial cases in which p is an attractor or a repeller, for which the index is 1 or -1 . An intuitive approach to the periodic patterns followed by the sequences has been given in Subsection 2.1.3 in

terms of the map φ , which codifies the behavior of the first homological Conley index as shown in Theorem 2.1.1. A common feature of the possible sequences is that the index is always ≤ 1 . Noteworthy, Bonino proved in [Bo02] that this inequality is true for orientation-reversing homeomorphisms even if we replace isolation as an invariant set by isolation in the set of fixed points.

The aim of this section is to generalize these previous results to continuous maps, where we find that the inequality

$$i(f, p) \leq 1$$

still holds provided that the point is not a repeller. There are two special cases which were already treated in Subsection 2.2.7, attractors and repellers, which in the plane are frequently called *sinks* and *sources*, respectively. We showed that the fixed point index for sinks is always 1 and that for sources the fixed point index sequence $\{i(f^n, p)\}_{n \geq 1}$ is a geometric progression whose ratio is equal to its starting value and can be any integer $d \neq 0$. For example, fix $d \neq 0$ and consider the map $f : \mathbb{C} \rightarrow \mathbb{C}$ defined by

$$f(z) = 2 \frac{z^d}{|z|^{d-1}}.$$

Trivially, the origin is a source whose index is d . It is not difficult to prove that, for any positive integer n , $i(f^n, 0) = d^n$.

The general case is addressed in the following theorem. It gives a characterization of the fixed point index sequence.

Theorem 2.3.1. *Let f be a local map of \mathbb{R}^2 and p a fixed point of f which is isolated as an invariant set and is neither a source nor a sink. Then,*

$$\{i(f^n, p)\}_{n \geq 1} = \sigma^1 - \sum_{k \in F} a_k \sigma^k$$

where F is a finite non-empty subset of \mathbb{N} and a_k is a positive integer for every $k \in F$.

Note that this is equivalent to the following statement:

There exists a map $\varphi : J \rightarrow J$ over a finite set J such that $i(f^n, p) = 1 - \#\text{Fix}(\varphi^n)$ for every positive integer n .

The map φ would be composed of a_k cycles of period k for every $k \in F$. The proof of Theorem 2.3.1 involves confining the local dynamics in a model for which the computation of fixed point indices is straightforward. As a corollary we obtain Theorem 2.4 in [GNR11], which is strictly weaker than our result.

Theorem 2.3.2 (Graff-Nowak-Przygodzki-Ruiz del Portal). *Under the hypothesis of Theorem 2.3.1:*

- For every $n \geq 1$, $i(f^n, p) \leq 1$.
- The sequence $\{i(f^n, p)\}_{n \geq 1}$ is periodic and contains infinitely-many non-positive terms.

Finally, let us emphasize that our result is only valid when the fixed point is isolated as an invariant set. Graff and Nowak-Przygodzki have proved in [GN03] that any sequence satisfying Dold's congruences is the fixed point sequence of a fixed point of a planar continuous map. Their example is far from fitting in our setting, as the fixed point is accumulated by periodic orbits provided the sequence is not periodic. It is still an open question whether analogous examples can be constructed such that the fixed point is isolated in $\text{Per}(f)$, i.e., as a periodic point.

2.3.2 Splitting and nilpotence arguments

Given two points $x, y \in S^2$, a *path* between x and y is the image of a continuous map $\phi : [0, 1] \rightarrow S^2$ such that $\phi(0) = x$ and $\phi(1) = y$. If ϕ is one-to-one, we will say that its image is a *Jordan arc*. In the case $\phi(0) = \phi(1)$ it will be called a *Jordan curve*.

The boundary of a 2-manifold with boundary $A \subset S^2$ is a 1-manifold, hence a disjoint union of Jordan curves. It is interesting to remark that if α is a Jordan arc or a Jordan curve contained in ∂A , the quotient space \hat{A} obtained from A by collapsing α to a point is homeomorphic to a 2-submanifold with (possibly empty) boundary of S^2 . If we collapse every Jordan curve in which the boundary of A is decomposed to a different point we obtain a set homeomorphic to the 2-sphere. Note also that, for every 2-manifold with boundary A in S^2 , the homology group $H_1(A)$ is generated by the 1-cycles represented by the connected components of ∂A .

Recall the notion of regularity defined for pair of spaces in Subsection 2.2.5. In this setting, a compact pair (B, A) , where $A \subset B$, of subsets of S^2 is a regular pair provided that A and $\overline{B \setminus A}$ are 2-manifolds with boundary and they intersect in a common submanifold of their boundaries composed of Jordan arcs and curves. Notice that this implies that B is also a 2-manifold with boundary.

A *hole* of a subset A of the sphere is a connected component of $S^2 \setminus A$, that is, an element of $\pi_0(S^2 \setminus A)$. Trivially, if $A \subset B$ are proper subsets of S^2 , the inclusion induces a natural map from the holes of B into the holes of A ,

$$\iota : \pi_0(S^2 \setminus B) \rightarrow \pi_0(S^2 \setminus A).$$

Evidently, this map induces a homomorphism between the reduced homology groups $\tilde{H}_0(S^2 \setminus B)$ and $\tilde{H}_0(S^2 \setminus A)$. If we assume that A and B are manifolds, it follows from Alexander duality that the dual of this homomorphism is the map $H_1(A) \rightarrow H_1(B)$ induced by inclusion. Thus, this map is surjective if and only if ι is injective, that is, no two holes of B are contained in the same hole of A . Holes can be replaced by arbitrary connected sets in part of the previous discussion. Let T_1 and T_2 be two disjoint connected subsets of S^2 . A set A is said to *separate* T_1 and T_2 if both sets are contained in different holes of A .

The idea of the proof of Theorem 2.3.1 is to split the local dynamics. The set we will use to make such a decomposition is the stable set. The connected components in which the stable set separates a small neighborhood of the fixed point essentially indicate the pieces of the exit set of the neighborhood. Let us include some results involving separation and dynamics.

Lemma 2.3.3. *Let $\{K_n\}_{n \geq 0}$, with $K_{n+1} \subset K_n$, be a nested sequence of compact subsets of S^2 and T_1 and T_2 two disjoint connected subsets of S^2 , none of which meets K_0 .*

Suppose $f : K_0 \rightarrow S^2$ is a continuous map such that $f(K_{n+1}) \subset K_n$ for every $n \geq 0$. Denote $\Lambda_n = \Lambda^+(f, K_n) = \bigcap_{l=0}^{\infty} f^{-l}(K_n)$ the stable set of f in K_n . For any $n \geq 0$, if Λ_n does not separate T_1 and T_2 there exists $m \geq n$ such that K_m does not separate T_1 and T_2 either.

Trivially, the previous lemma can be generalized to deal with finitely many sets T_i .

Corollary 2.3.4. *Assume that, in the conditions of the previous lemma, there is a finite family $T = \{T_1, \dots, T_k\}$ of disjoint connected subsets of S^2 , none of which meets K_0 . Then, there exists n such that every pair of sets of T is separated by K_n if and only if they are separated by $\Lambda_n = \Lambda^+(f, N)$.*

Proof. Take two elements $T_i, T_j \in T$. Consider an integer n_{ij} such that T_i, T_j are separated by $K_{n_{ij}}$ if and only if they are separated by K_n , for any $n \geq n_{ij}$. Then, by Lemma 2.3.3, Λ_n must separate T_i and T_j as well. Thus, if we take $n \geq n_{ij}$ for every pair $1 \leq i < j \leq k$, the conclusion follows. \square

Proof of Lemma 2.3.3. Suppose T_1 and T_2 are not separated by Λ_n . Let γ be a path disjoint to Λ_n which joins T_1 and T_2 . A compactness argument shows that every point of γ is eventually mapped outside K_n by one of the first m iterates of f , if m is large enough. Since $f^k(K_{n+m}) \subset K_n$ for any $0 \leq k \leq m$, the path γ cannot meet K_{n+m} , hence T_1 and T_2 are not separated by K_{n+m} . \square

The way in which the stable set separates its complement and the dynamics induced in its set of holes gives a combinatorial description of the dynamics which suffices to carry out fixed point index computations. This will be possible because the dynamics carried by the stable set is negligible, as the following lemma shows.

Lemma 2.3.5. *Let $X \subset \Lambda \subset S$ be compact subsets of the plane, S a 2-manifold with boundary which is a neighborhood of X , and let $f : S \rightarrow S$ be a continuous map such that Λ is positively invariant and X is a global attractor for the restricted dynamical system $(\Lambda, f|_{\Lambda})$. Assume further that,*

- *Every pair of holes of S is separated by Λ .*
- *X is cellular.*

Then, the map $f_{,1} : H_1(S) \rightarrow H_1(S)$ is nilpotent.*

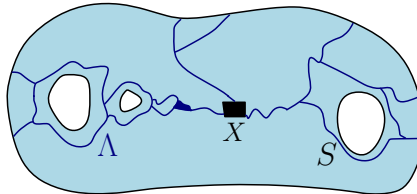

Figure 2.3: Proof of Lemma 2.3.5: All 4 (3 bounded and 1 unbounded) holes of S are separated by Λ .

Proof. Let $D \subset S$ be a closed topological disk which is a neighborhood of X . Take n so that $f^n(\Lambda) \subset D$ and consider a neighborhood U of Λ in S which is a 2-manifold with boundary also satisfies $f^n(U) \subset D$. We will show that $f_{*,1}^n : H_1(S) \rightarrow H_1(S)$ is the zero morphism.

Since U contains Λ , every pair of holes of S is separated by U as well. Consequently, the inclusion-induced map $H_1(U) \rightarrow H_1(S)$ is surjective. Fix a class $\alpha \in H_1(S)$, which is represented by a 1-chain σ contained in U . The homology class $f_*^n(\alpha)$ is represented by the 1-chain $f^n(\sigma)$, which is contained in $f^n(U) \subset D$. Since D is a disk in S , $f^n(\sigma)$ is a boundary in S . Therefore, $f_*^n(\alpha) = 0$. \square

Notice the similarity between the previous proof and Proposition 2.2.20, where X was an attracting fixed point and $\Lambda = S$ a positively invariant neighborhood.

2.3.3 Characterization of fixed point index sequences

Proof of Theorem 2.3.1. Let N be a 2-manifold with boundary which contains p in its interior and denote

$$\mathcal{L} = \{L : (N, L) \text{ is a regular filtration pair for } p \text{ and } f\}.$$

By Proposition 2.2.17, we can assume that the choice of N ensures $\mathcal{L} \neq \emptyset$. It is easy to check that \mathcal{L} is closed under union. Associate to every element $L \in \mathcal{L}$ an integer, r_L , that denotes the number of holes of S which contain holes of N , where S denotes the connected component of $\overline{N \setminus L}$ that contains p . Equivalently, r_L is the cardinal of the image of the map

$$\pi_0(S^2 \setminus N) \rightarrow \pi_0(S^2 \setminus S).$$

Take $L_0 \in \mathcal{L}$ such that $r := r_{L_0} = \min_{L \in \mathcal{L}} r_L$. Evidently, $L_0 \neq \emptyset$ because p is not a sink. Note that for any $L \in \mathcal{L}$ with $L_0 \subset L$ we have necessarily $r_L = r$.

The careful choice of L_0 is justified by the following lemma, which is a particular case of Lemma 2.5.5.

Lemma 2.3.6. *Suppose $J \in \mathcal{L}$ contains L_0 and denote T (resp. S_0) the connected component of $\overline{N \setminus J}$ (resp. $\overline{N \setminus L_0}$) which contains p . Then, any $C \in \pi_0(\overline{S_0 \setminus T})$ contains exactly one connected component of $\partial_N T$.*

Proof. Since S_0 is connected and contains T it is immediate to check that $\partial_N T$ meets C . Suppose there are two different components $\lambda, \lambda' \in \pi_0(\partial_N T)$ contained in C . Observe that none of them can be a Jordan curve because T is connected. Consequently, λ and λ' are Jordan arcs. Take a path in T joining λ and λ' and extend it to a Jordan curve $\gamma \subset T \cup C$, which we can assume only meets λ and λ' in one point each and not any of their end points. Since any end point of a Jordan arc in $\pi_0(\partial_N T)$ belongs to the adherence of a hole of N , one deduces that there exist holes H, H' of N which lie in different components of $S^2 \setminus \gamma$. Assume each of the adherences of H and H' contains one end points of λ . As $\gamma \subset S_0$, H and H' are separated by S_0 and, in particular, $H \neq H'$. However, it is clear that it is possible to connect H and H' by a path, close to the arc λ , which does not meet T . Thus, H and H' are not separated by T and we deduce that $r_J < r_{L_0}$, which contradicts the definition of L_0 . \square

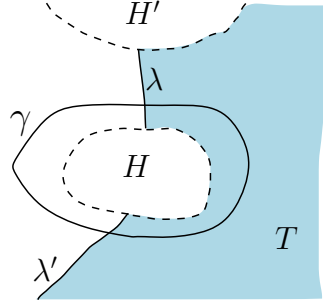

Figure 2.4: Proof of Lemma 2.3.6.

The compact set $L'_1 = (f^{-1}(L_0) \cap N) \cup L_0$ is a neighborhood of L_0 in N such that

$$f(L'_1) \cap \overline{(N \setminus L'_1)} \subset (L_0 \cap \overline{(N \setminus L'_1)}) \cup (f(L_0) \cap \overline{(N \setminus L'_1)}) = \emptyset$$

and also that $\overline{N \setminus L'_1}$ is an isolating neighborhood of p . Therefore, we can find a neighborhood L_1 of L'_1 in N such that

- (N, L_1) is a regular pair,
- $\overline{N \setminus L_1}$ is an isolating neighborhood of p ,
- $f(L_1) \cap \overline{(N \setminus L_1)} = \emptyset$,
- $f(\overline{N \setminus L_1}) \subset N \setminus L_0$,

In particular, (N, L_1) is a regular filtration pair. With the same process, we can define inductively a sequence (N, L_n) of regular filtration pairs of p , such that

- L_{n+1} is a neighborhood of $(f^{-1}(L_n) \cap N) \cup L_n$ in N ,
- $f(\overline{N \setminus L_{n+1}}) \subset N \setminus L_n$.

Denote S_n the connected component of $\overline{N \setminus L_n}$ that contains p . Of course, one has that $f(S_{n+1}) \subset S_n$ for any $n \geq 0$. Indeed, $f(S_{n+1})$ is connected, contains p and does not meet L_n . It is trivial to check that each pair (N, S_n) is regular. From the definition of L_0 we deduce that the sets S_n satisfies the following essential property: for any $n \geq 0$, in the diagram below, the map ι restricted to the image of ι_0 is one-to-one.

$$\pi_0(S^2 \setminus N) \xrightarrow{\iota_0} \pi_0(S^2 \setminus S_0) \xrightarrow{\iota} \pi_0(S^2 \setminus S_n)$$

Apply Corollary 2.3.4 to the nested sequence of compact sets $\{S_n\}_{n \geq 0}$ and the finite set of holes of N . We obtain a positive integer $m \geq 1$ such that every pair of holes of N is separated by S_m if and only if it is separated by $\Lambda^+(f, S_m)$. Set $S = S_m$ and $\Lambda = \Lambda^+(f, S_m)$.

It is possible to encapsulate the local dynamics in N as we did in the proof of Proposition 2.2.22. Define a map $\Phi : \overline{S_0 \setminus S} \rightarrow \pi_0(\partial_N S)$ which sends each point x , that belongs to a connected component C of $\overline{S_0 \setminus S}$, to the unique connected component of $\partial_N S$ which is contained in C . The map Φ is well-defined by Lemma 2.3.6.

Consider the quotient space \widehat{S} obtained by collapsing each connected component of $\partial_N S$, λ , to a different point q_λ . The map f induces a continuous map $\widehat{f} : \widehat{S} \rightarrow \widehat{S}$, defined as follows. Denote $\pi : S \rightarrow \widehat{S}$ the projection map. Note that $f(\partial_N S) \cap S = \emptyset$. Then, for a point $x \in S \setminus \partial_N S$, if $f(x) \in S \setminus \partial_N S$ then $\widehat{f}(\pi(x)) := \pi(f(x))$ and, otherwise, $\widehat{f}(x) = q_\lambda$ provided that $\lambda = \Phi(f(x))$. Finally, $\widehat{f}(q_\lambda) := q_{\lambda'}$ if for any $x \in \lambda$, $\Phi(f(x)) = \lambda'$. Note that \widehat{f} is locally constant around each point q_λ , $\lambda \in \pi_0(\partial_N S)$, and, more precisely, it is locally constant in $\pi(S \cap f^{-1}(N \setminus S))$. It follows that \widehat{f} is continuous.

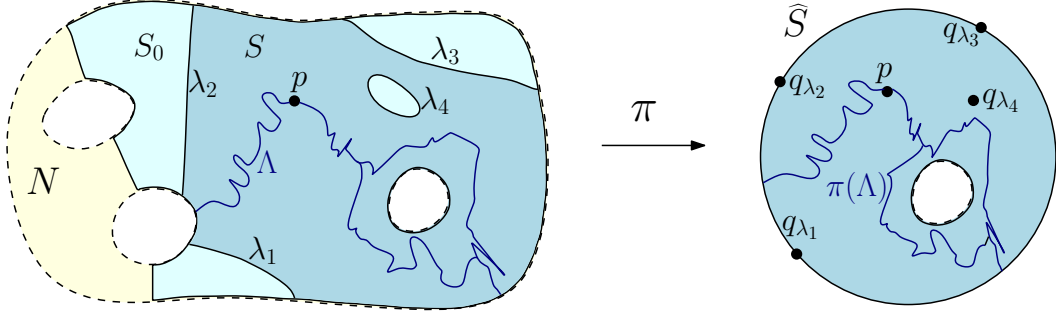

Figure 2.5: Proof of Theorem 2.3.1.

The compact set \widehat{S} is a 2-manifold with boundary and it is not difficult to see that $H_2(\widehat{S})$ is trivial unless every connected component of $\partial_N S$ is a Jordan curve. In this case, $f(S) \supset S$ and p is a repeller, contrary to our hypothesis.

In order to compute the Lefschetz numbers of the maps $(\widehat{f})^n : \widehat{S} \rightarrow \widehat{S}$ we just need to describe its induced action in the first homology groups. The compact set Λ does not meet $\partial_N S$, hence $\pi(\Lambda) \approx \Lambda$ and it is nothing but the stable set $\Lambda^+(\widehat{f}, \pi(p))$.

The boundary of each hole of S represents a 1-cycle of the group $H_1(S)$. This set of cycles generates $H_1(S)$. Similarly, the group $H_1(\widehat{S})$ is generated by the 1-cycles represented by the boundaries of the holes of \widehat{S} . It is easy to check that each hole of \widehat{S} is associated to a unique hole of S whose boundary is not completely contained in $\partial_N S$, hence it must contain at least one hole of N . Since Λ separates the holes of N , we deduce that $\pi(\Lambda)$ separates every pair of holes of \widehat{S} .

Lemma 2.3.5 then yields that the map $\widehat{f}_{*,1} : H_1(\widehat{S}) \rightarrow H_1(\widehat{S})$ is nilpotent, so the trace of $(\widehat{f})_{*,1}^n$ is 0 for any $n \geq 1$. Thus, the Lefschetz number of $(\widehat{f})^n$ is equal to 1 and by Lefschetz Theorem we conclude that

$$i((\widehat{f})^n, \widehat{S}) = 1.$$

The invariant set of \widehat{f} is contained in the set $\{\pi(p)\} \cup \{q_\lambda\}_{\lambda \in \pi_0(\partial_N S)}$. Denote φ the restriction of \widehat{f} to $\{q_\lambda\}_{\lambda \in \pi_0(\partial_N S)}$. If q_λ is a fixed point for $(\widehat{f})^n$ then $i((\widehat{f})^n, q_\lambda) = 1$ because \widehat{f} is locally constant at q_λ . Note additionally that, since \widehat{f} and f are conjugate in a neighborhood $\pi(p)$ and p , respectively, we have $i((\widehat{f})^n, \pi(p)) = i(f^n, p)$. Therefore,

$$1 = i((\widehat{f})^n, \widehat{S}) = i((\widehat{f})^n, \pi(p)) + \sum_{q_\lambda \in \text{Fix}(\varphi^n)} i((\widehat{f})^n, q_\lambda) = i(f^n, p) + \#\text{Fix}(\varphi^n).$$

If we denote a_k the number of k -periodic orbits of φ and $F = \{k \in \mathbb{N} : a_k \geq 1\}$, we

obtain the desired formula,

$$\{i(f^n, p)\}_{n \geq 1} = \sigma^1 - \sum_{k \in F} a_k \sigma^k.$$

□

2.3.4 Realization of all possible sequences

In this subsection we construct examples which realize all possible fixed point index sequences obtained in Theorem 2.3.1.

Let F be a finite subset of the positive integers and let a_k be a positive integer for every $k \in F$. Consider a continuous map $h : S^1 \rightarrow S^1$ with exactly a_k attracting periodic orbits of period k for every $k \in F$. Denote P the set of points belonging to these orbits. Notice that there is no obstruction in the definition of the map h as we are only asking for continuity. Take a compact neighborhood $V \subset S^1$ of P such that $h(V) \subset \text{int}(V)$ and $\text{Inv}(h, V) = P$.

Let $g : S^1 \rightarrow \mathbb{R}$ be a continuous map such that

$$g(\theta) \geq 0 \Leftrightarrow \theta \in V$$

and $g(\theta) > 0$ in $\text{int}(V)$. Consider the cylinder $S^1 \times \mathbb{R}$. Compactify the end of the lower semi-cylinder $S^1 \times (-\infty, 0]$ with the point $\{e^-\}$. We obtain a closed topological disk, which will be denoted D_0 . Similarly, we define disks D_r for any r . Let $s : S^1 \times \mathbb{R} \rightarrow S^1 \times \mathbb{R}$ be defined by $s(\theta, r) = (\theta, 0)$ if $r \geq 0$ and $s(\theta, r) = (\theta, r)$ otherwise. Clearly, it is a retraction from the cylinder onto D_0 . Define $f : S^1 \times \mathbb{R} \rightarrow S^1 \times \mathbb{R}$ by

$$f((\theta, r)) = s(h(\theta), r + g(\theta)).$$

Fixing the lower end e^- we obtain a continuous extension of f to $S^1 \times \mathbb{R} \cup \{e^-\}$.

For every $r \leq 0$, the disk D_r is an isolating block because the following property is satisfied:

$$g(\theta) \geq 0 \Rightarrow g(h(\theta)) > 0.$$

By a compactness argument, it implies that, for some $\varepsilon > 0$,

$$g(\theta) \geq -\varepsilon \Rightarrow g(h(\theta)) \geq \varepsilon.$$

Therefore, for any point $x \in D_0$ either $f^n(x)$ tends to e^- as $n \rightarrow +\infty$ or $f^n(x)$ eventually belongs to $\partial D_0 = S^1 \times \{0\}$. The same conclusion trivially holds for any point x in the upper semi-cylinder. We deduce that $\text{Inv}(S^1 \times \mathbb{R} \cup \{e^-\}, f)$ is composed of a fixed point, e^- , and the set $P \times \{0\}$ of attracting periodic orbits in ∂D_0 .

The computation of the fixed point index of the point e^- is now straightforward. Take D_1 as the ambient space for the computation, it satisfies $f(D_1) \subset D_1$ and, clearly, $\text{Inv}(D_1, f) = \{e^-\} \cup (P \times \{0\})$. The Lefschetz number of the map $f|_{D_1}^n : D_1 \rightarrow D_1$ is 1 because D_1 is a disk. Consequently, the total sum of the local fixed point indices of the map $f|_{D_1}^n$ is equal to 1. A point $\theta \in P$ is fixed by h^n if and only if $(\theta, 0)$ is fixed by f^n . Additionally, a fixed point for the map f^n of the form $(\theta, 0)$ is attracting

because g is strictly positive in a neighborhood of θ , so its fixed point index is equal to 1. Consequently, we have

$$i(f^n, e^-) = 1 - \sum_{h^n(\theta)=\theta \in P} i(f^n, (\theta, 0)) = 1 - \sum_{k|n} k \cdot a_k$$

which evidently implies

$$\{i(f^n, e^-)\}_{n \geq 1} = \sigma^1 - \sum_{k \in F} a_k \sigma^k.$$

The previous construction is similar to the one carried out in Theorem 3.1 in [BB92]. The result from Babenko and Bogatyi shows that any sequence $\{\sum_{k \geq 1} a_k \sigma^k$ with $a_1 \leq 1$ and $a_k \leq 0$, for $k \geq 2$, is realized as the fixed point index sequence of a fixed point of a continuous planar map. They only assume isolation in $\text{Fix}(f^n)$, for every $n \geq 0$, so that the sequence is well-defined. However, in their example, if there is only a finite number of non-zero coefficients a_k the fixed point is isolated as an invariant set.

2.4 Some questions around discrete Conley index theory

2.4.1 Around the definition

This subsection presents a brief account on the different definitions of the Conley index in the literature. Special emphasis will be put on the compact pairs used by the authors to encapsulate the local dynamics. So far, in this work we have followed Franks and Richeson’s article [FR00] to define the index. Filtration pairs, see Definition 2.2.16, are the basic pieces which isolate the invariant set. Discrete Conley index is defined as the shift equivalent class of the maps $\bar{f} : N/L \rightarrow N/L$ induced in any filtration pair (N, L) . This invariant is more general than the ones obtained in the first articles which undertook the task of carrying Conley’s work from the continuous to the discrete setting. Throughout this subsection we will only require f to be a continuous map and X an isolated invariant set. All the results should work for locally compact metric spaces.

Mrozek, [Mr90], and Robbin and Salamon, [RS88], were the first authors which defined the discrete Conley index. In both articles local dynamics is encapsulated by index pairs, but their definitions of index pair are different. However, their definitions agree in two basic features: the pair (N, L) is used to isolate the invariant set and the map f induces a map, the index map, in the quotient space N/L . Mrozek proved that the Leray reduction of the map induced by the index map in the cohomology groups $H^r(N/L)$ is invariant, giving rise to the so-called cohomological Conley index. Robbin and Salamon approach uses shape theory. They showed that the shape of the inverse limit of the inverse sequence generated by the index map $\bar{f} : N/L \rightarrow N/L$ only depends on X and f . They called their invariant shape index.

Later, Mrozek managed to merge both indices into one and then Szymczak generalized this index using a categorical approach. Szymczak’s article, [Sz95], defines the discrete Conley index as an isomorphism class in a certain category. Franks and Richeson [FR00] proved that isomorphism classes coincide with shift equivalence classes in Szymczak’s category. Consequently, Szymczak’s approach is equivalent to the one we have described

in this work and both are more general than the original indices described in [Mr90, RS88]. It is worth noting that the compact pairs used by Szymczak to encapsulate the dynamics are virtually equivalent to the ones Mrozek introduced in [Mr90], which we will call Mrozek index pairs or simply index pairs.

The compact pairs used by Robbin and Salamon in their article [RS88] are the most general ones among the pairs used to define the Conley index. We will refer to them as *weak index pairs*. They satisfy:

(1) $\overline{N \setminus L}$ is an isolating neighborhood of X .

- f induces an continuous map $\bar{f} : N/L \rightarrow N/L$, called index map, defined

$$\bar{f}(x) = \begin{cases} \pi(f(x)) & \text{if } x \in N \setminus L \text{ and } f(x) \in N \\ [L] & \text{otherwise} \end{cases} \quad (2.8)$$

where $\pi : N \rightarrow N/L$ is the projection map and we have identified $N \setminus L \sim N/L - [L]$.

These properties are the weakest ones required for a pair to take part in Conley index theory, as it must isolate the invariant set and also induce some map in the quotient which encapsulates the local dynamics around X . In order to be more precise, we include Theorem 4.3 in [RS88] which states the necessary and sufficient conditions for a pair (N, L) and a map f to induce an index map \bar{f} in N/L .

Lemma 2.4.1 (Robbin-Salamon). *Let (N, L) be a compact pair. The map $\bar{f} : N/L \rightarrow N/L$ defined by (2.8) is continuous if and only if:*

(2b) *Every $x \in N \setminus L$ with $f(x) \in \partial N \setminus L$ has a neighborhood B with $f(B \cap (N \setminus L)) \subset N$.*

(3b) *Every $x \in L$ such that $f(x) \in N \setminus L$ has a neighborhood A with $f(A \cap (N \setminus L)) \cap N = \emptyset$.*

Mrozek index pairs are much closer to filtration pairs than to weak index pairs.

Definition 2.4.2. *A compact pair (N, L) is a Mrozek index pair, or just index pair provided*

(1) $\overline{N \setminus L}$ is an isolating neighborhood of X ,

(2a) $f(\overline{N \setminus L}) \subset N$,

(3a) $f(L) \cap N \subset L$.

Note that every Mrozek index pair is a weak index pair because (2a) \Rightarrow (2b) and (3a) \Rightarrow (3b). Let us recall the definition of filtration pair from Subsection 2.2.5.

Definition 2.4.3. *A compact pair (N, L) is a filtration pair provided both N and L are the closure of their interiors,*

(1) $\overline{N \setminus L}$ is an isolating neighborhood of X ,

(2) $f(\overline{N \setminus L}) \subset \text{int}(N)$,

(3) $f(L) \cap N \subset \text{int}_N(L)$.

Since (2) \Rightarrow (2a) and (3) \Rightarrow (3a) we obtain that a filtration pair is an index pair and, in particular, a weak index pair. The following example shows that these three type of pairs are different.

Example 2.4.4. Fix $d = 2$ and $k = 1$ in Example 2.2.18 and take $A = \begin{pmatrix} 2 & 0 \\ 0 & \frac{1}{2} \end{pmatrix}$. The origin is an isolated fixed point which is trivially hyperbolic. Denote $N = [-1, 1]^2$ and $L = L_{\frac{1}{3}}^-$. The pair (N, L) is a regular filtration pair. Now define $J_1 = [\frac{1}{6}, \frac{1}{3}] \times [0, 1]$. Evidently, $f(J_1) \subset L$ and it follows that $(N, L \cup J_1)$ is a Mrozek index pair. However, the point $(\frac{1}{3}, 0) \in f(J_1)$ belongs to the relative boundary of $L \cup J_1$ in N . Thus, (3) does not hold and $(N, L \cup J_1)$ is not a filtration pair. See Figure 2.6.

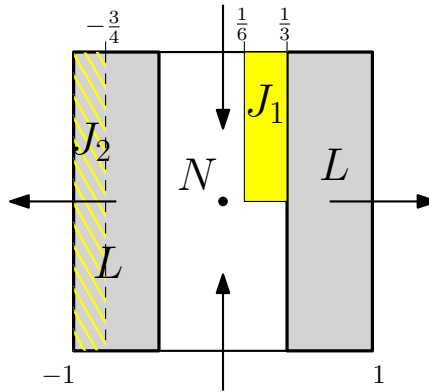

Figure 2.6: weak index pairs, Mrozek index pairs and filtration pairs are different.

Consider $J_2 = [-1, -\frac{3}{4}] \times [-1, 1]$. Clearly, $f(J_2) \cap N = \emptyset$ and it is easy to check that $(N, (L \cup J_1) \setminus J_2)$ is a weak index pair. However, $f(L) \cap J_2 \neq \emptyset$ so (3a) does not hold and it is not a Mrozek index pair.

Note that the differences between filtration and index pairs lie in the behavior of the maps in the boundaries of the sets and also in the regularity required for the pair. This gap prevents index pairs to be stable under perturbations. On the other hand, since (1), (2) and (3) are open conditions, if we drop the assumption on the regularity of the sets, filtration pairs are stable under perturbations.

Lemma 2.4.5. For any filtration pair (N, L) for X and f there exists $\varepsilon > 0$ such that for any compact pair (N', L') with N' and L' , equal to the closure of their interiors, and any map f' such that

$$d_H(N', N) < \varepsilon, \quad d_H(L', L) < \varepsilon, \quad \|f' - f\|_\infty < \varepsilon,$$

where d_H denotes the Hausdorff distance and $\|\cdot\|_\infty$ the supremum norm, the pair (N', L') is a filtration pair for f' .

Additionally, if $f' = f$ the index maps associated to both filtration pairs are shift equivalent.

Proof. The first part of the lemma is a consequence of the previous discussion. It suffices to notice that if ε is small enough

$$f'(\overline{N' \setminus L'}) \cup f(\overline{N \setminus L}) \subset \text{int}(N) \cap \text{int}(N'), \quad (f'(L') \cup f(L)) \cap ((\overline{N' \setminus L'}) \cup (\overline{N \setminus L})) = \emptyset,$$

and also $\text{Inv}(f', N') \subset \overline{N' \setminus L'}$.

For the second part note that the previous relations imply f induces well-defined continuous maps $r : N/L \rightarrow N'/L'$ and $s : N'/L' \rightarrow N/L$. If $\pi' : N' \rightarrow N'/L'$ denotes the projection, $r(x) = \pi'(f(x))$ for any $x \in N \setminus L \sim N/L - [L]$ and $r(x) = [L']$ otherwise. The definition of s is analogous. It is now easy to check that $s \circ r = (\bar{f})^2 : N/L \rightarrow N/L$ and $r \circ s = (\bar{f}')^2 : N'/L' \rightarrow N'/L'$, where \bar{f} and \bar{f}' are the index maps associated to each filtration pair. \square

The final part of this subsection is devoted to establish a direct link between index pairs and filtration pairs via shift equivalence. We present a procedure which naturally modifies a given index pair to obtain a filtration pair. The former and latter index maps will be shift equivalent, hence we could have chosen to work with index pairs instead of with filtration pairs to introduce Conley index. The task involves a careful modification of the subsets of the boundary over which f does not behave properly. We need a technical lemma which sorts out problems with internal tangencies. A compact set A presents an interior tangency if

$$f^{-1}(A) \cap \partial A \cap f(A) \neq \emptyset$$

or, equivalently, if there exists $x \in A$ such that $f(x) \in \partial A$ and $f^2(x) \in A$. Recall from Subsection 2.2.5 that an isolating neighborhood without internal tangencies is called isolating block. The procedure consists in pasting bubbles exactly where internal tangencies are taking place.

In order to avoid tangencies we paste bubbles in the pieces of the boundary of A which present tangencies so that the points $f(x)$ are contained in the interior of the bubbles.

Lemma 2.4.6. *Let (B, A) be a compact pair included in the domain of definition of f such that $\text{Inv}(\partial_B A) = \emptyset$ and $f(\partial_B A) \subset A$. Then, there exists $n := \nu(A)$ such that $\bigcap_{k=0}^n f^{-k}(\partial_B A) \neq \emptyset$ and $\bigcap_{k=0}^m f^{-k}(\partial_B A) = \emptyset$ for every $m > n$. Furthermore, for every open neighborhood V of $\partial_B A$ in B we can find a subset A^* of B which contains A and satisfies*

(i) $A^* \subset A \cup V$, $f(\partial_B A^*) \subset \text{int}(A^*)$ and

(ii) there exists $l \geq 1$ so that, for every point $x \in A^* \setminus A$, $f^j(x) \in A$ for some $0 \leq j \leq l$.

In addition, if $f(A) \cap B \subset A$ then A^* can be chosen to satisfy $f(A^*) \cap B \subset \text{int}_B(A^*)$.

Proof. Given an integer $m \geq 0$, let $a_m = \bigcap_{k=0}^m f^{-k}(\partial_B A)$. It is easy to check that $f(a_{m+1}) \subset a_m$ for every $m \geq 0$. Suppose that $K = \bigcap_{k \geq 0} f^{-k}(\partial_B A) = \bigcap_{m \geq 0} a_m \neq \emptyset$. Then, $f(K) \subset K$ and $\omega(K) = \bigcap_{j \geq 0} f^j(K)$ would be a non-empty invariant subset of $\partial_B A$. Thus $K = \emptyset$, hence there exists $n = \nu(A)$ such that $a_n \neq \emptyset$ and $a_{n+1} = \emptyset$.

The proof of the second part of the lemma uses an induction argument. For any compact set $A \subset A' \subset A \cup V$, denote $\nu(A')$ the greatest positive integer n such that $a'_n = \bigcap_{k=0}^n f^{-k}(\partial_B A') \neq \emptyset$. We assert that given such A' it is possible to find $A'' \subset A' \subset A \cup V$ with $\nu(A'') \leq \nu(A') - 1$. Moreover, if A' satisfies (ii) then A'' will also satisfy (ii). Thus, starting with A and iterating this process at most $\nu(A)$ times we obtain a compact set A^* such that $A \subset A^* \subset A \cup V$ and $\nu(A^*) = 0$, hence $f(\partial_B A^*) \subset \text{int}_B(A^*)$, and which satisfies property (ii) because, trivially, so does A .

Let us prove the assertion in the previous paragraph. Denote $n = \nu(A')$ and consider the compact sets $\{f^m(a'_n)\}_{m=0}^n$. Each $f^m(a'_n)$ lies in $a'_{n-m} \setminus a'_{n-m+1}$ so the sets $\{f^m(a'_n)\}_{m=0}^n$ are pairwise disjoint and, additionally, $f(f^n(a'_n)) \subset \text{int}_B(A')$. Thus, for each $0 \leq m \leq n$ we can find a compact neighborhood W_{n-m} of $f^m(a'_n)$ relative to B and contained in V such that

- $f(W_{m+1}) \subset \text{int}_B(W_m)$ for every $0 \leq m < n$ and
- $f(W_0) \subset \text{int}_B(A')$.

See Figure 2.7 for an illustration.

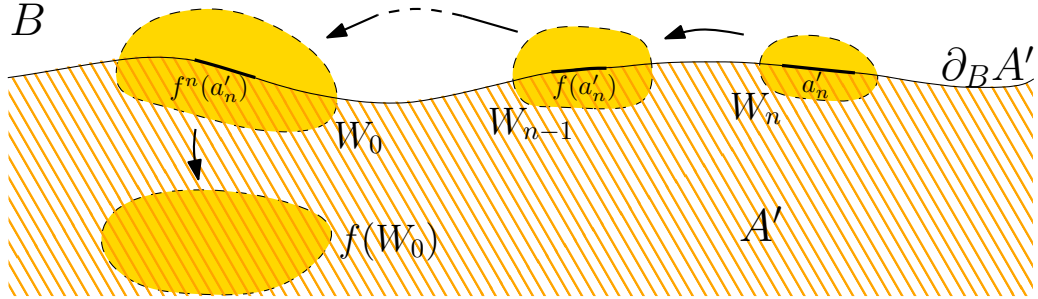

Figure 2.7: Proof of Lemma 2.4.6.

Denote $W = \bigcup_{m=0}^n W_m$. The set $A'' := A' \cup W$ is compact and lies in $A \cup V$. Its relative boundary in B , $\partial_B A''$ is contained in $\partial_B A' \cup \partial W$. Since $f(W) \subset \text{int}_B(W) \cup \text{int}_B(A')$, we get that $a''_m = \bigcap_{k=0}^m f^{-k}(\partial_B A'')$ is a subset of a'_m for every $m \geq 1$. Moreover, $a'_n \subset \text{int}_B(W)$ implies that $a''_n = \emptyset$ and $\nu(A'') < n$ as desired. Note also that for every point $x \in W_m$, $f^{m+1}(x)$ belongs to $\text{int}_B(A')$ and it follows that if A' satisfies (ii) so does A'' .

In the case A is positively invariant in B , that is $f(A) \cap B \subset A$, the inductive step ensures that we obtain in the end $f(A^*) \cap B \subset A^*$. Moreover, we already know that $f(\partial_B A^*) \subset \text{int}_B(A^*)$. It may happen that $f(\text{int}_B(A^*)) \cap \partial_B A^* \neq \emptyset$, but in order to solve this issue it is sufficient to slightly thicken the compact set A^* within its neighborhood $A \cup V$ in B so that we obtain

$$f(A^*) \cap B \subset \text{int}_B(A^*).$$

□

Property (ii) of the previous lemma is important to understand why the modification of the pair (B, A) goes along well with shift equivalence. The procedure explained in Lemma 2.4.6 allows to modify an index pair into a filtration pair while leaving invariant the shift equivalence class of the induced map.

Lemma 2.4.7. *Let $A \subset A'$ compact sets positively invariant by f . Assume that for every $x \in A'$ there exists $m \in \mathbb{N}$ such that $f^m(x) \in A$. Then $f|_A$ and $f|_{A'}$ are shift equivalent.*

Proof. Take m so that $f^m(x) \in A$ holds for every $x \in A'$. If r denotes the map induced by the inclusion $A \subset A'$ and $s = f^m : A' \rightarrow A$ then it is very easy to check that r and s define a shift equivalence between the two maps. □

Lemma 2.4.8. *Let (B, A) and (B, A') two compact pairs such that f induces self-maps $\bar{f} : B/A \rightarrow B/A$ and $\bar{f}' : B/A' \rightarrow B/A'$ and the following property is satisfied:*

- $A \subset A'$ and for any $x \in A'$ there exists $m \geq 0$ such that $f^k(x) \in B$ for every $0 \leq k \leq m$ and $f^m(x) \in \text{int}_B(A)$.

Then, the maps \bar{f} and \bar{f}' are shift equivalent.

Proof. Since A' is compact, the set $\{m = m(x)\}_{x \in A'}$ as in the previous lemma is bounded and denote l its upper bound. Denote $r : B/A' \rightarrow B/A$ the map induced by inclusion and define $s : B/A' \rightarrow B/A$ by $s([A']) = [A]$, $s(x) = [A]$ if one of the first l forward images of x belongs to A and put $s(x) = \pi(f^l(x))$ otherwise, where $\pi : B \rightarrow B/A$ is the projection map.

Let us show that the maps r and s define a shift equivalence between \bar{f} and \bar{f}' . The continuity of r is trivial and the continuity of s follows from the definition of l . One may check also that $r \circ \bar{f} = \bar{f}' \circ r$ and $s \circ \bar{f}' = \bar{f} \circ s$. Finally, the compositions $r \circ s = (\bar{f}')^l$ and $s \circ r = (\bar{f})^l$. \square

Note that if a point of A' is eventually mapped into A by f and hypothesis from Lemma 2.4.6 hold, $\text{Inv}(\partial_B A) = \emptyset$ and $f(\partial_B A) \subset A$, then we automatically deduce that the point eventually enters $\text{int}_B(A)$.

Now, we are in position to prove that the shift equivalence class of an index map associated to an index pair is exactly the discrete Conley index.

Proposition 2.4.9. *The index map associated to an index pair is shift equivalent to the index map associated to some filtration pair.*

Proof. Let (N_0, L_0) be an index pair and f_0 its associated index map. The plan of the proof is to modify several pieces of the boundary of N_0 and L_0 where the pair may fail to be a filtration pair. The sets subject to modification, in the order we will deal with them, are: $\partial_{N_0} L_0, \partial N_0 \cap (\overline{N_0} \setminus \overline{L_0}), \partial N_0 \cap L_0$. The outcome of each step will still be an index pair that additionally satisfies some extra hypothesis.

First step: Choose a neighborhood of L_0 in N_0 which does not meet X and apply Lemma 2.4.6 to the pair (N_0, L_0) in order to obtain a pair (N_0, L_1) such that $f(\partial_{N_0} L_1) \subset L_1 \setminus \partial_{N_0} L_1 = \text{int}_{N_0} L_1$. The pair (N_0, L_1) is an index pair which satisfies (3) and its associated map f_1 is shift equivalent to f_0 by Lemma 2.4.8.

Second step: Let M be a compact neighborhood of N_0 and J a compact neighborhood of $\partial N_0 \cap \partial L_1$ in the relative topology of $M \setminus N_0$. It is not difficult to see that the boundary of N_0 relative to the set $\overline{M \setminus J}$ is contained in $\lambda = \partial N_0 \cap (\overline{N_0} \setminus \overline{L_1})$. Moreover, if J is small enough, $f(J \cap \lambda)$ does not meet $\overline{N_0} \setminus \overline{L_1}$, so $\lambda \cap f^{-1}(\lambda) \subset \partial_{(\overline{M \setminus J})} N_0$. Apply Lemma 2.4.6 to $(\overline{M \setminus J}, N_0)$. The result is a compact neighborhood N_1 of N_0 . Furthermore, in a neighborhood V of L_1 there has not been any modification, that is $N_1 \cap V = N_0 \cap V$, so $\partial_{N_1} L_1 = \partial_{N_0} L_1$. The pair (N_1, L_1) is an index pair which satisfies

$$f(\partial_{N_1} L_1) \cap (\overline{N_1} \setminus \overline{L_1}) = \emptyset \quad \text{and} \quad f(\overline{N_1} \setminus \overline{L_1}) \subset \text{int}(N_1) \cup L_1.$$

Lemma 2.4.7 applied to $N_0/L_1 \subset N_1/L_1$ shows that the shift equivalence class of the index map is invariant.

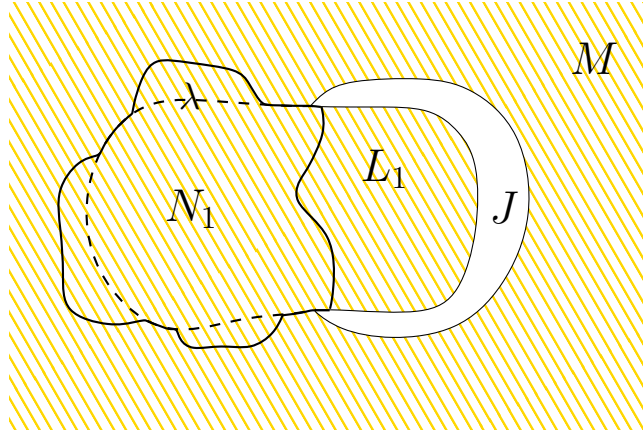

Figure 2.8: Step 2 of Lemma 2.4.9. N_0 is marked by a dashed line.

Third step: Add a small compact neighborhood of $\partial N_1 \cap \partial L_1$ to L_1 and denote L_2 the result. Note that can assume that $L_2 \cap N_1 = L_1$. Denote $N_2 = N_1 \cup L_2$. The pair (N_2, L_2) now satisfies (1), (2) and (3) and, since $N_2/L_2 = N_1/L_1$, the associated index map is unchanged.

Finally, perturb slightly the pair (N_2, L_2) to obtain a pair (N_3, L_3) so that each of the sets is equal to the closure of its interior and still satisfies properties (1), (2) and (3). The pair (N_3, L_3) is the desired filtration pair because the associated index maps are shift equivalent in view of Lemma 2.4.5. \square

2.4.2 Another approach to the discrete Conley index

In this subsection, we present another possible approach to discrete Conley index which makes a closer geometrical connection with the continuous-time case. Charles Conley originally introduced the index as a topological invariant valid for flows, see [Co78]. One can define the notions of isolated compact invariant set X and isolating block N of a flow in a similar way it was defined in the discrete case. The exit set l^- of a given isolating block N for X is a closed subset of the boundary of N . The continuous Conley index of X is the homotopy class of the pointed space $(N/l^-, [l^-])$, which does not depend on the choice of N and l^- but only in the local dynamics of the flow around X . Usually, the continuous Conley index is defined using index pairs, which are more general than the pairs (N, l^-) we introduced as, for instance, they do not require the second set to be contained in the boundary of the first one.

Discrete Conley index has been introduced in this article using filtration pairs (N, L) , a notion slightly less general than that of index pairs, for the discrete case, which is widespread in the literature. However, in any case, the exit set of the isolating neighborhood N is contained in L and, consequently, L is not contained in ∂N except for highly degenerate cases. We present below a way of computing discrete Conley index using pairs (N, l) satisfying $l \subset \partial N$. Additionally, the use of isolating blocks will allow us to compute the indices of a homeomorphism and its inverse with the same isolating neighborhood.

Let X be an isolated invariant set of a local homeomorphism f . Take an isolating

block N for X which is a manifold with boundary. Then,

$$U^- = \{x \in N \mid f(x) \notin N\}, \quad U^+ = \{x \in N \mid f^{-1}(x) \notin N\}$$

are open subsets of N whose union covers ∂N . Thus, there exists a regular decomposition (l^-, l^+) of ∂N such that $l^- \subset U^-$ and $l^+ \subset U^+$.

Lemma 2.4.10. *(N, l^-) is a weak index pair for f and (N, l^+) is a weak index pair for f^{-1} .*

Proof. We only include a proof for the first pair, for the second pair the proof is analogous. Clearly, $\overline{N \setminus l^-} = N$ is an isolating neighborhood of X . Recall from Lemma 2.4.1 and Equation 2.8 that we only need to show that (N, l^-) satisfies properties (2b) and (3b) for the map f . A point $x \in \partial N \cap f(N)$ must lie in l^- so (2b) is trivially satisfied. It follows from $f(l^-) \cap N = \emptyset$ that (3b) holds as well. \square

There are continuous basepoint preserving maps

$$f^- : N/l^- \rightarrow N/l^- \quad \text{and} \quad f^+ : N/l^+ \rightarrow N/l^+$$

induced by f and f^{-1} , respectively. A triple (N, l^-, l^+) as defined will be called *filtration triple*. Our task is now to show that the discrete Conley index can be extracted from this framework. Later, in Subsection 2.4.4, the symmetry between f and f^{-1} will permit us to give a proof of a duality theorem originally due to Szymczak (see [Sz98]). Consider a compact set L such that (N, L) is a filtration pair, and let \bar{f} be the induced map in N/L .

Proposition 2.4.11. *The maps \bar{f} and f^- are shift equivalent. Similarly, $\overline{f^{-1}}$ and f^+ are shift equivalent.*

Proof. The same argument works for both statements, we will just write it for \bar{f} and f^- .

There exists an integer $n \geq 1$ so that, for every $x \in L$, one of the first n forward images of x by f does not lie in N . The complementary U of $\bigcap_{k=0}^n f^{-k}(N)$ in N is composed of the points $x \in N$ such that $f^k(x) \notin N$ for some $1 \leq k \leq n$ and so contains L . Denote π_{l^-} and π_L the projections of N onto N/l^- and N/L respectively. The map, from N to N/l^- , that sends every point of U to $[l^-]$ and every point $x \in \bigcap_{k=0}^n f^{-k}(N)$ to $\pi_{l^-}(f^n(x))$ induces a map $b : N/L \rightarrow N/l^-$ because $L \subset U$. The map b is constant on the open set U of N and continuous when restricted to $\bigcap_{k=0}^n f^{-k}(N)$. In order to check the continuity of b on N/L we just need to observe that $f^n(x) \in l^-$ for any $x \in \partial_N U$, hence $b(x) = [l^-]$ as desired. To prove that $b \circ \bar{f} = f^- \circ b$, one must prove that

$$b(\bar{f}(\pi_L(x))) = f^-(b(\pi_L(x)))$$

for every $x \in N$. Observe that this equation is satisfied in the cases

$$x \in L, \quad x \in U \setminus L, \quad x \in \bigcap_{k=0}^{n+1} f^{-k}(N), \quad x \in \bigcap_{k=0}^n f^{-k}(N) \setminus \bigcap_{k=0}^{n+1} f^{-k}(N).$$

The projection π_L sends every point of l^- to $[L]$ because $l^- \subset L$ and so induces a continuous map $a : N/l^- \rightarrow N/L$ which sends $[l^-]$ to $[L]$. To prove that $a \circ f^- = \bar{f} \circ a$, one must prove that

$$a(f^-(\pi_{l^-}(x))) = \bar{f}(a(\pi_{l^-}(x)))$$

for every $x \in N$. Here again, using the fact that $U^- \subset L$ and $f(L) \cap N \subset L$, one can observe that the previous equality is satisfied in the following cases

$$x \in l^-, x \in U^- \setminus l^-, x \in L \setminus U^-, x \in N \setminus L.$$

It remains to prove that $b \circ a = (f^-)^n$ and $a \circ b = (\bar{f})^n$, which means

$$b(a(\pi_{l^-}(x))) = (f^-)^n(\pi_{l^-}(x)), \quad a(b(\pi_L(x))) = (\bar{f})^n(\pi_L(x))$$

for every $x \in N$. It is satisfied in the following cases

$$x \in U, x \in \partial_N U, x \in N \setminus \bar{U}.$$

□

Note that in the proof of Lemma 2.4.10 and Proposition 2.4.11 we haven't used the invertibility of f , so the results concerning (N, l^-) and f^- hold for any continuous map f .

2.4.3 On the connectedness of $\overline{N \setminus L}$

Even though we already know that filtration pairs can always be chosen to be regular, it may happen that the isolating neighborhood $\overline{N \setminus L}$ fails to be connected despite X is connected. The purpose of the first part of this section is to solve this issue by showing that, if X is connected, we can stick our considerations to the connected component of $\overline{N \setminus L}$ without losing any dynamical information represented by the spectrum of the discrete homological Conley index of X and f . The 2-dimensional version of what is done here can be found in [LY].

Example 2.4.12. Recall the hyperbolic dynamics in Example 2.2.18. Let (N, L_t^-) a filtration pair for f and $\{0\}$. Let us add to L_t^- a thin strip lying close to l_t^- . Clearly, if $\varepsilon > 0$ is sufficiently small, $f(l_{t+2\varepsilon}^-) \subset L_t^-$. Define $L = L_t^- \cup (\overline{L_{t+2\varepsilon}^- \setminus L_{t+\varepsilon}^-})$. A careful inspection shows that (N, L) is still a regular filtration pair. However, $\overline{N \setminus L}$ is not connected.

One may expect all Conley index information to be carried to the connected component where X lies, not only its spectrum. In the second half of the subsection we will expose a geometrical argument which allows, if f is a homeomorphism, to replace spectrum equivalence by shift equivalence in the previous paragraph.

Throughout this subsection we just assume that f is continuous unless otherwise stated. Assume that (N, L) is a regular filtration pair for X and f and denote $\mathcal{S} = \pi_0(\overline{N \setminus L})$ the set of connected components of $\overline{N \setminus L}$. Recall that, for every $r \geq 0$, $\tilde{H}_r(N/L) \sim H_r(N, L)$ and $\tilde{H}_r(N/(\overline{N \setminus S})) \sim H_r(N, \overline{N \setminus S})$ because the pairs (N, L) and $(N, \overline{N \setminus S})$ are regular for any $S \in \mathcal{S}$. The quotient N/L is the wedge sum of the pointed spaces $N/(\overline{N \setminus S})$ for $S \in \mathcal{S}$ and we may write

$$H_r(N, L) = \bigoplus_{S \in \mathcal{S}} H_r(N, \overline{N \setminus S}).$$

This decomposition provides a way to split the action of the map $\bar{f}_{*,r}$ in the group $H_r(N, L)$. Given $S_0, S_1 \in \mathcal{S}$, define

$$\bar{f}_{*,r}^{S_1, S_0} = \pi_r^{S_1} \circ \bar{f}_{*,r}|_{H_r(N, \overline{N \setminus S_0})},$$

where $\pi_r^{S_1} : H_r(N, L) \rightarrow H_r(N, \overline{N \setminus S_1})$ is the projection parallel to $\bigoplus_{S \neq S_1} H_r(N, \overline{N \setminus S})$. Therefore, it is possible to write

$$\bar{f}_{*,r}|_{H_r(N, \overline{N \setminus S_0})} = \sum_{S \in \mathcal{S}} \bar{f}_{*,r}^{S, S_0}$$

for any connected component S_0 of $\overline{N \setminus L}$. As a consequence, we get

$$\text{trace}(h_r(f, X)) = \text{trace}(\bar{f}_{*,r}) = \sum_{S \in \mathcal{S}} \text{trace}(\bar{f}_{*,r}^{S, S}).$$

Let us give another interpretation of the maps $\bar{f}_{*,r}^{S_1, S_0}$. Denote $R_i = \overline{N \setminus S_i}$, for $i = 0, 1$. We are in a pretty similar situation of that of weak index pairs and Lemma 2.4.1. Actually, (N, R_i) is a weak index pair for $i = 0, 1$. Define

$$\bar{f}^{S_1, S_0}(x) = \begin{cases} \pi_{R_1}(f(x)) & \text{if } x \in N \setminus R_0 \\ [R_1] & \text{otherwise} \end{cases} \quad (2.9)$$

where $\pi_{R_1} : N \rightarrow N/R_1$ is the projection map and we identify $N \setminus R_0 \sim N/R_0 - [R_0]$. Since (N, L) is a filtration pair,

$$f(\partial_N R_0) \subset f(\partial_N L) \subset \text{int}_N(L) \subset \text{int}_N R_1,$$

so \bar{f}^{S_1, S_0} is continuous at $[R_0]$. It follows that \bar{f}^{S_1, S_0} is a continuous base-preserving map. The action of \bar{f}^{S_1, S_0} on the reduced homology groups $\tilde{H}_r(N/R_i) \sim H_r(N, R_i)$ is nothing but $\bar{f}_{*,r}^{S_1, S_0}$. In the special case $S_0 = S_1$ the map \bar{f}^{S_1, S_0} coincides with the map induced by f in the weak index pair $(N, R_0) = (N, \overline{N \setminus S_0})$.

Lemma 2.4.13. *Let S_0 and S_1 be connected components of $\overline{N \setminus L}$ and $\kappa \in H_r(N, \overline{N \setminus S_0})$. If κ is represented by a relative r -cycle σ of $(N, \overline{N \setminus S_0})$, then the class $\bar{f}_{*,r}^{S_1, S_0}(\kappa)$ is represented by a relative r -cycle σ' of $(N, \overline{N \setminus S_1})$ such that $\sigma' \subset f(\sigma \cap S_0)$.*

Proof. Since $f(\overline{N \setminus L}) \subset \text{int}(N)$ and $f(L) \cap (\overline{N \setminus L}) = \emptyset$, there exists a compact neighborhood U of $\overline{N \setminus L}$ in N such that $f(U) \subset N$ and $f(U \cap L) \cap U = \emptyset$. One can suppose additionally that the connected component U_0 of U that contains S_0 is included in $L \cup S_0$. Let σ be a relative r -cycle of $(N, \overline{N \setminus S_0})$ that represents a class $\kappa \in H_r(N, \overline{N \setminus S_0})$. By excision, one can find a r -cycle σ_0 of $(U_0, \overline{U_0 \setminus S_0})$, such that $\sigma_0 \subset \sigma$, which represents the class κ , as a cycle of $H_r(N, \overline{N \setminus S_0})$. Recall that $H_r(N, \overline{N \setminus S_0})$ is a subspace of $H_r(N, L)$ and that the class $\bar{f}_{*,r}(\kappa) \in H_r(N, L)$ is represented by the relative r -cycle $f(\sigma_0)$ of (N, L) . The class $\bar{f}_{*,r}^{S_1, S_0}(\kappa)$ is nothing but the projection of $\bar{f}_{*,r}(\kappa)$ in $H_r(N, \overline{N \setminus S_1})$. It is the homology class of $f(\sigma_0)$, seen as relative cycle of $(N, \overline{N \setminus S_1})$. By excision again, it is represented by a r -cycle σ' of $(U, \overline{U \setminus S_1})$ such that $\sigma' \subset f(\sigma_0) \cap U$. Observe now that

$$\sigma' \subset f(\sigma \cap U_0) \cap U \subset f(\sigma \cap S_0),$$

because $U_0 \subset L \cup S_0$ and $f(U \cap L) \cap U = \emptyset$. \square

For every word $I = \{S_k\}_{0 \leq k < m} \in \mathcal{S}^m$, we define the itinerary map

$$\bar{f}_{*,r}^I = \bar{f}_{*,r}^{S_0, S_{m-1}} \circ \bar{f}_{*,r}^{S_{m-1}, S_{m-2}} \circ \dots \circ \bar{f}_{*,r}^{S_2, S_1} \circ \bar{f}_{*,r}^{S_1, S_0}.$$

The maximal compact invariant set which follows the itinerary defined by I will be denoted $\text{Inv}(I) = \bigcap_{k \in \mathbb{Z}} f^{-k}(S_k)$, where $\{S_k\}_{k \in \mathbb{Z}}$ is the m -periodic extension of I .

Proposition 2.4.14. *For any word I , if $\text{Inv}(I) = \emptyset$ then the map $\bar{f}_{*,r}^I$ is nilpotent, hence, in particular, $\text{trace}(\bar{f}_{*,r}^I) = 0$.*

Proof. Suppose $I = \{S_k\}_{0 \leq k < m}$ and write $\{S_k\}_{k \in \mathbb{Z}}$ for the m -periodic extension of I . The stable set $\Lambda^- = \bigcap_{k \geq 0} f^{-k}(S_k)$, must be empty. Otherwise, Λ^- would be a non-empty compact set such that $f^m(\Lambda^-) \subset \Lambda^-$, hence $\text{Inv}(I) = \bigcap_{k \geq 0} f^{km}(\Lambda^-) \neq \emptyset$. Thus, there exists $n_0 \geq 1$ such that $\bigcap_{0 \leq k \leq mn_0} f^{-k}(S_k) = \emptyset$.

Fix a class $\kappa \in H_r(N, \overline{N \setminus S_0})$ represented by a relative cycle σ_0 in $(N, \overline{N \setminus S_0})$. By Lemma 2.4.13, we can construct inductively a sequence of relative cycles $\{\sigma_k\}_{0 \leq k \leq mn_0}$ such that

- σ_k represents $\bar{f}_{*,r}^{S_k, S_{k-1}} \circ \dots \circ \bar{f}_{*,r}^{S_1, S_0}(\kappa)$ and
- $\sigma_{k+1} \subset f(\sigma_k \cap S_k)$.

Then, one deduces that $f^{-mn_0}(\sigma_{mn_0}) \subset \bigcap_{0 \leq k \leq mn_0} f^{-k}(S_k) = \emptyset$. Therefore, one has $(\bar{f}_{*,r}^I)^{n_0}(\kappa) = 0$. □

An itinerary which defines a non-nilpotent map must necessarily contain a non-trivial invariant set. Thus, if we assume that X is connected and S denotes the unique connected component of $\overline{N \setminus L}$ which contains X , we obtain that the only itinerary followed by points of X must be constant equal to S , hence

$$\text{trace}(h_r(f^n, X)) = \text{trace}((h_r(f, X))^n) = \text{trace}((\bar{f}_{*,r})^n) = \sum_{I \in \mathcal{S}^n} \text{trace}(\bar{f}_{*,r}^I) = \text{trace}((\bar{f}_{*,r}^{S,S})^n).$$

We have proved the following:

Proposition 2.4.15. *If X is connected, the endomorphisms $\bar{f}_{*,r}$ and $\bar{f}_{*,r}^{S,S}$ are spectrum equivalent.*

Recall from Subsection 2.2.2 that two maps are spectrum equivalent iff they have the same non-zero eigenvalues counted with multiplicity. It is possible to prove that they are actually shift equivalent, which is slightly stronger than being spectrum equivalent. This result is contained in the end of this subsection.

We will conclude this subsection by looking at a particular situation. Assume that there is a compact set $L' \subset \text{int}_N(L)$ such that $f(\overline{N \setminus L'}) \subset N$. If S' is the connected component of $\overline{N \setminus L'}$ which contains S , denote

$$e_r : H_r(N, \overline{N \setminus S}) \rightarrow H_r(S', \overline{S' \setminus S})$$

the excision isomorphism and

$$f_{*,r} : H_r(S', \overline{S' \setminus S}) \rightarrow H_r(N, \overline{N \setminus S})$$

the map induced by f . One can write $\bar{f}_{*,r}^{S,S} = f_{*,r} \circ e_r$. It will be more convenient to deal with $\tilde{f}_{*,r} := e_r \circ f_{*,r}$. This map being conjugate to $\bar{f}_{*,r}^{S,S}$, one can state:

Proposition 2.4.16. *If X is connected, the endomorphism $\tilde{f}_{*,r}$ belongs to the spectrum equivalence class of the r -homological Conley index.*

To sum up, if X is connected the trace computations can be done with the map $\tilde{f}_{*,r}$, which is not directly induced in general by a filtration pair but arises as the result of considering just the connected component containing X . A complete description of this map for $r = 1$ will allow us to prove a closed formula for the traces of the iterates of the 1-homological discrete Conley index.

Let us conclude this discussion with the statement the particular case $S_0 = S_1 = S$ of Lemma 2.4.13, with $\tilde{f}_{*,r}$ instead of $\tilde{f}_{*,r}^{S,S}$, which will be used in the proofs as a way to keep control of the successive images of an homology class under the map $\tilde{f}_{*,r}$.

Lemma 2.4.17. *If $\kappa \in H_r(S', \overline{S' \setminus S})$ is represented by a relative r -cycle σ , the homology class $\tilde{f}_{*,r}(\kappa)$ is represented by a relative cycle σ' such that $\sigma' \subset f(\sigma \cap S)$.*

Henceforth and until the end of this subsection we will assume f is a homeomorphism and X is connected. Previously, we have defined the maps $\tilde{f}_{*,r}$ on the homology groups $H_r(S', \overline{S' \setminus S})$. In general, the pair $(S', \overline{S' \setminus S})$ is not a filtration pair for X and f because we can not ensure that the set $\overline{S' \setminus S}$ is positively invariant in S' . It may happen that

$$f(\overline{S' \setminus S}) \cap S \neq \emptyset.$$

Thus, we do not know a priori whether the map $\tilde{f}_{*,r}$ belongs to the shift equivalence class $h_r(X, f)$ or not.

Likewise, $(N, \overline{N \setminus S})$ is not a filtration pair in general. However, it is a weak index pair for X . Denote $J = \overline{N \setminus S}$. It is enough to notice that

$$f(\partial_N J) \cap S \subset f(\partial_N L) \cap (\overline{N \setminus L}) = \emptyset$$

and $f(S) \subset f(\overline{N \setminus L}) \subset \text{int}(N)$.

The fundamental object in our next arguments is the unstable set of f in $S = \overline{N \setminus J}$, which we denote simply $\Lambda^- = \Lambda^-(f, S)$. The unstable set is backward invariant and essentially captures all information contained in the Conley index. We have that

$$\Lambda^- = \bigcap_{n \geq 0} f^n(S).$$

The nested sequence $\{V_k = \bigcap_{n=0}^k f^n(S)\}_{k \geq 0}$ is a basis of compact neighborhoods of Λ^- in S . It is easy to check that the pairs $(V_k \cup J, J)$ are weak index pairs hence f induces a continuous map f_k in the quotient space $(V_k \cup J)/J$. Notice that f_0 is the index map associated to the pair (N, J) .

Lemma 2.4.18. *The maps f_k , for $k \geq 0$, are shift equivalent.*

Proof. It suffices to show that f_k and f_{k+1} are shift equivalent for any $k \geq 0$. By definition $f(V_k) \subset V_{k+1} \cup J$, hence f induces a map $r : (V_k \cup J)/J \rightarrow (V_{k+1} \cup J)/J$. Clearly, $r \circ f_k = f_{k+1} \circ r$.

The inclusion $V_{k+1} \subset V_k$ induces a continuous map $s : (V_{k+1} \cup J)/J \rightarrow (V_k \cup J)/J$ which is also a semiconjugation between f_k and f_{k+1} , $s \circ f_{k+1} = f_k \circ s$. Finally, it is also evident that $s \circ r = f_k$ and $r \circ s = f_{k+1}$. \square

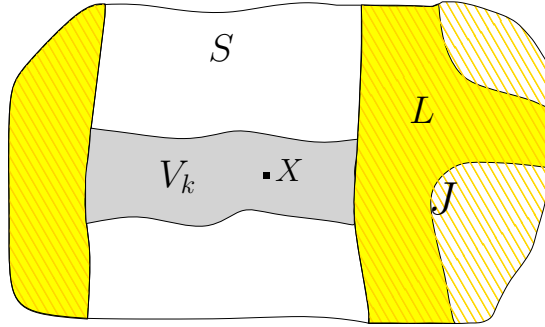

Figure 2.9: Elements of N in Lemma 2.4.18.

The following lemma shows that the shift equivalence class of the maps f_k is the Conley index of X . In particular, the index map associated to (N, J) or, equivalently, to $(S', \overline{S' \setminus S})$ is a representative of the Conley index.

Lemma 2.4.19. *If $k \geq 0$ is sufficiently large, the pair $(V_k \cup J, J)$ is a filtration pair for f and X .*

Proof. Firstly, note that V_k is a compact neighborhood of X contained in $\overline{N \setminus J} \subset \overline{N \setminus L}$. Leaving regularity of the sets aside, the only property of filtration pairs which may not be fulfilled by $(V_k \cup J, J)$ is (3) in Definition 2.2.16 as $f(J)$ may possibly meet V_k . However, note that Λ^- is backward invariant, $f(\Lambda^-) \supset \Lambda^-$, and the relative boundary of J is mapped by f into the relative interior of J . As a consequence, the compact set $f(J)$ is disjoint to Λ^- . Since $\{V_k\}_{k \geq 0}$ is a basis of neighborhoods of Λ^- in $\overline{N \setminus J}$, if k is large enough $f(J)$ is disjoint to V_k .

Finally, we need to check that J and $V_k \cup J$ are the closure of their interiors. This regularity is guaranteed for J by the fact that the original (N, L) was a filtration pair. Now, if $x \in V_k$ does not belong to the closure of $\text{int}(V_k)$ the point $f^{-k}(x)$ of $V_0 = \overline{N \setminus J}$ will not be a limit point of $\text{int}(N)$, contradicting the regularity of the pair (N, L) . \square

As a corollary of the previous lemmata, we improve Proposition 2.4.16 for homeomorphisms.

Proposition 2.4.20. *If X is connected and f is a homeomorphism, the endomorphism $\tilde{f}_{*,r}$ belongs to the r -homological discrete Conley index of X and f .*

Proof. It is enough to notice that the induced action in homology of the map f_0 is exactly $\tilde{f}_{*,r}^{S,S}$, which is conjugate to $\tilde{f}_{*,r}$. \square

2.4.4 Duality

In this subsection we prove a duality result for the discrete Conley index. As in any duality result, the invertibility of our dynamics is essential, so we will assume that f is a homeomorphism.

Although the results of this subsection are already contained in the work of Szymczak [Sz98], here we aim to give a more intuitive approach to the duality of the discrete Conley

index. We show that it is possible to define an intersection between classes of the r -dimensional homological Conley index of X for f and classes of the $(d - r)$ -dimensional homological Conley index of X for f^{-1} . This intersection pairing corresponds to the one which was already defined for singular chains, and the reason why it can be applied to our context is that classes of homological Conley indices for f and f^{-1} may be represented by cycles lying close to the stable and unstable set of f of some isolating neighborhood of X . Thus, cycles representing classes of the two indices will intersect just in a neighborhood of $X = \Lambda^+ \cap \Lambda^-$, which may be assumed to be contained in the interior of the isolating neighborhood, and their intersection is a well-defined number. A classical reference for intersection of singular chains is the book of Seifert and Threlfall (Section 73, [ST80]).

Let X be an isolated invariant set, N a regular isolating block of X and (N, L^-) and (N, L^+) regular filtration pairs for X and f and f^{-1} , respectively. Without loss of generality, assume that the pairs $(\overline{N \setminus L^+}, \overline{L^- \setminus L^+})$ and $(\overline{N \setminus L^-}, \overline{L^+ \setminus L^-})$ are also regular. Denote $M = N \setminus (L^- \cup L^+)$.

Lemma 2.4.21. *$(\overline{N \setminus L^+}, \overline{L^- \setminus L^+})$ and $(\overline{N \setminus L^-}, \overline{L^+ \setminus L^-})$ are filtration pairs for X and f and f^{-1} , respectively.*

Proof. We just write the proof for the first pair. The set M is an isolating neighborhood of X and satisfies $f(M) \cap L^+ = \emptyset$ because $f^{-1}(L^+) \cap N \subset \text{int}_N(L^+)$ by definition of filtration pair. Consequently, $f(M) \subset \overline{N \setminus L^+}$. Again, using that $f(\overline{N \setminus L^+}) \cap L^+ = \emptyset$ we deduce that the set $\overline{L^- \setminus L^+}$ is positively invariant relative to N , from which we can conclude that $(\overline{N \setminus L^+}, \overline{L^- \setminus L^+})$ is a filtration pair. \square

Our immediate goal is to arrive at the situation described in Subsection 2.4.2. Denote $l^- = M \cap L^-$ and $l^+ = M \cap L^+$.

Lemma 2.4.22. *The triple (M, l^-, l^+) is a filtration triple.*

Proof. From the regularity assumption on the pairs

$$(\overline{N \setminus L^+}, \overline{L^- \setminus L^+}) \quad \text{and} \quad (\overline{N \setminus L^-}, \overline{L^+ \setminus L^-})$$

we deduce that l^- and l^+ are manifolds with boundary. Since N is an isolating block, $L^- \cup L^+$ covers its boundary and this implies that $l^- \cup l^+ = \partial M$. It also follows from the construction that l^- and l^+ only meet in their common boundary and (l^-, l^+) is a regular decomposition for ∂M . \square

The map f induces continuous maps $f^- : M/l^- \rightarrow M/l^-$ and $f^+ : M/l^+ \rightarrow M/l^+$ which are equal to the maps induced by f in the filtration pairs $(\overline{N \setminus L^+}, \overline{L^- \setminus L^+})$ and $(\overline{N \setminus L^-}, \overline{L^+ \setminus L^-})$, denoted g^- and g^+ respectively, because the quotient spaces are identical. In particular, this means that f^- and f^+ belong to the Conley index of f and f^{-1} , as was also deduced in Subsection 2.4.2 from the definition of filtration triple.

The maps induced by f^- and g^- in the relative homology groups are conjugate via the excision isomorphism

$$e^- : H_*(\overline{N \setminus L^+}, \overline{L^- \setminus L^+}) \rightarrow H_*(M, l^-).$$

In other words, f_*^- is equal to the composition $e^- \circ g_*^- \circ (e^-)^{-1}$. Writing $[\cdot]$ to denote the homology class represented by a cycle, for a cycle $\sigma \in C_*(M, l^-)$ we get that

$$f_*^-([\sigma]) = [f(\sigma) \cap M] \quad (2.10)$$

as a consequence of the work done in Subsection 2.4.3. Analogous statements hold if we replace f^- by f^+ .

Filtration triples provide a very nice setting to work with homology classes, but we need an extra remark for the duality to be well-defined. As we are only interested in homological Conley indices, we just need to look at the generalized images of the maps f_*^- and f_*^+ .

Since M is an isolating neighborhood, the invariant set $X = \Lambda^- \cap \Lambda^+$ lies in the interior of M , where Λ^+ and Λ^- denote the stable and unstable set of f in M . There are neighborhoods of Λ^- and Λ^+ of the form $V^- = \bigcap_{n=0}^k f^n(M)$ and $V^+ = \bigcap_{n=-k}^0 f^n(M)$ which do not intersect in ∂M . Using repeatedly Equation 2.10 as in the arguments contained in Subsection 2.4.2, one deduces that every homology class of the generalized image of the map f_*^- , i.e. of the homological Conley index of f , can be represented by a relative cycle contained in $(V^-, l^- \cap V^-)$. Similarly, every homology class of $h(X, f^{-1})$ can be represented by a relative cycle in $(V^+, l^+ \cap V^+)$. If we take any couple of those cycles their intersection will be contained in $V^- \cap V^+ \subset \text{int}(M)$. Therefore, there is a well-defined intersection between homology classes of the Conley index of f and f^{-1} . If $\alpha \in h_r(X, f)$ and $\alpha' \in h_{d-r}(X, f^{-1})$ are represented by relative cycles σ and σ' in $(V^-, l^- \cap V^-)$ and $(V^+, l^+ \cap V^+)$, respectively, then

$$\alpha \cap \alpha' = [\sigma] \cap [\sigma'] := \sigma \cap \sigma'.$$

This intersection pairing goes along well with the map f . Take $\alpha_0, \alpha_1 := f_*^-(\alpha_0) \in h_r(X, f)$ and $\alpha'_1, \alpha'_0 := f_*^+(\alpha'_1) \in h_{d-r}(X, f^{-1})$ and relative cycles $\sigma_0, \sigma_1 \subset (V^-, l^- \cap V^-)$ and $\sigma'_1, \sigma'_0 \in (V^+, l^+ \cap V^+)$ representing $\alpha_0, \alpha_1, \alpha'_1, \alpha'_0$, respectively, such that $\sigma_1 = f(\sigma_0) \cap M$ and $\sigma'_1 = f^{-1}(\sigma'_0) \cap M$. Then,

$$\alpha_0 \cap f_*^+(\alpha'_1) = \alpha_0 \cap \alpha'_0 = \sigma_0 \cap \sigma'_0 = d(f)\sigma_1 \cap \sigma'_1 = d(f)\alpha_1 \cap \alpha'_1 = d(f)f_*^-(\alpha_0) \cap \alpha'_1, \quad (2.11)$$

where $d(f) = 1$ if f preserves orientation and -1 otherwise.

Lefschetz duality offers another perspective of this intersection. There is an isomorphism $\Phi : H_{d-r}(M, l^+) \rightarrow H^r(M, l^-)$ given by $\Phi(\sigma) = \delta$ iff $\sigma = \delta \cap [M, \partial M]$, where $[M, \partial M] \in H_d(M, \partial M)$ denotes the fundamental class and the symbol \cap has here been used to denote the cap product. It turns out that the intersection of homology classes $\kappa' \in H_r(M, \partial L^- \cap M)$ and $\kappa \in H_{d-r}(M, \partial L^+ \cap M)$ is

$$\kappa \cap \kappa' = (\Phi(\kappa'))(\kappa)$$

This property shows that the intersection pairing is non-degenerate and from Equation 2.11 we get that the map f_*^{-1} is dual to f_* . The general result can be stated as follows.

Theorem 2.4.23 (Szymczak). *Let f be a local homeomorphism of a manifold of dimension d and X an isolated invariant set. Then, for any $0 \leq r \leq d$*

$$h_{d-r}(X, f) \cong (h_r(X, f^{-1}))^*.$$

This result was already proved by Szymczak in [Sz98], where he had to overcome some technical problems caused by the manipulation of index pairs (a weaker notion than filtration pair that has been described in Subsection 2.4.1) which were not assumed to be regular, as in our case.

Example 2.4.24. Recall the picture from Example 2.2.18. For $t > 0$ sufficiently small we showed that (N, L_t^-) is a filtration pair. As defined in Subsection 2.2.6, the induced map $\bar{f} : N/L_t^- \rightarrow N/L_t^-$ is a representative of the discrete Conley index of $\{0\}$. Since, (l_0^-, l_0^+) is a regular decomposition of ∂N , the induced map $f^- : N/l_0^- \rightarrow N/l_0^-$ is also a representative of the discrete Conley index. It is easy to check that the pointed spaces N/L_t^- and N/l_0^- are homotopically equivalent to the standard pointed k -sphere $(S^k, *)$. Suppose that all the eigenvalues of A whose modulus are larger than 1 are positive. Then, the maps \bar{f} and f^- are homotopic to the identity map in the k -sphere. In particular, $h_r(f, \{0\})$ is trivial except for $r = k$ and

$$h_k(f, \{0\}) = (\mathbb{Q}, \text{id}).$$

As a generalization, if exactly l eigenvalues of A with modulus greater than 1 are negative, we obtain that the only non-trivial index is the one of grade k and is equal to

$$h_k(f, \{0\}) = (\mathbb{Q}, (-1)^l \cdot \text{id}).$$

An analogous discussion computes the indices for f^{-1} . All homological Conley indices are trivial except for $r = d - k$,

$$h_{d-k}(f^{-1}, \{0\}) = (\mathbb{Q}, (-1)^j \cdot \text{id}),$$

where j denotes the number of negative eigenvalues of A with modulus smaller than 1. The reader can check the validity of Theorem 2.4.23 in this example.

For the following fix $d = 3$ and $k = 2$. In this case we retrieve the typical portray of an hyperbolic fixed point in \mathbb{R}^3 with a 2-dimensional unstable manifold. Denote $\mathbb{H}^+ = \mathbb{R}^2 \times \{y \geq 0\}$ the upper half-space, which is invariant under f , and set $N^+ = N \cap \mathbb{H}^+$.

Consider the unit cube M in \mathbb{R}^3 . Let us divide \mathbb{R}^3 radially in six infinite square pyramids $\{P_1, \dots, P_6\}$, the intersection of each of them with ∂M being one face of the cube and its common apex being the origin. Transfer the dynamics of $f|_{\mathbb{H}^+}$ to each P_i via a homeomorphism $h_i : \mathbb{H}^+ \rightarrow P_i$. Assume that the gluing homeomorphisms agree in the faces of the pyramids so that we obtain a homeomorphism g of \mathbb{R}^3 such that $g|_{P_i} = h_i \circ f|_{\mathbb{H}^+} \circ h_i^{-1}$. Assume further that $h_i(N^+) = M \cap P_i$ and denote l^- (resp. l^+) the union of the sets $h_i(l_0^- \cap \mathbb{H}^+)$ (resp. $h_i(l_0^+ \cap \mathbb{H}^+)$). Clearly, (l^-, l^+) is a regular decomposition of ∂M , l^- is a neighborhood of the edges of the cube and l^+ has six connected components, one inside each face of the cube. See Figure 2.10. Additionally, $g(l^-) \cap M = \emptyset$ and $g^{-1}(l^+) \cap M = \emptyset$ from which it follows that (N, l^-, l^+) is a filtration triple. The origin is the unique bounded invariant set and, in particular, it is the maximal invariant subset of M . Therefore, the map g^- (resp. g^+) induced by g (resp. g^{-1}) in the quotient space M/l^- (resp. M/l^+) belongs to discrete Conley index of g and $\{0\}$ (resp. g^{-1} and $\{0\}$).

The computation of the homology groups of N/l^- and N/l^+ is not difficult once we observe that N/l^- is homotopically equivalent to a bouquet of 5 2-spheres and N/l^+ is

homotopically equivalent to a bouquet of 5 circles. Consequently, the only non-trivial homology groups are

$$H_2(N, l^-) \cong \mathbb{Q}^5 \quad \text{and} \quad H_1(N, l^+) \cong \mathbb{Q}^5.$$

From the dynamics it is possible to conclude that the action of the maps g^- and g^+ in homology is equal to the identity map. Thus, the only non-trivial homological Conley indices for g and g^{-1} are

$$h_2(g, \{0\}) = (\mathbb{Q}^5, \text{id}) \quad \text{and} \quad h_1(g^{-1}, \{0\}) = (\mathbb{Q}^5, \text{id}).$$

This computation trivially agrees with Theorem 2.4.23.

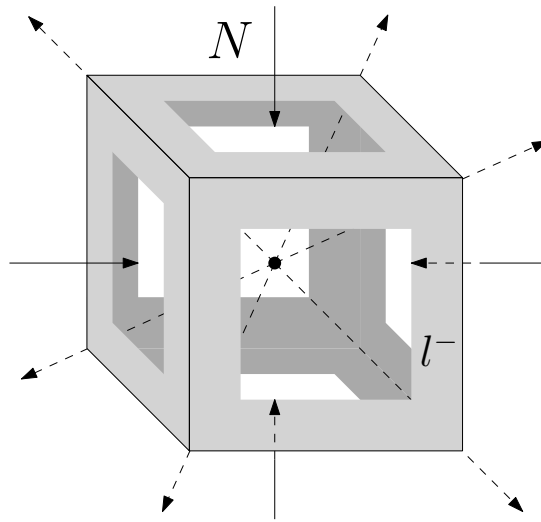

Figure 2.10: Example 2.4.24: l^- is a neighborhood of the edges of the cube N .

2.5 Main results

2.5.1 Statement of the key theorem and proofs

Henceforth, we will assume that our isolated invariant set X is connected and acyclic and the map is just continuous. In Subsection 2.4.3 we proved that it suffices to know the traces of the iterates of the map $\tilde{f}_{*,r}$ in order to compute the sequence $\{\text{trace}(h_r(f^n, X))\}_n$, they are equal. In this subsection we provide the statement of a result from which all the theorems presented in the introduction follow easily, hence it is the key result of the chapter.

Theorem 2.5.1. *Let f be a local map of \mathbb{R}^d and X an isolated invariant acyclic continuum which is not a repeller. There exists two finite maps $\varphi : J \rightarrow J$ and $\psi : J' \rightarrow J'$ and, for every $r \geq 1$, a representative $\tilde{f}_{*,r}$ of the spectrum equivalence class of the r -homological discrete Conley index of X and f such that:*

- $\tilde{f}_{*,1}$ is a reduced permutation endomorphism defined by φ .

- $\tilde{f}_{*,r}$ is dominated by ψ .
- φ and ψ are shift equivalent.

The proof of this theorem is the content of Subsections 2.5.4 to 2.5.9. We have all ingredients to prove Theorems 2.1.1, 2.1.2 and 2.1.8. In Subsection 2.2.7 it has been already addressed the case in which X is an attractor and was also shown that the previous result also holds for repellers provided that the map is a homeomorphism.

Proof of Theorem 2.1.1. It is straightforward once we apply Propositions 2.2.11 and 2.2.14 to the reduced permutation endomorphism $\tilde{f}_{*,1}$, which is spectrum equivalent to any map in the class $h_1(f, X)$. \square

Proof of Theorem 2.1.2. From Theorem 2.1.1 we get that $\text{trace}(h_1(f, X)) = -1$ if and only if φ is fixed point free. In that case, ψ is also fixed point free because it is shift equivalent to φ . The trivial remark that follows Definition 2.2.9 finishes the proof. \square

Proof of necessity of Theorem 2.1.8. From equation (2.7) we obtain that for $n \geq 1$,

$$i(f^n, X) = -\text{trace}(h_1(f^n, X)) + \text{trace}(h_2(f^n, X)). \quad (2.12)$$

Theorem 2.1.1 and Szymczak's duality tell us that there exist two finite maps $\varphi : J \rightarrow J$ and $\varphi' : J' \rightarrow J'$ such that

$$\text{trace}(h_1(f^n, X)) = -1 + \#\text{Fix}(\varphi^n)$$

and

$$\text{trace}(h_2(f^n, X)) = (-1)^n(-1 + \#\text{Fix}((\varphi')^n)).$$

Plugging these expressions into (2.12), we deduce that

$$i(f^n, X) = \begin{cases} 2 - \#\text{Fix}(\varphi^n) - \#\text{Fix}((\varphi')^n) & \text{if } n \geq 1 \text{ is odd} \\ -\#\text{Fix}(\varphi^n) + \#\text{Fix}((\varphi')^n) & \text{if } n \geq 1 \text{ is even.} \end{cases}$$

If we denote b_k and c_k the number of k -periodic orbits of φ and φ' , respectively, we get

$$i(f^n, X) = \begin{cases} 2 - \sum_{k|n} k \cdot (b_k + c_k) & \text{if } n \geq 1 \text{ is odd} \\ -\sum_{k|n} k \cdot (b_k - c_k) & \text{if } n \geq 1 \text{ is even.} \end{cases}$$

Thus, a careful computation shows that if we define

$$a_k = \begin{cases} 2 - b_1 - c_1 & \text{if } k = 1, \\ -1 - b_2 + c_2 + c_1 & \text{if } k = 2, \\ -b_k - c_k & \text{if } k > 1 \text{ is odd,} \\ -b_k + c_k & \text{if } k > 2 \text{ and } k/2 \text{ are even,} \\ -b_k + c_k + c_{k/2} & \text{if } k > 2 \text{ is even and } k/2 \text{ is odd.} \end{cases} \quad (2.13)$$

we can write $\{i(f^n, X)\}_{n \geq 1} = \sum_k a_k \sigma^k$. Now, it is trivial to check that Corollary 2.1.4 implies that $a_1 \leq 1$, hence $b_1 + c_1 \geq 1$ and also that $a_k \leq 0$ for all odd $k > 1$. Moreover, there are only a finite number of non-zero b_k and c_k , hence of a_k , which implies that the sequence of fixed point indices must be periodic. \square

2.5.2 A toy model: a radial case

In this subsection we will sketch a proof of our results and, in particular, of Theorem 2.5.1 for the case in which the map is a homeomorphism which fixes only one point and presents a radial dependence. This type of maps will provide examples which realize all possible sequences of fixed point indices of the iterates of a map at a fixed point described in Theorem 2.1.8 as will be explained in the next subsection.

The $(d + 1)$ -dimensional sphere is the end compactification of $S^d \times \mathbb{R}$, where one adds the lower end e^- , adherent to $S^d \times (-\infty, 0]$, and the upper end e^+ , adherent to $S^d \times [0, +\infty)$.

Let h be a homeomorphism of S^d and $g : S^d \rightarrow \mathbb{R}$ be a continuous map. The skew-product of g and h

$$(z, r) \mapsto (h(z), r + g(z))$$

induces in S^{d+1} a homeomorphism f which fixes the two ends. An extra hypothesis may be added to ensure that the origin is isolated as an invariant set. Assume that

$$g(z) \geq 0 \Rightarrow g(h(z)) > 0 \tag{P}$$

which evidently implies that there exists $\varepsilon > 0$ so that

$$g(z) \geq -\varepsilon \Rightarrow g(h(z)) \geq \varepsilon.$$

Property (P) implies that no discrete interior tangency is possible in any closed $(d + 1)$ -ball of the form $(S^d \times (-\infty, r]) \cup \{e^-\}$, hence it is an isolating block for f . In particular, there are no fixed points in $S^d \times \mathbb{R}$. Assume additionally that the origin is neither a repelling nor an attracting fixed point, which means that g must take positive and negative values.

Let l^- be a submanifold with boundary of S^d which is a neighborhood of the set $\{z \in S^d \mid g(z) \geq \varepsilon\}$ included in $\{z \in S^d \mid g(z) > 0\}$. Observe that

- $h(l^-) \subset \text{int}(l^-)$.
- $g > 0$ in l^- and $g < 0$ in $S^d \setminus h^{-1}(l^-)$.

Define $l^+ = \overline{S^d \setminus l^-}$, then $h^{-1}(l^+) \subset \text{int}(l^+)$. After identifying S^d to $S^d \times \{0\}$, the sets l^- and l^+ may be considered as subsets of $S^d \times \{0\} \subset S^d \times \mathbb{R}$. If we denote $N = (S^d \times (-\infty, 0]) \cup \{e^-\}$, the triple (N, l^-, l^+) is a filtration triple as defined in Subsection 2.4.2.

The map \bar{f} induced by f on the quotient space N/l^- induces an endomorphism $\bar{f}_{*,r} : H_r(N, l^-) \rightarrow H_r(N, l^-)$ which is a representative of the r -homological Conley index. Each space $H_r(N)$ being trivial if $r \neq 0$ and 1-dimensional if $r = 0$, the connecting map

$$\partial_r : H_r(N, l^-) \rightarrow H_{r-1}(l^-),$$

induces an isomorphism between $H_r(N, l^-)$ and the reduced r -homological group $\tilde{H}_{r-1}(l^-)$, where

$$\tilde{H}_r(l^-) = \begin{cases} H_r(l^-) & \text{if } r \geq 1 \\ \ker(j_*) & \text{if } r = 0 \end{cases}$$

and

$$j_* : H_0(l^-) \rightarrow H_0(N)$$

is the inclusion-induced map.

There is an easy way to understand the inverse of the connecting map. Denoting Δ_r the standard affine simplex, one can associate to every singular r -simplex $\sigma : \Delta_r \rightarrow l^-$ a singular $(r+1)$ -simplex $p(\sigma) : \Delta_{r+1} \rightarrow N$ defined as follows:

$$p(\sigma)(t_1, \dots, t_{r+1}) = \begin{cases} \left(\sigma \left(\frac{t_1}{1-t_{r+1}}, \dots, \frac{t_r}{1-t_{r+1}} \right), \frac{t_{r+1}}{t_{r+1}-1} \right) & \text{if } t_{r+1} \neq 1, \\ e^- & \text{if } t_{r+1} = 1. \end{cases}$$

By linear extension, p associates to every r -chain σ of l^- a $(r+1)$ -chain of N . If σ is a cycle of l^- (inducing an element of $\tilde{H}_0(l^-)$ if $r=0$), then $p(\sigma)$ is a relative cycle of (N, l^-) . If σ is the boundary of a $(r+1)$ -chain of l^- , then $p(\sigma)$ is the boundary of a relative $(r+2)$ -chain of (N, l^-) . The naturally induced morphism $p_* : \tilde{H}_r(l^-) \rightarrow H_{r+1}(N, l^-)$ is nothing but the inverse of ∂_r . Observe now that

$$\bar{f}_{*,r}([p(\sigma)]) = [p(h(\sigma))].$$

In other words, the map $\bar{f}_{*,r+1} : H_{r+1}(N, l^-) \rightarrow H_{r+1}(N, l^-)$ is conjugate to the map $h_{*,r} : \tilde{H}_r(l^-) \rightarrow \tilde{H}_r(l^-)$ by p_* . Similarly the map $(\bar{f}^{-1})_{*,r+1} : H_{r+1}(N, l^+) \rightarrow H_{r+1}(N, l^+)$ is conjugate to $(h^{-1})_{*,r} : \tilde{H}_r(l^+) \rightarrow \tilde{H}_r(l^+)$.

The duality explained in Subsection 2.4.4 can be deduced from classical duality results. By Alexander's duality, there is a natural isomorphism

$$\tilde{H}_r(l^-) \rightarrow \tilde{H}^{d-r-1}(l^+),$$

where $\tilde{H}^{d-r-1}(l^+)$ is the dual space of $\tilde{H}_{d-r-1}(l^+)$. This isomorphism conjugates $h_{*,r}$ to the dual map of $(h^{-1})_{*,d-r-1}$ if h preserves the orientation and to its opposite if h reverses the orientation. This morphism induces naturally an isomorphism

$$H_{r+1}(N, l^-) \rightarrow \tilde{H}^{d-r}(N, l^+),$$

where $\tilde{H}^{d-r}(N, l^+)$ is the dual space of $\tilde{H}_{d-r}(N, l^+)$, which conjugates $\bar{f}_{*,r+1}$ (up to the sign) to the dual map of $(\bar{f}^{-1})_{*,d-r}$.

Theorem 2.5.1 is obvious in this case. Here $\psi = \varphi$ is the natural map induced by h on the set $\pi_0(l^-)$ of connected components of l^- . Indeed, every connected component c of l^- is associated to an element $[c]$ of the homology group $H_0(l^-)$, and the set $\{[c]\}_{c \in \pi_0(l^-)}$ is a basis. Taking $[N]$ as a basis of $H_0(N)$, one has the natural identification $H_0(N) \sim \mathbb{Q}$. The map j_* sends every $[c]$ onto 1. This means that $h_{*,0}|_{\tilde{H}_0(l^-)}$ is nothing but the reduced permutation endomorphism defined by φ . Moreover, for every $r \geq 1$, one has

$$\tilde{H}_r(l^-) = H_r(l^-) = \bigoplus_{c \in \pi_0(l^-)} H_r(c)$$

and $h_{*,r}(H_r(c)) \subset H_r(\varphi(c))$.

As a conclusion, note that given a homeomorphism h of S^d and an attractor/repeller regular decomposition (l^-, l^+) of S^d it is possible to define a map $g : S^d \rightarrow \mathbb{R}$ such that $g > 0$ in l^- and $g < 0$ in $h^{-1}(l^+)$. The triple (N, l^-, l^+) is a filtration triple for the map f , induced in S^{d+1} by the skew-product of g and h .

2.5.3 Realizing all possible sequences $\{i(f^n, p)\}_{n \geq 1}$

In this subsection we will prove the sufficiency condition of Theorem 2.1.8, which characterizes the sequences $I = \{I_n\}$ of integers that can be realized as the sequence $\{i(f^n, p)\}_{n \geq 1}$ of an orientation-reversing local homeomorphism f of \mathbb{R}^3 with a fixed point p isolated as an invariant set. The class of radial homeomorphisms already defined contains examples of homeomorphisms which realize any sequence I satisfying the conditions in the statement of Theorem 2.1.8. The idea will be to control the sequence of fixed point indices in terms of the combinatorial descriptions we have obtained. In order to define the examples we need orientation-reversing homeomorphisms of S^2 with an arbitrary number of periodic orbits. More precisely, we need to prove the following lemma.

Lemma 2.5.2. *Let $\varphi : J \rightarrow J$ be a permutation of the finite set J . It is possible to construct an orientation-reversing homeomorphism f of S^2 which permutes a family $\{D_j\}_{j \in J}$ of pairwise disjoint closed disks such that*

- $f(D_j) = D_{\varphi(j)}$, for every $j \in J$;
- if $f^n(D_j) = D_j$ and n is even then $f^n|_{D_j}$ is equal to the identity;
- if $f^n(D_j) = D_j$ and n is odd then $f^n|_{D_j}$ is conjugate to the map $z \mapsto \bar{z}$ defined on $\mathbb{D} = \{z \in \mathbb{C} \mid |z| \leq 1\}$.

Several approaches may be taken to prove this result. In this article we will follow the ideas of Homma, see [Ho53]. Define a *simple triod* in S^2 as the union of three closed arcs having only one point in common, end point of every one of them.

Theorem 2.5.3 (Homma). *Let F be a compact, connected and locally connected subset of S^2 . A one-to-one continuous map from F to S^2 can be extended to an orientation-preserving homeomorphism of S^2 if and only if it preserves the cyclic order of all simple triods contained in F .*

Proof of Lemma 2.5.2. Let $\{D_j\}_{j \in J}$ be a family of pairwise disjoint circles of same radius, all centered on the real line \mathbb{R} in the complex plane \mathbb{C} . Let $h : \bigcup_{j \in J} D_j \rightarrow \bigcup_{j \in J} D_j$ be the map that translates each disk D_j over $D_{\varphi(j)}$. Consider a set Γ composed of closed segments of the real line such that $F = (\bigcup_{j \in J} D_j) \cup \Gamma$ is connected. It is not difficult to see that h can be extended to a one-to-one continuous map $\tilde{h} : F \rightarrow S^2$, see Figure 2.11. It obviously preserves the cyclic order of all simple triods. By Homma's theorem, one can extend it to a map (with the same name) on the Riemann sphere $\mathbb{C} \cup \{\infty\}$. Composing \tilde{h} with the extension of the complex conjugation to the Riemann sphere yields the required map. \square

Therefore, using Lemma 2.5.2 we can produce examples of orientation-reversing homeomorphisms of the 2-sphere having an arbitrary number of periodic disks with prescribed periods. Now, we are ready to complete the proof of Theorem 2.1.8.

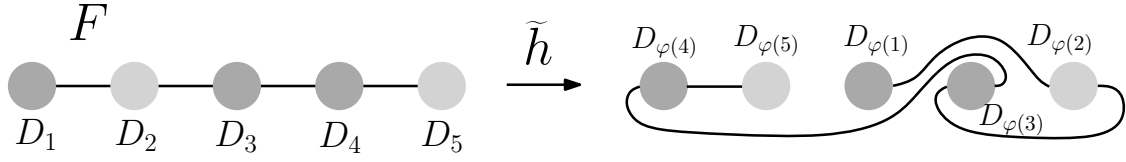

Figure 2.11: Proof of Lemma 2.5.2: example of F and \tilde{h} for $\varphi : \{1, 2, 3, 4, 5\} \rightarrow \{3, 5, 4, 1, 2\}$.

Proof of sufficiency of Theorem 2.1.8. Consider the following system of equations:

$$a_k = \begin{cases} 2 - b_1 - c_1 & \text{if } k = 1, \\ -1 - b_2 + c_2 + c_1 & \text{if } k = 2, \\ -b_k - c_k & \text{if } k > 1 \text{ is odd,} \\ -b_k + c_k & \text{if } k > 2 \text{ and } k/2 \text{ are even,} \\ -b_k + c_k + c_{k/2} & \text{if } k > 2 \text{ is even and } k/2 \text{ is odd.} \end{cases}$$

Clearly, there exist two sequences of non-negative integers $\{b_k\}_{k \geq 1}$ and $\{c_k\}_{k \geq 1}$ which satisfy the system of equations and such that $c_1 = 1$, $b_2 \geq 1$ and $c_k = 0$ for all odd $k > 1$. Since at most a finite number of a_k are non-zero, we can assume that there are only a finite number of non-zero integers b_k and c_k as well. By applying Lemma 2.5.2, choose an orientation-reversing homeomorphism h^+ of a 2-sphere S^+ having b_k cycles of pairwise disjoint disks of period k , for every positive integer $k \geq 1$. Denote one of the b_2 couples of 2-periodic disks $\{D_1^+, D_2^+\}$ and the disks of all the remaining cycles \mathcal{F}^+ . Similarly, one may construct an orientation-reversing homeomorphism h^- of a 2-sphere S^- that induces a permutation on a set of pairwise disjoint closed disks, which will be denoted \mathcal{F}^- , with c_k cycles of length $k/2$ for every even number $k \geq 2$, plus an additional fixed disk D^- . The complement of D^- and all other periodic disks in \mathcal{F}^- will be denoted Σ^- . One can suppose that our two homeomorphisms satisfy the last two assertions of Lemma 2.5.2. Consider two spheres S_1^- and S_2^- of the type S^- together with S^+ . Let s be a map which identically identifies S_1^- to S_2^- and viceversa. Take out the interior of the disks D^- in S_1^- and S_2^- and the disks D_1^+ and D_2^+ of S^+ . Then, paste one boundary ∂D^- to each ∂D_i^+ , $i = 1, 2$. The result is a topological sphere. The fact that our two homeomorphisms satisfy the assertions of Lemma 2.5.2 implies that the pasting can be done in such a way that there exists an homeomorphism h' of our sphere coinciding with h^+ in the complement of $D_1^+ \cup D_2^+$ and with the composition $s \circ h^- = h^- \circ s$ in the complement of the two disks D^- in $S_1^- \cup S_2^-$. Construct a homeomorphism h by composing h' with an orientation-preserving homeomorphism h'' such that every disk D of \mathcal{F}^+ satisfies $h''(D) \subset \text{int}(D)$ and $h''(\Sigma_1^-) \subset \text{int}(\Sigma_2^-)$ and $h''(\Sigma_2^-) \subset \text{int}(\Sigma_1^-)$. The union l^- of the disks in \mathcal{F}^+ , Σ_1^- and Σ_2^- is an attracting set for h'' and, more importantly, for h .

The action $h_{*,0}$ of h on the reduced homology group $\tilde{H}_0(l^-)$ is associated to the reduced permutation automorphism defined by a permutation having b_k cycles of length k , for all $k \geq 1$. The action $h_{*,1}$ of h on $\tilde{H}_1(l^-) = H_1(l^-)$ is associated to the opposite of the permutation automorphism associated to a permutation with c_k cycles of length k , for all even $k \geq 2$. Indeed, the boundaries of the disks of the sets \mathcal{F}^- corresponding

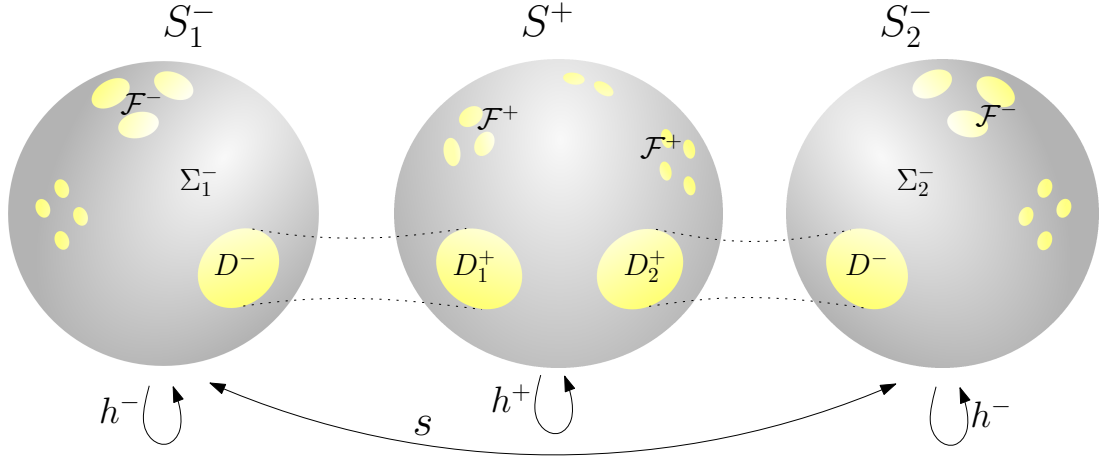

Figure 2.12: Proof of sufficiency of Theorem 2.1.8.

to each S_1^- and S_2^- define a basis of $H_1(l^-)$. To study $h_{*,1}$, one can also use the duality by considering the repeller $l^+ = \overline{S^2} \setminus l^-$ and look at the action of $(h^{-1})_{*,0}$ on $\tilde{H}_0(l^+)$ which is the reduced permutation automorphism defined by a permutation having c_k cycles of length k , for all $k \geq 1$. The traces of the maps $(h_{*,0})^n$ and $(h_{*,1})^n$ are now easy to compute using Propositions 2.2.11, 2.2.14 and Szymczak's Duality. They are equal respectively to $-1 + \sum_{k|n} k \cdot b_k$ and to $(-1)^n(-1 + \sum_{k|n} k \cdot c_k)$. Combining these expressions we obtain,

$$-\text{trace}((h_{*,0})^n) + \text{trace}((h_{*,1})^n) = \begin{cases} 2 - \sum_{k|n} k \cdot (b_k + c_k) & \text{if } n \text{ is odd,} \\ -\sum_{k|n} k \cdot (b_k - c_k) & \text{if } n \text{ is even.} \end{cases}$$

As remarked in the end of Subsection 2.5.2, it is possible to associate to the attractor/repeller pair (l^-, l^+) a continuous map $g : S^2 \rightarrow \mathbb{R}$ such that $g > 0$ in l^- and $g < 0$ in $h^{-1}(l^+)$. The map f induced in S^3 by the skew-product of h and g , is the one we are looking for. Summarizing what has been done in Subsection 2.5.2, one knows that the lower end $\{e^-\}$ is an isolated invariant set for f and, for any integer $n \geq 1$,

$$i(f^n, e^-) = -\text{trace}((\bar{f}_{*,1})^n) + \text{trace}((\bar{f}_{*,2})^n) = -\text{trace}((h_{*,0})^n) + \text{trace}((h_{*,1})^n),$$

whose exact value has been computed in terms of the integers b_k and c_k . It remains to realize that the work done in equation (2.13) guarantees that the definition of b_k and c_k leads to the expression

$$\{i(f^n, e^-)\}_{n \geq 1} = \sum_k a_k \sigma^k.$$

□

2.5.4 Proof I: Construction of a suitable pair

The proof of Theorem 2.5.1 is comprised in the next six subsections, starting from this point and until the end of Section 2.5.

Recall from the hypothesis that X is an isolated invariant acyclic continuum of a local map f . Consider a regular filtration pair (N, L_0) for X and f such that N is connected. The compact set $L'_1 = (f^{-1}(L_0) \cap N) \cup L_0$ is a neighborhood of L_0 in N such that

$$f(L'_1) \cap \overline{(N \setminus L'_1)} \subset (L_0 \cap \overline{(N \setminus L'_1)}) \cup (f(L_0) \cap \overline{(N \setminus L'_1)}) = \emptyset$$

and also that $\overline{N \setminus L'_1}$ is an isolating neighborhood of X . Therefore, we can find a neighborhood L_1 of L'_1 in N such that

- (N, L_1) is a regular pair,
- $\overline{N \setminus L_1}$ is an isolating neighborhood of X ,
- $f(L_1) \cap \overline{(N \setminus L_1)} = \emptyset$,
- $f(\overline{N \setminus L_1}) \subset N \setminus L_0$,

In particular, (N, L_1) is a filtration pair. With the same process, we can define inductively a sequence (N, L_n) of regular filtration pairs of X , such that

- L_{n+1} is a neighborhood of $(f^{-1}(L_n) \cap N) \cup L_n$ in N ,
- $f(\overline{N \setminus L_{n+1}}) \subset N \setminus L_n$.

Note that these properties imply that $f(\overline{L_{n+1} \setminus L_n}) \subset \text{int}_N(L_{n+1})$. Observe that the boundary of a set $N \setminus L_{n+1}$ relative to N and relative to any $\overline{N \setminus L_m}$, with $m \leq n$, coincide because $\partial_N L_{n+1} \cap L_n = \emptyset$ and also that $f(\partial_N L_n) \cap \overline{(N \setminus L_n)} = \emptyset$.

Let us denote S_n the connected component of $\overline{N \setminus L_n}$ that contains X . Of course one has that $f(S_n) \subset S_m$, whenever $0 < m < n$. Indeed $f(S_n)$ is connected, contains X and does not meet L_m . It is trivial to check that each triple (N, S_m, S_n) is regular and satisfies the properties:

- i) S_m is a neighborhood of S_n in N (for the relative topology),
- ii) $f(S_m) \subset N$, $f(S_n) \subset S_m$,
- iii) $f(\partial_N S_n) \cap S_n = \emptyset$,
- iv) S_n is an isolating neighborhood and $\text{Inv}(S_n) = X$.

For every $n \geq 0$ and every $r \in \{0, \dots, d\}$ denote $E_{r,n}$ the subspace of $H_r(N)$ generated by the r -cycles in S_n . We obtain $d + 1$ non-increasing sequences. Each space $H_r(N)$ being finite-dimensional, one can find an integer n_0 such that for every $n \geq n_0$ and every $r \in \{0, \dots, d\}$, one has $E_{r,n} = E_{r,n_0}$. Replacing L_0 with L_{n_0} , and each L_n with L_{n_0+n} , we have the following property, consequence of the minimality of the images of $H_r(S_n) \rightarrow H_r(N)$ and the following chain of inclusions:

$$S_{n+m} \subset \bigcap_{0 \leq k \leq m} f^{-k}(S_n) \subset S_n.$$

- v) For every $n, m \geq 0$ and $r \in \{0, \dots, d\}$, every r -cycle in S_n is homologous, as a cycle of N , to a r -cycle in $\bigcap_{0 \leq k \leq m} f^{-k}(S_n)$.

Let us fix some extra notation valid for the rest of the proof:

$$S' = S_0, \quad S = S_1.$$

The endomorphisms

$$\tilde{f}_{*,r} : H_r(S', \overline{S' \setminus S}) \rightarrow H_r(S', \overline{S' \setminus S})$$

induced by f were shown, in Proposition 2.4.16, to be spectrum equivalent to the r -homological discrete Conley index of X and f . These will be the representatives required by Theorem 2.5.1.

2.5.5 Proof II: Nilpotence

A first approach to the task of describing the homological Conley indices may wonder about the homology groups of the sets S_n , and, in particular, to that of S' . An isolating neighborhood as S' that arises from a filtration pair should be somehow similar to the invariant set X . Thus, for example, it may be possible to prove that there exists a contractible S' provided that X is reduced to a point. However, we have not found yet the dynamical argument, if any, which allows to make such a simplification. The discussion which we present in this subsection formalizes the following idea: a homology class of S' which is not represented by some chain close to the invariant set X , is eventually mapped onto the zero class by the map $\tilde{f}_{*,r}$.

The idea of nilpotence is already present in the work of Richeson and Wiseman, see [RW02], which was discussed in Subsection 2.2.7. In our context, we have to use it in a much more delicate way and need property v).

Denote F_r the image of the inclusion map

$$\iota_r : H_r(S') \rightarrow H_r(S', \overline{S' \setminus S}),$$

that is, the subspace of $H_r(S', \overline{S' \setminus S})$ generated by the r -cycles in S' .

Proposition 2.5.4. *The space F_r is forward invariant under $\tilde{f}_{*,r}$ and included in its generalized kernel.*

Proof. Let us begin by proving the invariance of F_r . By property v) every r -cycle in S' is homologous, as a cycle of N , to a r -cycle of $S' \cap f^{-1}(S')$, so it is homologous to such a cycle as a relative cycle of $(N, N \setminus S)$ and, by excision, as a relative cycle of $(S', \overline{S' \setminus S})$. In particular, every homology class in F_r is represented by a r -cycle σ in $S' \cap f^{-1}(S')$ and its image $\tilde{f}_{*,r}$ is represented by $f(\sigma)$ which is a r -cycle in S' . This means that F_r is forward invariant under $\tilde{f}_{*,r}$. Let us prove now that F_r is included in the generalized kernel of $\tilde{f}_{*,r}$. Since X is acyclic, we can find neighborhoods $V \subset U$ of X contained in $\text{int}(S)$ such that the inclusion-induced map $H_r(V) \rightarrow H_r(U)$ is trivial. The set $\bigcap_{k \in \mathbb{Z}} f^{-k}(S')$ being reduced to X , there exists $n_0 \geq 0$ such that

$$\bigcap_{|k| \leq n_0} f^{-k}(S') \subset V.$$

By using again property v) one knows that every class $\kappa \in F_r$ is represented by a r -cycle σ in $\bigcap_{k=0}^{2n_0} f^{-k}(S')$. This implies that $\tilde{f}_{*,r}^{n_0}(\kappa)$ is represented by $f^{n_0}(\sigma)$, which is a cycle in V , hence a boundary in U . One deduces that $\tilde{f}_{*,r}^{n_0}(\kappa) = 0$. \square

2.5.6 Proof III: Definition of φ , description of $\tilde{f}_{*,1}$

Property v) applied to $r = 1$ gives information about the display of the subsets S and S' of N , which the next proposition will illustrate.

Lemma 2.5.5. *Let (M, T', T) be a regular triple such that all three sets are connected,*

- $T \cap (\overline{M \setminus T'}) = \emptyset$ and
- *the images of the inclusion-induced maps $H_1(T) \rightarrow H_1(M)$ and $H_1(T') \rightarrow H_1(M)$ are equal.*

Then:

- *Given any $c \in \pi_0(\overline{T' \setminus T})$, the set $c \cap T = c \cap \partial_M T$ is connected.*
- *If $\Delta \subset T$ is closed and $\Delta \cap \partial_M T = \emptyset$, there is a bijection*

$$\lambda : \pi_0(T' \setminus \Delta) \rightarrow \pi_0(T \setminus \Delta)$$

defined by $\lambda(c) \subset c$ for any $c \in \pi_0(T' \setminus \Delta)$.

Proof. Let us begin by proving the first point. Every connected component of $\partial_M T$ is a $(d-1)$ -manifold with boundary, whose boundary belongs to ∂M . It defines a homology class $\kappa \in H_{d-1}(M, \partial M)$ and, by Lefschetz duality, a cohomology class in $H^1(M)$, defined by intersecting κ with homology classes in $H_1(M)$. This cohomology class vanishes on the image of $H_1(T)$ in $H_1(M)$, so it vanishes on the image of $H_1(T')$ in $H_1(M)$, by hypothesis. Every connected component c of $\overline{T' \setminus T}$ meets $\partial_M T$ because T' is connected and one knows that $c \cap \partial_M T = c \cap T$. More precisely, $c \cap \partial_M T$ is the finite union of connected components of $\partial_M T$ contained in c . The manifold T being connected, if there is more than one component, one can find a loop γ in T' that intersects a given component of $\partial_M T$ in a unique point and transversally. The cohomology class defined by this component does not vanish on the homology class of γ .

Let us prove now the second point. Denote $\mu : \pi_0(T \setminus \Delta) \rightarrow \pi_0(T' \setminus \Delta)$ the map that assigns to every connected component C of $T \setminus \Delta$ the connected component of $T' \setminus \Delta$ that contains C . The first point tells us that $\mu(C)$ is the union of C and of the connected components c of $\overline{T' \setminus T}$ such that the non-empty connected set $c \cap \partial_M T$ is included in C . As a consequence, one deduces that μ is one-to-one. The fact that μ is onto is an immediate consequence of the connectedness of T' . One has $\lambda = \mu^{-1}$. □

The previous lemma permits us to define a map

$$\varphi : \pi_0(\overline{S' \setminus S}) \rightarrow \pi_0(\overline{S' \setminus S})$$

as follows. Take a component $c \in \pi_0(\overline{S' \setminus S})$. One knows that $c \cap S = c \cap \partial_N S$ is connected. Since $f(S) \subset S'$ and $f(\partial_N S) \cap S = \emptyset$, one deduces that $f(c \cap \partial_N S)$ is contained in a connected component $\varphi(c) \in \pi_0(\overline{S' \setminus S})$.

Proposition 2.5.6. *The spectrum equivalence class of $h_1(f, X)$ is represented by the reduced permutation endomorphism defined by φ .*

Proof. By Lemma 2.2.6 and Proposition 2.5.4, one knows that the induced endomorphism

$$\check{f}_{*,1} : H_1(S', \overline{S' \setminus S})/F_1 \rightarrow H_1(S', \overline{S' \setminus S})/F_1$$

is shift equivalent to $\tilde{f}_{*,1}$ and therefore represents the spectrum equivalence class of the first-homological Conley index of X and f .

From the long exact sequence of homology groups of the pair $(S', \overline{S' \setminus S})$, the homology group $H_1(S', \overline{S' \setminus S})/F_1$ is isomorphic to $\text{im}(\partial_1) = \ker(j_*)$, where

$$\partial_1 : H_1(S', \overline{S' \setminus S}) \rightarrow H_0(\overline{S' \setminus S})$$

is the connecting map and

$$j_* : H_0(\overline{S' \setminus S}) \rightarrow H_0(S')$$

the inclusion-induced map.

Every connected component c of $\overline{S' \setminus S}$ is associated to an element $[c]$ of the homology group $H_0(\overline{S' \setminus S})$, and the set $\{[c]\}_{c \in \pi_0(\overline{S' \setminus S})}$ is a basis. To the map φ is naturally associated a permutation endomorphism u on $H_0(\overline{S' \setminus S})$. Taking $[S']$ as a basis of $H_0(S')$, one has the natural identification $H_0(S') \simeq \mathbb{Q}$. The map j_* sends every $[c]$ onto 1. Observe now that the isomorphism $H_1(S', \overline{S' \setminus S})/F_1 \rightarrow \ker(j_*)$ conjugates $\check{f}_{*,1}$ to the restriction of u to $\ker(j_*)$ which is nothing but the reduced permutation endomorphism defined by φ . \square

The previous proposition proves the first item of Theorem 2.5.1.

2.5.7 Proof IV: Introducing the stable set

Recall that the stable set of f in S is $\Lambda^+ = \bigcap_{k \geq 0} f^{-k}(S)$. Lemma 2.5.5 implies the following:

- every connected component of $S' \setminus \Lambda^+$ that meets a connected component of $\overline{S' \setminus S}$ contains this component.

Notice that every connected component of $S' \setminus \Lambda^+$ contains a unique connected component of $S \setminus \Lambda^+$. Denote $\mathcal{C} = \pi_0(S' \setminus \Lambda^+)$ the set of connected components of $S' \setminus \Lambda^+$ and \mathcal{C}^* the set of components $C' \in \mathcal{C}$ that meet $\overline{S' \setminus S}$. Like in Subsection 2.5.6, one can define a map

$$\Psi : \mathcal{C} \rightarrow \mathcal{C}$$

as follows. Consider a connected component $C' \in \mathcal{C}$ and denote C the unique connected component of $S \setminus \Lambda^+$ contained in C' . Every point in S whose image by f belongs to Λ^+ must be contained in Λ^+ . One deduces that $f(C)$ is included in $S' \setminus \Lambda^+$, hence contained in a unique connected component $\Psi(C') \in \mathcal{C}$. Should C' meet $\overline{S' \setminus S}$, then C' would meet $\partial_N S$ so, by definition, $\Psi(C')$ would also meet $\overline{S' \setminus S}$ because $f(\partial_N S) \subset \overline{S' \setminus S}$. Therefore, \mathcal{C}^* is forward invariant. Observe that, for every $C' \in \mathcal{C}$, there exists $n \geq 0$ such that

- $f^n(C') \cap \overline{(S' \setminus S)} \neq \emptyset$;
- $f^k(C') \cap \overline{(S' \setminus S)} = \emptyset$, if $k < n$.

In particular, $\Psi^k(C') \in \mathcal{C}^*$ for every $k \geq n$.

Proposition 2.5.7. *Suppose that for some $c, c' \in \pi_0(\overline{S' \setminus S})$ we have $\varphi^n(c) \neq \varphi^n(c')$ for any $n \geq 0$. Then, every path in S' which joins c and c' meets Λ^+ .*

Proof. Let γ_0 be a path in S' which joins c and c' . As a 1-cycle in $(S', \overline{S' \setminus S})$, it represents a relative homology class $[\gamma_0] \in H_1(S', \overline{S' \setminus S})$. With the notations introduced in Subsection 2.5.6, one knows that $f_{*,1}^n([\gamma_0]) \neq 0$ for every $n \geq 1$, because

$$\partial_1(\tilde{f}_{*,1}^n([\gamma_0])) = [\varphi^n(c)] - [\varphi^n(c')] \neq 0.$$

By Lemma 2.4.17, one can construct a sequence of relative 1-cycles $\{\gamma_n\}_{n \geq 0}$ of $(S', \overline{S' \setminus S})$ such that

- γ_n represents the class $\tilde{f}_{*,1}^n([\gamma_0])$ and
- $\gamma_{n+1} \subset f(\gamma_n \cap S)$, for every $n \geq 0$.

The sequence $\{f^{-n}(\gamma_n \cap S)\}_{n \geq 0}$ is a decreasing sequence of non-empty compact subsets of γ_0 . Therefore the set $\bigcap_{n \geq 0} f^{-n}(\gamma_n \cap S)$ is not empty, included both in γ_0 and in $\bigcap_{n \geq 0} f^{-n}(S) = \Lambda_+$. \square

Since every $C \in \mathcal{C}$ is pathwise connected, the previous proposition shows that any two components of $\overline{S' \setminus S}$ that are contained in the same component $C \in \mathcal{C}^*$ have equal image under φ^n for sufficiently large n .

Corollary 2.5.8. *The maps φ and $\psi = \Psi|_{\mathcal{C}^*}$ are shift equivalent.*

Proof. The inclusion $\Lambda^+ \subset S$ induces a map $a : \pi_0(\overline{S' \setminus S}) \rightarrow \mathcal{C}^*$ which is onto and semiconjugates φ and Ψ . This last property can be deduced immediately from the following fact: for every component $c \in \pi_0(\overline{S' \setminus S})$, the connected set $f(c \cap \partial_N S)$, which is non-empty, belongs both to $\varphi(c)$ and to $\psi(a(c))$. As seen in Section 2.2, there exists an integer n_0 such that the restriction of φ to $\text{im}(\varphi^{n_0})$ is the permutation induced by φ . The map a being onto, its restriction to $\text{im}(\varphi^{n_0})$ sends $\text{im}(\varphi^{n_0})$ onto $\text{im}(\psi^{n_0})$. Proposition 2.5.7 tells us that the restriction of a to $\text{im}(\varphi^{n_0})$ is one-to-one, which implies that this restriction conjugates $\varphi^{n_0}|_{\text{im}(\varphi^{n_0})}$ to $\psi^{n_0}|_{\text{im}(\psi^{n_0})}$. Consequently, the restriction of ψ to $\text{im}(\psi^{n_0})$ is bijective. This implies that it is the permutation induced by ψ . The permutation induced by φ and ψ being conjugate, φ and ψ are shift equivalent. \square

This corollary proves the third item of Theorem 2.5.1.

2.5.8 Proof V: Gathering all dynamical information closer to the unstable set

Given a neighborhood U of X contained in the interior of S , denote $E_r(U)$ the subspace of $H_r(S', \overline{S' \setminus S})$ generated by the relative r -cycles of $(S', \overline{S' \setminus S})$ that are included in $(S' \setminus \Lambda^+) \cup U$. The space $H_r(S', \overline{S' \setminus S})$ being finite-dimensional, one can choose U such that for every neighborhood V of X contained in U one has $E_r(V) = E_r(U)$.

Proposition 2.5.9. *The space $E_r(U)$ is forward invariant under $\tilde{f}_{*,r}$ and contains the generalized image of $\tilde{f}_{*,r}$.*

Proof. Fix a neighborhood V of X such that U contains V and $f(V)$. Every homology class $\kappa \in E_r(U)$ is represented by a relative cycle σ of $(S', \overline{S' \setminus S})$ included in $(S' \setminus \Lambda^+) \cup V$ because $E_r(V) = E_r(U)$. The class $\tilde{f}_{*,r}(\kappa)$ is represented by a relative cycle of $(S', \overline{S' \setminus S})$ which is included in $f(\sigma \cap S)$. But such set will meet Λ^+ only in $f(V)$ (recall that $f(S \setminus \Lambda^+) \cap \Lambda^+ = \emptyset$) so it is included in $(S' \setminus \Lambda^+) \cup U$. One deduces that $E_r(U)$ is forward invariant.

Let us conclude by proving that it contains the generalized image of $\tilde{f}_{*,r}$. Fix $\kappa \in H_r(S', \overline{S' \setminus S})$ and σ_0 a relative cycle in $(S', \overline{S' \setminus S})$ representing κ . By Lemma 2.4.17, one can construct inductively a sequence of relative cycles $\{\sigma_n\}_{n \geq 0}$ of $(S', \overline{S' \setminus S})$ such that

- σ_n represents $\tilde{f}_{*,r}^n(\kappa)$,
- $\sigma_n \subset f(\sigma_{n-1} \cap S)$.

Consequently, one deduces that $\sigma_n \cap S \subset \bigcap_{0 \leq k \leq n} f^k(S)$. The fact that $\bigcap_{k \in \mathbb{Z}} f^{-k}(S) = X$ implies that $(\bigcap_{0 \leq k \leq n} f^k(S)) \cap \Lambda^+ \subset U$ if n is large enough, hence $\sigma_n \cap \Lambda^+ \subset U$. Therefore, one has $\tilde{f}_{*,r}^n(\kappa) \in E_r(U)$. \square

2.5.9 Proof VI: Higher-dimensional homological decomposition

The space $G_r(U) = E_r(U) + F_r$ is forward invariant and contains both F_r and the generalized image of $\tilde{f}_{*,r}$. Applying Lemma 2.2.6 to the couple $(F_r, G_r(U))$, one knows that $\tilde{f}_{*,r}$ is shift equivalent to $\check{f}_{*,r}$, the induced endomorphism of $G_r(U)/F_r$. We will prove now that $\check{f}_{*,r}$ is dominated by ψ . For every $C \in \mathcal{C}$, write $E_r^C(U)$ for the subspace of $H_r(S', \overline{S' \setminus S})$ generated by the relative r -cycles of $(S', \overline{S' \setminus S})$ that are included in $C \cup U$ and define $G_r^C(U) = E_r^C(U) + F_r$. The set \mathcal{C}^* being finite, one can suppose U small enough to ensure that for every neighborhood V of X contained in U , and every $C \in \mathcal{C}^*$, one has $E_r^C(V) = E_r^C(U)$.

Proposition 2.5.10. *Let us suppose that $r \geq 2$. Then one has a direct sum*

$$G_r(U)/F_r = \bigoplus_{C \in \mathcal{C}^*} G_r^C(U)/F_r.$$

Moreover, for every $C \in \mathcal{C}^*$, one has

$$\check{f}_{*,r}(G_r^C(U)/F_r) \subset G_r^{\psi(C)}(U)/F_r.$$

Proof. Since X is acyclic there exists neighborhoods $W \subset V$ of X contained in U such that the inclusion-induced maps $H_s(W) \rightarrow H_s(V)$ and $H_s(V) \rightarrow H_s(U)$ are trivial for every $s \geq 1$. By hypothesis, $E_r^C(W) = E_r^C(U)$ for every $C \in \mathcal{C}^*$. The proof of Mayer Vietoris formula tells us that

$$E_r(W) = \sum_{C \in \mathcal{C}} E_r^C(W).$$

Indeed, if σ is a relative chain of $(S', \overline{S' \setminus S})$ included in $(S' \setminus \Lambda^+) \cup W$, the decomposition principle tells us that the chain σ is homologous to

$$\sigma = \sum_{i \in I} \sigma_i + \sigma',$$

where σ' is a r -chain in W and where each σ_i is a connected r -chain in $S' \setminus \Lambda^+$ whose boundary may be written

$$\partial\sigma_i = (\partial\sigma_i)^{\overline{S' \setminus S}} + (\partial\sigma_i)^W$$

where $(\partial\sigma_i)^{\overline{S' \setminus S}}$ is a $(r-1)$ -cycle in $\overline{S' \setminus S}$ and $(\partial\sigma_i)^W$ a $(r-1)$ -cycle in W . Of course each cycle σ_i is included in a connected component $C_i \in \mathcal{C}$. The fact that $H_{r-1}(W) \rightarrow H_{r-1}(V)$ and $H_r(V) \rightarrow H_r(U)$ are trivial implies that there exists a r -chain ν_i in V such that $\partial\nu_i = -(\partial\sigma_i)^W$ and a $(r+1)$ -chain ω in U such that $\partial\omega = \sigma' - \sum_{i \in I} \nu_i$. One deduces that σ is homologous in $(S', \overline{S' \setminus S})$ to $\sum_{i \in I} (\sigma_i + \nu_i)$, which implies that its homology class is included in $\sum_{C \in \mathcal{C}} E_r^C(U)$.

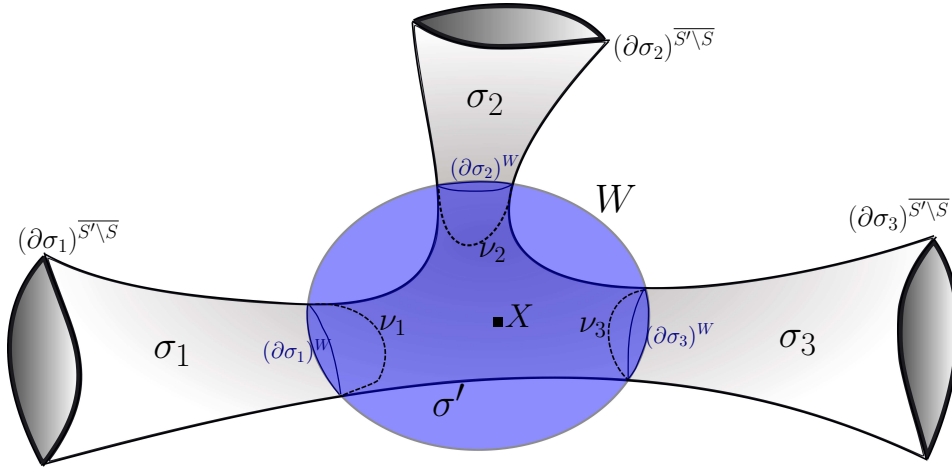

Figure 2.13: Decomposition of σ .

Every space $E_r^C(U)$ being included in F_r if $C \notin \mathcal{C}^*$, one can write

$$G_r(U) = \sum_{C \in \mathcal{C}^*} G_r^C(U).$$

To prove that it is a direct sum, one must prove that for every family $\{\kappa_C\}_{C \in \mathcal{C}^*}$ in $H_r(S', \overline{S' \setminus S})$ such that $\kappa_C \in E_r^C(U)$ and $\sum_{C \in \mathcal{C}^*} \kappa_C \in F_r$, then one has $\kappa_C \in F_r$ for every $C \in \mathcal{C}^*$. Let us consider the connecting map

$$\partial_r : H_r(S', \overline{S' \setminus S}) \rightarrow H_{r-1}(\overline{S' \setminus S})$$

and the inclusion map

$$\iota_r : H_r(S') \rightarrow H_r(S', \overline{S' \setminus S}).$$

Recall that $\text{im}(\iota_r) = \ker(\partial_r)$. We will use the equality

$$H_{r-1}(\overline{S' \setminus S}) = \bigoplus_{C \in \mathcal{C}^*} H_{r-1}((\overline{S' \setminus S}) \cap C),$$

true if $r \geq 2$. We have

$$\sum_{C \in \mathcal{C}^*} \kappa_C \in F_r \implies \sum_{C \in \mathcal{C}^*} \partial_r(\kappa_C) = 0 \implies \partial_r(\kappa_C) = 0 \implies \kappa_C \in \text{im}(\iota_r) \implies \kappa_C \in F_r$$

for every $C \in \mathcal{C}^*$.

A proof similar to the proof of the invariance of $E_r(U)$ gives us

$$\tilde{f}_{*,r}(E_r^C(U)) \subset E_r^{\psi(C)}(U),$$

for every $C \in \mathcal{C}^*$. Indeed, every homology class in $E_r^C(U)$, $C \in \mathcal{C}^*$, is represented by a relative cycle σ included in $C \cup V$ and its image by $\tilde{f}_{*,r}$ is represented by a relative cycle included in $\psi(C) \cup f(V)$, so by a relative cycle included in $\psi(C) \cup U$. \square

This proposition completes the proof of Theorem 2.5.1.

2.6 Further remarks

As said in the introduction, apart from Dold's congruences there are not any more known constraints to the fixed point index sequence of fixed points of homeomorphisms in dimension greater than 3. In [LRS10], an example of a fixed point isolated as an invariant set of a local homeomorphism of \mathbb{R}^4 with an unbounded sequence of fixed point indices was exhibited. Therefore, periodicity is not guaranteed in higher dimensions. A legitimate question is whether there exist any additional obstruction to the fixed point index sequence in dimension 4 or higher apart from Dold's congruences.

Here, in order to give an account on the orientation-reversing 3-dimensional case as complete as possible we present an orientation-reversing analogue of the example constructed in Remark 6 of the aforementioned article. Suppose that T is a 2-torus embedded in S^3 which cuts the 3-sphere in two solid tori, T^+ and T^- . Define an orientation-reversing diffeomorphism h of S^3 such that the maps $h : T^+ \rightarrow T^+$ and $h^{-1} : T^- \rightarrow T^-$ are solenoidal maps of degree $-m$, m a positive integer, which means conjugate to a mapping

$$(\theta, z) \mapsto \left(\theta^{-m}, \frac{1}{2}\theta + \frac{1}{2^{m+1}}z \right)$$

defined on the filled torus $\{\theta \in \mathbb{C}, |\theta| = 1\} \times \{z \in \mathbb{C}, |z| \leq 1\}$. The pair (T^+, T^-) is an attractor/repeller decomposition of S^3 such that

$$i(h^n, T^+) = \text{trace}(h_{*,0}^n) - \text{trace}(h_{*,1}^n) = 1 + (-m)^n.$$

At the end of Subsection 2.5.2 we showed that given a regular attractor/repeller decomposition of the sphere, it is possible to define $g : S^3 \rightarrow \mathbb{R}$ so that the diffeomorphism $f : S^4 \rightarrow S^4$ induced by the skew-product of g and h satisfies:

- e^- is an isolated fixed point.
- Its index by f^n is $i(f^n, e^-) = i(h^n, T^+) = 1 + (-m)^n$.

Consequently, the sequence of indices is unbounded either from below or from above.

Fixed point index drew some attention from the local study of conservative homeomorphisms. If we drop the hypothesis about isolation of the fixed point, it remains true for the planar case that the index of a fixed point is less than or equal to 1 provided that the homeomorphism is area-preserving. This result was proved by Pelikan and Slaminka in [PS87]. Previously, Nikishin and Simon had addressed the same question

for diffeomorphisms, see [Ni74] and [Si74]. However, the analogue statement referred to orientation-reversing local homeomorphisms of \mathbb{R}^3 does not hold, as the following example shows.

Let l be a positive integer and define $f(z) = z + z^l$, a local diffeomorphism of the complex plane in a neighborhood U of the origin. In Subsection 2.2.1 we proved that the fixed point index of f at the origin is l . The map

$$g : (z, t) \mapsto \left(f(z), \frac{-t}{|f'(z)|} \right)$$

defined in $U \times [-1, 1]$ is a local diffeomorphism of \mathbb{R}^3 using the usual identification of $\mathbb{C} \sim \mathbb{R}^2$. The Jacobian of g is equal to 1, hence it preserves volume. Since f preserves orientation, g is orientation-reversing. The origin, 0, is the unique fixed point of g and its index can be computed easily because g is isotopic to the map $(z, t) \mapsto (f(z), -t)$ through an isotopy $\{g_\lambda\}_{\lambda=0}^1$ defined as:

$$g_\lambda(z, t) = \left(f(z), \frac{-t}{(1-\lambda)|f'(z)| + \lambda} \right).$$

This isotopy does not create extra fixed points in $U \times [-1, 1]$ because the origin is the unique fixed point of g_λ for any $\lambda \in [0, 1]$. Then,

$$i(g, 0) = i(g_0, 0) = i(g_1, 0) = i(f, 0) \cdot i(s, 0) = l,$$

where

$$s = -\text{id} : [-1, 1] \rightarrow [-1, 1].$$

The fixed point indices computations for the maps f and s were explained in Subsection 2.2.1.

In order to show that the previous construction is not of local nature, that is, there is no obstruction to extend the local dynamics to a global one, we present another example. We define an orientation-reversing conservative homeomorphism of S^3 with only one fixed point, whose fixed point index is equal to 2, the Lefschetz number of the map. Let us start with the following lemma.

Lemma 2.6.1. *Let B be the closed unit ball in \mathbb{R}^3 and denote its boundary by S^2 . Given any diffeomorphism $f : S^2 \rightarrow S^2$, there exists a diffeomorphism $g : B \rightarrow B$ which extends f , $g|_{S^2} = f$, and preserves the Lebesgue measure of B .*

Before we prove the lemma, let us show how the construction works.

1. Take an orientation-preserving diffeomorphism $f : S^2 \rightarrow S^2$ with only one fixed point, which must have index 2. For instance, take the extension the map $z \mapsto z + z^2$ to the Riemann sphere and remove the fixed point at ∞ via a local perturbation.
2. Use the lemma to obtain a conservative diffeomorphism g of B .
3. The sphere S^3 is composed of two closed 3-balls glued by their boundary. Let s denote the inversion in the sphere which swaps the balls and keeps their common boundary pointwise fixed. Define $h : S^3 \rightarrow S^3$ by setting $h = s \circ g$ within each 3-ball. Then h is the desired homeomorphism.

It is straightforward to check that h satisfies the required properties. It reverses orientation because g preserves it and s is a symmetry. Every fixed point of h must lie in the boundary of the glued balls, so it is a fixed point of f . Thus, $\text{Fix}(h)$ is a single point. The map h preserves in S^3 the measure μ defined by the Lebesgue measure in each of the two balls as subspaces of \mathbb{R}^3 . Evidently, μ is equivalent to the Lebesgue measure of S^3 as a subspace of \mathbb{R}^4 . If we normalize both measures induced in S^3 , Oxtoby-Ulam's Theorem [OU41] provides a homeomorphism $\phi : S^3 \rightarrow S^3$ such that $\phi \circ h \circ \phi^{-1}$ preserves the Lebesgue measure.

Proof of Lemma 2.6.1. We divide the proof in steps. Let V be a small open neighborhoods of S^2 in B .

Step 1: There is a diffeomorphic extension $\bar{f} : V \rightarrow \bar{f}(V) \subset B$ of f which is conservative in W , i.e., preserves Lebesgue measure in W , where $W \subset V$ is a small neighborhood of S^2 in B .

Step 2: Extend \bar{f} to a diffeomorphism on B , which may fail to be conservative outside W .

Step 3: Let λ be the Lebesgue measure in B and we define μ , with $\mu(A) = \lambda(\bar{f}^{-1}(A))$ for every Borel set $A \subset B$. Clearly, $\lambda(B) = \mu(B)$ and both measures coincide in W .

Step 4: Both measures μ and λ are non-atomic and positive for open sets and satisfy $\mu(S^2) = \lambda(S^2) = 0$. By Oxtoby-Ulam's Theorem there exists a homeomorphism $\phi : B \rightarrow B$ such that $\phi|_{S^2} = id$ and

$$\phi_*\mu = \lambda.$$

In other words, $\lambda(A) = \mu(\phi^{-1}(A)) = \lambda(\bar{f}^{-1} \circ \phi^{-1}(A))$ by definition of μ . Define $g = \phi \circ \bar{f}$ and the proof is finished. \square

2.7 Local zeta function

The information contained in the fixed point index of f^n for all $n \geq 1$ or, in other words, in the Lefschetz numbers of the maps f^n is synthesized in the Lefschetz zeta function, which is a formal power series.

Definition 2.7.1. *Let f be a local map of \mathbb{R}^d and p a fixed point for f which is isolated as a fixed point. The local Lefschetz zeta function of f at p is*

$$\mathcal{Z}_f^p(t) = \exp \left(\sum_{n=1}^{\infty} \frac{i(f^n, p)t^n}{n} \right).$$

If f is a map in a compact manifold, the (global) Lefschetz zeta function of f is

$$\mathcal{Z}_f(t) = \exp \left(\sum_{n=1}^{\infty} \frac{i(f^n)t^n}{n} \right).$$

Using Lefschetz Theorem we can replace $i(f^n)$ by $\Lambda(f^n)$ in the definition of \mathcal{Z}_f . Denote $\text{Per}(f)$ the set of periodic points of f . The identity of formal power series

$$\mathcal{Z}_f(t) = \prod_{p \in \text{Per}(f)} \mathcal{Z}_f^p(t) \tag{2.14}$$

follows from the fact that $i(f^n) = \sum_{f^n(p)=p} i(f^n, p)$ provided that the number of periodic points of any period is finite. Notice that the right hand side of the previous equation will be well-defined even though the total number of periodic points is infinite.

Our results can be applied to obtain descriptions of $\mathcal{Z}_f^p(t)$ for fixed points which are isolated as invariant sets and maps in dimension 2 and 3. In particular, Theorem 2.3.1 allows to partially answer the question raised in [Fri83] wondering whether the local Lefschetz zeta function at a fixed point is rational, provided that it is isolated in the set of periodic points.

The computation of the local zeta function is easy once we realize that any sequence $\{i(f^n, p)\}_{n \geq 1}$ satisfies Dold's congruences. Consequently, the sequence is an integer combination, possibly infinite, of the normalized sequences σ^k . Each of these sequences contributes to a factor in the zeta function. Note that $\sigma_n^k = \sum_{\omega^k=1} \omega^n$, hence

$$\exp \left(\sum_{n \geq 1} \frac{\sigma_n^k}{n} t^n \right) = \prod_{\omega^k=1} \exp \left(\frac{(\omega t)^n}{n} \right) = \prod_{\omega^k=1} \frac{1}{1 - \omega t} = \frac{1}{1 - t^k}.$$

The following proposition contains the information relative to dimension 2 and fixed points isolated as invariant sets.

Proposition 2.7.2. *The local Lefschetz zeta function of a fixed point p isolated as an invariant set and a local continuous map f in \mathbb{R}^2 is:*

- If p is a sink,

$$\mathcal{Z}_f^p(t) = \frac{1}{1 - t}.$$

- If p is a source such that $i(f, p) = d$,

$$\mathcal{Z}_f^p(t) = \frac{1}{1 - dt}.$$

- Otherwise,

$$\mathcal{Z}_f^p(t) = \frac{1}{1 - t} \prod_{k \in F} (1 - t^k)^{a_k},$$

for a finite subset $F \subset \mathbb{N}$ and some positive integers a_k , $k \in F$.

Proof. Since the fixed point index sequence is equal to σ^1 for sinks, that is, constant equal to 1, the zeta function is equal to $\frac{1}{1-t}$.

Similarly, if p is neither a sink nor source, Theorem 2.3.1 shows that the sequence $\{i(f^n, p)\}_{n \geq 1}$ is equal to $\sigma^1 - \sum_{k \in F} a_k \sigma^k$. Thus, \mathcal{Z}_f is the product of the factors corresponding to each normalized sequence σ^k .

Finally, if p is a source then we showed in Subsection 2.2.7 that $i(f^n, p) = d^n$ for an integer $d = i(f, p)$. Thus

$$\mathcal{Z}_f^p(t) = \exp \left(\sum_{n \geq 1} \frac{d^n}{n} t^n \right) = \frac{1}{1 - dt}.$$

□

The local Lefschetz zeta function can be characterized as well for local homeomorphisms of \mathbb{R}^3 .

Proposition 2.7.3. *The local Lefschetz zeta function of a fixed point p isolated as an invariant set and a local homeomorphism f in \mathbb{R}^3 is:*

- If f is orientation-preserving then

$$\mathcal{Z}_f^p(t) = \prod_{k \in F} (1 - t^k)^{a_k},$$

for a finite subset $F \subset \mathbb{N}$ and some integers $a_k, k \in F$.

- If f is orientation-reversing then,

$$\mathcal{Z}_f^p(t) = \frac{1}{1-t} \prod_{k \in F} (1 - t^k)^{a_k},$$

for a finite subset $F \subset \mathbb{N}$ and some integers $a_k, k \in F$, which must be positive for odd k .

Proof. It is a consequence of the formulas for the fixed point index sequence obtained in Corollary 2.1.7 and in Theorem 2.1.8. \square

The power of the Lefschetz zeta function lies in the fact that it contains all the information about fixed point indices. Consequently, any argument which just involves fixed point index considerations can be rewritten using the zeta function. As an example, let us prove the non-existence of minimal homeomorphisms of the finitely punctured 2-sphere, theorem originally due to Le Calvez and Yoccoz and contained in [LY97], and also give a second proof of Corollary 2.1.9, which showed that there are no orientation-reversing minimal homeomorphisms of \mathbb{R}^3 . Recall that a homeomorphism is said to be *minimal* if every orbit is dense or, equivalently, there exists no proper closed invariant set.

Lemma 2.7.4. *Let $P(x), Q(x) \in \mathbb{Z}[x]$ be two polynomials defined by a finite product of monomials of the form $(1 - x^n)$ where $n \in \mathbb{N}$. Then, $P = Q$ if and only if every possible monomial $(1 - x^n)$ appears in P and Q the same number of times.*

Proof. Assume that $P = Q$ and let $(1 - x^n)$ be the monomial with higher power appearing in P and Q . Take $x = \zeta$ to be a primitive n -th root of unity. Since the multiplicity of ζ as a root of P must be equal to the multiplicity as a root of Q and ζ is a root only for the monomial $(1 - x^n)$ among all in P and Q , we must have that $(1 - x^n)$ appears the same number of times, r , in P than in Q . Now, divide both polynomials by $(1 - x^n)^r$ and use the same argument. Finally, we arrive at the trivial identity $1 = 1$ and the conclusion of the lemma follows, the other direction being totally obvious. \square

The previous naive lemma will allow us to arrive at a contradiction when we substitute in Equation 2.14 the expressions obtained in Propositions 2.7.2 and 2.7.3.

Theorem 2.7.5 (Le Calvez-Yoccoz). *There are no minimal homeomorphisms of the finitely punctured 2-sphere.*

Proof. Assume on the contrary that f is a minimal homeomorphism of $S^2 \setminus \{p_1, \dots, p_k\}$ and extend it to a homeomorphism $\hat{f} : S^2 \rightarrow S^2$. Every point p_i is periodic for \hat{f} , hence there exists n such that $\hat{f}^n(p_i) = p_i$ for every $1 \leq i \leq k$. If n is odd multiply it by 2. Since f is minimal, all fixed points p_i of \hat{f}^n are isolated as invariant sets.

The zeta function of the orientation-preserving homeomorphism \hat{f}^n of the 2-sphere equals $\mathcal{Z}_{\hat{f}^n}(t) = \frac{1}{(1-t)^2}$. The only fixed points of \hat{f}^n are p_1, \dots, p_k and their local zeta function is equal to

$$\mathcal{Z}_{\hat{f}^n}^{p_i}(t) = \frac{(1-t^q)^r}{1-t},$$

where each $r \geq 1$. Use now Equation 2.14 and make the cross product to eliminate denominators. We obtain on one side $(1-t)^k$ and on the other side the product of at least $k+2$ monomials, from which a contradiction is derived using Lemma 2.7.4. \square

To conclude, we prove Corollary 2.1.9, which shows that there are no minimal orientation-reversing homeomorphisms of \mathbb{R}^3 , using Lefschetz zeta function.

Proof of Corollary 2.1.9. Assume f is minimal and extend it to a homeomorphism \hat{f} of S^3 by fixing the point at ∞ . The Lefschetz number of the map \hat{f}^n is 2 if n is odd because \hat{f} reverses orientation and 0 if n is even, hence the zeta function of \hat{f} is $\mathcal{Z}_{\hat{f}}(t) = \frac{1-t^2}{(1-t)^2}$. However, the local zeta function of \hat{f} at the fixed point at ∞ must be of the form described in Proposition 2.7.3. Equation $\mathcal{Z}_{\hat{f}}(t) = \mathcal{Z}_{\hat{f}}^{\infty}(t)$ can not hold because the monomial $(1-t)$ appears twice in the denominator on the left side and only once in the right side, so Lemma 2.7.4 gives a contradiction. \square

Bibliography

- [Al12] B. Alarcón, *Rotation numbers for planar attractors of equivariant homeomorphisms*, to appear in *Topol. Methods Nonlinear Anal.*
- [AGG07] B. Alarcón, V. Guíñez, C. Gutierrez, *Planar embeddings with a globally attracting fixed point*, *Nonlinear Anal.* **69** (2008), 140-150.
- [AY92] K.T. Alligood, J.A. Yorke, *Accessible saddles on fractal basin boundaries*, *Ergod. Th. Dynam. Sys.* **12** (1992), 377-400.
- [AP92] D.K. Arrowsmith, C.M. Place, *An Introduction to Dynamical Systems*, Cambridge University Press, Cambridge, 1992.
- [BB92] I.K. Babenko, S.A. Bogatyí, *The behavior of the index of periodic points under iterations of a mapping*, *Math. USSR Izvestiya*, **38** (1992), 1-26.
- [Ba93] M. Barge, *Prime end rotation numbers associated with the Hénon map*. *Continuum theory and dynamical systems*, 15-33, *Lecture Notes in Pure and Appl. Math.*, 149, Dekker, New York, 1993.
- [BG91] M. Barge, R.M. Gillette, *Rotation and periodicity in plane separating continua*, *Ergodic Theory Dynam. Systems* **11** (1991), no. 4, 619-631.
- [BG92] M. Barge, R.M. Gillette, *A fixed point theorem for plane separating continua*, *Topology Appl.* **43** (1992), no. 3, 203-212.
- [BaK98] M. Barge, K. Kuperberg, *Periodic points from periodic prime ends*, *Proceedings of the 1998 Topology and Dynamics Conference (Fairfax, VA)*, vol. 23, 1998, 13-21.
- [Be76] H. Bell, *A fixed point theorem for planar homeomorphisms*, *Bull. Amer. Math. Soc.* **82** (1976), 778-780.
- [BL96] J. Bernat, J. Llibre, *Counterexample to Kalman and Markus - Yamabe conjectures in dimension 4*, *Dynamics of Continuous, Discrete and Impulsive Systems* **1** (1996).
- [Bi32] G.D. Birkhoff, *Sur quelques courbes fermées remarquables*, *Bull. Soc. Math. de France* **60** (1932), 1-26.
- [BoK98] C. Bonatti, B. Kolev, *Surface homeomorphisms with zero-dimensional singular set*, *Topology Appl.* **90** (1998), 69-95.

- [Bo02] M. Bonino, *Lefschetz index for orientation reversing planar homeomorphisms*, Proc. Amer. Math. Soc. **130** (2002), no. 7, 2173-2177.
- [Bo04] M. Bonino, *A Brouwer-like theorem for orientation reversing homeomorphisms of the sphere*, Fund. Math. **182** (2004), no. 1, 1-40.
- [Br60] M. Brown, *A Proof of the Generalized Schoenflies Theorem*, Bull. Amer. Math. Soc. **66** (1960), 74-76.
- [Br84] M. Brown, *A new proof of Brouwer's lemma on translation arcs*, Houston J. Math. **10** (1984), 35-41.
- [Br12] L.E.J. Brouwer, *Beweis des ebenen Translationssatzes*, Math. Ann. **72** (1912), 37-54.
- [Ca13] C. Carathéodory, *Über die Begrenzung einfach zusammenhängender Gebiete*, Math. Ann. **73** (1913) 323-370.
- [CL54] M.L. Cartwright, J.E. Littlewood, *Some fixed point theorems*, Annals of Math. **54** (1951), 1-37.
- [CMY83] S. N. Chow, J. Mallet-Paret, J. A. Yorke, *A periodic orbit index which is a bifurcation invariant*, Geometric Dynamics (Rio de Janeiro, 1981), Lecture Notes in Math. **1007**, Springer, Berlin, (1983), 261-293.
- [CE⁺95] A. Cima, A. van den Essen, A. Gasull, E. Hubbers, F. Mañosas, *A polynomial counterexample to the Markus - Yamabe Conjecture*, Nijmegen Report **9551** (1995), 1-4.
- [CGM99] A. Cima, A. Gasull, F. Mañosas, *The discrete Markus - Yamabe problem*, Non-linear Anal. **35** (1999) 343-354.
- [CLo66] E. F. Colingwood, A. J. Lohwater, *The Theory of Cluster sets*, Cambridge Univ. Press, Cambridge, 1966.
- [Co78] C. Conley, *Isolated invariant sets and the Morse index*, CBMS Reg. Conf. Ser. in Math., **38**. AMS, Providence, (1978).
- [De32] A. Denjoy, *Sur les courbes définies par les équations différentielles à la surface du tore*. J. Math. Pures Appl. **11** (1932), 333-375.
- [DS78] J. Dydak, J. Segal, *Shape Theory: An Introduction*, Lecture Notes in Math., vol. 688, Springer-Verlag, Berlin, (1978).
- [Do72] A. Dold, *Lectures on Algebraic Topology*, Springer, Berlin-Heidelberg-New York, (1972).
- [Do83] A. Dold, *Fixed point indices of iterated maps*, Invent. Math. **74** (1983), 419-435.
- [Ea89] R. Easton, *Isolating blocks and epsilon chains for maps* Physica D **39** (1989), no. 1, 95-110.

- [FL100] N. Fagella, J. Llibre, *Periodic points of holomorphic maps via Lefschetz numbers*, Trans. Amer. Math. Soc., **352** (2000), 4711-4730.
- [FH77] A. Fathi, M. Herman, *Existence de difféomorphismes minimaux*, Astérisque, **49** (1977), 37-59.
- [Fr77] J. Franks, *Some Smooth Maps with Infinitely Many Hyperbolic Periodic Points*, Trans. Am. Math. Soc., **226** (1977), 175-179.
- [Fr85] J. Franks, *Period doubling and the Lefschetz formula*, Trans. Am. Math. Soc. **287** (1985), no. 1, 275-283.
- [Fr99] J. Franks, *The Conley index and non-existence of minimal homeomorphisms*, Illinois J. Math. Soc. **43** (1999), no. 3, 457-464.
- [FR00] J. Franks, D. Richeson, *Shift equivalence and the Conley index*, Trans. Amer. Math. Soc. **352** (2000), no. 7, 3305-3322.
- [Fri83] D. Fried, *Periodic points and twisted coefficients*, Geometric Dynamics (Rio de Janeiro, 1981), Lecture Notes in Math. **1007**, Springer, Berlin, (1983), pp. 261-293.
- [GN03] G. Graff, P. Nowak-Przygodzki, *Fixed point indices of iterations of planar homeomorphisms*, Topol. Methods Nonlinear Anal., **22** (2003), no. 1, 159-166.
- [GN06] G. Graff, P. Nowak-Przygodzki, *Fixed point indices of iterations of C^1 -maps in \mathbb{R}^3* , Discrete Contin. Dyn. Syst. **16** (2006), 843-856.
- [GNR11] G. Graff, P. Nowak-Przygodzki, F.R. Ruiz del Portal, *Local fixed point indices of iterations of planar maps*, J. Dynam. Differ. Equat. **23** (2011), no. 1, 213-223.
- [GD03] A. Granas, J. Dugundji, *Fixed point theory*, Springer Monographs in Mathematics, New York, 2003.
- [GL108] J.L.G. Guirao and J. Llibre, *Periods for the Morse-Smale diffeomorphisms on S^2* , Colloq. Math. **110** (2008), no. 2, 477-507.
- [Gu95] C. Gutierrez, *A solution to the bidimensional Global Asymptotic Stability Conjecture*, Ann. Inst. H. Poincaré Anal. Non Linéaire **12** (1995), 627-671.
- [Hal88] J.K. Hale, *Asymptotic behavior of dissipative systems*. Mathematical Surveys and Monographs, 25. American Mathematical Society, Providence, RI, 1988.
- [Ha82] M. Handel, *A pathological area preserving C^∞ diffeomorphism of the plane*, Proc. Amer. Math. Soc. **86** (1982), no. 1, 163-168.
- [Ha92] M. Handel, *There are no minimal homeomorphisms of the multipunctured plane*, Ergod. Th. and Dynam. Sys. **12** (1992), 75-83.
- [HCR13] L. Hernández-Corbato, P. Le Calvez, F. R. Ruiz del Portal, *About the homological Conley index of invariant acyclic continua*, submitted.

- [HOR12] L. Hernández-Corbato, R. Ortega and F. R. Ruiz del Portal, *Attractors with irrational rotation number*, Math. Proc. Camb. Phil. Soc. **153** (2012), 59-77.
- [Ho53] T. Homma, *An extension of the Jordan Curve Theorem*, Yokohama Math. J. **1** (1953), 125-129.
- [Hu65] S. T. Hu, *Theory of retracts*, Wayne State Univ. Press, Detroit, 1965.
- [JM05] J. Jezierski, W. Marzantowicz *Homotopy methods in topological fixed and periodic points theory, topological fixed point theory and its applications*, 3. Springer, Dordrecht (2005).
- [Ke76] J. Keesling, *On the Whitehead theorem in shape theory*, Fund. Math. **92** (1976) 247-253.
- [Ke34] B. Kerékjártó, *Sur le caractère topologique des représentations conformes*, C.R. Acad. Sci. **198** (1934), 317-320.
- [KLN12] A. Koropecski, P. Le Calvez, M. Nassiri, *Prime ends rotation numbers and periodic points*, preprint, arXiv:1206.4707.
- [L99] P. Le Calvez, *Une propriété dynamique des homéomorphismes du plan au voisinage d'un point fixe d'indice > 1* , Topology **38** (1999), no. 1, 23-35.
- [LRS10] P. Le Calvez, F.R. Ruiz del Portal, J.M. Salazar, *Fixed point indices of the iterates of R^3 -homeomorphisms at fixed points which are isolated invariant sets*, J. London Math. Soc. **82** (2010), no. 2, 683-696.
- [LY97] P. Le Calvez, J.C. Yoccoz, *Un théorème d'indice pour les homéomorphismes du plan au voisinage d'un point fixe*, Annals of Math. **146** (1997), 241-293.
- [LY] P. Le Calvez, J.C. Yoccoz, *Suite des indices de Lefschetz des itérés pour un domaine de Jordan qui est un bloc isolant*, Unpublished.
- [LR10] F. Le Roux, *Un indice qui affine l'indice de Poincaré-Lefschetz pour les homeomorphismes de surfaces*, Ann. of Math. (2) **171** (2010), 1531-1589.
- [Le48] N. Levinson, *Transformation theory of non-linear differential equations of the second order*, Ann. of Math. **45** (1944), 723-737. Addendum: Ann. of Math. **49** (1948) 738.
- [MS82] S. Mardešić, J. Segal, *Shape theory*, North-Holland, Amsterdam, 1982.
- [Ma70] N.G. Markley, *Homeomorphisms of the circle without periodic points*, Proc. London Math. Soc. **20** (1970), 688-698.
- [MY60] L. Markus, H. Yamabe, *Global Stability Criteria for Differentiable Systems*, Osaka Math. J. **12** (1960), 305-317.
- [MW07] W. Marzantowicz, K. Wojcik, *Periodic segment implies infinitely many periodic solutions*, Proc. Amer. Math. Soc. **135** (2007), no. 8, 2637-2647.

- [Ma82] J.N. Mather, *Topological proofs of some purely topological consequences of Carathéodory's theory of prime ends*. Selected Studies. North Holland Publis. Co Eds. Th.M. Rassias, G.M. Rassias (1982), 225-255.
- [Mat13] S. Matsumoto, *Nontrivial attractor-repeller maps of S^2 and rotation numbers*, preprint, [arXiv:1302.4041](https://arxiv.org/abs/1302.4041).
- [MN11] S. Matsumoto, H. Nakayama, *Continua as minimal sets of homeomorphisms of S^2* , Enseigne. Math. **57** (2011), 373-392.
- [Ma81] D. Mauldin, *The Scottish Book*, Birkhauser-Boston, Boston, Mass. (1981).
- [MS93] W. de Melo, S. van Strien, *One-dimensional Dynamics*, Ergeb. Math. Grenzgeb. (3) **25**, Springer, Berlin, 1993.
- [Mil06] J. Milnor, *Dynamics in one complex variable*, 3rd ed., Annals of Mathematics Studies, vol. 160, Princeton University Press, Princeton, NJ, 2006.
- [MM02] K. Mischaikow, M. Mrozek, *Conley index*. In B. Fiedler (Ed.), *Handbook of Dynamical Systems*, North-Holland, Volume **2** (2002), 393-460.
- [Mr90] M. Mrozek, *Leray Functor and Cohomological Conley Index for Discrete Dynamical Systems*, Trans. Am. Math. Soc. **318** (1990), no. 1, 149-178.
- [Mr89] M. Mrozek, *Index pairs and the fixed point index for semidynamical systems with discrete time*, Fund. Math **133** (1989), no. 3, 179-194.
- [Ni74] N.A. Nikishin, *Fixed points of diffeomorphisms of two-dimensional spheres preserving an oriented plane*, Funktsional Anal. i Prelozen **8** (1974), 84-85.
- [OR11] R. Ortega, F.R. Ruiz del Portal, *Attractors with vanishing rotation number*, J. Eur. Math. Soc. **13**, no. 6, 1569-1590.
- [OU41] J. C. Oxtoby, S. M. Ulam, *Measure-preserving homeomorphisms and metrical transitivity*, Annals of Math. (2) **42** (1941), 874-920.
- [PS87] S. Pelikan, E. Slaminka, *A bound for the fixed point index of area-preserving homeomorphisms of two-manifolds*, Ergodic Theory Dynam. Systems **7** (1987), no. 3, 463-479.
- [Po92] Ch. Pommerenke, *Boundary behaviour of conformal maps*, Lecture Notes in Math., Springer-Verlag, New York, 1992.
- [RW02] D. Richeson, J. Wiseman, *A fixed point theorem for bounded dynamical systems*, Illinois Journal of Mathematics, **46** (2002), no. 2, 491-495, addendum, **48** (2004), no. 3, 1079-1080.
- [RS88] J. Robbin, D. Salamon, *Dynamical systems, shape theory and the Conley index*, Ergodic Theory Dynam. Systems **8*** (1988), 375-393.
- [RS02] F.R. Ruiz del Portal, J.M. Salazar, *Fixed point index of iterations of local homeomorphisms of the plane: a Conley-index approach*, Topology **41** (2002), 1199-1212.

- [RS05] F.R. Ruiz del Portal, J.M. Salazar, *A stable/unstable manifold theorem for local homeomorphisms of the plane*, Ergodic Theory Dynam. Systems **25** (2005), no. 1, 301-317.
- [SG08] J. Sánchez-Gabites, *Aplicaciones de la topología geométrica y algebraica al estudio de flujos continuos en variedades*. Ph.D. Dissertation. Universidad Complutense de Madrid, 2008.
- [SG11] J. Sánchez-Gabites, *How strange can an attractor for a dynamical system in a 3-manifold look?*, Nonlinear Anal. Theory Methods Appl. **74** (2011), 6162-6185.
- [ST80] H. Seifert, W. Threlfall, *Seifert and Threlfall: A Textbook of Topology*, Academic Press, New York, 1980.
- [Si74] C. Simon, *A bound for the fixed-point index of an area-preserving map with applications to mechanics*, Invent. Math. **26** (1974), 187-200.
- [Sz98] A. Szymczak, *A cup product pairing and time-duality for discrete dynamical systems*, Topology **37** (1998), 1299-1311.
- [Sz95] A. Szymczak, *The Conley index for discrete semidynamical systems*, Topol. Appl. **66** (1995), 215-240.
- [SS74] M. Shub, D. Sullivan, *A remark on the Lefschetz fixed point formula for differentiable maps*, Topology **13** (1974), 189-191.
- [W91] R. Walker, *Periodicity and decomposability of basin boundaries with irrational maps on prime ends*, Trans. Amer. Math. Soc. **324** (1991), no. 1, 303-317.