

Power Production via North Sea Hot Brines

Alison Auld^a, Simon Hogg^a, Arganthaël Berson^a, Jon Gluyas^{b,*}

^a*Engineering and Computing Sciences, Durham University, South Road, Durham, DH1 3LE, UK*

^b*Department of Earth Sciences, Durham University, South Road, Durham, DH1 3LE, UK*

Abstract

Traditionally the power demand of offshore oil platforms is delivered by on-platform gas turbines. Natural gas to fuel these turbines is usually separated from the produced oil. However, in aging fields as oil production declines so does the associated gas. Ultimately gas supply becomes insufficient; in order to continue producing fuel is imported at great expense. This study proposes the power demand of a platform could be met or supplemented by an on-platform Organic Rankine Cycle (ORC) fuelled by coproduced hot brines. This could extend the operating life of oil platforms and reduce both cost and emissions. The potential power output of an ORC is modelled for fields in the North Sea's Brent Province. Results show 6 fields have the potential to generate more than 10 MW via an organic Rankine cycle fuelled by hot brines, with a maximum of 31 MW predicted for the Ninian field. Analysis of simulations for the Eider field shows that ORC plants can scale to size constraints. The cost of a 10 MW ORC is compared to cost of continued use of gas turbines. Payback times of between 3.09 and 4.53 years are predicted for an ORC, without accounting for greenhouse gas emissions levies.

Keywords: Organic Rankine Cycle, North Sea, Coproduced hot brines

1. The problem of power supply in oil fields

Traditionally the power demand of offshore oil platforms is met by gas turbines installed on the platform [1]. Natural gas to power these turbines is conventionally available from the produced oil; pressure is lowered in the separator and the

*Corresponding author

Email address: jon.gluyas@durham.ac.uk (Jon Gluyas)

exsolved gas extracted. Some or all of this is then used to generate power. The biggest power demand comes from the pumps used to inject water and so sustain oil production. However there are three key reasons why considering alternative ways of meeting an offshore platforms energy requirement is desirable.

Firstly conventional power generation methods, via gas turbines, are not always possible. Over the life time of a producing field the rate of oil production will decline and as a consequence associated gas production will also decline. Ultimately the gas exsolved from the oil may become insufficient to supply the gas turbines that generate the power for the platform. Once too little gas is produced to meet the requirements of the platform, gas has to be imported to allow the platform to keep producing. However, this is an expensive solution and operating life of the platform becomes a function of the cost of importing gas against the profit from production. The platform will shut down when operating expenditure (including the cost of gas import) makes production uneconomical [2].

Secondly, there is increasing pressure to decrease emissions of GreenHouse Gases (GHGs). Oil production on offshore platforms produces significant volumes of GHGs from various processes, including electricity generation via gas turbines. For example, GHG emissions from oil and gas extraction in Norway accounted for 26 % of all Norway's GHG emissions in 2012 [3]. Different countries limit and tax carbon emissions in different ways, but increasingly emission of GHGs results in significant financial penalties. Thus there is a clear economic driver for the industry to reduce GHG emissions of on-platform power production.

Lastly, increasing operating costs and depleting oil fields mean operating efficiently is of increasing importance. An inefficient process on an offshore platform may use an unnecessary large amount of gas which might otherwise be sold, and will also incur a cost for the associated GHG emissions. Nguyen et al. consider the thermodynamic efficiency of each process on a typical North Sea oil and gas platform [4]. Efficiency is considered in terms of exergy destruction [5]. Exergy is the maximum theoretical work that can be extracted from a system and is destroyed by inefficiencies in processes. So, to maximise thermodynamic efficiency, exergy destruction should be minimised. Nguyen et al. show power generation is the largest source of exergy destruction by a factor larger than 2 when compared with other processes on a platform. Therefore, there is a strong driver to improve the efficiency of electric power production on offshore platforms.

Cost penalties, requirements to reduce GHG emissions, the inefficiency of current power production and dwindling gas supply; raise the question of how best to meet the electricity demands of offshore platforms. Several alternative

methods for supplying power to offshore platforms have been proposed, but gas turbines remain the primary source of power for most platforms.

In some situations a direct electrical connection to a platform from the shore may be feasible. An example is one of the world's largest offshore platforms, Troll A 65 km west of Bergen, Norway, as described by Stendus and Jones [6]. Troll A is connected to the mainland by two parallel 40 MW connections using High Voltage Direct Current (HVDC) transmission technology to the 132 kW mainland grid. Stendus and Jones [6] identify the main motivation for installing a direct electrical connection as being to 'reduce cost and emissions'. The cost of the CO₂ emissions is cited as being considerable and therefore an electrical connection is economically feasible despite Troll A producing plenty of gas to power its gas turbines. However, Stendus and Jones acknowledge the significant challenges of engineering offshore networks. Offshore electrical networks are expensive and the cost increases significantly with the distance from the shore.

Other network based solutions to offshore power supply include inter-platform networks and integration of offshore wind turbines. In regions where some wells produce excess gas while others do not produce enough gas to generate enough electricity inter-platform networks exist. For example there is a 33 kV connection between Dunlin Alpha and Brent Charlie [7]. Excess gas production means extra power production capability, surplus electricity is then transported via an inter-platform network to allow depleting wells to continue producing. It has also been proposed in the literature that offshore wind turbines might be able to supply power to platforms, for example by Marvik et al. [8]. This would further reduce emissions penalties as the electricity supply would then be GHG free. Marvike et al. [8] simulated four interconnected platforms with integrated wind farms. This study identifies challenges in maintaining a stable network if a fault occurs, but predicts it will be feasible in the future to integrate offshore wind farms that are local to platforms requiring additional power. Clearly, an issue with power supply from wind is availability. An alternative method of power generation must also be available if a continual power supply is to be guaranteed.

Several authors describe the evolution of large off-shore grids as inevitable, e.g. Vrana et al. [9]. This is due mainly to the large scale deployment of offshore wind turbines and the need to trade electricity between countries. Figure 1 compares the distributions of oil and gas platforms with wind farms in the North Sea. The figure shows regions where oil and gas platforms are far from land and the locations of offshore wind farms. The feasibility of network based power

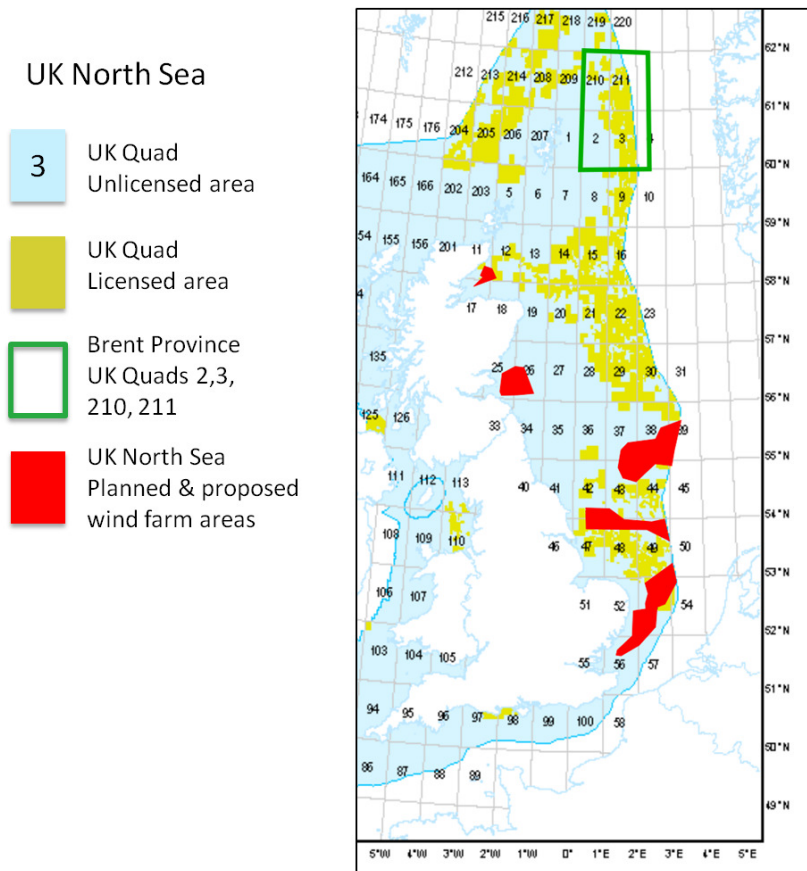

Figure 1: Position of both built and proposed wind farms and oil and gas platforms in the North Sea

supplies is highly dependent on the location of the platforms. If a platform in need of additional power is too far from mainland, other platforms with excess power or a wind farm, then connecting to a network becomes uneconomical. Thus offshore networks cannot provide the only solution to offshore power demand.

An alternative method of on-platform generation would avoid the high costs and technical issues associated with offshore networks. Younger et al. [2] propose that some power demand could be met by Organic Rankine Cycle (ORC) technology driven by hot brines coproduced during water injection. ORCs are power cycles capable of producing mechanical work and electricity using very low grade heat sources.

Hot brine production is an unwanted but inevitable by-product of oil production. Within an oil field, the oil typically occupies only about 70 % (range 40-95 %

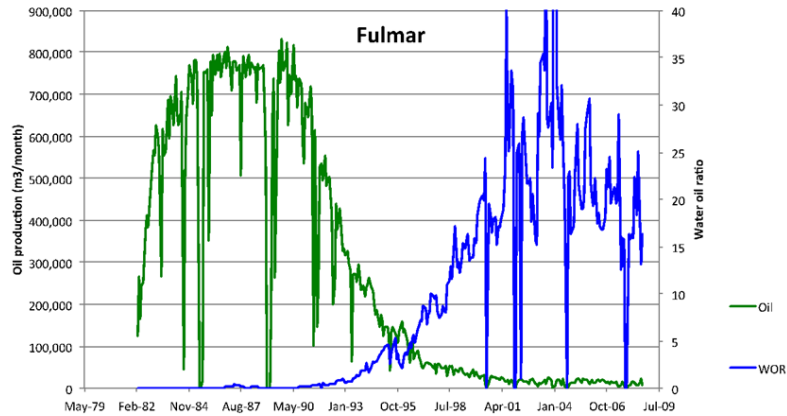

Figure 2: Monthly production profile for the Fulmar Field, Central North Sea, showing development of the water production as the field aged. WOR = water oil ratio

for producible oil) of the pore space in a reservoir rock. The remaining 30 % is occupied by water (brine) and 100 % of the pore space beneath the oil column (water leg) is occupied by water. At production start-up a field may produce dry oil but as production continues water will eventually be produced. The field pressure will decline. In order to maintain production, pressure support will be required. There are several natural mechanisms which can maintain pressure including natural aquifer inflow, but for the vast majority of fields some form of secondary recovery mechanism is used. The most common, particularly in offshore settings which have easy access to (sea) water, is to inject water. The combination of natural inflow and injected water leads to an ever-growing quantity of, geothermally heated, coproduced water. For the most mature fields in the North Sea between 10 and 20 times as much water is produced as oil (Figure 2). The quantities of water handled each day; produced, separated from the oil, cleaned of petroleum and then either re-injected or disposed of in the sea are enormous and hot (60 – 150 °C). For the Ninian Field about 0.5 million barrels of water is produced per day at approximately 102 °C (100,000 m³day⁻¹, Figure 2). The large excursions shown in Figure 2 occurring approximately annually and are due to planned shutdowns for maintenance.

Currently, the vast thermal resource harnessed by water injection is discarded as waste. In this study we examine in depth the potential to supply power by converting the thermal energy from the hot brines using an ORC.

An ORC system has several features which make it particularly suitable for offshore applications. Firstly, the ORC cycle can recover power from waste heat

without the need to burn any oil or gas. Therefore there are no costs associated with GHG emissions are incurred. By powering an ORC system with hot brines there is no fuel cost. This reduces a platform's operating costs significantly. Current regulation permits ORC power stations to operate without requiring an operator onsite and operation can be fully automated [10]. This makes ORCs suitable for remote sites, such as offshore platforms, and further reduces their operating costs. The primary cost associated with ORC systems are their installation and capital costs. An economic analysis of the feasibility of an ORC system is carried out as part of this study.

Unlike wind power the hot brine resource is predictable and reliable, so it is capable of providing baseload generation. While hot brine production will vary over time (Figure 2) this is controlled by the water injection pumps. The more power available to supply the injection pumps the better oil recovery. With increased oil recovery comes an increased volume of hot brine. This means more heat is available from the hot brines to fuel the ORC power system and thus more power can be produced. Therefore the ORC system should be sized with the maximum hot brine flow rate as it is possible to maintain this with the power supplied by the ORC.

Other advantages of ORC technology come from the specific features of the operating scenario proposed here. Firstly, the ORC coupled with hot brines can improve the oil recovery ratio. By providing thermal energy to the ORC, the hot brines are cooled before reinjection into the well. The cooled water results in better thermal fracturing of rock when re-injected; this means less pump power is required to maintain production. Similarly, the cooled brine has a higher viscosity. Increased viscosity improves the mobility of the brine fraction relative to the oil. Therefore, higher sweep efficiency is achieved and oil recovery is further improved.

2. Power production from low enthalpy resources

The Organic Rankine Cycle (ORC) is a low temperature power cycle that uses the same series of processes as a conventional water/ steam Rankine cycle. The Rankine cycle is used in virtually all types of thermal power generation and is represented by a diagram in Figure 3. The cycle starts by boiling a fluid (Figure 3, point 2) and expanding this vapour through a turbine (Figure 3, point 3). During the expansion process mechanical work is extracted from the system and the exiting fluid is condensed (Figure 3, point 4) and re-pressurised by means of a pump (Figure 3, point 1), in order that the cycle may start again. In a normal thermal power cycle (as in a power station) water is used as the working fluid in

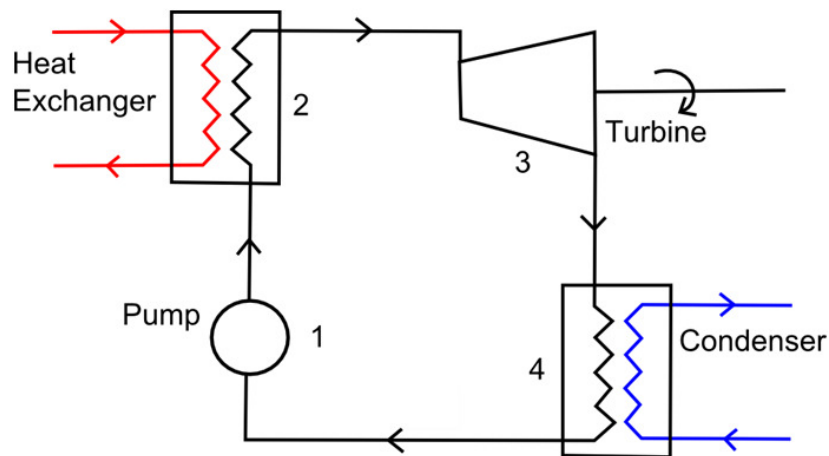

Figure 3: Schematic diagram of a Rankine cycle

the system. Using water as a working fluid requires the use of a high temperature source of heat to provide enough energy to vaporise the water. ORCs use organic fluids, with much lower boiling points, in place of water. These fluids require less thermal energy for vaporisation to occur so lower temperature operation is more easily achieved.

ORCs have been in commercial operation for a number of years, the first commercial examples were built in the late 1970s after the fuel crisis [11, 12]. Initial applications focussed on medium sized plants (MW size) for waste heat recovery, biomass and geothermal applications. ORC systems in low temperature, large scale (several MW) applications are widely considered a mature technology largely developed by ORMAT Technologies since the 1980s [12, 13]. Thus, there is extensive operational experience and previous research into ORC technology powered by geothermal resources with similar characteristics to those considered in this study. In the case of ORCs powered by low enthalpy geothermal resources, as proposed here, Quoilin et al. cite the cost of drilling boreholes and the high power consumption of the brine pump as factors which often make systems uneconomical [11]. However, by using hot brines as proposed in this paper the borehole has already been drilled so this cost can be discounted. Brine pumps are reported to require up to 50 % of the work output by the ORC. In this application the power output from the ORC is generated precisely to run these pumps. Oil extracted in addition to the hot brines will be separated so in this application more brine pump power will be required than in typical geothermal applications.

The ORC supplied by the lowest temperature geothermal heat source in the literature is in Chena springs, Alaska, which runs on a hot water supply of 73.33

°C [14]. However, the true feasibility of an ORC system is determined by the difference between the hot source and cold sink conditions, not the absolute temperature of the heat source. The larger the difference between the hot and cold source the more heat can be taken into the cycle and thus there is a higher potential power output. In this case, using hot brines in the North Viking Graben, the difference in temperature between the hot brines and condensing temperature is significant as the condensing fluid is North Sea brine which has an average temperature of approximately 5 °C. This is much lower than in many other ORC applications.

We propose that an ORC power system could supply a significant part, or all, of an offshore platform's power demand by using waste hot brines coproduced by water injection. The idea of using ORCs powered by hot brines offshore is not new. However, the scale to which an ORC could meet a platform's demand and address the issue of power supply in depleted oil wells has not been previously investigated. Zabek et al. present a case study of an ORC proposed to use hot brines on Chevron oil field off the West coast of the USA [15]. In this application ambient conditions are warm (10 – 28 °C) and although the brine temperature is high, 150 °C, the volume is very small: 4.53 kg/s. The resulting ORC is designed to produce 700 KW of electricity. Ambient conditions and available thermal resource from brines varies significantly between oil fields. In this paper a substantially different resource to that of Zabek et al. as described in section 3.

3. Demand and resource in the Brent province

The North Sea's Brent Province is examined in this paper. It is located in the North Viking Graben, Figure 4, some 150-300 km east and north east of the Shetland Isles in Scotland and the same distance west and north of Bergen in Norway. The Brent Province has a number of attributes which make it an attractive option for development of a power system from co-produced brines. Most of the fields were discovered and developed in the 1970s and as such they are all at about the same stage of development – late field life.

The water depth is around 150 m and the fields typically large such that they have dedicated production platforms. The depth to top reservoir varies from field to field but typically is close to 3 km and as such the reservoir temperature is about 100 °C. For most of the fields the oil is light (35° API) and has a low gas oil ratio meaning that relatively little gas is exsolved when the oil is brought to surface. The development scheme has typically been (pressure) depletion drive until a point just above the bubble point for the oil, followed by water injection

by line drive (Figure 2). A few fields in the Norwegian sector have been subject to water alternating gas using a locally abundant source of gas but for the most part the Brent Province is gas poor. Sweep efficiency and hence the proportion of petroleum recovered varies as a function of reservoir quality (recovery degrades with burial depth). The average recovery from the Brent Province is about 50 % (5-65 %).

Importantly fields produce about 10 times the quantity of water compared with that of oil and hence associated gas. Because the gas required is now in short supply production rates (oil plus gas and water) are declining for many fields. There comes a point when the operating expenditure (OPEX) exceeds income. Before that point is reached the field needs to be abandoned given the decommissioning costs for the platform. Yet half the oil remains in the ground.

Additionally, in the North Sea typically the temperature of the sea water at the surface is 5 °C. It is proposed the cool sea water be used as the heat sink. Thermal recovery from the hot brines is expected to be higher than for many other applications of ORCs with similar heat sources because sea water is much colder than the sink temperatures usually available. Thus a greater proportion of the heat energy can be recovered.

4. ORC Modelling Methodology

An analytical model is used to quantify the potential power output that ORC systems installed in the Brent province could produce. The model takes heat supply (hot brine) and heat sink (sea water) characteristics and computes the power output, specific power and global UA value for an ORC from these two heat streams.

The model used is an extended version of a model used in previous work by the authors [17]. The model uses standard thermodynamic heat-balance relations are used to describe the components in the cycle: heat exchangers, pump and turbine. It is capable of simulating organic cycles of any type, ranging from Trilateral Flash Cycles (TFC), operating with saturated liquid at inlet to the expander, through to subcritical cycles operating with superheated vapour throughout the expansion through the turbine.

The model has been extended in this work to be more flexible. In the previous work the mass flow rate of the organic working fluid was fixed and the Turbine Inlet Pressure (TIP) determined the cycle configuration. The TIP was then optimized to maximise power output of the ORC. The current model relaxes the constraint of a fixed ORC mass flow rate. Calculations are carried out for a range of TIPs, ORC working fluid mass flow rates and different working fluids. TIP range is

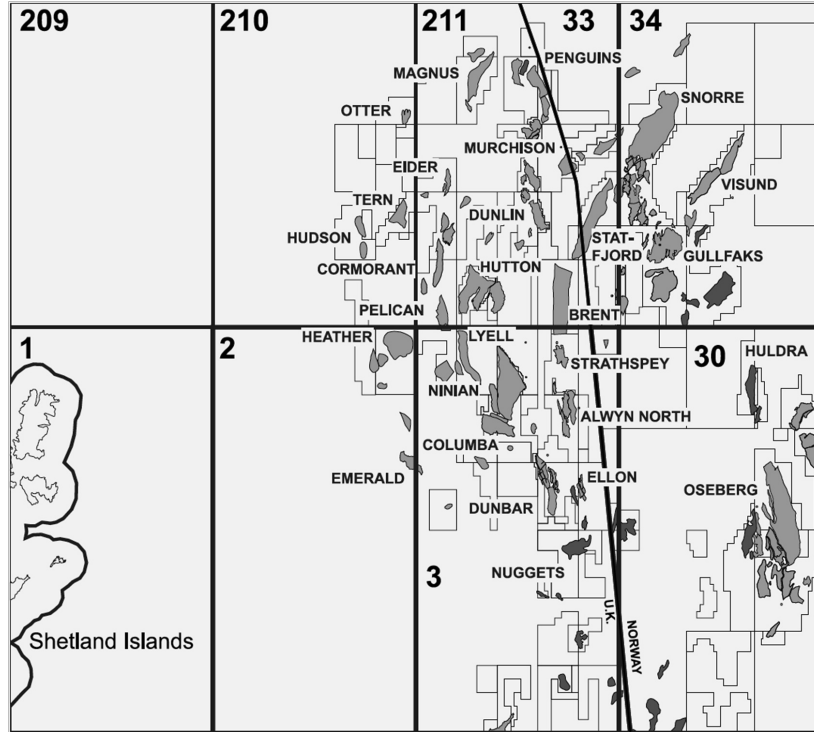

Figure 4: Location of Brent Province in North Viking Graben reproduced with permission from the Geological Society [16]

restricted to $0.01 P_{crit} < TIP < 0.8 P_{crit}$. The lower limit is selected to ensure the condenser vacuum was practically achievable and the upper limit of the TIP is set to limit error incurred by fluid properties uncertainty near the critical point (P_{crit}) in accordance with Herberle et al. [18]. Similarly the working fluid mass flow rate (\dot{m}_O) is limited to $0.4 \dot{m}_S < \dot{m}_O < 2.5 \dot{m}_S$, where \dot{m}_S is the mass flow rate of hot brine, to keep the quantity of working fluid within practically achievable limits.

In the present study, global UA and specific power values are calculated as indicators of plant size and balance respectively. The global UA value is calculated. It is derived from the equation for heat transfer:

$$Q = UA\Delta T_{LM} \quad (1)$$

where Q is the rate of heat transfer, ΔT_{LM} is the log mean temperature difference, U is the overall heat transfer coefficient and A is the heat exchange area. The UA value is the product of the heat transfer coefficient and heat exchange area. The larger the UA value the larger the heat exchanger required. Specific power is

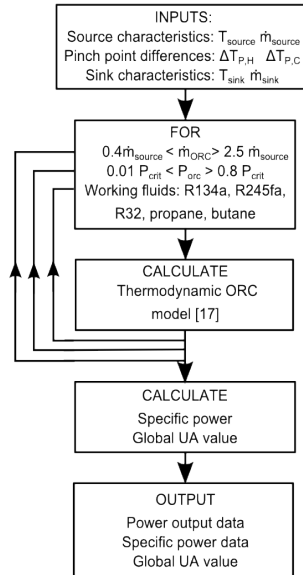

Figure 5: Flow diagram of the organic Rankine cycle model from [17]

defined as the power output divided by the mass flow rate of working fluid in the ORC.

The heat source and sink are assumed to be streams of pure water. In reality these streams will be brines but the thermodynamic properties are very similar which makes water an appropriate assumption for an initial estimate of ORC potential. The thermodynamic states of the organic working fluid, heat source and heat sink are calculated using FluidProp [19], a fluid properties calculator. The working fluids modelled are: R134a, R245fa, R32, propane and butane. These have been selected from the literature as a range of fluids commonly used in low temperature ORCs [12].

The ORC modelling strategy is shown by the flow diagram in Figure 5. Details of the thermodynamic model, as labelled in Figure 5, can be found in [17].

5. Recoverable power - A Balance of plant size, cost and power output

In order to assess potential power generation from hot brines coproduced in the North Sea multiple simulations modelling different heat supply characteristics were run.

Heat supply is characterised by mass flow rate and temperature of the hot brines co-produced. Temperatures of hot brines typically range from 70 °C –

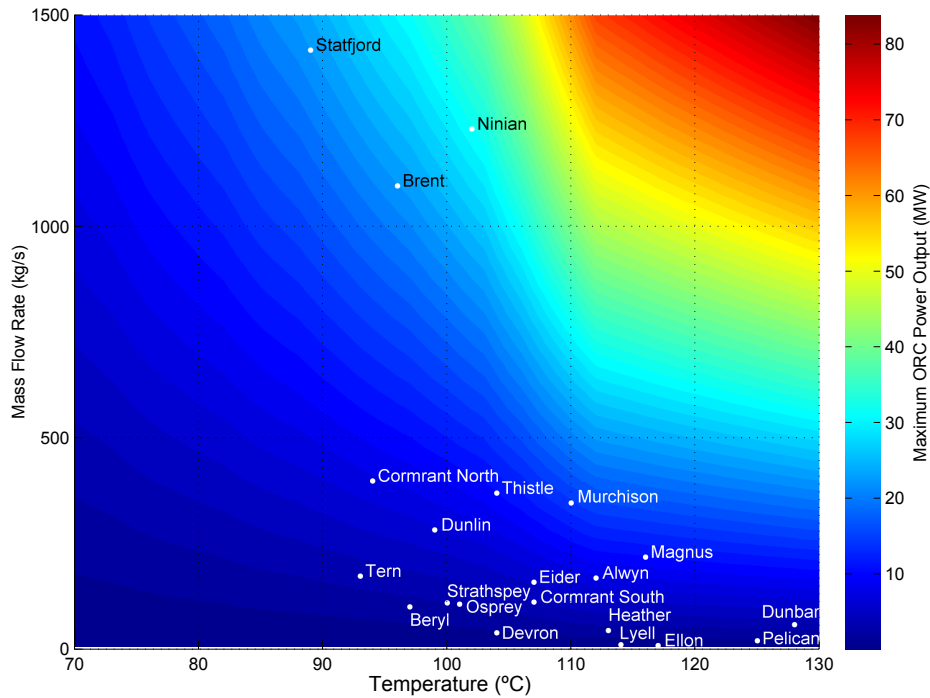

Figure 6: Potential power output of organic Rankine cycle fuelled by coproduced hot brines

130 °C and simulations are run in 3 °C increments through this range. Hot brine mass flow rates have a larger range, a typical range is 1 kg/s – 1500 kg/s (543 - 815158 bwpd) so simulations were run in increments of 75 kg/s. The condensing stream is assumed to be 5 °C which is representative of the temperature of the North Sea [20]. It is assumed that the condensing stream mass flow rate is 5 times that of the ORC working fluid mass flow rate.

For each possible combination of heat source characteristics the ORC was modelled using the ORC configurations, varying working fluid, TIP and mass flow rate, as described in the section 4. To create Figure 6 the ORC configuration which produced the maximum power output was selected and this power output is plotted as contours against the heat source conditions. Potential power output is also modelled using peak volume data from specific wells in the Brent province as recorded in Table 1. These results are plotted as data points on Figure 6.

The hot source in each simulation is modelled by a single temperature and mass flow rate and therefore the ORC selected is the optimum design. Off-design performance is not considered because the mass flow rate and temperature of the hot brines produced will remain constant. The temperature of the hot brines will

Name	Mass Flow Rate (kg/s)	Temperature (°C)	Max. Power Output (MW)
Ellon	9.29	117	0.45
Lyell	11.25	114	0.52
Pelican	20.51	125	1.09
Devron	39.54	104	1.09
Heather	44.88	113	2.05
Dunbar	58.43	128	3.2
Beryl	100.88	97	2.1
Osprey	107.15	101	2.66
Strathspey	110.29	100	2.59
Cormorant South	111.94	107	3.67
Eider	159.22	107	5.22
Alwyn North (East)	168.71	112	7.58
Tern	173.17	93	3.15
Magnus	218.65	116	10.36
Dunlin	282.72	99	6.39
Murchison	346.46	110	14.1
Thistle	369.93	104	10.19
Cormorant North	398.72	94	7.57
Brent	1096.62	96	22.28
Ninian	1231.1	102	31.01
Statfjord	1417.43	89	22.56

Table 1: Characteristics of coproduced hot brines in the Brent province and potential power output of an ORC for each. Mass flow rate data available from DECC, Temperature data from Gluyas and Hichens [16]

not fluctuate much because the temperature in the reservoir remains constant. However the mass flow rate of the brine is determined by the power applied to the pumps used to inject the cool brines into the reservoir. Currently pump power and operation is determined by the cost of gas required to produce power to run them. However, when using an ORC to meet power demand, the mass flow rate of the hot brine can be held constant by supplying enough power from the ORC to the injection pumps. As a consequence using an ORC fuelled by hot brines will improve the stability of production.

The graph shows significant power output can be generated with even low temperature hot brine due to the large volumes available. This is evidenced by the Brent, Ninian and Statfjord fields. These fields have relatively low temperature

coproduced brines but the large volumes produced mean they have the potential to produce the largest amounts of power. The model used in the study predicts the Ninian field is able to produce the largest amount of power 31 MW. In reality this size of system would require exceptionally large heat exchangers and volume of organic fluid so may be practically difficult or expensive to implement. However this does indicate the vast potential of hot brines as an energy source.

Magnus, Thistle, Murchison, Brent, Ninian and Statfjord have the potential to generate more than 10 MW, while the majority of other sites are predicted to be capable of producing several MWs of power. This is a significant proportion of a typical platform's energy demand.

The potential power predicted by the model used in this study exceeds that predicted using similar data for the Brent field published by Younger et al. [2]. This is because Younger et al. assumed a fixed temperature drop of 30 °C for each hot brine stream. The available heat input to the cycle is limited by this assumption and therefore so is the possible power output. In this study pinch point analysis is used to model the heat exchange process and allows the fixed temperature drop constraint to be relaxed. The pinch point method employs an assumption of a minimum temperature difference between the hot brine and organic working fluid in the heat exchanger also known as the pinch point (in this study, the pinch point was set arbitrarily to 5 °C). This assumption relates to the physical construction of the heat exchanger, and here it is assumed that it is possible to construct a heat exchanger to meet the heat exchanger duty needed.

Potential power production is examined further by considering the case of a single field. The Eider field has been selected for further investigation by calculating how potential power output, size of plant and specific power changes with the ORC configuration. However, the trends shown are common to each field. The configuration of the ORC is characterised by the pressure at inlet to the turbine (TIP) and the mass flow rate of the ORC fluid. The organic working fluid is R134a. R134a was selected because out of the working fluids simulated it was predicted to have the highest power output, the other fluids used in the simulations predicted similar power outputs with the exception of n-butane which was much lower. Figure 7 shows how the potential power produced from hot brines varies as a function of the characteristics of the ORC.

Figure 7 shows that in this example the maximum power output occurs at the highest mass flow rate of working fluid possible with the highest TIP. The figure shows that by reducing the mass flow rate from the maximum the potential work output decreases significantly. However, if the turbine inlet pressure were to be reduced, whilst mass flow rate remained constant, the ORC can still produce near

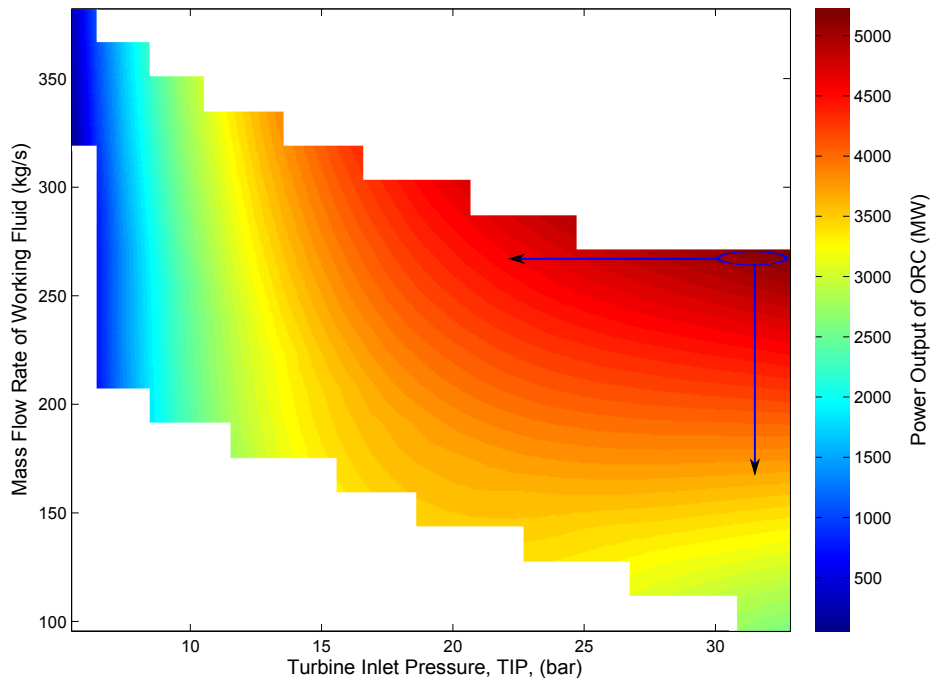

Figure 7: Power output as a function of ORC mass flow rate and TIP for the Eider field. The working fluid is R134a. Oval indicates area of maximum power output.

to the maximum potential power output. Therefore, near the maximum power output the ORC is more sensitive to changes in mass flow rate than turbine inlet pressure.

The total UA value for the heat exchanger is mapped according to ORC configuration, in Figure 8. The total UA value is an indicator of the size of the heat exchanger required to achieve the heat transfer demanded for each ORC configuration. Thus an understanding of how the ORC might scale with work output is possible by comparing Figures 7 and 8.

Figure 8 shows the maximum UA value, and therefore largest heat exchange area, does not occur at the same location as maximum power output. This is because power output is a function of both cycle efficiency and heat exchanged into the cycle. In this case the maximum heat input to the cycle will occur when the UA value is largest but the ORC cycle configuration here must be less efficient meaning maximal power output is produced at a different configuration. From Figure 8 it is clear that by decreasing the mass flow rate from the location of maximum power output the UA value decreases rapidly and therefore the size of the heat exchanger would decrease significantly. Conversely, starting from

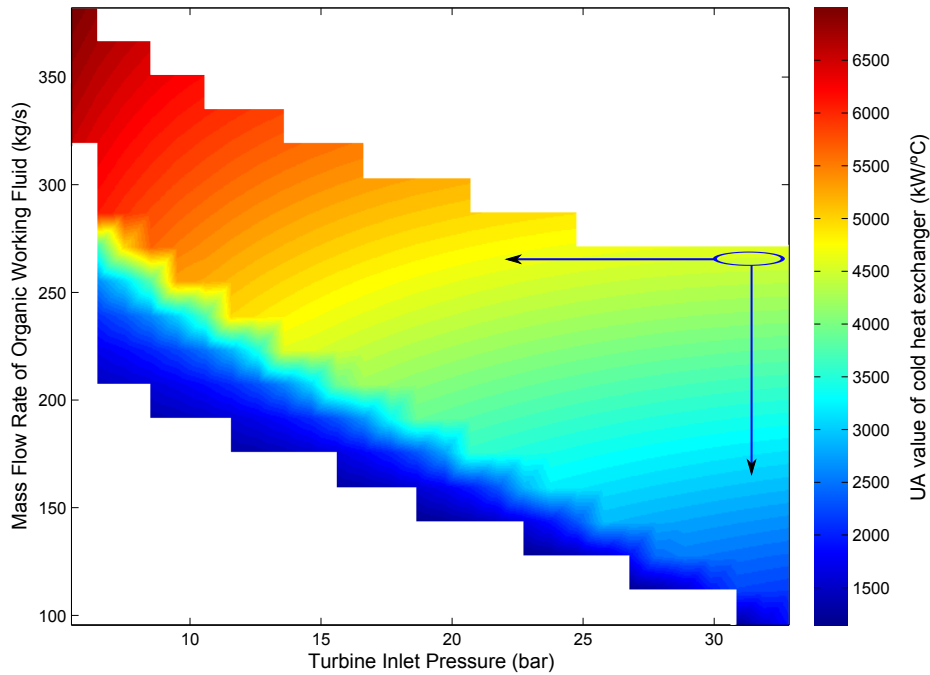

Figure 8: UA value of the heat exchanger as a function of ORC mass flow rate and TIP for the Eider field. The working fluid is R134a. Oval indicates area of maximum power output.

the location of maximum power output and decreasing the turbine inlet pressure results in a gradual increase in UA value and therefore heat exchanger size.

Next the specific power for each ORC configurations is calculated, as shown in Figure 9. Optimising for the specific power gives the best balance between size of plant and power output. At a low specific power there is a low power output per kg of working fluid so this represents a large system. Similarly a high specific power represents a smaller system. Figure 9 shows at maximum power output the specific power is quite high, but not at the maximum specific output calculated. The specific power decreases rapidly with mass flow rate of organic fluid but stays at a similar value with decreasing TIP.

Figures 7,8 and 9 show that the power output of the ORC can be designed to scale with the heat exchanger area and system size. For example starting from the position of maximum power output, indicated by the oval shape in Figure 7, the power output can be decreased by lowering the mass flow rate in the cycle, this is indicated by the vertical arrow. Decreasing the mass flow rate, results in a higher specific power and lower UA value (Figures 8 and 9). So the heat exchanger area and plant size will decrease with the power output. However,

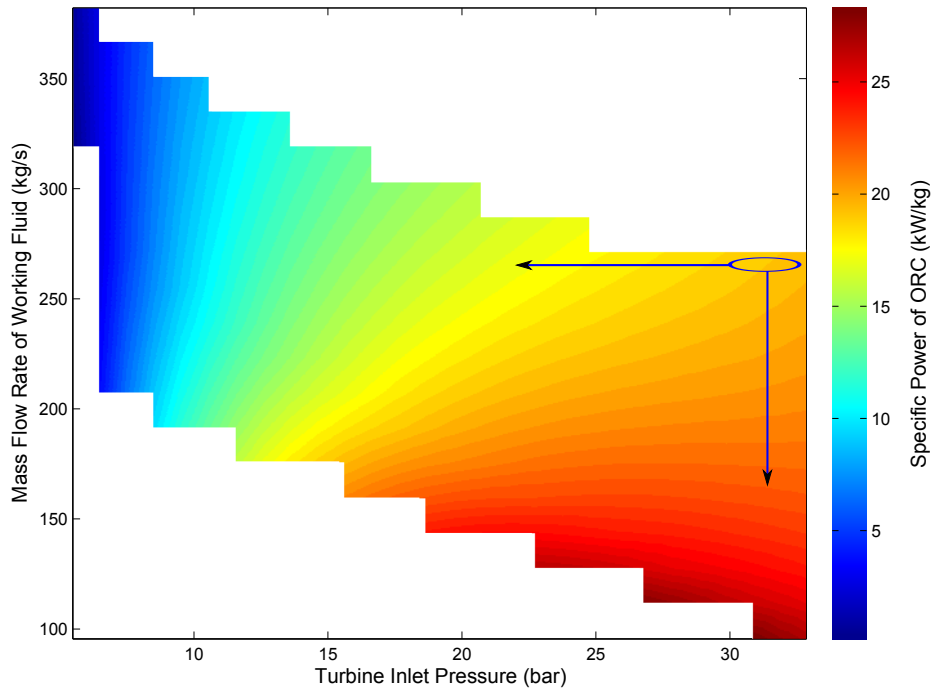

Figure 9: Specific power as a function of ORC mass flow rate and TIP for the Eider field. The working fluid is R134a. Oval indicates area of maximum power output.

should the TIP be reduced, indicated by the horizontal arrow, the required UA value and specific power will increase a little, meaning the size of the ORC system and heat exchanger area would be larger for a smaller power output. Care should be taken when designing the ORC to avoid this scenario unless it offers a cost saving. Regions on all the maps (Figures 7,8, 9) with no data are outside the operating limits of the ORC. These limits are determined by the model and thermo-physical limits of the working fluid, some of which were described in section 4.

To optimise an ORC power plant design, the power output should be maximised while cost is minimised. Minimising cost effectively means minimising the UA value, to minimise heat exchanger size, and maximising specific power, to produce maximal power per unit mass of ORC working fluid. Figures 7, 8 and 9 show maximum work output, minimum UA value and maximum specific power occur at different ORC configurations. Therefore an ORC designed for an offshore platform and fuelled by hot brines will be a compromise of power, size and cost.

6. Economic assessment compared to existing costs

For an ORC power generation system to be economically feasible the cost of installation and operation and maintenance costs must be less than the cost of supplying gas to power gas turbines plus the maintenance of the gas turbines over an acceptable pay back period. The ORC system will have a high initial capital expenditure but as the fuel (hot brines) is free, there are low running costs after installation. In contrast, using the existing gas turbines clearly has no initial capital outlay but a significant continual fuel and maintenance cost. Whether or not a platform will continue to produce, will rely on the gas import cost to be less than the income from the oil produced. To understand the feasibility of an ORC system versus continued use of gas turbines the cost of each scenario has been estimated.

The power requirement of North Sea oil and gas platforms varies from approximately 10 MW to several hundreds of MWs [21]. Figure 6 shows six wells capable of generating more than 10 MW of power via an ORC system, while many others have the potential to generate several MWs. In this study all financial evaluation is carried out for a power requirement of 10 MW, as this is representative of the power requirement of a North Sea platform and the size an ORC power plant fuelled by hot brines could supply. Nguyen et al. [22] report a typical North Sea platform to have 3 Siemens SGT-500 turbines. Typically the power demand, approximately 19.06 MW, is supplied by 2 turbines running at 50 % load while the third is on standby for maintenance. In this case it is unlikely an ORC could supply the platforms whole power demand fuelled by heat from hot brines. However an ORC system could supply a base load proportion of a platforms power requirement thereby reducing the required gas supply and reducing the running costs of the platform.

The cost of an ORC power system is taken as 3000 €/kW, this is an estimate for a MW-scale fully installed geothermal type system including the ORC plant and all process integration [11] Therefore it is estimated that an ORC capable of supplying 10 MW of power would cost €30 million. Next, the cost of gas supply to generate 10 MW is estimated, using the characteristics of the SGT-500 turbines as shown in table 2. We assume annual maintenance costs for the ORC system would be comparable to that of gas turbines and therefore maintenance costs are omitted from the calculations.

The amount of gas required to produce 10 MW for a year via SGT-500 turbines operating at 50 % load is 18.4 million therms per year (19.4×10^5 GJ/year). Most North Sea platforms are supplied with gas to fuel the gas turbines via a pipeline. Therefore, the cost of gas to a platform is equal to the wholesale gas

Name	Siemens SGT-500
Base load power output	17 MW _e
Base load efficiency	32.20 %
Heat rate at base load	0.1060 therms/kWh (0.0112 GJ/kWh)
50 % load efficiency	25 %
Heat rate at 50% load	0.1990 therms/kWh (0.0210 GJ/kWh)
Turbine Speed	3,600 rpm

Table 2: Siemens SGT-500 turbine characteristics [23]

price [21]. The UK Department of Energy and Climate Change (DECC) fuel price projections 2013 [24] for natural gas have been used in this study, these are shown in Figure 10.

The DECC fuel price projections have been used to estimate the annual cost of gas required to continually supply 10MW via gas turbines for a year. The estimated cost of both a 10 MW ORC power system and gas supply to power existing turbines has been combined in Figure 11 to show the cash flows for each scenario.

From the cash flow model it is not clear which scenario, continued use of gas turbines or adoption of ORC power plants, would cost the least over time. A discounted cash flow model has been used to calculate the present value of the gas cost in future years. The Discounted Present Value (DPV) is calculated by equation 2

$$DPV = FV/(1 + d)^n \quad (2)$$

Where FV is the future value of the gas cost, this is calculated using the projected gas price as shown in Figure 10, n is the number of years from the present and d is the discount rate. The discount rate accounts for the time value of money, here it is set at 10 % in accordance with Aboody [25]

The effective payback period of the ORC is then found by calculating how many years worth of gas, using DPV, is equivalent to the capital cost of the ORC. The effective payback time has been calculated using the low, central and high gas price projections, Table 3. The payback time for all three scenarios is encouraging. The maximum payback predicted time is 4.53 years. This is particularly important in the North Sea where oil and gas reserves are depleting and therefore the forecast shutdown date of many platforms in the North Sea may only be a matter of a few years.

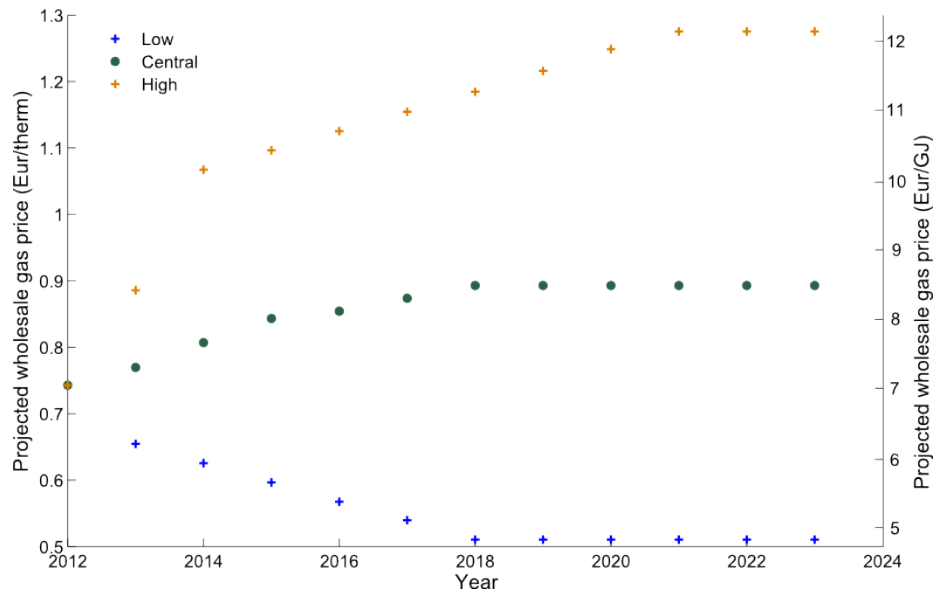

Figure 10: DECC 2013 gas price projections [24]

However, the different gas price scenarios do show that gas price has a strong influence on the payback time. The payback time is 24.8 % longer in the low gas price scenario and 14.9 % shorter in the high gas price scenario relative to the central gas price projection. Uncertainty in effective pay back time often mean investments are less attractive. But in this case all the payback times are small, less than 5 years. Additionally, power production via ORC protects the platform operation from the influence of fluctuating gas price as the platform could continue operation through periods of high gas price production where previously production would have stopped until the gas price fell.

The number of active wells from each platform has remained fairly constant over the decades since production began in the 1970s. This is in part because the design of the platforms typically underestimated both the field performance and field longevity. Individual wells have been abandoned but most of their host wellslots have been used for sidetrack wells to target areas of unswept oil. Even now as the fields reach old age it is likely that payback time will be less than well abandonment rate. Moreover, if the coproduced water generates value then wells could be produced to even higher Water to Oil Ratios (WORs) and the economic production life of wells extended.

CO₂ emissions associated with the gas turbine exhaust will incur additional expense to the fuel cost. Norway has very clear levies on GHG emissions and

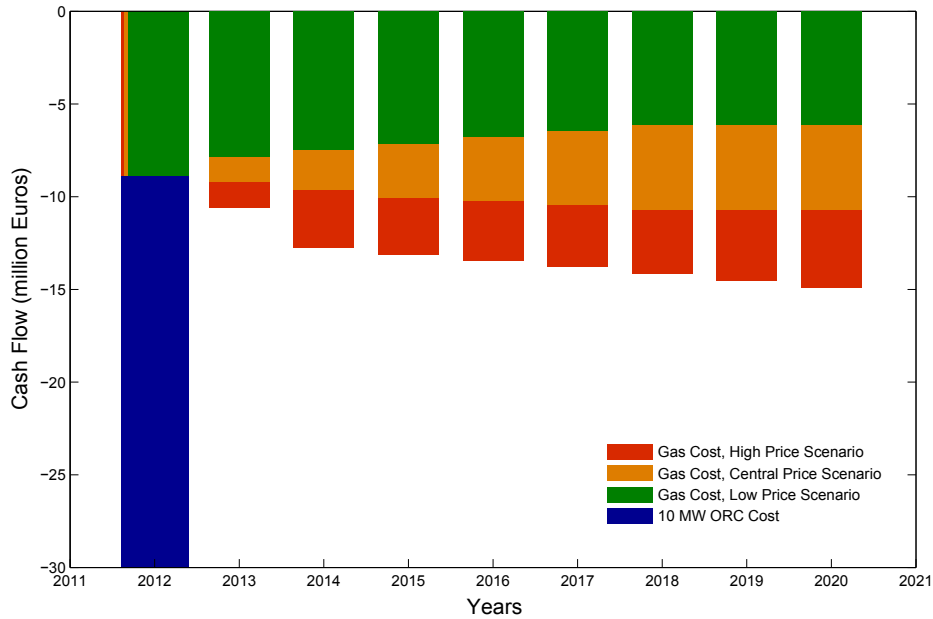

Figure 11: Cash flow for ORC and gas turbine scenarios

DECC Gas Price Scenario	Payback Time (years)
Low	4.53
Central	3.63
High	3.09

Table 3: Payback time of a 10 MW ORC based on DECC gas price projections

therefore is used as a case study here. The Norwegian carbon tax costs 200 Norwegian Krone, NOK, (€24) per tonne of CO₂ [26]. The CO₂ emissions from gas combustion is defined as 2.34 tonne CO₂ per 1000 Sm³ (where Sm³ is standard meter cubed) by Statistics Norway [27]. So the cost, due to the carbon tax to produce 10 MW via gas turbines is €2.02 million per year. This is 23 % of the cost of gas (as calculated for 2012). Therefore in Norway CO₂ emission levies are a significant additional cost and will reduce the payback time of an ORC power system further relative to the values given in Table 3.

7. Conclusions

Organic Rankine Cycles (ORCs) have been modelled with heat supplied by hot brines coproduced from oil and gas fields in the Brent province.

Simulations show coproduced hot brines, for a range of temperatures and mass flow rates, have the potential to fuel ORCs that are capable of supplying all or a large part of a off-shore platform's power demand. The Magnus, Murchison, Thistle, Brent, Staffjord and Ninian fields all have the potential to produced greater than 10 MW of electricity. This Ninian field is predicted to have the largest power output, 31 MW. Results from a single field (Eider) show that ORC plants will scale to size or financial constraints. Further work is ongoing to model the size and cost of an ORC in more detail in order to better understand how ORC design might be optimised. Financial analysis calculated a payback time for a 10 MW ORC based on a discounted cash flow model. The payback time based on low gas price projections is 4.53 years while payback time based on high gas price projections is 3.09 years. Payback times would be decreased even further if the cost of emitting GHG were taken into account in the calculations. Therefore ORC power plants have real potential in terms of both financial cost and power output to fulfil significant proportions of power demand in the North Sea.

8. Acknowledgements

We thank Tony Peters (Fairfield Energy) and Andrew Cavanagh (Statoil) for providing guidance on gas consumption rates for power generation.

References

- [1] B. H. N. Smulders, J. L. Franklin, B. L. Logan, The eider production platform concept: A platform in deep water with small reserves, in: Offshore Technology Conference, Houston, Texas, 1987.
- [2] P. L. Younger, J. G. Gluyas, W. E. Stephens, Development of deep geothermal energy resources in the uk, Proceedings of the Institution of Civil Engineers 164(EN0) (2011) 1–14. doi:<http://dx.doi.org/10.1680/ener.2011.164.0.1>.
- [3] Emissions of greenhouse gases, 1990-2012, final figures, Online Report (January 2014). URL <http://www.ssb.no/en/natur-og-miljo/statistikker/klimagassn>
- [4] T. Nguyen, B. Elmegaard, L. Pierobon, F. Haglind, P. Breuhaus, Modelling and analysis of offshore energy systems on north sea oil and gas platforms, in: SIMS 53rd Conference on Simulation and Modelling, Reykjavik, Iceland, 2012.
- [5] I. Dincer, M. A. Rosen, Exergy: energy, environment and sustainable development, Newnes, 2012.
- [6] L. Stendius, P. Jones, The challenges of offshore power system construction - bringing power successfully to troll a, one of the worlds largest oil and gas platform, in: EWEC, ABB Sweden, Athens, 2006.
- [7] Access to fairfield energy's oil and gas infrastructure.
URL <http://www.fairfield-energy.com/pages/view/access-to-fairfield-energy-s-oil-and-gas-infrastructure>

- [8] J. I. Marvik, E. V. Øyslebø, M. Korpås, Electrification of offshore petroleum installations with offshore wind integration, *Renewable Energy* 50 (2013) 558–564. doi:doi:10.1016/j.renene.2012.07.010.
- [9] T. K. Vrana, R. E. Torres-Olguin, B. Liu, T. M. Haileselassie, The north sea super grid-a technical perspective., in: 9th IET International Conference on AC and DC Power Transmission, London, UK, 2010. doi:10.1049/cp.2010.0992.
- [10] I. Obernberger, P. Thonhofer, E. Reisenhofer, Description and evaluation of the new 1,000 kwel organic rankine cycle process integrated in the biomass chp plant in lienz, austria, *Euroheat and Power* 10(1) (2002) 18–25.
- [11] S. Quoilin, M. Van Den Broek, S. Declaye, P. Dewallef, V. Lemort, Techno-economic survey of organic rankine cycle (orc) systems, *Renewable and Sustainable Energy Reviews* 22 (2013) 168–186. doi:10.1016/j.rser.2013.01.028.
- [12] B. F. Tchanche, G. Lambrinos, A. Frangoudakis, A. Papadakis, Low-grade heat conversion into power using organic rankine cycles: A review of various applications, *Renewable and Sustainable Energy Reviews* 15 (2011) 3963–3979. doi:10.1016/j.rser.2011.07.024.
- [13] Ormat energy converter the most reliable power for unmanned offshore facilities (2006). URL <http://www.ormat.com/research/papers/RemotePowerUnits>
- [14] G. Holdmann, The chena hot springs 400kw geothermal power plant: Experience gained during the first year of operation, *Geothermal Resources Council Transactions* 31 (2007) 515–519. URL <http://pubs.geothermal-library.org/lib/grc/1025270.pdf>
- [15] D. Zabek, J. Penton, D. Reay, Optimization of waste heat utilization in oil field development employing a transcritical organic rankine cycle (orc) for electricity generation, *Applied Thermal Engineering* 59 (2013) 363–369. doi:10.1016/j.applthermaleng.2013.06.001.
- [16] J. G. Gluyas, H. M. Hichens, R. F. P. Hardman, J. R. Underhill, Y. A., N. McKim, P. Taylor, T. Chapman, G. Cowan, T. Boycott-Brown, et al., United Kingdom oil and gas fields: commemorative millennium volume, Vol. 20, Geological Society, 2003. doi:10.1144/GSL.MEM.2003.020.01.01.
- [17] A. Auld, A. Berson, S. Hogg, Organic rankine cycles in waste heat recovery: a comparative study, *International Journal of Low Carbon Technology* 8 (suppl 1) (2013) i9–i18. doi:10.1093/ijlct/ctt033.
- [18] F. Heberle, M. Preißinger, D. Brüggemann, Zeotropic mixtures as working fluids in organic rankine cycles for low-enthalpy geothermal resources, *Energy* 37 (2012) 364 – 370. doi:doi:10.1016/j.renene.2011.06.044.
- [19] P. Colonna, T. P. van der Stelt, Fluidprop: a program for the estimation of thermo physical properties of fluids, Software, energy Technology Section, Delft University of Technology (2004).
- [20] D. for Environment Food, R. Affairs, Charting progress 2, section 2 ocean processes: Sea temperature, salinity and circulation (2012). URL <http://chartingprogress.defra.gov.uk/chapter-2-oceanprocesses>
- [21] Private correspondence with A. J. Cavenagh (statoil).
- [22] T. Nguyen, L. Pierobon, B. Elmegaard, Exergy analysis of offshore processes on north sea oil and gas platforms, in: 3rd International Conference on Contemporary Problems of Thermal Engineering, Gliwice, Poland, 2012.

- [23] SGT-500 Industrial Gas Turbine, accessed 27/01/14 (2011).
URL http://www.energy.siemens.com/us/pool/hq/power-generation/gas-turbines/SGT-500/downloads/SGT-500_for_PG_EN.pdf
- [24] Decc 2013 fossil fuel price projections, accessed: 27/04/2014 (2013).
URL https://www.gov.uk/government/uploads/system/uploads/attachment_data/file/212521/130718_decc-fossil-fuel-price-projections.pdf
- [25] D. Aboody, Recognition versus disclosure in the oil and gas industry, *Journal of Accounting Research* 34 (1997) 21–32.
- [26] P. Sopher, A. Mansell, Norway, the world's carbon markets: A case study guide to emissions trading, Tech. rep., IETA and EDF (May 2013).
- [27] T. Sandmo, The norwegian emission inventory 2011, Tech. rep., Statistisk sentralbyrå (Statistics Norway) (2011).
URL http://www.ssb.no/a/publikasjoner/pdf/doc_201121_en/doc_201121_en.pdf