

## MASTER

Holiday city in Parkcity  
tourism outcom for shrinking regions

Bulut, A.

*Award date:*  
2016

[Link to publication](#)

### **Disclaimer**

This document contains a student thesis (bachelor's or master's), as authored by a student at Eindhoven University of Technology. Student theses are made available in the TU/e repository upon obtaining the required degree. The grade received is not published on the document as presented in the repository. The required complexity or quality of research of student theses may vary by program, and the required minimum study period may vary in duration.

### **General rights**

Copyright and moral rights for the publications made accessible in the public portal are retained by the authors and/or other copyright owners and it is a condition of accessing publications that users recognise and abide by the legal requirements associated with these rights.

- Users may download and print one copy of any publication from the public portal for the purpose of private study or research.
- You may not further distribute the material or use it for any profit-making activity or commercial gain

# Holiday city in Parkcity

Tourism outcome for shrinking regions

# Holiday city in Parkcity

Tourism outcome for shrinking regions

Master of Architecture 2016  
Graduation project by Ahmet Bulut

Graduationstudio:  
IBA Parkstad 2020

Graduation Committee:  
dr.ir. A.H.J. (Jos) Bosman  
dr. S. (Sukanya) Krishnamurthy  
dipl.-Ing. H.H. (Hüsnü) Yegenoglu

Faculty of Architecture, Building and Planning  
Eindhoven University of technology  
Netherlands

Eindhoven © 2016

Auteur: Ahmet Bulut

## Preface

This report is the result of my graduation studio, resulting in a design for a park hotel in Landgraaf for the graduation studio "IBA Parkstad 2020," for completion of the Master in Architecture, Building and Planning at the Technical University of Eindhoven.

The process began with an M3 project, in which the graduation studio took part in the IBA Parkstad 2020. In the joint book "Bicycle Highway Plus" by the graduation studio, spatial concepts can be extensively examined. This report focuses on these concepts and ideas.

In the second part of the graduation period, I continued to individually design a building that had a connection to the IBA Parkstad objectives. During this process, I encountered obstacles. Thanks to the extra motivation I received from my professors, I was able to overcome these periods. I would therefore like to thank my professors, Mr. Jos Bosman, Husnu Yegenoglu and Mrs. Sukanya Krishnamurthy, for their support.

## TABLE OF CONTENTS

PREFACE	5
SUMMARY	9
INTRODUCTION	10
PHENOMENON SHRINKAGE	
shrink cities	14
the communication paradox	15
the IBA	16
studio Parkstad	16
TOURISM DEMOGRAPHICS	
South Limburg tourism	22
Parkstad tourism	23
STARTEGIE	
Main attractions	28
Sights of Parkstad South Limburg	30
Open recreation areas	32
Available accommodation types	34
Location attractiveness	36
LOCATION APPROACH	
Location development	42
Location approach	44
DESIGN	
Concept	54
Design	56
DRAWINGS	60
CONCLUSION	109
SOURCES LITERATURE AND IMAGES	112

## Summary

The Parkstad Limburg region is suffering from shrinkage. This is effecting the local economy, the quality of life of the residents and contributing to the closure of regional towns. Shrinkage is, however, not the problem, but is rather the result of the problem. The problem itself is the decline of the population in the region. This has been caused by factors such as low birth rates, economic migration and young generations moving away from the region. This migration has created many vacancies in various sectors, such as businesses, facilities, education and housing. In the years to come, the expectation is that the population will continue to decline. For many, migrating to the region has developed a negative image.

Parkstad was a growing economy in the 1960s and 1970s, due to the presence of the mining industry. After the closure of the mines, the economy slowed. This trend encouraged the present deterioration of the economy, leading to many vacant houses, shops and recreation facilities, which has in turn decreased the quality of life. To restore a high quality of life and reduce the vacancy rate, more people must become involved in Parkstad.

In this study, the focus lies on approaching people from outside the Parkstad region. In the city center, shops are vacant due to lack of visitors, and facilities cannot be maintained due to a low usage. Parkstad requires larger public utilization in the near future. To achieve this, the focus must be on what Parkstad has to offer. Therefore, this study addressed the following question: "How can we attract people to Parkstad?"

Limburg is a tourism region of the Netherlands. Parkstad must be able to distinguish itself as a specific region. It already has its own identity as the City of Entertainment located within a characteristic Limburg landscape. From this foundation, these qualities can be used to create alternative choices of accommodation within the urban areas. The second main question is therefore: "How can we use the qualities of Parkstad to offer an alternative landscape accommodation?" To answer these questions, the earlier presented surveys, case studies and literature publications were analyzed.

The conclusion of this study details the development of a quality experience, whereby accommodation, sights and attractions are linked with catering establishments. This led to the creation of a child-friendly bungalow park with a modern architectural design, where guests can enjoy an open natural environment within an urban area.

## Introduction

Parkstad Limburg is a south-eastern region that includes eight municipalities: Brunssum, Heerlen, Kerkrade, Landgraaf, Nuth, Onderbanken, Simpelveld and Voerendaal. Heerlen is the central municipality of Parkstad. The Parkstad region experienced economic growth during the period in which the mining industry was active. Following the closure of the mines in the 1960s and 1970s, the region underwent a metamorphosis. In spite of its favorable international location between the economic centers of the Randstad, the Ruhr and Brussels/Antwerp, the region could not use this location advantage to continue its economic growth.

The Parkstad region is currently shrinking. This shrinkage is related to several factors, one of these being economic. An examination of the mining history of Parkstad reveals only some monumental mine shafts and, for example, the huge mine slag heaps in Landgraaf.

Many companies are located in Parkstad due to its favorable international situation. However, in recent years the number of these companies has declined. The economic decline of Parkstad is becoming more apparent, as seen through the increase in vacant spaces in the city centers. The vacancy rate is one of the problems that must be addressed.

In contrast to the decline in employment in various sectors, such as production and business, there is a sector, namely that of tourism, that can ensure that Parkstad receives an economic boost. The inner cities have a problem with empty shops, and social services cannot be maintained because there are too few visitors. The tourism sector can provide a solution within a short time to all of these problems.



Pic 1: Parkstad Limburg region

Phenomenon shrinkage



## Shrinking cities

Shrinkage involves population decline, and an alteration in the population structure. This has mainly involved young people and young families, which move away from a shrinking city or region. Vacant properties and unsold homes arise in shrinking areas. Amenities such as shops, sports clubs, recreational areas and schools disappear because they cannot be maintained. In turn, with the disappearance of facilities, the quality of life and livability decreases.

The reason for shrinkage may be a decline in birth rates, high death rates or the departure of people from the region. Demographic developments may have various impacts on population migration. The reasons for this may involve the absence of or minimal social services or employment, or the presence of emerging regions.

Shrinkage occurs at both local and regional levels. At a national level, no shrinkage is observable, and is also not expected in the future. The life expectancy is higher, the rural birth rate is higher than the death rate, and migration is occurring from abroad. According to statistics from the Centraal Planbureau (CPB; Netherlands Bureau for Economic Policy Analysis), a decline in population is expected only after 20 to 30 years. Not only must the Netherlands, but all European countries, deal with this phenomenon.

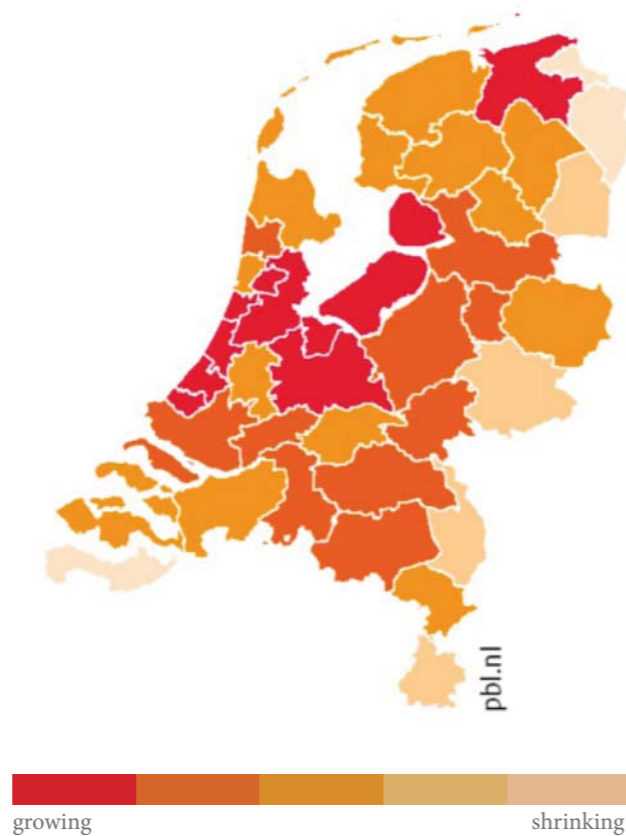

Pic 2: Population growth by region

## The communication paradox

The visibility of shrinkage in Parkstad is not only evident in the decline of the population, but also in the number of households. This type of shrinkage has major consequences for the facilities. A number of facilities in the Parkstad cities within the valleys, and in housing and shopping areas, stand empty. Due to these vacancies, and in particular those within the city centers, the economic prospects of Parkstad cities have been negatively affected.

Parkstad was therefore not able to focus on the decline of the population or type of population groups such as youth, the elderly, families or singles. The social facilities of Parkstad are available to enable each group to meet their social needs. Competitive regions have, at the same time, drawn many young people. Many people have also left Parkstad for economic reasons.

The Parkstad municipalities have brought into focus the importance and urgency of shrinkage, under the name of “communication paradox.” When a region is connected with shrinking, it loses its attractiveness and this thereby creates a downwards spiral, which can be emphasized in population and economic decline.



Pic 3: Vacancy Parkstad center



Pic 4: Vacancy Parkstad center

IBA is the tool to weak cities and regions in order to create strong and vital areas. It is a structural program that creates wide interest and raises expectations, builds tension up to the outcome and focus of the project for a long time on a field. "Peter Bertholet, director-secretary City Region of Parkstad Limburg (source: Limburgs Dagblad, 2010).



## The IBA

The International Bau Ausstellung (IBA, International Construction Exhibition), originated in Germany as an exhibition for modern buildings. Over time, the IBA became a proven success. Its creative approach supports economic progress and the growth of weak regions. Innovation is at the core of the IBA. Different projects are developed under various themes, such as social, cultural and economic. This causes the transformation of cities and regions that satisfies the expectations of the population.

The City Region of Parkstad Limburg is currently working on a major transformation. The present shrinkage has literally provided room for new initiatives. Due to the increase in internationalization, a focus beyond the borders of the area has also been maintained. These developments offer opportunities for the economy. Parkstad desires to take advantage of these opportunities and to concretely show the changes achieved in successful projects. IBA is therefore used as an accelerator and stage of transformation.

## Studio Parkstad

Studio Parkstad is a graduation studio that has participated in the open call for IBA Parkstad 2020, submitting a proposal entitled "Bicycle Highway Plus." The bicycle highway is a plan that finds its origins in Aachen, Germany. The state of North Rhine-Westphalia issued a contest for a new bicycle highway to connect inputs in Heerlen, Herzogenrath and Kerkrade. The bicycle highway connection of Heerlen, Aachen, is where this IBA project is focused. To increase the attractiveness of the route, a number of temporary and permanent urban initiatives were introduced. These initiatives reinforce the idea and the use of the bicycle highway.

Several projects were developed by six students from the border areas between Netherlands and Germany. One of the projects was developed by the author. This project is located near the Parkstad stadium, at the intersection of the Euregioweg and Heerlerbaan. This area is scheduled for future redevelopment; in the meantime, people can arrange to stay overnight. The Hermit House section provides an entrance to the "forgotten" natural spaces behind Heerlerbaan.

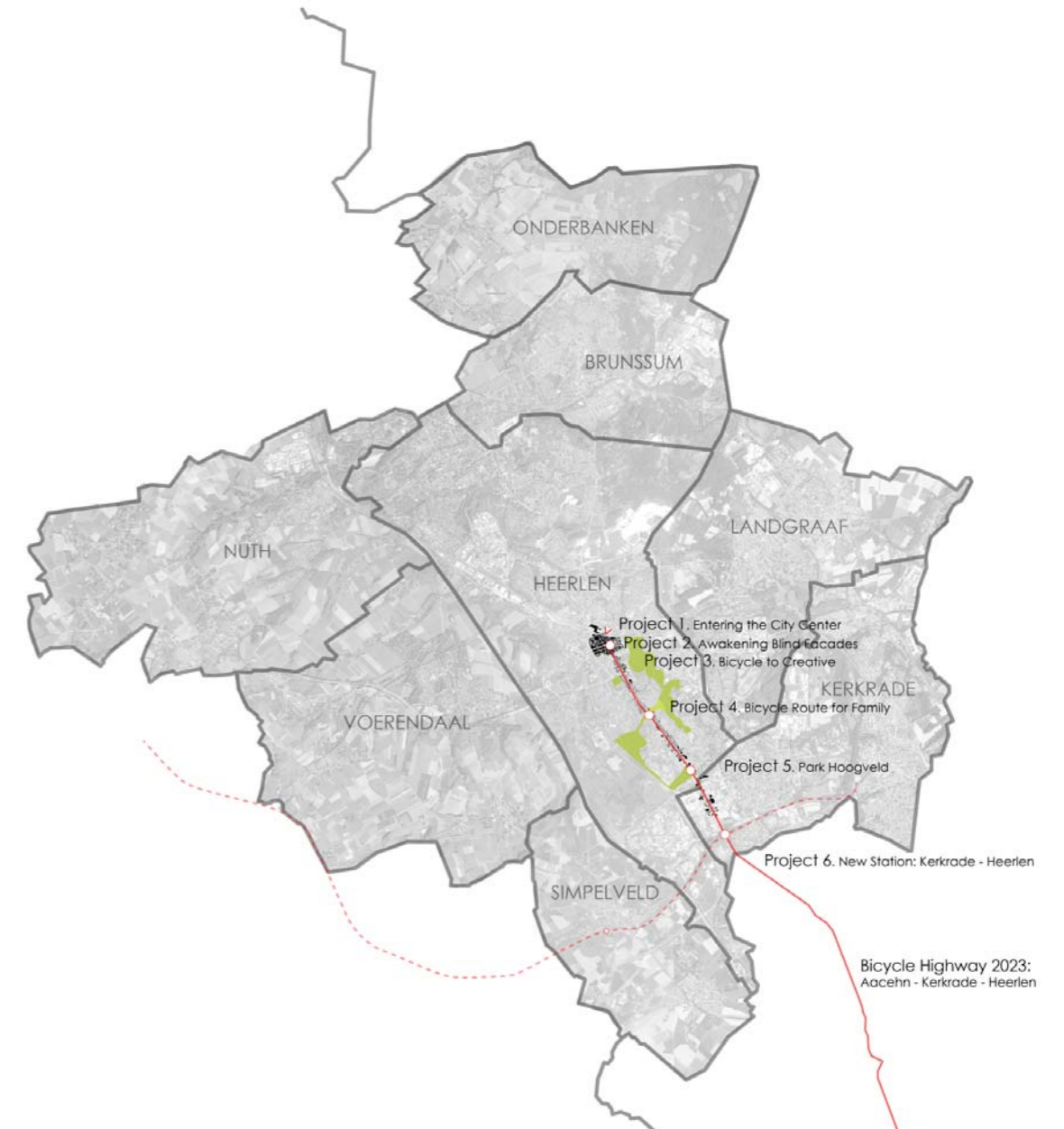

Pic 5: Studio Parkstad graduation projects

The small local economy of Parkstad is struggling. An increasing number of shops in the city center are lying vacant. The local population is not sufficient to maintain the city centers. To encourage a population increase, tourism can provide stimulation and a solution through the involvement of people from outside the region. Subsequently, this could lead to an influx of people, translating into an increase in customers and growth. Therefore, it is necessary that people from outside the region will come to visit Parkstad.

The tourism sector has great potential. South Limburg is an attractive location for domestic tourism. It is strategically located in an international region between Germany and Belgium. This strategic location can be used to realize the studio Parkstad vision, along with the Hermit Houses, in an extensive plan.

The plan to place temporary Hermit Houses (designed by the TU/e through the study of Mark of the Net and Daniel Venneman) in vacant public spaces can be permanently accomplished by using the same concept as that used in tourist recreation areas. In order to achieve this plan, a strategic location will be carefully selected from places where facilities are already present. For example, local recreation areas will be used to involve people outside the Parkstad region.

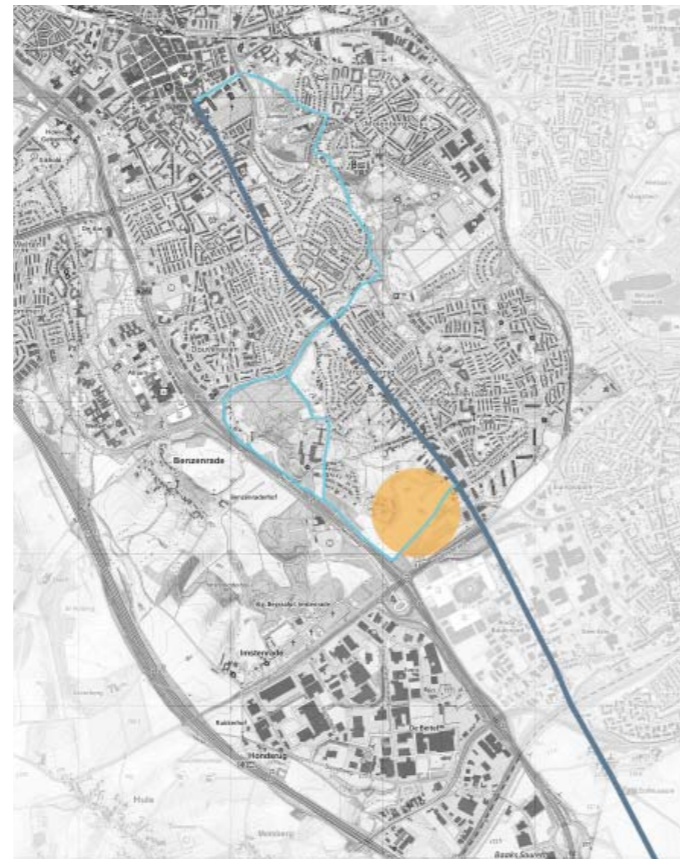

Pic 6: Location Hermit Houses



Pic 7: Entrance from Heerlerbaan



Pic 8: Hermit House in situation

## Touristic demography

## South Limburg tourism

The province of Limburg, during recent years, has not been viewed as an attractive place to live. However, as it is a special area in the Netherlands with its own landscape character, it is an attractive region for tourism. According to the “Tourism Trend Report Limburg 2013 – 2014” (TTRL, 2014), Limburg is the second-most popular vacation location for the Dutch, in terms of overnight stays, after Gelderland. According to the report, holidays in Limburg have decreased slightly, by a rate of 7% per year; however, the number of overnight stays has slightly increased. Limburg has remained in first place concerning city breaks and bungalow holidays, with the Dutch staying for almost half (49%) of their holidays in a bungalow in Limburg. This is significantly more than the Dutch average (36%). In regards to city breaks and bungalow holidays, a distinction should be made between the regions in South Limburg. The types of holiday vary from one region to another. Hotel holidays are more often chosen in South Limburg. In northern and central Limburg, bungalow holidays are popular. During 2013 – 2014, the number of guests who stayed in hotels was 52%, and in bungalows 40%. For foreign guests, bungalow holidays are the most popular, with 60% of all foreign guests spending their holidays in a bungalow. This is because the average stay in a bungalow is longer (4.3 nights) than in a hotel (1.7 nights).

Three separate regions of South Limburg can be distinguished. These are Maastricht and surroundings, hill country and Parkstad Limburg. These three regions have their own urban, architectural and landscape characters. In the tourist profile, it can be seen that these characters have a marked effect on the choice of location. In this way, Maastricht and its surroundings attract young people especially, and those who want to have a short city break. This area is attractive for young people because many young audience is present of his student city profile. The Limburg hill country is popular with the elderly demographic because of its cultural, architectural and historical sights. It is also a region with its own landscape character. Many parks exist where a large number of elderly people come to rest and relax. Although Parkstad is a new town that has lost its historic architecture, the city is known for its many attractions and events.

*(source: Toeristische Trendrapportage Limburg 2013-2014)*

## Region Karakter

- Maastricht**
  - cultural history
  - city break
  - shopping
  - young people
- Heuvelland**
  - landscape
  - green attractions
  - Limburg landscape
  - rest
- Parkstad**
  - modern urban character
  - entertainment





Strategy

*Parkstad has invested in the recent years in a number of attractions to attract people from outside the region. These are mostly major projects and outdoor places.*

## Main attractions

Parkstad has heavily invested in recent years in major attractions and entertainment under various themes, such as music, shopping, family, sports and culture. Some examples of this are SnowWorld, GaiaZOO, Continium Discovery Center and the residential boulevard.

Only a few years ago, SnowWorld Parkstad was the largest indoor ski slope in the Netherlands, and GaiaZOO the only zoo that was built in the 21st century. Large music events take place annually, such as Pinkpop Megaland. The cultural history of Parkstad is known for its mining museum, but Limburg also has a rich Roman past. The Thermenmuseum (Roman bathhouse museum) is an important cultural attraction.

Attractions under the themes of culture and shopping are situated in central Parkstad. The large solid family and sports attractions are scattered throughout the urban area, bordered by green recreational space.

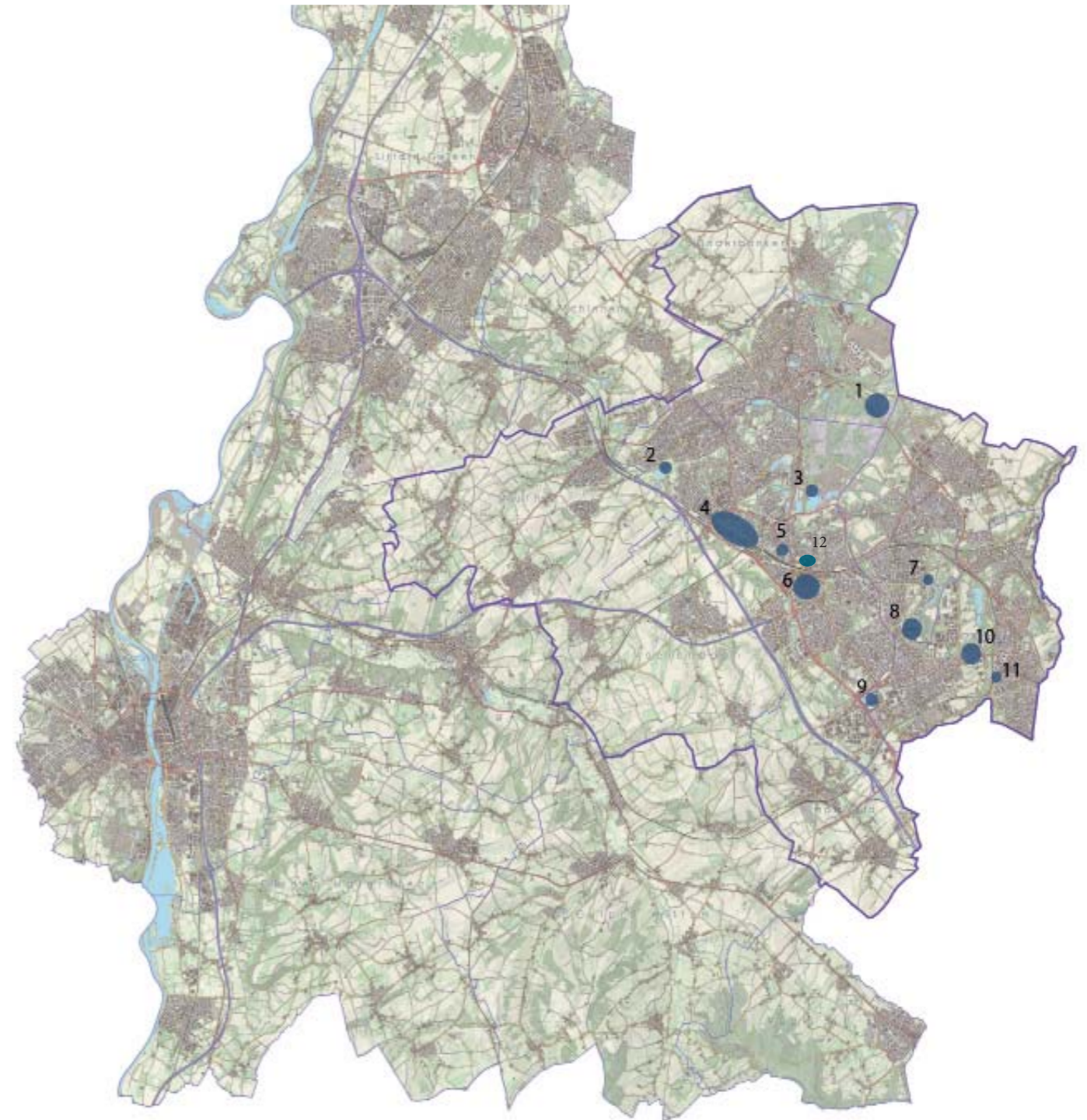

- 1: Bare feet park
- 2: Castle Hoensbroek
- 3: Heienhoven
- 4: Furniture mall
- 5: Mine museum
- 6: Heerlen center
- 7: Mondo Verde
- 8: SnowWorld
- 9: Sportpark Kerkrade
- 10: Gaia Zoo
- 11: Continium discovery center
- 12: Thermenmuseum



*Parkstad Limburg is an old southern region which has many cultural sights. This mainly involves churches, castles and museums. Of course also the mines history that has brought Parkstad to the modern day.*

## Sights of Parkstad South Limburg

The history of South Limburg begins with the Roman Empire, and there are currently many active archeological excavations underway. The Thermenmuseum is one example of this. In addition to the Roman heritage, there are numerous other sights in Parkstad.

Spiritual and religious buildings, such as churches, monasteries and basilicas, are interspersed among modern buildings in Parkstad. These buildings have stood since the 11th and 17th centuries. The architecture of the Renaissance, Baroque, Neo-Romanesque, Gothic Revival, Neo-Renaissance and Neoclassicism periods can be experienced. Many public buildings, such as town halls and museums, are also built in these styles. These buildings are either Dutch or are international monuments. One example of the latter is the former diocese building of Rolduc Abbey.

Rolduc Abbey in Kerkrade is one of the most important religious monuments in the Netherlands. Rolduc is the largest abbey complex in the Benelux, and is on the UNESCO list of the 100 most important monuments. The abbey has a rich history of over 900 years, and is thereby a world-famous tourist attraction.

- 1: BloteVoetenPark
- 2: Castle hoensbroek
- 3: Golf course Brunssemheide
- 4: St. Vincentiuskerk
- 5: St. Barbara-kapelletje
- 6: Walking Areas Gravenrode and Brunssumerheide
- 7: Visitors center Brunssumerheide
- 8: Kasteel Meezenbroek
- 9: Family Amusement park Mondo Verde Landgraaf
- 10: Kloosterkapel
- 11: Kasteel Eyckholt
- 12: St. Pancratiuskerk
- 13: H. Johannes de Doper
- 14: Kasteel Strijthagen
- 15: Nederlands Mijnmuseum
- 16: H. Antonius van Padua
- 17: Streythagermolen
- 18: St. Lambertuskerk
- 19: Landgoed Brunssheim
- 20: De Oliemolen
- 21: Kasteel Terworm
- 22: hoofdkerk van Heerlen
- 23: Abdij Rolduc

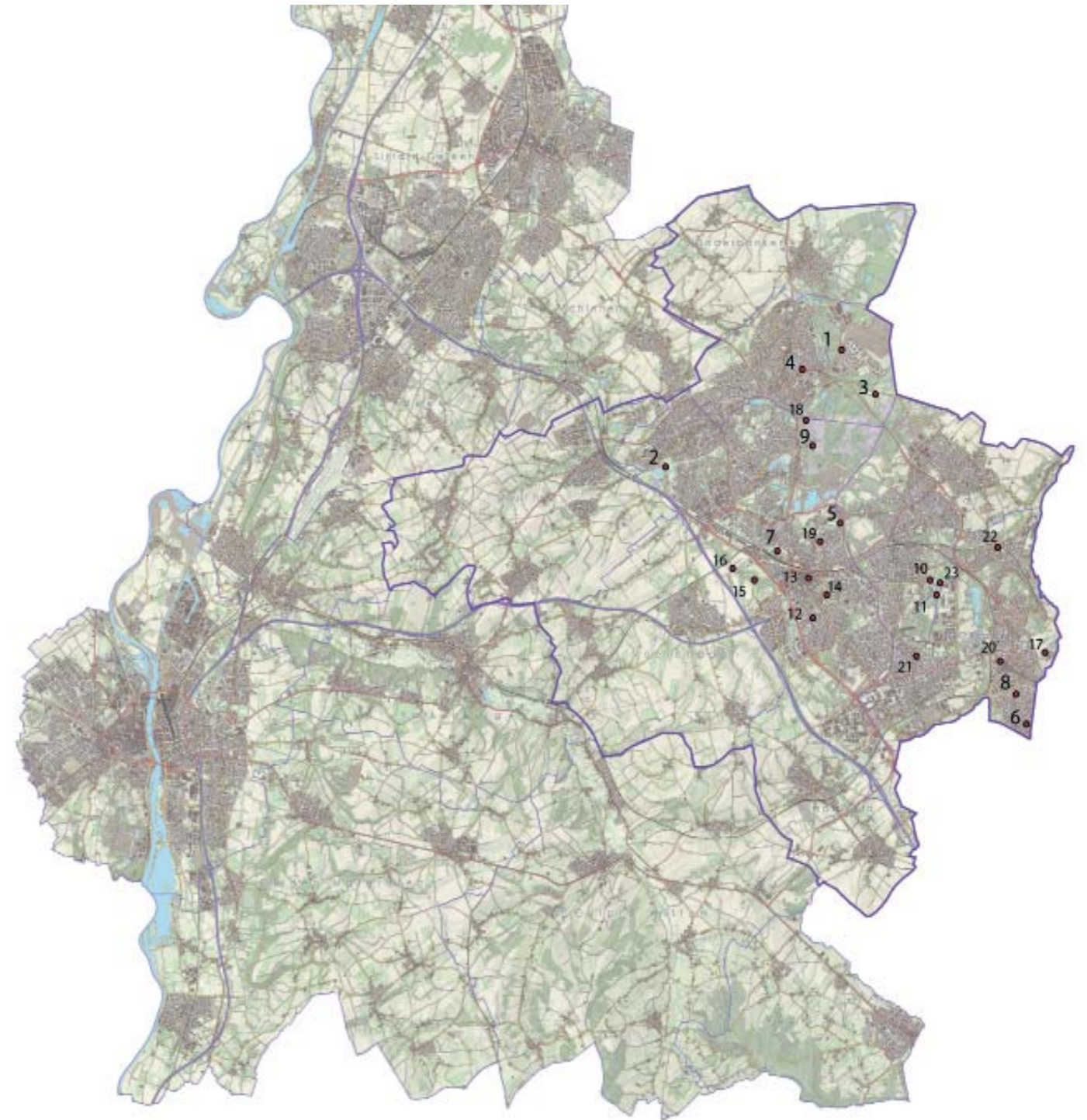

South Limburg landscape character is within Parkstad noticeable. Within the urban space, it has plenty of green recreation areas, where the Limburg landscape character is obvious. There are also self-created landscaped parks where people can undertake recreational activities.

## Open recreation areas

Parkstad has a unique structure. The urban area has a conjunction with the landscape character, thus creating a unique internal coherence. This is reflected in the infrastructure and urbanization of the region. Natural areas are largely protected, as each park has its own identity and character. Some of these areas are afterwards constructed by people.

The green areas enclosed by the urban structures perform a recreational function. Brunssmheide is a large park containing a number of recreational functions. Another green area is that of Park Gravenrode. This park has changed from a recreational area into a tourist recreation park. There are several attractions built around this park.

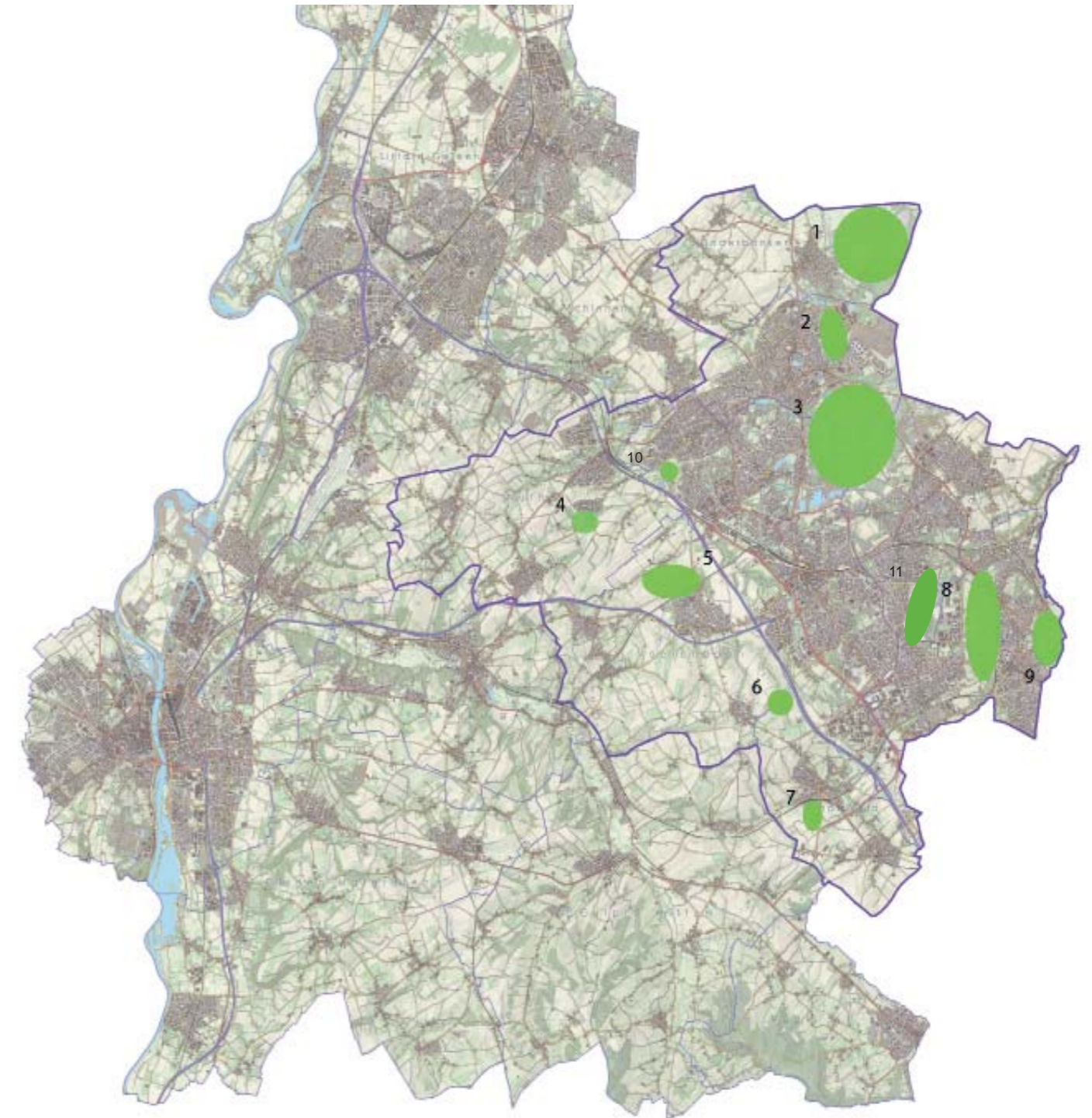

- 1: Natuur- en Landschapspark Rodebach
- 2: Schutterspark
- 3: Brunsummerheide
- 4: Kasteel Wijnandsrade
- 5: Archeologisch Landschapspark Voerendaal
- 6: Land van Kalk
- 7: Gebied nabij station Simpelveld
- 8: Kasteel Schaesberg
- 9: Eurodepark Kerkrade
- 10: Kasteel Hoensbroek
- 11: Park Gravenrode

As mentioned in the previous chapter, Parkstad has developed for the next 10 years a touristic vision 2020. The goal is to connect the graduation project in the touristic vision 2020. In this chapter, various tourist facilities as cultural and historical attractions will be analyzed, in order to arrive an strategic location and accommodation type for overnighting.

### Available accommodation types

There are several types of accommodation available, including hotels, bungalows, holiday houses, villas and apartments. In deciding on a type of accommodation, the location, purpose of stay and the regional facilities are considered. Limburg distinguishes itself in regards to breaks, nature and tranquility. For this reason, the region has achieved first place regarding city breaks and bungalow holidays.

The A76 highway runs through Parkstad, which separates the region into two areas. On the left stands a large green space, and on the right an urban area. The analysis showed that the existing accommodation facilities have played here on in. In the green space standing just a view hotels while there are more holiday houses are located. In urban areas, they are found in green areas and spread over all eight municipalities. Unlike holidays homes, hotels are short, stand side-by-side and are centrally located in Parkstad. When each municipality is examined, it can be observed that Heerlen and Landgraaf are attractive hotel locations.

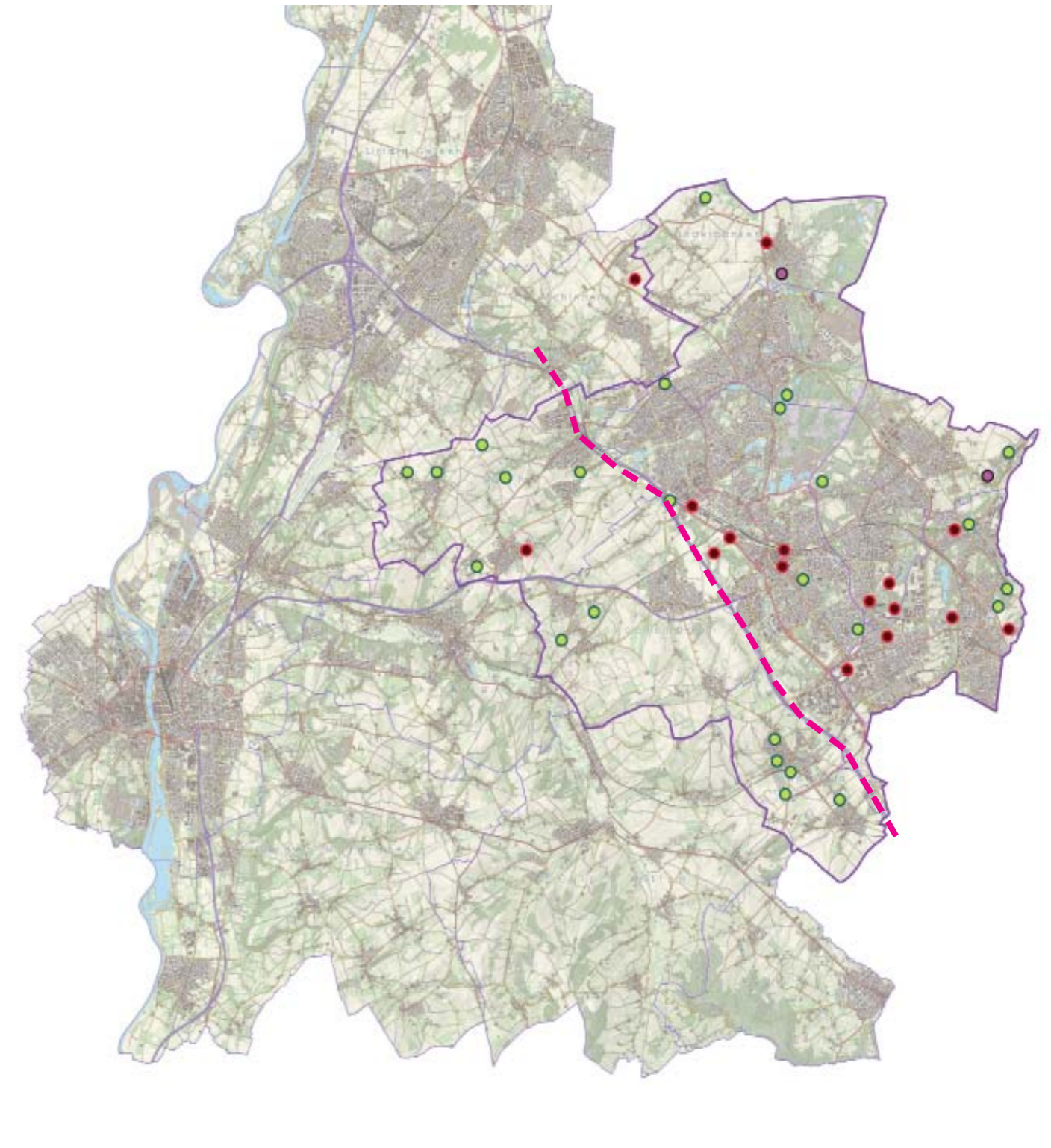

*Comparing the location of attractions and sights towards the hotels. This enables to determine how the existing hotels have situated themselves in relation to the attractions.*

### Location attractiveness

When all these elements are combined, it can be assumed that two strategic locations are created. In the municipality of Heerlen, hotels are located around the downtown region. In the southeast of Parkstad in Landgraaf, some hotels are located next to major attractions. It can be assumed that Heerlen stands out in shopping and sightseeing, while Landgrave has a larger tourist recreation function. The aim of this study was to add value to the tourism sector. Therefore, this study will concern the area of Landgraaf.

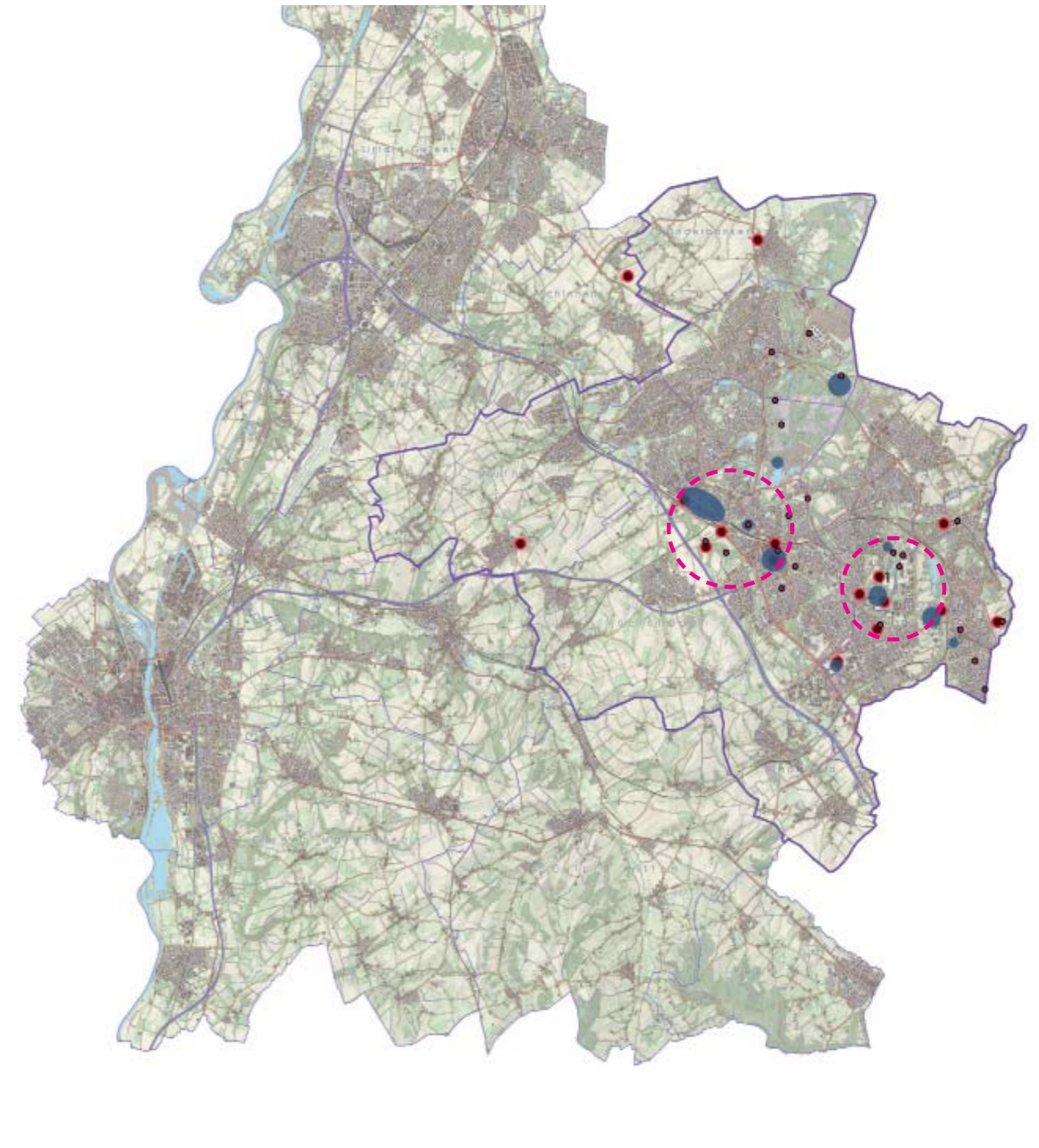

Muzik: 15 - 35
shopping: 25 - 60
family: with children till 12
sportive: 18 - 40
culture: +45

Tabel 1.1:Themas of entertainment:

## Location choice

When choosing a location, the following factors are desired: interconnected accommodation, sights, main attractions and catering establishments, creating a high quality stay-accommodation experience. The three clusters were separately analyzed and mapped. In order to achieve the quality required, different clusters must be easily accessible. Under the theme “City of Entertainment,” main attractions were used as the principle source for the determination of the strategy that later determined the location and accommodation type. Creating new competition for the existing tourist accommodations should be avoided.

The attractions differ from each other. For example, the residential boulevard is not similar to the GaiaZOO. It was therefore important that the focus was on the target audience. The target group choice will ultimately be determinative of the attractions that will be established.

Due to the shrinkage, Parkstad is aging, as the city is no longer attractive to young people. The recreation facilities are therefore struggling. Maastricht and its surroundings attracts many young people; the hilly landscape is attractive to older people who seek tranquility. Parkstad is attractive to both young people and adults. The reason for this is that Parkstad offers various recreation possibilities under different themes. Examples include the annual music festivals such as Pinkpop, shopping in the city centers and sports recreation at SnowWorld.

In the table above (Table 1.1), the attractiveness of different teams according to age group can be observed. Parkstad has an aging population; therefore, the aim is to attract more young people. The themes are therefore being attractive to young adults and to families with children. Competing with this region is possible; however, the aim here is to make use of the identity of Parkstad as the City of Entertainment and present this to a specific group of people.

The target audience chosen was that of young adults and young families with children. Pinkpop Megaland, the family park Mondo Verde, SnowWorld, GaiaZOO and Discovery Center Continium are the most famous attractions in Parkstad that are attractive to this audience.

Park Gravenrode is a tourist recreational area in Parkstad. It is centrally located and offers a large variety of nature and landscapes. The presence of the streams, ponds, extensive hillside forests, castles and old farms, makes it a public park as well as a recreational park. Due to its central location in Parkstad, it is surrounded by attractions and is an ideal location to establish the property.

As mentioned above, Limburg holds first place with regard to bungalow holidays. In Parkstad, the bungalows are located outside the urban area. In order to provide an alternative way of staying within existing boundaries and to avoid creating competition with the existing forms of accommodation, small holiday homes were chosen in which young families with children can spend their vacations.



Pic 10: pinkpop Megalang



Pic 11: Mondo Verde



Pic 12: SnowWorld



Pic 13: Discovery Centrum Continium



Pic 14: Gaia Zoo

## Location approach

## Location development

Park Gravenrode is not only a tourist area in Parkstad. Due to the large redevelopment, the EDEN Award 2009 was awarded to Park Gravenrode. Park Gravenrode is a green recreation area on which people have had an influence. During the mining period, the park was a hotch-potch of mining areas, mining production companies and mining slag heaps. Around these companies lay a green field named "Green Rest." The park was surrounded by working class neighborhoods that grew rapidly through economic development. (van Vuurde, L. 2009)

After closure of the mines, the park evolved and was redeveloped into a recreation area. Facilities arose, including the racecourse, sports park and ponds. On the non been dug mine slag heap, a brush track was built for skiing; a pool was constructed at Castle Erenstein, and several other provisions for tennis, hockey and football were created.

Beginning in 1995, Park Gravenrode was again redeveloped into a tourist recreation area. The racecourse was transformed into the event area Megaland, in which the racecourses were replaced by cycling tracks and inline skating rinks. In place of the brush track, the SnowWorld complex was built. Strijthagen castle was bought and the environment was developed into the World Gardens of Mondo Verde. The swimming pool and sports courts of Erenstein were replaced by the GaiaZOO. (van Vuurde, L. 2009)



PIC 15: Park Gravenrode

## Location approach

A pack consists of segments or clusters in which an experience or activity takes place. In this area, visitors can experience being required to perform an activity.

The park is separated by a passageway which passes through the middle. This creates two zones. On the west side of the park there are attractions, and on the east side an open green recreation area. There is no direct connection because there is no access between the two zones. Instead of a zone boundary that connects the two zones, the path serves as a dividing factor that has been strengthened by a fence placed along it. The core of the park consists of different water surfaces running the length of the park. The water surfaces provide a contrast to the heavily wooded area.





The Park is enclosed by roads. On three sides by main roads and on one side by a narrow harden road. The park can partly be driven in by car through two points. Further it consists of cycle paths and walkways.



Main entrance road to the park



Due to the blockage, the is park limited accessible for drivers.



A large industrial area is located on the east side of the park. Through this road, the park will be separate from the industrial terrain.

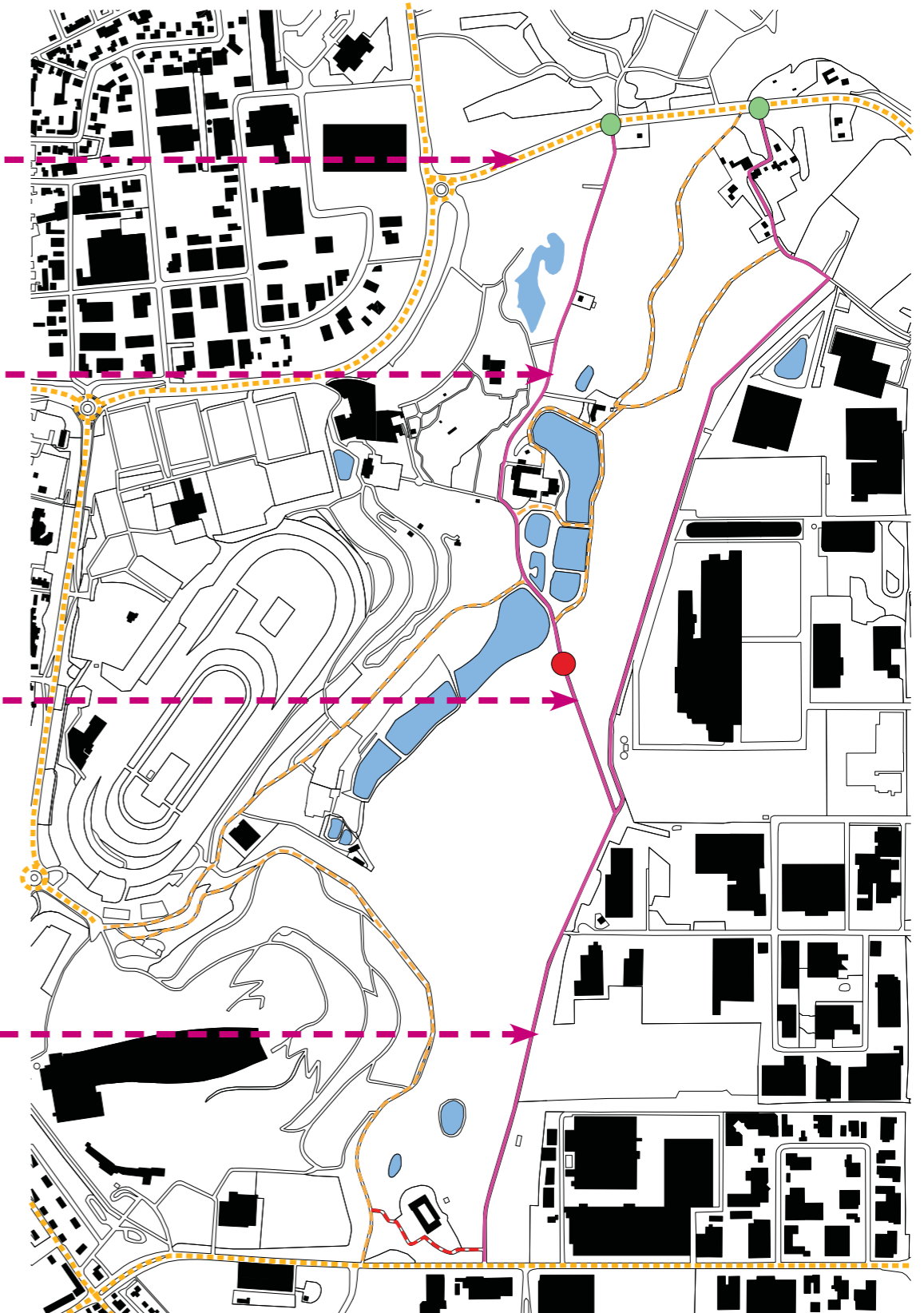
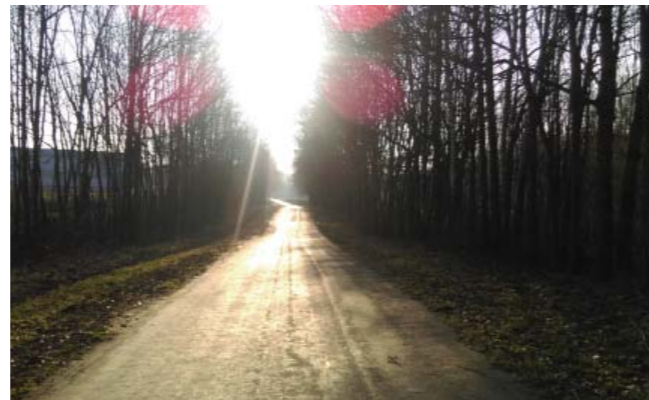

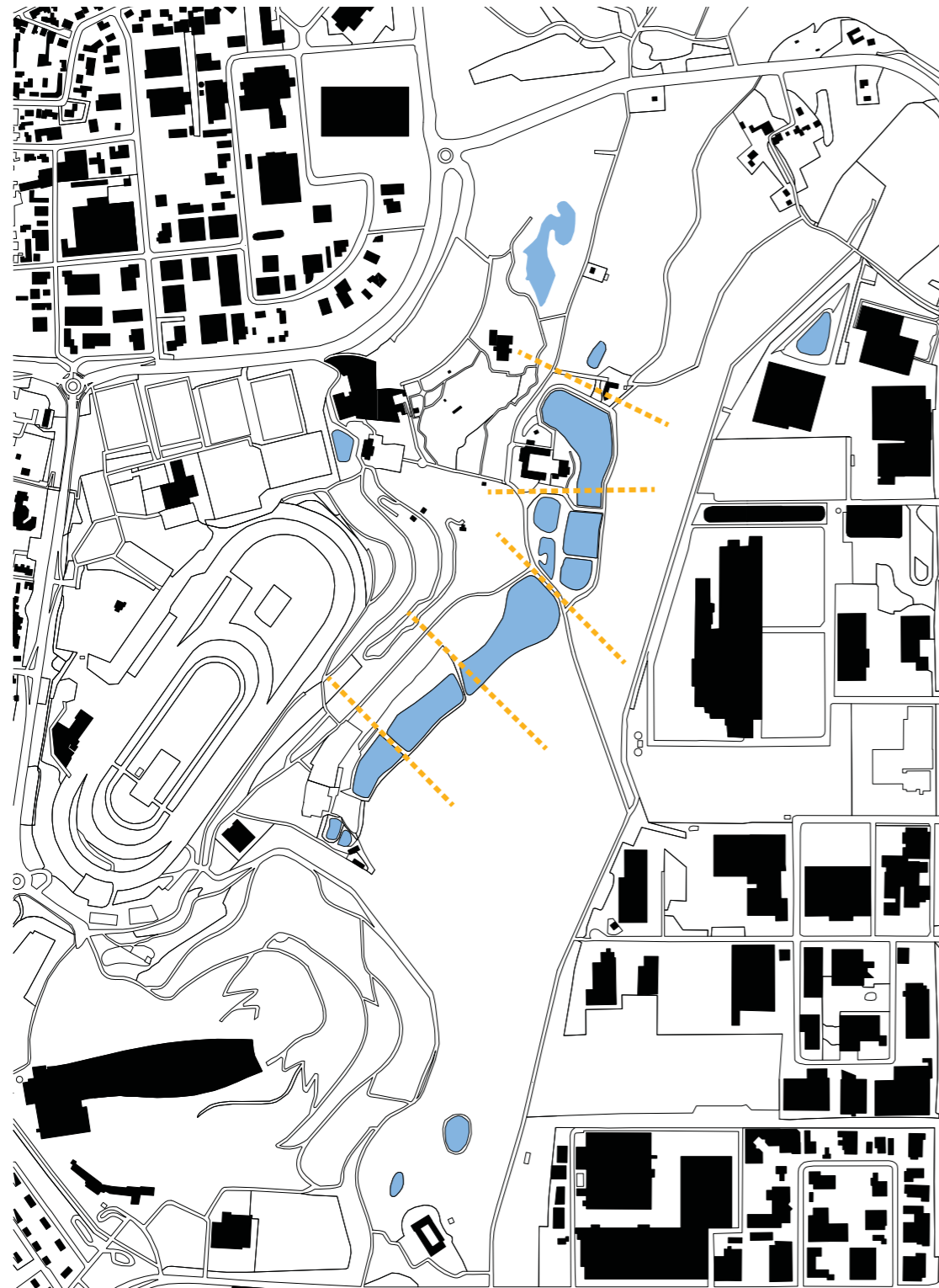

Between the watersurfaces are sight lines. These strengthen the separation between the watersurfaces and causing an arise of different experiences.

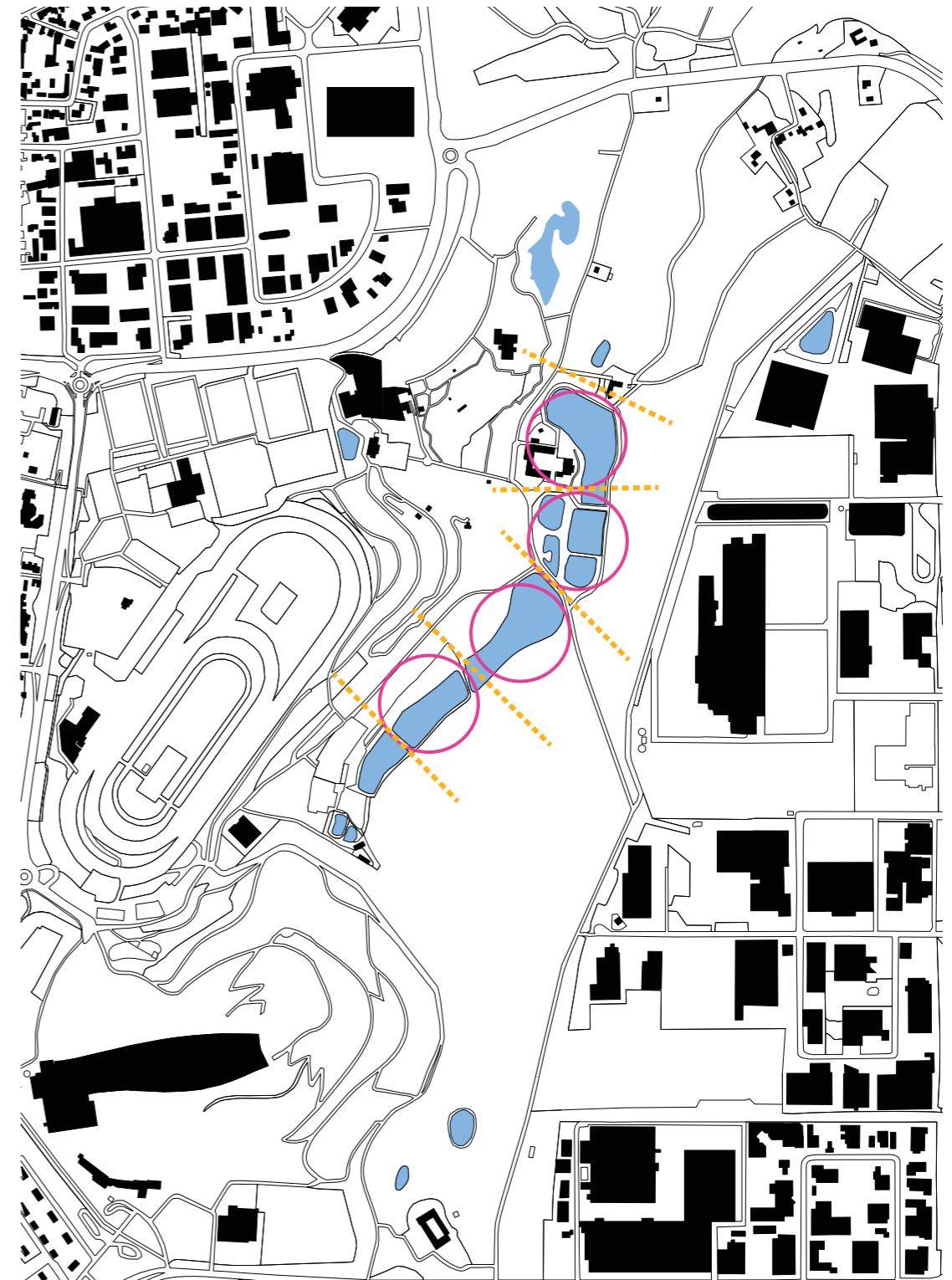

By the combination of sight lines with water surfaces, creates park rooms.

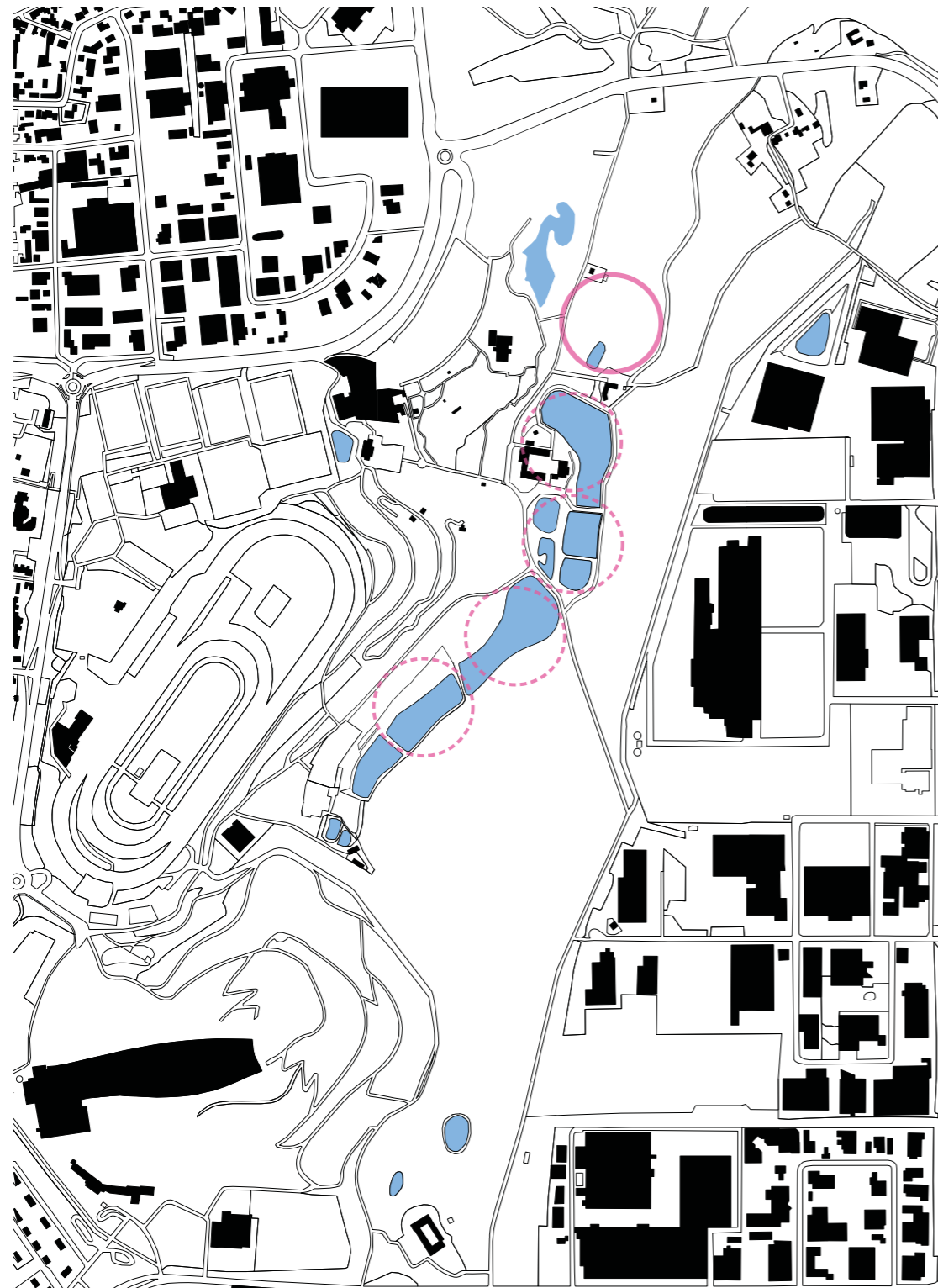

The core of the park consists of four park chambers. In the north of the park we create a new chamber by placing the

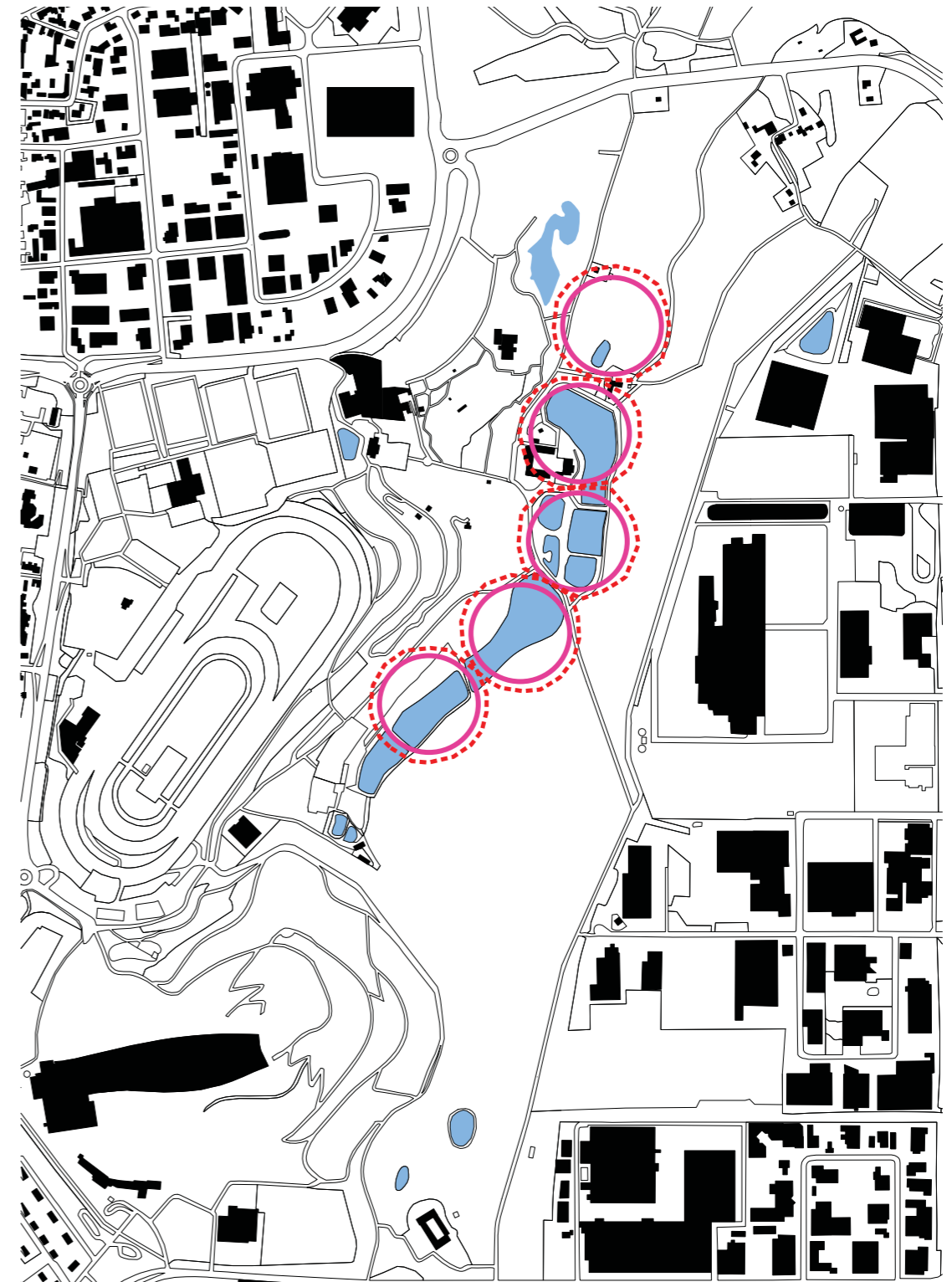

The continuous line of chamber is put through.

Design

## Concept

The location is next to the Rouenhof. The space is partly enclosed by a forest area. The open spaces that remain create sight lines that allow a view over parts of the park. The trees act as a wall, blocking visibility. The design will be pressed against the trees and the front direction to the open spaces in order to allow a view over the area. The blockade of the trees creates three different zones. These are the design zones in which the buildings with different functions will be placed.

In zone 1, the main building will be placed where communal activities, facilities, service, storage and management of the park will be housed.

Zone 2 is located in a V-shaped containment area, from which it has a view of the space. A group of bungalows will be placed here.

Zone 3 is located on the Rouenhof. This zone is a connection to the main road and is only accessible by car. The bungalow park will be accessed through zone 3, which is ideal as an entrance.

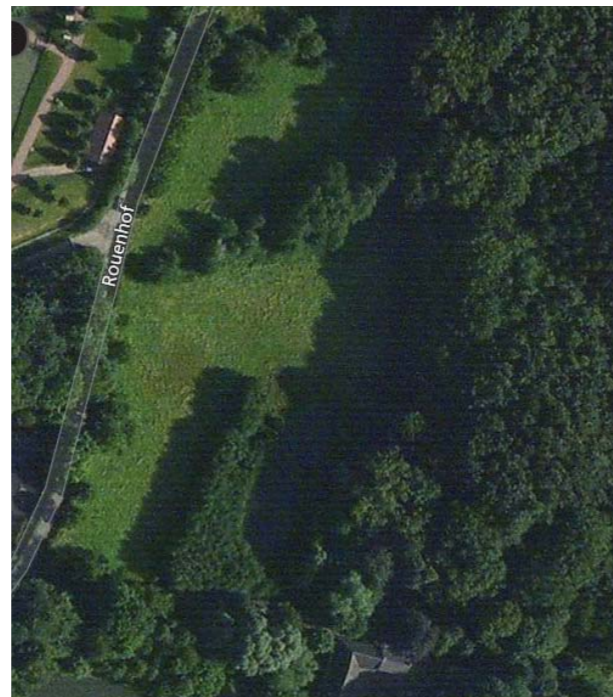

Pic 16: Top view situation

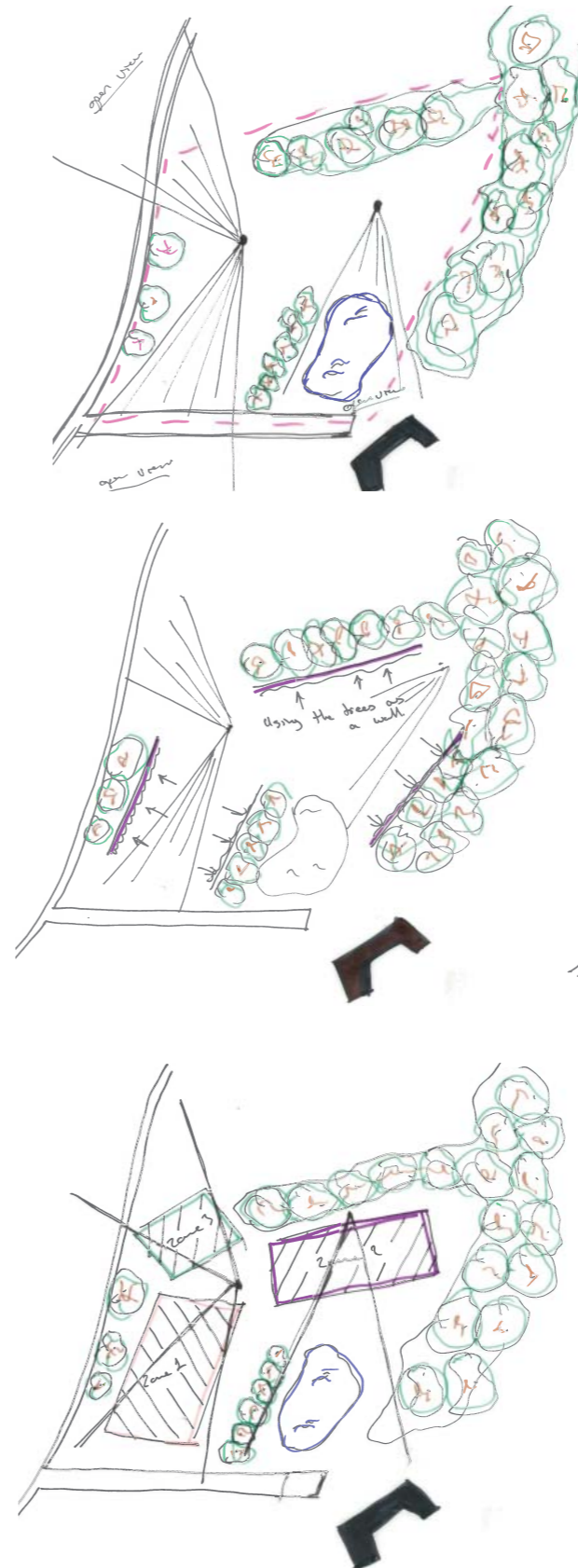

### Inspiration

Barn-style buildings have developed in modern architecture. Within the classical form, the building can be adapted to the environment through the use of modern abstract architecture or by worked with the environment without any aesthetic resistance. The structure of barn buildings involves high façades and short lengths and widths. Because of the large façade surfaces, large openings can be constructed to create spaciousness. Barn buildings can offer the opportunity to combine several functions into one space through their wide open indoor spaces. This makes a barn flexible.

### Design

The architecture and construction of the design is in response to the environment. An abstract building will be constructed in a natural green environment. The design consists of two different buildings; the houses have three different formats. The main building is a public building in which multiple functions are placed. This building will serve as parking, catering and leisure facilities. The small houses will serve as rentable holiday bungalows.

### Architectural approach

The basic form of the building is a farm barn with a modern architectural approach. The publicly accessible space is aesthetically strengthened by increasing the volume in relation to the section where the office facilities and storage of goods will occur. The building has a solid façade finished with wooden lamellae. The lamellae will run the length of the wall to the roof in order to form a cohesive part. A number of windows in the facilities section will be boarded up behind the lamellae, as these will not offer added value to the experience of the guests.

### Interior space

The building is accessible by a large open glass façade. Behind the façade stands a lobby containing a fireplace. This will create a welcoming atmosphere for the guests. The space is 45 meters long and 13 meters wide. The ground floor consists of three zones, in which a bar, louche and a lobby will be contained, respectively. The zones are separated from each other by floor heights. The floor heights provide a separation without losing the feeling of spaciousness. The same principle will also be applied to the second floor, through the use of an atrium. By centering the atrium, the volume of the spaciousness is strengthened and connects the levels.

The vacation homes consist of a kitchen, bedroom, sanitary room and a living space. Each type of accommodation has its own interior design. House type one has three bedrooms, a central kitchen and a living room located at the front. Unlike house type one, in house type two the living room is central and there are two bedrooms. House type 3 multifunctional adjustable. Due to the varying house types, the light and views of the surroundings will be taken into account. They can be placed in any position and in any direction by combining them in different positions. In addition, a guest can choose an accommodation type depending on the size of their family.

### Construction

A decision was made to hide the construction due to the modern solid architecture used. The main structure of the building is made from steel. The long distances can be bridged without making the columns and beams visible. The parking and the basement foundation consist of concrete. The point load pressures are transferred by concrete footings.

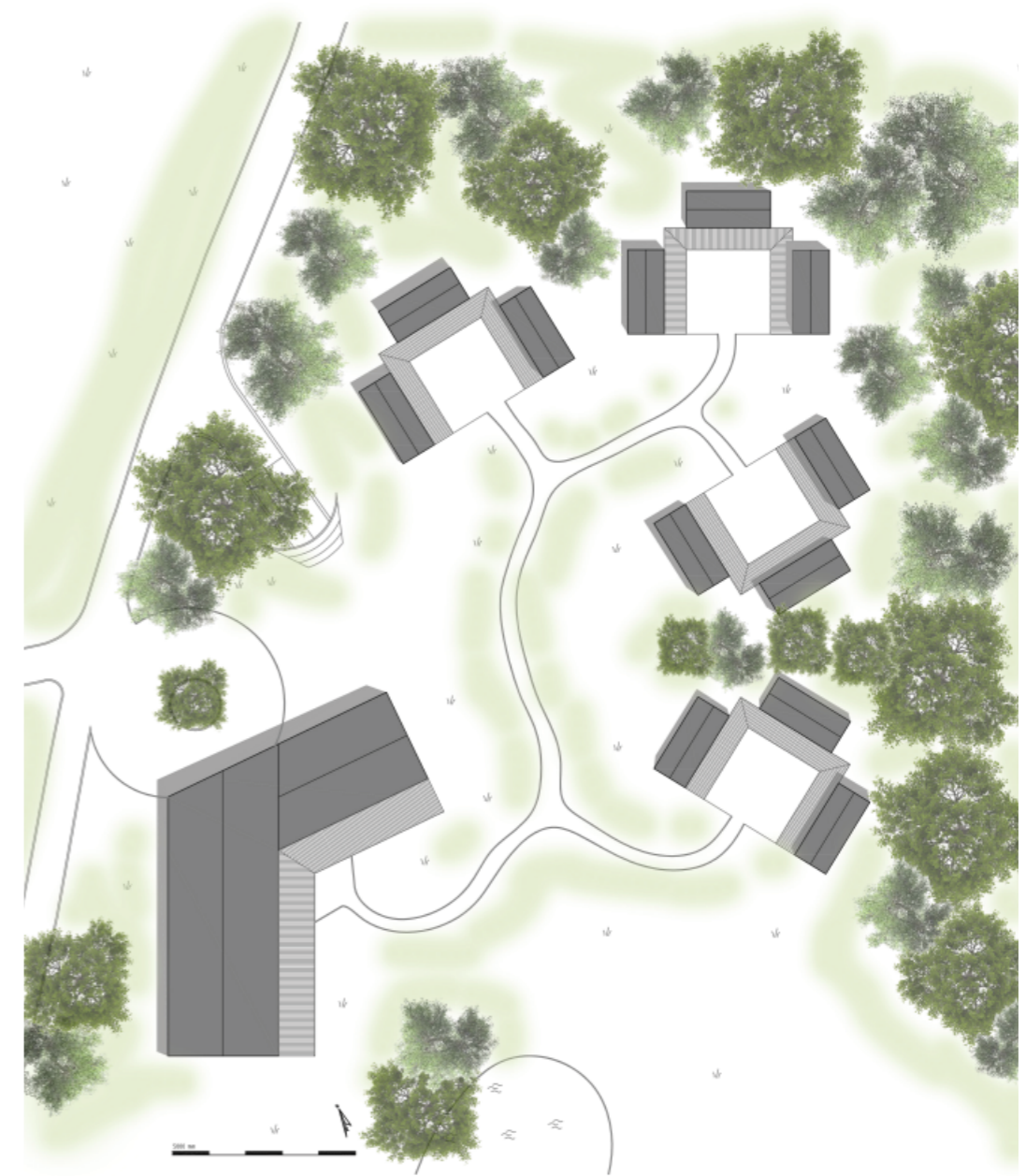

## Drawings

Main building facades

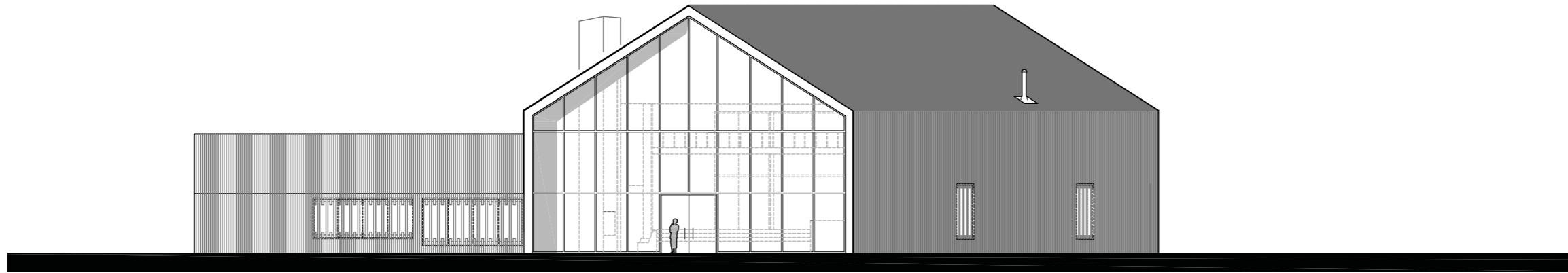

entrance- front view

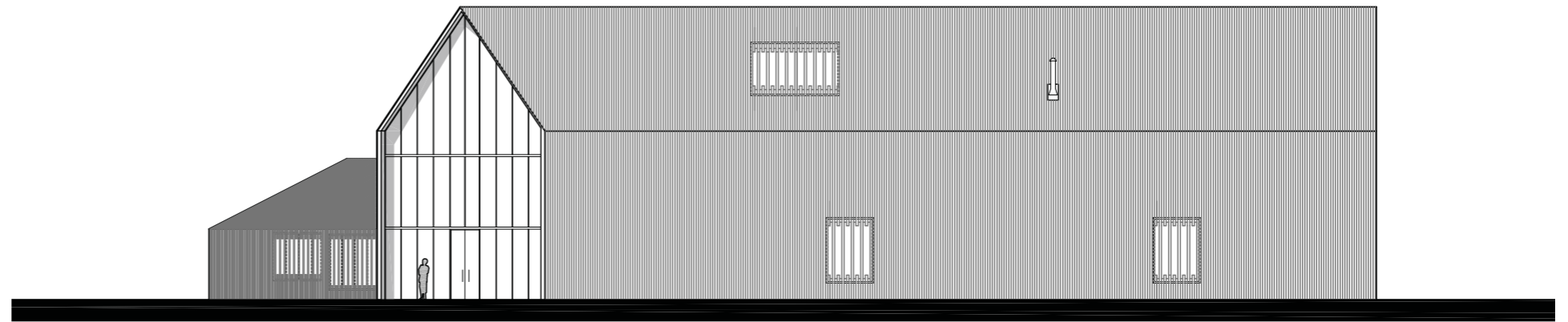

front rear view



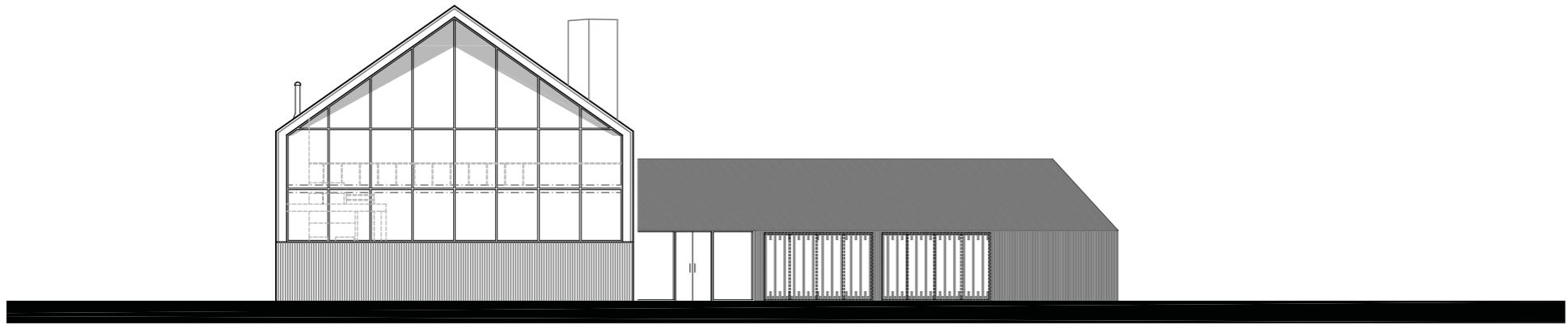

right view

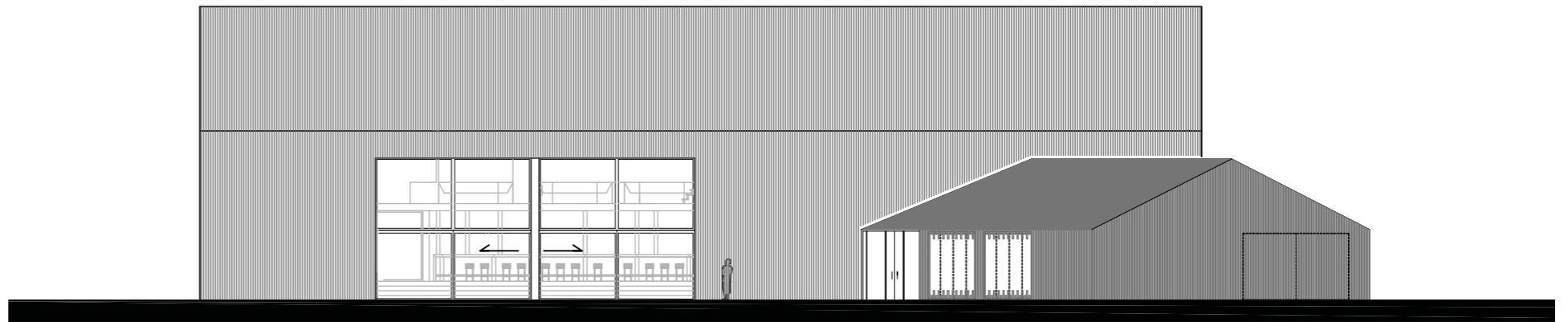

back view

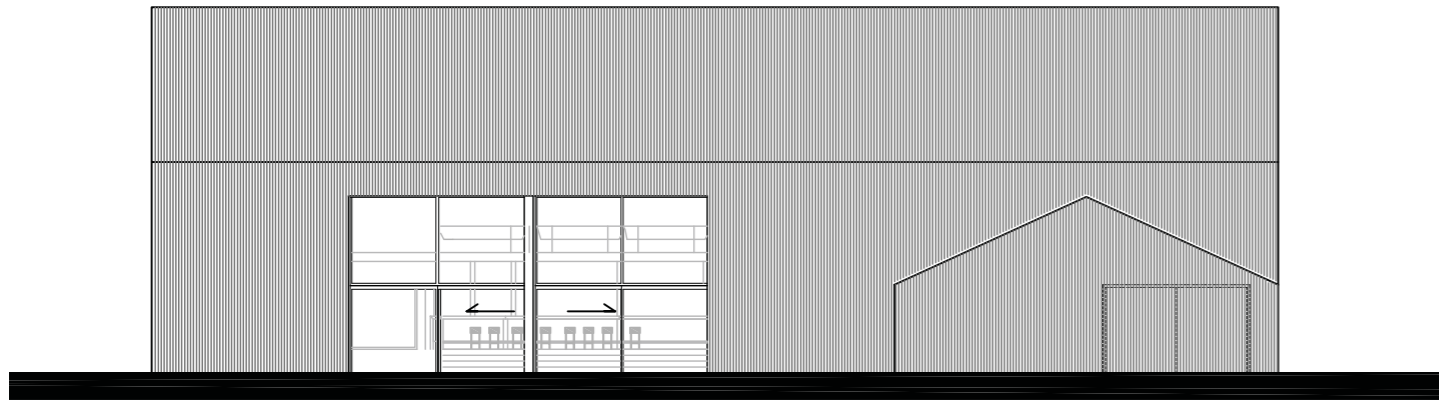

right back view

Floor plans

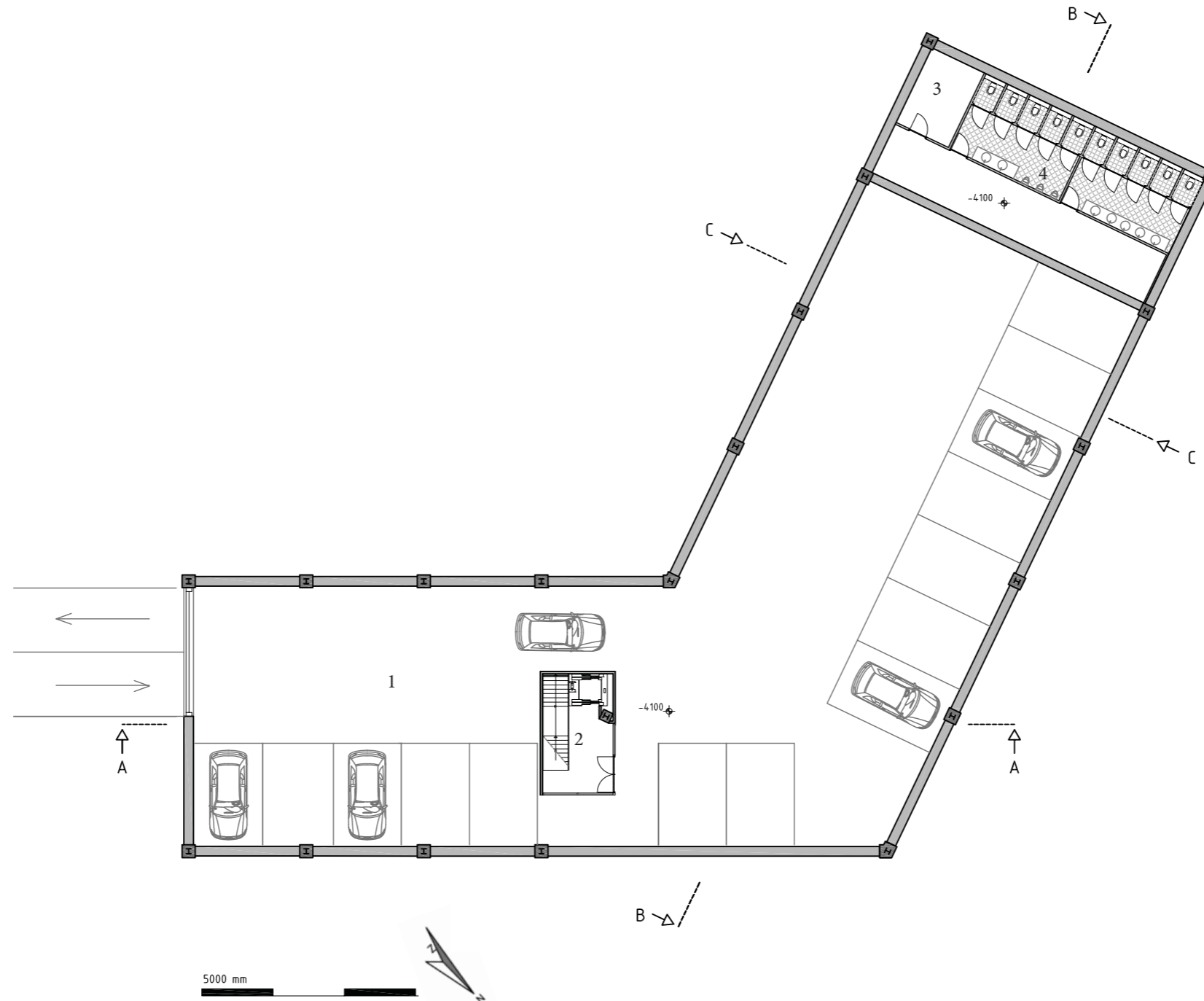

-1 Parking

- 1 parking
- 2 staircase
- 3 material storage
- 4 restroom

Ground floor

- 1 storage
- 2 laundry
- 3 restrooms staff
- 4 cantine
- 5 office
- 6 lobby
- 7 reception
- 8 bar
- 9 kitchen
- 10 louche

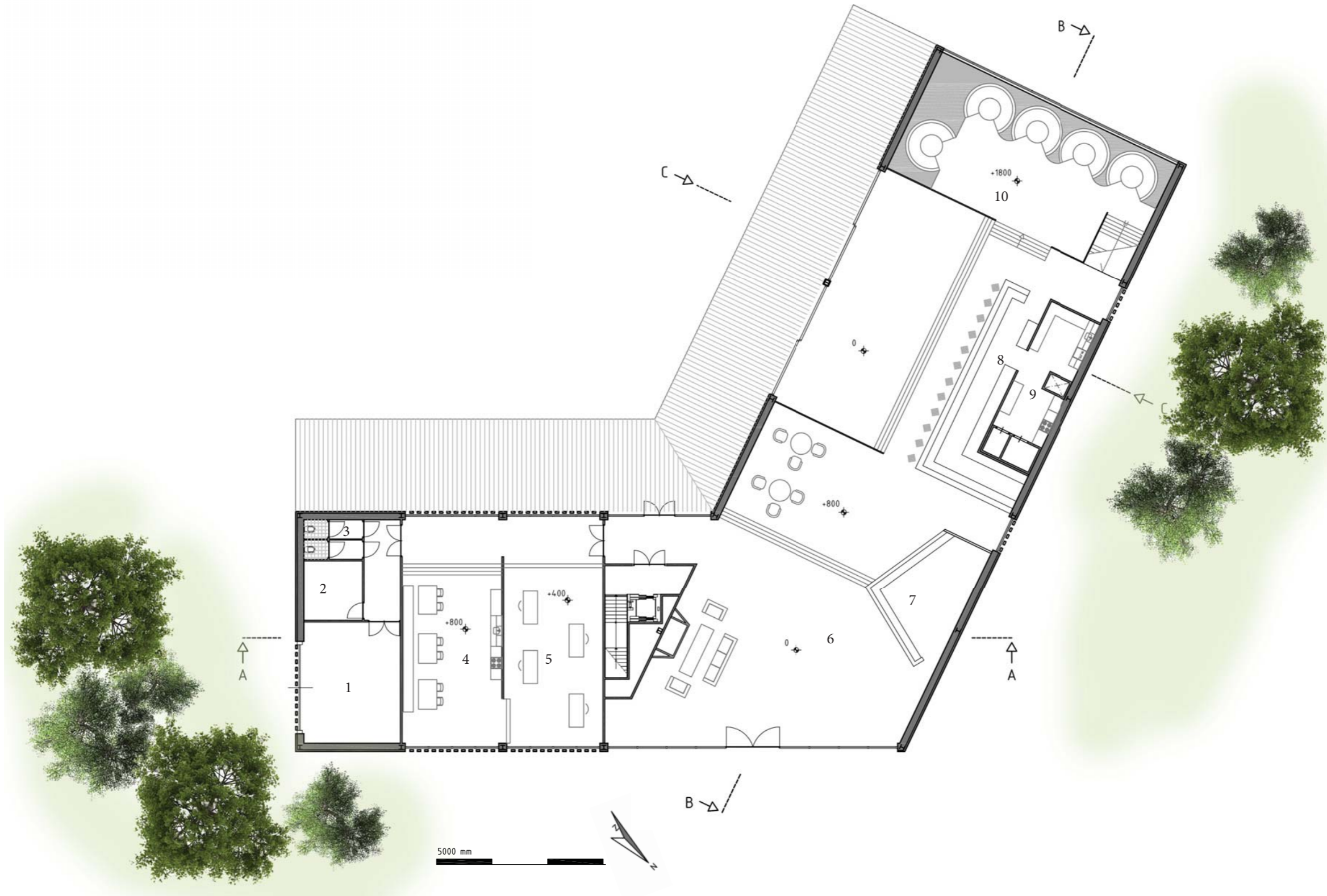

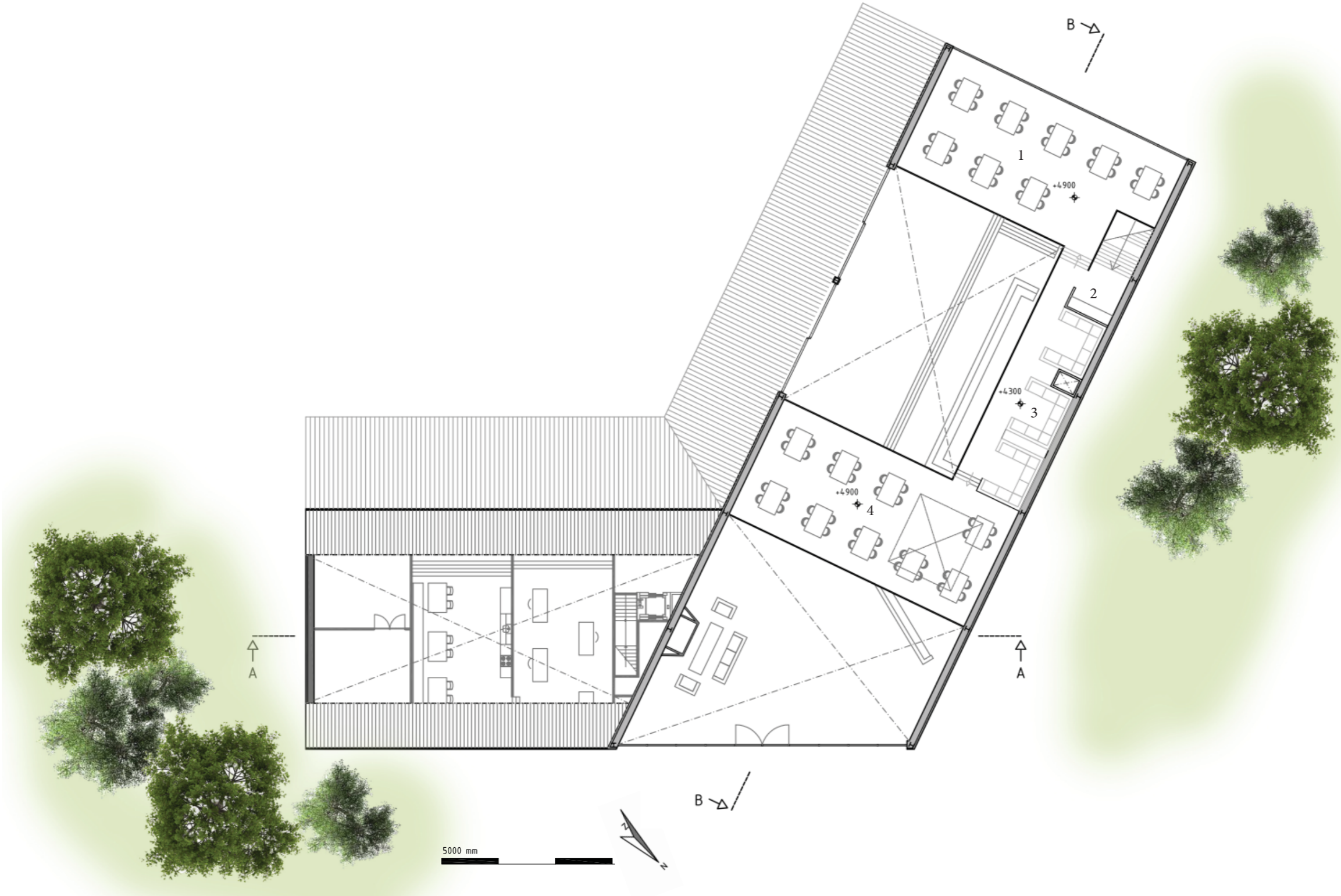

First floor

- 1 dinner area
- 2 waitresses corner
- 3 lounge dinner area
- 4 dinner area

Sections

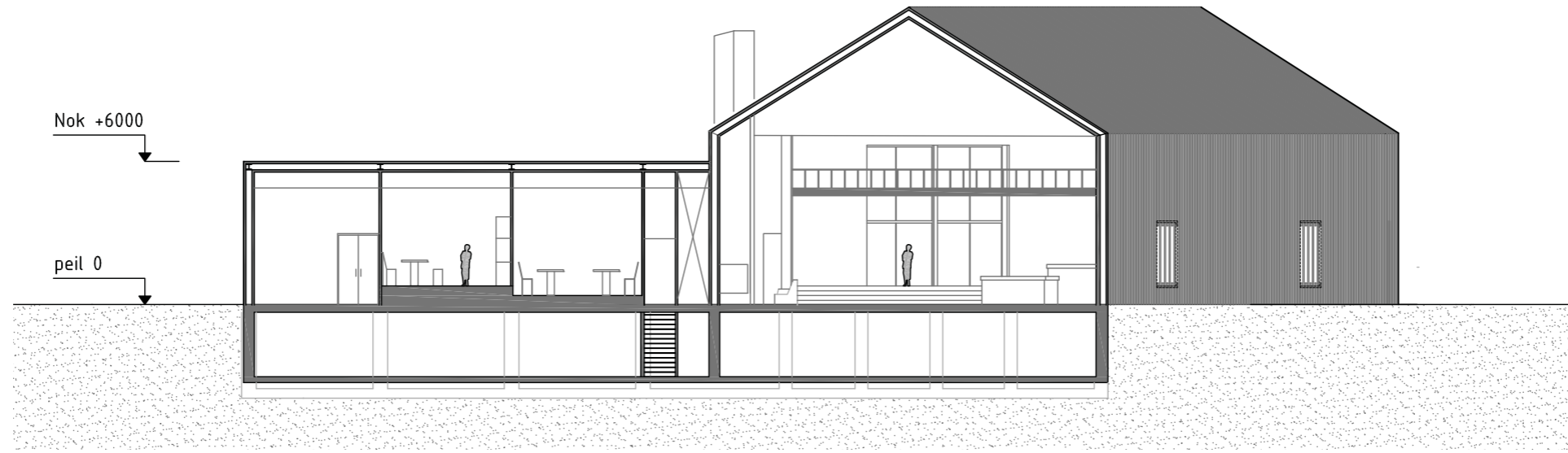

Section A

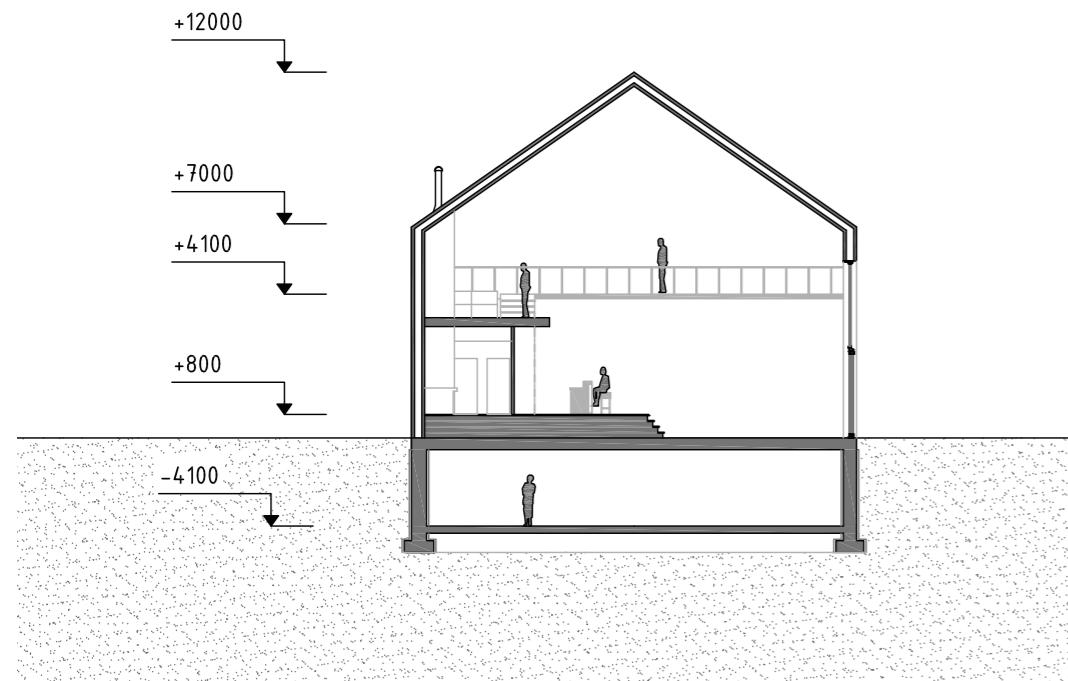

Section C

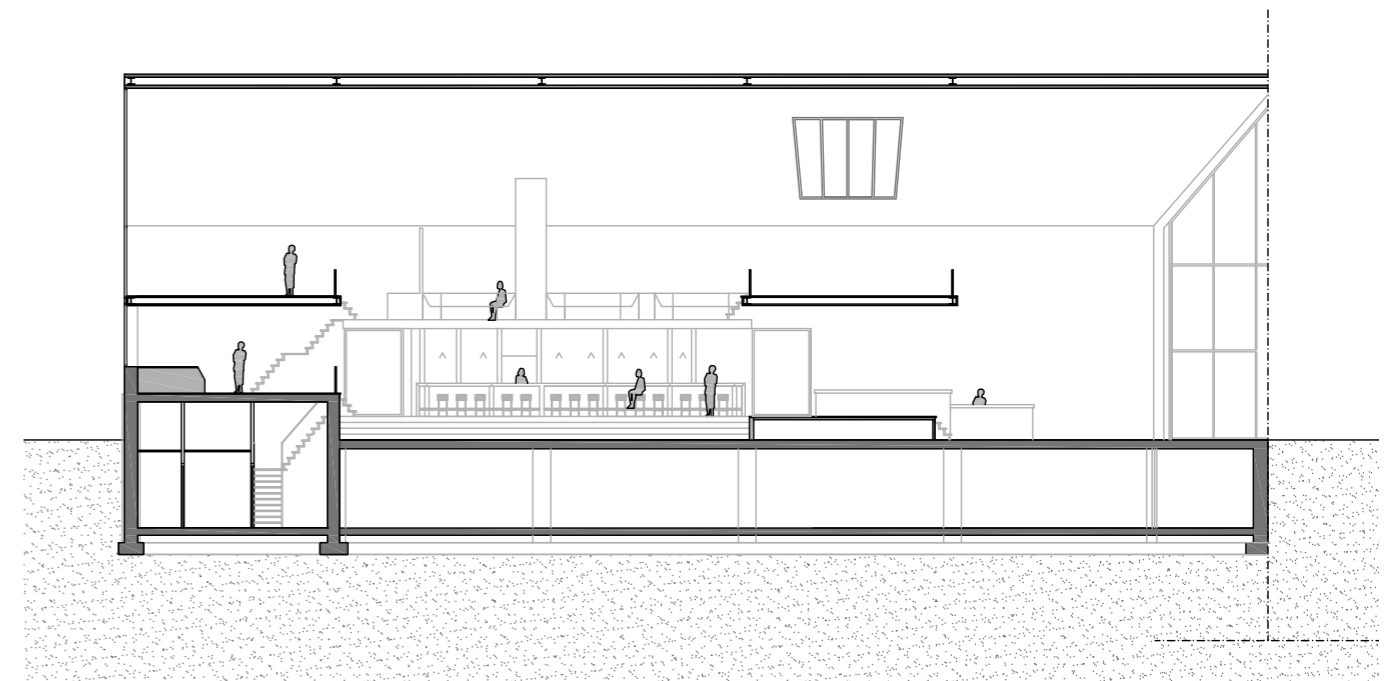

Section B

Exterior impression







Interior impression



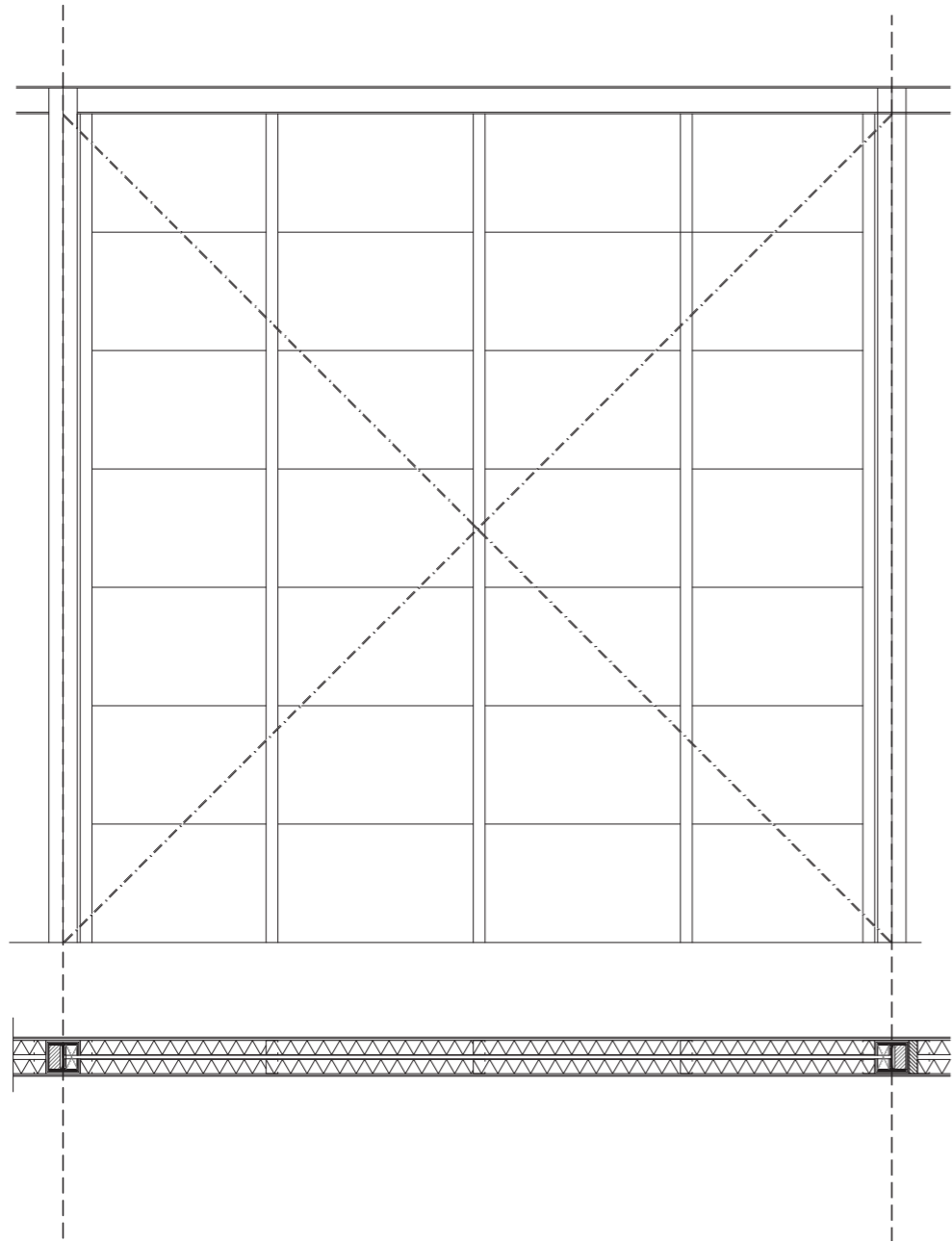

frame facade fragment

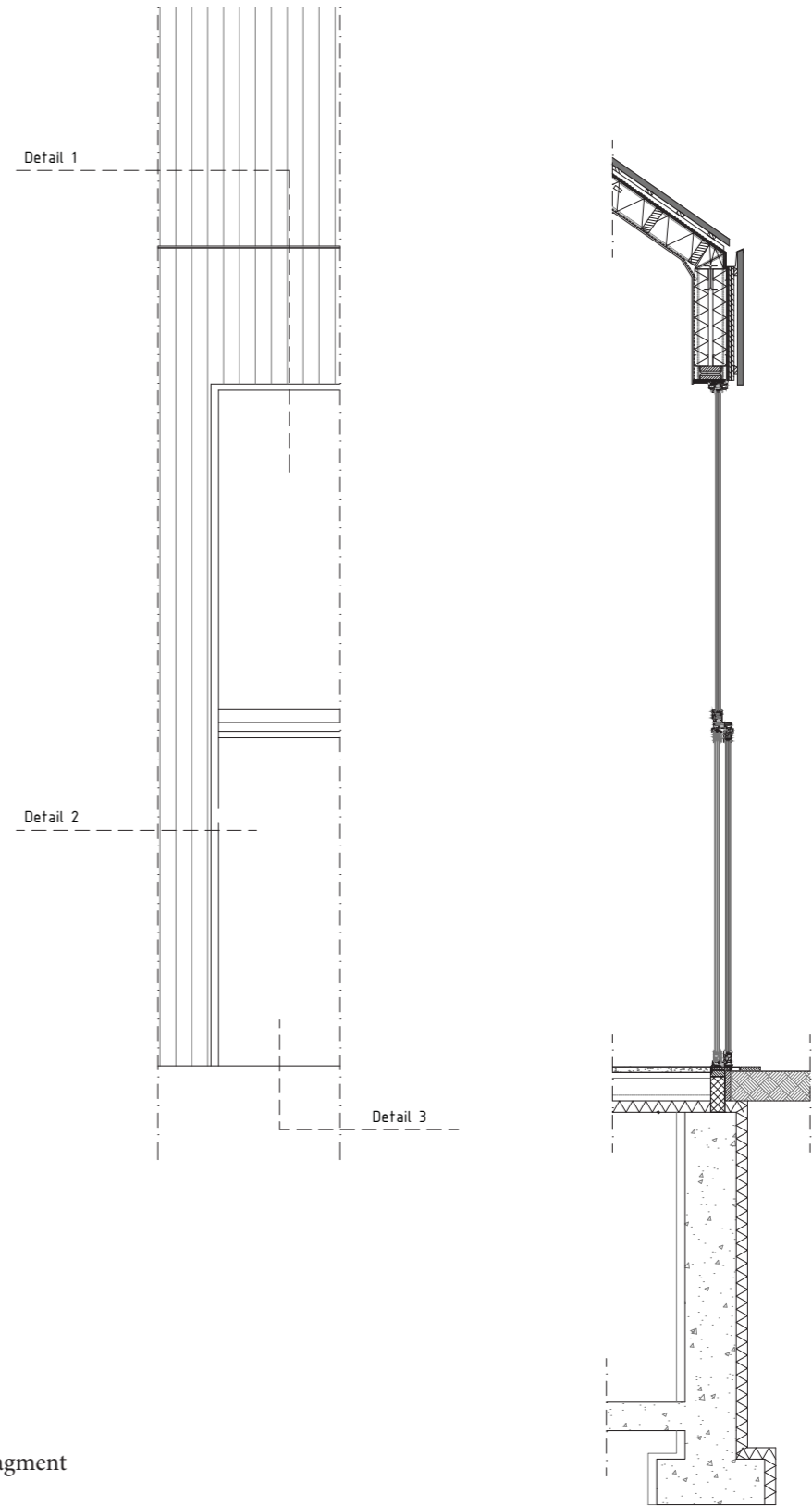

facade fragment

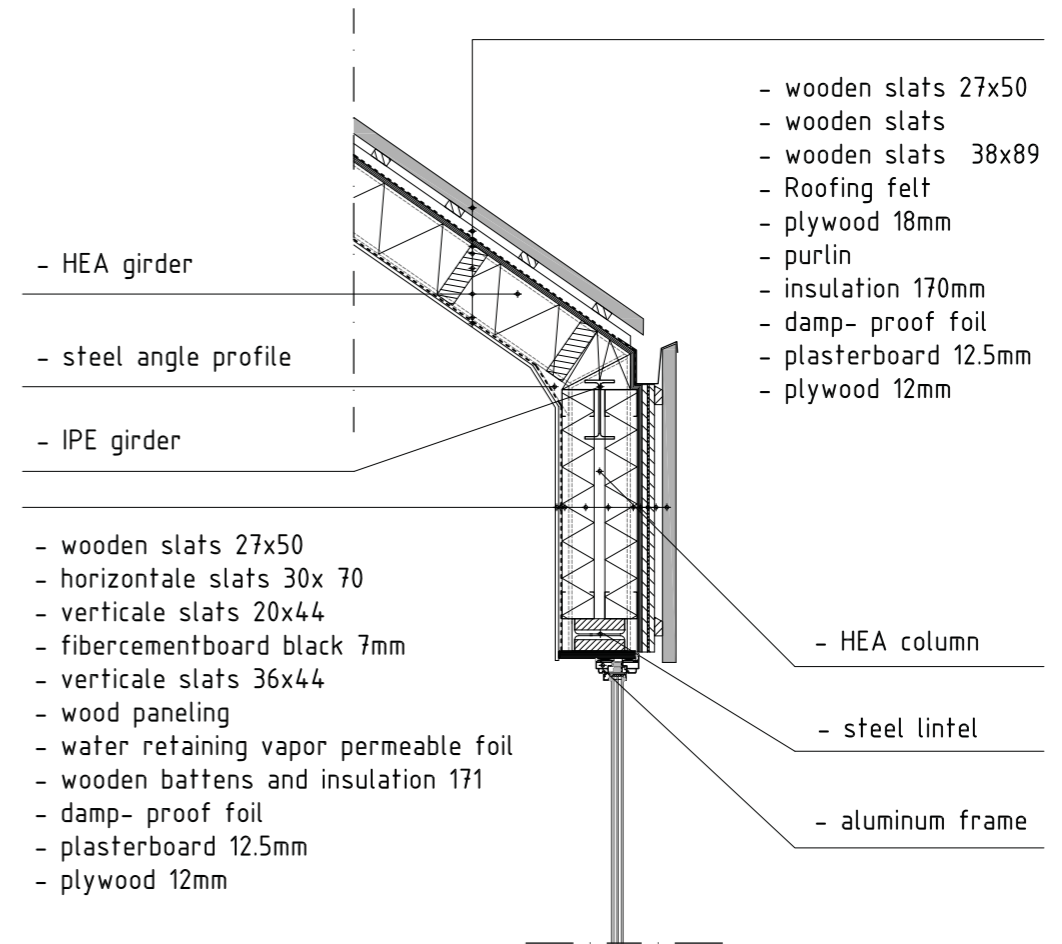
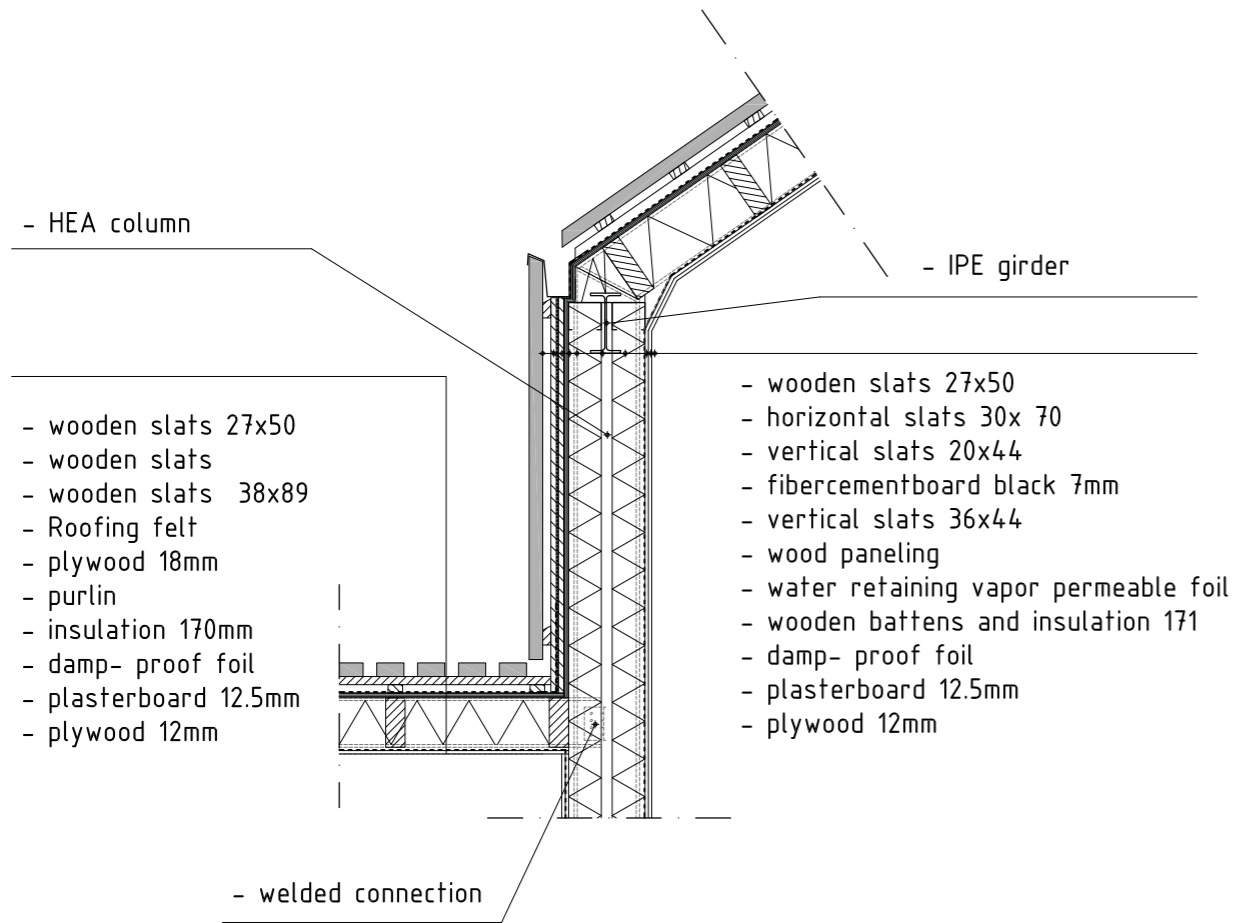

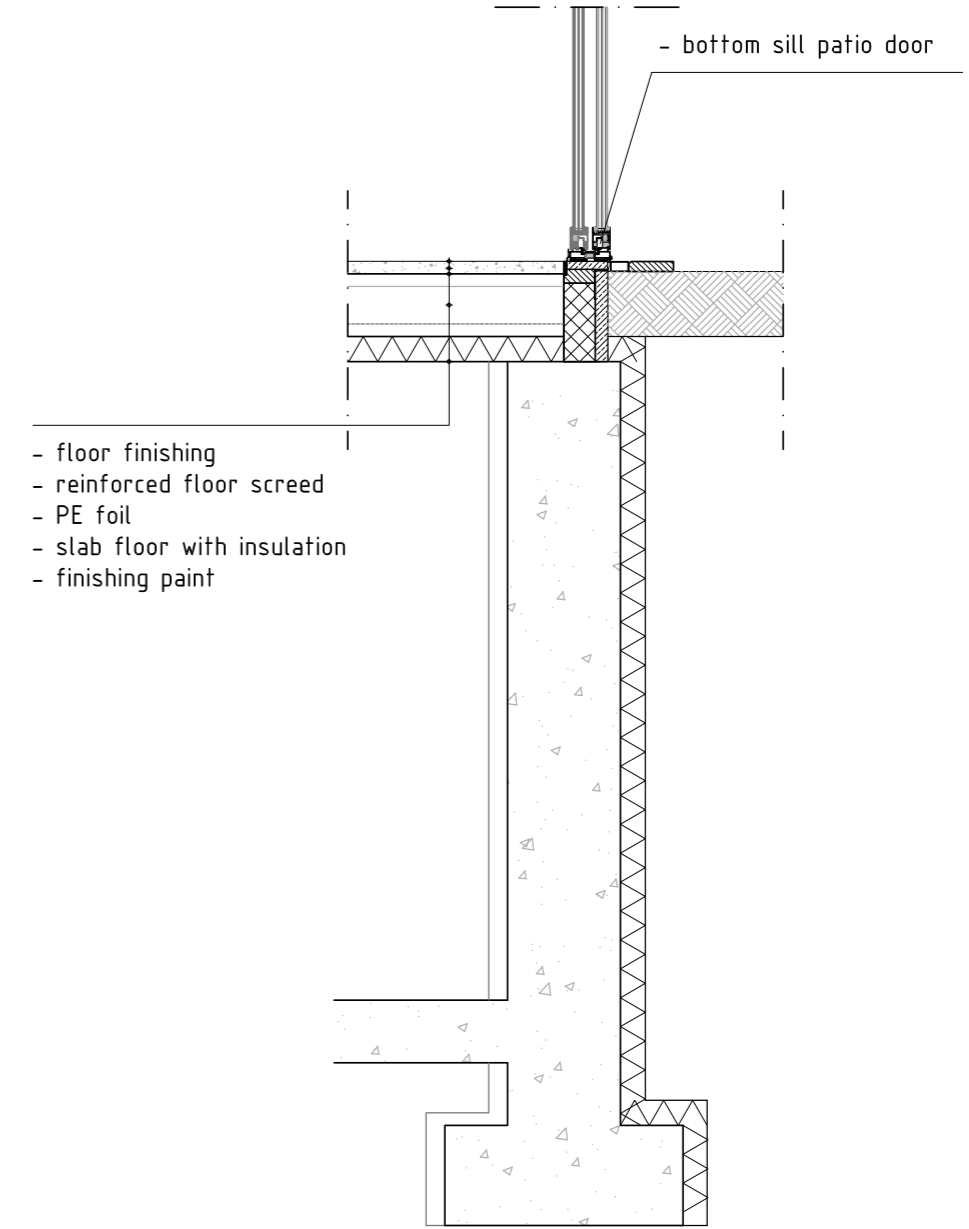
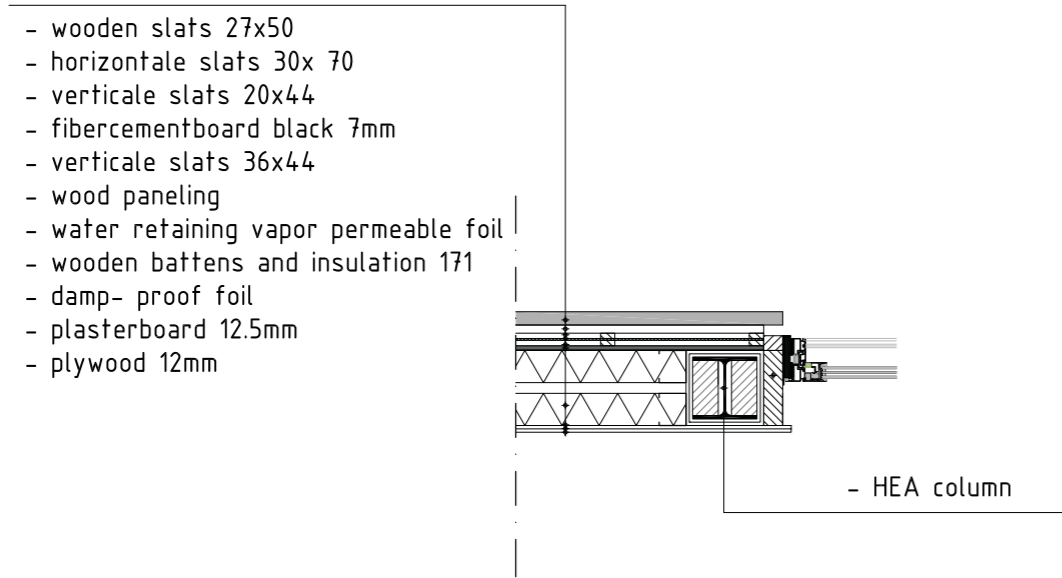
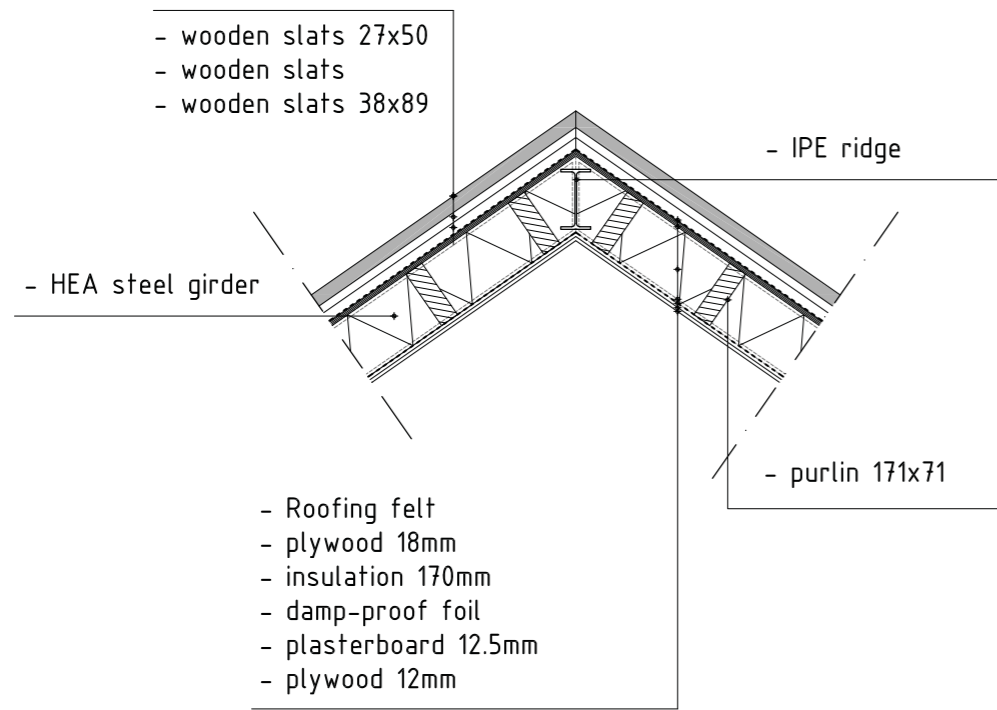

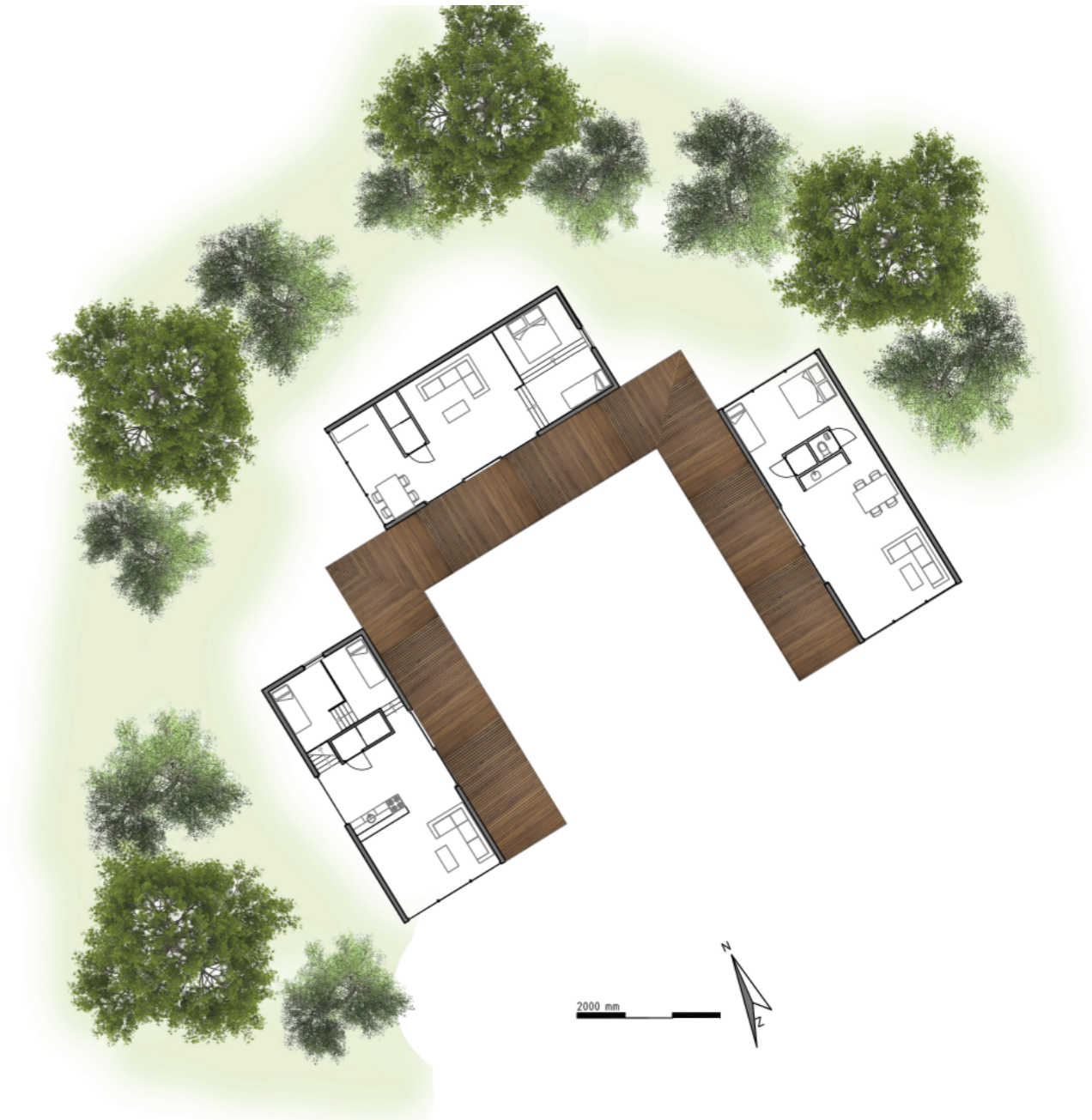

Group situation bungalows

Bungalow type 1



right view

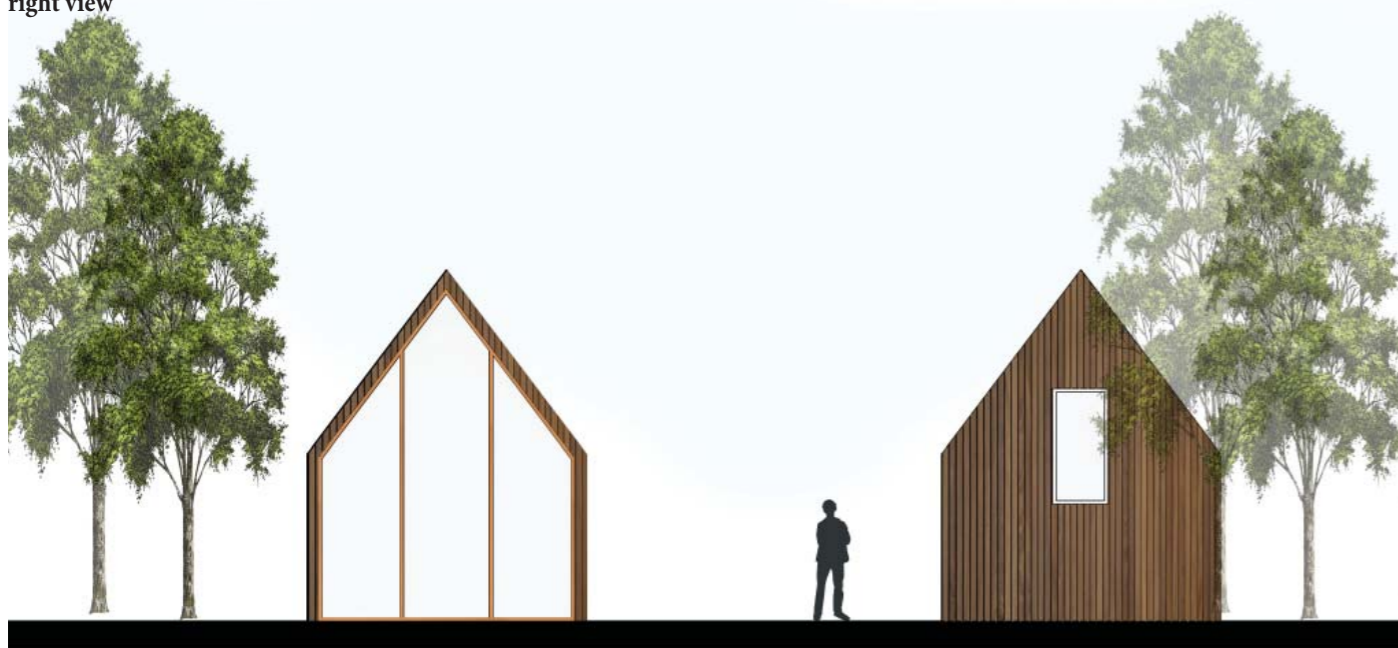

front view

rear view



left view

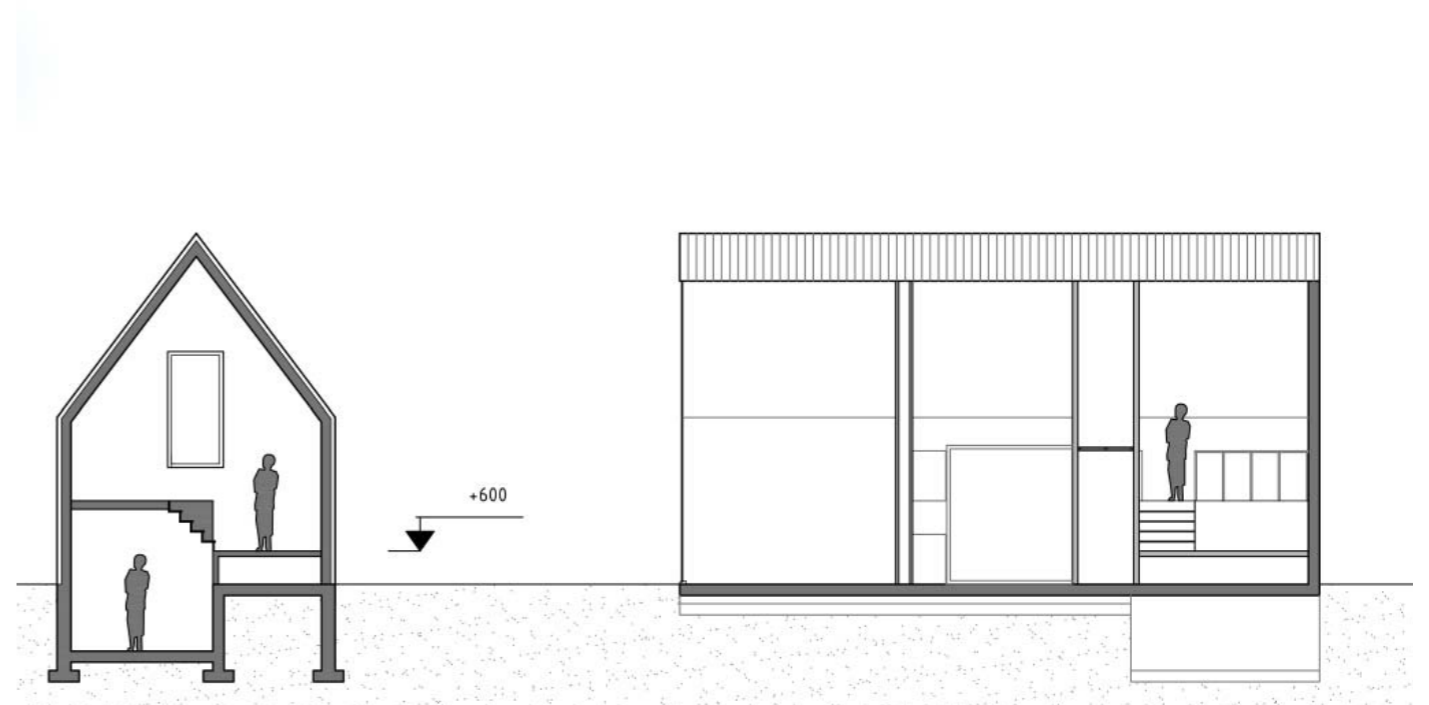

sections

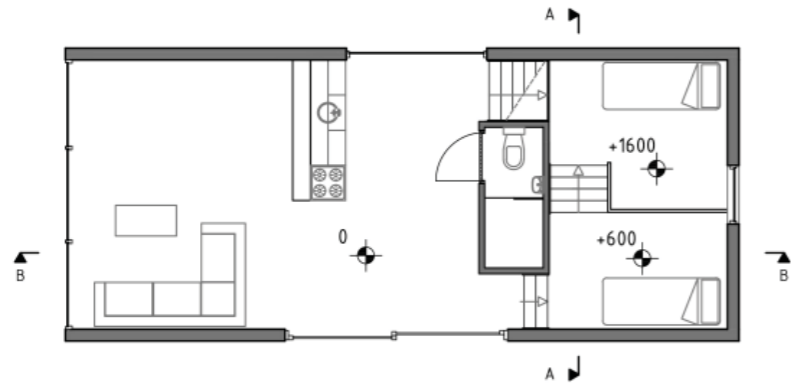

1000 mm

ground floor

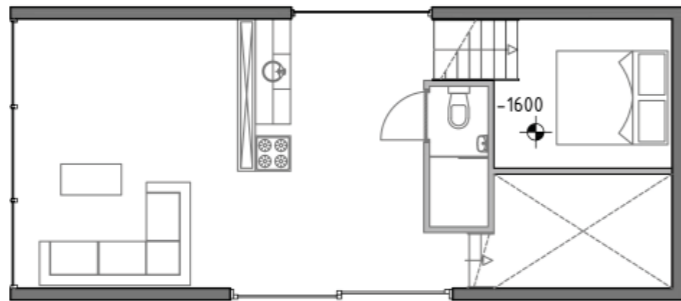

floor -1



interior impression

Bungalow type 2

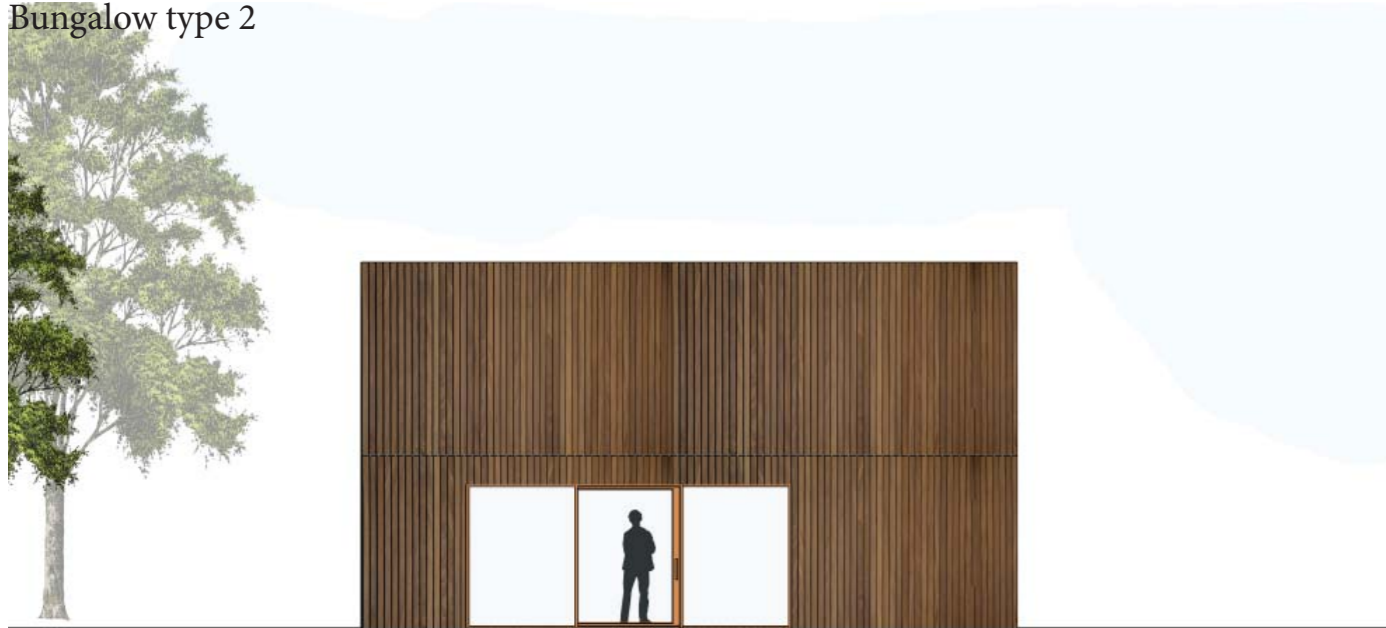

right view

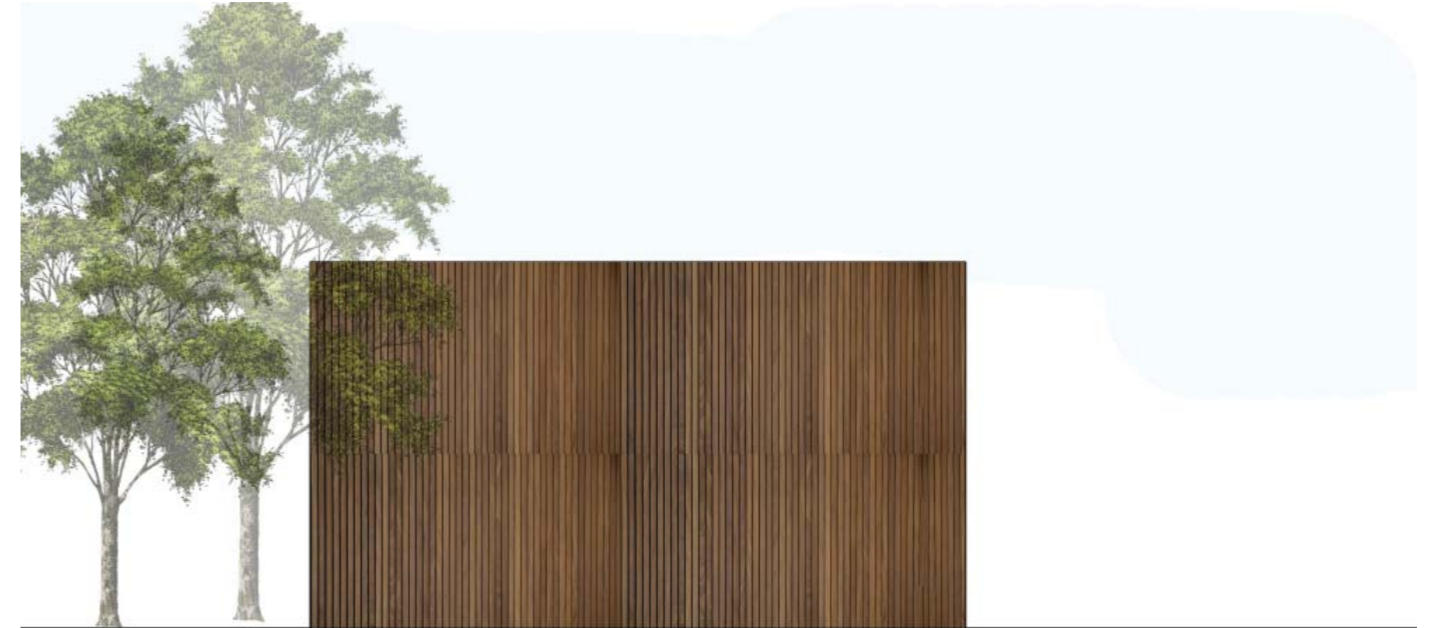

left view



front view

rear view

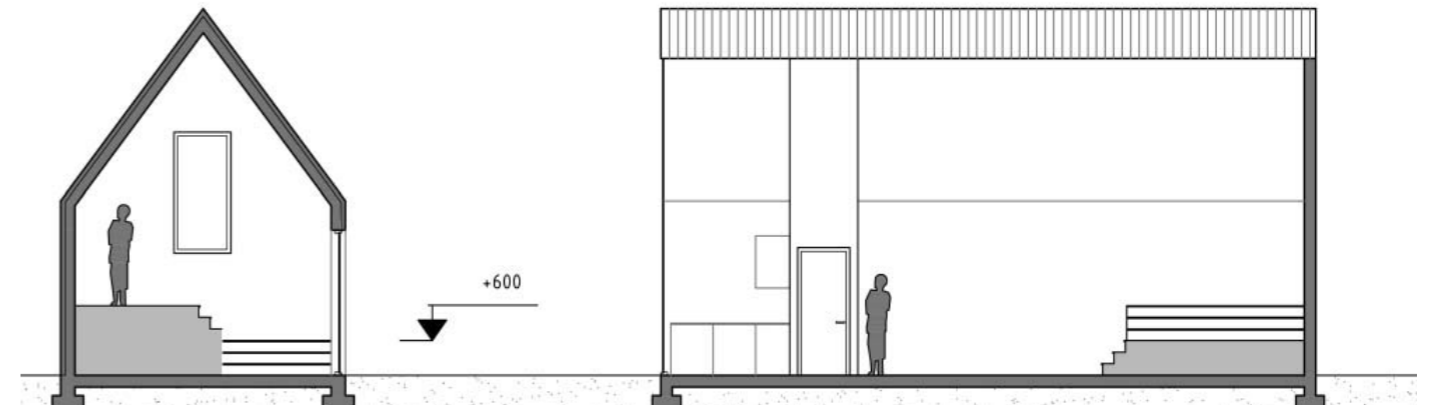

sections



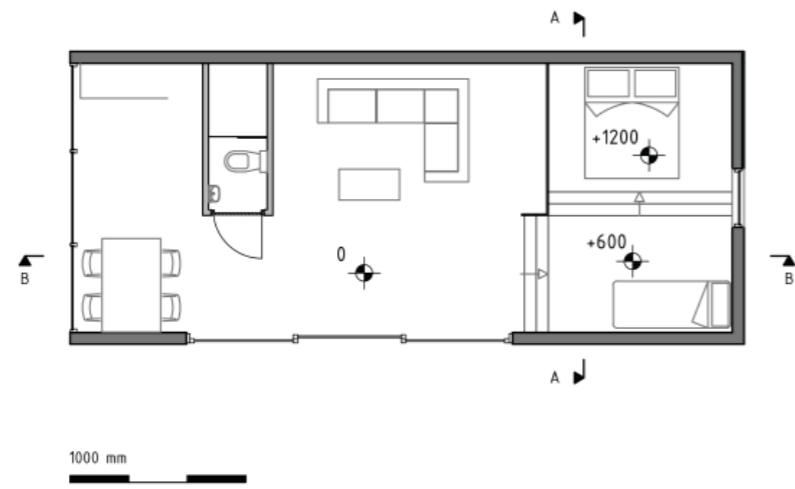

floor plan



interior impression

Bungalow type 3



right view



left view

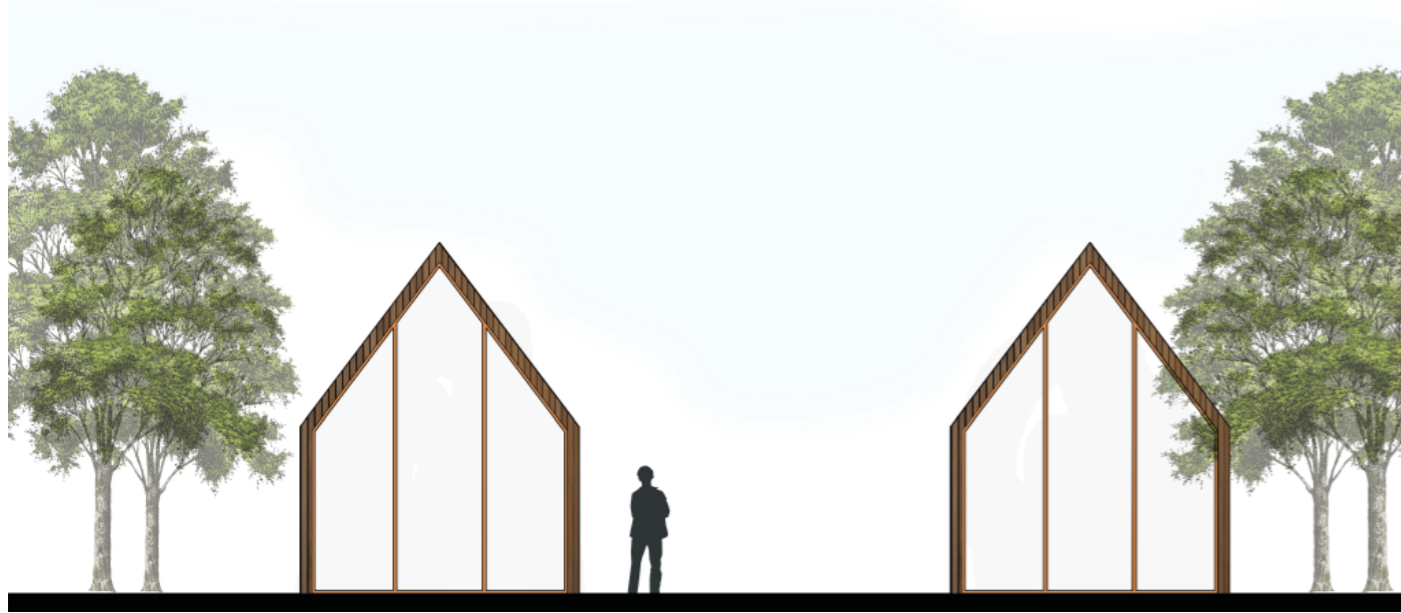

front view

rear view

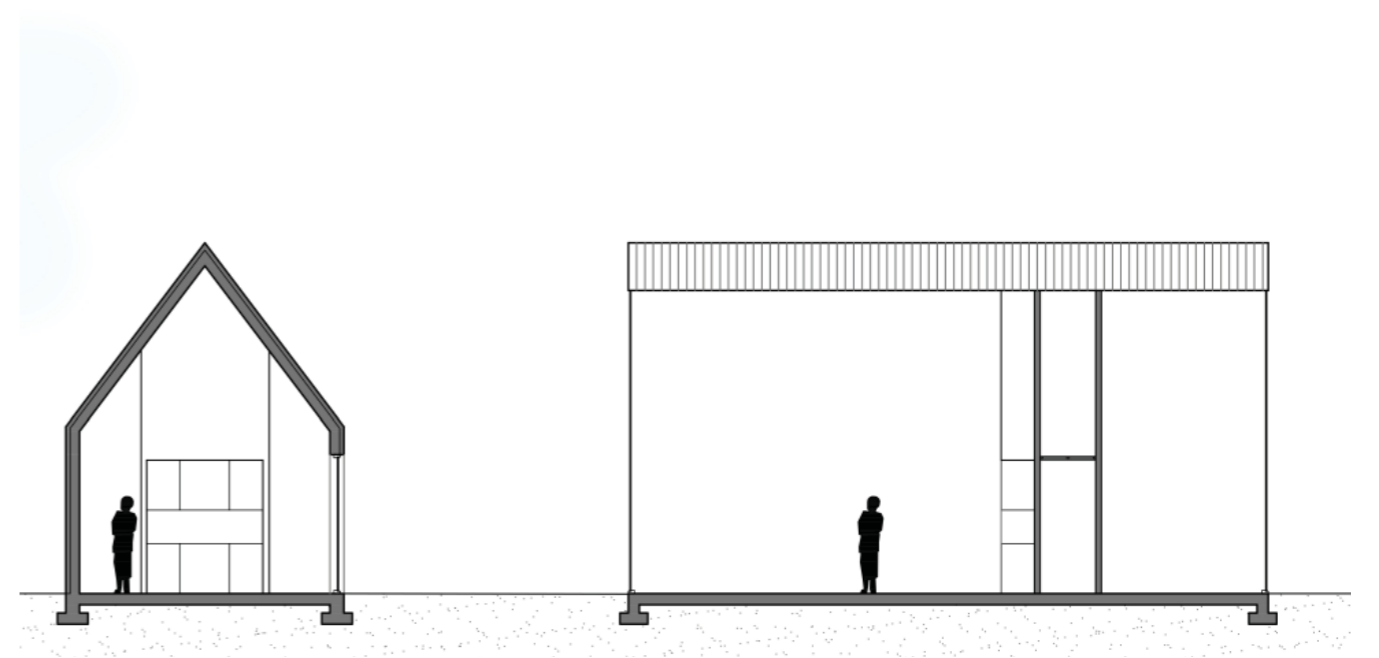

sections

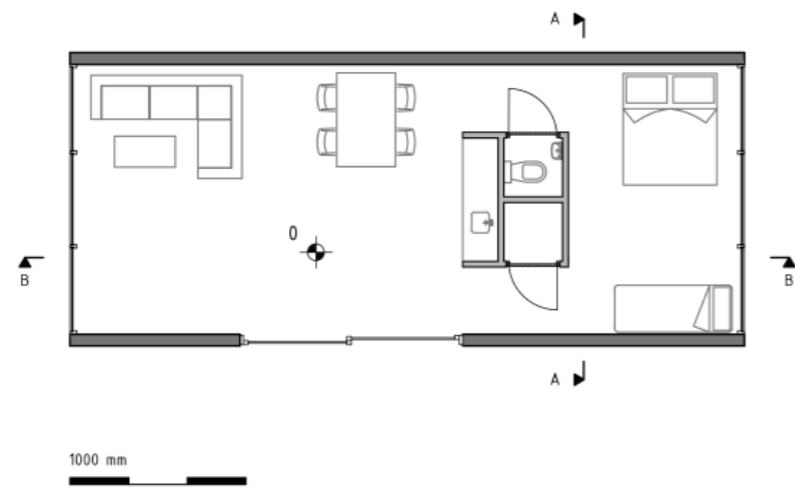

floor plan



interior impression



# Facade fragment

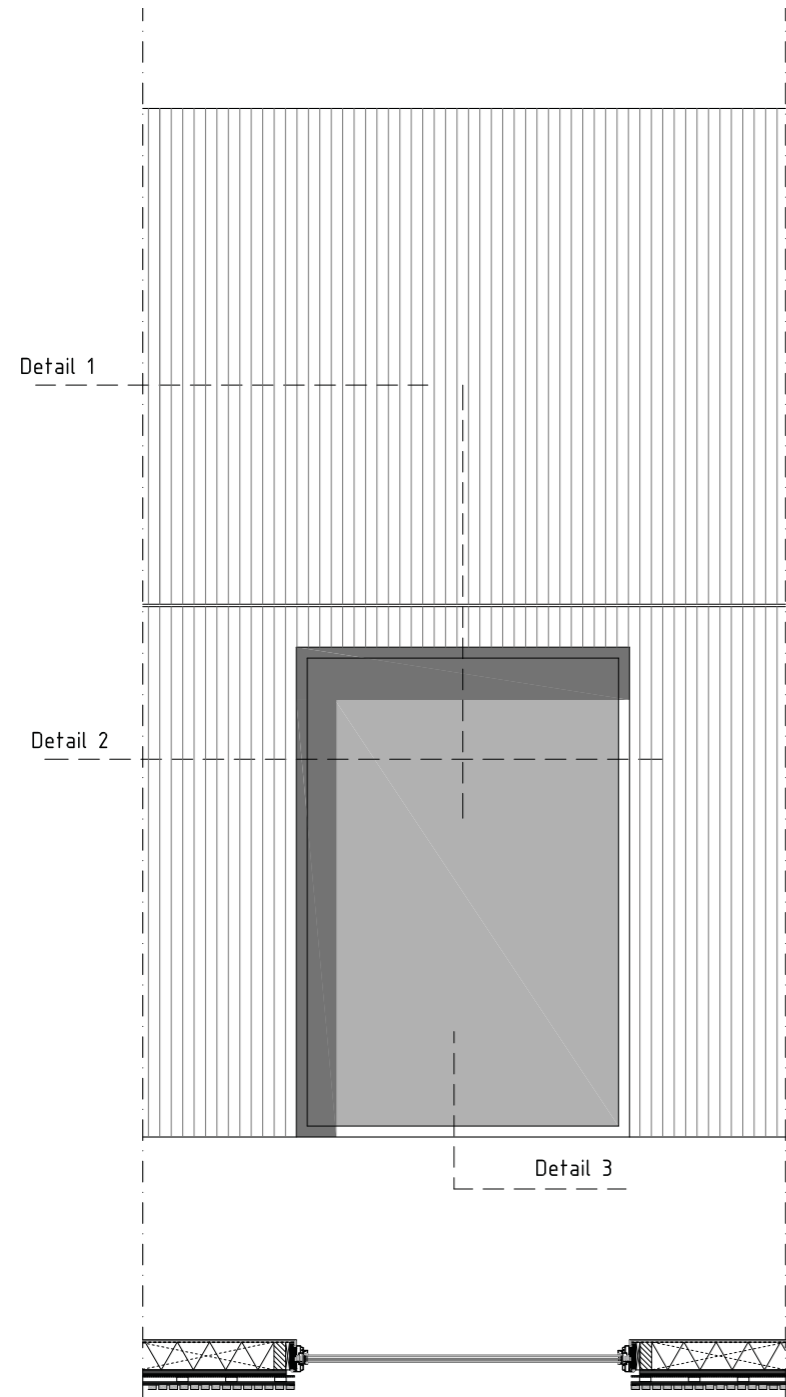

facade fragment

# Details

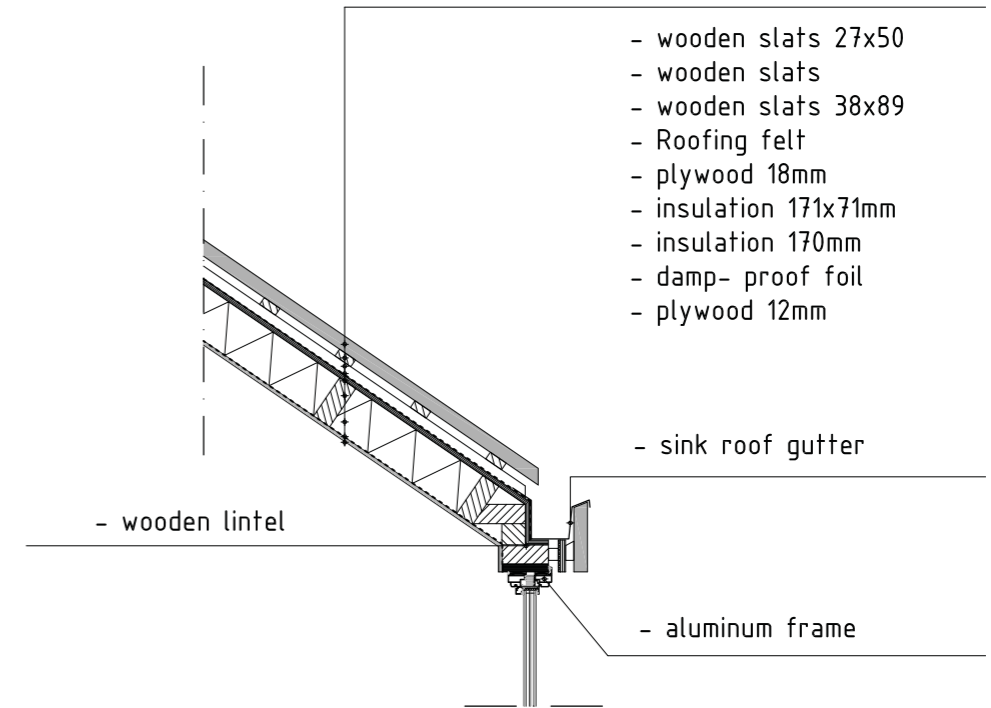
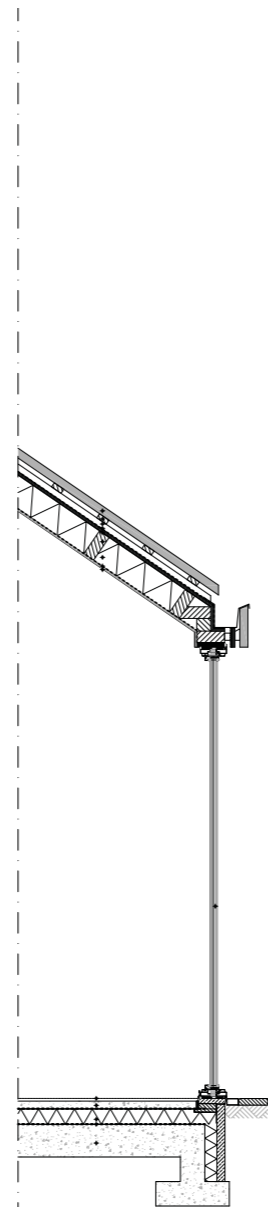

- wooden slats 27x50
- horizontal slats 30x 70
- vertical slats 20x44
- fibercementboard black 7mm
- horizontal slats 36x44
- water retaining vapor permeable foil
- wooden battens and insulation 171
- plywood 12mm

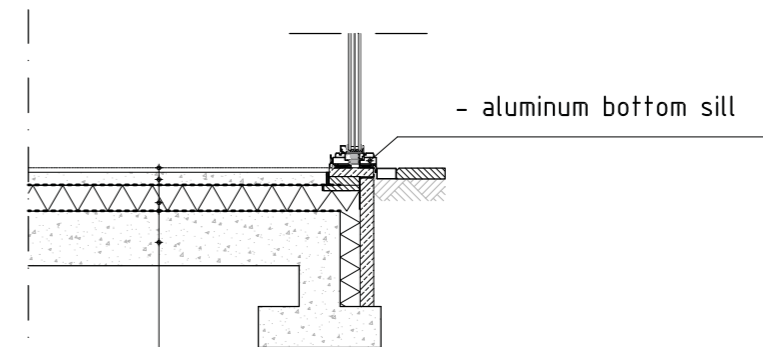
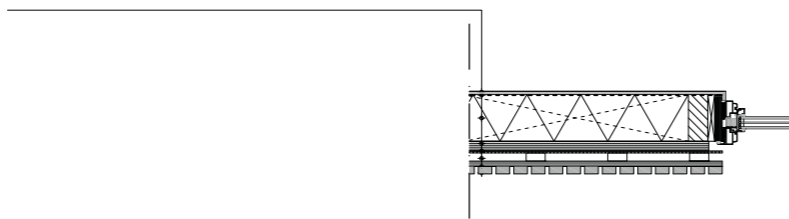

- floor finishing
- reinforced floor screed
- PE foil
- flame proof insulation
- PE foil
- leveling layer
- concrete floor

## CONCLUSION

## Conclusion

The study is a continuation of the final workshop “IBA Parkstad 2020 Bicycle Highway Plus,” and focuses on the tourism activities within Parkstad. It is a study of the possibilities offered by the region to young families with children. In the first stage of the research, the activities, attractions and accommodation provided by the region were examined. There followed a strategy to choose a target group from the attractions and activities and thereby a suitable type of accommodation.

Due to the shrinkage, increase in vacancies and decline in population, an economic decline has occurred. This study found that there is a growing tourism sector in the region. Parkstad Limburg has released a vision to increase the number of tourists. Hereby, the report “Tourism Vision 2020” was published. From the standpoint “How can we attract people to Parkstad?” the attractions and sights of Parkstad were mapped in order to identify which group of people can be attracted to Parkstad. It was concluded that the main attractions of Parkstad appeal to families with children.

Parkstad is a region frequented by day visitors. People visit the region for a day rather than staying for several days; therefore, the money spent by the visitors is limited. Due to this limited cash inflow, there is currently no economic profit made. To encourage people to stay for the entirety of their annual holidays, research concerning accommodation type and location was performed. It was concluded that urban areas have hotels as their main accommodation type, while Limburg is known for bungalow holidays.

The main question was therefore: “How can we use the qualities of Parkstad to offer an alternative landscape accommodation?” This was answered by examining the qualities of Parkstad. The main quality of Parkstad is that it is an entertainment city with many attractions and activities. It was decided to choose a strategy in which the Limburg landscape character will be highlighted together with the urban structure, creating an alternative way to stay within the urban areas. By choosing a bungalow for which Limburg is known, combining it with qualities of Parkstad, a holiday is created in which the landscape, attractions and activities are coupled.

A bungalow is not a holiday park. In a holiday park, facilities such as swimming pools, grocery stores and catering establishments can be found. Unlike holiday parks, bungalows offer fewer facilities and are used as overnight accommodation. This allows tourists to leave the park, participate in society and make use of attractions. This will add value to the Parkstad economy.

The bungalow consists of different types of houses that are placed in groups to create a community. The main building serves as a common recreation area. The facilities are limited inside the park, to encourage the residents to participate in activities outside of the park.



LITERATURE AND IMAGES

## Books

Jacques, D. H. (2011): *Barns and Other Out-Buildings, With Information on the Architecture of Farm Buildings*  
publisher: Cousens Press

Michael Vlach, J. (2011): *Barns, Volume 1*  
publisher: W. W. Norton & Company

Soerensen, C. Th. (2001): *landscape modernist*  
publisher: Danish Architectural Press

McLaren, B. Lasansky, D. M. (2004): *Architecture and Tourism, Perception, Performance and Place*  
publisher: Bloomsbury Academic

Bærenholdt, J.O. (2004): *Performing Tourist Places, New directions in tourism analysis*  
publisher: Ashgate

## Publications

Parkstad Limburg (2010): *Uitvoeringsprogramma Toerisme 2010- 2014*  
publisher: Parkstad Limburg

Parkstad Limburg (2010): *Transformatieplan 2010-2020*  
publisher: Parkstad Limburg

Bureau ruimte & vrije tijd (2014): *Toeristische trendrapportage Limburg 2013-2014*  
publisher: Parkstad Limburg

ZKA Consultants & Planners (2008): *Strategische Visie op het toerisme in Parkstad*  
publisher: Parkstad Limburg

VVV Zuid Limburg (2009): *Beleef Parkstad Limburg*  
publisher: Parkstad Limburg

Seijben, R. (2013): *Leisure ontwikkeling Parkstad Limburg*  
publisher: Parkstad Limburg

Dix, M. Berg en Terblijt. (2009): *We zijn wat we delen: wij zijn Parkstad! Regiodialoog Parkstad Limburg*  
publisher: Parkstad Limburg

Croé, A. Peters, P. Luijten, A. Vrolijk, D. (2005): *Stedebouw & Ruimtelijke Ordening, Ontwerpen aan Parkstad Limburg*  
publisher: Nirov – Den Haag

Dijkstal, H.F. Mans J.H. (2009): *Krimp als structureel probleem.*  
publisher: Topteam Krimp

Daalman, M. Kloosterman, K. van Teerns, M (2014): *Woongedrag en woonwensen jongeren.*  
publisher: Onderzoek en Statistiek Groningen

Borger, P. Holger Dux, A. Nolten, W. Braad, R.(2011): *Het land van Herle*  
publisher: unknown

Huisman, C. de Jong, A. van Duin, C. Stoeldraijer, L.(2013): *Regionale prognose 2013–2040. Vier grote gemeenten blijven sterke bevolkingstrekkers*  
publisher: CBS

## Internet

<http://www.iba-parkstad.nl/>

<http://www.limburg.nl/dsresource?type=pdf&objectid=limburg:40057&versionid=&subobjectname=>

<http://www.ditisparkstadlimburg.eu/>

<http://www.rvo.nl/onderwerpen/duurzaam-ondernemen/gebouwen/stad-en-regio/bevolkingsdaling>

<http://zwartgoud.net/2012/04/2012-2022-heerlen-in-de-overgang/>

[https://nl.wikipedia.org/wiki/Park\\_Gravenrode](https://nl.wikipedia.org/wiki/Park_Gravenrode)

[http://www.vvvzuidlimburg.nl/ontdekken/regio\\_gravenrode.aspx](http://www.vvvzuidlimburg.nl/ontdekken/regio_gravenrode.aspx)

<https://www.rijksoverheid.nl/documenten/rapporten/2009/09/01/krimp-als-structureel-probleem-rapportage-topteam-krimp-voor-parkstad-limburg>

<http://kennisbank.platform31.nl/pages/23757/Projecten/Krimp-als-kans-in-Parkstad-Limburg.html>

[https://nl.wikipedia.org/wiki/Parkstad\\_Limburg](https://nl.wikipedia.org/wiki/Parkstad_Limburg)

[http://issuu.com/petramaas/docs/111019\\_bvr\\_werkboek\\_iba](http://issuu.com/petramaas/docs/111019_bvr_werkboek_iba)

## Images

Pic 1: graduation studio Parkstad 2020 TU/e

Pic 2: <http://www.cbs.nl/NR/rdon-lyres/54C923ED-5A6B-4B0C-8380-DC8F0A37FB-C9/0/2013Regionaleprognose20132040art.pdf>

Pic 3&4: <http://zwartgoud.net/2012/04/2012-2022-heerlen-in-de-overgang/>

img page 13: <http://www.iba-parkstad.nl/>

Pic 5: graduation studio Parkstad 2020 TU/e

Pic 6, 7 & 8: Booklet “Bicycle Highway Plus”  
graduation studio Parkstad 2020 TU/e

Pic 9: *Uitvoeringsprogramma Toerisme 2010- 2014 pdf*

Pic 10: <http://www.nufoto.nl/fotos/214527/terrein-pinkpop-vanuit-luchtballon-.html>

Pic 11: <http://www.wereldtuinenmondoverde.nl/nl/achtbaan/>

Pic 12: <http://www.tacky.nl/snowboard/article/?id=115179>

Pic 13: [http://www.telegraaf.nl/filmuitgaan/21585006/\\_\\_\\_Continium\\_weer\\_leukste\\_kindermuseum\\_\\_.html](http://www.telegraaf.nl/filmuitgaan/21585006/___Continium_weer_leukste_kindermuseum__.html)

Pic 14: <http://www.gaiazoo.nl/dagje-uit-limburg/>

Pic 15: <http://www.panoramio.com/photo/62087273>

Pic 16: <http://www.google.nl/maps>

Page 16: [www.IBA.nl](http://www.IBA.nl)

