

MASTER

Arkhe archives architecture a physical place for digital opinions

van Vlerken, J.M.

Award date:
2016

[Link to publication](#)

Disclaimer

This document contains a student thesis (bachelor's or master's), as authored by a student at Eindhoven University of Technology. Student theses are made available in the TU/e repository upon obtaining the required degree. The grade received is not published on the document as presented in the repository. The required complexity or quality of research of student theses may vary by program, and the required minimum study period may vary in duration.

General rights

Copyright and moral rights for the publications made accessible in the public portal are retained by the authors and/or other copyright owners and it is a condition of accessing publications that users recognise and abide by the legal requirements associated with these rights.

- Users may download and print one copy of any publication from the public portal for the purpose of private study or research.
- You may not further distribute the material or use it for any profit-making activity or commercial gain

Arkhe Archives Architecture

A physical place for digital opinions

Student: J.M. (Jan) van Vlerken
student ID: 0650885

Graduation project of graduation studio:
A Contemporary Cultural Forum

Supervising committee:
prof. ir. J.D. (Juliette) Bekkering
ir. M.P. (Mark) Hemel MArch RA
J.J.P.M. (Sjef) van Hoof

19 January 2016

Index

Abstract	4	Architectural design	79
Introduction	7	Concept	81
<i>Research</i>	9	Program	83
Rough thoughts	11	Urban embedding	85
Theme	13	Typology	91
Method design/ design method	15	Public space	97
Essay; <i>Arche, Archives, Architecture</i>	19	Lecture hall	100
Paris of Haussmann	29	Bataclan Archive	106
Archival Architecture	33	Digital Political Archive	114
Museum of Modern Literature, Germany	35	Facade materials	123
New National Archives of France	37	Bibliography	126
The Treasury Research Centre & Archive, New Zealand	41		
EDF Archives, France	43		
Archeological Archives, China	45		
Internet Archive	47		
Personal Archive Experiences	49		
National Library of the Netherlands	49		
Bibliothèque Historique de la ville de Paris	51		
Comission de Vieux Paris	52		
Archives de Paris	52		
Location Choice and Analysis	59		
Conclusion	72		

This project is a search for the possibility to implement a politically meaningful archive in a public contemporary context. Seeing the rise and prevalence of the digital realm, it is hard to imagine any political debate nowadays without the context of online opinion makers and sentiments. As Bernard Stiegler has theorised, the digital sphere gives nearly anyone the opportunity to add their opinions and values to a vast network of knowledge. This human brainpower is can be exploited and used on an industrial scale like it once became possible to industrialise human working power during the industrial revolution. An example of this is the way in which Facebook uses this thought exteriorisation to improve web interfaces by analysing behavioural responses to interface changes. Through its 500 million users, an unseen scale of thought and behaviour engineering becomes possible. This system harbours endless possibilities of social and political research which is currently only in a conceptual stage or done by private institutions for internal or commercial purposes like in the Facebook example.

The next step in mnemotechnological industrialisation should be a public one. Adequate analysis of twitter feeds,

weblogs, likes, shares and comments should be done to understand polarisation, public opinion and sentiments. How many people changed their profile picture into a French flag as a reaction to the November 13 Paris massacre? What values could be added to the average comments on those profile pictures, are they of compassion or of nationalism? Does an event like this polarise or unite? What is the geographic spread of these opinions? Questions like this can be researched by analysing online data to provide better insight in public sentiment. This kind of public opinion is an actor in the public debate which established media only marginally seem to understand, this because it has only just become possible to access this data.

To provide insight in public political data, it should be stored in an archive which at the same time is a public space and a research centre. The storage will take place in a prioritised position of the city, in this way the new archive becomes a beacon of reference in the city. This project is a search for a way to implement the digital open archive in a way to create a physical space where results can be presented, press conferences can be held, lectures can

be attended and TV reports can be shot.

These statements have resulted in the design of an archive in Paris that can make both a monumental statement and show a large openness to the public. This is done by incorporating motives and shapes from the history of the locus and by incorporating the aftermath of the 13 November attacks that happened on the site. These attacks created new collective memory that is firmly linked to this place but that will change over time inevitably. This change is used in the narrative of the research showing that memory and perception of places are not fixed and change constantly. The other important marker of the design is separating the functions over three similar buildings, this is done to create a design that provokes a conversation with the context that resonates in the properties of the archive, the archive as a forum should not depend on one truth or authority but shows its many faces as well as in the architecture as the program. Since digital archiving is only in the beginning stages, this project also provides a platform for discussion and development of its own constitution.



Introduction

This report is the result of the graduation project called Arche, Archives, Architecture. This project is part of the graduation studio A Contemporary Cultural Forum Led by Sjef van Hoof and Mark Hemel as part of the master track Architectural Design and Engineering at the Eindhoven University of Technology.

The research for this project is guided by focussing on the question how an archive can be used in a context of politics and power to create a public forum in a Western European metropolis, in this case Paris. The interest in archiving is a personal and intrinsic starting point that has been used to guide the process. The interest is explained in the chapter Rough Thoughts, the research question that follows is explained in the chapter Theme.

Researching the theme of archiving in a contemporary context has exposed the problem of a discrepancy between offline and online politics. The goal of this project is to design an archive in the context of a forum that allows new connections between offline politics and online opinions. Therefore, the architecture has to be a search between institutionalising and accessible buildings.

After introducing the spark of

the idea to the archive as a forum and the theme and methods of the research, an essay eponymous to the project follows. The essay is the result of a literature research, other parts of the research capture the state of the art of archiving and archive architecture and research to the context of the chosen site for the eventual design. The choice of the location is elaborated in this part too. The research ends with a conclusion that is the basis for the definition of the design concepts and the program. These concepts are part of the explanation of the architectural design.

Research

Rough thoughts

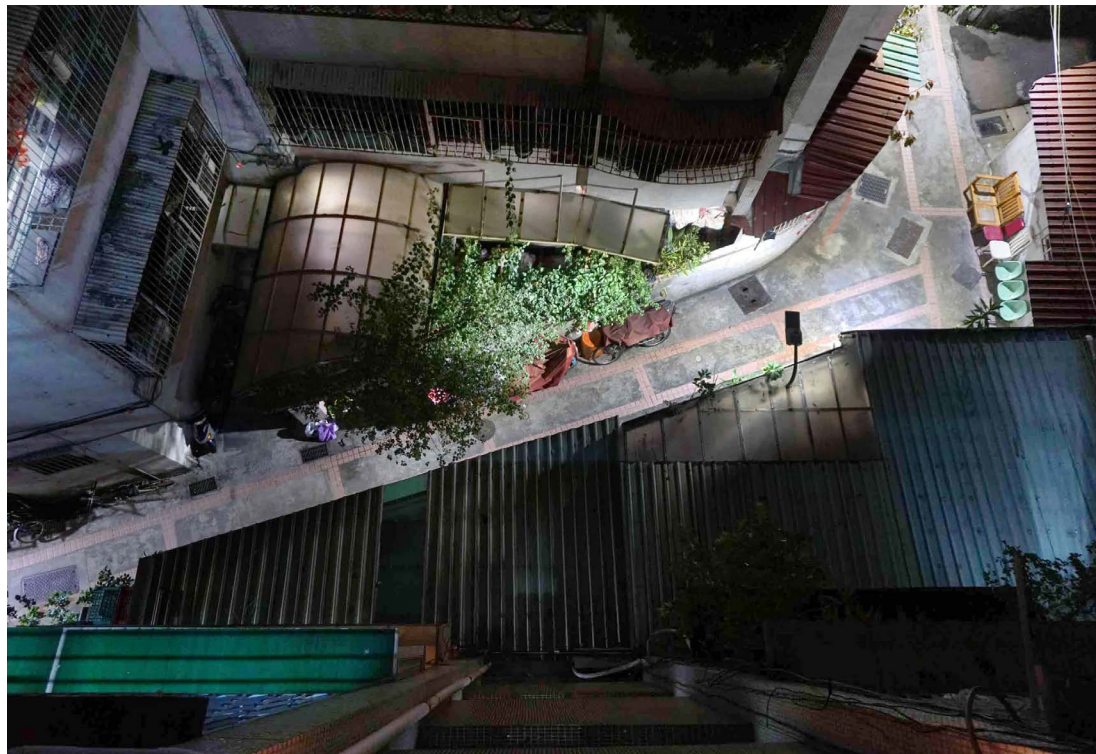

▼ View from my apartment in Taipei

It starts at January 6th of 2015 in Taipei, Taiwan. I'm nearly at the end of my exchange semester at the architecture faculty of Taiwan Tech. It's one week before the final presentation and a fellow student gets some last minute advice from the tutor. He swiftly mentions, amongst others, the possibility of incorporating a small archive into her design. Her English is not perfect which made her ask what an archive actually is. The answer is equally swift and straightforward while I suddenly realise it is never going to be easy to fully understand the implications of an archive.

During that semester, I was fully occupied with trying to get to know the city Taipei as best as I could because I wanted my student exchange to be as local as possible. I had spent hours and hours wandering and cycling through the city, I had talked to many locals, both ordinary citizens as professionals from the architectural field, while living in a very typical Taipei neighbourhood participating in the public life there as much as I could. This is why I am convinced that I have learned and understood how this city works quite well. When my tutor mentioned the archive, I started to think that it would never be possible to acquire this kind of knowledge from a museum or

from an archive. So would it be possible to manipulate an archive to make this soft and subjective knowledge tangible? Would it be possible to create such an 'un-archived archive' which refers to the entire city not in the things it stores there but in the experience it offers? Since the city is already an archive of itself, (I found out later that Koolhaas mentions in this S,M,L,XL introducing his design for a très grande bibliothèque in Paris) this would be a rather useless building if the archive were only to be focussed on the present. However, in my opinion, the archive is not so much focussed one time frame. The important motive of the archive is to save artefacts in the present to connect the past in the future. It gives the best possible solution known to interpret the past without the filter of selective writing of history.

The public and all-encompassing nature of the archive led me to take this idea into the graduation project a Contemporary Cultural Forum. My definition of a forum includes a few of the basic concepts that are also at the basis of an archive. A forum could be public, in which sense it is accessible and meaningful for everyone. In extension to that, a forum is a place in which these people engage in cultur-

al, political and or economic exchange. The concept of exchange implies the gathering of artefacts and ideas on a forum. In this way, the forum isn't only a marketplace for money, goods and ideas, through the gathering of knowledge it becomes a place with a meaning for the content and dialectics the content produces. In my opinion, the forum is therefore a place that represents a certain common ground, it plays a role in establishing culture and society.

This definition of a forum has a lot in common with an archive. If the reason for the archive is the preserving of undistorted information from the past to be used in the future, it too is a place that builds common ground for a society. The other similarity is the seeming objectiveness of the archive, like an ideal forum, the ideal archive is open, meaningful and accessible to all citizens.

I use the word ideal because it is probably always possible to create counter examples of a selective archive or an elitist forum. For the architecture, there possibly lies an opportunity here. The contradictions like closed versus open, past versus future and selective versus all-encompassing can become design tools which can explain the contradictions and conflicts that are,

according to me, always present in architecture. For this reason, the aspect of the contradiction makes it worthwhile to explore the archive as a forum.

Theme

This graduation project started in February 2015 with the intention to define and design a contemporary cultural forum. The overarching theme of the entire graduation studio, a group of 15 students, is therefore the forum. Here, it is explained which direction is taken to arrive at the theme of this specific project called Arche, Archives, Architecture.

The design brief proscribes a design in London or Paris because they both have a defining impact on the Western world and because they are the two most prominent metropolises in Western Europe. Both cities are at the same time metaphorical for both cultural and political principles that are foundational for the western civilisation. Think about pop-culture, modern sports and the Magna Carta, all closely related to London. Think about the French revolution, modernist philosophy and the origin of the great international World Expos, all closely related to Paris.

The first choice made in the theme is to focus on the political aspects of the forum. This is done because the investigation of architecture in combination with politics will help to define the place in the city and in society. Adding to that, Paris lends

itself as an excellent research subject because the architecture and urban planning of its centre is a living memory of political play and aspirations.

The second choice in guiding the process is to choose to investigate the type and program of an archive in relation to the political and metropolitan context. There are two ways in which the forum is connected to the archive. Firstly, an archive is a political building, like a forum it operates by the allowance of the political structure that it constitutes. Both forums and archives are political attempts to condense cultural, national or political communities in a single physical place. Secondly, both having a position so closely related to the society, they both face challenges that need solving, these challenges include amongst many the questions of the digital age, individualism in society, the perception of memory and history, the democratic principle of equality and the meaning of the need for a physical space.

The research question is a condensed version of all of these issues which allows for investigation and elaboration of the theme in various ways. The goal of trying to answer the research question is to attain better in-

sight into the political and physical context of the architectural project to present a meaningful agenda that supports the design. The research question being as follows;

How can an archive be re-interpreted as a political building using architectural principles of order and memory in a contemporary context?

It should be noted that a few things are added to direct the research. The reinterpretation of the archive means that the principle of archiving and the state of the art concerning archiving should be taken into account. Adding to that, the connection with politics is made to be able to assess the political and social consequences and implementations of the archive. The architectural principles of memory and order are inspired on the nature of archiving, this implies two sides of the same coin. On the one side, it means the investigation of the physical order and memory with which the design is concerned and on the other side it is concerned with the social and political memory, history and order which could be connecting understandings between archiving and political forums. Lastly, working in a contemporary context is mentioned because of two things, which are

the starting conditions of the graduation studio prescribes a contemporary awareness and the given that the contemporary context provides an enormous amount of inspiration, context and meaning for the project. That last aspect prescribes taking into account digital archiving, the current state of democracy but also the history of the locus.

Design method/method design

Here the method of working and guidance of the process over the entire graduation year is explained. It is important to note that a graduation project of the master Architecture Building and Planning at the TU/e has both a research part and a design part and that it takes two semesters to complete the process. Because each student has his or her own different approach to the same assignment, the processes are always different and multi-faceted. The title of this chapter is chosen with this multi-faceted aspect in mind; working on such a year-long process requires both constantly adapting and changing the process as well as knowing a clear direction in which you are working

Mixed methods

The way in which the research is done could be described as a pragmatist concurrent method. It is pragmatist because the nature and understanding of the problem is more important than the methods itself. During this research, whatever method became available has been used in order to get a broader understanding of the problem; which is in this case the question of the implementation of an archive as contemporary political forum. The concurrent method is a mixed research method

that combines multiple research methods at the same time. In this way, a comprehensive body of information is combined out of multiple sources into one whole. (Cresswell, pp.9)

Field observation and experiences

The premises of the graduation studio A Contemporary Cultural Forum includes the selection of a location in 'one of the two metropolises in Western Europe, Paris or London'. Therefore a common studio field trip was planned to London. After that, I went to Paris myself twice in smaller groups to be able to compare the two cities and thus to select a location for the project. These trips have also helped to gain a better insight in the atmosphere of different urban and architectural spaces that have a metropolitan and/or political context. Results of this part of the research can be found in the chapter personal archive experiences

Cartography

To understand the size and distribution of cultural and political objects in the urban tissue, as well as to select a location of operation for the design process, maps have been made. Technically, the maps are drawn on a template downloaded from Open Street Maps (OSM).

The data used to draw maps comes from OSM, Opendata.fr and from Institut de Géographie Nationale de France (IGNF) The results have been used to determine and research the location of the project

Literature research

The literature overview conducted was done to conceptualise the understandings coined in the research question. In this way, the state of the art concerning the theme has been described. The results of the literature review are presented in condensed form as the essay. The literature review has led to the essay Arche Archives Architecture

Archive research

This research employs archive research in two ways. The first is to gather information about the selected location in Paris. The second, more important implementation is to understand in what way an archive works. How do you request a document? Where can visitors and researchers go in an archive? How do you search for the right document?

Interviewing

A part of the research consists of an interview conducted with Jan Bos, head of the collections department at the National Library

of the Netherlands. This interview was useful to get a better overview of the state-of-the-art of archiving and of the problems archives currently face.

Case studies

In this research project, case studies are used to get an insight into the different types of contemporary archives. In each different case one or more aspects are analysed in drawings or schemes. The case studies provide understanding of spatial and functional logic of contemporary archives.

Method design

To connect the research process with the design process is to connect the architectural design with the research topic. In this research, that is done by the early but fundamental choice of wanting to design a political archive. Over the year-long process the archive motive has always had a role on the background. Doing this, the process –not the research- is steered in a certain direction which the idea that this will provide a higher level of thoroughness and sophistication. At the same time, having chosen a general direction of eventually designing an archive, the research permits the constant modulation of the idea and the vision behind and about the archive and about

archiving. Fundamental questions like ‘what does the archive look like in the future?’ or ‘is the archive democratic or authoritarian?’ constantly linger on the background. It is through this lingering that the positions found during the research can find their way into the eventual design. Method design means here that to have control over the process it is necessary to constantly redesign the process itself to adapt to newly found

information but to keep in mind the eventual goal which is always to make an architectural design.

The architectural design is a result of this steering process. The concepts of memory and order that play a role in the research question both find their way into the design. That is done through modulation of these concepts according to the outcome of the research.

It is commonly accepted that the arrival of the digital age is definite and revolutionary. It has created a new context for world-wide networks of knowledge, information and social contacts. The world has changed seemingly in the benefit for all, it is a democratic change because it gives all people equal opportunities to develop and express themselves, to make contacts. At the same time new worries about the abuse of power, new ways of controlling and monitoring the population, digital espionage and manipulation are more relevant than ever. Offline, political interest from the public seems to decline, voter turnout is at all-time lows in the Western world and public demonstrations are diminishing. All the while political voices and platforms are more alive than ever in the digital sphere; social media users share and comment on political articles while publishing anything has become available for the masses. Activism has gained a massively new dimension, think about black twitter, the pietitie or the stories about hunger in Madaya, Syria in January 2016. Has then, the principle of a forum shifted to from the street to the web indefinitely?

Arche, Archives Architecture is a search for the possibility to

introduce the richness of online politics in the offline realm. The context is the development of a contemporary political forum in combination with the principle of archiving as a starting point. What does archiving mean? What is the powerful principle of archiving? Can it be democratic? And how can it be implemented as a political forum? are the questions that lead up to the introduction of the topic of digitalisation into the forum.

Arche

It is a matter of origin, authority and ruling, or better; a matter of arche. Derrida starts his work *Archive Fever, A Freudian Impression* with his definition of the *arkhē*, by deconstructing the term to its Greek origins; *arch*. In this way, arche is understood as the beginning, or foundational principle of commencement and commandment at the same time. In other words, that is the starting point of ruling based on ontological, natural and physical principles as well as on nomological, law-prescribing and technical, man-made principles. (Derrida 1997 pp 1-2)

Within the political philosophical discourse, the explanation of arche is important. Political theorist and philosopher Jacques Rancière uses it to go to the basis of politics and democra-

cy. When going back to what democracy is intrinsically made of, he arrives at the first principle that every person is able to assume authority. Therefore, there should be other systems to distribute the origin of ruling than ancient principles of strong over weak, old over young, cultured over ignorant and so on. These systems are what he calls politics. In this reasoning, democracy is a foundational principle that stands at the basis of politics rather than the other way around. Here, democracy is not another way of governing a state but a first figure of distribution of authority, arche, over the entire population instead of over the hierarchically entitled people. (Rancière 2010 pp 60-62)

It is important to place this theorisation in the current time-frame of what Michel Foucault calls Bio-power. The notion that Western politics since the 20th century is concerned with the protection and proliferation of the life and welfare of the individuals of the entire population adds another dimension to ruling and democracy. 'For millennia, man remained what he was for Aristotle: a living animal with the additional capacity for a political existence; modern man is an animal whose politics places his existence as a living being

in question.' In modern liberal democracies the understanding about democracy is not a mere possibility but a defining constitution of life. (Rabinow 1984, pp 264-265) Everyone has the right of expression, protection and opportunities. In the late 20th century this has led to the idea of deliberative democracy by John Rawles and Jürgen Habermas. Political theorist Chantal Mouffe sees a problematic here. (Mouffe 2010) The idea of deliberative democracy is to randomly select people from a population, then to inform them about a specific political context and finally to let them discuss and develop new policies. From a perspective that every person has the possibility to rule and that no specific person should rule over anyone else this gives the opportunity to create a real democracy that is not distorted by the effects of populism and election campaigns (van Reybrouck, 2013). According to Mouffe, there is a distinct difference between politics and the political. Politics are the institutional rules, discourses and practices that define the relations of order and human coexistence. The political is the inherent antagonism between different opinions and contrasting views of people. She argues that a system of deliberative democracy only tries to

find compromises with which all participants can live instead of acknowledging inherent differences. 'This question, pace the rationalists, is not how to arrive at a consensus without exclusion, since this would imply the eradication of the political'. (Mouffe 2010, pp 15) She proposes a system of agonistic pluralism in which the opposition between 'us and them' is no longer a leading question but in which oppositions are truly tolerated as source of advisory ideas. (Mouffe 2010, pp 15)

Archives

Derrida has shown that the archive starts with the principle of the origin of power, arche. To link this back to the context in which Chantal Mouffe and Michel Foucault are working we need to recognise that everyone has a relation to the archive. There is a dual connection; at the same time the archive houses artefacts that define our culture and society, at the same time; the fact that there is an archive and that we have a (distant) relationship with it is also defining our way of life.

It is exactly this dual connection to the origin pointed out by Derrida that makes the archive powerful. On the one hand it name raises the notion of a deep natural origin of knowl-

edge and on the other hand it prescribes a the future by physically imprinting the past. On the one hand it is practical, a place where we remember, but at the same time it defines the culture and society by reducing what we are to exteriorised memory. The internal contradiction of the archive doesn't stop there, because of the split between nomology and ontology, Derrida calls the archive both radically conservative and radically progressive at the same instance. (Derrida 1997 pp 7) Moreover, he recognises in the archive a hypomnesic device, a device which exteriorises memory in another external place to reassure the possibility of repetition, repetition which is on its turn not detachable from Freud's death drive. As a consequence, the allowance of an archive is the same drive that eventually leads it to its own destruction. (Derrida 1997 pp 12-13) This might sound radical but it certainly explains the title Archive fever, a Freudian Impression. To put the paradoxical view of Derrida into perspective it needs to be said that a definitive and total archive does not exist, at least not outside the imaginative library of Borges. This means that the authority of the archive determines the direction, use and in the end, the way in which it can be used.

Before going into the use of the archive it is useful to further dig into another contradictory principle; hypomnesia. Meaning the exteriorisation of memory, the writing down, the recording and the reproduction of thoughts, it is opposed to internal human memory; mneme, and anamneme. Hypomnesia is therefore the original principle that makes archiving possible. One can write down to allow him or herself to forget. And it is in writing and exteriorised memory itself that the most prominent contradiction and duality comes to the surface. In Plato's Pharmacy, Derrida points out that logically, the speaker is father to his speech. Introducing the 'art of writing' a problem arises. Who is now the father of speech? or thought? or memory for that matter? To understand this problem, Plato employs the concept of oppositions. (Derrida (1968) pp97-103). Bernard Stiegler, French philosopher and political and technology theorist, notes that the duality that is the foundation of Western metaphysics finds its origin here. Derrida on his turn wants to move away from this duality. (Stiegler 2010) In Plato's Pharmacy, Derrida uses his concept of difference to explicate this; 'These two types of repetition relate to each other according to

the graphics of supplementarity.' Derrida's two types of repetition are the repetitions needed to convey the true and the untrue. For repetition is, according to Derrida, always a supplementary form of hypomnesia, he argues that actually truth and untruth are linked by this same principle. Therefore, truth should be searched for in processes rather than oppositions.

Stiegler takes Derrida's description and conceptualisation as a first step to define his ideas about hypomnesia in the digital age. In Stiegler's vision, the digitalisation of hypomnesia, has brought us into the age of hyperindustrialisation. During the industrial revolution it became possible to industrialise production, according to Stiegler this is exteriorised memory used to reproduce human labour. Hyperindustrialisation on its turn, is the reproducibility of consumer behaviour instead of production. To illustrate this, he speaks of the transition from mnemotechniques to mnemotechnologies. The first represents the simple exteriorisation of memory known since the stone age until today, from rock carvings then until agendas now. Mnemotechnologies however, are those hypomnesic devices of which the user cannot fully understand any more the inner workings.

Stiegler uses computers and PDAs (personal digital agendas) as examples for these mnemotechnologies. He connects this not fully understanding the inner workings of our devices with the possible power it could give the professionals who do understand the workings. Perhaps now, five years later, more evident and problematic examples can be found.

Late 2011, Facebook noticed that users were using the option to report offensive content on the networking site more than usual. Had the reporting option been implemented to repress porn and violence, it turned out that most users reported pictures in which they appeared themselves because they didn't like the photo. The vast majority of reported content were what users called 'embarrassing photos', embarrassing is not violating so Facebook could only provide the users the option to write the person who posted the embarrassing picture. This gave Facebook the opportunity to test which text of a suggested message would prove to be the most effective in having unwanted or embarrassing content removed by the other user. They realised that with this tool they had the ability to conduct social research on a scale that

had never been possible before. Facebook invited researchers to use their data or to devise new experiments. Up to this point it sounded really positive; providing a better and faster tool to conduct research. (Abumrad, Krulwich 2015) Uproar began however in 2014 when it became apparent that Facebook was able to measure significant differences in happiness of users depending on content generated for a survey on the effect of images on emotions. (Booth, 2014) A study from 2012 concluded that between 2006 and 2010 voter turnout in the United States increased by 0,6% by a Facebook feature which asked Facebook users if they voted while showing how many of their close Facebook friends had voted too.

Regarding this 'mnemotechnological' working of Facebook, one could only wonder in what hidden ways other institutions or companies can manipulate behaviour with or without the public knowing. Have people lost the power over their own behaviour? And if so, is it really a problem? Isn't behaviour constantly being influenced by uncontrollable factors? Whatever the answers to these questions are it stands clear that with the introduction of the digital and social media, the political

realm has gained an entire new dimension.

Social theorist Pierre Lévy said in 1999 that the development of the internet gives the opportunity to build a global hypercortex. The goal is however not to replace human intelligence with an artificial one rather than to provide a new network that promotes the sharing of knowledge. Resuming it can be said that the digital revolution has posed new opportunities and problems at once. Stiegler fears the abuse of information networks by the ones in power while Lévy speaks more about opportunities of more collective understanding. He goes further by stating that the goal of architecture in the 21st century is to develop the architecture of the cyberspace. The last problem has also been noted by Kristen Gwinn-Becker, Founder and CEO of History-IT during a lecture in October 2015. As a graduate of both history and IT, she is concerned by making archival information digitally available for the public. Doing so, she quickly discovered that archives of today that have been digitalised are very literal digital versions of their offline counterparts. While this might sound logical, it really isn't because extracting an analogue archive is a precise and specialist work which requires knowl-

edge about the technique of archiving. So putting everything online doesn't necessarily makes it more accessible for the public. Gwinn-Becker illustrates this by searching for the wealthy 19th century industrial Andrew Carnegie in the New York public archives. Entering Andrew Carnegie in the search field does not give any results while this is what most people would search for. Instead, a search for Carnegie, Andrew would lead to the information on the subject. (Gwinn-Becker, 2015)

These examples show the connection between the power and knowledge in a digital context. It shows that the abled, the ones behind the scenes and the ones in power can access a huge body of information which is produced on an industrial scale. At the same time, several theorists as well as some public voices have expressed their concerns about this tendency. Just think about Wiki-leaks and the leaks committed by Edward Snowden which showed integral access to meta data from social network users worldwide by the US government. However, this still doesn't stop further positive development of a global collective intelligence. Gwinn-Becker and Lévy both stress this to point to generate more attention to make information

accessible for everyone, not only the ones who are familiar with certain digital systems. This brings us back to the foundational principle of distribution of arche, because we believe that everyone has inside the possibility to become a political being, public information should be integrally accessible.

Architecture

Certainly this is an important notion but it seems to miss the connection with the context. If the digital sphere is purely self-referential, only then we perhaps don't need a physical place. In any other case, the online debate is always linked to a physical or real place, a happening outside of the digisphere. In *Between Memory and History*, Pierre Nora speaks about the replacement of memory by history. The Western civilisation in the 20th century has tried to completely write its unchanging complete history and fix it in numerous institution. These are museums, archives, libraries, monuments etc. We do not longer rely on interior 'real memory' to define our history and ourselves, we need exteriorised signs to remind us what we are and where we stand for. (Nora 1989, pp 8) This opposition shows the contrast between human memory, which often changes, and the fixed memory

of archives. It resonates in the contrast between the volatile online politics and the fixed politics. In this tradition it would be logical to try to fixate and institutionalise digital memory as well. However, the negative aspect of fixation is that relentless storage of memory alone is that there exists an exteriorised truth without proper relations to the context and without the chance to be flexible.

In 'Architecture, power and national identity', Lawrence J. Vale points out that political power has a locus. Vale argues that government buildings are attempts to build governments and regimes. In this sense, architecture both facilitates politics as well as representing it. Here lies a contradiction, while the functional aspect concerns the strict demarcation and regulated access to these buildings, this occupation of important space is at the very same time the place that safeguards democratic values. Vale argues that in some cases the powerful and monumental architecture of institutions widens the gap between people and the powerful. Here the same negative aspect appears as in the institutionalising of memory, the authority of history and truth. On the other hand Vale shows that institutions are there to remind society of

its central and collective governance, which is needed to provide a safe and prosperous nation.

Like Lévy mentioned, the task of architecture in the 21st century will be to provide clear access to the digital memory. It is important to note that this also needs a physical place because the human interaction and understanding about politics takes place in the physical world. Jacques Rancière talks about politics as a constant battle of the rulers plugging the holes in the law that are constantly made by the ruled. Chantal Mouffe theorises that contemporary politics is a politics of agnostic pluralism which is a direct effect of intrinsic human differences. All these battles and differences find their origin in the physical world, not online. It is therefore needed to connect the online antagonism with a kind of architecture that is not only focussed on making a memory institution but also shows its intrinsic interest in the memory and the significance of the city.

This memory in the city should not be an institution like a parliament building or a national library. It should be more open to create a forum where people can express and discuss their differences without yet

making any inferences on good government or righteousness. The power of the archive is not used to express the power and history of the society but rather the ever changing nature of it. The connection between online and offline is made in a physical place not to define history but to define the future. The archive is in this way constantly in conversation with society about its own constitution. Here, the authority over the how to archive has become a part of the discussion.



Paris of Haussmann

The most remarkable characteristic of the Parisian cityscape is the plan that was executed under the supervision of Baron Georges-Eugène Haussmann during the second half of the 19th century. Still today, this plan dominates the impression of the city with its system of wide boulevards, long lines of sight and closed stately building blocks. The monumentality and the scale of the 'plan Haussmann' proves to be so rigorous that nearly all new developments have to take a position in regard to the plan.

Before Haussmann was granted the opportunity to create a plan of this scale, the idea of creating a city from straight lines and wide boulevards already existed in the royal gardens of Versailles. Although this concept had not been implemented before in an urban environment, the revolutionaries of 1789 regarded it as a new ideal that fitted the aspirations of a rapidly developing republic. However, during the first half of the 18th century a series of monarchies and republics quickly succeeded each other as the ruling power of France meaning that serious urban developments could not be done. Simultaneously, Paris had grown rapidly as a result of the industrial revolution. In the 1850's Paris counted over a

million inhabitants and was still growing. The large population put a lot of strain on housing and the high population density combined with a still medieval urban texture made Paris it a hotbed for civil unrest.

The narrow and haphazardly built streets made it very easy to disrupt the city, and with that, the nation, by throwing up barricades. During the revolutions of 1830 and 1848 barricades played a large role in consecutively overthrowing the restored monarchy and the July Monarchy. In 1848, the Second French Republic was proclaimed already in 1851, Napoleon Bonaparte's nephew Napoleon III overthrew the Second French Republic and established the Second Empire.

In 1853 he appointed Haussmann as prefect of the Seine. Haussmann was assigned with the rigorous modernisation desired by Napoleon III. Wide new boulevards known as percées tore apart the existing tissues of often dangerous and poor working class areas to make leeway for organised and spacious apartment buildings for the bourgeoisie. Since the prefect was working from the private domain, the changes could take place without too much public interference but was largely funded with money

◀ The heart of Buttes des Moulins in the 1860's



from the (bourgeois) taxpayers. Nonetheless, the renewed and monumental look that still characterises Paris today was a great success with its intended target group; the bourgeoisie.

The spacious boulevards provided a cleaner, safer and more modern city. At the same time, Napoleon III's hidden agenda was executed; barricading these wide boulevards was far less easy and troupes could be deployed to knock down uprisings more easily as well. Never again has a government been overthrown by civil unrest, riots or barricades since Haussmann designed a new Paris.

When Napoleon III's rule ceased in 1870 as a result of the Franco-Pussian war, the Third French Republic was installed and Haussmann was dismissed. However, this democratic government effectively continued executing Haussmann's plan. Until the early 1920's, the typical 'Haussmannien' housing blocks and percées were being built.

Preliminary conclusion

This short review of a 'Haussmannien' revamp of a neighbourhood shows two things; it is possible to disrupt or displace the social issues of a certain place with heavy force as long as a big authority is behind it and secondly, the perception of a city changes. When the plan was new, the bourgeoisie thought it was modern and spacious while the lower classes despised the plan because of the social disruption. Nowadays, however, the plan Haussmann is commonly lauded for its monumentality and uniformity; an image that sticks to the touristic and romantic vision on Paris.

▲ The current Avenue d'Opera that replaced the unsafe neighbourhood



◀ The Buttes de Moulins neighbourhood after the Haussmann rebuilt

▼ The destroyed building plots

▶ The redeveloped building plots

Archival Architecture

To understand the state of the art in archive building, several different types of archive typologies are analysed, the questions asked are:

How do you access an archive?
How is the division between public and private made?

Besides an analysis of physical archives it should be noted that archiving is changing from analogue to digital. Here, some of the issues are raised as well.

The examples treated are the large New National Archives of France, a small archive in New Zealand, the Museum of Modern Literature in Bavaria, Germany, the EDF archives in the French countryside, the archaeological archives by Ai Wei Wei in China and finally the internet archives in California, USA. The New National Archives in France represents a large public project which has the specific aim to collect and conserve public memory. The Treasury Research and Archive centre gives the opportunity to assess the possibility of a very small archive which tries to blend with its urban environment. The Museum of Modern Literature in Germany poses the question of connecting the archive with a public function. The archaeological archives in China provide a more

metaphorical approach to the concept of archiving and finally, the internet archives represent the problems that arise when archiving shifts from an analogue state to a digital state.



Museum of Modern Literature

David Chipperfield

Marbach am Neckar, Bavaria, Germany

2002

This example stands for a huge trend in archive architecture; combining the archive with exhibition spaces. The museum is built next to the German literature archive in this town where German dramatist writer Friedrich Schiller was born. Specific to this museum is the use of history as well as context. The somewhat static and tectonic architecture by David Chipperfield is the backdrop of the conservational motive of the museum and archive context. At the same time it allows for demarcation of both open and closed spaces. The open spac-

es connect the building with the views and the environment while the closed spaces allow for the display of fragile archive pieces under artificial light only. The accidented terrain asks for solutions to the differences in height, also here it reflects into the typology. The archives are at the same level as the museum but are buried underground into the hill. The exhibition spaces that are light by artificial light only are underground too but border spaces with views over the valley at the same time.

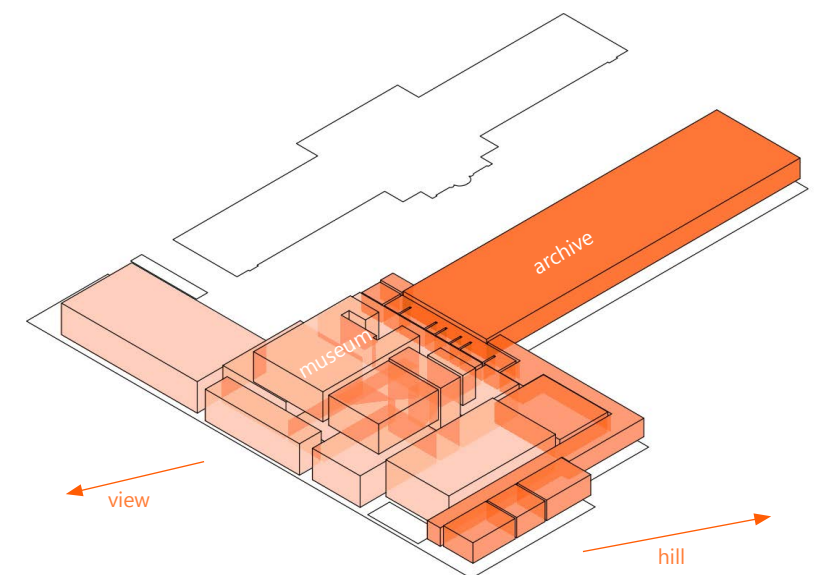



◀ 1.1 The void between the two typologies of the New National Archive

◀ 1.2 View towards the public entrance of the New National Archive

New National Archives of France

Studio Fuksas

Pierrefitte sùr Seine, Seine saint Denis, France

2013



The French New National Archives represent the archiving of documents of political regimes spanning from the 7th century to the 5th French republic of today. As the largest accumulation of French collective memory, this is a highly symbolic project. Fuksas has developed an architectural scheme in which two opposing types appear to stand separated. The contradiction stems from the 'order and chaos' inherent to the archiving process. The large monolith volume holds the archives and a public reading room. The monolith is shaped and materialised to recall the idea of a treasure chest. The counterpart of the archive ensemble, consisting of so called 'sattelites', houses softer functions like conference halls, reception spaces and offices. The satellites set themselves apart from the monolith in glazed transparency, large cantilevers and a seemingly chaotic arrangement of architectural volumes.

The next spread features two analyses that are made with the aid of the ground floor plan published by the architect. From the left page it can be seen that while the two parts of the typology appear to separate the archive from the offices and public functions, the division between open and closed runs through both parts of the complex. The difference between the public and closed parts is clearly recognisable in the plan; the public part consists of large open and fluid spaces that house reception areas and reading rooms while the closed-off archive space features a more strict and utilitarian layout. From the analysis on the right hand side page it can be seen that both systems are meticulously separated and that access to the archive spaces for the public is regulated through a centralised access point.

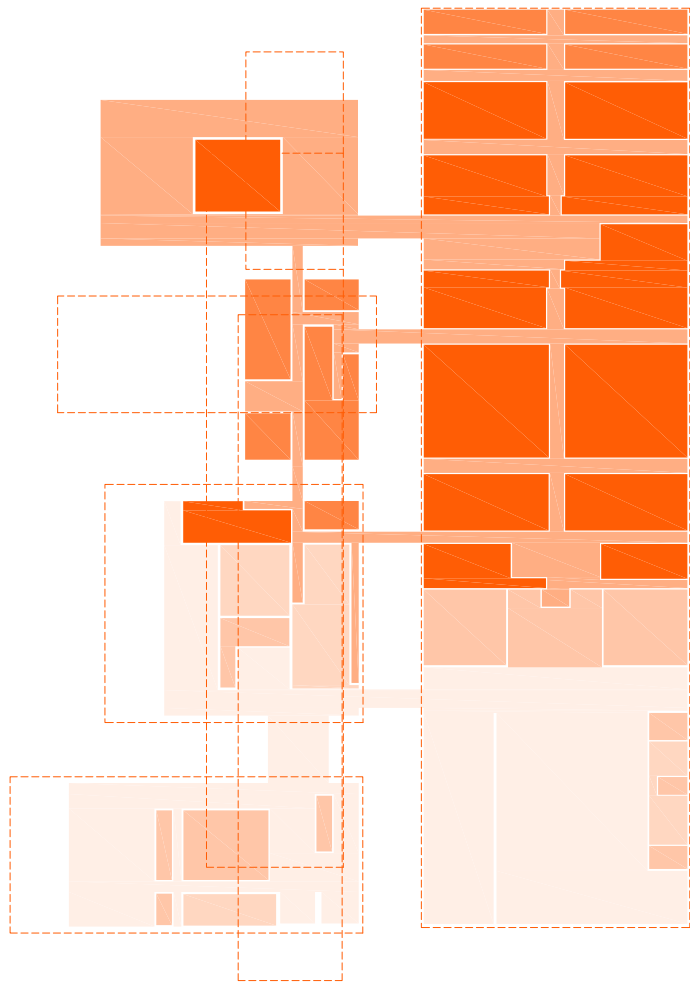

- Archive store and auxiliary spaces
- Archive circulation/expedition
- Offices
- Auxiliary to the public spaces
- Conference rooms/ public offices
- Public space/reception space

Analysis of spatial arrangements.

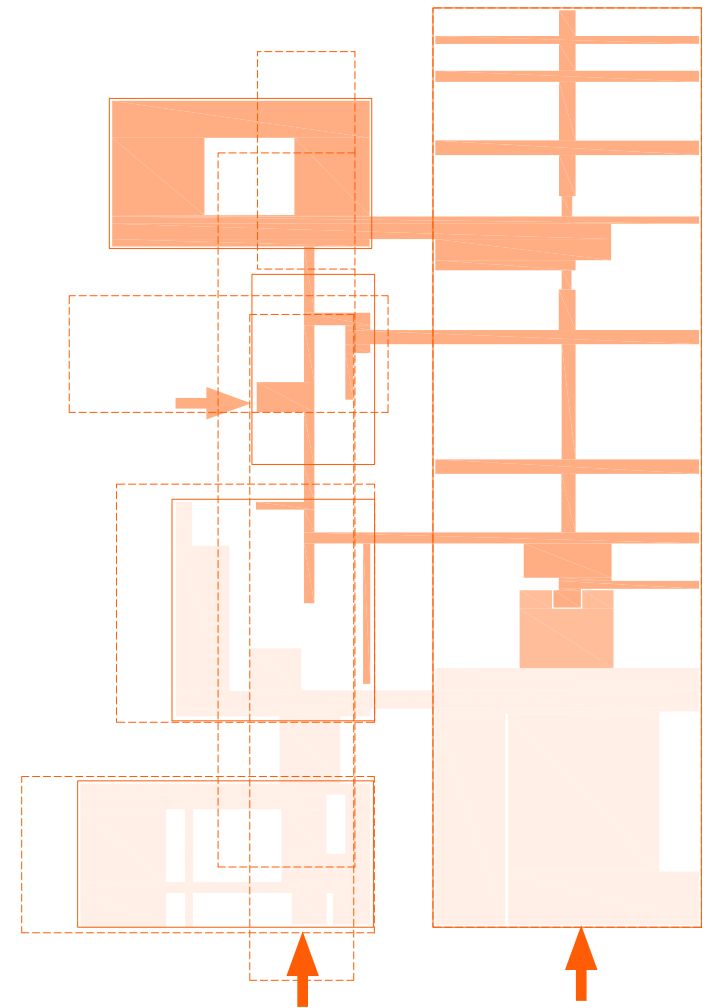

- Archive circulation/expedition
- Public archive access
- Public circulation spaces
- Public entrance
- Staff entrance

Analysis of routing and access



The Treasury Research Centre & Archive

Architectus
Thames, New Zealand

2015

The complex consists of the renovated *Carnegie Building* which is exemplary for local late 19th century architecture and a newly built annex. Goal of the renovation is to realise a genealogy centre, an archive and research spaces. The specific technical requirements for the archive and research spaces were the reason to extend the building while the existing monument would have to be altered to much. The existing structure now houses a public research room and recep-

tion space, the annex holds the archive and work spaces which are fenced off from the public. The architect chose to refer to the urban surrounding by conforming to a horizontal and orthogonal typology that fits within the scale of the context. They claim that the 'innovative' facade brings into memory the innovative spirit needed to realise authentic architecture like the Carnegie building.

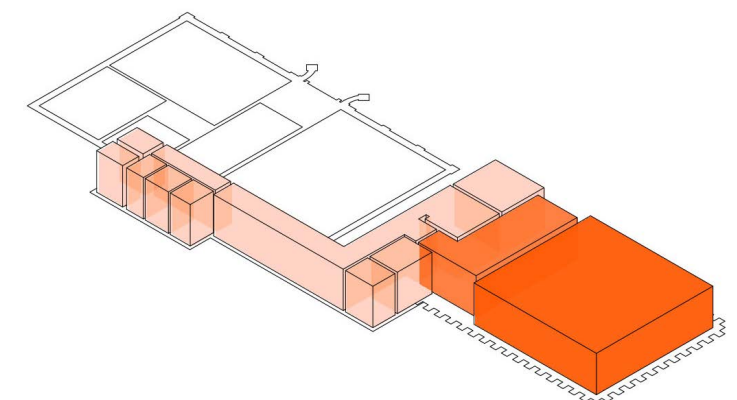
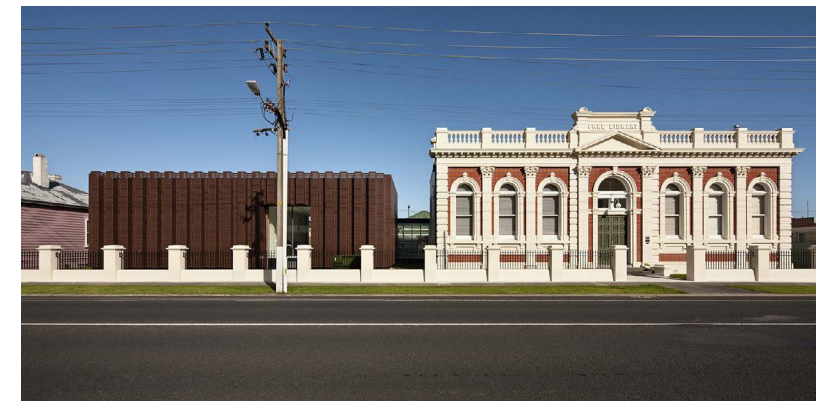

◀ Large window in the archive annex shows the working space

◀ View on the ensemble from the street

▶ Axionometry of the spatial layout



EDF Archives Centre

LAN Architecture
Bure, Meuse, France

2008



This archive of a French energy supplier is marked by its highly rational character. The goal is to gather paperwork of archives scattered over multiple power plants into one compact place. This program determines the compact appearance of the building. It results in a large square block that houses 4 stories of archive space, the offices are tucked underneath and besides is in a more playful and round typology that follows and plays with the contours of the landscape as is shown in the isometric image on the next pages.

energy consumption by being energy efficient. The building reduces façade surface in its typology and relies on renewable energy sources. The expression of the façade is made by casting stainless steel discs in the concrete; this is an attempt to give the impression of 'lightweight movement' of the architect.

◀ The typology seen from its surroundings

◀ View into the patio on the ground floor

As an institutional building of the energy company, it tries to express the value of reduction of

Archeological Archives

Ai Wei Wei
Zhejiang, China

2011



Ai Wei Wei is known for his controversial approach to history. Being a specialist in Neolithic pottery, for his art he smashed ancient Chinese Neolithic vases or painted shining silver Coca Cola logos onto it. For the archeological archives he cooperated with Swiss architects Herzog & de Meuron like he did in the construction of the iconic 'Bird's Nest' Olympic stadium in Beijing. The archeological archive heavily depends on the metaphorical position of archiving. In a conversation with

Hans Ulrich Obrist he revealed that this not merely an archive or museum to house Neolithic pottery but he might someday use the vases again in his artworks. In this way, the archive is questioned on its own foundations. This is reflected in the typology; the building is a long beam with a hexagonal section. Being buried half-way into the ground on one side only the generic shape of a house is visible, on the other side the typology is 'excavated' to reveal the true shape.



- ◀ A landscape garden is excavated like an archeological site
- ◀ The paving goes with the hexagonal shape of the entire building
- ▼ The front façade reminds of the shape of a house
- ▶ The hexagonal shape is half buried

Internet Archive

Brewster Kahle

San Francisco, California, United States of America

from 1996



The Internet Archive (IA) strongly represents the idea that conservation is a pillar of modern society. It teaches us about successes and failures in the past promoting a positive development. The internet archive is founded by internet pioneer Brewster Kahle in 1996 at the same time with web application Alexa, which is able to trace surfing behavior of internet users. In 1999 he sold Alexa to Amazon for \$250 million, since then he uses this capital to build the Internet Archive. Besides storing and digitizing collections of (mostly) American libraries, government institutions and private parties it also scans the entire internet several times a year and stores the information in its archive. The Internet Archive's goal is to make all information available to all people at all time. It promotes this equality by being completely open about its operations and by expressing that it has no particular interest or benefit of discoveries that users might make in its archive. (internet archive website, tegenlicht)

presents itself as an institution that constantly researches its own development to cope with new conditions. Another aspect of this rapid evolution is that storage media are become outdated more quickly, the Internet Archive also concerns itself with the complete re-storage of all its data to new media every 10 years. The IA is located in a disused Church in San Francisco in the United States, Kahle asks himself in a Dutch TV report in 2014 what a library in the future would look like and concludes that it would probably not include bookshelves. At that time, two towers of 3 server blocks of about a building story high represented 5 petabyte (million gigabyte) of a total of 15 petabyte for the entire archive. The two server towers are installed in the main hall of the disused church. To make the archives less vulnerable to damage by for instance natural disasters the entire archive is currently being copied to other facilities one of which being the recently built Alexandria Library in Egypt.

Because digital information is currently increasing at exponential rates, the Internet Archive

▼ Copy of the Internet Archive in the Bibliotheca Alexandrina

▼ Two server stacks in a disused church represent 5PetaByte of the IA's 15 Petabyte total in 2014



◀ The internal layout of the national library is often called confusing and disorienting.

Personal archive experiences

To get a better understanding about the working of archives I visited several archives. I met up with Jan Bos, head collections at the National Library of the Netherlands in The Hague on 31 July 2015 to talk about the challenges the National Archive encounters in their mission to remain a relevant place for culture, research and history. To get more information on the historical context of the chosen location I went to the Bibliothèque historique de la ville de Paris, the Commission de vieux Paris and the Archives de Paris on 24 and 26 October 2015.

National Library of the Netherlands

For Jan Bos it is really clear. There is no substitute for handling original documents. The imaginative power of the paper archive is the idea that someone else has held his or her head above the paper the same way you might do if you extract it from the archive. No scanner in the world can digitize the texture of ancient parchment or the smell of a letter that travelled on a colonial ship between oriental spices. It is exactly this attention to detail that is important for historical research; is there an imprint of a previous letter? where was the paper made? what kind of ink was used?

Historical research to eras be-

fore the digital age will always legitimise the existence of national archives and libraries for the aforementioned reason. Bos sees a cultural significance of the archive in its historical context, the archive helps to define the cultural identity of the Netherlands in this case. As a consequence of that, he feels that the archive has a legitimate part in our cities; it is important that is embedded in the urban fabric as an accessible monument for our own history. To the question in what way the archive is the connection between history and the past, like Jacques Derrida sees it, Bos is somewhat reluctant. For him, the main function is that of preservation, a task that is taken really seriously. Sure the history will teach us something about the future but it is not an idea they work with every day, perhaps also because an archive should not have any interest in what conclusions people might make from archival research. They are mainly there to preserve information.

This intrinsic interest in archiving documents ignites the difficult question how or if we should go on preserving everything we can. According to Bos, it would be impossible to archive everything that is being saved digitally at the moment. However, is it really a problem that we don't archive the text messages

people send each other before meeting to go out? In the same way, we have not archived trivial phone calls in the 1950's either. On the other hand, saving certain random online content could provide a real insight into daily life for 200 years from now.

Then there is the issue of use of the archive, besides the occasional historian, most users in the archive conduct genealogical research on their own family trees but this number will probably go down in the future since more and more documents will become available digitally. Another prominent group of users are university and high school students; Bos often heard the urban myth amongst school going youth that when studying in the national library one could hardly fail their final high school exams. This group rarely uses the actual resources offered by the library but when

asked about it, they wish to keep the environment the way it is; they like studying in the quiet environment surrounded by all these old books. To attract more attention and a bigger crowd to the archive currently the archive manifests itself in exhibitions both at the library as in other places. For instance, there was an exhibition at the The Hague city hall with old photos of the city. It turns out that especially those exhibitions brings new people to the archive or the online portals of the archive because people become triggered by the old photos.

To attract attention and awareness to the archive is seen as an important given; just like the fact that Bos is convinced that the National Library belongs in the centre of the city amongst the people. To the question if the archive could also function in a more symbolic way, just being



◀ Spaces like these in the National Library are mainly used to work quietly, not so much for archive work



a place of conservation but not of public interaction he denies firmly. We should not in any way want to replicate the feeling of a ghost or spectre watching over the people in the form of an all-encompassing archive like the KGB archives known in (Soviet) Russia or the DDR.

Bibliothèque historique de la ville de Paris

The location that I have chosen for the design of this project is a junction of two boulevards in Paris. Under one of the two boulevards lies the Vôte Richard-Lenoir, a vault in which the Canal Saint Martin lies, around 6 metres below street level. For the analysis of the location it is necessary to find out the exact location of the canal and the exact measurements of the vault. Although a lot of historical information about central Paris can be found in digital photo banks of various instances, I could not find the information I wanted which was a good reason to ask some help

▶ The main reading hall in the *Bibliothèque historique de la ville de Paris*

from the historical library of the city of Paris. The *Bibliothèque historique de la ville de Paris* is located in an *Hôtel Particulier*, a (former) private mansion of a wealthy family in the old Marais neighbourhood in the centre of Paris. The architecture of both the exterior and interior of this library fits beautifully with an archaic or romantic association one might have with the archiving of ancient books and documents. The facades feature the typical yellow sandstone and small windows, inside it is all dark wooden wainscoting and green velvet.

In half English half French the librarian kindly helped me with my search, she showed me that there was much more digitized information online than I had initially found. She emailed me the a link with the most useful search results so I could decide whether I could come back to do more research in the non-digitized section of the archive; in which case she would

also offered my help. It struck me that I was received with such kindness and that my interest in the history of Paris found a lot of sincere resonance with the librarian. After helping me with the email she suggested I should go to the Commission de Vieux Paris which has a large collection of 19th and 20th century photos which could also benefit my research. For old construction or permission drawings of public works I could go to the Archives de Paris.

Comission de Vieux Paris

The commission is not a public venue, I had to ring the doorbell and explain my story at the door. Luckily the worker who was there had a little time to help me find some old photos of the location. In a large catalogue the available photos were indexed per address that are stored in large bookshelves with archive boxes scattered all over the office. Sadly, here was still nothing to be found about the underground canal. The best advice she could give me was to continue searching at the Archives de Paris.

Archives de Paris

My last stop in Paris was the Archives de Paris, this archive keeps all public records of Paris. If there were drawings of the 19th century Canal Saint Martin it would have to be here. This

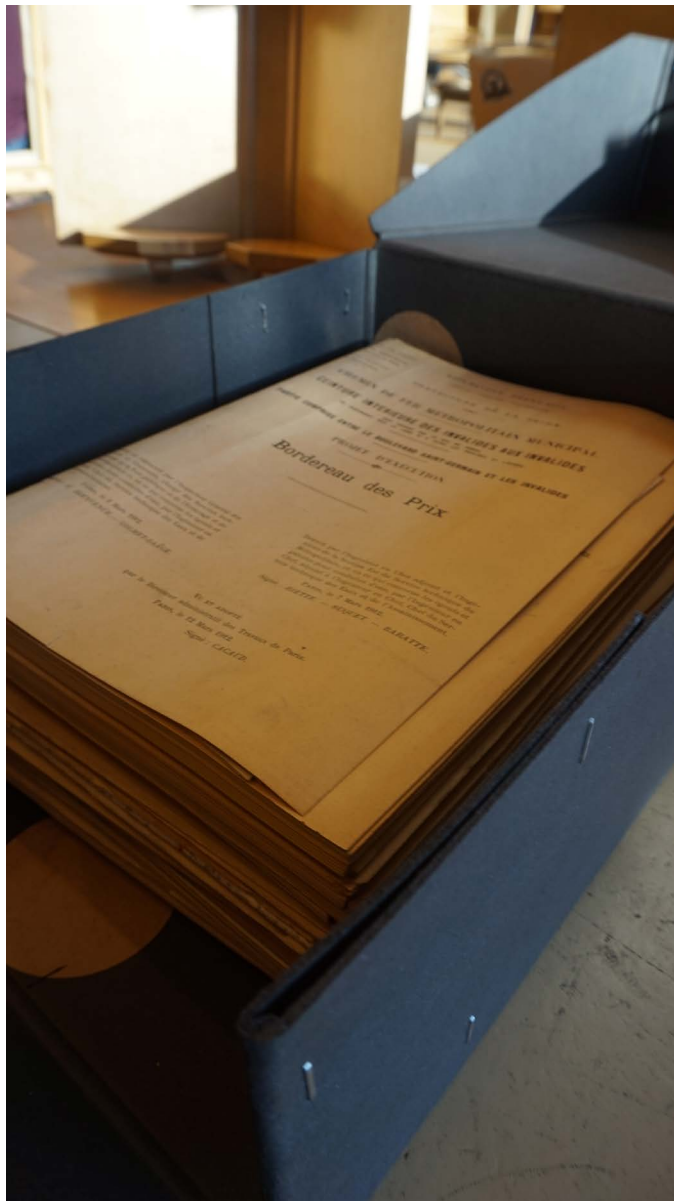

was also a good opportunity to discover how the process of extracting an old document from an archive really works.

The Archives of Paris are kept in a postmodern looking concrete building on the outskirts of Paris, close to Porte des Lilas. The shape of the building is easily readable, the public part is behind the glass facade on the first floor and the big volume behind probably houses the archive documents. When entering a small door on the ground floor, I arrive in a reception space. Here I explain my story and the receptionist sends me to an archivist who sits in a room behind the reception. He is able to explain me how to search the archive with the aid of catalogues that name specific search numbers of document series. Within the catalogue of canals and sewers I would

probably find more information about the Saint Martin Canal. After my consultation with the archivist I went back to the reception to get a archive pass which is needed to request documents from the archive. The pass is linked to my passport and carries my name; another security measure prescribes that all visitors of the archive have to put bags and coats in lockers. Cameras, pens and paper should be carried by hand to the archive or in a transparent plastic bag.

The extraction room of the archive is a large space on the first floor, daylight enters through coated glass to protect the documents. Here the same catalogues that the archivist showed me can be found. After browsing through a few different ones I request two documents of which I think it has the

- ▶ The extraction room of the Archives de Paris
- ▼ The extracted documents come in heavy carboard archive boxes and still feel cold from being in the archive
- ▶ The permit drawings for the urban plan of the location in the 1860's

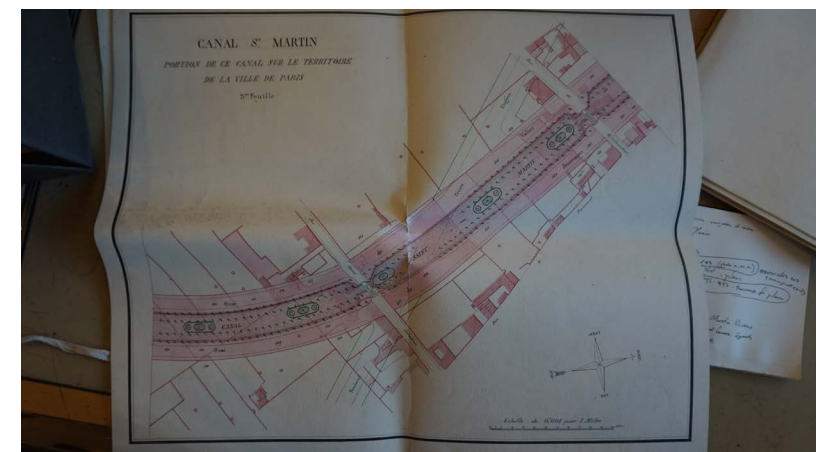

information I want. The request should be made at a computer which links your pass with the request, then you enter the call numbers of the documents you would like to view. Half an hour later I can pick up the requested documents at another desk. Behind this desk there is a constant come and go of documents by archive workers that use steel trolleys to carry them. When I collect my documents I notice that it is much more than I expected; what I thought was a document is actually a 15cm high stack of documents of the same category in an archive box of thick cardboard, I also discover that one of my documents is the wrong one, probably the call number was entered falsely and the other one I requested does not have the specific information I want. I decide to request one more document, the permission drawings of building requests related to the canal. After another 45 minutes I find my newly requested search at the request desk. In these documents I find more clues about my canal, there is a drawing of the original urban plan from when the canal was covered in the 1860's and drawings from a power plant that wanted to build an underground tunnel next to the vault.

Still not what I wanted, a cross section of the canal showing the dimensions and the depth.

Luckily, the search terms given to me by the librarian at the Bibliothèque historique de la ville de Paris provided access to such a section I found out later at home. However, no time was lost, I now have experienced myself what Jan Bos was talking about, a certain pleasure in retrieving old documents. I found it pretty astonishing that with a bit of effort I could handle 150 year old blueprints of the urban plan of my site, along with the hand-written letters and permits that come with it. Another striking thing was that although there were a lot of old folks doing genealogical research, I discovered that there were also a lot of young professionals that needed something from the archive. Those include some architects' interns whom I saw taking photographs of original architectural drawings and a man in suit of whom I think he was looking for some legal documents.

Preliminary conclusions

Things that this experience taught me is that archivists and librarians are often eager to help, themselves being interested in history as well. The infrastructure of an archive is complicated, so this help is much needed. For someone not experienced in archive searching it can however mean that one's

search is very much guided by the help offered by the institution.

Another thing that stood out is the given that archives try their very best to be democratic and open institutions. At the same time they promote a cultural significance that I would call singular and intellectual. The focus is mainly on old maps and photos, (classic) literature and genealogy. In the age of pluralism I would ask if the archive would be more relevant to the whole society if it would focus more on current or contradicting issues.

The internet archives are a good example of this. They categorise everything but are seemingly not interested. This principle is contradictory to the nice librarian that helps the archive searcher but actually stands as a basic principle before archiving in my opinion. The only interest the Internet Archive has in its collection is to make it better available and to make it larger. They are never talking about content, only about the user.

In this research it is important to keep in mind the archive as political forum. If the archive would reflect the pluralistic society it should involve the public on a very basic level like the internet archive. Another interesting

aspect of an archive as a forum is the connection between the offline and online fora.

Location choice and analysis



Why Paris? The choice for the planning area in this studio is given; either London or Paris. The reasoning behind this is that only those two cities are true (Western) European metropolises. These two cities are deemed most suitable for a design that can take up a critical position towards the metropolis.

My choice for Paris has three reasons. First of all, I consider London a global city while Paris feels more attached to its European identity. Although both cities have an important international political position, the history of Paris during the enlightenment and the French revolution still have a massive impact on our politics today. For instance, the separation of powers which is still a foundational principle for liberal democracies today, was conceived during the French revolution.

Besides that, France is one of the founding members of the European Union and has an exemplary role for European cities. Paris shares the social issues that arose after mass immigration of the second half of the 20th century with cities like Amsterdam, Berlin and Hamburg. In London, people of all ethnicities seem to have a place and are more embraced by society, setting London positively apart as

an odd European city.

The last reason for choosing Paris over London is its cityscape. Talking about archives and archiving, the extensive plan by Haussmann seems to turn the city into a real life archive for architecture of the 19th century. Considering the public nature of the forum combined with the past-present-future logic of an archive, this project would be very suitable for taking a stance in regard to the audacious 'Plan Haussmann'.

To find a suitable location, cartographic research has been done to determine a place that for the archive. The goal of this research is to find a place that is on the border of the very centre of Paris, the culturally and politically significant place and on the border of more regular dwelling areas. The next pages show the result of these cartographic researches and the chosen location.

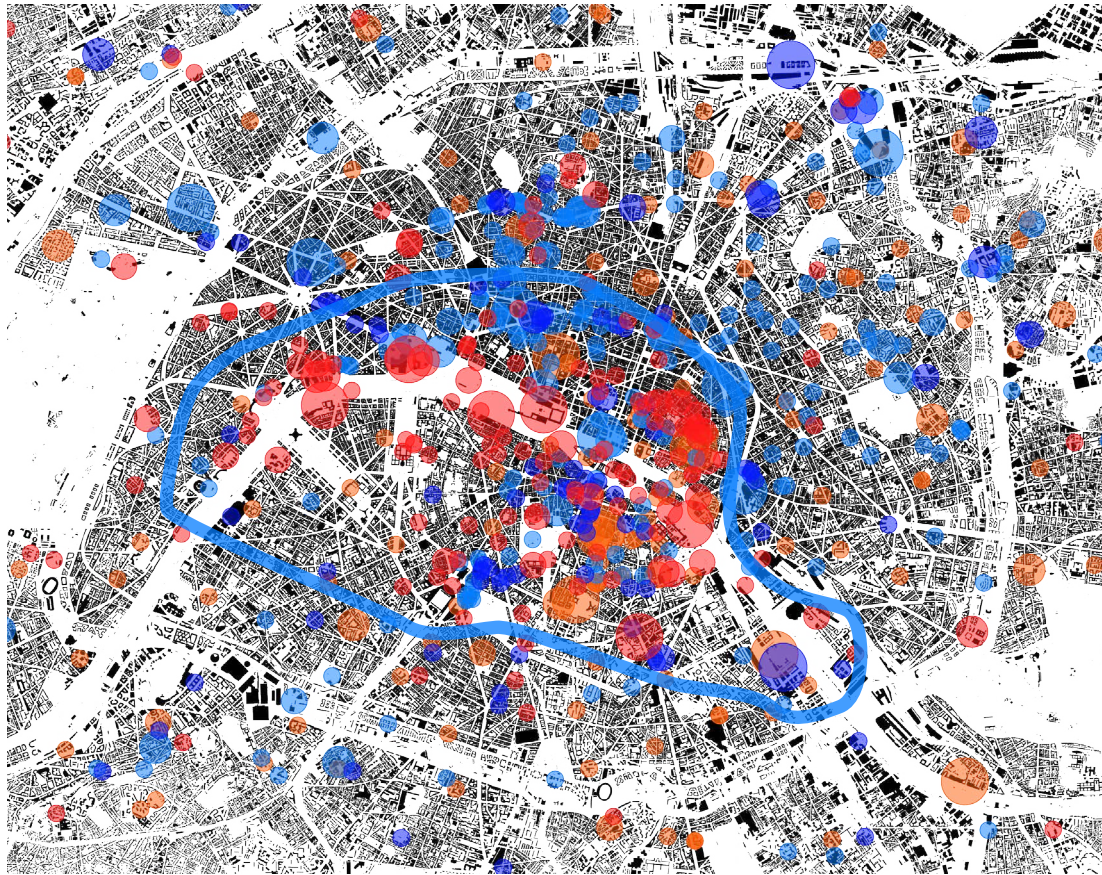

Cultural Paris

This map shows the cultural venues of Paris. The map is made to show how the cultural institutions mark the centre of the city.

The distribution of cultural buildings in Paris shows the way in which everything in Paris, and France, is focussed onto the centre. Approaching the centre, the density of cultural institutions becomes more and more dense. The location of this project is on the edge of what could be regarded as the very centre of Paris.

Legend:

- Library
- Museum
- Theatre
- Cinema
- Cultural core area

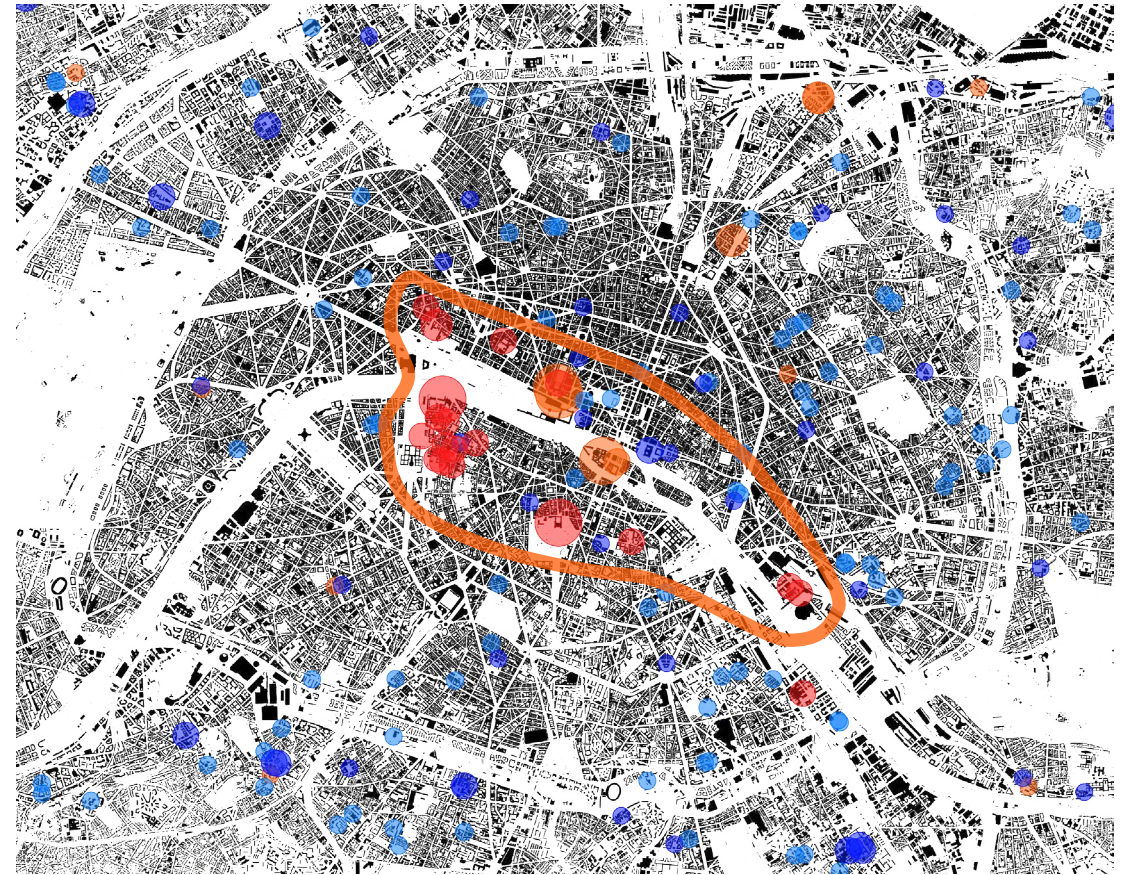

Powerful Paris

This map shows the powerful political and judicial institutions of Paris. The map is made to show how the political and judicial institutions mark the centre of the city.

Like the cultural venues, the political and judicial institutions are clustered towards the centre. However, the democratic values of the Republic make for a very equal distribution of less significant political buildings.

Legend:

- District court
- High court
- Ministry
- Parliament
- Community centre
- Town hall
- City hall
- Political core area

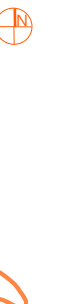

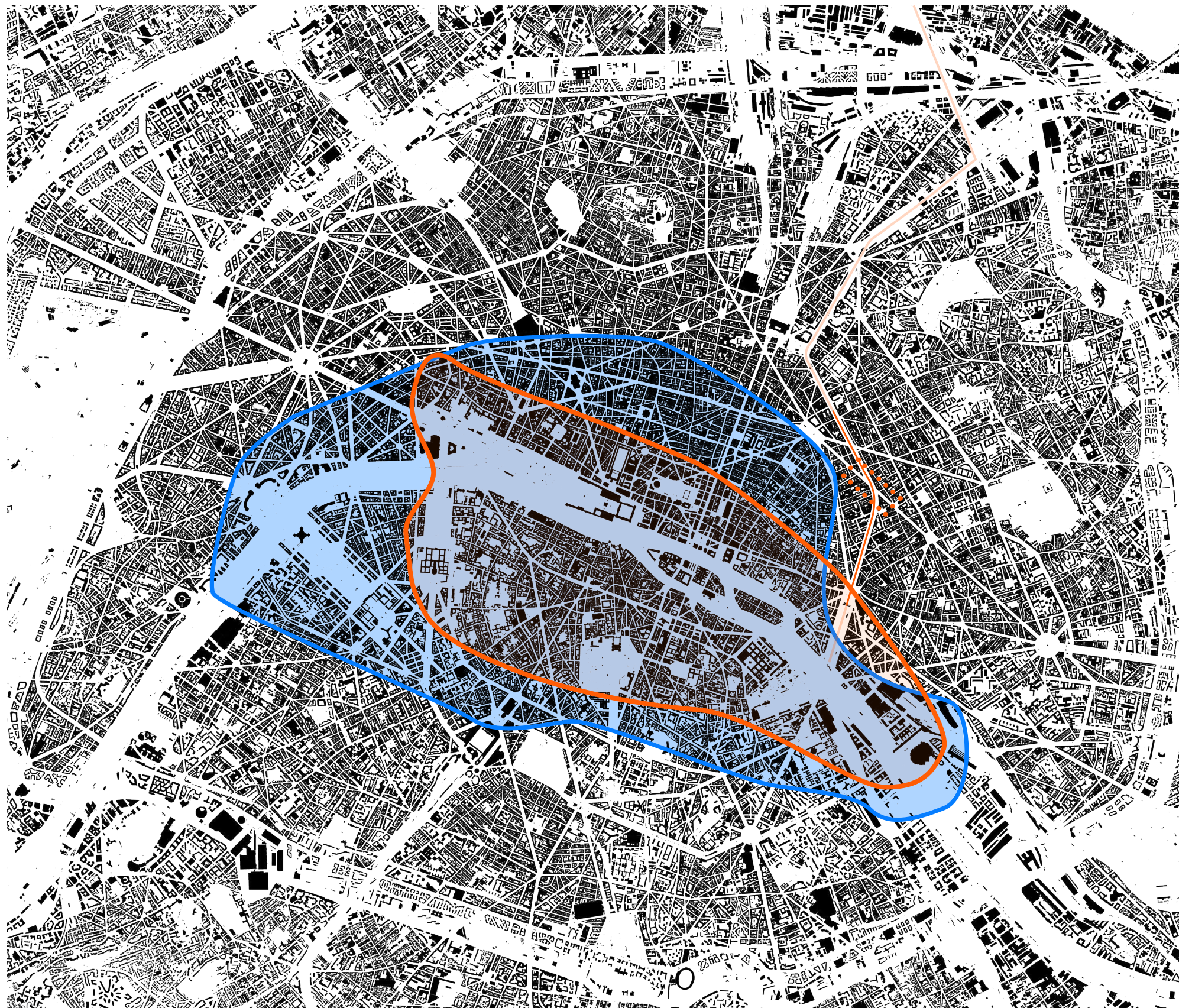





The location chosen for this project is the intersection of Boulevard Voltaire and Boulevard Richard-Lenoir in central Paris. As is shown in this map, the location is on the edge of both the cultural and political core area.

Since the project is a search for a way in which an archive can be implemented in a modern political society. The public nature of the project as a digital archive physically linked to the public political events and protests referred to in this map. This location is physically linked to history through an underground canal and direct links with important political squares in the city of Paris, the Place de la Republique and the Place de la Bastille.

Under the location lies the *Voute Richard Lenoir*, an underground tunnel housing the *Canal Saint Martin*. The connection with the canal provides another chance to interact with the history of the location.

Legend:

- Canal Saint Martin 
- Underground section 
- Location 
- Cultural core area 
- Political core area 

0 50 100 200 500

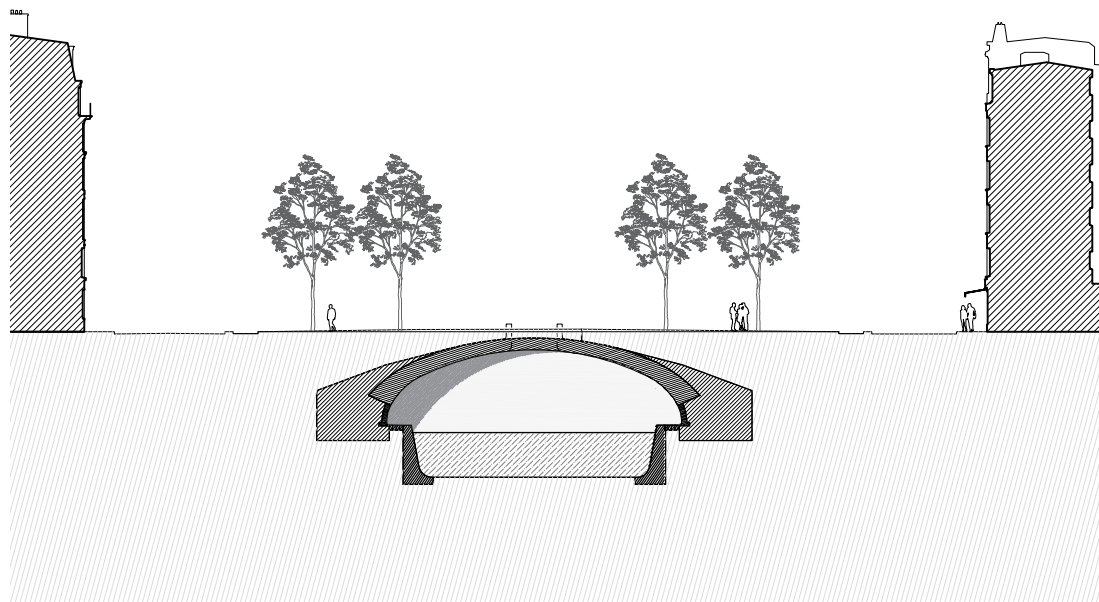
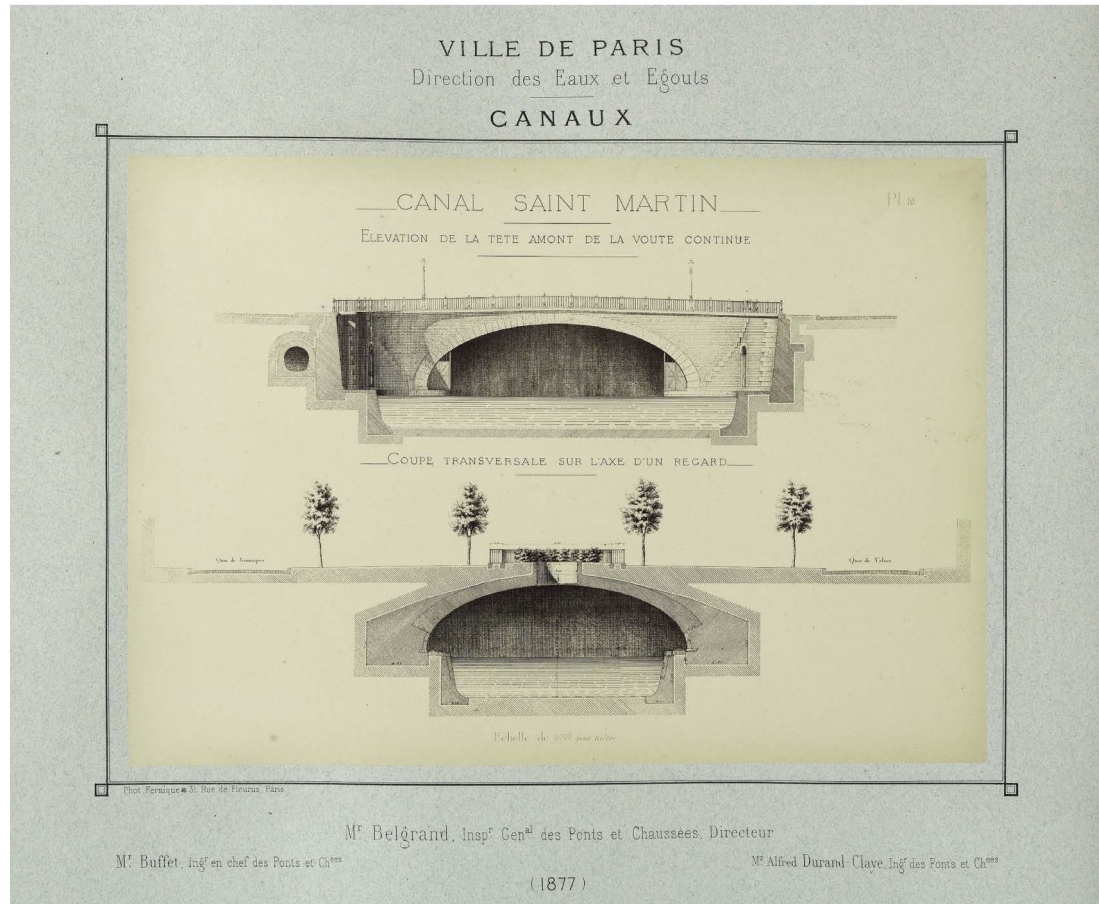

Canal Saint Martin

As mentioned earlier, Archive research has been done to determine the location of the *Canal Saint Martin*. The image on the opposite page is found in the digital archive of the *Bibliothèque historique de la ville de Paris*. This section is used as a underlayer for the digital drawing below. The digital section is used to determine the place of the canal on the urban map, shown on the next page. This

is done by taking the positions of the holes at the centre of the canal and drawing a centre line through them. The positions of the holes can be precisely determined with the aid of the cadastral map of the city of Paris.

The pictures below show the construction and the interior of the canal. The canal is still in use, mainly tourist boats go through it but light freight traffic is also still possible.

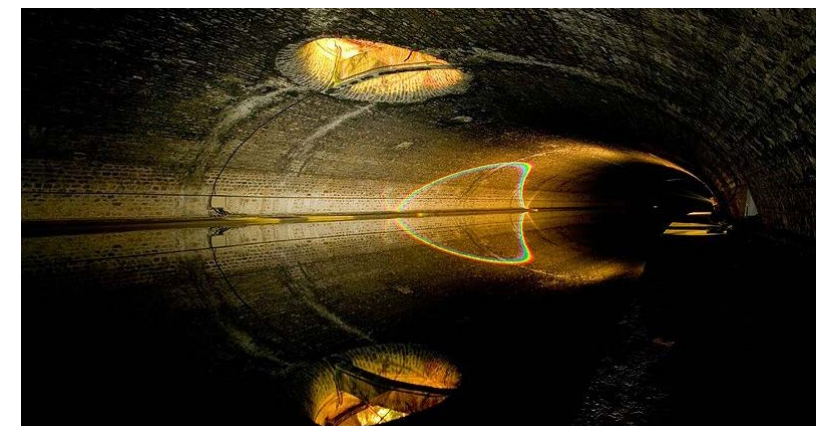

▶ Extract from <http://bspe-p-pub.paris.fr/>, digital portal of French municipalities
◀ Redrawn section of the Boulevard Richard-Lenoir with the Canal Saint Martin

◀ A tourist boat enters the Vault on the north side locks.

▶ Photograph of the construction of the vault

▶ Photograph of the interior of the canal

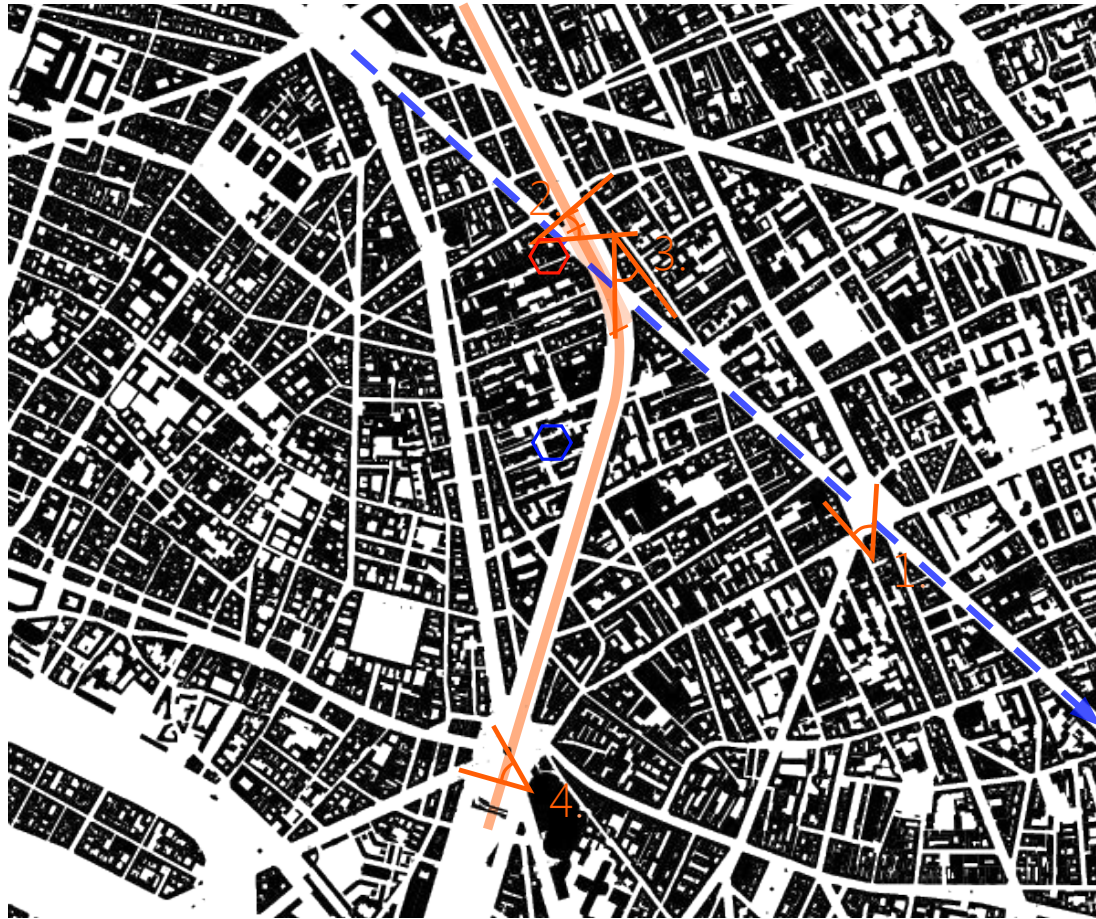

1. Route Charlie Hebdo Rally 11 January 2015

Legend:

- Route Charlie Hebdo Rally 11 January 2015
- Richard-Lenoir Vault (underground Canal)
- Bataclan, terrorist attack site 13 November 2015
- Charlie Hebdo, terrorist attack site 7 January 2015

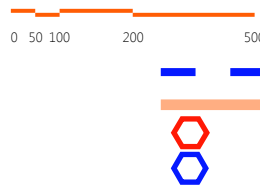

2. Spontaneous memorial at the Boulevard Richard-Lenoir for the 13 November victims

Local political context

Another aspect that played a role in the choice of the location is the local political context. In January 2015, a terrorist attack on the nearby office of satirical magazine Charlie Hebdo sparked massive collective peaceful uproar. A rally of over 2 million people walked from Place de la République to Place de la Nation.



3. A barricade on Boulevards Richard-Lenoir and Voltaire in 1871

November 13 2015, the Bataclan theatre which is located at the researched intersection was struck by another terrorist attack. At the same time 6 locations in Paris were struck by terrorists who randomly shot people killing 130 in total of which 90 died in the Bataclan. The fear of new attacks made the police decide no rally could be held. Since then, the memorials at the Bataclan and the Place the la République became the main places of remembrance for the people.

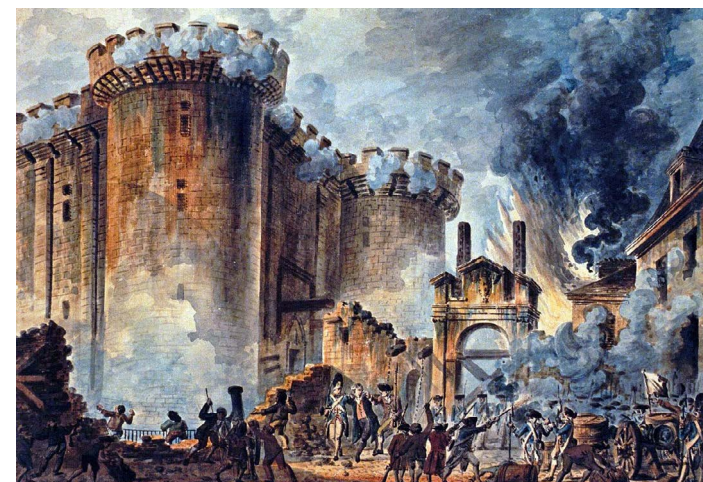

4. The taking of the Bastille which set of the French Revolution

Public outrage and violence was however not new to these streets, a picture taken in 1871 shows a barricade of the French army in front of the recognisable concave facade of the boulevard Richard-Lenoir, a curve that is the result of the round shape of the canal and the Hausmannien wish to make all street facades in one line.

These events happen close to the Place the la Bastille, the place which is commonly regarded as a symbol for the start of the French Revolution.



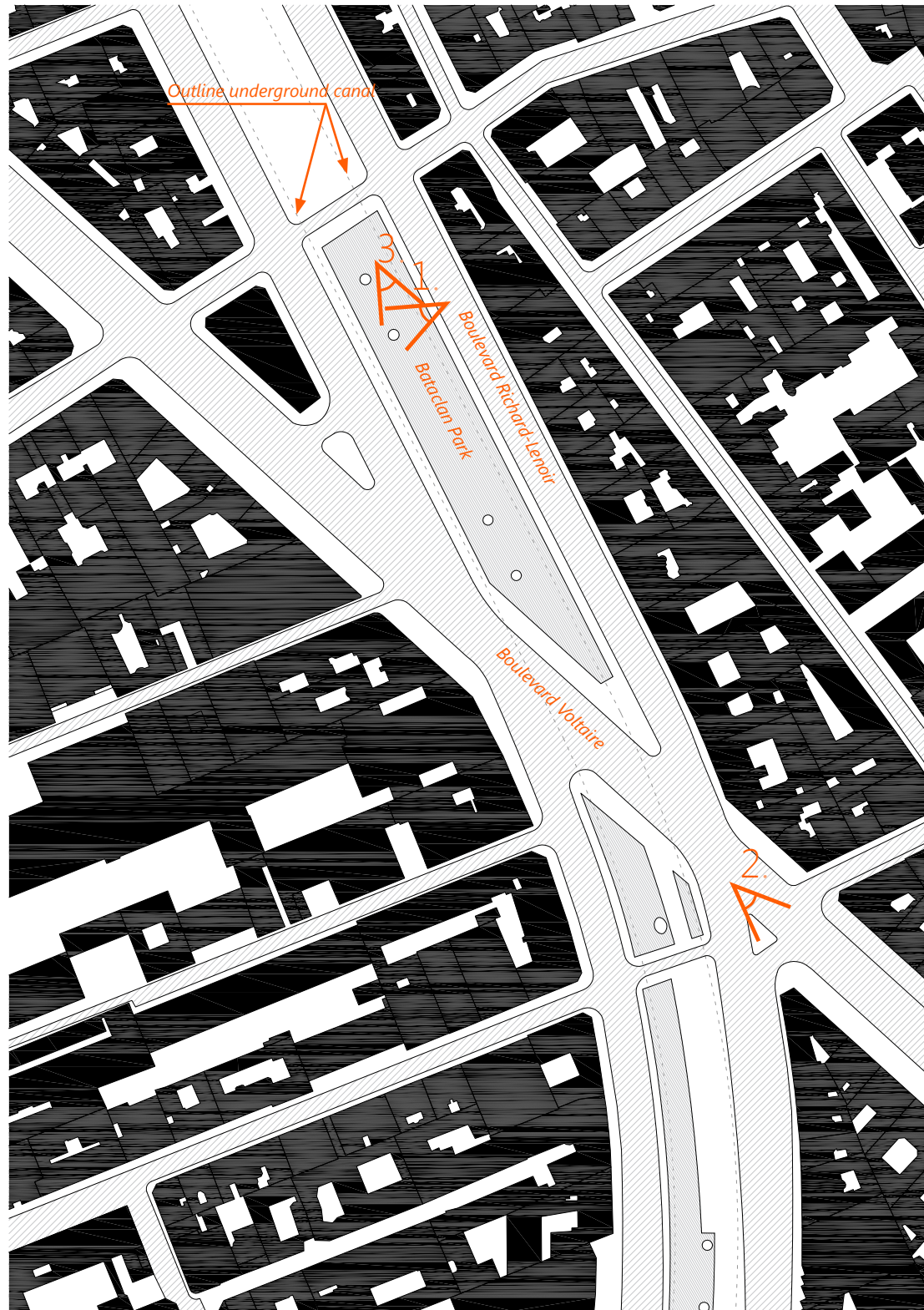

1.



2.



3.

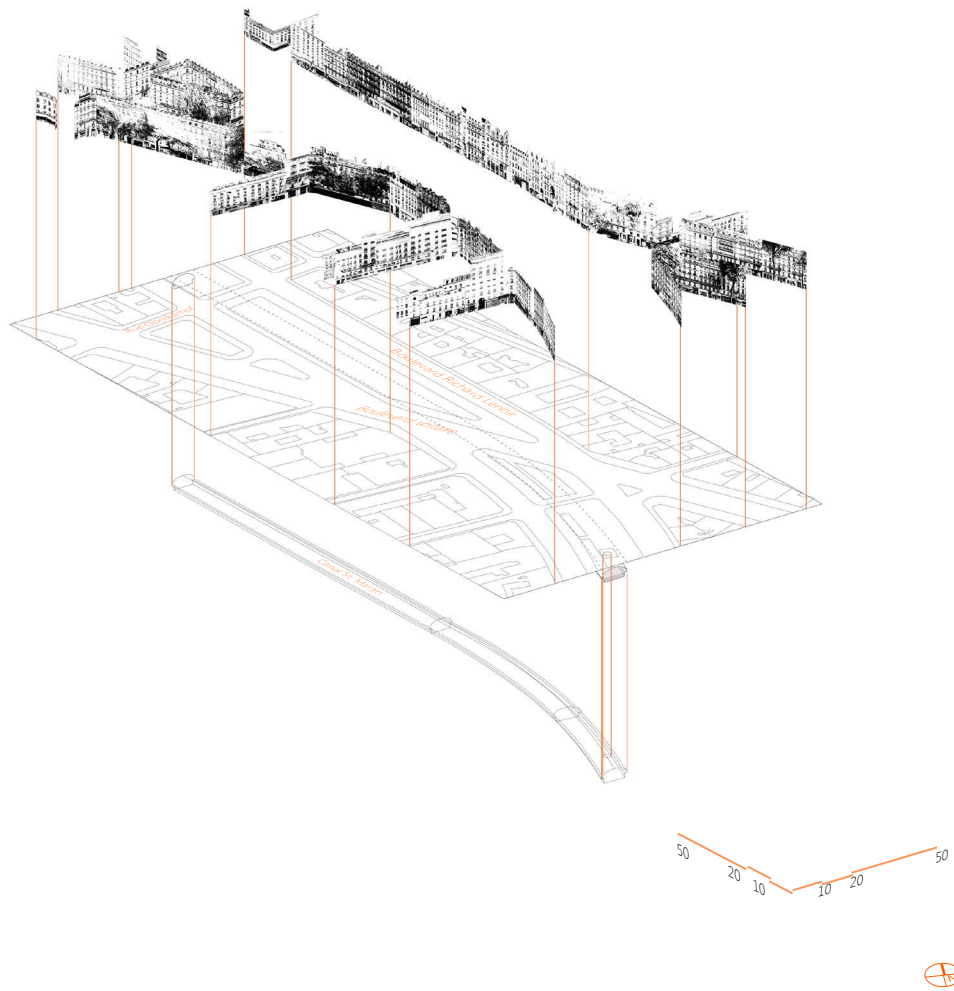

Parcelling map

The area of this analysis is the neighbourhood around the curve in the Canal St.Martin in the northeast of central Paris. The navigable canal lies below street level and is covered with public spaces and roads as can be seen from the parcelling map.

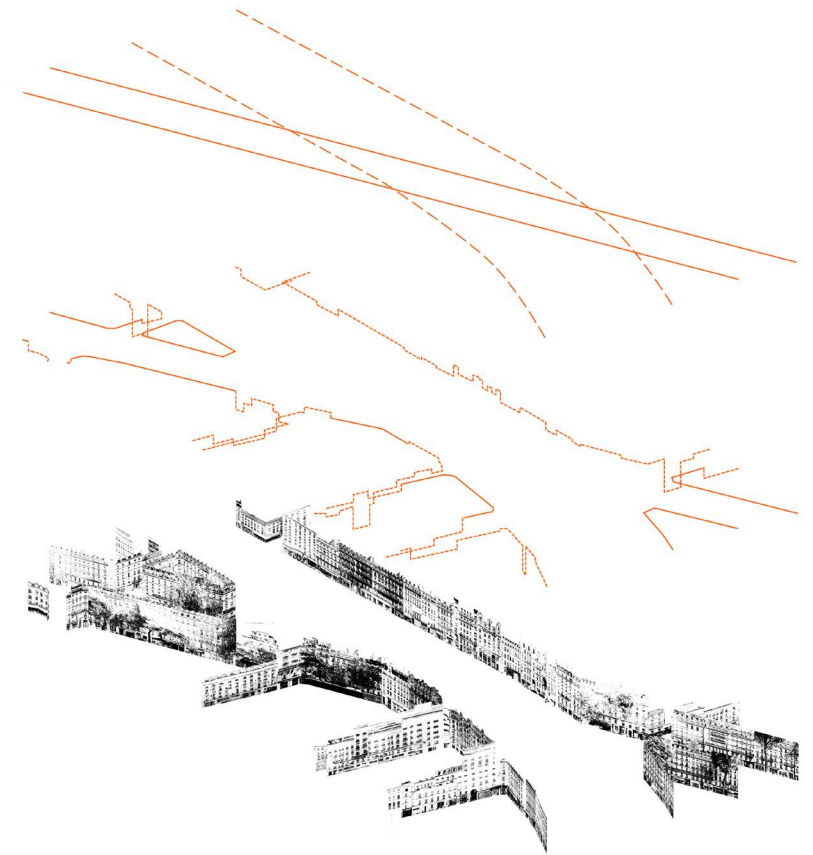

Legend:

- Straight roof lines —————
- Interrupted roof lines - - - - -







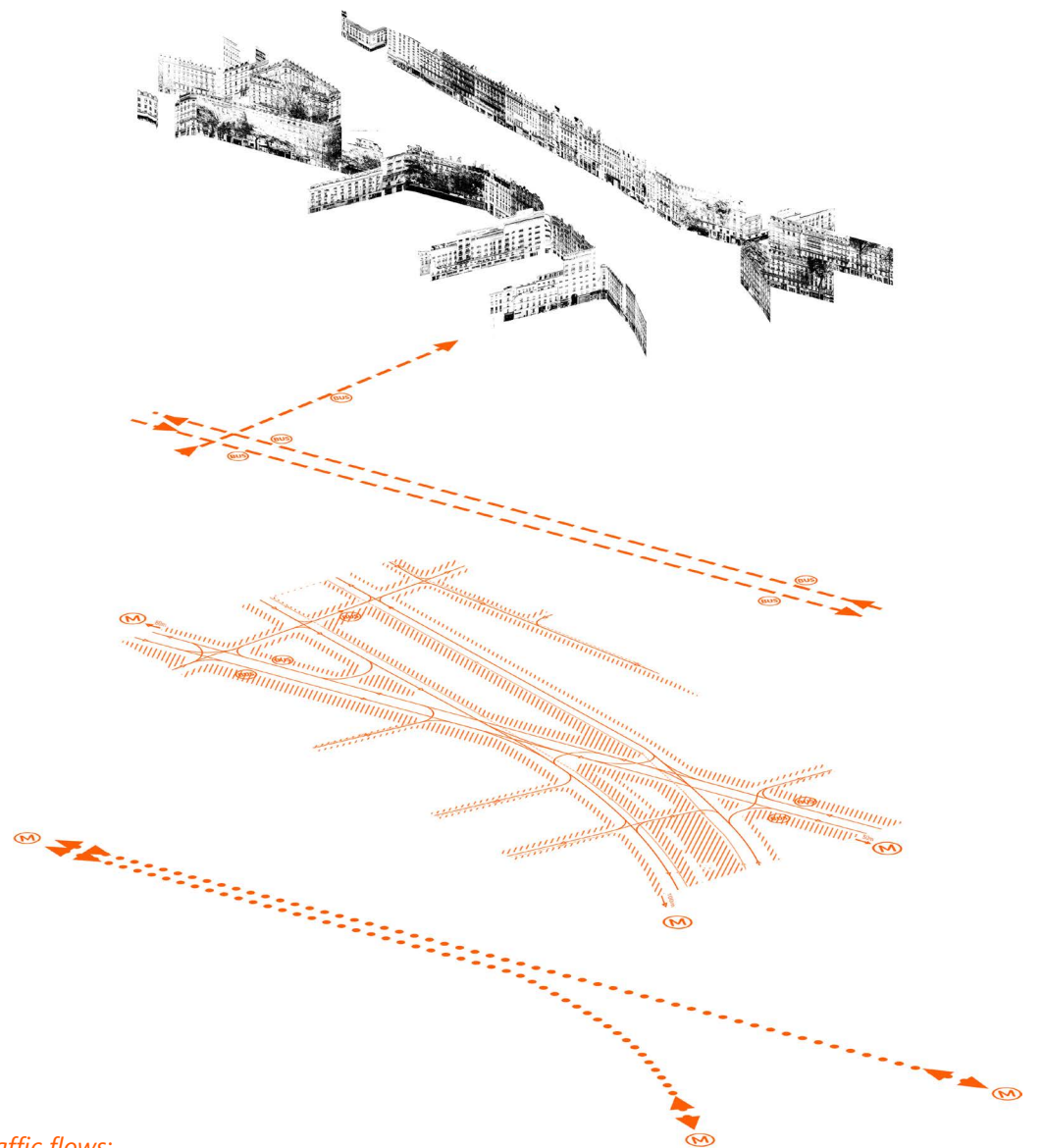

Roofline diagram

Of the three main streets of this section, Boulevard Voltaire is the only one developed under the planning authority of Haussmann. Rue Oberkampf developed in the 18th century as a 'rue faubourg'. Boulevard Richard Lenoir developed before the Haussmann era as well lining the canal that was dug in 1825.

As can be seen from the diagram, the Haussmannian street mainly features straight facade lines while the older streets have interrupted facade lines.



Traffic flows:

- Motorised traffic 
- Separated bicycle lanes 
- Indicated bicycle lanes 
- Pedestrian areas 
- Metropolitan routes 
- Metropolitan stations 
- Bus lines 
- Bus stops 

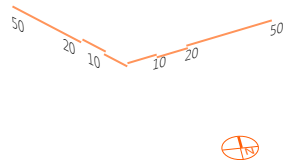

Preliminary conclusion

This location has a few special characteristics that are related to the research question. These are the aspects of memory and the fact is represents a spatial quality that is linked with the history and development of the city of Paris.

Local memory

The memory of the location is continuously developing and changing. From the taking of the Bastille during the French Revolution to the Terrorist attacks of 2015, new collective *milieux de mémoire* have developed. These are places that are linked to, in this case political, events that have taken place in the urban fabric. A milieu de mémoire is a temporal memory which is interior to large groups of people. Because of the temporal nature, the perception of the space and place can change. In the Haussmannien era this location was marked by large industrial constructions, of which the canal is the most important. After that, the wide boulevards witnessed

the Commune war in 1871. Nowadays, it represents the freedom of the Parisian life, this freedom was heavily thwarted by the terrorist attacks that connect these place to yet another memory.

The other part of memory is the physical part. The urban fabric reflects the urbanism motives of Baron d’Haussmann which is marked by strict lines an uniform façades. The façades of the Boulevard Voltaire represent these motives more than the Boulevard Richard-Lenoir, Haussmann was not able to control every single facade. The break with the official motive can be taken up as an interesting aspect of how history has shaped the environment.

The most peculiar aspect of the place is the underground canal. It is barely noticeable from the street but plays a huge role in the shape of the fabric. Making new connections with the canal can provide an interesting new aspect to the public space.

- ▼ Bataclan, October 2015
- Bataclan, December 2015

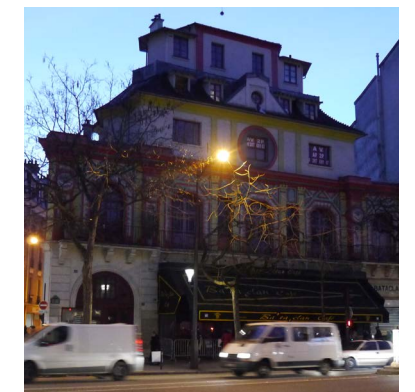

Conclusion

The research question was:

How can an archive be re-interpreted as a political building using architectural principles of order and memory in a contemporary context?

This question can be answered using several points:

Archive as political building

An archive can be political by using a popular demand as the driving force behind the archiving; everyone has the capacity to be a political (archiving) animal. The essay *Arche, Archives, Architecture* shows the connection between the archive and politics. An archive represents a certain cultural and political significance for society, it represents the cultural and political memory. At the same time it is a contradicting building that gathers alien information in a place to relentlessly remember. From the perspective of the archive, a political forum is a place that not only remembers but also involves the public. To be political it should be accessible to be all and used by as much groups of the society. With that given, it is important to keep in mind that the Western multicultural society does not base itself on one truth any more. Different groups manifest themselves in a different way, both online as offline.

This calls for a forum that can connect both digital as physical political manifestations.

What is a political forum?

Before the research, the forum is taken as a place where discussion and debate takes place.

Now, this understanding has been manipulated by the archive. The forum in the shape of an archive or the archive in the disguise of a forum can benefit from the differences and similarities. The differences between the archive and a forum are the focus and the adaptability. By creating the forum as an archive, the archive has to be able to adapt to rapidly changing political circumstances and debates, it also has to be more open and less institutive. Simultaneously, the discussion that takes place at a forum in the shape of online comments, TV reports, debates and lectures can be linked to the knowledge of the archive.

Dissensus and agnostic pluralism

The archive as a forum can play a role in connecting unbridgeable political differences, acting upon dissensus and agonistic pluralism. To enforce the popular motive, it should be conceivable on multiple levels. This means that the architecture should provide a backdrop to different kinds of political man-

ifestations as well as providing archive access that is meaningful to all. The latter should be done by defining the program of the archive in a way it has something to say about everyone. It is interested in attracting multiple groups rather than specific information. From the case studies to archives it is concluded that archiving is supposed to be open to all but it rarely always is. The archive has to recognise that we live in a society in which not everyone is interested in archiving high culture, rather, the archive as a forum should be a podium for entirely different groups, from immigrants to intellectuals. The differences between these groups are now the thriving force behind the archive.

Memory and order

Creating an archive means to create memory, since the building is the reaction to spatial needs, the building can express the sense of memory in its appearance too. The conversation between new and old in an urban context provides the marker for an archive that is also in constant conversation with itself. The Order from the research question is translated in this conversation. The building provides a new ordering of the urban fabric, this shows that the city is an archive of itself that

constantly changes.

After the 13 November attacks on the site, this aspect of memory changed dramatically. The attacks leave their imprint on the site and in the collective memory of the people. The memorial artefacts left at the site are currently being archived in the Archives de Paris but this project can provide programmatic space for these archived memorial. In this way, the archive is not only a place where one can go to take something, people can also put something new there. This idea is inspired on Pierre Nora's *Between Memory and History*. Here he has explained how the western world has replaced human memory by places of memory. By incorporating an archive with an actual happening of the locus, the new forum is rooted in the local fabric as a common memory. Because the happening is recent and actual, it gives the chance to change the perception of the place and grow along with the development of the digital archive of the forum.

Arche, Archives, Architecture

The essay shows the connection between the archive and politics. An archive represents a certain cultural and political significance for society, it represents the cultural and political memory. At the same time it is a contra-

dicting building that gathers alien information in a place to relentlessly remember. From the perspective of the archive, a political forum is a place that not only remembers but also involves the public. To be political it should be accessible to be all and used by as much groups of the society. With that given, it is important to keep in mind that the Western multicultural society does not base itself on one truth any more. Different groups manifest themselves in a different way, both online as offline. This calls for a forum that can connect both digital as physical political manifestations.

Archive analyses

The state of the art in archives is a highly developed and institutional one. Often archives are housed in large government buildings and while access is granted to all members of society, there are strong entrance regimes, of which most are more implicit than explicit. This comes to the forefront at the examples of the Archives de Paris and the Museum of modern literature. Here, it becomes clear that the average person is highly depending on the interest of the archivists and librarians to help them. Another aspect is that the preservation of culture is strongly coloured by the archive, by institutionalising German

literature, it is made implicitly important by the archive, the institutional sign is a metaphorical one. Ai Wei Wei uses this motive to question and manipulate the idea of institutionalisation with the Archeological Archives. What happens if the archive is not unbiased? What happens when I start to use archival artifacts to make art? And because he calls it an archive, at once the figure or shape that he uses, that of a house, is given a new meaning. Is it a house with artifacts or are all houses housing artifacts?

To make an archive more accessible and plural, it should be open to the public in more ways and with better options of consultation. the National Library of the Netherlands tries to attract more people to their archives and library by working together with other government institutions in making exhibitions. In the future they want to expand these operations perhaps by adding a theatre podium to the library. Digital changes for the future include a better online portal.

Architectural Design

Concepts

From the research it has been concluded that The archive as a forum needs to be an institution in the city that at the same time stand open for all people of society.

Duality and conflict

In the research a constant paradox and contradiction of the archive and of memory comes to the foreground. Contemporary political thinkers like Jacques Ranciere and Chantal Mouffe describe politics as a conflictual relationship. We are no longer looking for one ideal way of politics but rather for a way to unite multiple groups in society. This dual sense of connection is shown in the use and perception of the building, it can change over time while remaining the same. The archive is at the same time institutional and collective. The reflection of this in the design is that all buildings stand in a strict grid separately which seems like they provide rules for themselves. However, at the same time the perception and placement of the buildings is closely linked to the surrounding.

Memory

Memory plays a dual role in the design. It provides a way to connect and explain the design from the perspective of the urban context and the

social or political context. The first is done by showing and emphasising the history of the locus, the underground canal is accepted to give shape to the environment and the buildings. The second is done by incorporating the local memory of the Bataclan attacks on the one hand and the large political on-line memory on the other hand into the program. Because the perception of such a Bataclan archive will change over time, it can show the changing perception of history.

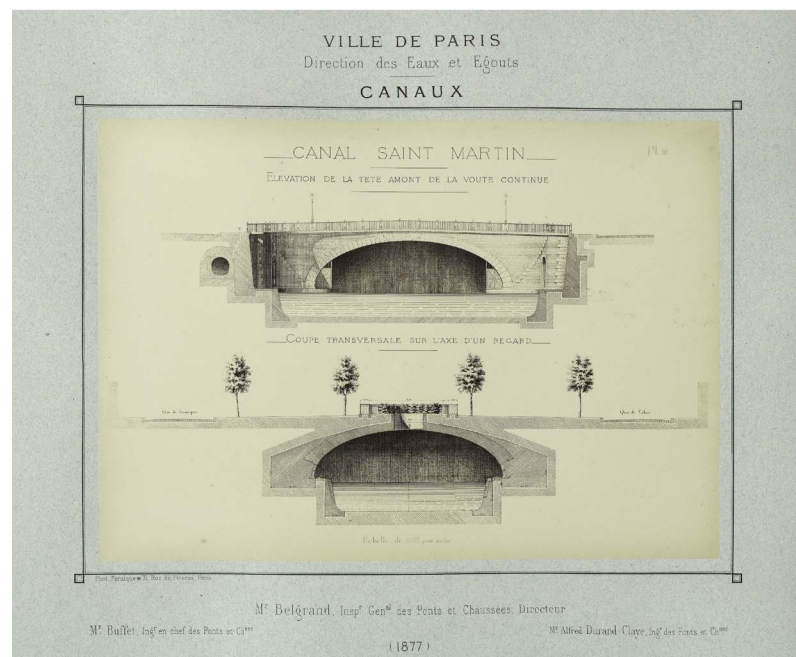

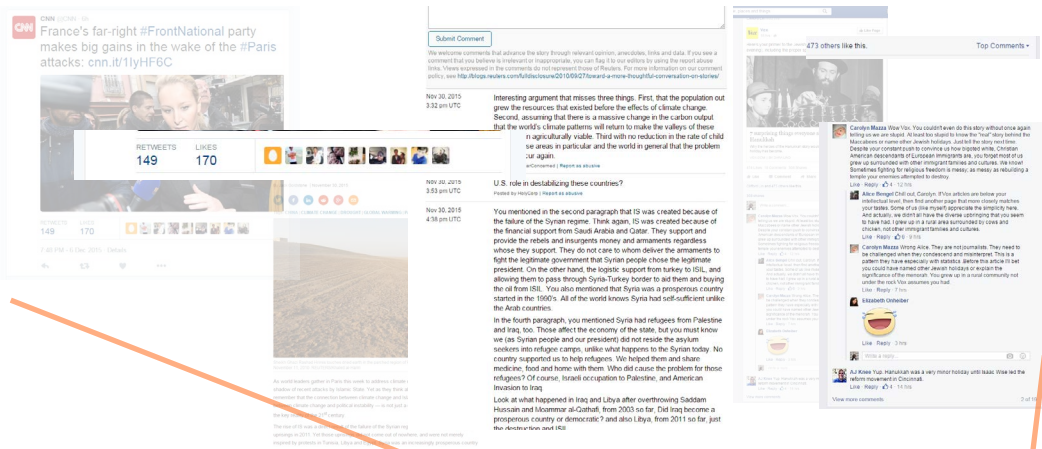

Lecture hall

Bataclan archive

Digital Political Archive

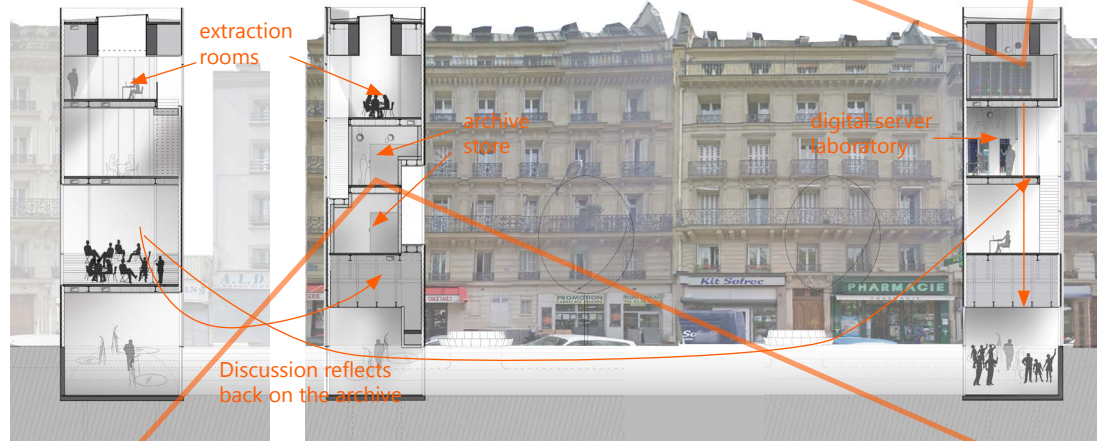

Attentats du 13 novembre : le mémorial du Bataclan aux Archives de Paris

Le Monde.fr | 14.12.2015 à 08h42 • Mis à jour le 14.12.2015 à 09h57 | Par Lucie Soullier

Abonnez vous à partir de 1 € Réseaux Classer Partager Twitter



1/13
Devant le Bataclan, jeudi 10 décembre, les équipes de la propreté et des archives de Paris trient et collectent les hommages déposés par les anonymes.
NICOLAS KRIEF POUR "LE MONDE"

Program

To make the archive a political forum it requires a sharply defined program. The conversation with Jan Bos and the case studies have shown that the use of the archive depends heavily on it. Therefore the program of this project is as follows:

The digital political archive

One part of the archive complex is a digital political archive. This archive collects and conserves digital political messages and meta data. It harvests political shares from social media like Facebook or Twitter along with the meta data attached to it. How many likes does a certain article have? Is there a positive or negative response? By doing this, the inaccessible or locked data is given free for everyone interested. This means that no longer companies with an extensive infrastructure have prior access to broad social network trends. The example of Internet Archive has shown that in the current time, a digital archive is a laboratory of itself, therefore, a laboratory space is included in this building.

Bataclan Archives

The terrorist attacks that the site witnessed represent a strong but temporal memory on the site. Archive space is provided to conserve and place personal memorial signs.

Lecture and meeting hall

The lecture hall is programmed to provide space in which lectures, conferences and meetings can be held. This connects the digital archive with the physical space by providing places for discussion about the archive. This aspect of discussion links the lecture hall with the extraction space of the digital archive. Because it has been established that archiving and extracting is a specialist job, discussion and conversation is needed by everyone who wants to consult the archive. Using the archive can be connected to a specific lecture or exhibition in the lecture hall; this on its turn reflects back on the use of the archive. In this way a public conversation adds authority and plurality to the archive.

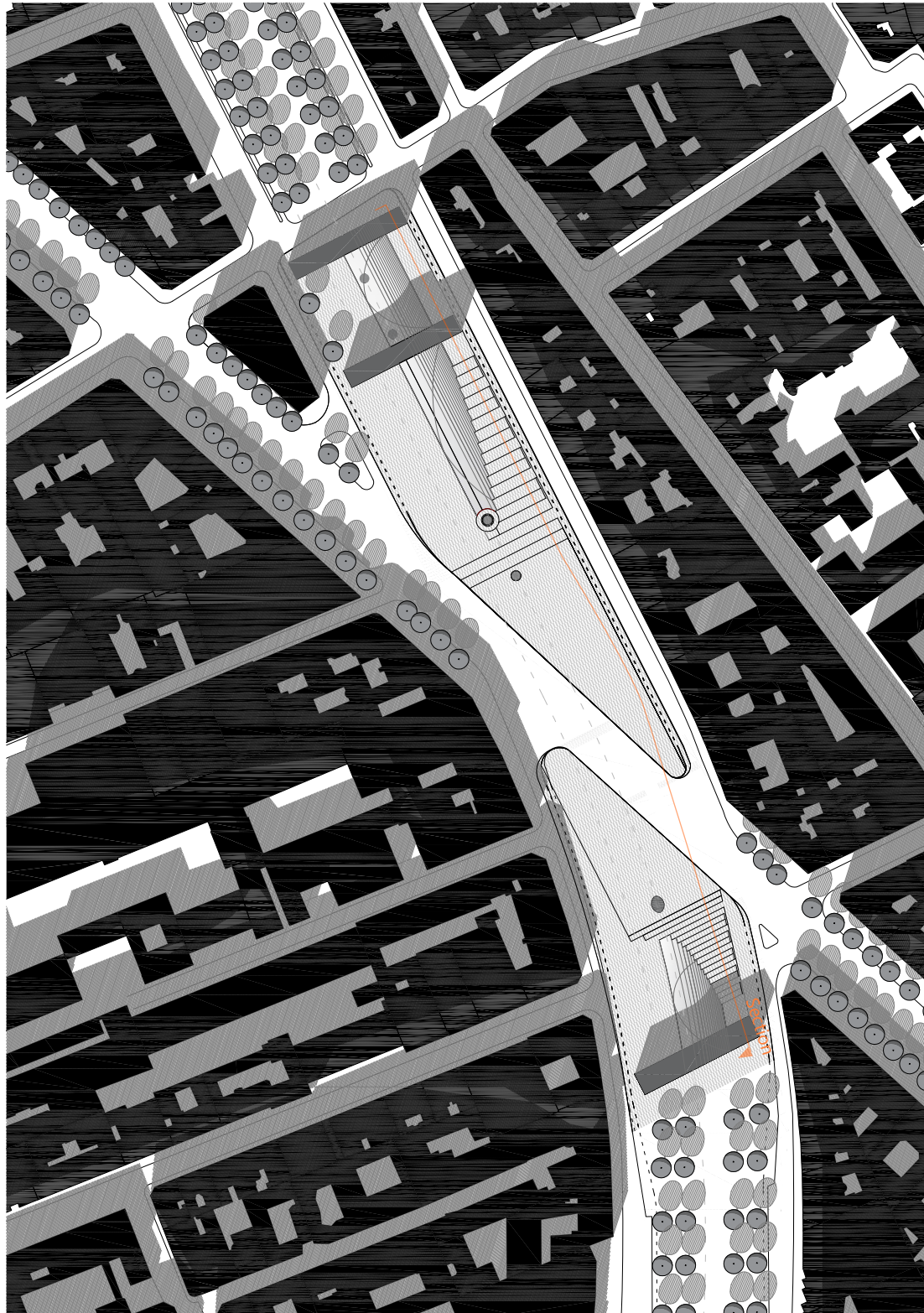

Urban embedding

The urban design is marked by three distinct volumes that stand in one orientation in the urban grid. By doing this, it automatically creates a conversation with the surroundings. The new shapes create new public space.

The accessibility of this public institution is exemplified in the

separation of the different buildings as well. The strong monumental statement of the three volumes is one for the public, it gives the opportunity, it gives the possibility to be recognised in the city while remaining conceivable; you still walk around it and experience what happens inside.



▼ The urban plan, scale 1:2000

▲ The plan creates new public space



Publicly accessible

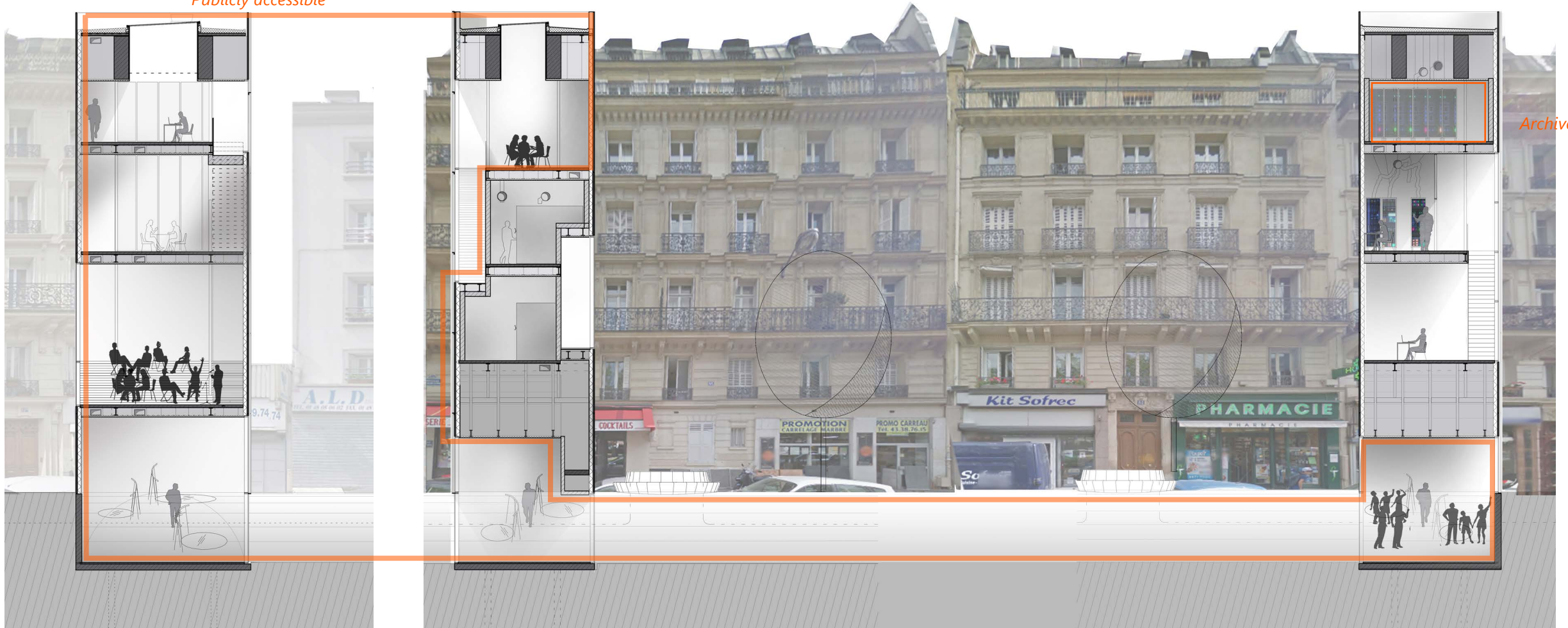

Archive

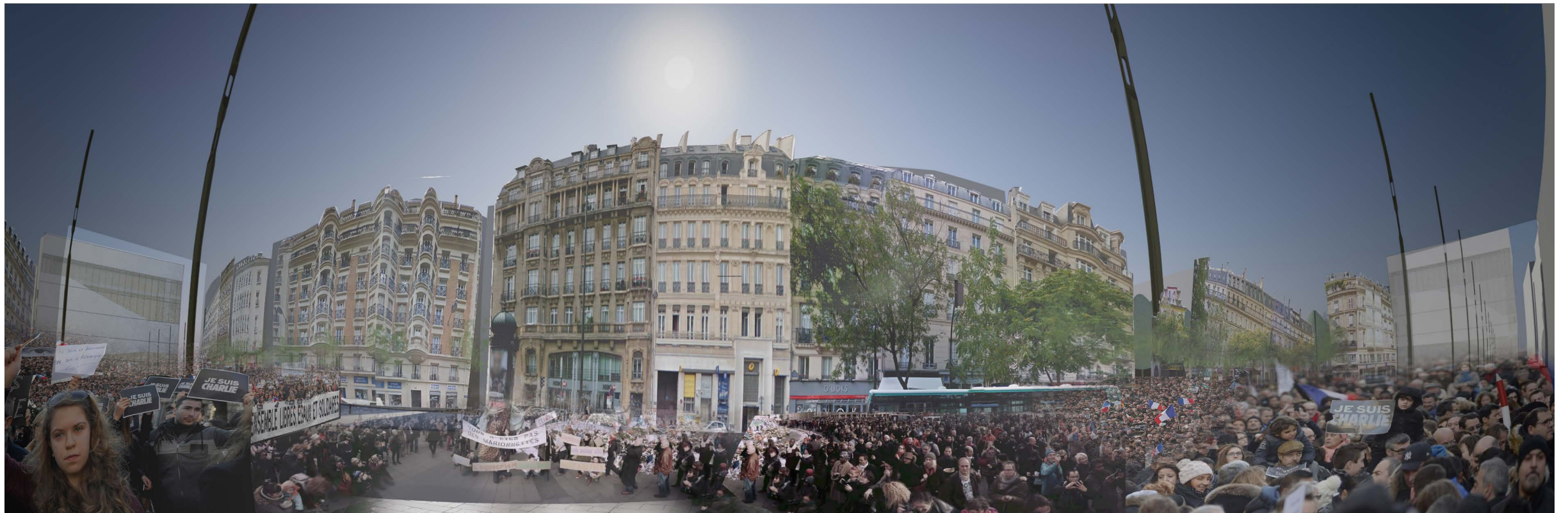
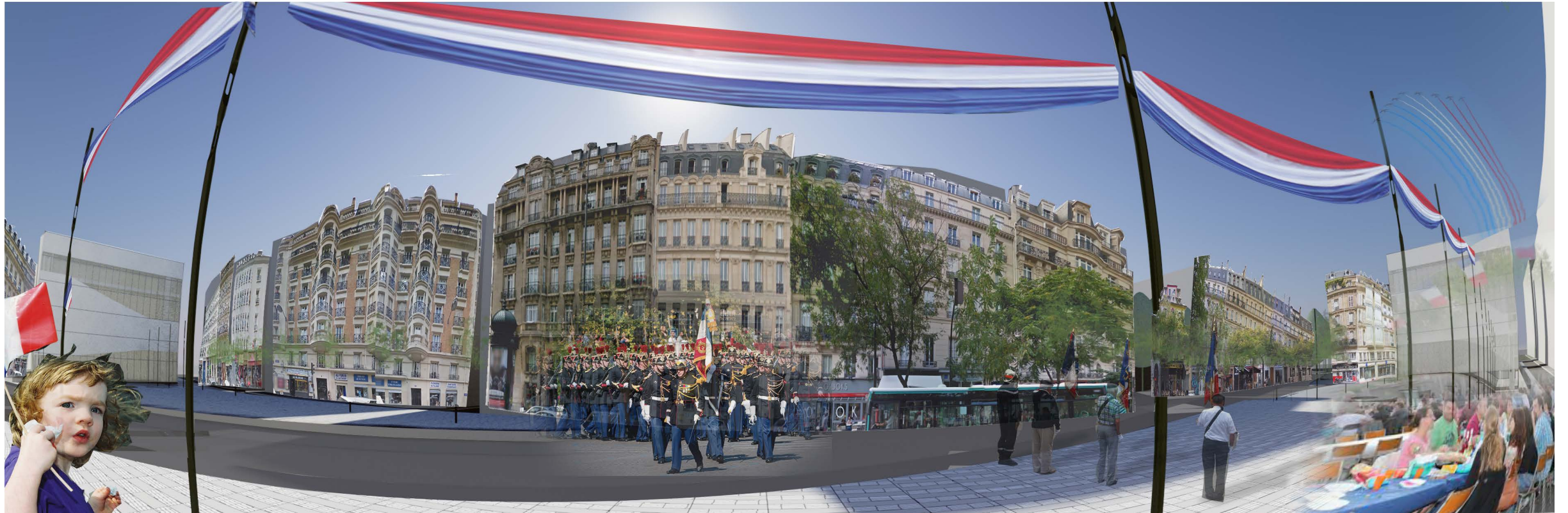

Typology

The idea of creating monumental hard slabs of building in the urban context and the wish to show the internal working, the typology is an expression of both. The building volumes all have three closed sides and one open side. All sides show the rough shapes of the internal program.

The recognisable shape of the building ensemble attributes to the appearance of the plan in the city.

Legend:

Closed facade ————
Open facade

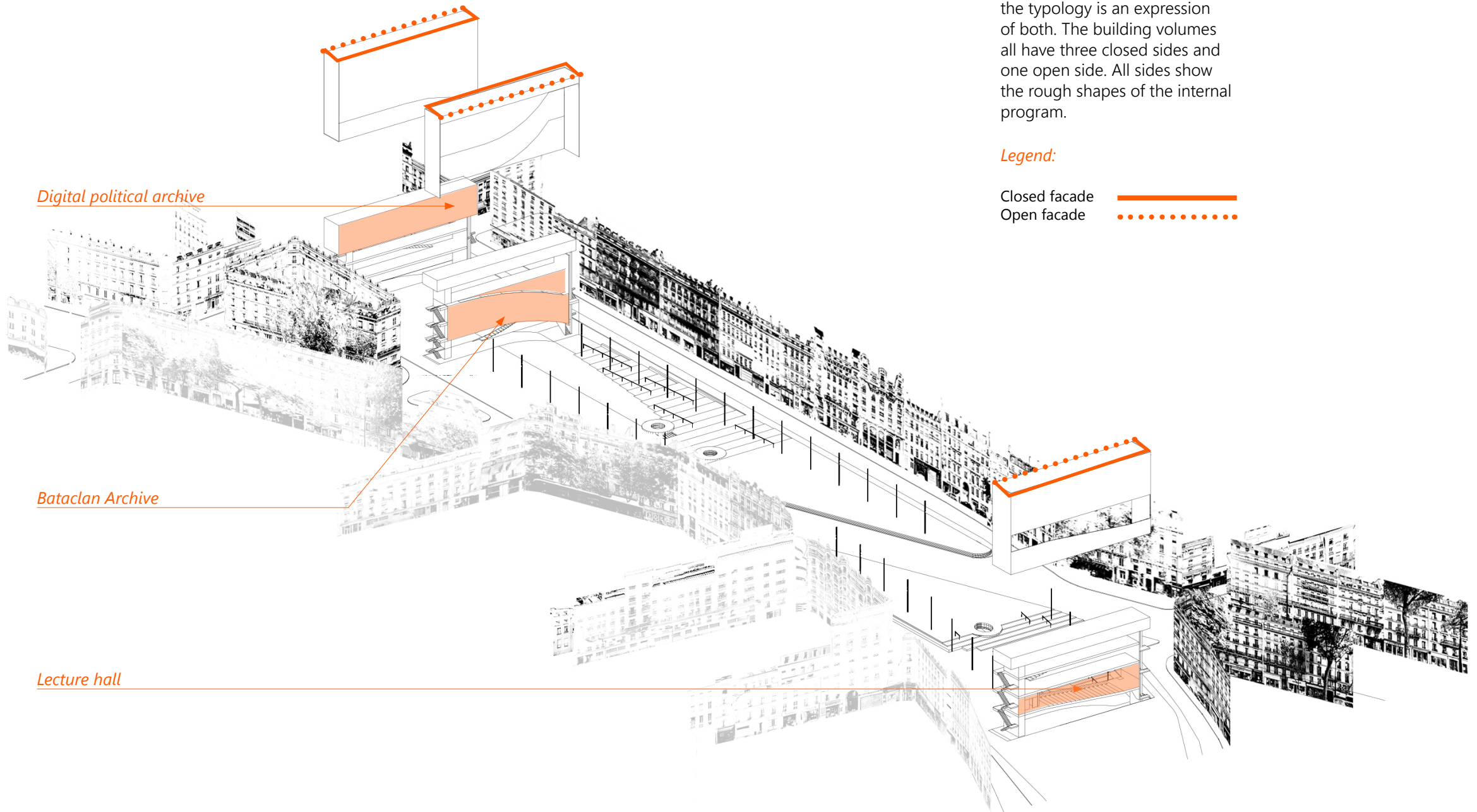



Digital political archive

Bataclan Archive

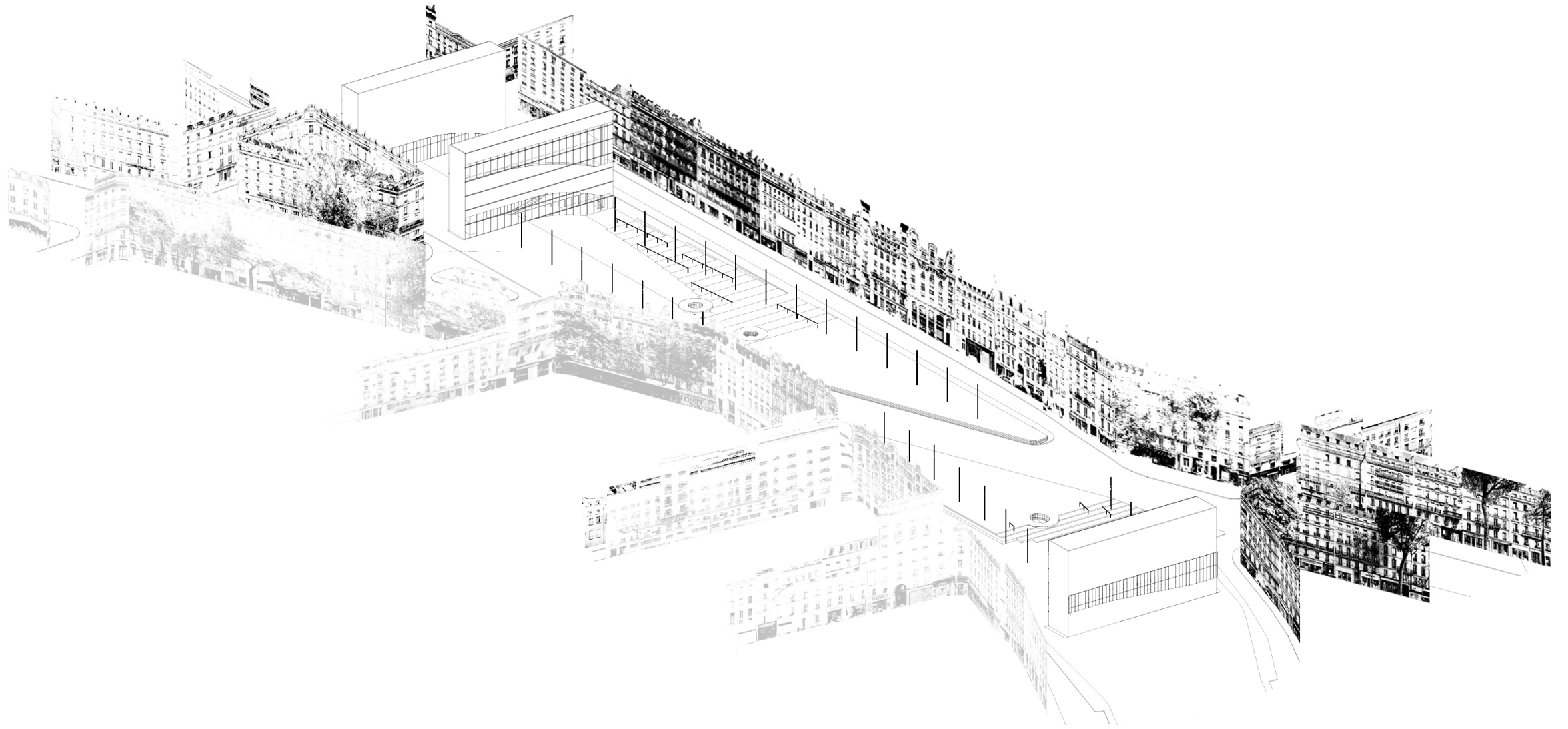
Lecture hall

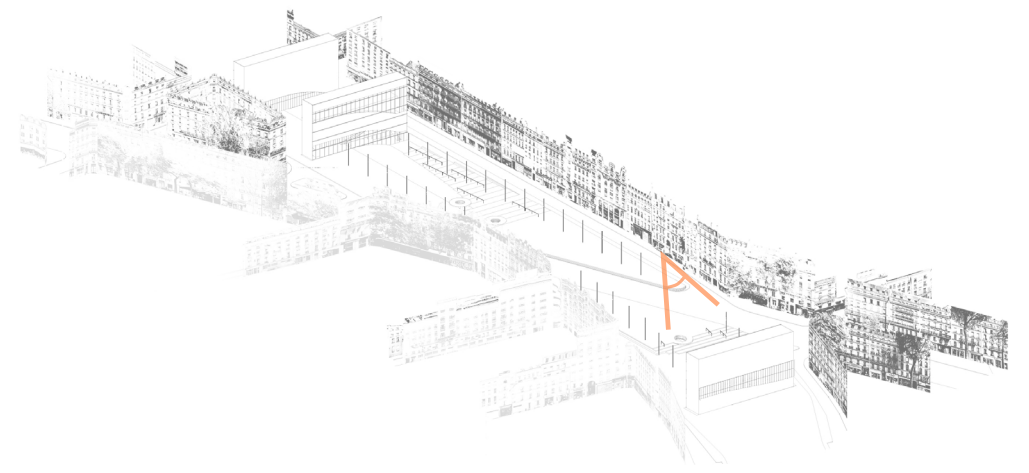
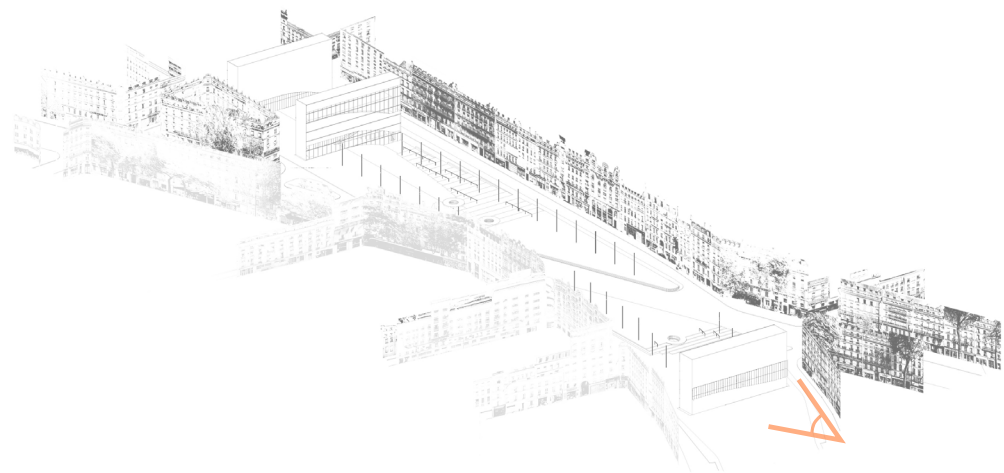
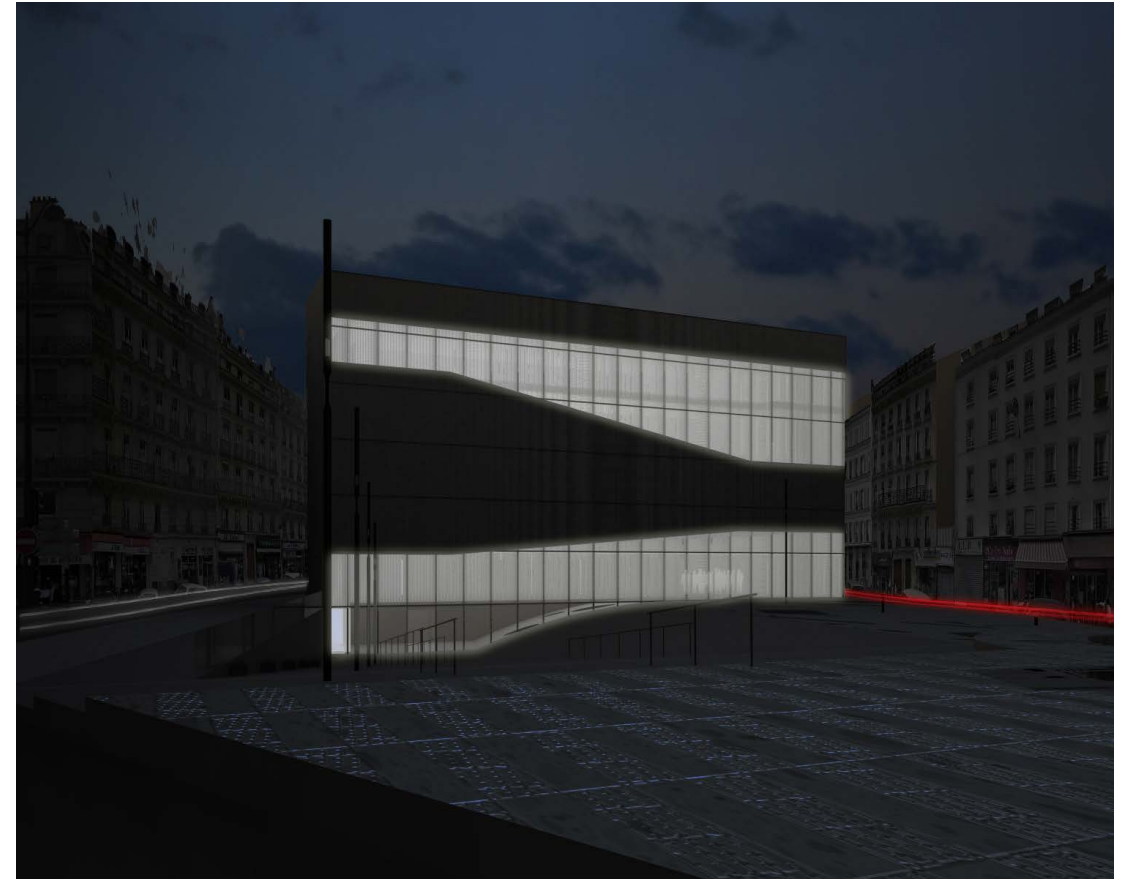
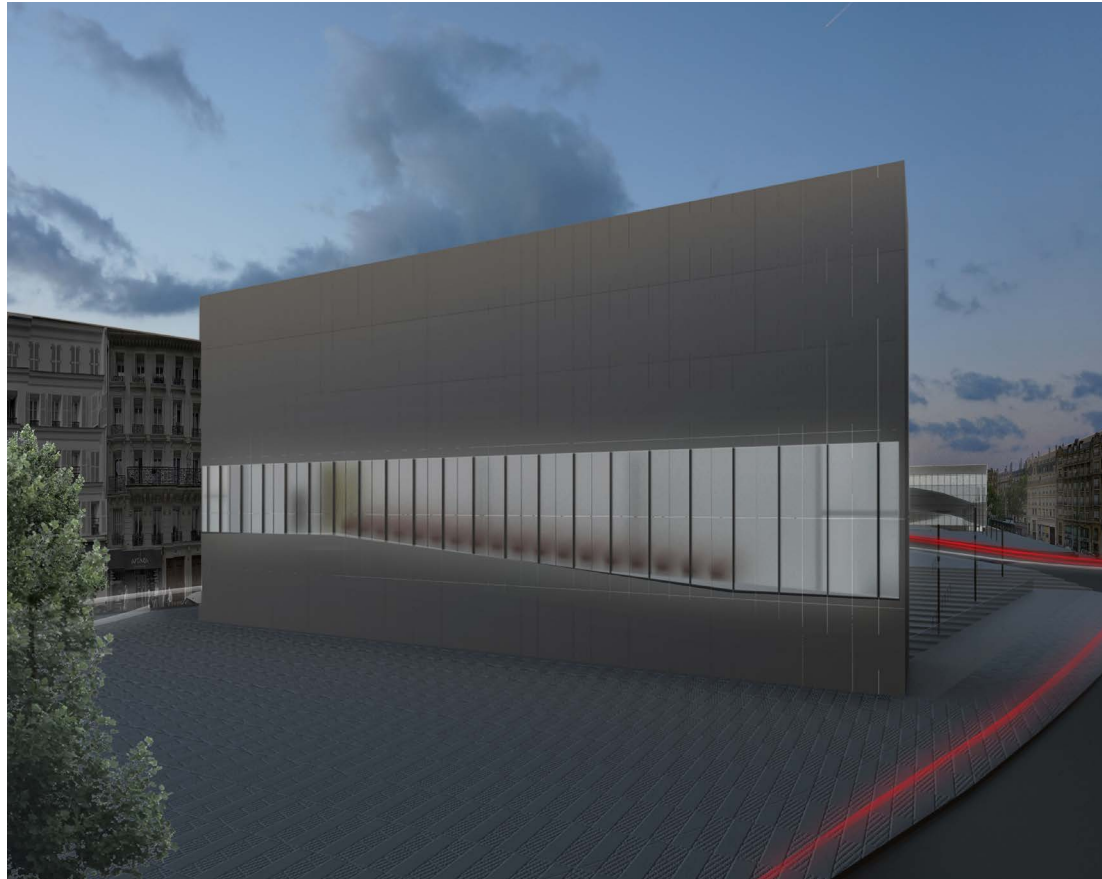



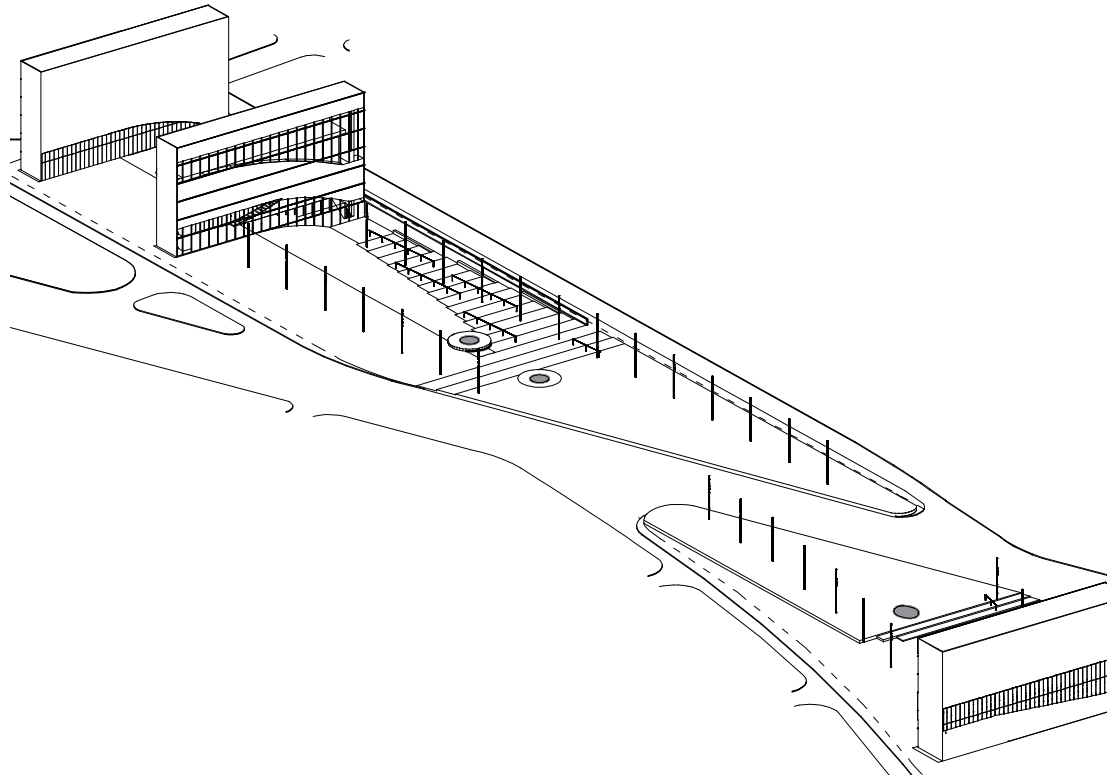

Public space

The shape of the public space is a result of a partial excavation of the underground canal. The round shape of the top of the tunnel provides a slope that leads down to the entrances of the buildings.

The shape of the canal conflicts with the direction of the plan. All three buildings have the exact same orientation while the canal changes direction underneath the plan. The concepts of memory and conflict are visible in this treatment of the canal.

The stairways leading down to the building entrances are made long so the entire square is involved in the 'excavation'. Where the stairways reach the streetlevel they go up three more steps to create a raised podium which is bisected by the Boulevard Voltaire.

The raised podium functions as a large seating element but can transform in a podium for demonstrations or large gatherings when the square is busily used.

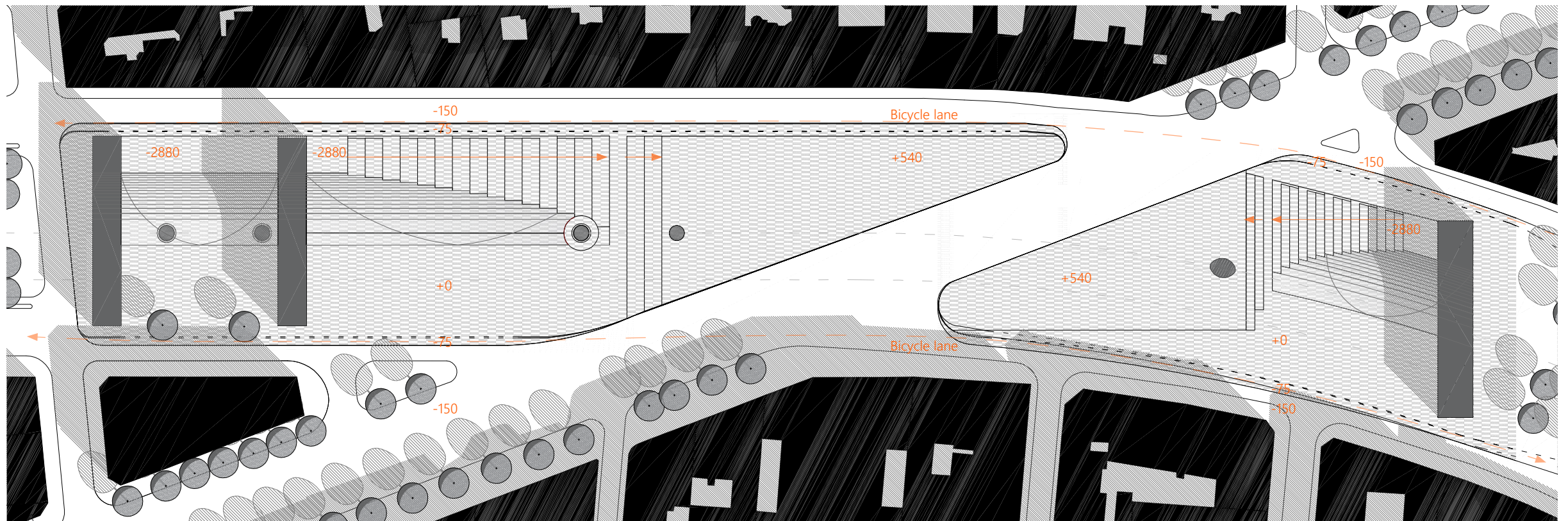

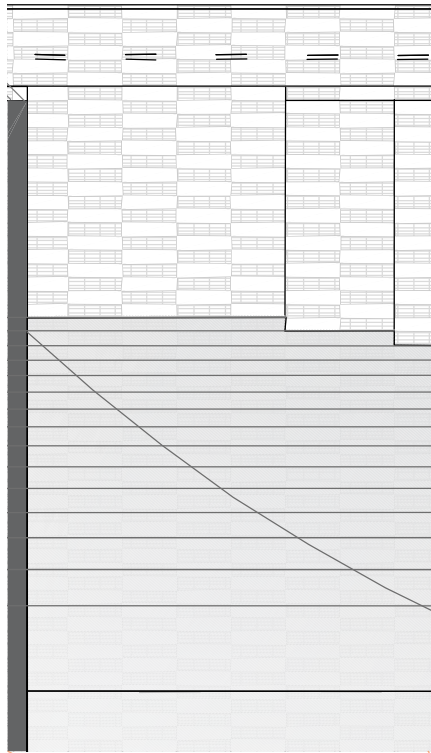

▼ The urban plan, scale 1:1000

◀ Cut-outs of the urban plan

▲ Cut-out of an impression showing the pavement surface

Pavement surface

The surface of the squares is paved with the same material as the closed facades, light terrazzo with grey aggregate.

The surface is made up of tiles of 450*1800mm. The tiles have been given a pattern that

is milled in the material. The pattern follows the lines of the existing urban fabric while the orientation of the tiles strictly follows the building grid. To emphasise the difference in direction, the milling is applied to half of the tiles in a checker-board pattern.

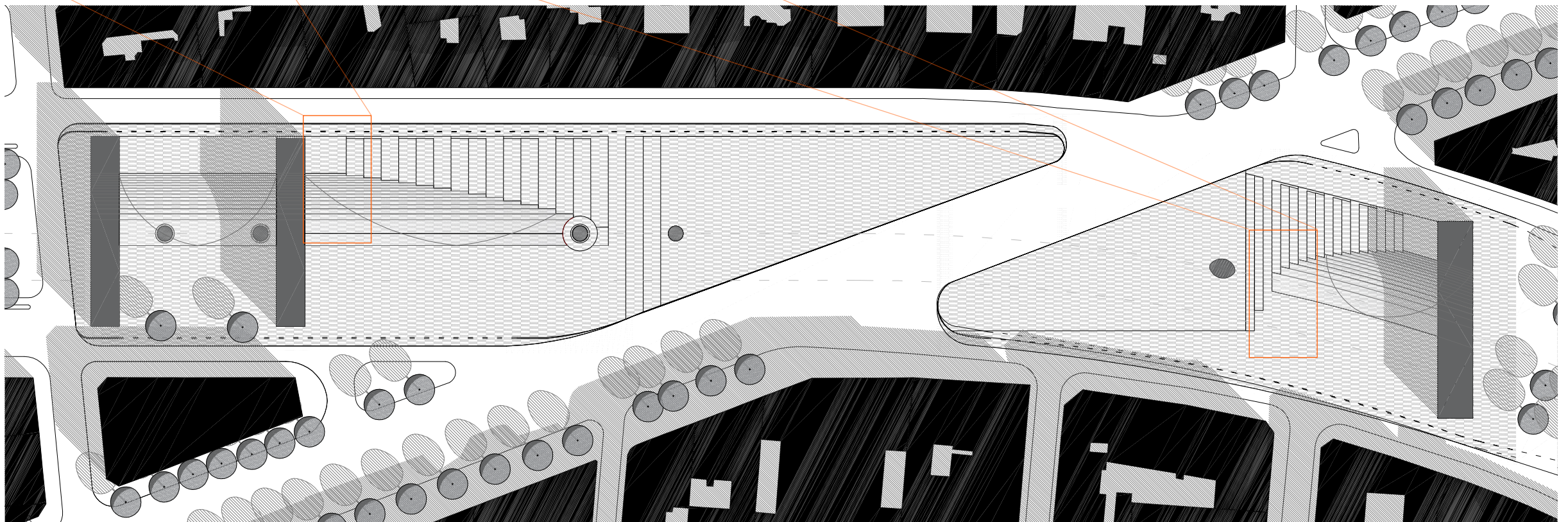
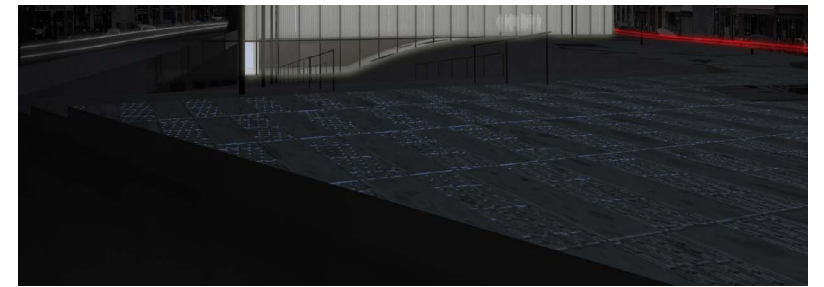

Lecture hall

This building houses a lecture hall and meeting spaces. These functions are created with the extraction room of the digital archive.

about what questions they want to have answered concerning online politics.

Since the extraction room of this archive is a consultation space, it consists of multiple smaller rooms where the public can meet and discuss with archivists



Section AA' 1:200

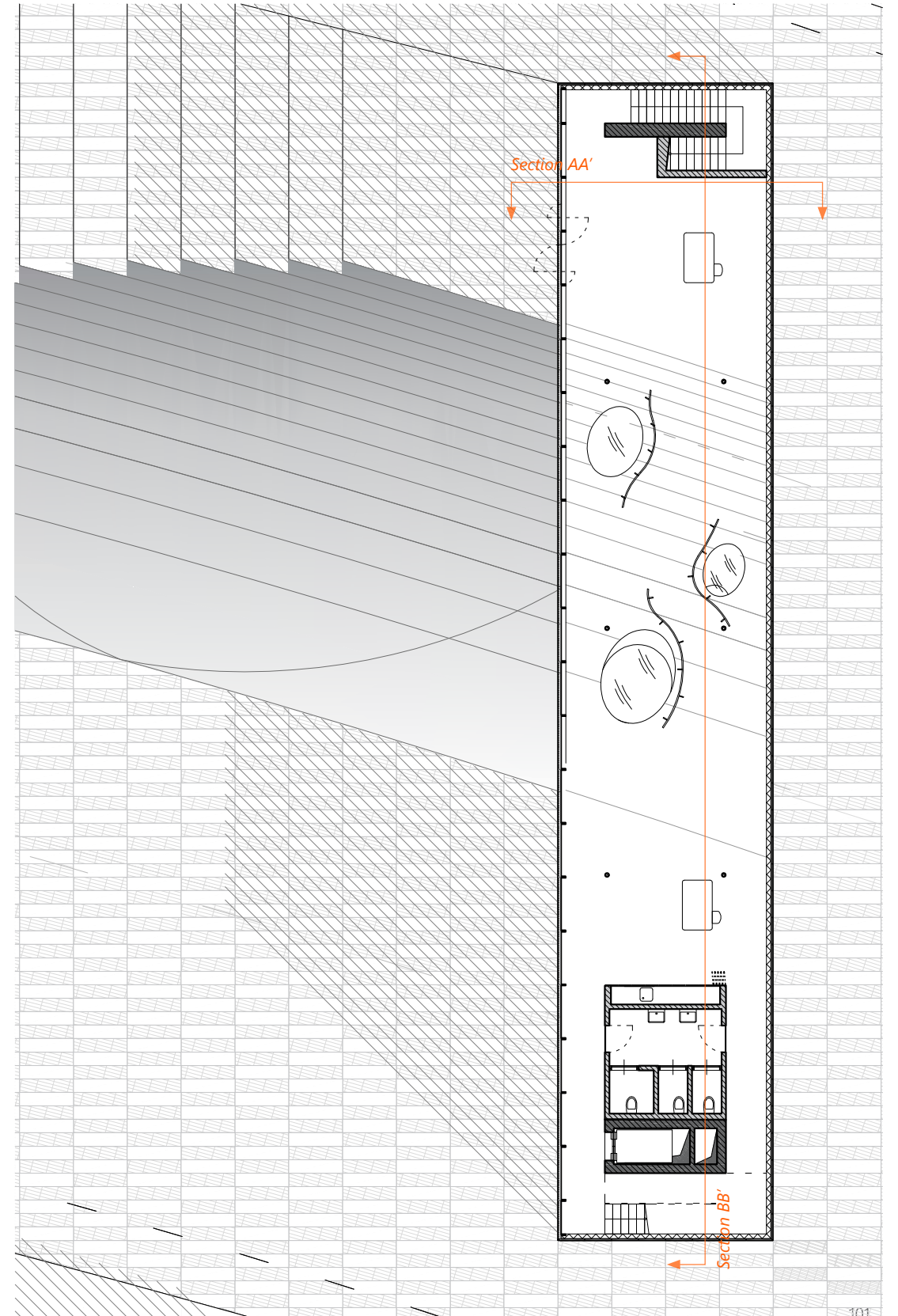

Street level 1:200

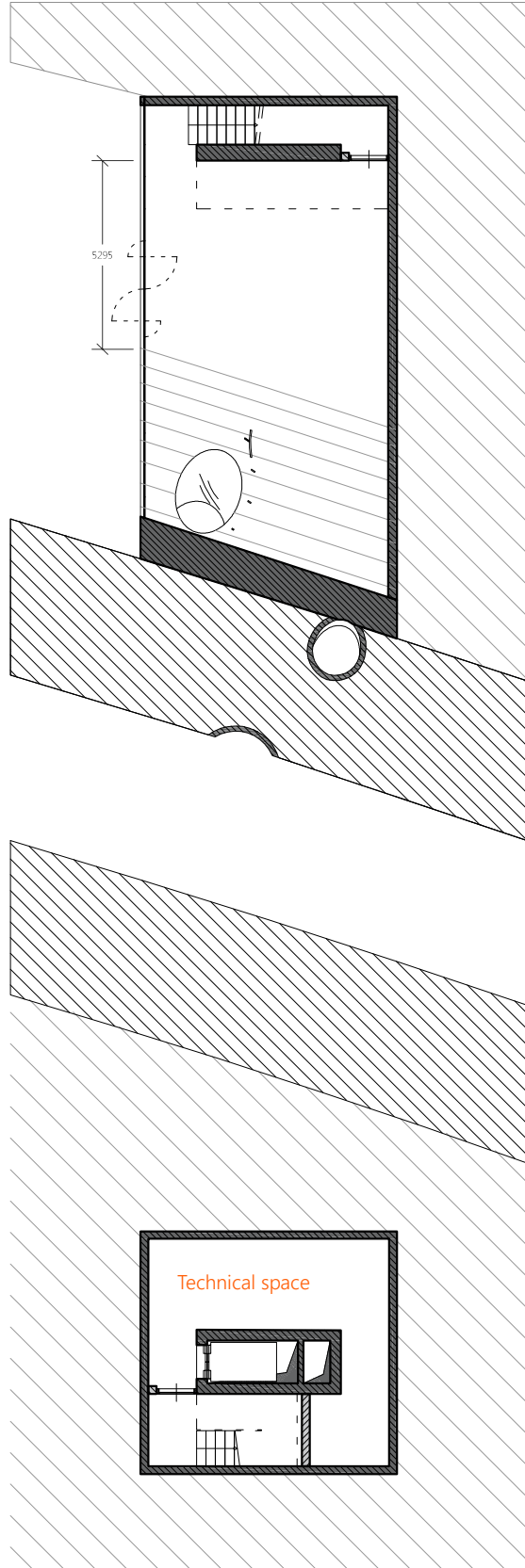

Level -1 (entrance level) 1:200

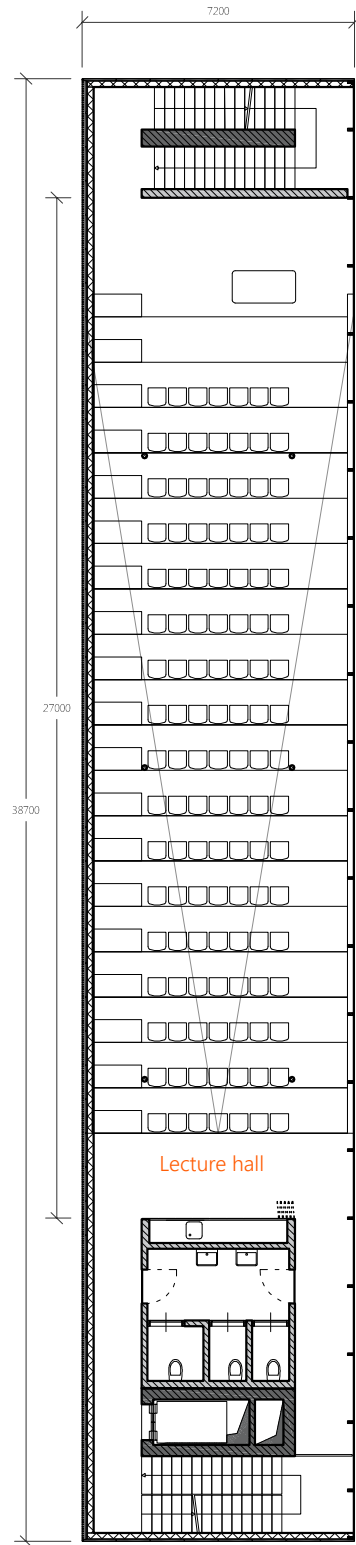

Level 1 1:200

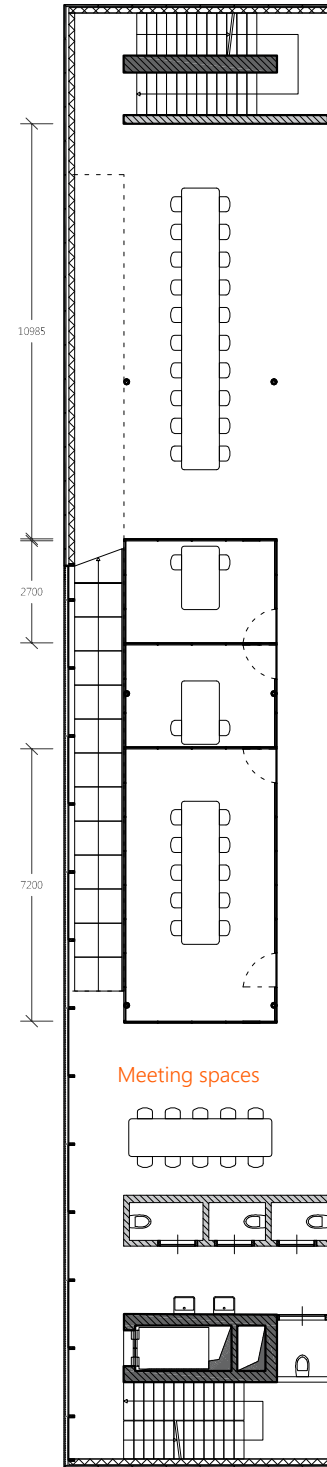

Level 2 1:200

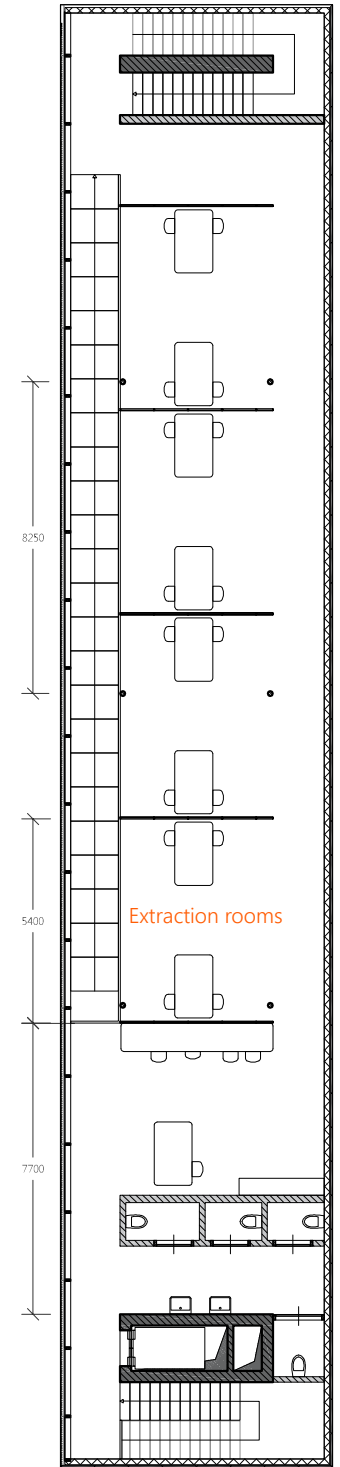

Level 3 1:200

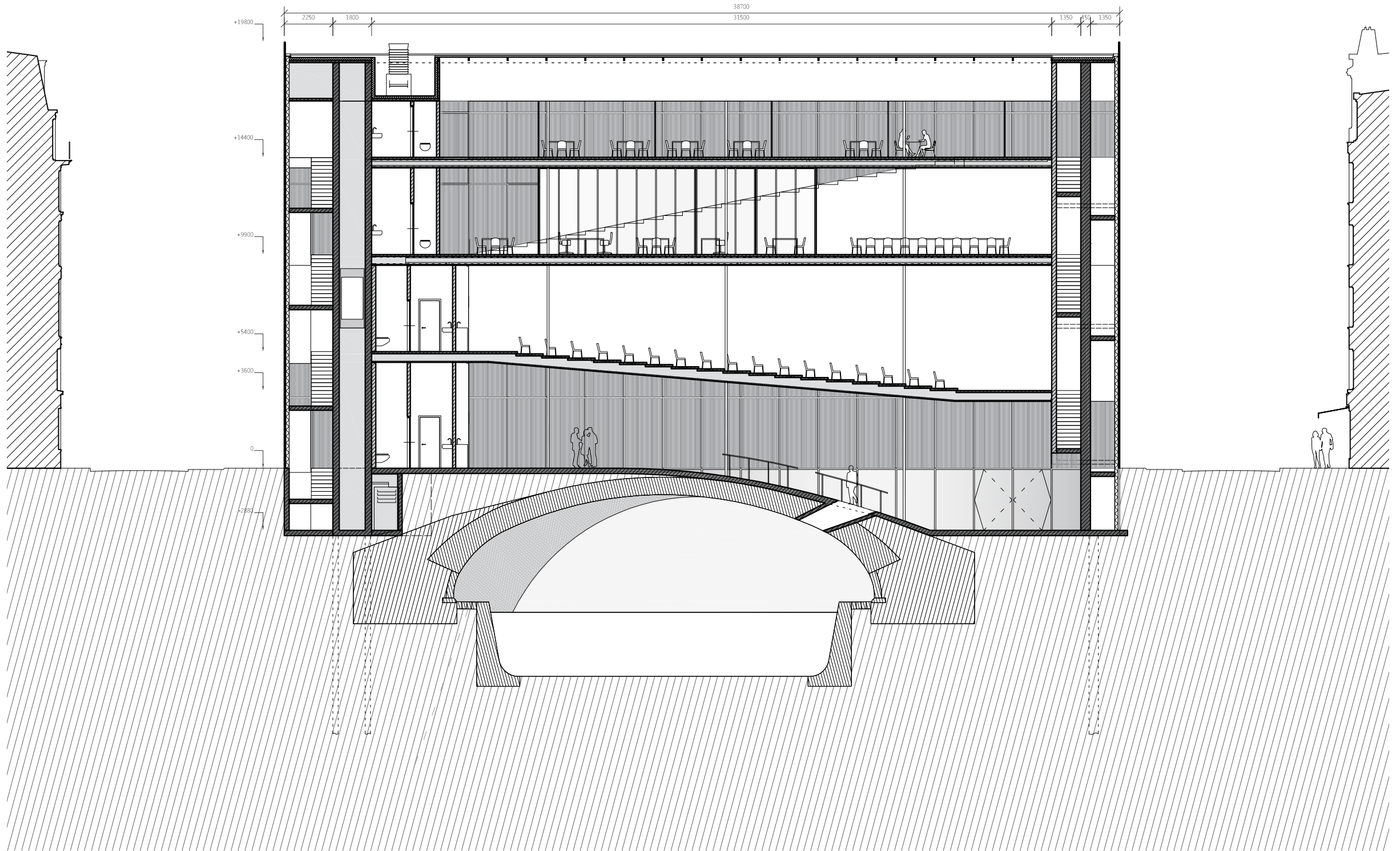

Bataclan Archive

The Bataclan archive is an archive where people can go to extract and to archive, materials left here will be archived at the same site. The extraction room is located on the highest floor and is reached by two curved stairways that are a reaction to the shape of the canal.

facade, a different motive than the facade of the other two buildings, that is done to show distinction between the functions.

The rounded shapes define the

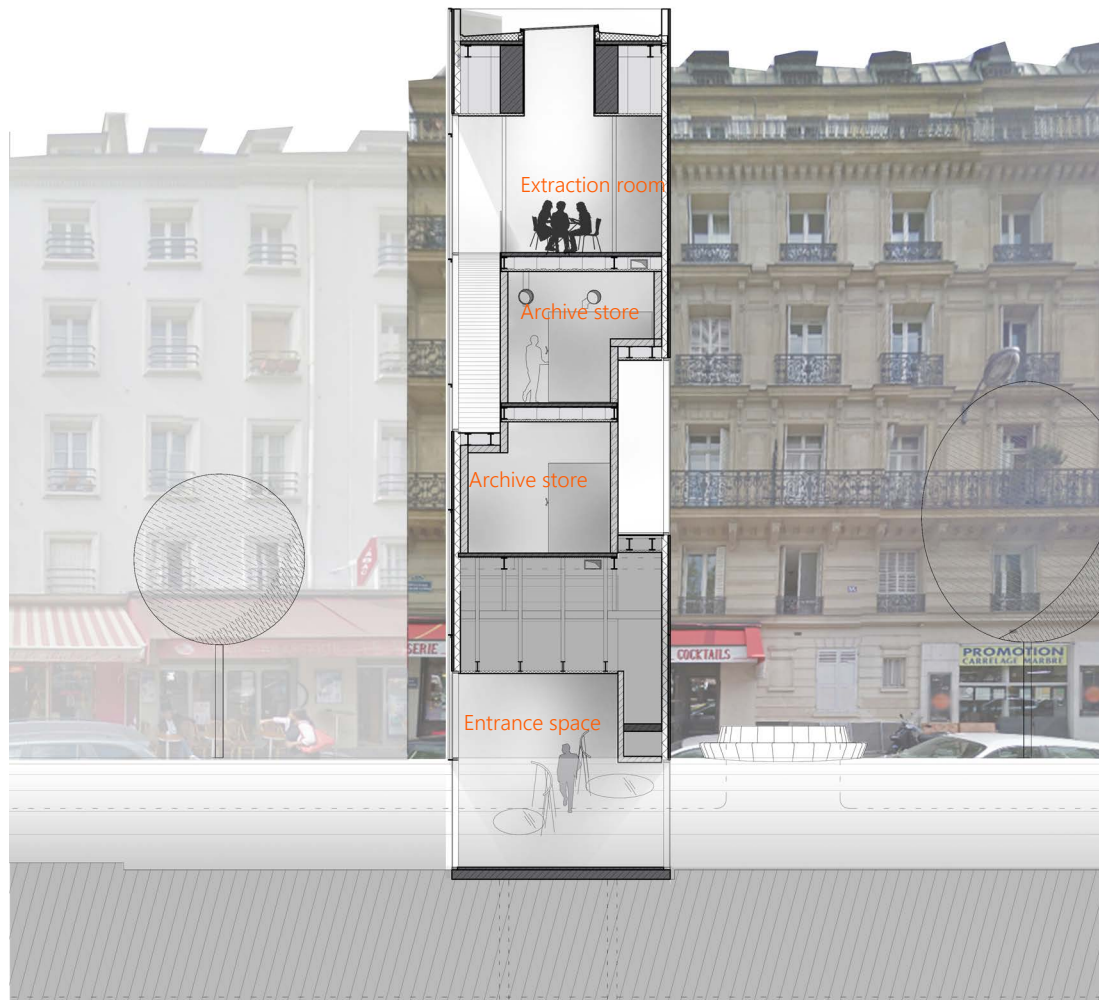

Section AA' 1:200

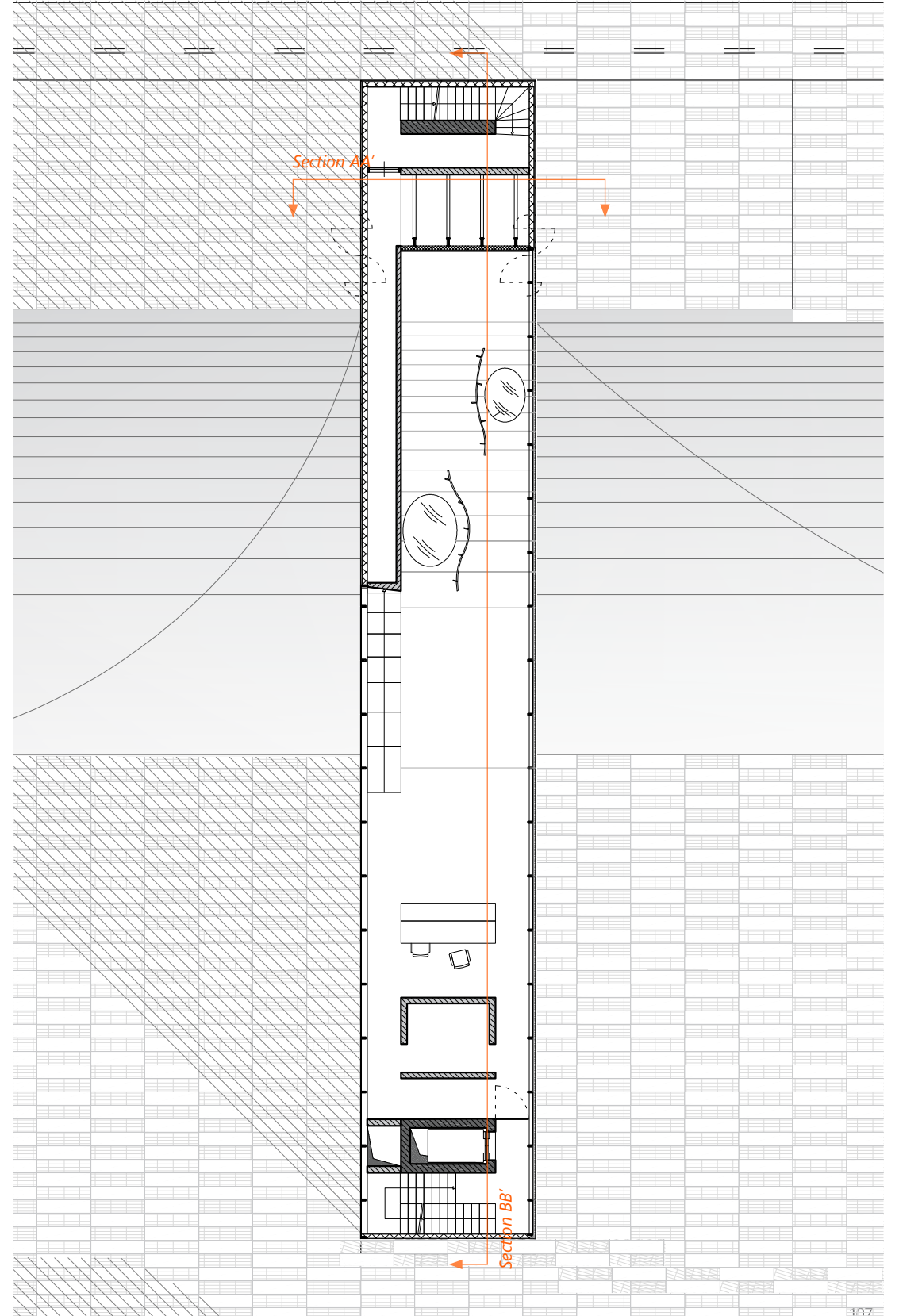

Street level 1:200

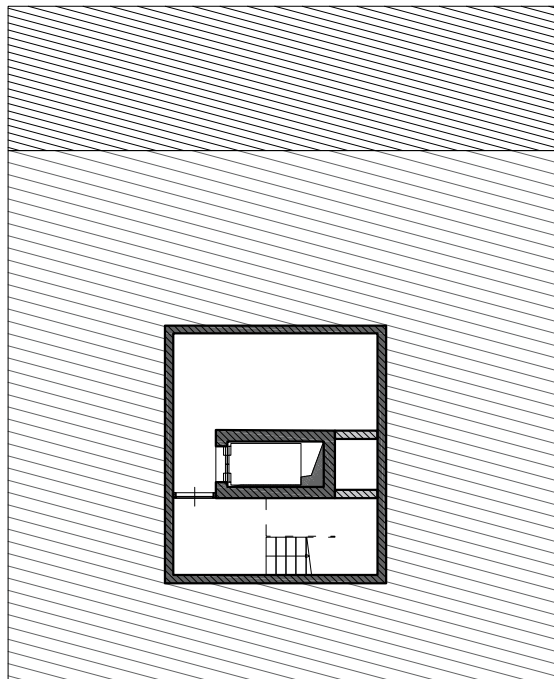
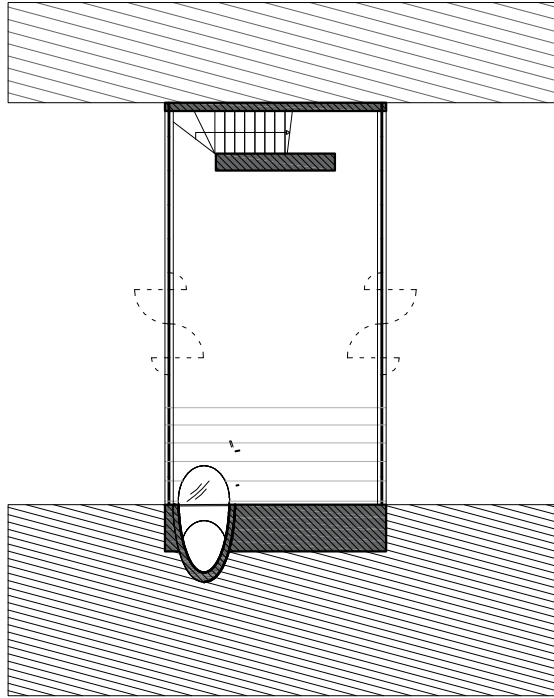

Level -1 (entrance level) 1:200

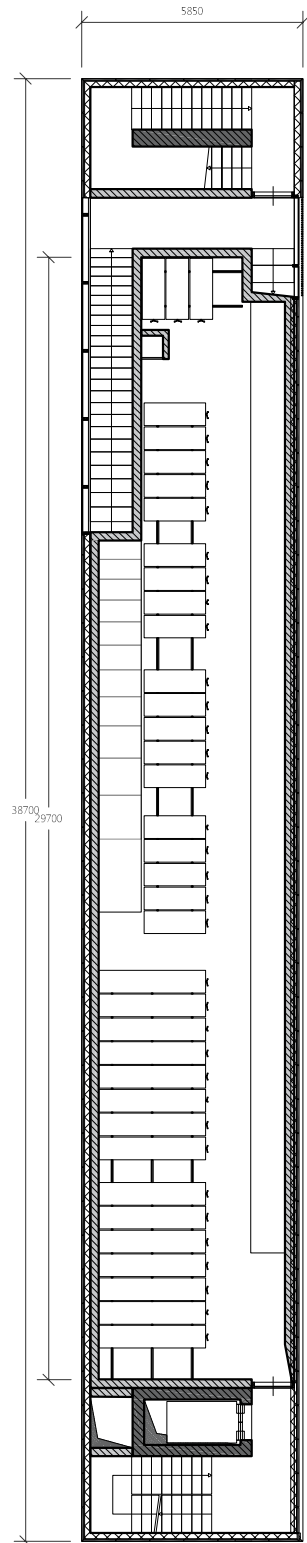

Level 1 1:200

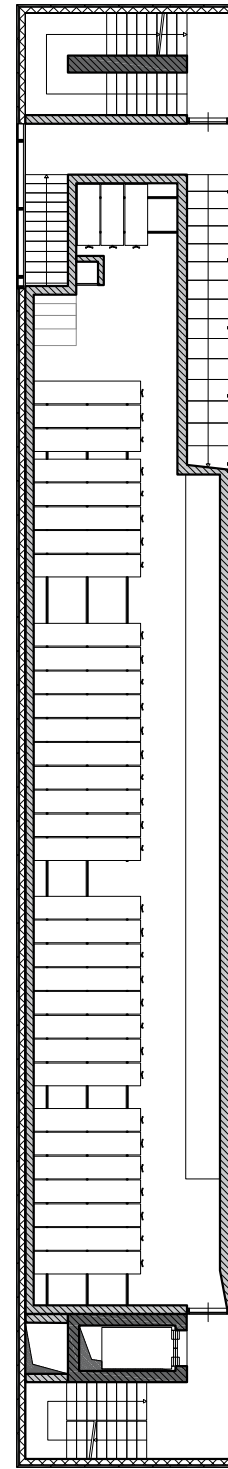

Level 2 1:200

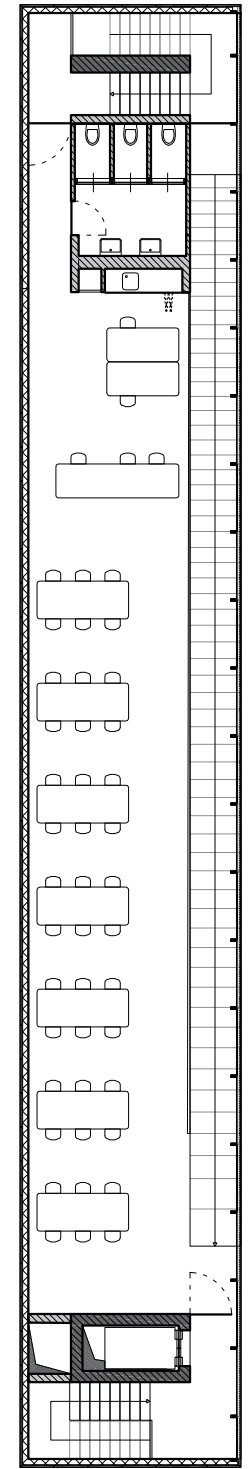

Level 3 1:200

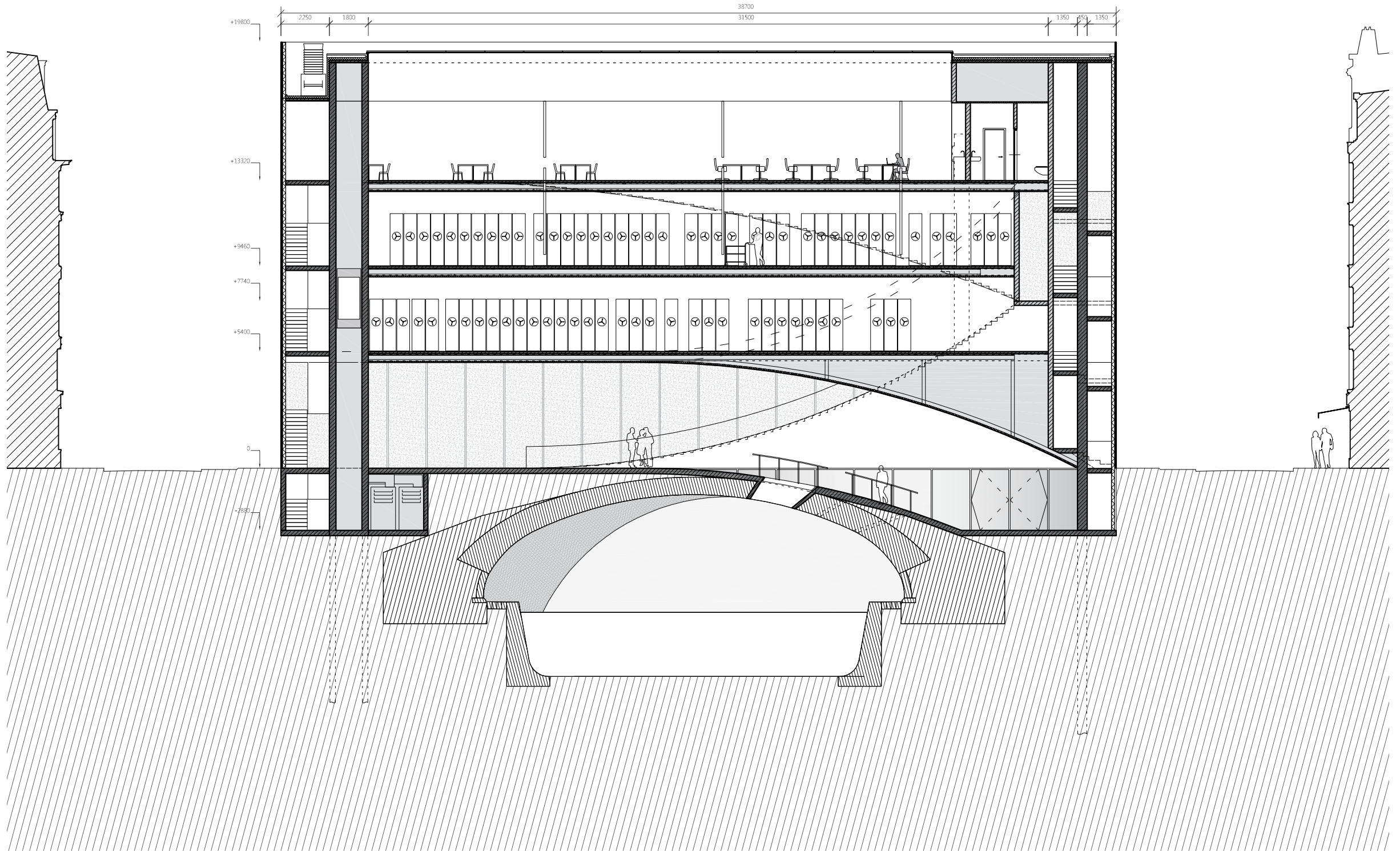

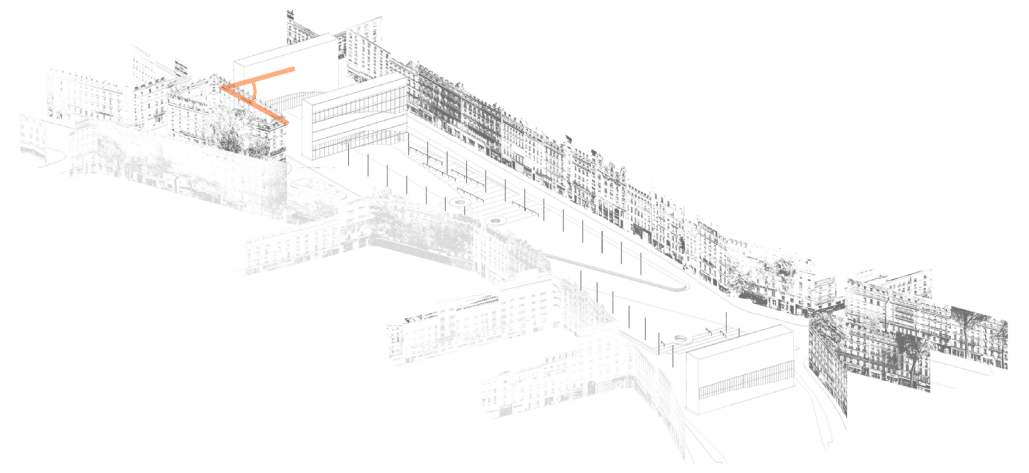
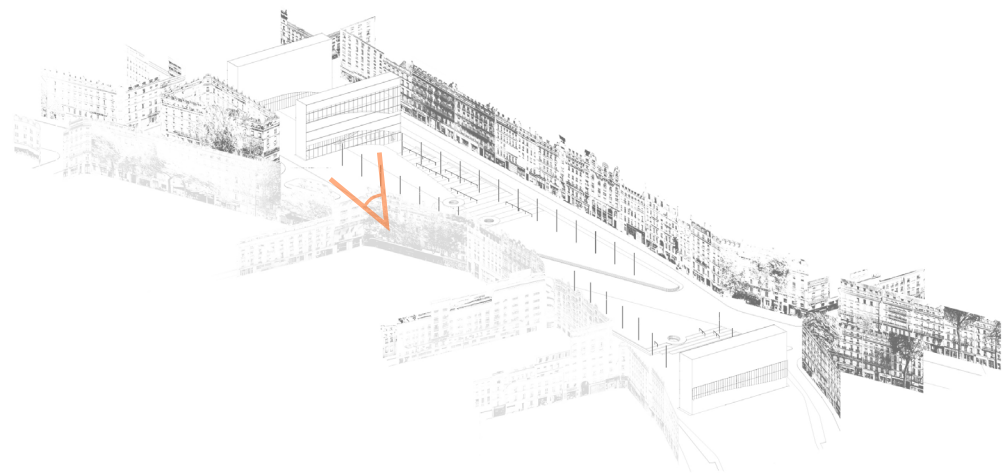
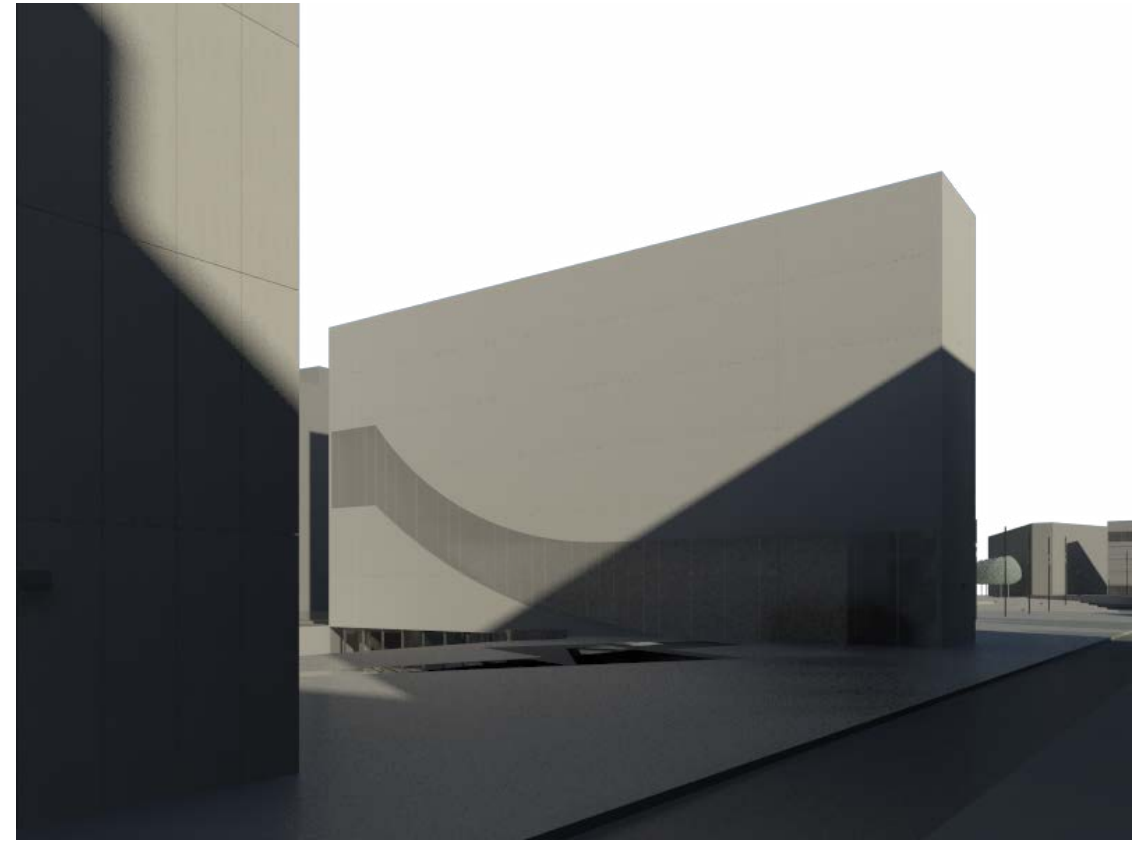
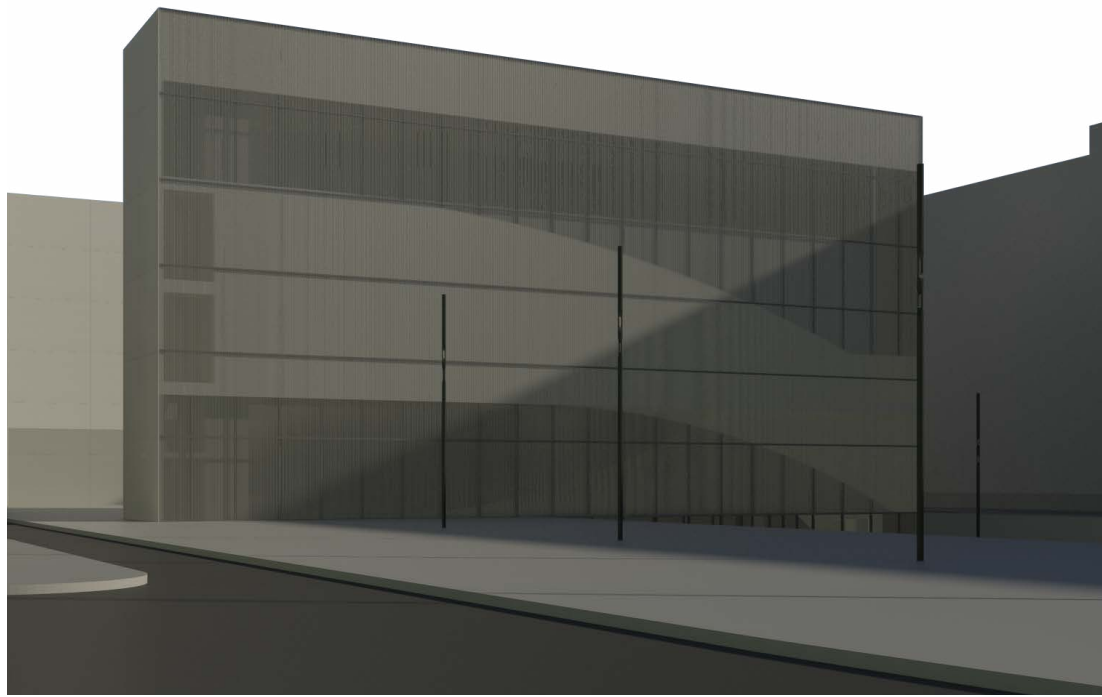

Digital Political Archive

The digital archive houses a server space which is placed at the top floor, close to the roof and an extra machine room that facilitates the cooling of the servers.

the first floor is office space. The two floors are connected by a large staircase that shows in the facade.

The middle two floors are non public archive research floors, the second floor (level 2) is a testing lab for server spaces and

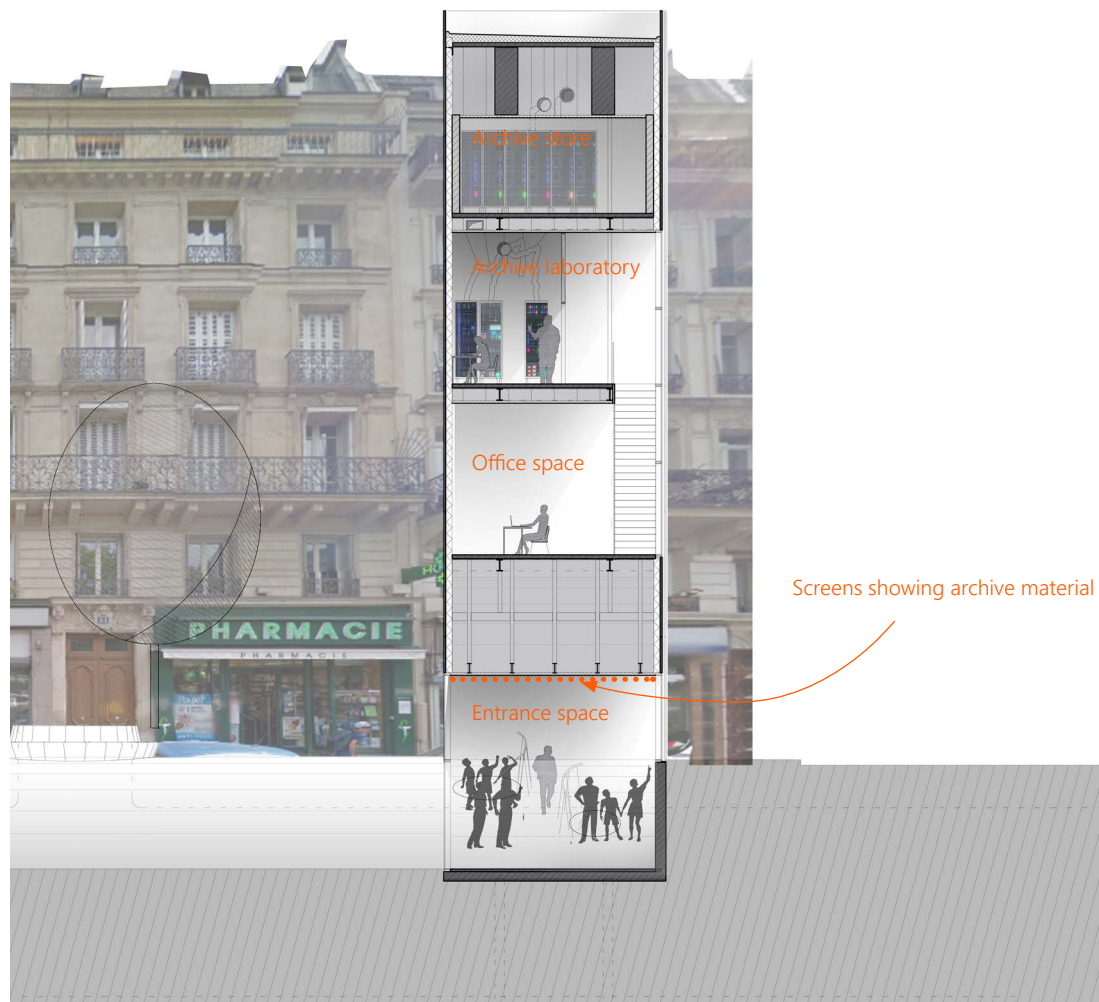

Section AA' 1:200

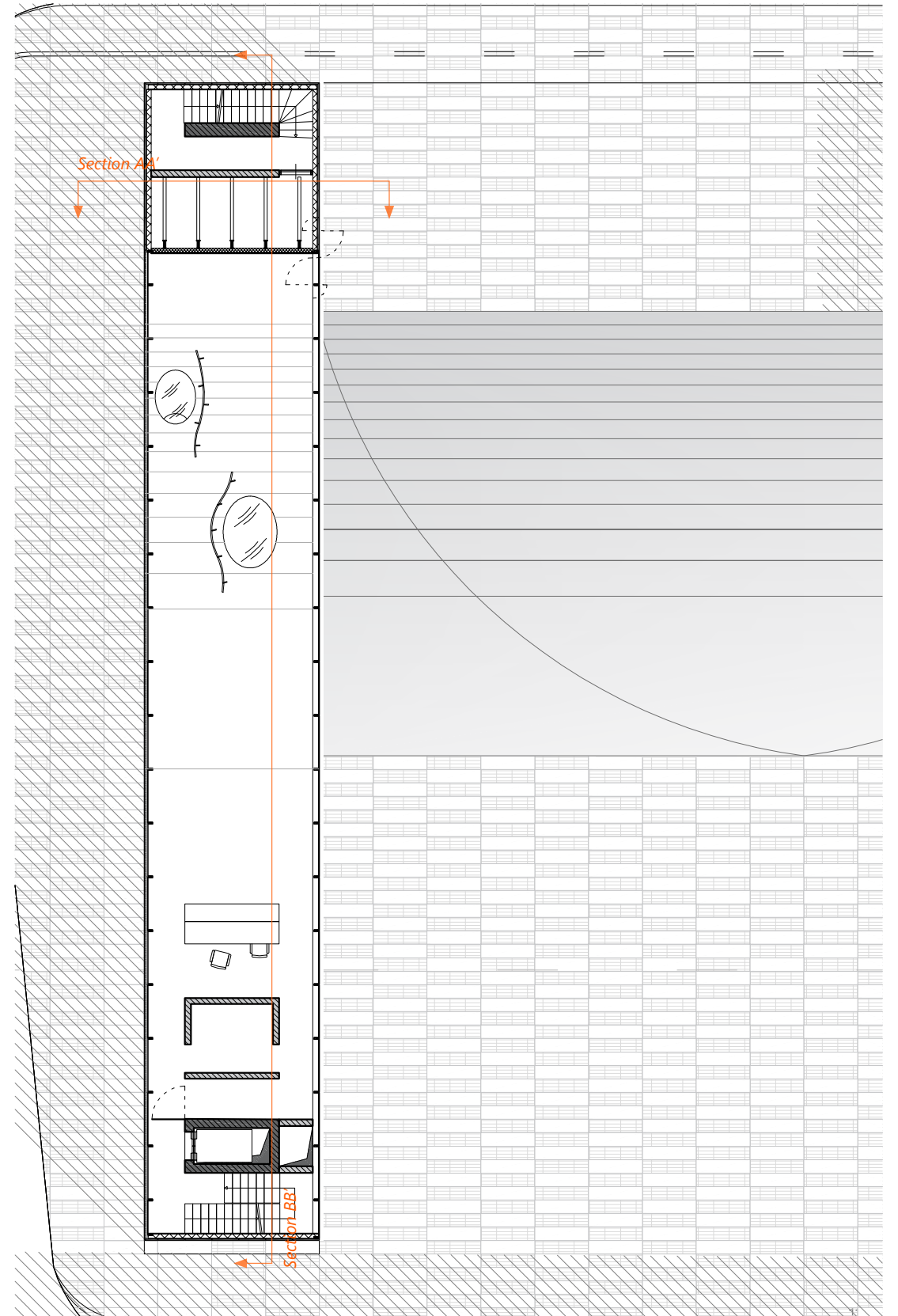

Street level 1:200

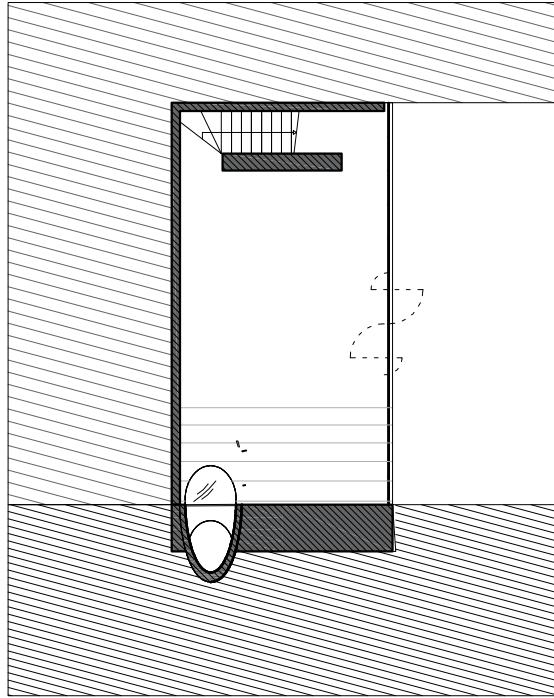

Level -1 (entrance level) 1:200

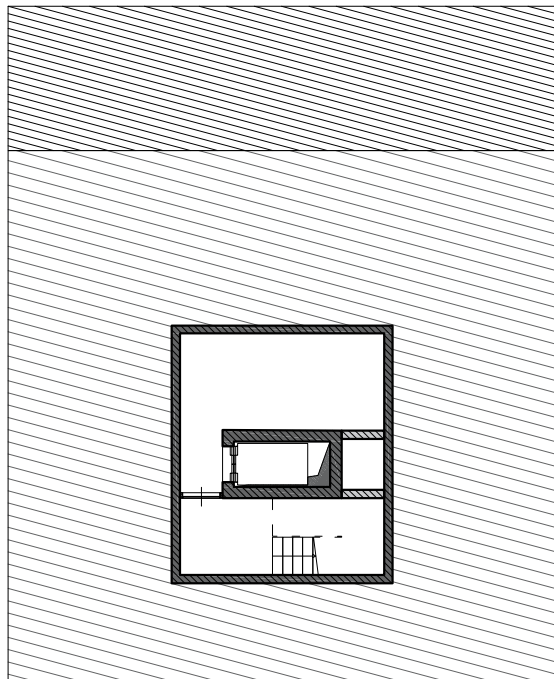

Level 1 1:200

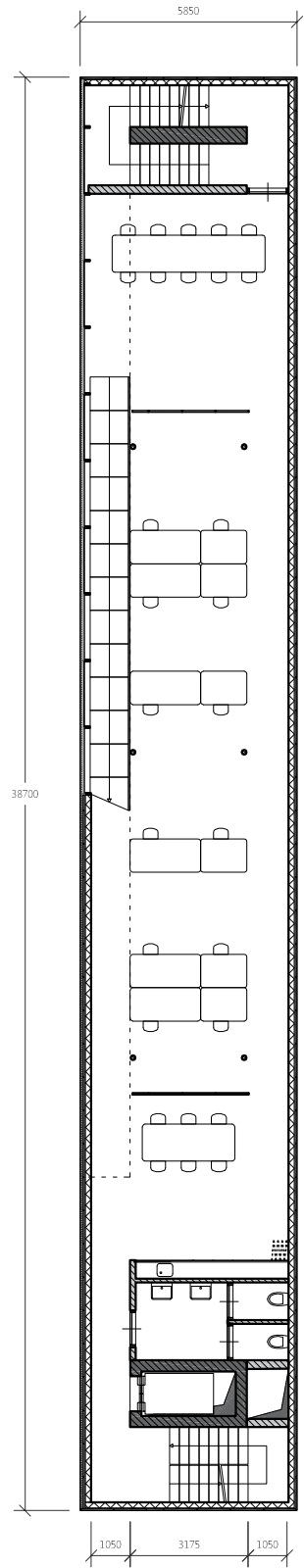

Level 1 1:200

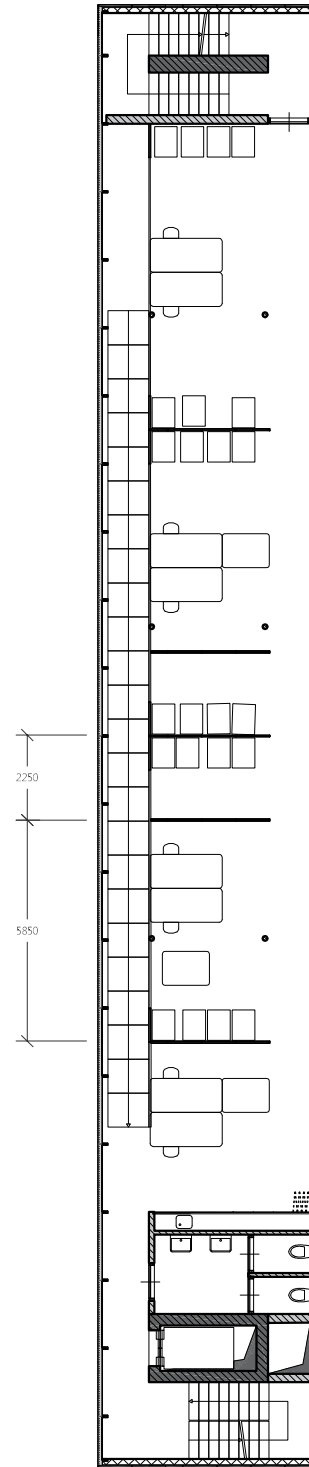

Level 2 1:200

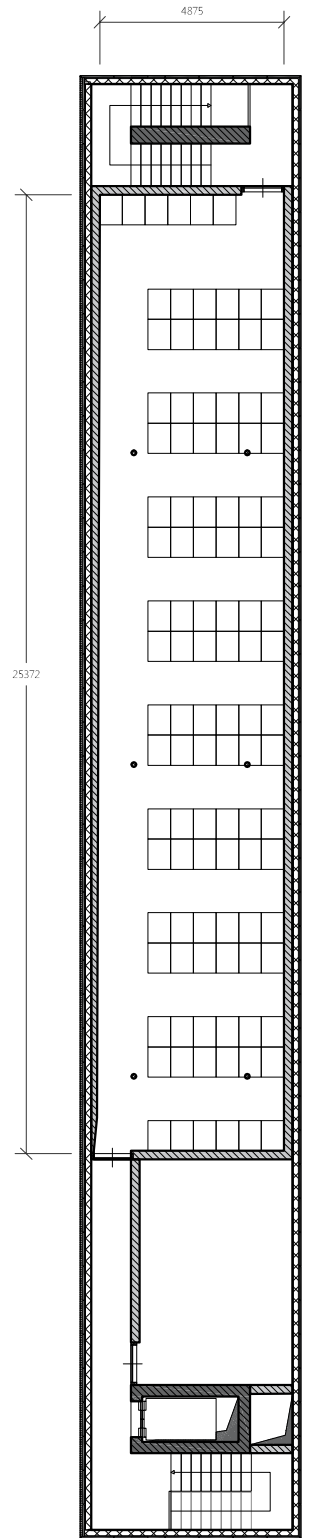

Level 3 1:200

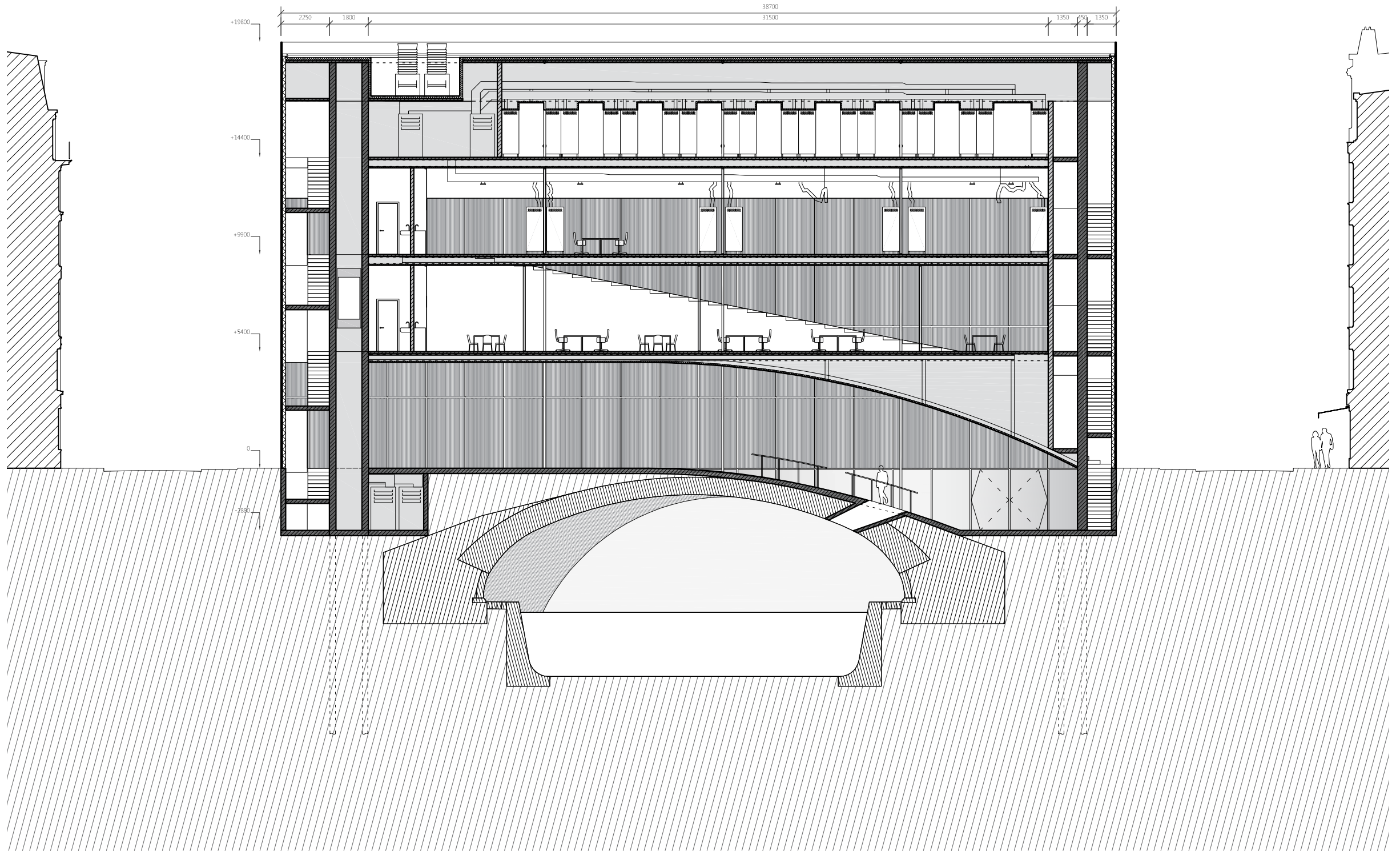

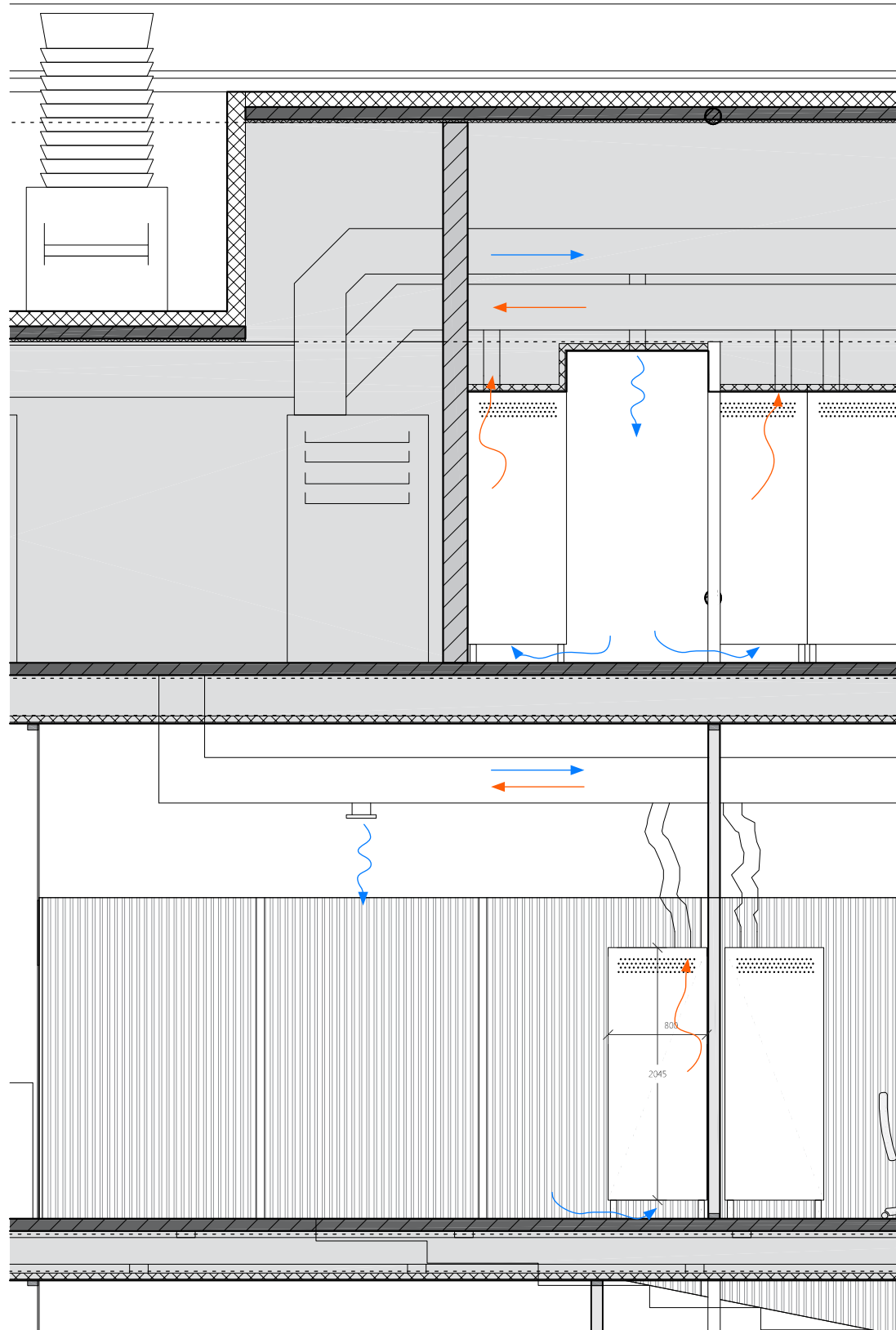

Digital archive infrastructure

The digital archive is built up out of server racks that measure 600*800*2045mm although the archive can be planned differently using any other type of server rack.

In the archive space, the servers are raised above the floor so fresh air can flow in to for

cooling. Used air is sucked away at the top. The same system is employed in the laboratory space but here the air system is exposed to allow for flexible test setups.

The air treatment is done in an extra machine room that sits right below the roof. Condensators and coolers can be placed at the rooftop.

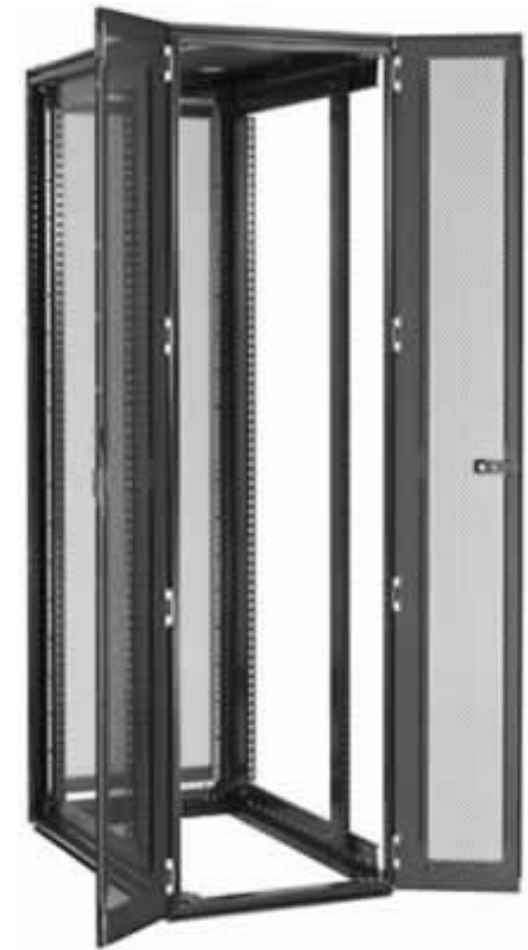

◀ Cut-outs of section BB' of the digital political archive, scale 1:50

◀ A typical server rack



◀ Glass beams in the section of the facade, behind terrazzo facade panels or glass, the distance between the bars is chosen so you can look into the building when close to the facade.

◀ The vertical joint between the terrazzo facade and the translucent terrazzo

Facade materials

As mentioned in the Typology chapter, there are three types of facades. The open facades towards the squares and the closed facades towards the enclosed space.

The open facade is made of a screen of glass beams that sits in front of a terrazzo plate facade or a glass facade. The shape of the interior shines through the

glass beams while the facade remains one whole.

The closed facade is made of the same terrazzo plates but is made translucent at some points show the inner program. This translucency is done by taking thin layers of translucent terrazzo veneer on regular curtain wall glazing.

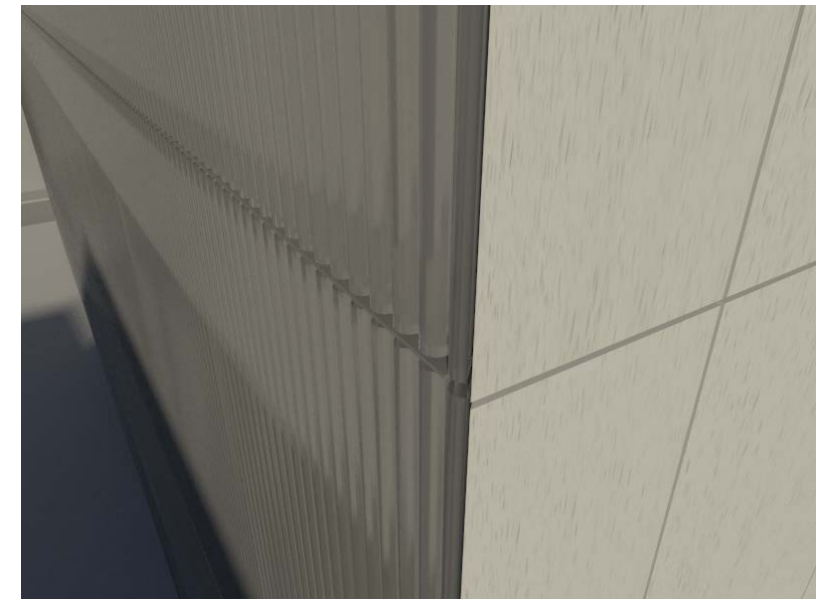

◀ The short section of the Bataclan Archive

▼ The translucent terrazzo facade material

▼ A facade detail of the corner where terrazzo and glass beams meet

▼ Next spread: the difference between the appearance of night and day of the glass beams facade

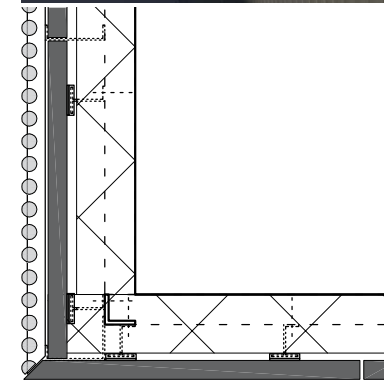

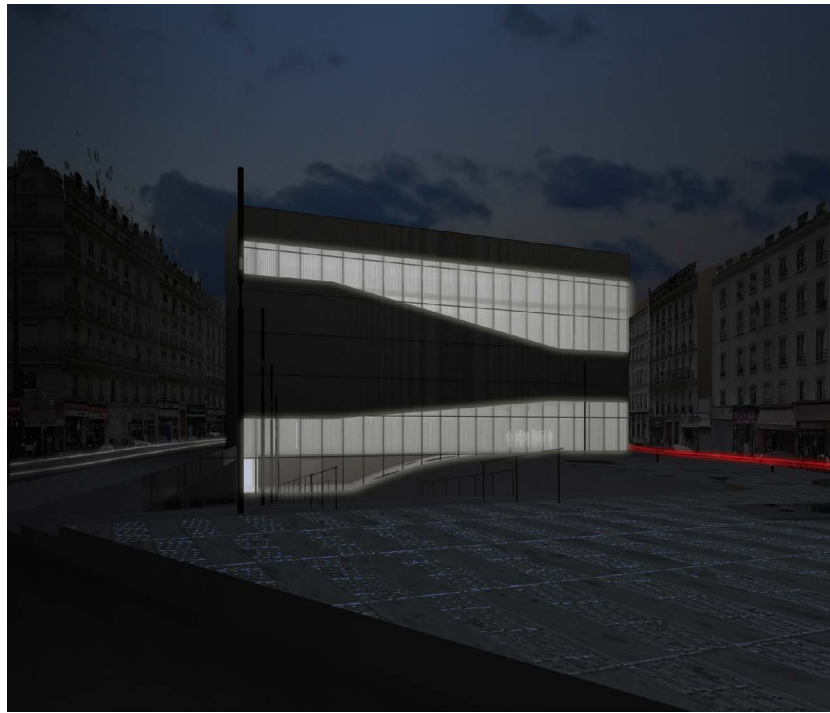

Bibliography

Creswell, John W. (2003) *Research Design, Qualitative, Quantitative and Mixed Methods Approaches*. 2nd edition. Thousand Oaks CA, United States of America; SAGE Publications.

Krulwich, Robert; Abumrad, Jab. (2015) *Trust Engineers*, WNYC, Radiolab podcast. New York NY, United States of America.
<http://www.radiolab.org/story/trust-engineers/>
Accessed 30 December 2015

Booth, Robert. (2014) Facebook reveals news feed experiment to control emotions, *The Guardian* website. London, United Kingdom
<http://www.theguardian.com/technology/2014/jun/29/facebook-users-emotions-news-feeds>
Accessed 30 December 2015

Stiegler, Bernard. (2010) *Anamnesis and Hypomnesis* Digitally published essay by Ars Industrialis, an association initiated by Bernard Stiegler to critically assess digital and political developments.
<http://arsindustrialis.org/anamnesis-and-hypomnesis>
Accessed 31 December 2015, first published in 2010

Vale, Lawrence J. (2008). *Architecture, Power & National Identity*, 2nd edition. Abingdon, Oxfordshire, United Kingdom: Routledge. (First published: 1992, Yale University press.)

Derrida, Jacques. (1996). *Archive Fever, a Freudian impression*, translated by Eric Prenowitz. Chicago IL, USA: Chicago University Press. (First published: 1995, Éditions Galilée, original title (French): *Mal d'archives: une impression freudienne*.)

Derrida, Jacques (1982). *Plato's Pharmacy*, appearing in *Derrida's Dissemination*. Translated by Barbara Johnson, Athlone Press,

Rabinow, Paul (1984). *The Foucault Reader*. Pantheon books,

New York. London UK

Mouffe, Chantal (2000). *Deliberative Democracy or Agonistic Pluralism*. Institute for Advanced Studies, Vienna

Castex, Depaule & Panerai (2004). *Urban Forms*. translated by Olga Vitale Samuels. Oxford, UK. Originally published as *Formes Urbaines, de l'Îllôt à la barre in 1977 in Versailles*, France.

Nora, Pierre. (1989) *Between memory and history*

Lévy, Pierre. (1997) *Collective Intelligence*, Cambridge MA, USA: Perseus Books.