

## MASTER

### Demand forecasting for commodity chemicals modeling price and supply chain dynamics

Corbijn, B.J.

*Award date:*  
2013

[Link to publication](#)

#### **Disclaimer**

This document contains a student thesis (bachelor's or master's), as authored by a student at Eindhoven University of Technology. Student theses are made available in the TU/e repository upon obtaining the required degree. The grade received is not published on the document as presented in the repository. The required complexity or quality of research of student theses may vary by program, and the required minimum study period may vary in duration.

#### **General rights**

Copyright and moral rights for the publications made accessible in the public portal are retained by the authors and/or other copyright owners and it is a condition of accessing publications that users recognise and abide by the legal requirements associated with these rights.

- Users may download and print one copy of any publication from the public portal for the purpose of private study or research.
- You may not further distribute the material or use it for any profit-making activity or commercial gain

Eindhoven, February 2013

**Demand forecasting for commodity  
chemicals: Modeling price and supply  
chain dynamics**

by

Bart J. Corbijn

BSc Industrial Engineering and Management Science – TU/e 2009  
Student identity number 0612087

in partial fulfillment of the requirements for the degree of

**Master of Science  
in Operations Management and Logistics**

Supervisors:

Prof.dr.ir. J.C. Fransoo, TU/e, IE&IS

Dr. ir. B. Walrave, TU/e, IE&IS

Eindhoven University of Technology

Series Master Theses Operations Management and Logistics

Subject headings: System Dynamics; Bullwhip effect; Sales forecasting; Process industry; Supply chain management.

## ABSTRACT

This Master's thesis extends research on supply chain bullwhips by incorporating the effect of upstream price volatility. An alternative forecasting tool for upstream polymer producers based on System Dynamics is deployed. We show that structural demand development is caused by final consumer demand, whereas short range demand dynamics are explained by price fluctuations.



# MANAGEMENT SUMMARY

This Master's thesis extends research on supply chain bullwhips by separately incorporating the effects of price and supply chain dynamics on the observed demand volatility of commodity chemicals. We analyze the downstream supply chain of a specific commodity polymer (polymer X) on industry level and improve the predictability of upstream demand waves.

## **Problem definition**

Polymer producers notice that the recent cyclical demand realization of polymer products is not accurately captured by traditional univariate demand forecasting techniques. Industry consultants report that both price and supply chain dynamics influence demand volatility observed by the polymer producers. From a price perspective, both the recent increase in commodity price volatility and the observation that price volatility extends deeper into the downstream supply chain affect the purchasing tactics of polymer processors (direct customers of polymer producers) and thereby increase the demand volatility observed. From a supply chain perspective, final consumer demand development and corresponding inventory updates in the downstream chain affect upstream demand volatility.

## **Research area**

We link the observations of industry consultants to the available literature on the bullwhip effect and illustrate that medium range demand fluctuations are based on final consumer demand development and re-active (de)stocking in the supply chain, while price dynamics initiate active (de)stocking by polymer processors which causes short range demand fluctuations. Active (de)stocking implies that companies change their inventory to sales ratio, while re-active (de)stocking is triggered by changing demand pattern (i.e. constant inventory to sales ratio). Aligned with this decomposition between short and medium range forecasting, the following research questions have been defined:

- 1. Can we improve medium range demand forecasting (horizon 3 to 12 months) for polymer X by a system dynamics model of the downstream supply chain that captures final consumer demand and re-active (de)stocking?*
- 2. Can we improve short range demand forecasting (horizon 1 to 2 months) for polymer X by a system dynamics model that captures active (de)stocking of direct customers triggered by price dynamics?*

## **Research methodology**

To develop short and medium range demand forecasts for polymer X on industry level, we construct a system dynamics model of the downstream supply chain. The model consists of a structural and a noise part. The structural part models the effect of final consumer demand on industry demand in the absence of active (de)stocking. Final consumer demand for polymer X is modeled as the end market of the supply chain under study. End market demand is linked to GDP since the various application domains of polymer X are fragmented across industries (e.g. retail, manufacturing and construction). The structural model is used for medium range demand forecasts. The noise part adds the price-demand relations to the system dynamic model by linking real-time price information to the desired inventory coverage of polymer producers. This active (de)stocking behavior mediates the price-demand relation and creates short range demand fluctuations.

### **Theoretical contribution**

The structural model accurately predicts medium range demand based on exogenous final consumer demand data and re-active destocking in the downstream chain. This finding is in line with earlier studies. In contrast to earlier findings, we show that the demand drop experienced by polymer producers as a direct result of the 2008 credit crisis is not amplified by active destocking in the chain. Hence, the demand drop is solely explained by a reduction of final consumer demand in combination with re-active destocking in the downstream chain. The observed demand drop by polymer producers is therefore lower than the demand drop observed by upstream echelons in the supply chains studied by Udenio et al. (2012), who modeled a synchronized active destocking shock at the start of the 2008 credit crisis. We reflect on this difference by stating that polymer processors have a more upstream cost than downstream demand focus due to the low value added nature of their processes. Upstream costs dropped dramatically due to the massive drop of commodity prices in 2008, this led to extra orders of commodity processors. The fact that the upstream companies in the supply chains studied by Udenio et al. (2012) are less commoditized and have a more downstream focus indicates why the demand drop observed by polymer producers is lower than the upstream demand drop reported by Udenio et al. (2012).

We however indicate structural destocking in the downstream supply chain of polymer producers in later years by illustrating that the average chain inventory coverage is reduced with 5 percent in 2011-2012. The structural increase of the commodity prices and exploitation efforts in the form of inventory reduction by downstream players in order to increase short term performance are possible explanations for this. We hereby confirm our hypothesis that the inventory coverage in the downstream supply chain of polymer X decreased in the last five years.

The second theoretical contribution of this thesis lies in the discovery of the influence of price dynamics on short range demand fluctuations for upstream polymer producers. Due to the high commodity price volatility and the observation that price volatility extends deeper into the downstream chain the price effect outweighs the effect of final consumer demand in the short range causing high demand variability. We furthermore illustrate that the relation between price and short range demand dynamics is mediated by the inventory tactics of polymer processors.

We assume that the inventory tactics of polymer processors depend on their ownership structure and test three different hypotheses underlying the price-active (de)stocking relation. We show that privately owned customers take advantage of a pre-buy opportunity caused by a delay in the price pass through from the price drivers to the polymer price (price anticipation), whereas non-privately owned customers delay their orders when the polymer price is high. We furthermore show that the pre-buy opportunity is maximal when the price drivers indicate a large increase in the polymer price for the next month. In contrast, the hypothesis that polymer processors speculate on a further price increase of polymer X by increasing their orders is rejected.

### **Managerial insights**

The results of this study have implications for polymer producers at both the tactical and operational level of decision making. Tactically, it is important for managers to keep *track of final consumer demands*, supported by an endogenous simulation of ordering behaviors, to make forecasts at quarterly or yearly levels. Furthermore, we recommend assessing the price formulas used in supplier-buyer contract management in order to *reduce the pre-buy opportunity*. Operationally, aligning commercial and supply chain decisions is crucial. It is

important to use price, production and allocation instruments as anticipation instead of reactive tool. For managers it is furthermore important to keep *track of the polymer price drivers as well as polymer prices* and understand the relation between price fluctuations and demand peaks. Scenario analysis (in the form of *contingency plans*) can assess the impact of different price scenarios on industry level demand. We recommend polymer producers to focus on margin during pre-buying periods, whereas periods in which customers postpone their orders ask for a focus on volume; demand will pick up in future periods, when a price reduction is expected.

The ability to test the effect of different price and final consumer demand scenarios on industry demand is of great value for the industry, since it not only improves demand signal interpretation in the short run (e.g. how to interpret an increase in demand when the feedstock price is increased?) but it also permits longer range forecasting of demand by testing different end market demand developments.

The models presented in this thesis should not be seen as purely forecasting tools. The key message lies in the difference between the medium and short term decision making focus for upstream commodity producers. When the implementation horizon is longer, decisions should be based on final consumer demand: focus on the necessities and the evolution of the markets in which products are used. For short range decision making price dynamics have an enormous impact. High commodity price volatility highlights the importance of tracking the price drivers and collaborating with customers to decrease bullwhips caused by the last minute price fluctuations.





## PREFACE

This thesis is the result of my graduation project for the MSc program in Operations Management and Logistics at the Eindhoven University of Technology.

I would like to use this opportunity to express my gratitude to my supervisors. First of all I would like to thank Jan Fransoo. It was a pleasure to work with him during this project. His enthusiasm during our meetings has been an inspiration. I'm truly impressed by his involvement; by critical reflecting on my work he guided me in developing new insights. Furthermore, my gratitude goes out to Bob Walrave, my second supervisor. During the modeling process he came up with valuable new insights that made me reflect on my work.

I would like to thank all my colleagues at the company where I executed this study. I am especially grateful to my supervisor. He gave me the opportunity to work in a nice and dynamic environment, and challenged me to stay focused on the practical implications of my project.

I owe many thanks to my family for their continuing support that allowed me to become who I am. Although the last couple of months have not been easy for us, it made me even more realize that family comes first, no matter what. Finally, thanks to all my friends who have made almost six years of studying at the university so enjoyable.

Bart Corbijn

February 2013



# CONTENTS

Abstract.....	2
Management summary.....	4
Preface .....	8
1. Introduction .....	12
1.1 Project scope .....	13
1.2 Project approach.....	15
2. Literature review.....	16
2.1 The modeling approach .....	16
2.2 The bullwhip effect.....	17
2.3 Medium range forecasting: Supply chain dynamics.....	18
2.4 Short range forecasting: Price dynamics.....	19
2.4.1 Commodity price volatility .....	20
2.4.2 Purchasing strategies of commodity consumers.....	20
3. Research contribution: Questions and methodology.....	22
3.1 Research questions .....	22
3.1.1 Medium range forecasting.....	23
3.1.2 Short range forecasting .....	23
3.2 Research methodology.....	24
4. Structural model: Supply chain dynamics .....	26
4.1 Single echelon model.....	26
4.2 Structural supply chain model.....	29
4.3 Verification .....	31
4.4 Conclusions.....	32
5 Structural model results.....	34
5.1 Demand data .....	34
5.2 Structural model validation.....	34
5.2.1 Validation procedure.....	34
5.2.2 Validation results .....	35
5.3 Conclusions.....	37
6 Noise model: Price dynamics .....	38
6.1 Modeling price effects .....	38
6.2 The price-(de)stocking relation .....	38
6.2.1 Price speculation by privately owned customers .....	39
6.2.2 Price anticipation by privately owned customers .....	40

6.2.3	Delayed buying behavior by non-privately owned customer .....	41
6.3	Conclusions.....	42
7	Noise model results.....	44
7.1	Noise model validation.....	44
7.2	Scenario analysis .....	45
7.3	Conclusions.....	47
8	Managerial insights .....	50
8.1	Model predictions.....	50
8.2	Polymer producers' bullwhip contribution .....	50
8.3	Recommendations .....	51
8.3.1	Tactical level .....	52
8.3.2	Operational level.....	53
8.4	Further research.....	54
9	Conclusions and further research.....	56
9.1	Conclusions.....	56
9.2	Further research.....	57
	References.....	60

# 1. INTRODUCTION

This thesis concerns the influence of price and supply chain dynamics on demand for commodity chemicals. To underpin the relevance of this work, we refer to the volatile demand dynamics to which commodity producers are exposed (Pindyck, 2004a). In particular, we refer to the effects experienced by polymer producers. Figure 1 indicates an enormous increase in demand variability from final consumer to direct demand for a specific commodity polymer (polymer X). The higher demand variance upstream the supply chain compared to downstream is referred to as the bullwhip effect and has extensively been studied in literature (Forrester, 1958; Lee et al., 1997a,b; Fransoo and Wouters, 2000; Bray and Mendelson, 2011,2012). Bullwhips can lead to mismatches between demand and production and hence to lower supply chain efficiency.

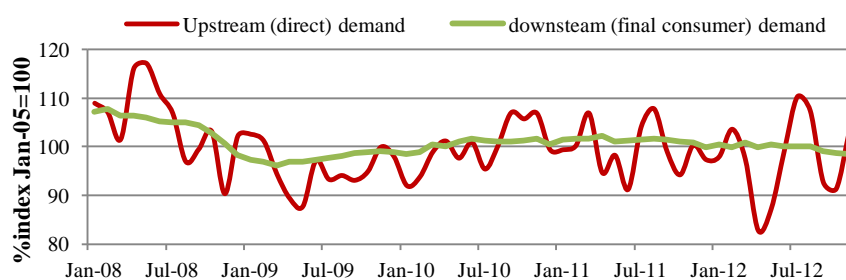

**Figure 1. Upstream (direct) and downstream (final consumer) demand for polymer X, seasonally corrected.**

This thesis elaborates on the bullwhip effect in the downstream supply chain of polymer X. The total supply chain bullwhip for polymer X over the period 2008 till 2012 is 2.60 (i.e. bullwhip effect is calculated by dividing the coefficient of variation of upstream monthly demand by that of monthly final consumer demand (Fransoo and Wouters, 2000)). Polymer producers have noticed that the cyclical realizations of industry demand for polymer X is not accurately captured by traditional forecasting techniques. According to industry consultants, price and supply chain dynamics influence upstream demand volatility.

From a price perspective, the recent increase in commodity price volatility and the observation that price volatility extends deeper into the downstream supply chain (caused by price triggers and falling inventory levels relative to shipments across industries (IHS,2011b)) are possible causes of the increased demand volatility observed at the producers of polymer X. From a supply chain perspective, destocking in the chain influences the demand observed upstream. Given the fact that GDP of EU27 for 2008 was just under 1% and before 2008 the European polymer market had been closely tracking GDP, the drop in demand of 7.4% in polymer demand for 2008 and 6.8% for 2009 are indications for destocking in the polymer chain. Subsequently, the demand increase for 2010 and 2011 (subsequently 2% and 1%) is in line with GDP growth (2010: 2.3%, 2011:0.8%), indicating relatively little re-stocking in the chain after the 2008 credit crisis.

In this study, we aim to improve the predictability of upstream demand waves for polymer X demand on industry level. We distinguish between short and medium range demand forecasting and show that the structural development of industry demand is caused by final consumer demand and corresponding supply chain dynamics, whereas the short range demand dynamics are explained by price fluctuations. Due to the high commodity price volatility and the observation that price volatility extends deeper into the downstream chain, the price effect outweighs the effect of supply chain dynamics on final consumer demand development in the

short range causing high demand variability. We extend our analysis of the price effect on ordering behavior and show that this relation is mediated by inventory tactics of companies downstream. We assume that the inventory tactics depend on the company's ownership structure, and illustrate that privately owned customers take advantage of a pre-buy opportunity caused by a delay in the price pass through from feedstock to polymer X, whereas non-privately owned customers postpone their orders when the price of polymer X is high.

Medium range demand forecasting is based on final consumer demand development and corresponding supply chain dynamics. Final consumer demand for polymer X is modeled as the end market of the supply chain under study. The end market for polymer X is linked to GDP since its various application domains are fragmented across industries (e.g. retail, manufacturing and construction). End market demand is linked to direct demand for polymer X by a system dynamics model of the supply chain. Short range demand forecasting is based on price-demand relations, which are added to the system dynamics model by linking real-time price information to the desired inventory coverage of actors in the chain.

Adding both final consumer demand and price data to this model ultimately leads to polymer X demand predictions. We calibrate the model on industry demand for polymer X in the EU27. This approach fundamentally differs from the traditional forecasting techniques and provides polymer X producers with a valuable 'alternative' forecasting tool. Additionally, the ability to test the effect of different price and final consumer demand scenarios on industry demand is of great value for the industry, since it not only improves demand signal interpretation in the short run (e.g. how to interpret an increase in demand when the feedstock price is increased?) but it also permits longer range forecasting of demand by testing different end market demand developments.

The scientific supply chain model is based on the model developed by Udenio et al. (2012), who used supply chain dynamics to prove the existence of the bullwhip effect. According to them, the 2008 credit crisis caused a synchronized reduction in target inventory levels across industries, leading to massive demand dynamics upstream the supply chain. The outcome of the study of Udenio et al. (2012) is used for medium to long range forecasting immediately after the start of the credit crisis. Our model-based empirical research differs from the work of Udenio et al. (2012) by taking the effect of price on the purchasing behavior of direct customers into account. The major theoretical contribution of this work is that we show that short range demand dynamics of commodity producers are caused by price fluctuations instead of downstream supply chain dynamics.

## 1.1 PROJECT SCOPE

This thesis is based on an industry demand analysis for polymer X. Before moving on to the project approach we first define the project scope.

### **Downstream chain and the final consumer**

Final consumer demand is linked to direct demand for polymer X by a system dynamics model of the downstream supply chain. We define the scope of the chain by elaborating on the characteristics of the actors and the end market that is served (Figure 2).

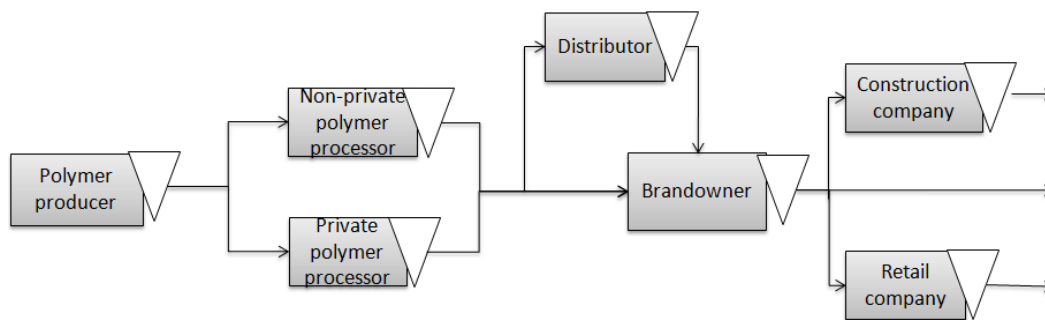

**Figure 2. The downstream supply chain for polymer X.**

The various application domains of polymer X lead to a divergent set of sales channels. In order to calibrate the model on industry demand for polymer X from the EU27, the geographical scope of the end market is the EU27. End market research executed by industry consultants for this region indicates seven major end-use applications for polymer X. In this study we focus on the largest end market applications, which accounts for one third of total end market sales. We provide two arguments for this. First, the demand realization of this end market is in the mature phase of its business development and a valid representation of the overall market space. Second, the remaining end market applications are extremely fragmented which complicates the identification of both the players as well as the link with market indicators. Hence, the fact that the total length of the downstream supply chain affects the timing and amplitude of the demand waves observed by the polymer producers indicates that we should not explicitly take those fragmented end market applications into account.

The supply chain between the polymer producer and the final consumer consists of two to four different echelons: polymer processors, distributors, brand owners and retail or construction companies. The purchasing strategies of polymer processors differ. We assume that the difference in purchasing strategies is linked to the ownership structure of these companies. The private and non-private polymer processors are therefore modeled as two different echelons in the chain.

### **Commodity markets**

Polymer producers function as the upstream echelon in the chain under study. They add value by polymerizing small molecules known as monomers into a bonded chain or network (Painter & Coleman, 1997). Polymers encompass very large classes of chemical compounds with a wide variety of properties. In this study we assess demand for commodity polymer X, which is a derivative of a feedstock commodity chemical. Commodities are products of uniform quality that are produced in large quantities by many different producers and to which the law of one price applies (O’Sullivan, 2003). Due to the similarities in the market space of commodities, the results of this study can be generalized to other commodity markets.

### **Industry aggregation**

We focus on industry demand for polymer X in Europe. According to Cachon et al. (2007) industry-level volatility is relevant to some (but not all) operational decisions. They argue that it is not possible to conclude from industry-level volatility whether amplification occurs at the firm level. Different pricing strategies by competitors may result in bullwhip exposure on individual firm level while the industry does not exhibit the bullwhip effect. Nevertheless, in a commodity market products are of uniform quality and the law of one price applies. Hence, customers can easily switch between suppliers indicating no difference between the bullwhip



exposure on industry and firm level. Industry results can therefore be generalized to the firm level.

## 1.2 PROJECT APPROACH

The remainder of this work is organized as follows: Chapter 2 commences with an explanation of the difference between traditional forecasting and the approach used in this study. Then, a structured overview of literature related to both the medium and short range demand drivers is presented. The research questions are formulated in section 3. The research questions are addressed by developing a system dynamics model of the downstream supply chain (chapter 4). The model is implemented in Vensim DSS and is used as a forecasting tool. Medium range forecasts are the output of the structural supply chain model and are validated in chapter 5. Chapter 6 explains the price – demand relation and shows how to create short range forecasts based on this relation. The outcome of this model is validated in chapter 7. Subsequently scenario analyses are discussed in order to test the effect of different price and end market demand scenarios on industry demand. In chapter 8 we translate the short and medium range forecasts to recommendations for tactical and operational supply/demand decision making. The conclusions and recommendations of the theoretical contribution of this thesis are presented in chapter 9.

## 2. LITERATURE REVIEW

*We first explain the difference between traditional forecasting and the approach used in this study. Then, a structured overview of literature related to supply chain dynamics as the medium range and price dynamics as the short range driver of the bullwhip effect is presented.*

### 2.1 THE MODELING APPROACH

Traditional uni- and multivariate demand forecasting techniques are based on the statistical relations within or between time-series. A time-series is a collection of observations made sequentially through time (Chatfield, 2000). In time-series analysis the main focus is on finding the main properties of the historical output data. Based on the autocorrelation within historical demand data a stochastic process is selected that adequately captures the underlying structure of the time-series. Subsequently, the parameters of this model are estimated and the model is used to extrapolate the historical values into forecasts.

In situations such as the 2008 credit crisis the dynamics are such that the statistical relation within the time-series of historical demand is not representative for future values (Peels et al., 2009). We therefore propose an alternative approach to forecasting where we create a model of the downstream supply chain where end market demand and price data are the only exogenous inputs to the model. Both discrete event simulation (DES) and system dynamics modeling (SD) are tools to model industrial and business processes and can be used to model a supply chain as a series of processes. The structure of the chain is important for both techniques. DES models use the historical and statistical relation between different building blocks of the chain to estimate the performance of a system with statistical certainty (Law and Kelton, 1999). In our model, the static relation between price and upstream demand however does not capture the dynamic nature of the interactions between both. This dynamic relation is influenced by (delayed) inventory policy updates of the customers and the producers' ability to supply. The same holds for the static relation between end market and upstream demand. Especially when the market space is hit by a black swan incident (Taleb, 2010) the supply chain dynamics are such that the static relations in the model are not representative for future values. We therefore conclude that DES is not the right modeling approach for our models.

#### **System dynamic models**

System dynamics is a computer-aided approach for analyzing and solving complex problems with a focus on policy analysis and design. The system dynamics approach uses a perspective based on information feedback and delays to understand dynamic behavior (Forrester, 1958). Forrester (1980) identified three types of data necessary to develop system dynamic models: numerical, written, and mental data. Where traditional forecasting models are only based on numerical data (e.g. time-series of historical demand data), written and mental data are also taken into account in system dynamic models. Written data includes operating procedures such as inventory policy parameters and mental data includes all the information in people's mental models such as their sensitivity to demand signals. Forrester (1980) stated that numerical data contains only a small fraction of the information available in written and mental data. Written and mental data can be seen as the explanatory variables underlying the numerical output data. Since system dynamic models account for the dynamic relation between explanatory variables and output data, these models will improve the accuracy of demand forecasts. The medium to long range forecasts derived from a system dynamics model of a supply chain during and immediately following the 2008 credit crisis are validated by Udenio et al. (2012).

To our knowledge, system dynamics is the only modeling approach that can account for price and supply chain dynamics. Moreover, system dynamics models allow for scenario analysis and thereby increase the interpretability of demand signals. It is therefore easy to see that system dynamics is a suitable approach for our problem.

## 2.2 THE BULLWHIP EFFECT

The observed increase in demand variance upstream the supply chain is in literature referred to as the bullwhip effect. The bullwhip effect first appeared in Forrester (1958). Bray and Mendelson (2012) measure the bullwhip on a single echelon level and define a company's bullwhip by the increase in variability from its sales to its purchases. According to Fransoo and Wouters (2000) the total supply chain bullwhip effect is the coefficient of variation of the upstream production plan divided by the coefficient of variation of consumer demand. Under specific conditions this is the product of the measured effects at each echelon.

The existence and measurement of the bullwhip effect is however extensively discussed in literature. Cachon et al. (2007) seek the bullwhip effect in industry level data and find that "retail industries generally do not exhibit the effect, nor do most manufacturing industries." Other studies (Holt et al., 1968; Anderson et al., 2000; Terwiesch et al., 2005) however confirm the existence of bullwhips on industry level. Chen and Lee (2012) illustrate that those contradicting findings are caused by a difference in the measurement of the bullwhip effect. Where Lee et al. (1997a) originally base their bullwhip measurement on information flows around a single product on a time level of one order period, empirical studies including that of Cachon et al. (2007) measure the bullwhip based on material flow, aggregated product and aggregated time level. Chen and Lee (2012) specifically note that increasing the time aggregation decreases the visibility of the bullwhip effect. Hence, empirical studies are essentially exploring the existence or the magnitude of aggregated bullwhips in material flows and therefore may not account for the original bullwhip effect described by Lee et al. (1997a). In this thesis, we will assess the total supply chain bullwhip in polymer X industry demand based on material flows and a product family level. From a time perspective we assess both the bullwhip effect on the order period level of one month as well as the aggregated bullwhip effect on the quarterly level.

Bray and Mendelson (2011) disaggregate the bullwhip effect in a multiplicative and an additive component. The multiplicative bullwhip is caused by magnifying existing demand signals through the chain and depends on the variability and autocorrelation of final consumer demand (i.e. demand signal processing as discussed in Lee et al. (1997a,b)). Hence, demand waves are amplified upstream due to inventory updates in the chain (given a stable inventory/sales-ratio), this is referred to as re-active (de)stocking (Peels et al., 2009). The additive bullwhip refers to the contribution of new sources of variation to demand signals (noise factors). The noise contribution arises from factors other than demand such as disruptions in the production process, price variations, order batching and staffing issues and leads to updates in the desired inventory coverage of companies in the chain (active (de)stocking (Peels et al., 2009)). Noise factors are related to the three other causes of the bullwhip effect as discussed in Lee et al. (1997a,b): rationing and shortage gaming, order batching and price fluctuations.

Additionally, Bray and Mendelson (2011) found that the short noticed noise contribution drives the bullwhip more than the multiplicative effect caused by signals with a longer information lead time. They suggest that firms should focus on reducing last-minute production and price fluctuations, since signal amplification due to uncertainty that is resolved with limited periods

notice is the main driver of the bullwhip effect. Bray and Mendelson (2012) confirmed this by reporting that demand signals firms observe with more than three quarters' notice drive 30% of the bullwhip, whereas signals with less than one-quarter's notice drive 51%.

In this thesis, we follow the bullwhip disaggregation approach of Bray and Mendelson (2012) and show that the multiplicative bullwhip effect on final consumer demand fluctuations affects medium range demand development (section 2.3), whereas the additive bullwhip triggered by price dynamics affects short range demand fluctuations (section 2.4). Table 1 provides an overview of the bullwhip disaggregation terminology used in this thesis.

<b>Bullwhip disaggregation</b>	<b>Multiplicative bullwhip</b>	<b>Additive bullwhip</b>
<b>Timing</b>	Medium range (quarterly)	Short range (monthly)
<b>Indicator</b>	Final consumer demand	Price dynamics
<b>Inventory effect</b>	Re-active (de)stocking (constant inventory/sales-ratio)	Active (de)stocking (adapt inventory/sales-ratio)
<b>Model</b>	Structural model	Noise model

**Table 1. Bullwhip terminology.**

## 2.3 MEDIUM RANGE FORECASTING: SUPPLY CHAIN DYNAMICS

We now demonstrate how final consumer demand affects industry demand. End market demand signals have a long information lead time and represent either structural end market movements or the seasonal pattern in end market demand. Chen and Lee (2012) showed that if the variability of seasonality dominates the deseasonalized demand variability, including seasonality in the bullwhip measurement will have a stabilizing effect on the bullwhip. According to the empirical findings of Cachon et al. (2007) this is caused by production smoothing in anticipation of a recurring seasonal pattern.

End market demand signals are amplified upstream due to supply chain dynamics causing a multiplicative bullwhip effect in the chain. Supply chain dynamics are primarily caused by inventory updates. Economist showed that inventory is an accelerator of business cycles (Abramovitz, 1950). Feldstein and Auerbach (1976) stated that inventory reductions account for around 75 percent of the cyclical downturn in GDP from peak to trough. Udenio et al. (2012) furthermore showed that the perceived demand volatility at the upstream producers is not independent; it is affected by every action and strategic decision taken by companies downstream. The effects of information and material delays within a supply chain are well understood and covered in detail in the literature (Sterman, 1989). Upstream demand amplification due to supply chain dynamics can be addressed by stabilizing demand, sharing sales forecasts, shortening the production lead time (Lee et al., 1997a,b) and reducing the sensitivity to demand changes (Udenio et al., 2012).

### **Lehman wave**

To further understand the effect of supply chain dynamics, we elaborate on the study of Udenio et al. (2012) who constructed a system dynamics model that used just the forecast for the relevant end markets and supply chain dynamics to predict medium to long range demand development at DSM during the 2008 credit crisis. In their model, the bullwhip effect is further amplified by explicitly modeling supply line underestimating by decision makers (re-active destocking) in the period immediately following a worldwide synchronized destocking shock in 2008 (active destocking). This shock is modeled as a single pulse shock to the system dynamic model of the downstream chain. In modern economies single pulse analyses are almost

impossible since many other side effects play a role. In 2008 such a pulse was created by a combination of factors (Peels et al., 2009):

1. The bankruptcy of the Lehman Brothers created a worldwide shockwave resulting in peaking interest rates and credit to disappear. In anticipation of these shortages on the credit market all companies worldwide had to improve their financial position. The most obvious way to increase cash reserves was to destock.
2. Up to mid 2008 commodity prices had increased at an astonishing rate. As a result industry was speculating on even higher prices, what resulted in strategies of inventory accumulation. When commodities crashed in mid 2008, industry aimed to reduce their over-priced inventory.
3. Before the crisis the markets were optimistic and expected demand was therefore high. When mid 2008 sales dropped, actual inventory levels grew too high and industry had to destock.

Due to this worldwide synchronized destocking shock, the supply chain bullwhip effect could be measured and validated. The model results show that the model is very robust with regards to the timing of the first demand trough. This means that the modeled structure of the supply chain and the settings of the behavioral parameters are sufficient in order to mimic the supply chain dynamics triggered by the active destocking shock. The robustness of the timing of the first peak and second trough are even better than the timing of the first trough. However, the accuracy of the amplitude of especially the first peak is worse. This lack of fit is primarily caused by the inaccurate assessment of total amount of inventory in the downstream supply chain (Udenio et al., 2012).

Udenio et al. (2012) demonstrated how inventory updates in combination with the underestimation of the supply line create upstream demand volatility. In this thesis, we change the research scope to a commodity polymer producing industry acting one echelon further upstream the supply chain than the upstream echelons in the models of Udenio et al. (2012). Although we do not implement the extra destocking shock in our model, we do build on their modeling effort of single echelon models that account for behavioral decision making and inventory acceleration in the chain (section 4.1).

## 2.4 SHORT RANGE FORECASTING: PRICE DYNAMICS

Last minute noise signals in the form of rationing and shortage gaming, order batching and price fluctuations trigger the additive bullwhip effect in the short range (Lee et al., 1997a; Bray and Mendelson, 2012). Additionally, polymer X industry consultants noticed an increase in the commodity price volatility and observed that price volatility extends deeper into the downstream chain (2011b). In this study, we therefore focus on price dynamics as the noise factor that triggers the additive bullwhip effect in the short range.

Lee et al. (1997a) illustrate how trade promotion pricing can lead to the bullwhip effect, and Blinder (1986) demonstrates that cost shocks increase the volatility of production. Cachon et al. (2007) also find support that price variability, as an indicator for promotion activities as well as cost shocks, contributes to demand amplification upstream the chain. Bray and Mendelson (2012) make the effect of price fluctuations as last-minute shocks apparent: the bullwhips raised by short noticed fluctuations are significant in 97% of the industries considered in their study.

The system dynamics approach used in this study allows us to link price information to the desired inventory coverage of actors in the chain. Subsequently, fluctuations in desired inventory levels will influence the ordering behavior via different feedback structures (Sterman, 1989). We will now underpin the increased influence of the price-demand relation by discussing literature stating that commodity price volatility has recently increased (section 2.4.1), and furthermore discuss how this affects the purchasing strategies of commodity consumers (section 2.4.2).

#### 2.4.1 COMMODITY PRICE VOLATILITY

Commodities are products of uniform quality that are produced in large quantities by many different producers (O'Sullivan, 2003). Since these products are considered to be equivalent, prices are determined on a commodity exchange market and the law of one price applies. The market for commodities is characterized by periods of sharp changes in price and inventory levels (Pindyck, 1994). Pindyck (2004a) adds that volatility of commodities fluctuates over time. A contribution from the UNCTAD secretariat to the G20 Commodity Markets Working Group (2012) indicates that the volatility of commodity prices has increased over the past 50 years. In the period 2003-2012, price volatility was significantly higher than in earlier decades (Pindyck, 2004b; Dvir and Rogoff, 2010). An extensive analysis of commodity volatility by IHS (2011a) provides some insights into the characteristics of the recent period of high volatility. Most price cycles have extended beyond six months. The length of those cycles is caused by the tendency for prices to overshoot in one direction during uncertain times and only when the market develops in a clear direction, prices quickly correct to fundamentally supported levels.

#### 2.4.2 PURCHASING STRATEGIES OF COMMODITY CONSUMERS

Given the high price volatility, key point in the purchasing strategies of commodity consumers is to avoid buying at peak prices. In this thesis, we define three possible ordering tactics for commodity consumers: (1) pre-buying by increasing orders in *speculation* of a further price increase, (2) pre-buying by increasing orders in *anticipation* of a further price increase, or (3) *delayed buying* when the price is high. In the remaining of this section we discuss literature explaining the three possible ordering tactics of commodity consumers. Furthermore, these tactics are used to develop the hypotheses formulated in section 3.1.2.

##### **Pre- or delayed buying**

We first distinguish between the purchasing strategies of privately and non-privately owned customers. We assume that this is caused by differences in the inventory tactics of both types of companies. Niehaus (1989) examined the relation between a firm's ownership structure and its inventory method choice. Specifically, the relation between the inventory tactics and both managerial and outside ownership concentration is examined. The evidence indicated a conflict of interest between managers and shareholders over the inventory method choice with respect to financial accounting. Niehaus (1989) illustrated this with an example of a LIFO inventory method, which is the tax minimizing method (beneficial to the shareholders) but decreases financial reporting results (used for managerial compensation). They showed that the method choice is dependent on the ownership structure of the company.

Walrave et al. (2011) state that when financial performance is decreased (i.e. while companies face a crisis situation) companies with high outside ownership concentration will execute exploitation efforts such as inventory reductions to improve short-term success for shareholders. A possible conflict of interest is solved by aligning the reward structure of the managers with

the shareholders interests. In the long run exploitation efforts affect operating results in a negative way, leading to even more exploitation efforts (success trap) (Levinthal and March, 1993; March, 1991). An example of an exploitation effort is the focus on working capital reduction by applying strict inventory targets. Companies with a higher managerial ownership concentration traditionally have a more long range focus leading to less focus on short-term exploitation efforts. Applying those insights to the different purchasing strategies to avoid buying at peak levels indicates a pre-buying strategy for companies with high managerial ownership, while companies with high outside ownership aim to postpone orders when the price is high. Based on this discussion we assume that privately owned companies will utilize pre-buy opportunities where they anticipate or speculate on a further price increase, while non-privately owned companies will delay orders when the price is high.

### **Price speculation**

We first position polymer X as a commodity at the start of the chain. By including growth dynamics in the standard commodity storage framework (Deaton and Laroque, 1992), Dvir and Rogoff (2010) stated that in the presence of uncertainty regarding the price trend, active stocking behavior in order to speculate on an upward price trend acts to enhance volatility. The reason for this storage behavior is that access to supply is not infinite because key players have limited availability due to inflexible production and low inventories. When demand rises, availability drops and prices will rise. Companies facing this problem will speculate on price raises by increasing their inventories. In line with these findings, Peels et al. (2009) argued that when commodity prices were at record levels in 2008, the speculation on the continuation of this trend led to overstocking in many different industries. They argued that an upwards trend in the price of a commodity has a positive effect on desired inventory levels of customers. In the remainder of this thesis we test whether polymer X consumers speculate on a further price increase.

### **Price anticipation**

When monitoring the price drivers of commodities, it is possible to anticipate on a price increase when a delay in the price pass through from the price drivers to the commodity price exists. Where the transfer of a feedstock price change to the price of the derivative used to take two months, it has shortened, happening as quickly as one month later in recent years. However, this one month delay in combination with high price volatility still holds a pre-buy opportunity. A study of IHS (2011b) furthermore demonstrates that price volatility is extending deeper downstream into the supply chain. This is caused by price triggers, escalator clauses into buyer-supplier contracts and falling inventory levels relative to shipments across industries compared to a decade ago (IHS, 2011b). We will test whether this pre-buy opportunity is utilized by polymer X consumers in the remainder of this thesis.

### 3. RESEARCH CONTRIBUTION: QUESTIONS AND METHODOLOGY

Section 3.1 relates the research questions to the existing theories and models in the scientific domain and specifies the hypotheses to test. This chapter ends with the description of the research methodology in section 3.2.

#### 3.1 RESEARCH QUESTIONS

The aim of this thesis is to improve short and medium range demand forecasting for polymer X on industry level. We accomplish this by identifying the main drivers of both short and medium range demand fluctuations and link the demand drivers to industry demand by developing a system dynamic model of the downstream chain (Figure 2). The literature review indicates that medium range demand fluctuations are based on final consumer demand development and re-active (de)stocking in the supply chain, while price dynamics affect short range demand fluctuations via active (de)stocking decisions in the chain. Combining the problem definition discussed in the introduction with the theories discussed in chapter 2 leads to the following two main research questions of this thesis:

1. Can we improve medium range demand forecasting (horizon 3 to 12 months) for polymer X by a system dynamics model of the downstream supply chain that captures final consumer demand and re-active (de)stocking?
2. Can we improve short range demand forecasting (horizon 1 to 2 months) for polymer X by a system dynamics model that captures active (de)stocking of direct customers triggered by price dynamics?

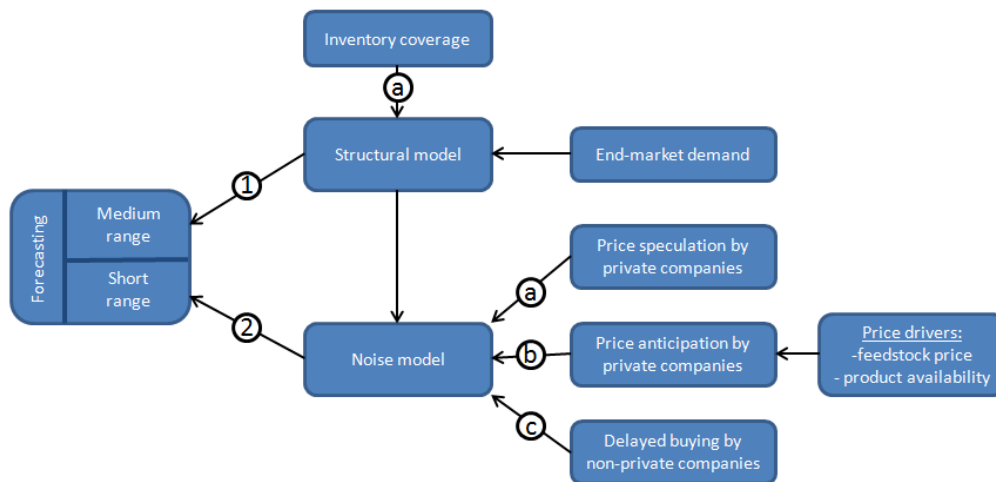

Figure 3. Research plan.

The proposed models describe relationships that have been documented in literature (chapter 2), but much evidence available for those relationships is case-specific. To test and build confidence in the model as a whole, we need to assess individual demand driver – demand relations as well as the model performance as a whole (Oliva and Sterman, 2001).

The research questions can be assessed by either a process or a hypotheses approach. The process approach explains how the interplay between different factors in a system works, but does not assess the direct relation between variables. On the other hand, a hypothetical approach is used to statistically test relations between factors in a system. Since we search for specific



relations between the demand drivers (e.g. price and supply chain dynamics) and the demand waves, we use a hypothetical approach where we test individual relations. We will furthermore discuss how these relations develop over time in order to improve the demand signal interpretation. Figure 3 visualizes the research questions (1 and 2) and the hypotheses (1a+2a-2c) to test.

### 3.1.1 MEDIUM RANGE FORECASTING

In order to improve the demand signal interpretation of medium range demand dynamics we analyze the amount of inventory in the downstream chain. Industry consultants have reported massive destocking in and minor restocking after the 2008 credit crisis in polymer supply chains. Since overall polymer industry demand is compared to GDP development, industry consultants did not specifically assess polymer X demand or its end market. We therefore question to what extent destocking has taken place in the downstream supply chain of polymer X (Figure 2) and if this destocking is caused by a reduction of final consumer demand or by a reduction of the inventory coverage in the chain. A structural decrease of inventory coverage in the chain is a cause of the bullwhip effect and thereby affects the relation between final consumer and industry demand. We therefore test the following hypothesis:

- 1a. The average inventory coverage in the downstream supply chain of polymer X is decreased over the measurement period.*

### 3.1.2 SHORT RANGE FORECASTING

The hypotheses underlying the price-active (de)stocking relation are now discussed. Based on the theoretical discussion in chapter 2 we assume that the purchasing strategies of direct customers depend on their ownership structure: companies with high managerial ownership (privately owned) pre-buy polymer X either in speculation of a further price increase (hypothesis 2a) or in anticipation of a price increase (hypothesis 2b), whereas companies with high outside ownership (non-privately owned) delay their orders when the price is high and thereby reduce their inventory position (active destocking) in times of high prices (hypothesis 2c).

#### **Price speculation by privately owned customers**

We first position polymer X as a commodity at the start of the chain. It is hypothesized that active stocking behavior is a result of pre-buying by speculating on a further price increase of polymer X. We test whether customers speculate on a further price peak by increasing their inventories as soon as the price of a commodity starts to rise and product availability drops.

- 2a. Speculation on the continuation of an upward trend in the price of polymer X leads to active stocking behavior by privately owned customers.*

#### **Price anticipation by privately owned customers**

We next position polymer X as a derivative of its feedstock and include product availability and feedstock price as its main price drivers. The hypothesis for the relation between price and stocking behavior of privately owned customers is that the stocking decision is triggered by a pre-buying opportunity (price anticipation) due to a delay in the price pass through of the price drivers (IHS, 2011a).

- 2b. A price anticipation opportunity caused by a delay in the price pass through of the polymer X price drivers triggers active (de)stocking by privately owned customers.*

### Delayed buying behavior by non-privately owned customers

In section 2.4.2 we elaborated on the difference between companies with high managerial ownership (private companies) and companies with high outside ownership (non-private companies). The later companies focus on exploitation efforts to improve short-term success while facing a crisis situation (Walrave et al, 2011). An example of an exploitation effort is the focus on working capital reduction by applying strict inventory level targets. We therefore hypothesize that non-privately owned customers delay their orders when the price is high.

*2c. Non-privately owned customers choose a riskless buying strategy where they delay orders when the price is high.*

## 3.2 RESEARCH METHODOLOGY

To solve research question (1) and (2) we construct a forecasting tool based on system dynamics. The model consists of a structural and a noise part. The structural part models the effect of end market dynamics on industry demand in the absence of active (de)stocking. The noise part models the additive bullwhip effect: active (de)stocking decisions in the chain based on price dynamics.

The structural part consists of all downstream echelons, which are individually modeled based on the standard one echelon model of Udenio et al. (2012). After that, constructing a supply chain is a matter of arranging a series of echelons and initializing the parameters in order to mimic the structure of the supply chain we are analyzing (Figure 2). The noise part adds the price – active (de)stocking relation to the model. The model will be implemented as a tool in Vensim DSS. The model and its implementation are validated on historical data of polymer X industry demand. We furthermore test different scenarios to increase demand signal interpretation. We end this thesis with guidelines for commercial and supply chain decision making and an overview of the general conclusions and directions for future research.

The research design to address the research questions is depicted in Figure 4.

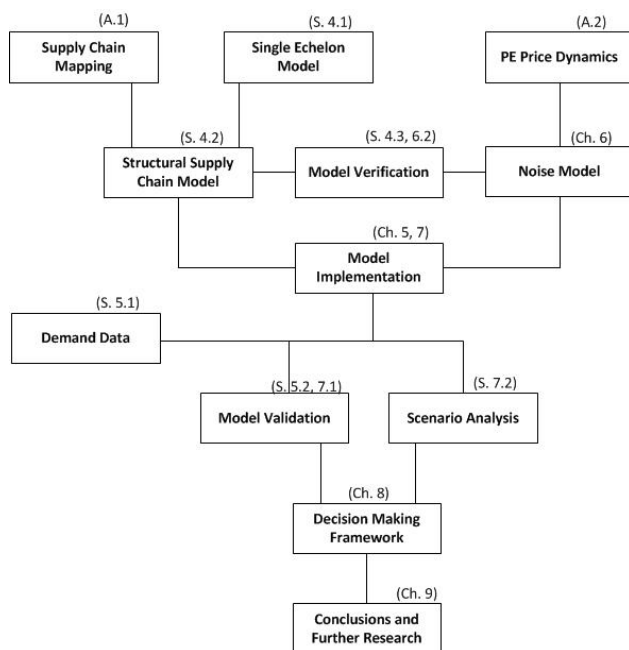

Figure 4. Research design.



## 4. STRUCTURAL MODEL: SUPPLY CHAIN DYNAMICS

The goal of this section is to develop a structural model of the downstream supply chain. We first present the formal single echelon model in section 4.1. From there, constructing a supply chain is a matter of arranging a series of echelons and initializing the parameters (section 4.2). We complete this chapter with the verification of the model and the conclusions.

### 4.1 SINGLE ECHELON MODEL

The single echelon model is a straightforward extension of Sterman's managerial decision making, and supply chain model (Sterman, 2000). Conceptually, single echelon models represent individual tiers: a group of competing companies providing the same product to the same supply chain. This is equivalent to what Sprague and Wacker (1996) and Blinder and Maccini (1991) call modeling inventories with a "disaggregation by stages along the inventory stream". The current analysis is therefore grounded in mesoeconomics. The single echelon model used for this study is similar to the model developed by Udenio et al. (2012).

The single echelon model consists of three sectors (Figure 5): the forecasting section tracks the incoming customer orders and develops the echelon sales forecast. The production section models the physical flow of goods and determines the required material replenishment orders and the delivery section keeps track of deliveries and the remaining backlog. The model assumes that sales is never lost and is based on a continuous time system dynamics simulation with a time interval of one week.

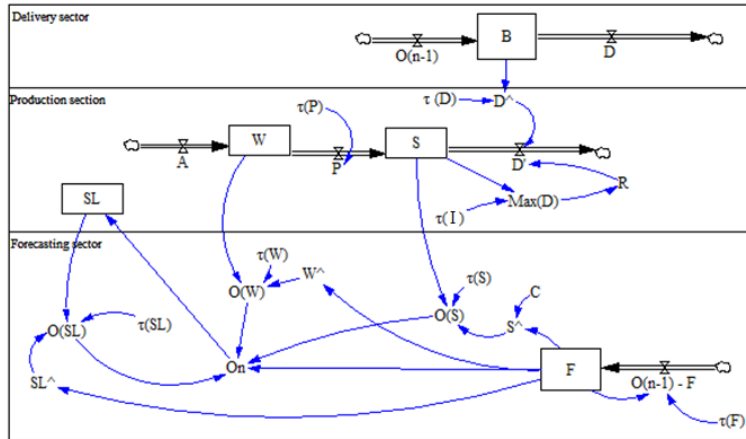

Figure 5. Overview of a single echelon model

Table 2. Definition of model parameters

$F_n$	sales forecast at echelon n	$\bar{S}L_n$	desired supply line at echelon n
$O_n$	order placed by echelon n	$\tau_n(S)$	finished goods adjustment fraction at echelon n
$\tau_n(F)$	forecast adjustment fraction at echelon n	$\tau_n(W)$	work in process adjustment fraction at echelon n
$A_n$	incoming material at echelon n	$\tau_n(SL)$	supply line adjustment fraction at echelon n
$D_n$	deliveries from echelon n	$\tau_n(I)$	The minimum time to fill orders at echelon n
$L_n$	incoming delivery lead time echelon n	$\tau_n(D)$	The expected delivery delay at echelon n
$SL_n$	supply line at echelon n	$O_n(S)$	finished goods adjustment at echelon n
$W_n$	work in process stock at echelon n	$O_n(W)$	work in process adjustment at echelon n
$P_n$	production rate of echelon n	$O_n(SL)$	supply line adjustment of orders at echelon n
$\tau_n(P)$	production time of echelon n	$B_n$	backlog at echelon n
$S_n$	on hand stock at echelon n	$R_n$	delivery ratio echelon n
$\hat{S}_n$	desired on hand inventory at echelon n	$\bar{D}_n$	desired delivery rate echelon n
$\hat{C}_n$	desired on hand inventory coverage at echelon n		

## Forecasting

The forecasting sector maintains a sales forecast by accumulating the differences between the incoming customer demand ( $O_{n-1}$ ) and the previous forecast ( $F$ ). When demand exceeds the forecast it's updated upwards and vice-versa. To allow for a smoothing of the forecast, these differences are multiplied by the forecast adjustment rate ( $\tau(F)$ ) indicating whether the whole difference or only a fraction is taken into account. The forecast method used is similar to exponential smoothing, where the smoothing constant  $\alpha$  is similar to the forecast adjustment rate.

$$\left(\frac{d}{dt}\right)F_n^t = (O_{n-1}^t - F_n^t)\tau_n(F) \quad (1)$$

## Production

The production sector models the flow of material through the echelon. The incoming material rate ( $A$ ) is equal to the sum of the delivery rates of the upstream echelons ( $D_{n+1}$ ),

$$A_n^t = D_{n+1}^{t-L_n} \quad (2)$$

The supply line is the cumulative difference between orders placed and orders received,

$$\left(\frac{d}{dt}\right)SL_n^t = O_n^t - A_n^t \quad (3)$$

Incoming material is stored as work in process ( $W_n$ ) (4). In the interest of simplicity we do not model any production release rule. The production rate is modeled based on the order arrival rate and a fixed delay equal to the production time ( $\tau(P)$ ). System dynamics modeling allows for the introduction of this discrete step in the model, which approximates the real production process,

$$\left(\frac{d}{dt}\right)W_n^t = A_n^t - P_n^t \quad (4)$$

$$P_n^t = \frac{W_n^t}{\tau_n(P)} \quad (5)$$

Equation 5 assumes a production model where the manufacturing time is independent of the utilization rate. It also implicitly assumes that there are no (temporary) capacity limitations for production. On hand inventory ( $S$ ) depends on the delivery rate ( $D$ ) and the production rate ( $P$ ),

$$\left(\frac{d}{dt}\right)S_n^t = P_n^t - D_n^t \quad (6)$$

Material orders are based on an anchor and adjustment heuristic (Tversky and Kahneman, 1974): the sales forecast acts as the anchor, with the adjustment stemming from the difference between actual and target stock, production and supply line levels. To calculate the target stock, we start with the desired on hand inventory coverage measured in time units ( $\hat{C}$ ). When this is multiplied by the sales forecast, we obtain the desired on hand stock ( $\hat{S}$ ) in units of product. In chapter 6, the desired on hand inventory coverage ( $\hat{C}$ ) will be linked to price dynamics.

$$\hat{S}_n^t = \hat{C}_n^t F_n^t \quad (7)$$

Analogously, the desired supply line level  $\hat{S}\hat{L}$  and a desired work in process level  $\hat{W}$  consist of the multiplication of the delay and the forecasted volumes,

$$\widehat{SL}_n^t = L_{n+1}F_n^t \quad (8)$$

$$\widehat{W}_n^t = \tau_n(P)F_n^t \quad (9)$$

Once we have calculated the desired levels of supply line, in process and on-hand inventories, we generate adjustment orders with the purpose of closing the gap between the actual values of these inventories, and their desired (target) levels. The finished goods inventory leveling ratio ( $\tau(S)$ ), the work in process leveling ratio ( $\tau(W)$ ) and supply line leveling ratio ( $\tau(SL)$ ) represent the part of the difference between current and desired level that is corrected for in this period. These leveling ratios model the behavioral aspect of the order generation. High ratios imply a nervous buying behavior whereas low leveling ratios are equivalent to a smooth ordering strategy. We define the stock adjustment orders (O(S)), work in process adjustment orders (O(W)) and supply line adjustment orders (O(SL)) as,

$$O_n^t(S) = \tau_n(S) * (\widehat{S}_n^t - S_n^t) \quad (10)$$

$$O_n^t(W) = \tau_n(W) * (\widehat{W}_n^t - W_n^t) \quad (11)$$

$$O_n^t(SL) = \tau_n(SL) * (\widehat{SL}_n^t - SL_n^t) \quad (12)$$

Equations 10, 11 and 12 calculate the difference between desired and actual values and spread these in equal parts over the amount of periods specified by the leveling times. Finally, generated orders (O) is expressed as,

$$O_n^t = \max \{0, F_n^t + O_n^t(S) + O_n^t(W) + O_n^t(SL)\} \quad (13)$$

### Delivery

Customer orders (O) accumulate in a backlog (B) until they are processed. The backlog is reduced by the order delivery rate (D). Note that according to our naming convention, echelon n will generate orders  $O_n$  and will receive orders  $O_{n-1}$  from its customers.  $O_0$ , the demand observed by the echelon closest to the end market, is end market demand input to the model.

$$\left(\frac{d}{dt}\right)B_n^t = o_{n-1}^t - D_n^t \quad (14)$$

The order delivery rate (D) is the rate of product that is actually shipped out in response to a customer order. To calculate this, we first define the desired delivery rate ( $\widehat{D}$ ), which is equal to current backlog divided by the expected delivery delay ( $\tau(D)$ ),

$$\widehat{D}_n^t = \frac{B_n^t}{\tau_n(D)} \quad (15)$$

The maximum delivery rate ( $\max(D)$ ) per period is equal to the total stock available to ship in the period. This quantity depends on the ability of firm to physically prepare the products for shipment, modeled as the minimum time to fill orders ( $\tau(I)$ ),

$$\max(D)_n^t = \frac{S_n^t}{\tau_n(I)} \quad (16)$$

We calculate the delivery ratio (R) as the proportion of outstanding orders that can be shipped from stock,

$$R_n^t = \min \left\{ 1, \frac{\max(D)_n^t}{\widehat{D}_n^t} \right\} \quad (17)$$

Finally, the actual order fulfillment rate is equal to the desired delivery rate multiplied by the delivery ratio,

$$D_n^t = \widehat{D}_n^t R_n^t \quad (18)$$

Alternatively, we can combine equations 15 to 18 and define the order fulfillment rate as:

$$D_n^t = \min \left\{ 1, \frac{S_n^t}{B_n^t} \right\} B_n^t \quad (19)$$

## 4.2 STRUCTURAL SUPPLY CHAIN MODEL

The echelon model captures the dynamics of entire supply chains by explicitly modeling the operational and behavioral aspects of ordering decisions made within each individual stage in the chain. Methodologically, a supply chain model is constructed by linking individual echelon models (section 4.1) through successive customer/supplier relationships. We enumerate echelons downstream to upstream: the most downstream echelon being 1 and the most upstream N. In the case of diverging supply chains, where one echelon can potentially have several direct customers, we introduce a second indices (a or b) indicating the existence of other parallel echelons in the supply chain. The structure of the downstream supply chain and end market of polymer X is introduced in section 1.1. Based on the findings of Chen and Lee (2012) we decided to use seasonal adjusted end market data, since companies anticipate on predictable seasonal patterns by production smoothening.

In this section the parameters of the chain are initialized. The input parameters are categorized in two different groups: observable and behavioral parameters. Where behavioral parameters represent information delays, structural parameters represent material delays.

### Observable parameters

The observable parameters represent stocks and flows. In an attempt to simplify the model, we assume that lead times are deterministic and that the companies involved have enough resources such that order preparation does not introduce any lag. Thus, the expected delivery delay  $\tau_n(D)$  is equal to the lead time ( $L_n$ ), and the minimum time to fill orders ( $\tau_n(I)$ ) is equal to one week. The inventory is divided between the work in process (raw material inventory plus production) and finished goods inventory. Based on industry benchmark reports, the average inventory coverage of the polymer X industry is 5 weeks: one week for production and four weeks for average finished goods inventory. The inventory coverage of companies in the downstream chain is estimated by calculating the inventory turnover ratio from the public reports from the companies that are listed on the stock market (Table 3). The transfer time of a product from the financial account of the seller to the financial account of the buyer is assumed to be one week. Hence, all lead times between echelons are initiated at one week. The estimated parameter values are shown in Figure 6.

Polymer processor	Coverage (in weeks)	Brand owner	Coverage (in weeks)	Retailer	Coverage (in weeks)
#1	7	#1	9	#1	6
#2	8	#2	10	#2	3
#3	8	#3	10	#3	3
#4	8	#4	6	#4	5

**Table 3. Inventory coverage downstream chain.**

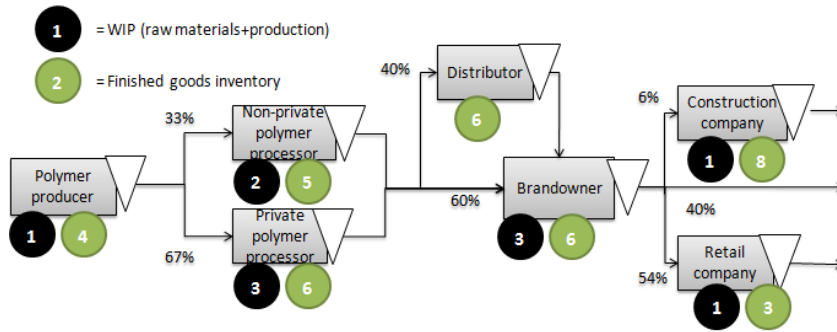

**Figure 6. Observable parameters downstream chain.**

## Behavioral parameters

Every echelon model consists of a set of four behavioral parameters: the forecast, finished goods inventory, work in process and supply line adjustment fractions. The behavioral parameters indicate the part of the difference between current and desired level that is corrected for in the current period. The settings of the behavioral parameters have an effect on the multiplicative bullwhip. Values closer to 0 indicate a lower sensitivity of firms towards differences between expected and realized demand or stock levels. As discussed in Oliva (2003) behavioral parameters need to be calibrated. Oliva points out that a good historical fit does not confirm dynamic hypotheses; the model has to match observations for the right reasons.

The behavioral parameters of our structural model have not been calibrated against realized demand data since we have used the calibrated behavioral parameter values identified by Udenio et al. (2012). In their study, they optimized the model fit of four different supply chain models by calibrating the four behavioral parameters. Applying industry specific parameter values in a different supply chain increases the possibility to generalize behavioral parameter values across supply chains. Specifically, this would indicate that industries (i.e. groups of competing companies providing the same product) have a similar sensitivity to demand signals that does not depend on supply chain characteristics. This can however only be concluded when our model fit shows accurate results.

Udenio et al. (2012) showed that both the work in process and supply line leveling ratios are small, indicating the fact that on average companies do not take the amount of work in process or supply line inventory into account (i.e. referred to as supply line underestimation). The values for  $\tau(\text{SL})$  and  $\tau(\text{W})$  are therefore independently of the echelon number initialized at 0.001. We furthermore initiate the values for the finished goods inventory adjustment fraction ( $\tau(\text{S})$ ) and the forecast adjustment fraction ( $\tau(\text{F})$ ) in accordance with the study of Udenio et al. (2012) (Table 4). The initial value for the forecast adjustment fraction for both private and non-private polymer processors is the only exception to this decision. An initial survey among industry account managers led to the observation that polymer processors respond to stock updates instead of forecast updates. They manage the absolute value of the stock. We therefore initiated the forecast adjustment fraction at 0.01 instead of 0.1.

Echelon	$\tau(\text{F})$	$\tau(\text{S})$
Polymer producer	0.1	0.1
Private polymer processor	0.01	0.1
Non-private polymer processor	0.01	0.1
Distributor	0.25	0.25
Brand owner	0.1	0.1
Construction company	0.001	0.25
Retail company	0.001	0.25

**Table 4. Initial values behavioral parameters.**



### 4.3 VERIFICATION

In this section we study whether the model and its implementation in Vensim DSS correctly measures what we want to measure. By performing a number of verification tests we assess whether the multiple echelon supply chain model is correctly derived from the single echelon model.

By a single pulse shock on a stable end market demand, the dynamics of the structural model can be assessed in isolation. Figure 7 shows the total supply chain bullwhip triggered by a 10%-reduction in final consumer demand. The difference between industry and final consumer demand corrected by the temporary built up of inventory as a result of an information delay is the amount of inventory taken out of the chain caused by inventory target updates. Next, we compare the structural model output to real end market demand realization (Figure 8). The multiplicative bullwhip effect caused by inventory updates is clearly observed. The timing of the first dip in polymer X industry demand after the 2008 credit crisis is two months delayed compared to the dip in end market demand. Moreover, the amplitude of the wave is increased with a factor of 1.5.

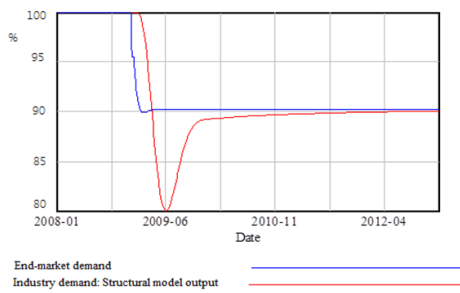

**Figure 7. The multiplicative bullwhip effect: single pulse analysis.**

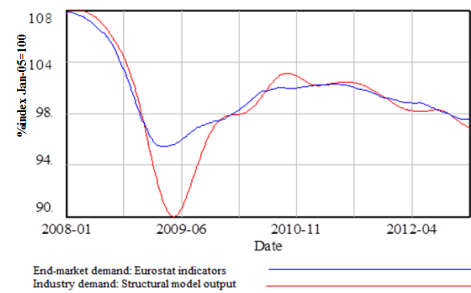

**Figure 8. Verification structural model.**

Most important in the verification of system dynamics models is the assessment of the robustness of the models. We therefore perform a sensitivity analysis for three different parameters between the estimated boundaries of those parameters: (1) behavioral parameter: forecast adjustment ratio, (2) observable flow parameter: flow ratio distributor, and (3) observable stock parameter: polymer processors stock coverage.

A Monte Carlo sensitivity analysis (2000 simulation runs, uniform distributed) is performed. From Figures 9 to 11 is learned that the model is robust. A sensitivity analysis of the desired stock coverage for both private and non-private polymer processors (between 1 and 10 weeks) has only a small effect on the supply rate of the polymer X producers. Simulating a change in the demand ratio for distributors between 0 and 1 (currently 0.4) has a larger effect on the amplitude of the demand wave than on the timing. This is explained by the higher forecast and inventory adjustment ratios of distributors compared to the other echelons in the chain. Finally, a sensitivity analysis of the forecast adjustment ratio for both types of polymer processors indicates that increasing this parameter will increase the amplitude and will accelerate the timing of the demand wave. The amplitude of the dip caused by the 2008 credit crisis changes only three percent points when the forecast adjustment ratio is increased from 0.01 to 0.25 (Figure 11). This indicates that the model is robust to changes in the behavioral input parameters.

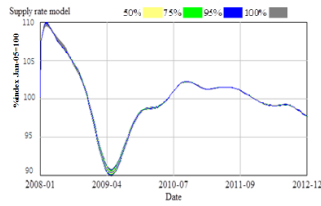

**Figure 9: Sensitivity analysis of stock coverage direct customers.**

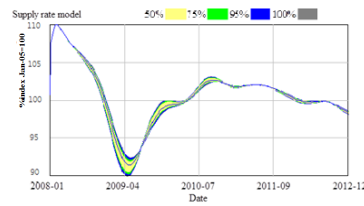

**Figure 10: Sensitivity analysis of flow ratio distributor.**

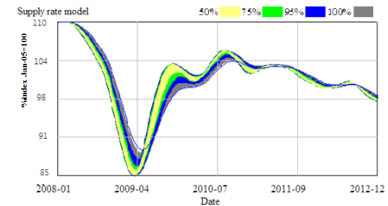

**Figure 11: Sensitivity analysis of forecast adjustment ratio direct customer.**

#### 4.4 CONCLUSIONS

This chapter elaborated on the development of the structural model of the downstream supply chain for polymer X in the EU27. The supply chain structure and parameter settings are based on data from industry consultant reports and previous research by Udenio et al. (2012). The verification step indicated robust model results to changes in behavioral and observable parameters in the medium term. We noticed that the amplitude of the bullwhip effect observed by the polymer producer is less strong than expected. Hence, the difference between the final consumer demand dip after the 2008 credit crisis and the upstream demand dip is a factor 1.5. The timing of the dip is delayed with two months compared to the dip in final consumer demand. This will create opportunities for upstream producers to anticipate on a dip in end market demand in the future. This can however only be concluded after validating the model results against industry demand data. The historical fit and validation of the model output on industry demand data and the test of hypothesis 1a related to the decrease in average inventory in the chain will be discussed in section 5.



## 5 STRUCTURAL MODEL RESULTS

After developing a model of the downstream chain we validate the structural model in order to answer research question 1. In section 5.1 we will discuss the industry demand data used for this analysis, subsequently the model validation procedure is discussed. Then, we elaborate on the validation results and end this chapter with the major conclusions.

### 5.1 DEMAND DATA

Demand for polymer X is based on total industry demand in the EU27. An important design decision related to demand data is whether to take the perspective of industry sales or downstream demand. Since our model predicts the local downstream demand based on end market data, we take the demand perspective. We therefore have to correct EU27 industry sales for polymer X for import and export. The trading balance (EU27 export – EU27 import) (Figure 12) and industry demand are based on monthly industry data reported by industry consultants. Note that the month to month volatility of the trading balance is high; indicating a large effect on monthly normalized seasonal corrected demand data for polymer X (Figure 13).

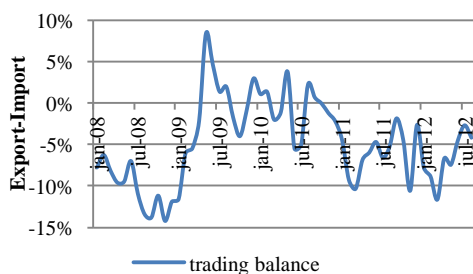

Figure 12. Trading balance polymer X.

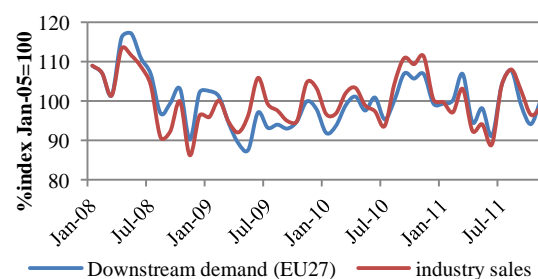

Figure 13. Industry sales and downstream demand.

### 5.2 STRUCTURAL MODEL VALIDATION

Estimating the model parameters and model validation cannot be performed on a single data set. We therefore split the data in a model fit and a model validation period. Industry demand data is available from January 2008 till December 2012. Demand data till December 2011 is used for fitting the model, and data over 2012 is used for validation. The validation procedure is further explained in section 5.2.1 and the results are discussed in section 5.2.2.

#### 5.2.1 VALIDATION PROCEDURE

The parameters values for the structural model are based on external information (section 4.2). Hence, the historical fit can be analyzed over the model fit (i.e. real end market demand data) as well as the validation period (i.e. estimated end market demand data linked to GDP forecast).

The hypotheses approach used in this study (chapter 3) asks for statistically estimating the effect of individual relations on the model performance (chapter 6). Furthermore, the behavior of the full models is compared to the available polymer X industry demand data. Performance measurement of our models is in accordance with the study of Oliva and Sterman (2001) that used a system dynamic approach to test different individual relations in the service industry and to assess how these relations influence the overall level of service companies deliver. We use the following historical fit statistics to assess the quality of our models:

- 1) *Root mean square error (RMSE)*: measurement of the differences between values predicted by a model and the realized values. This measurement is scale dependent and emphasizes on data points which differ a lot from the realized values.

- 2) *Coefficient of determination ( $R^2$ )*: indicator of how well the model predictions fit the data set. It indicates the proportion of variability accounted for by the model.
- 3) *Theil's inequality statistics*: decomposition of the MSE into three components: bias ( $U^m$ ), unequal variation ( $U^s$ ) and unequal co-variation ( $U^c$ ). It thereby separates the systematic error from unsystematic random differences between the model predictions and the actual data. This statistics helps in localizing the source of error.

### 5.2.2 VALIDATION RESULTS

#### Model fit

The results of the model fit are first discussed (Figure 14). Later we will compare the results of the validation period to the results of the model fit. The structural model parameters are based on external input (section 4.2). The structural model accounts for 53 percent of the demand variability and the RMSE is 4.08 (Table 5). Theil's inequality statistics indicates a minor systematic error between the mean and trend of the structural model and the demand realization ( $U^m=.0210$ ,  $U^s=.1909$ ). The model therefore accurately tracks actual data except for an unsystematic error term with zero mean. Hence, the model only differs from the data on a point by point basis.

Since the structural model accurately fits actual demand realization, we confirm that the timing of the polymer X industry demand dip as a result of the 2008 credit crisis is two months delayed compared to the dip in final consumer demand (as discussed in section 4.3). This delay is however not observed on the quarterly demand level. The effect of the multiplicative bullwhip as a result of the 2008 credit crisis is quantified by comparing the quarterly average final consumer demand drop from 2008Q2 to 2009Q2 to the drop in industry demand. Where final consumer demand dropped with 9 percent, polymer X industry demand dropped with 14 percent. Finally, average yearly demand from 2008 till 2010 shows a good fit for the amplitude of the demand dip following the 2008 credit crisis (max error = .7%) (Table 6).

We however need to make one remark on the model fit; Actual demand realization over 2011 is 1.5 percent lower than the model output, indicating a demand loss in the chain not accounted for by the structural model. The noise model discussed in section 7 will explain this difference.

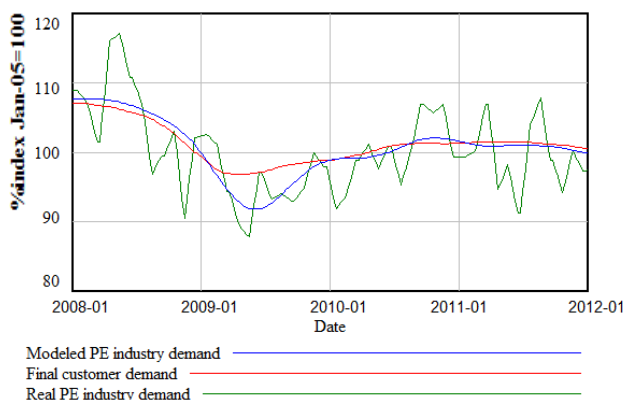

Figure 14. Structural model fit.

#### Model validation

End market demand forecasts for 2012 are input for the model validation. Forecasts are based on the December 2011 GDP forecast for 2012 (-0.3%). The fit indices for the structural model indicate a worse fit for the validation model compared to the model fit (RMSE: 6.77 (+66%),  $R^2$ : .01 (-99%)) (Table 5). The bias term of Theil's inequality statistics ( $U^m=.0451$ ) indicates a

poor level fit of the structural model for 2012 (i.e. average model output is 1.5 percent higher than realized demand). Furthermore, the structural supply chain model does not capture short range demand variability in 2012 ( $U^s=.8116$ ). We observe demand cycles in the actual demand data over 2012, which are not accounted for by the model. Since the model purpose is to predict the cycles in the data, this is a systematic error. We assess the systematic error by the noise model where the price effect is added to the structural model.

Structural model	Model fit	Model validation
RMSE	4.08	6.77
$R^2$	.53	.01
$U^m$	.0210	.0451
$U^s$	.1909	.8116
$U^c$	.7882	.1433

Table 5. Structural model fit.

Average	Model	Actual	Difference
2008	105.75	105.02	.7%
2009	95.26	95.52	-.3%
2010	100.54	100.09	.4%
2011	100.87	99.42	1.5%
2012	98.66	97.22	1.5%

Table 6. Yearly average demand.

## Bullwhip

Fransoo and Wouters (2000) define the total supply chain bullwhip as the coefficient of variation of the upstream demand faced by the polymer producer divided by the coefficient of variation of final consumer demand. The total bullwhip effect in the chain under study is 2.60 over the measurement period (section 3.1). The multiplicative supply chain bullwhip explained by this model over the same period is 1.47. Specifically, the bullwhips on a single echelon level for both types of polymer producers are 1.13 for non-privately owned companies and 1.15 for privately owned companies. We will further assess the measurement of the bullwhip effect in chapter 7, when we add the noise factors to the model.

## Inventory in the downstream chain

In order to improve the demand signal interpretation of medium range demand dynamics we analyze the amount of inventory in the downstream chain. Based on industry consultant reports we hypothesized (1a) that the average inventory coverage in the polymer supply chain is reduced (IHS, 2011a). We use real end market demand for 2012 for this analysis. The average amount of inventory in the downstream chain in the second half of 2012 is estimated to be 6 percent lower than the average inventory in the first half of 2008. However, end market demand reduced with 6 percent in this period indicating stable inventory coverage of around 26 weeks of sales in the chain (Figure 15). This is an expected result of the structural model since we did not change the target inventory coverage parameters in the chain. The question however remains if the model results are a good approximation of actual average yearly demand. Table 6 shows a misfit of average yearly demand between the model output and the actual industry demand in 2011 and 2012 (both 1.5%). This indicates a reduction of the total inventory coverage in the chain. We will further elaborate on this topic and assess hypothesis 1a in chapter 7.

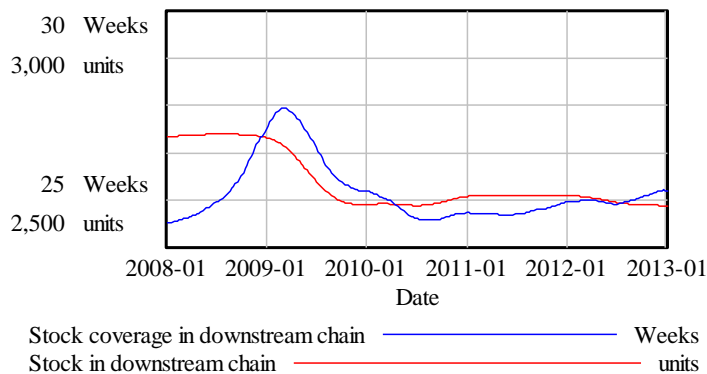

Figure 15. Stock in downstream chain.

### 5.3 CONCLUSIONS

The structural supply chain model is developed to answer research question 1. In this section we demonstrated that the structural supply chain model can be used to predict average demand development for polymer X. The model performance over the period 2008 till 2011 indicated a  $R^2$  of 53% and a RMSE of 4.08. Theil's inequality statistics showed that the remaining error is mainly caused by point by point differences between the model predictions and the actual data. We showed that the timing of the demand dip as a result of the 2008 credit crisis delayed two months from downstream end market to upstream industry demand. Additionally, the amplitude of the first dip increased with a factor 1.5 due to supply chain dynamics.

By extrapolating this system dynamics model, structural demand development can be forecasted based on end market demand forecasts (GDP related). We showed that demand volatility in 2012 is not caused by final consumer demand and re-active (de)stocking. In the remainder of this thesis we will show that short range demand waves are caused by price dynamics.

Finally, we found an indication to accept the hypothesis that the average inventory coverage in the chain is decreased. We noticed a misfit in average demand over recent years, where the model output is on average above the demand realization (1.5 percent for 2011 and 2012). This indicates active destocking in the chain, and increases demand signal interpretation of end market signals with a long information lead time. We will account for this misfit in chapter 7.

## 6 NOISE MODEL: PRICE DYNAMICS

The goal of this section is to add the effect of price dynamics to the structural supply chain model. The price-demand relation is mediated by inventory tactics: we assume that price triggers active (de)stocking in the chain.

### 6.1 MODELING PRICE EFFECTS

The aim of this section is to formally add the price-(de)stocking relations to the structural model discussed in chapter 4 and validated in chapter 5. In the discussion of the research questions in section 3.1 three different hypotheses are formulated. From a price perspective we either use the actual polymer X price or the next month forecast for the polymer X price based on the price drivers. A multivariate time-series analysis led to the following forecasting model for the price:

$$\left(\frac{d}{dt}\right)\hat{P}_t = .423\left(\frac{d}{dt}\right)FS_{t-1} + .515\left(\frac{d}{dt}\right)PA_{t-1} + .107\left(\frac{d}{dt}\right)AU_{t-2} \quad (1)$$

This price effect is included in the ordering decision of customers via the desired inventory coverage ( $\hat{C}_n^t$ ). The desired stock coverage is multiplied by a stock effect ( $E_n^t$ ),

$$\hat{C}_n^t = \text{stock coverage}_n * (1 + E_n^t) \quad (2)$$

The speculation option (3) for private polymer processors (hypothesis 2a) links the derivative of the price ( $\left(\frac{d}{dt}\right)P_t$ ) to the stock effect ( $E_n^t$ ) by multiplying it with the stock adjustment factor. The anticipation option (4) (hypothesis 2b) links the derivative of next month's price forecast ( $\left(\frac{d}{dt}\right)\hat{P}_{t+1}$ ) to the stock effect ( $E_n^t$ ),

$$E_n^t = \left(\frac{d}{dt}\right)P_t * dASE_n \quad (3)$$

$$E_n^t = \left(\frac{d}{dt}\right)\hat{P}_{t+1} * \text{prebuy } dASE_n \quad (4)$$

The stock effects for the delayed buying opportunity (hypothesis 2c) is dependent on the price at time t,

$$E_n^t = (P_t - 1) * ASE_n \quad (5)$$

**Table 7. Definition parameters noise model.**

$P_t$	Price at time t
$\hat{P}_t$	Price forecast at time t
$FS_t$	Feedstock price at time t
$PA_t$	Product availability at time t
$AU_t$	Asset utilization at time t
$E_n^t$	Stock effect for echelon n at time t
$\text{prebuy } dASE_n$	Stock adjustment factor based on derivative of price forecast for echelon n
$dASE_n$	Stock adjustment factor based on derivative of price for echelon n
$ASE_n$	Stock adjustment factor based on price for echelon n

### 6.2 THE PRICE-(DE)STOCKING RELATION

Chapter 5 showed that medium range demand development for polymer X is influenced by end market demand. In addition, the polymer X price has a large impact on the purchasing behavior of customers (Figure 16). The magnitude of the price effect has recently increased due to high feedstock price volatility that extends deeper into the downstream supply chain (IHS, 2011a). In



this section we test three hypothetical relations between the (perception of) the price and active (de)stocking by actors in the chain. For now, we only focus on the timing of the demand waves.

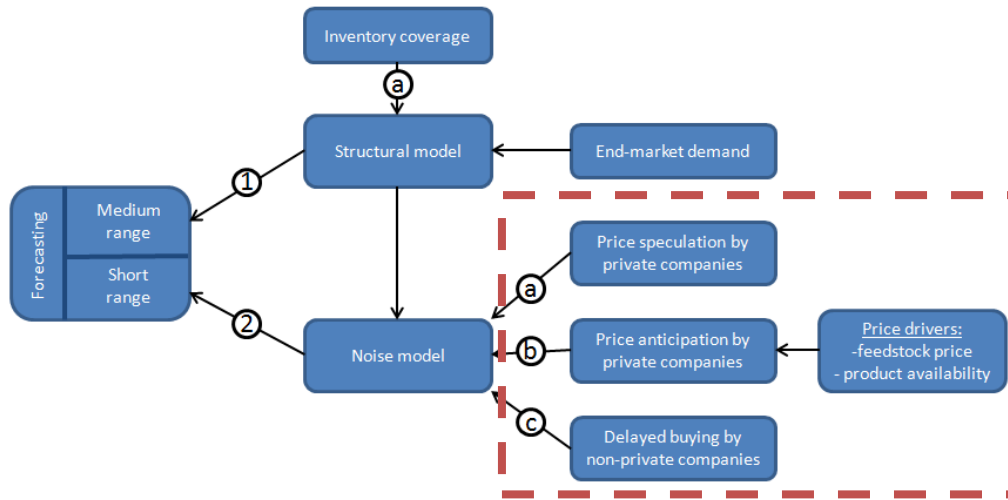

Figure 16. Price-(de)stocking hypothesis.

### 6.2.1 PRICE SPECULATION BY PRIVATELY OWNED CUSTOMERS

The first hypothesis to test is whether or not privately owned polymer producers speculate on a further price increase by increasing their inventories. Dvir and Rogoff (2010) state that stocking behavior in order to speculate on an upward price trend acts to enhance price volatility. Due to the inflexible production and low inventory levels of polymer X producers, extra demand will reduce the product availability and thereby increase the margin component of the price.

The price speculation effect, mathematically formulated in section 6.1, is visualized in Figure 17. The desired inventory coverage is linked to the price level, which implies that the change in the desired stock coverage is equal to the price change. Via the stock adjustment order ( $O_n^t(S) = \tau_n(S) * (\hat{S}_n^t - S_n^t)$ ) the impact on orders is calculated. The increase in orders is maximal when the price is minimal and the desired inventory coverage is maximal at the point of inflexion of the price. Next, the timing of the demand waves caused by this effect is tested. We do this by introducing a positive value for the stock adjustment factor of privately owned customers that is based on the derivative of the price (dASE).

The results of a Monte Carlo sensitivity analysis of the dASE parameter (2000 runs, uniform distributed between 0 and 10) are compared to the actual industry demand realization in Figure 18.  $dASE_{pri.conv}=10$  indicates that an increase of x% of the price will result in an x% increase in the desired inventory coverage in one week. Adding price speculation slightly improves the statistical model fit over the measurement period illustrated by a decrease of RMSE of 3 percent and a 6 percent improvement of the  $R^2$ . However, the visual model fit (Figure 18) indicates worse fit results for the timing of the demand waves since the timing of demand peaks is often delayed (e.g. 2008Q2, 2011Q1 and 2012Q3). In the next section we will assess the price anticipation option, hereafter we will conclude whether to accept the price speculation (2a) or the anticipation (2b) hypothesis.

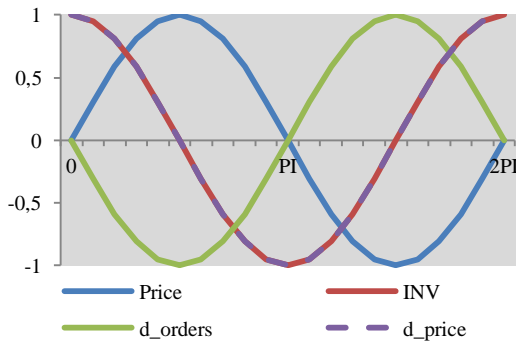

Figure 17. Pre-buying on actual price (dASE>0).

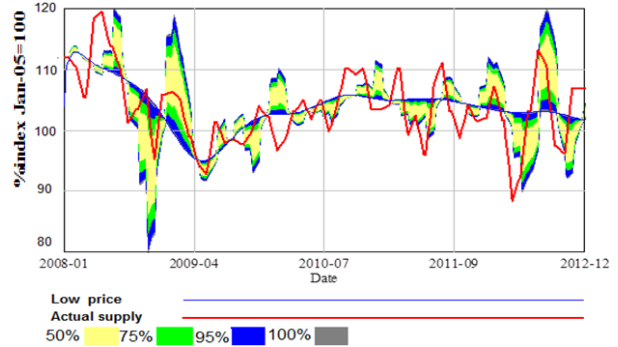

Figure 18. Effect of pre-buying on actual price.

### 6.2.2 PRICE ANTICIPATION BY PRIVATELY OWNED CUSTOMERS

The alternative approach is that customers anticipate on further price increase by tracking the price drivers. Due to the delay in price pass through of one month the price drivers indicate what the price will do in the next month. In section 6.1 a time-series model is developed for the price (formula (1)). The results of the next month price change forecast for 2012 indicate an accurate fit illustrated by a RMSE of 1.6% (Figure 19).

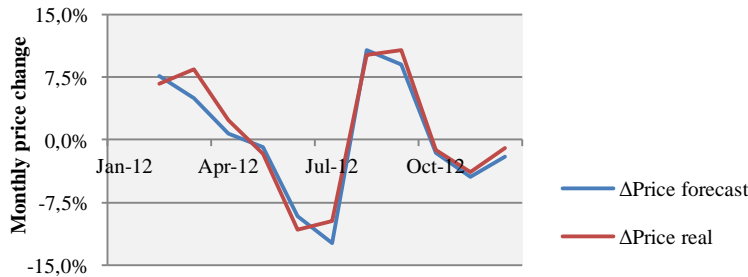

Figure 19. Monthly polymer X price movement.

This creates a pre-buying opportunity that can lead to cost savings for customers by increasing orders at time  $t$  when the price drivers indicate an increase of the price at time  $t+1$ . Note that the advantage in raw material costs must outweigh the increase in holding costs. Figure 20 visualize this purchasing strategy. The desired stock coverage is linked to the derivative of the price forecast for the next month, which implies that the effect on the desired stock coverage is equal to the price movement. Via the stock adjustment order the impact on orders is calculated. The desired inventory coverage is maximal at the point of inflexion of the forecast for next month's price. Hence, the desired inventory coverage is maximal when the pre-buy opportunity is maximal. Next, the timing of the demand waves caused by this effect is tested. We do this by introducing a positive value for the stock adjustment factor of privately owned customers that is based on the derivative of the price forecast (prebuy dASE).

The results of a Monte Carlo sensitivity analysis of the prebuy dASE parameter (2000 runs, uniform distributed between 0 and 10) are compared to the actual industry demand realization in Figure 21. We observe that this price-(de)stocking relation increases the predictability of the demand waves in the industry. The price anticipation option predicts the timing of the demand peaks and troughs better than the price speculation option: the decrease of RMSE (increase of  $R^2$ ) by adding pre-buying in anticipation of the development of the price drivers is 16 (26) percent against 3 (6) percent by adding the pre-buying reaction on the realized price. This analysis indicates that we accept hypothesis (2b): "A price anticipation opportunity caused by a delay in the price pass through of the polymer X price drivers triggers active (de)stocking by

privately owned customers.” and reject hypothesis 2a “*Speculation on the continuation of an upward trend in the price of polymer X leads to active stocking behavior by privately owned customers*”.

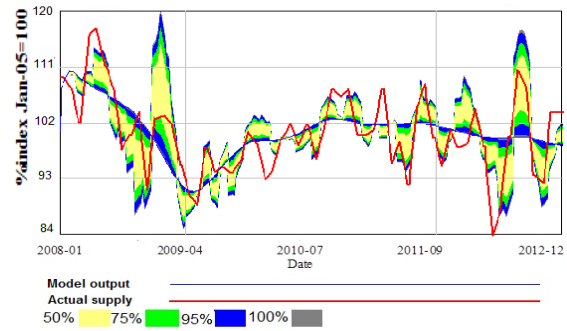
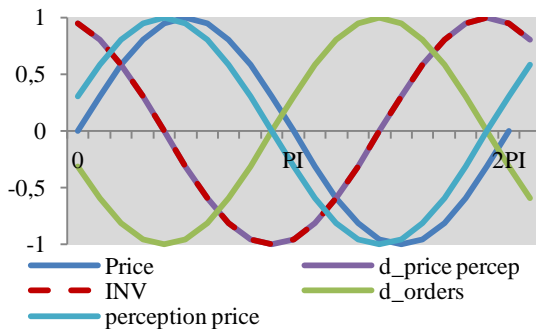

Figure 20. Pre-buying on price drivers (prebuy dASE>0). Figure 21. Effect of pre-buying on price drivers.

### 6.2.3 DELAYED BUYING BEHAVIOR BY NON-PRIVATELY OWNED CUSTOMER

Finally, we test whether publically listed customers have different ordering behavior than privately owned customers. In this section we therefore test if non-privately owned companies in contrast to pre-buying behavior postpone their orders when the price is high. Instead of building up inventories for periods with a high price, we hypothesize that non-private companies will deplete their inventories when the price is high. This is explained by their short-term focus while facing a crisis situation (Walrave et al, 2011). Hence, in this study we assume that the polymer X industry faces a ‘crisis situation’ in recent years, which commenced with the 2008 credit crisis.

Delayed buying behavior, mathematically formulated in section 6.1, is visualized in Figure 22. The inverse of the polymer X price is linked to the inventory coverage target of non-privately owned customers, which implies that the target inventory level is reduced with a price increase. Via the stock adjustment order ( $O_n^t(S)$ ) the impact on orders is calculated. The increase of orders is maximal at the point of inflexion of the price (i.e. the minimum of first derivative). Since we apply the stock adjustment factor to the absolute price, a structural higher price engenders a structural reduction of inventory.

We test the timing of the demand waves at the upstream producer caused by this effect by introducing a negative value for the stock adjustment factor based on price (ASE) at the non-privately owned customers. The results of a Monte Carlo sensitivity analysis (2000 runs, uniform distributed between -3 and 0) are compared to the actual industry demand realization in Figure 22. The poor timing of the demand wave around the 2008 credit crisis is caused by the length and amplitude of the price wave. The polymer X price dropped with 55% in four months followed by an increase of 60% in ten months indicating a demand wave with a length of 14 months (Figure 23). Given a stable production, customers need inventory to buffer for this demand wave. Since inventory is capacitated, it is not possible to increase (or decrease) orders for so many consecutive months. This explains the poor timing of the demand wave around the 2008 credit crisis. On the other hand, the demand wave in 2012 is timed correctly. The shorter wave length made it possible to use inventory to buffer. By introducing the delayed buying effect to the non-privately owned polymer processors, the RMSE is reduced with 13 percent. Therefore hypothesis 2d “*Non-privately owned customers choose a riskless buying strategy where they delay orders when the price is high.*” is confirmed.

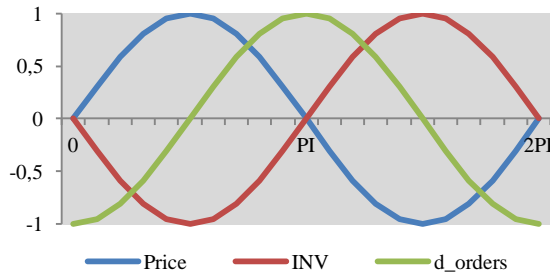

Figure 22. Delayed buying behavior ( $ASE < 0$ ).

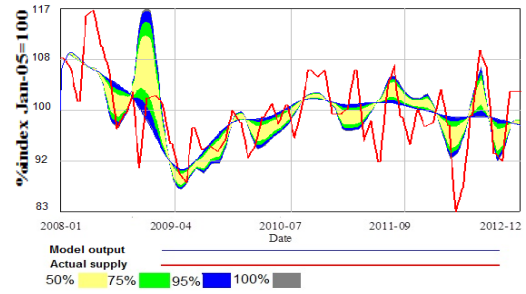

Figure 23. Effect of delayed buying behavior.

### 6.3 CONCLUSIONS

The price – active (de)stocking relation is added to the structural model of the chain. In this chapter we tested three hypothetical relations. We showed that direct customers utilize a pre-buy opportunity due to a delay in the price pass through from the price drivers (feedstock price and product availability) to the actual price realization (hypothesis 2b). Moreover, the difference in purchasing behavior between private and non-private companies is confirmed: privately owned customers take advantage of a pre-buy opportunity, whereas non-privately owned customers follow a riskless buying strategy where they delay their orders when the price is high (hypothesis 2c). The speculation option on a further price increase is not confirmed (hypothesis 2a). In the next section we will validate the noise model.



## 7 NOISE MODEL RESULTS

In an attempt to answer research question 2 we construct and validate the noise model in this chapter. The validation procedure has been discussed in chapter 5. We validate the noise model in section 7.1 and discuss different scenario analyses to further understand the timing and amplitude of demand waves and troughs in section 7.2.

### 7.1 NOISE MODEL VALIDATION

#### Model fit

The price-active (de)stocking relation is added by calibrating the prebuy dASE parameter (i.e. the stock adjustment factor based on the derivative of the next month price forecast) for privately owned companies and the ASE parameter (i.e. the stock adjustment factor based on price) for non-privately owned companies over the model fit period. Estimated boundaries for both parameters are:  $0 \leq \text{prebuy dASE}_{\text{pri.conv.}} \leq 5$  and  $-2 \geq \text{ASE}_{\text{non-pri.conv.}} \geq 0$ . Prebuy dASE<sub>pri.conv.</sub>=5 indicates that an increase of x% of the price will result in 0.5x% increase in the desired inventory coverage. A parameter value of -2 for ASE<sub>non-pri.conv.</sub> reflects a maximum decrease of two times the maximum increase of the price. Historically (data 2008-2011) the maximum value of the price was 25% higher than the January 2008 price. This would indicate a decrease of 50% in desired inventory coverage (i.e. 2.5 weeks of desired inventory coverage remains). The expected parameter value for ASE<sub>non-pri.conv.</sub> is -1, this reflects the case that the absolute value of working capital remains constant (e.g. an increase of x% in the price, indicates a target inventory coverage decrease of x%).

The calibration step is implemented within the system dynamics software package; simulations are performed on both parameters, while keeping the other model parameters constant. The cumulative sum of square errors (MSE) between the estimated demand and the historical industry demand data over the model fit period is calculated per run and the parameters that minimizes this error is chosen. This results in the following parameter values: prebuy dASE<sub>pri.conv.</sub> = 3.4; ASE<sub>non-pri.conv.</sub> = 0. This is in line with the expectations (section 6.2.3) since the ASE<sub>non-pri.conv.</sub> parameter leads to large fit errors during and immediately following the 2008 credit crisis due to the tremendous drop of the commodity price (i.e. model optimization is based on minimizing the MSE and MSE emphasizes large errors). The noise model (Figure 24) improves the RMSE of the model with 16% to 3.43 and the R<sup>2</sup> is increased with 26% to .67 (Table 8). Theil's inequality statistics shows a small decrease in the unequal variation (U<sup>s</sup>) which indicates that the standard deviation of the model is more in line with the standard deviation of the realized data.

Model fit	Structural model	Noise model	Change
RMSE	4.07	3.43	-16%
R <sup>2</sup>	.53	.67	26%
U <sup>m</sup>	.0210	.0295	.0085
U <sup>s</sup>	.1909	.1618	-.0291
U <sup>c</sup>	.7882	.8087	.0206

Table 8. Results model fit.

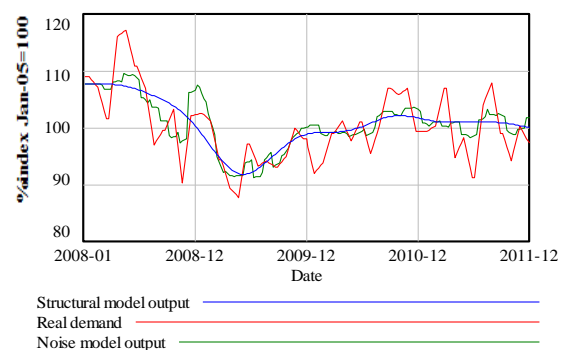

Figure 24. Model fit results.

## Model validation

The model validation is based on a comparison between actual demand and model results, which are based on end market demand forecast for 2012 (Figure 25). The corresponding statistics are shown in Table 9. We have tested the validity of the predicted demand volatility caused by active (de)stocking based on the pre-buy opportunity. The  $R^2$  of the noise model is improved compared to the structural model ( $R^2=.50$ ). Furthermore, the RMSE is decreased to 5.21 (-23%). The decrease of the unequal variation ( $U^s$ ) compared to the structural model from .8116 to .4111 in combination with a decrease in RMSE illustrates that the pre-buy dASE parameter improves the fit of the demand waves over the validation period.

Validation	Structural model	Noise model	Change
RMSE	6.77	5.21	-23%
$R^2$	.01	.50	5178%
$U^m$	.0451	.1181	.0731
$U^s$	.8116	.4111	-.4005
$U^c$	.1433	.4708	.3274

Table 9. Results of model validation.

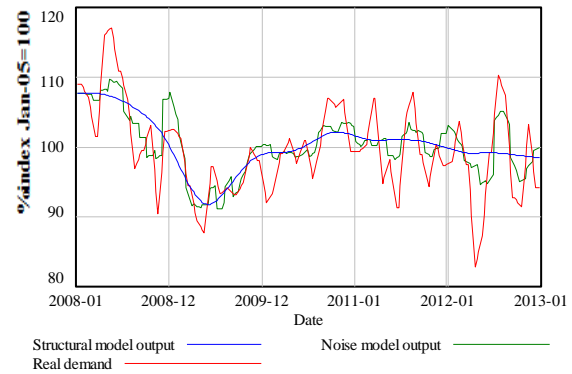

Figure 25. Model validation.

## 7.2 SCENARIO ANALYSIS

The scenarios analysis discussed in this section are based on actual industry demand realizations over the period 2008 – 2012 (measurement period). We will discuss different scenarios for adding delayed buying to our model and furthermore assess the size of the bullwhip and the amount of inventory in the chain.

### Delayed buying

The model fit and validation indicate that the remaining fit problems are caused by the misfit of the level and the amplitude of the demand waves in the last two years (2011-2012). Chapter 6 indicates a possible cause for this: delayed buying by non-private customers. This behavior is represented by a negative value for  $ASE_{non-pri.conv}$ . The effect of introducing a value for the ASE parameter from 2010 onwards on the model results for 2012 is shown in Figure 26. The model realization for ASE values of -2, -1 and 0 indicate that the model fit can be improved by introducing a parameter that represents delayed buying behavior plus a structural decrease in target inventory levels (Table 10).

Scenario	ASE=0	ASE=-1	Improve	ASE=-2	Improve
RMSE	3.81	3.67	-4%	3.72	-2%
$R^2$	.63	.65	3%	.63	0%
$U^m$	.0362	.0263	-.0099	.0156	-.0206
$U^s$	.2185	.1565	-.0620	.0729	-.1456
$U^c$	.7649	.8384	.0734	.9320	.1671

Table 10. Results of ASE scenario analysis.

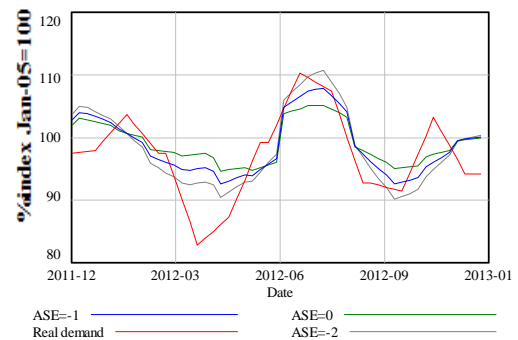
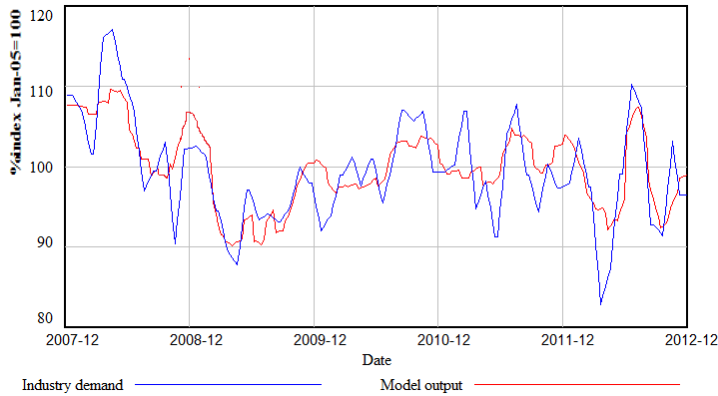

Figure 26. ASE non-private customer.

$ASE_{\text{non-pri.conv}} = -1$  improves the  $R^2$  of the model (+3% to .65 (Table 10)) and reflects the case that the absolute value of working capital remains constant (i.e. an increase of x% in the price, indicates a decrease of x% of the target inventory coverage). In addition, the visual model fit indicates that the timing of the demand troughs in 2012 has improved (Figure 27). This suggests that the optimal parameter values for the price factors are  $ASE_{\text{non-pri.conv}} = -1$  (activate from 2010 onwards) and pre-buy  $dASE_{\text{pri.conv}} = 3.4$ .



**Figure 27. Fit of noise model including delayed buying.**

### **Bullwhip**

The total bullwhip effect in the chain under study is 2.60 over the measurement period (section 3.1). The multiplicative supply chain bullwhip explained by this model is 1.47 (chapter 5). After adding the noise factors, the total modeled supply chain bullwhip is increased to 1.85. Specifically, the bullwhips on a single echelon level for both types of polymer processors are increased compared to the structural model: from 1.13 to 1.40 (+24%) for non-privately owned companies and from 1.15 to 1.55 (+34%) for privately owned companies. This is caused by last minute (de)stocking due to price fluctuations. The bullwhips for the distributor (1.10) and brand owner (1.19) did not change compared to the structural supply chain model, since we did not assess the effect of price dynamics on the bullwhips of companies further downstream. Bray and Mendelson (2012) demonstrated that the bullwhip caused by last minute fluctuations is higher than the bullwhip caused by fluctuations with a long information lead time (structural end market development). Based on the calculated bullwhips for the polymer processors in this case-study, we confirm their finding.

### **Inventory in the downstream chain**

We continue the discussion on the distribution of inventory in the chain from section 5.2. The estimated stock level of private and non-privately owned polymer producers differs over time due to a difference in inventory and order policies (expressed by different price-active (de)stocking relations in the model). Figure 28 visualizes the customer's stock coverage in weeks. The increased pressure on target inventory levels for non-privately owned companies led to a structural decrease of 10 percent in their stock coverage (first semester of 2008 compared to second semester 2012). This is in line with the findings of Walrave et al. (2011) who showed that non-privately owned companies while facing a crisis situation aim to improve short range performance by exploitation efforts like inventory reductions. In contrast, the pre-buy opportunities for privately owned customers led to a small increase in the average stock coverage of 4 percent. This is explained by the upstream cost focus of privately owned companies in the form of pre-buying opportunities. Additionally, the high month to month volatility in stock levels in 2012 is caused by the high feedstock price volatility.



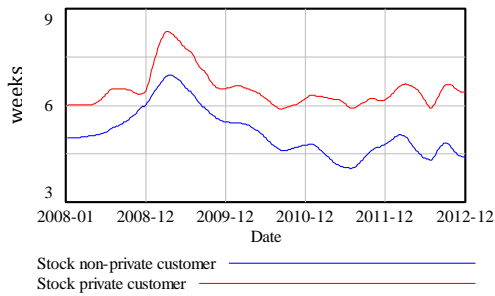

**Figure 28. Stock coverage direct customers.**

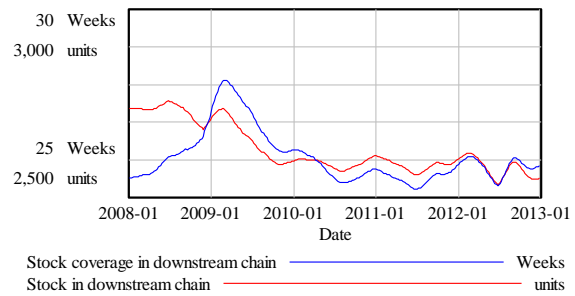

**Figure 29. Stock (coverage) in downstream chain.**

Finally, we assess structural destocking in the overall chain (hypothesis 1a). The model output (Figure 29) indicates that the total stock coverage in the downstream chain in the first semester of 2008 is in line with stock coverage in the second semester of 2012 (26 weeks). However, the yearly average model results over the last 5 years were higher than actual demand (Table 11). The cumulative difference between the model output and actual industry demand is 1.5 weeks and represents active destocking in the downstream chain. Hence, the difference in stock coverage of the downstream chain between the first semester of 2008 and the second semester of 2012 is 1.5 weeks or 6 percent. We thereby confirm hypothesis 1a stating that “*The average inventory coverage in the downstream supply chain of polymer X is decreased over the measurement period.*”

Average	Model	Actual	Difference	Share of weekly demand
2008	105.14	105.02	.1%	5
2009	95.96	95.52	.5%	26
2010	100.50	100.09	.4%	21
2011	100.59	99.42	1.2%	62
2012	98.19	97.22	1.0%	52

**Table 11. Yearly average demand.**

### 7.3 CONCLUSIONS

The fit of the structural supply chain model illustrates that the structural model develops accurate medium range demand predictions (chapter 5). However when the time aggregation is reduced, the structural model shows weak fit results. In this chapter we demonstrate that short range demand forecasting can be improved by adding the influence of price dynamics with a short information lead time to the model (RQ. 2). We showed that privately owned companies anticipate on a further price increase by pre-buying behavior. We modeled this effect by a price-active (de)stocking relation and validated the model on industry demand. Adding the noise factor improved the  $R^2$  of the model from .01 to .50 over the validation period. Additionally, we showed that adding delayed buying by non-privately owned customers after the 2008 credit crisis increased the model performance over the total measurement period ( $R^2$  is increased with 3 percent). Besides the short range demand amplification effect of delayed buying by non-privately owned converters, the delayed buying parameter has a structural side effect: a decrease of the desired inventory coverage if the price is increased in order to level the absolute amount of desired working capital.

We furthermore show that the total supply chain bullwhip accounted for by the noise model (1.85) is 26 percent higher than the total supply chain bullwhip of the structural model (1.47). Specifically, the contribution of the effect of last minute price fluctuations on the bullwhips of the privately and non-privately owned polymer processors is higher than the multiplicative

bullwhip caused by final consumer demand. This is in line with the finding of Bray and Mendelson (2012). Aligned with our expectation we furthermore found that privately owned polymer producers contribute more to the upstream bullwhip effect than non-privately owned polymer producers.

From an inventory perspective, we confirm hypothesis 1a and showed that the downstream chain inventory coverage in the last 5 years is reduced with 6 percent. Furthermore, a difference in ordering behavior based on company ownership indicates that the increased pressure on target inventory levels for non-private companies led to an extra decrease in their desired stock coverage (i.e. an exploitation effort in crisis situations to improve short range performance (Walrave et al. (2011))). On the other hand, private companies have an upstream cost focus and base their ordering behavior on the pre-buy opportunity amplified by the feedstock price volatility. We thereby conclude the discussion of research question 2. In the next chapter we aim to translate the short and medium range forecasts to tactical and operational decision making.



## 8 MANAGERIAL INSIGHTS

*In this chapter we specifically reflect on bullwhip exposure of polymer X producers. Demand forecasts produced by our system dynamics model can improve supply/demand decision making. In this chapter we interpret the output of our model and elaborate on which information to use at different levels in the decision making processes of polymer X producers. We furthermore discuss the case-study specific recommendations for further research. In chapter 9, we will focus on the theoretical contribution of this work.*

### 8.1 MODEL PREDICTIONS

In the previous chapters we have demonstrated that price and supply chain dynamics can be used for polymer X industry demand predictions. We have developed a prediction method by which final consumer demand, three to four echelons downstream, and price fluctuations with short information lead times are taken as the only exogenous information. A system dynamics model of the downstream chain is then used to propagate demand upstream. On industry level, our results show a high level of forecast accuracy. Medium range demand forecasts are based on final consumer demand development and are input for tactical supply/demand decision making. Major insight of our work is that the influence of price dynamics on short range polymer producers' demand variability is huge. Note that this underpins the essence of supply chain and commercial decisions making alignment. The unpredictability of commodity prices causes some problems, however due to the delay in price pass through of feedstock commodity price downstream; scenario analysis can be used to predict demand development under different feedstock price scenarios. The short range demand forecasts are input for operational decision making like order allocation and production scheduling.

We have already showed that the price of polymer X affects downstream industry demand via inventory and, consequently, ordering tactics of direct customers (chapter 6). To increase the understanding of the dynamics that create massive price fluctuations, we elaborate on the role of the upstream polymer producer industry in the amplification of the total supply chain bullwhip in section 8.2. Section 8.3 provides recommendations on how to use short and medium range demand predictions in supply/demand decision making. This section is structured by a hierarchical decision making framework aiming to decrease the supply chain bullwhip. We conclude this chapter with an overview of specific recommendations for further research for the polymer X industry case-study.

### 8.2 POLYMER PRODUCERS' BULLWHIP CONTRIBUTION

Polymer producers influence downstream demand by their supply chain and commercial tactics. In this section we sum how these tactics influence demand amplification by separately addressing costs (e.g. feedstock price) and margin (e.g. product availability) contribution as the main drivers of the polymer X price and consequently demand. Additionally, we spend some words on the role of inventory.

#### **Feedstock price pass through**

Although we assume that polymer producers cannot influence the variability of the feedstock price, they do control the pricing variability of polymer X. At this moment the average month to month feedstock price change is half of the average month to month polymer X price change. In chapter 5 is demonstrated that the delayed price pass through of the feedstock price to the price of polymer X creates pre-buying opportunities for direct customers. Customers taking advantage of this opportunity by increasing their orders in anticipation of a price increase amplify the total

supply chain bullwhip. Forward pricing contracts (i.e. prices are determined on the first day of the month or linked to last month's prices) further increase the value of the pre-buying opportunity for customers.

### **Product availability**

The European commodity polymer market has entered a more mature phase of their business development. The market is structurally long (i.e. structural overcapacity in the European market, without major possibilities to export products to other continents) indicating more buying power for customers and an increased pressure on price. Cachon et al. (2007) note that overcapacity amplifies the total supply chain bullwhip, because extra demand can always be fulfilled by increasing production. They argue that in a structural short market firms experience capacity constraints when demand peaks. This limits the bullwhip effect.

Although the European polymer market is structurally long, capacity problems or demand peaks due to pre-buy opportunities can lead to supply problems in the short run. Polymer producers are chemical companies. The chemical industry is known for its inflexible production with long lead times and high changeover times (Fransoo and Rutten, 1993). The process of adapting production rates in response to unexpected demand peaks or capacity problems is therefore delayed. The same holds for updating prices in response to supply or demand changes. In order to fulfill orders when the product availability is low, production runs are shortened. The resulting increase in changeover times decreases the overall production output. Hence, although the market is structurally long, short range product unavailability is possible. In a structural long market temporary supply problems may lead to shortage gaming. Shortage gaming is one of the causes of the bullwhip effect (Lee et al., 1997a) and will further amplify the demand waves.

### **Inventory strategies**

The inventory strategies of polymer producers amplify the demand waves observed. First, the recent economical crisis situation (Walrave et al., 2011) increased pressure on short-term performance, which led to a success trap (Levinthal and March, 1993; March, 1991): the recurring reduction of inventory targets as an example of exploitation efforts leads to predictable rebates and demand push at quarters' and year's end. This negatively affects long-term performance. We did not assess this phenomenon in this study, but we acknowledge it for further research. Second, inventory is supposed to function as a buffer between production and demand. With the reduction of average inventory levels flexibility has to be created differently. Shorter production cycles, last-minute production fluctuations, order allocation and price changes are all instruments used by polymer producers to balance supply and demand. It is however crucial to use these instruments as an anticipation instead of a reactive tool (Selçuk et al., 2007; Jansen et al., 2011). When used as reactive tool, problems like shortage gaming and pre-buy opportunities increase the supply chain bullwhip.

We conclude that the supply chain and commercial tactics of polymer producers amplify the total supply chain bullwhip. In section 8.3 we present recommendations which should ultimately help to limit polymer producers' bullwhip exposure. We structure our practical recommendations by a hierarchical supply/demand decision making framework.

## **8.3 RECOMMENDATIONS**

The results of this study have implications at both the tactical and operational level of decision making. Tactically, it is important for managers to keep track of final consumer demands, supported by an endogenous simulation of ordering behaviors, to make forecasts at quarterly or

yearly levels. Operationally, aligning commercial and supply chain decisions is crucial. For managers it is important to keep track of feedstock as well as polymer X prices and understand the relation between price fluctuations and demand peaks. Furthermore, scenario analysis can assess the impact of different price scenarios on industry level.

The production decision making framework (Silver et al., 1998) is used to translate the case-study insights to a hierarchical supply/demand decision making framework for commodity chemical producers (Figure 31). Medium range forecasts are input for the aggregate supply/demand planning recommendations (horizon of 3 to 12 months). Aggregate supply/demand planning decisions cover inventory targets, which plants to utilize and yearly customer contracts. Short range forecasts (1-2 months) are fed into the master production schedule and order allocation functions.

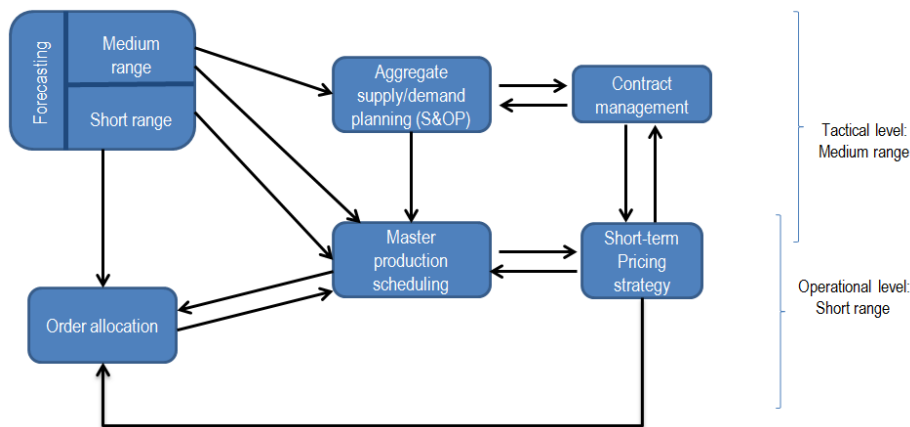

Figure 30. Hierarchical supply/demand decision making framework.

### 8.3.1 TACTICAL LEVEL

#### Aggregate supply/demand planning (S&OP)

Final consumer demand is crucial input to the aggregate supply/demand planning on tactical level. It is important to realize that in addition to unexpected changes in supply and demand, supply chains also face structural changes in markets. Companies need to anticipate on those structural demand changes to stay competitive. We propose to use forecasts solely based on a forecast of final consumer demand, which propagates upstream the chain via system dynamics models of the chain, as input for tactical decisions. Lee (2004) supports the importance of deciphering the need of your final consumers as a form of supply chain adaptability. The effect of price volatility on short range demand for commodity producers highlights the importance of final consumer demand mapping for tactical decision making since it allows managers to interpret demand signals.

As an example we explain the structural model forecast for polymer X demand (Figure 32). Final consumer demand dropped in the second half of 2012. The GDP forecast for 2013 is +0% compared to 2012. The dip in end market demand in the fourth quarter of 2012 propagates upstream the chain and results in a forecasted demand dip for the first quarter of 2013. The timing of the dip is around two months later than the dip in final consumer demand and is amplified with a factor of 1.5 due to updates in the inventory coverage in the chain. We recommend managers to use those models as an alternative forecasting tool in the S&OP decisions.

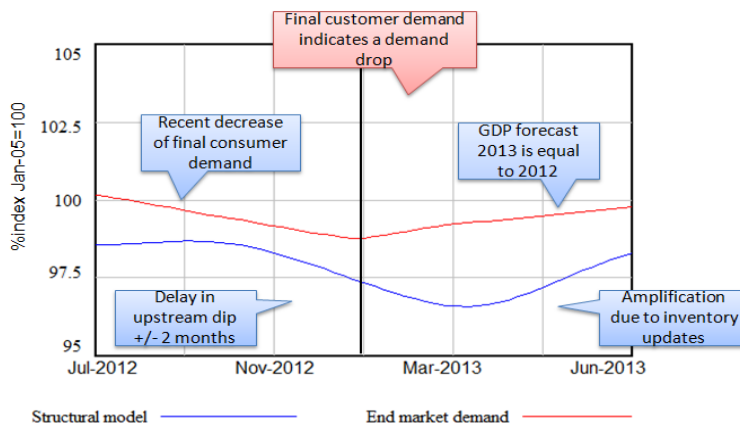

**Figure 31. Structural demand forecast.**

### Contract management

In a commodity market it is difficult to build relations with customers. Since products are of uniform quality customers can easily switch to competitors. Given the 7 percent average month to month price change of polymer X in 2012, the incentive to pre-buy or postpone orders is massive. *Stabilizing contracted demand volumes* per month therefore comes with a large advantage, so that a premium can be offered to the customer. Those premiums can only be calculated on individual account level. Major drawback of this method occurs when the month to month price change of polymer X reduces. This will lead to lost margin due to premiums offered to the customers.

Besides the volume and discount percentage settlements, the pricing strategy is crucial in contract negotiations. In this study, we showed that the type of pricing strategy affects the length of the delay in the price pass through between feedstock and polymer X. The longer the delay, the more valuable the pre-buying opportunity gets. With this in mind we acknowledge a comprehensive study of *the effect of price formulas on pre-buying behavior* for further research (section 8.4).

Final recommendation on contract management is to *separate the pricing tactics* of commodity polymers from the pricing tactics of engineering polymers. Hereby, the product length is taken into account. Commodities demand for more feedstock price related pricing tactics, since customers can easily switch, whereas engineering products are more customers specific and demand for robust pricing. We however note that it is difficult for a single player in a commodity market to change the way the prices of commodities are determined, since customers can easily switch between suppliers.

### 8.3.2 OPERATIONAL LEVEL

#### Master production scheduling

Master production scheduling serves as the primary interface between marketing and production (Silver et al., 1998). Low industry inventory levels imply that inventory is only partially used to buffer between supply and demand. Hence, production needs to closely match demand. We showed that price fluctuations influence short range demand volatility. This highlights the importance for supply chain managers to keep track of polymer X prices and its price drivers and to understand the relation between price fluctuations and demand peaks. Moreover, it is important to align commercial and supply chain decisions (indicated by the double arrows in the decision making framework (Figure 31)). In order to respond quickly to short-term changes in demand or supply, *contingency plans* are used for different scenarios. Those scenarios contain

the development of the different polymer X price drivers: feedstock price and product availability. As an example we have developed forecasts for different feedstock price scenarios (Figure 33). The output indicates that a radical feedstock price increase will lead to aggressive buying in January and a demand dip at the end of the first quarter, a radical feedstock price decrease will lead to a demand dip in January and increased demand (due to delayed buying) at the end of the quarter. During pre-buying periods polymer producers focus on margin, whereas periods in which customers postpone their orders ask for a focus on volume; demand will pick up in future periods, when a price reduction is expected.

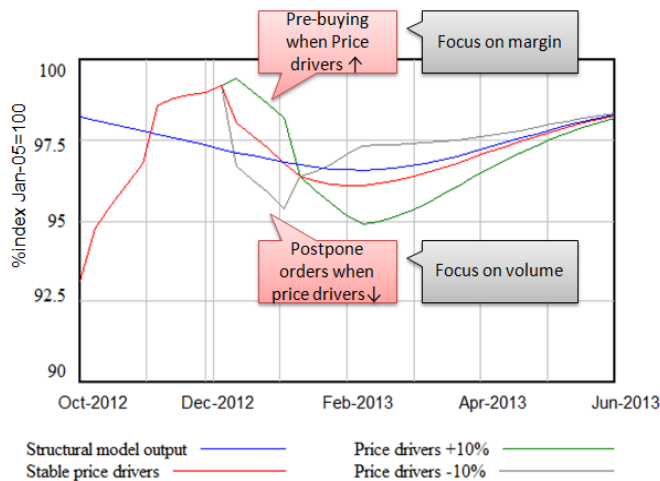

Figure 32. Feedstock price scenario forecasts.

### Order allocation

Both commercial and supply chain managers prevent shortage gaming by their customers. Shortage gaming is caused by customers expectations that demand cannot be fulfilled. Order allocation (i.e. dividing available product among customers' demand expectations) will create shortage gaming when customers start ordering more than they actually need. *Optimistic supply estimates* are therefore used in periods of high demand in order to limit the number of orders that is rejected. Hence, the signal of order rejection will lead to higher demand estimates for future periods, and thereby creates shortage gaming.

## 8.4 FURTHER RESEARCH

In this chapter, we specifically reflected on the supply chain bullwhip in the polymer producers industry. The previous section provided an overview of industry recommendations that could help to limit bullwhip exposure by polymer X producers. We end this chapter by elaborating on directions for further research in the polymer producers industry. First, we acknowledge the effect of different price formulas in contracts between polymer producers and processors for further research. Second, we propose to study the effect of end of the quarter inventory targets on long term performance on the individual firm level.

Section 8.3 illustrates that the price formula in the contract between the polymer producers and processors affects the length of the delay in the price pass through between feedstock and polymer X. The longer this delay, the more valuable the pre-buying opportunity gets. In order to quantify this effect, we propose to develop scenario analysis for different price formulas so that price risk can be assessed. Since the European market for commodity polymer X is structural long, implementing a contract price formula that takes feedstock price + x% might be an



alternative solution. Further research is however necessary to assess other factors influencing the price formulas in contracts between polymer producers and processors.

On the individual firm level we have noticed that end of the quarter inventory targets play a large role in the demand amplification of polymer X producers. As discussed in the previous section public listed firms focus on exploitation efforts to increase short-term performance by inventory reduction objectives while facing a crisis situation. At quarter's end those objectives lead to sales push into the market against high rebates. The predictability of this effect creates an opportunity for customers to anticipate on these rebates. In the short-term inventory capital negatively affects the return on investment (ROI). However, in the long-term inventory functions as a buffer between production and demand and positively affects revenues via both increasing operational customer service and decreasing production costs. This long range exploration effect positively affects the ROI. Quantifying the positive effect of the buffer function of inventory on the ROI and comparing it to the exploitation value of inventory capital reduction is an interesting direction for further research.

## 9 CONCLUSIONS AND FURTHER RESEARCH

*In the final chapter of this thesis we evaluate the theoretical contribution of this study. Section 9.1 presents the conclusions and areas for further research are defined in section 9.2.*

### 9.1 CONCLUSIONS

This thesis studies demand volatility upstream the supply chain on industry level for a specific product family. It is clear that the issue of supply chain variability has received considerable attention both in economics and in operations management. Economists tell us that inventory is an accelerator of business cycles (Abramovitz, 1950) while the focus in operations management has been on identifying causes of the bullwhip effect and suggesting improvement strategies based on those causes (Lee et al., 1997a,b; Fransoo and Wouters, 2000). To our knowledge Bray and Mendelson (2011, 2012) are the first to make a decomposition of the bullwhip. They decomposed the bullwhip in a multiplicative and additive component and showed that the additive bullwhip caused by the short noticed noise contribution drives the total bullwhip more than the multiplicative effect caused by signals with a longer information lead time.

Udenio et al. (2012) constructed a system dynamic model of the downstream supply chain with final consumer demand three to four echelons downstream as the only exogenous information to their models. Additionally, they modeled a synchronized destocking shock in the downstream chain at the start of the 2008 credit crisis. They validated the timing and amplitude of the demand wave as a result of the 2008 credit crisis and report accurate fit results in the supply chains under study. In this thesis, we change the scope to a commodity polymer producing industry acting one echelon further upstream the supply chain, and develop a system dynamics model of their downstream supply chain to predict upstream demand. Aligned with the decomposition of Bray and Mendelson (2012) we distinguished between short and medium range forecasting, which is also reflected in our two research questions:

- 1. Can we improve medium range demand forecasting (horizon 3 to 12 months) for polymer X by a system dynamics model of the downstream supply chain that captures final consumer demand and re-active (de)stocking?*
- 2. Can we improve short range demand forecasting (horizon 1 to 2 months) for polymer X by a system dynamics model that captures active (de)stocking of direct customers triggered by price dynamics?*

In line with the research questions, the theoretical contribution of this work is divided in two parts. First, we developed accurate medium range demand predictions based on final consumer demand that is amplified upstream due to supply chain dynamics. This finding is in line with the work of Udenio et al. (2012). We however contribute to this line of research by showing that the demand drop experienced by polymer producers as a direct result of the 2008 credit crisis is not amplified by active destocking in the chain. The drop is solely explained by a reduction in final consumer demand in combination with re-active destocking in the downstream chain. The observed demand drop by polymer producers is therefore lower than the demand drop observed by upstream echelons in the supply chains studied by Udenio et al. (2012). We reflect on this difference by stating that polymer processors have a more upstream cost than downstream demand focus due to the low value added nature of their processes. Upstream costs dropped dramatically due to the massive drop of commodity prices in 2008, this led to extra orders of commodity processors. The fact that the upstream companies in the supply chains studied by Udenio et al. (2012) are less commoditized and have a more downstream focus indicates why

the demand drop observed by polymer producers is lower than the upstream demand drop reported by Udenio et al. (2012).

We however identified active destocking in the downstream supply chain of polymer producers in later years by illustrating that the average chain inventory coverage is reduced with 5 percent in 2011- 2012. The structural increase of the commodity prices in recent years is a possible explanation for this. Short range demand variability is however not explained by final consumer demand. We therefore need to turn to the influence of price dynamics on demand for polymer products.

The second theoretical contribution of this thesis lies in the discovery of the influence of price dynamics on short range demand fluctuations for upstream polymer producers. Due to the high commodity price volatility and the observation that price volatility extends deeper into the downstream chain (IHS, 2011b) the price effect outweighs the effect of final consumer demand in the short range causing high demand variability. We furthermore illustrate that the relation between price and short range demand dynamics is mediated by the inventory tactics of polymer processors. We assume that the inventory tactics of polymer processors depend on their ownership structure and illustrate that privately owned customers take advantage of a pre-buy opportunity caused by a delay in the price pass through from the price drivers to the polymer price (price anticipation), whereas non-privately owned customers delay their orders when the polymer price is high. We show that the pre-buy opportunity is maximal when the price drivers indicate a large increase in polymer price for the next month.

Finally, we compare the magnitude of the additive and multiplicative supply chain bullwhips in the polymer supply chain. The total bullwhip of the downstream polymer supply chain is 2.60 over the measurement period. The results of our structural supply chain model indicate that the multiplicative bullwhip is 1.41. When adding the price effects to our model, the total bullwhip explained by our model increases to 1.85 (26 percent increase). Specifically, the contribution of the effect of last minute price fluctuations on the bullwhips of the privately and non-privately owned polymer processors is higher than the multiplicative bullwhip caused by final consumer demand. This is in line with the finding of Bray and Mendelson (2012).

With that said, it is important not to see the models presented in this thesis as purely forecasting tools. The key message lies in the difference between the medium and short term decision making focus for upstream producers. When the implementation horizon is longer, decisions should be based on final consumer demand: focus on the necessities and the evolution of the markets in which products are used. For short range decision making price has an enormous impact. High commodity price volatility highlights the importance of tracking the price drivers of commodities and collaborating with customers to decrease bullwhips caused by the last minute price fluctuations.

## 9.2 FURTHER RESEARCH

Our results, however, come with several limitations: (1) we estimate aggregated bullwhips on product family level instead of single product level; (2) we estimate bullwhips for commodity instead of engineering polymer products; and (3) we study the bullwhip effect on the mature over capacitated European market instead of developing under capacitated markets. Disaggregation to individual product level can lead to different bullwhip measures since production cycles and schedules are not taken into account. Furthermore, we cannot generalize the results of this study to engineering polymers (i.e. polymers produced in small quantities for

specific applications), since the law of one price does not apply to those products. This would weaken the price-demand relations discussed in this thesis. Finally, the European commodity polymer market has entered a more mature phase of their business development, whereas the polymer market space in emerging geographical regions is still evolving. Limiting the scope to the European market influences the conclusions of this study since the European market for polymer X is over capacitated while the supply/demand balance in emerging geographical regions is balanced. Cachon et al. (2007) note that overcapacity amplifies the total supply chain bullwhip, because extra demand can always be fulfilled by increasing production. This indicates that the results of this study can only be generalized to mature and over capacitated markets. To conclude, we acknowledge those limitations for further research so that the effect of changing the scope on the thesis results can be tested.

Additionally, more research is necessary to validate how the pattern of amplification changes at different positions in the chain. In this study we had limited access to data of the downstream echelons. We therefore based our assumptions on industry analysis and end market studies. To improve the understanding of the effect of commodity price volatility that extends deeper into the downstream chain on upstream demand amplification in the chain, a collaborative research of all echelons in a linear supply chain has to be conducted.

Specific to the supply chain under study, we acknowledge that industry supply problems are not directly taken into account. Although an overall shortage in the market is reflected in the market price for polymer X, a delay between supply problems and the pass through in the market price forces us to recognize this issue for further research. The system dynamics model of the downstream chain does not directly take production capacity restrictions into account; this means that production can be as large as 200% in one week and 0% in the next week. Furthermore, no limitation exists on the industry delivery rate, so that demand is always immediately fulfilled. We propose to include supply problems in the model to correctly account for the robustness of the polymer producers industry. This step has not been completed in current research due to difficulties in estimating the total industry supply volume. The structural overcapacity in the European polymer market forces polymer producers to limit their production volumes in order to balance supply and demand.

We end the discussion of directions for further research by acknowledging the effect of price strategies of competitors and the effect of production capacity limitations of downstream players on industry demand. Specifically, we recognize the effect of production smoothening in anticipation on a seasonal pattern in final consumer demand on upstream demand amplification for further research (Chen and Lee, 2012).



## REFERENCES

- Abramovitz, M. 1950. "Inventories and business cycles, with special reference to manufacturer's inventories." National Bureau of Economics Research.
- Anderson, E., C. Fine, G. Parker. 2000. "Upstream volatility in the supply chain: The machine tool industry as a case study." *Production Operations Management* 9 239–261.
- Blinder, A. 1986. "Can the production smoothing model of inventory behavior be saved?" *Quart. J. Econom.* 101 431–453.
- Blinder, A., L.J. Maccini. 1991. "Taking stock: A critical assessment of recent research on inventories." *The journal of economic perspectives* 5(1) 73–96.
- Bray, R.L., H. Mendelson. 2011. "Deriving Supply Chain Metrics From Financial Statements." *working paper Stanford Graduate School of Business.*
- Bray, R. L., H. Mendelson. 2012. "Information transmission and the bullwhip effect: An empirical investigation." *Management Science* 58(5) 860–875.
- Cachon, P., T. Randall, G.M. Schmidt. 2007. "In search of the bullwhip effect." *Manufacturing & Service Operations Management* 9(4) 457.
- Chatfield, C. 2000. "Time Series Forecasting." Univeristy of Bath, UK: Chapman & Hall/CRC (n.d.): 1-265.
- Chen, L., H.L. Lee. 2012. Bullwhip effect measurement and its implications. *Operations Research* 60(4) 771–784.
- Deaton A., G. Laroque. 1992. "On the behavior of Commodity Prices." *The review of Economic Studies* 59(1) 1-23.
- Dvir, E., K.S. Rogoff. 2010. "The Three Epochs of Oil." Working paper, Boston College.
- Feldstein, M, A Auerbach. 1976. Inventory behavior in durable-goods manufacturing: The target-adjustment model. *Brookings Papers on Economic Activity* 7(2) 351–408.
- Forrester, J.W. 1958. "Industrial dynamics: a major breakthrough for decision makers." *Harvard Business Review* 36(4) 37–66.
- Forrester, J.W. 1980. "Information sources for modeling the national economy." *Journal of the American Statistical Association* 75(371), 555-574.
- Fransoo, J.C., W.G.M.M. Rutten. 1994. "A Typology of Production Control Situations in Process Industries." *International Journal of Operations & Production Management*, 14(12):47-57.
- Fransoo, J.C., M. Wouters. 2000. "Measuring the bullwhip effect in the supply chain." *Supply Chain Management: An international journal* 5(2) 78–89.
- Holt, C. C., F. Modigliani, J. P. Shelton. 1968. "The transmission of demand fluctuations through distribution and production systems: The tv-set industry." *Canadian J. Econom.* 14 718–739.
- "IHS: Commodity volatility white paper". *IHS.* (2011a).

- “IHS: Pricing risks – be prepared for the next round of commodity price swings”. *IHS*. (2011b).
- Jansen, M.M., A.G. de Kok, J.C. Fransoo. 2011. "Lead time anticipation in Supply Chain operations Planning." *OR Spectrum*.
- Law, A.M., W.D. Kelton. 1999. “Simulation model and analysis”. Industrial Engineering and Management Science Series. McGraw-Hill. ISBN 0070592926
- Lee, H.L., V. Padmanabhan, S. Whang. 1997a. "The bullwhip effect in supply chains." *Sloan management review* 38(3) 93-102.
- Lee, H.L., V. Padmanabhan, S. Whang. 1997b. “Information distortion in a supply chain: the bullwhip effect”. *Management science* 43(4) 546–558.
- Lee, H. L. 2004. The Triple-A Supply Chain. *Harvard Business Review*.
- Levinthal, D. A., J.G. March. 1993. “The myopia of learning.” *Strategic Management Journal* 14 95–112.
- March, J. G. 1991. “Exploration and exploitation in organizational learning.” *Organization Science* 2 71–87.
- Niehaus, G.R. 1989. “Ownership structure and inventory method choice.” *The accounting review* 64(2) 269-284.
- O'Sullivan, A. 2003. Economics: Principles in Action. Pearson Prentice Hall.
- Oliva, R., J.D. Sterman. 2001. “Cutting corners and working overtime: quality erosion in the service industry.” *Management Science* 47(7) 894-914.
- Oliva, R. 2003. “Model calibration as a testing strategy for system dynamics models.” *European Journal of Operational Research* 151(3) 552–568.
- Painter, P. C., & Coleman, M. M. 1997. *Fundamentals of Polymer Science: An Introductory Text*. Lancaster: Technomic Pub Co.
- Peels, R., M. Udenio, J.C. Fransoo, M. Wolfs, T. Hendrikx. 2009. "Responding to the Lehman Wave: Sales Forecasting and Supply Management during the Credit Crisis." *BETA Working Paper Series* 297.
- Pindyck, R. S. 1994. “Inventories and the short-run dynamics of commodity prices.” *The RAND Journal of Economics* 25(1) 141-159.
- Pindyck, R.S. 2004a. “Volatility and commodity price dynamics.” *The Journal of Futures Markets* 24(11) 1029–1047.
- Pindyck, R.S. 2004b. “Volatility in natural gas and oil markets.” *The Journal of Energy and Development* 30(1).
- Silver, E.A., D.F. Pyke, R. Peterson. 1998. *Inventory Management and Production*. 3rd edition. John Wiley & Sons, New York.

- Selçuk, B. 2007. "Dynamic performance of hierarchical planning systems: modeling and evaluation with dynamic planned lead times." PhD thesis, Eindhoven University of Technology.
- Sterman, J. 1989. "Modeling managerial behavior: misperceptions of feedback in a dynamic decision making experiment." *Management Science* 35(3) 321–339.
- Sterman, J.D. 2000. *Business dynamics: Systems thinking and modeling for a complex world*. Irwin/McGraw-Hill.
- Taleb, N.N. 2010. *The Black Swan*. Penguin.
- Terwiesch, C., J. Ren, T. H. Ho, M. Cohen. 2005. "Forecast sharing in the semiconductor equipment supply chain." *Management Sci.* 51 208–220.
- Tversky, A., D. Kahneman. 1974. "Judgment under uncertainty: Heuristics and biases." *Science* 185 1124–1131.
- Udenio, M., J.C. Fransoo, R. Peels. 2012. "Sales forecasting and Supply Chain Management During the Credit Crisis." *article submitted to Management Science*.
- UNCTAD secretariat to the G20 Commodity Markets Working Group. "Excessive commodity price volatility: Macroeconomic effects on growth and policy options". (2012).
- Walrave, B., K.E. van Oorschot, A.G.L. Romme. 2011. "Getting trapped in the suppression of exploration: a simulation model." *Journal of Management Studies*.