

MASTER

QRA and CFD methods for industrial explosions

Mannaerts, S.

Award date:
2008

[Link to publication](#)

Disclaimer

This document contains a student thesis (bachelor's or master's), as authored by a student at Eindhoven University of Technology. Student theses are made available in the TU/e repository upon obtaining the required degree. The grade received is not published on the document as presented in the repository. The required complexity or quality of research of student theses may vary by program, and the required minimum study period may vary in duration.

General rights

Copyright and moral rights for the publications made accessible in the public portal are retained by the authors and/or other copyright owners and it is a condition of accessing publications that users recognise and abide by the legal requirements associated with these rights.

- Users may download and print one copy of any publication from the public portal for the purpose of private study or research.
- You may not further distribute the material or use it for any profit-making activity or commercial gain

QRA and CFD methods for Industrial explosions



TU / **e** Technische Universiteit
Eindhoven
University of Technology

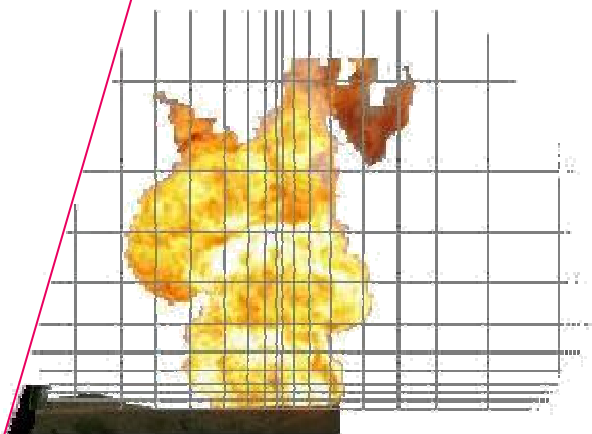

S. Mannaerts
04-02-08



Part I: Quantitative Risk Assessment

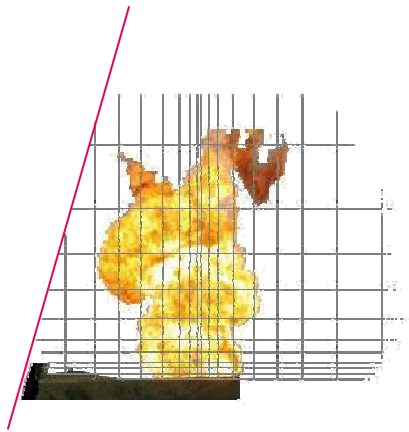

Part II: Explosion Modeling With the Use of Computational Methods

Master Thesis Eindhoven University of Technology Unit Structural Design Section Applied Mechanics

By:

S. Mannaerts
Stu nr. 0579897
Professor Verbernelaan 70
5037 AH Tilburg

Committee:

Prof. Dr. Ir. J.G.M. Kerstens
Dr. Ir. M.C.M. Bakker
Dr. Ir. B.J.E. Blocken
Dr. C.N. Smit

V a105 03-04-08

Preface

This thesis is written as the final part of the master program Structural Design. Structural Design is one of the master tracks offered by the faculty Architecture Building and Planning at the Eindhoven University of Technology. A master thesis is a compulsory part of the master program at the Eindhoven University of Technology and marks the end of a specialization, in which a student can apply his or her gained knowledge in the field of expertise, and is offered the opportunity to work closely with the scientific staff of the university in a certain field of interest. The underlying thesis topic is initiated by the unit applied mechanics, which is a unit which operates within Structural Design. The thesis is credited with 39 ECTS.

Writing a thesis can be a long journey where good supervision is a necessity to obtain a good quality in scientific work. As for the supervision, I had excess to people with a considerable reputation in the scientific world. Therefore I would like to take the opportunity to thank Prof. Dr. Ir. J.G.M. Kerstens, professor of the Unit Applied Mechanics TU/e, and Chair of the AGS, Dr. Ir. M.C.M. Bakker, associate professor of the Unit Applied Mechanics TU/e, Dr. Ir B.J.E. Blocken, Building Physics Systems TU/e and Building Physics KU Lueven and Dr. C.N. Smit, of the AGS. Their guidance and expertise assured a high end output. This all was achieved within a very pleasant way of interacting.

Furthermore I would like to thank the contribution made by the Centre of External Safety of the RIVM. Ir L. Gooijer, Ir. P. Timmers for the guidance offered with SAFETI-NL.

Also the contribution of Drs. J.M. van Dongen, city of Tilburg, and J. Eskens of Oranjewoud is highly appreciated.

I would also like to thank Julija Luzan, for her patience and the topic related critical reasoning from time to time which was quite challenging, and therefore very useful.

Summary

Activities with dangerous substances are not without risks. When an accident occurs people in the vicinity of the accident site are exposed to the physical effects of the accident. The exposure, fire exposure, exposure to overpressure and toxic exposure, can result in injuries or lethality for people who are close to the accident site.

The Netherlands is a country in which a lot of transport activities take place, also with dangerous substances. A big part of the Dutch population is exposed on a daily basis to these transport activities because of the dense population of the country. The government established therefore a framework which provides a minimum level of safety for third parties in the vicinity of transport activities with dangerous substances. The safety for third parties is called external safety and is expressed in a individual risk (IR) and a societal risk (SR). The individual risk is regulated whereas the societal risk is given as an advisory value.

Due to new national regulation a shift in risk control is initiated. The local governments are now also responsible for risk control and thus external safety of their inhabitants.

The local governments use Quantitative Risk Assessment (QRA) instruments to calculate the IR and SR in a region of interest. The guideline for the assessment is published by the national government in the Publication Series on Dangerous Substances, also referred to as the colored books. Over the years a number of software packages has been released to give local governments a standardized, digital tool to perform QRA's, based on the guidelines given in the Publication Series on Dangerous Substances. The national government is now considering legislating these software packages, RBM II and SAFETI-NL. These software packages are black boxes, and a insight in performed operations is not provided. In an attempt to open these black boxes, a case study is performed in part I of this thesis. A QRA is performed with the use of the guidelines given in the Publication Series on Dangerous Substances, to provide insight in the required operations. The results are compared with RBM II and SAFETI-NL results to establish if the QRA instruments are transparent, robust, verifiable and valid. The conclusion of this thesis is that the QRA instruments do not completely fulfill these base requirements.

In the past the QRA tools were used for screening purposes i.e. for relative decision making. Today the QRA instruments are in use as an absolute tool. This means that based on the result, urban planning takes place, but also the preparation of emergency services for accidents to occur are based on the QRA results. The QRA research in part I of this thesis questions the accuracy of physical effects. In part II of this thesis blast effects are studied, and the effect of complex urban configurations on their propagation. Currently, the Publication Series on Dangerous Substances only considers simple urban configurations, via a single building. Literature review shows that urban geometries can have an effect on the conservation of blast waves. This means that the effect distances can be greater than expected in the Publication Series on Dangerous Substances.

Therefore blast wave propagation in urban geometries has been investigated by studying a simplified explosion model with the use of the CFD tool FLUENT. The simplification is done by adopting certain assumptions, which is needed because the initial problem of gas explosions in urban geometries is very complicated.

The results of this thesis show that it is very hard to model this simplified approach, let alone to model the complex initial problem with the use of a commercial CFD code.

The suspicion that the blast effects are less straightforward as stated in the Publication series on Dangerous Substances, and the conclusion of this thesis that it is at this moment not possible to give an accurate prediction of blast wave propagation in a urban environment shows that the QRA in its current form (Publication Series on Dangerous Substances, RBM II and SAFETI-NL), might not be appropriate to use as a absolute tool to justify urban planning and preparation of emergency services.

Table of content

Preface	III
Summary	IV
Table of content	VI
General Introduction	IIX
Part I: Quantitative Risk Assessment	9
1. Introduction	9
2. Risk Assessment	10
2.1 Risk Control	10
2.2 Quantitative Risk Assessment	11
2.3 Problem Statement & Research Question	12
2.4 Physical Effects	13
2.4.1 BLEVE	13
2.4.2 VCE	15
3 Literature Review	16
3.1 BLEVE	16
3.2 Vapor Cloud Explosions	18
3.3 Interaction Blast Waves and Urban Geometries	18
4 Methodology	20
4.1 Outline of the Research	20
4.2 Assumptions	20
4.2.1 Assumption Deterministic Approach	21
4.2.2 Assumptions Probabilistic Approach	21
5 Case Study	23
5.1 Deterministic Approach	23
5.1.1 CBM Deterministic Results	23
5.1.2 RBM II Deterministic Results	26
5.1.3 SAFETI-NL Deterministic Results	27
5.1.4 Results of Risk Contours	29
5.1.5 Discussion of Deterministic Results	31
5.2 Probabilistic Approach	33
5.2.1 CBM Probabilistic Results	33
5.2.2 RBM II Probabilistic Results	34
5.2.3 SAFETI-NL Probabilistic Results	36
5.2.4 Discussion of Probabilistic Results	38
6. Conclusions & Recommendations	39
6.1 Conclusions	39
6.1.1 Transparent	39
6.1.2 Robust	39
6.1.3 Verifiable	40
6.1.4 Valid	40
6.2 Recommendations	41
6.2.1 Physical Effects	41
6.2.2 Injury and Damage Models	42
Part II: Explosion Modeling With the Use of Computational Methods	43
1. Introduction	43
1.1 Problem Statement	44

1.2 Research Question	44
1.3 Scientific Relevance.....	45
1.4 Social Relevance	45
2 Literature Review	46
2.1 Subsonic Modeling	46
2.2 Supersonic Modeling.....	47
2.3 Urban Environment Modeling.....	48
2.4 Summary Literature Review	49
3. Methodology	50
3.1 Outline of the Research	50
3.1.1 Assumptions	50
3.1.2 Methods Investigation.....	50
3.1.3 Results and Discussion.....	50
3.1.4 Conclusions and Recommendations	50
3.2 Assumptions.....	51
3.2.1 Free Air Explosion.....	51
3.2.2 Two Dimensional Simulations	51
3.2.3 TNT Equivalence.....	51
3.2.4 Supersonic, Inviscid, Laminar Flow	52
3.2.7 FLUENT.....	52
3.3 Reference	53
3.3.1 Deflagration vs. Detonation.....	53
3.3.2 Shockwave.....	54
4. Available Methods.....	55
4.1 Method 1: FLUENT T Combustion Model	55
4.2 Method 2: FLUENT Propane Cloud Model.....	56
4.3 Method 3: Equilibrium Model.....	56
4.4 Method 4: Acoustic Shockwave Model.....	57
4.5 Selected Method	57
4.5.1 Mesh.....	57
4.5.2 Known parameters.....	59
5. Results and Discussion	60
5.1 Results	60
5.1.1 Simulation 7	61
5.1.2 Simulation 8	64
5.2 Discussion	66
6. Conclusions & Recommendations.....	68
6.1 Conclusions.....	68
6.2 Recommendations.....	69
References	71

General Introduction

This thesis deals with safety issues concerning hazards that can occur after accidents with transport installations. These installations are of particularly interest, because of the huge amount of transport movements in the Netherlands.

Part I of this thesis addresses the risk analysis methods used for estimating risks. Risk analysis methods gained over the last few years in importance for policy making in the Netherlands. In order to prepare for accidents, and to allow urban development within a certain safety level, it is fair to question how useable the current risk analysis methods are.

Part II of the thesis deals with the research of the possibilities of modeling a shock wave with the use of computational methods. The need for this investigation arose from the lack of knowledge of blast wave propagation in urban geometries. In the current risk analysis methods, blast waves are calculated with methods which don't take channeling effects into consideration. Current literature shows however the importance of street channeling effects. As a first step, this thesis is limited to the numerical modeling of free air explosions

Part I: Quantitative Risk Assessment

1. Introduction

The Netherlands is a small country, with a highly developed industry. The different industries produce goods for the domestic market, and for export purposes. The presence of big ports like Rotterdam and IJmuiden, assure that there is enough opportunity for in and export. All these activities have a major influence on the amount of transported goods through the country. These goods are mainly transported by inland shipping, railway transport, road transport or pipeline transport.

The goods transported are not only harmless materials, but part of it also consists out of dangerous substances. Examples of dangerous substances are ammonia, chlorine and liquefied petroleum gas or LPG. KPMG et al [2004] state that, from an economic point of view, these three materials are the most important, because they are produced and used on a large scale. Ammonia for example is used for fertilizer, but it also finds its use as a cooling substance in refrigerators. Chlorine is a base material to produce certain types of plastic. LPG is a popular type of car fuel in the Netherlands, which means that most of the gas stations provide it and, as a consequence, store large amounts of it.

Transporting dangerous goods is not without risks. There is always the possibility of an accident occurring when it is transported. When an accident occurs the consequences can be

- Dispersion of a toxic cloud with chlorine for example
- Ignition of a fire with unleaded fuel for example
- Setting of an explosion with LPG for example

Due to the production facilities which are spread all over the country and the import and export of goods in the ports, a lot of transportation has to take place through densely populated areas. This increases the risk for people who live near a transport route. In case of an accident, there will be more casualties in a densely populated area, than the same accident in a less densely populated area.

2. Risk Assessment

Risk assessment is used to recognize, assess and control risks for third parties in the vicinity of dangerous substances.

This chapter gives a short overview of the issues concerning risk control and current methods for risk assessments. Also the problem statement and the research question will be stated.

2.1 Risk Control

The government of the Netherlands has defined a framework in which a set of risk limits is established for the population in the vicinity of activities with dangerous substances. Due to new legislation, the responsibility for risk control shifted from the national government to the local governments, like provinces and communities. The risk control for the local government exists out of four parts:

- Pro active to prevent accidents;
- Preventive to limit risks in case of an accident;
- Preparative to prepare for a accident which might occur ;
- Repressive to maintain quality of emergency services.

The first two parts are external safety issues; the last two are specified for emergency services.

External safety is concerned with the risk of an accident to occur, and the consequences for third parties when they are in the vicinity of activities with dangerous goods which, in case of the underlying thesis, will be transport activities. Transport activities are of particular interest because third parties expose themselves regularly in the vicinity of transport routes.

The external safety is expressed in terms of an individual risk and a societal risk. The individual risk is a value for the risk of one person dying per year on a certain place, as a consequence of an accident with a dangerous substance. This value is regulated by the national government in the BEVI [2004] and has an upper limit of 1×10^6 of one lethal casualty per year. Or, in other words one lethal casualty once in every million years. The individual risk is presented on a map, where all the points of equal risk are connected as shown in figure 2.1a .

The societal risk is the risk of a group of people dying at a certain place due to an accident with hazardous goods. This value is not regulated, but an advice is given to limit the risk for a group of ten people dying, to be equal or less then 1×10^6 per year. The societal risk is not regulated

because of economic reasons. Regulation would mean that parts of the existing urban areas in the Netherlands would need to be removed to meet the regulation. The societal risk is presented in a FN curve. The curve represents the accumulated number of casualties on the x axis, and the lethality probability on the Y axis as shown in figure 2.1b.

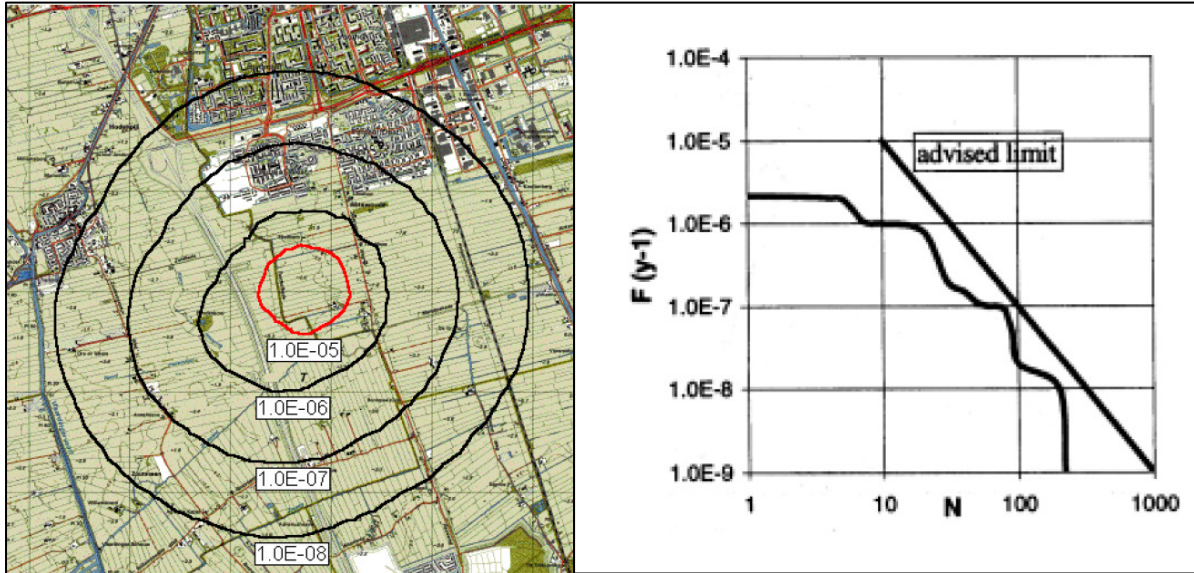

fig 2.1a Individual risk contour, 2.1b FN curve representing societal risk

The recognition and assessment of risks becomes of vital importance, to guarantee a certain safety level to third parties. The recognition and assessment of risks requires a risk analyses procedure.

The analyses can be carried out with the use of two approaches. The first one is a deterministic approach. In this approach the risk levels are only based on physical effects of an accident. The second one is the probabilistic approach. In this approach, the risk levels are also determined by the probability of an accident occurring. The last approach is used in the Netherlands, because this model reduces the risk levels and gives way for urban development.

2.2 Quantitative Risk Assessment

The risk assessment is carried out using a Quantitative Risk Assessment, denoted as QRA. The policy for the treatment of hazardous goods is anchored in the "stoffenbeleid". The execution and implementation of this policy is available as a set of guidelines called the Publication Series on Dangerous Substances (also known as the Colored Book Series). The guidelines embed a description for the execution of a QRA. These guidelines are well known over the world,

especially some methods from the Yellow Book which describe the calculation of blast effects. Based on this publication series, two software packages were introduced over the years to standardize and control the calculations which were carried out. One software package is only available for calculation of risks involving transport activities. This package, called RBM II, is developed on request of the Dutch ministry of transportation and water management. The second package can be used for both stationary and transport installations. This package, called SAFETI-NL, is developed on request of the Dutch ministry of Housing, Spatial Planning and Environment.

Local governments use these QRA instruments for a variety of governmental decisions. The instruments are used by local governments to plan urban development of a city or region near activities with a high risk. It is also used for licensing for companies who work with dangerous substances, and for planning to build a facility in the vicinity of an urban area. Often the instruments are also used for studying route alternatives, when dangerous goods are transported through densely populated areas. In all cases it is used to justify the risk to civilians which are present in a high risk area.

The Dutch national government is planning to legislate RBM II and SAFETI-NL, when a risk assessment is required. This is stated in the "Nota Ruimte" [2004]

2.3 Problem Statement & Research Question

Knowing the application of the instruments, and the importance given to them, it is important to know if the instruments are usable. As mentioned before, RBM II and SAFETI-NL are both based on the Publication Series on Dangerous Substances. The problem with the instruments however, is that it is hard to determine if the instruments produce accurate outcomes, which are usable for local governments to justify risks and for policy making.

Therefore the research question which needs to be answered is:

Are the QRA instruments CBM RBM II and SAFETI-NL transparent, verifiable, robust and valid?

CBM is the abbreviation for Colored Book Method. This is the assessment method described in the Publication Series on Dangerous Substances. This method serves as the bench mark for the other two methods because this method provides insight in the procedures for the calculation of

risks. That means that the calculation procedure for the physical effects is known, and the procedures to calculate the risks due to the previously mentioned physical effects are also known.

The method is called CBM, in order to be able to discuss in a later stage the shortcomings, if discovered, of the Publication Series on Dangerous Substances which then apply for all three of the methods.

The testing criteria stated in the research question are the criteria used by the AGS (Advice committee on dangerous substances, independent committee who advises Dutch government about safety issues and dangerous substances) in the report “QRA Modelling voor Vervoer van Gevaarlijke Stoffen” published in 2004 in Dutch.

2.4 Physical Effects

The accident under investigation in this thesis is an accident which causes an explosion and thus gives rise to a pressure wave. There is a specific interest in pressure waves because this research is initiated by the unit Structural Engineering of Eindhoven University of Technology, to study structural response caused by industrial explosions.

There are two types of industrial explosions recognized in the Purple Book [2004] with transport installations. The occurrence depends on how the substance is released in atmospheric conditions:

- Instantaneous release: BLEVE, discussed in 2.5.1
- Steady release: VCE, discussed in 2.5.2

The effects are discussed in this chapter to be able to understand the literature review in the next chapter.

2.4.1 BLEVE

A BLEVE, short for Boiling Liquid Expanding Vapour Explosion, with a flammable gas is considered here. BLEVE's occur when a material which is pressurized, for example LPG, is released in atmospheric conditions. Gasses are often pressurized to bring them in to the fluid state under atmospheric temperatures. This fluid is more compact and easier to transport. The fluid is boiling during transportation or storage, but cannot vaporize due to the pressure. When the storage tank (transport tank is a moving storage tank) fails, the pressure drops back to

atmospheric values. The fluid is boiling and due to loss of pressure, vaporization is now possible. With vaporization comes the expansion from fluid state to gaseous state. In case of LPG, the volume of vapor is 280 times bigger than LPG in liquid state. Due to the instantaneous release of the complete tank inventory and the very rapid vaporization, this fast evaporation is also known as flashing, a pressure wave develops. This very fast evaporation process is also known as explosive evaporation.

Tank failure can be caused by different scenarios for example

- Collisions between storage tank and a moving object
- Loss of strength due to corrosion of the storage tank
- External fire which weakens the storage tank

In case of collision or corrosion, the tank fails at operating pressure. The explosive evaporation at operating pressure of the storage tank is called a cold BLEVE.

When an external fire occurs, the material in the tank is warmed even more (superheat) than it already was under atmospheric temperatures. This causes the internal tank pressure to rise far above operating pressure. The external fire also weakens the storage tank, and at a certain pressure, the tank fails and the superheat material is released into the atmosphere. Due to the high internal pressure, the inventory will evaporate even faster compared to the cold BLEVE situation. The faster evaporation causes a pressure wave with high amplitude. The process of material release due to an external fire is called a warm BLEVE.

After the material is released, a gas cloud forms near the accident site. In case of a warm BLEVE with a flammable gas, the gas ignites immediately. When ignited, a flame front will move rapidly through the gas cloud. The generated heat makes the cloud to rise in the air. During the burning process, the gas expands, i.e. the volume of the burnt reactants is bigger than the volume of unburned reactants. This expansion pushes the surrounding air away. Due to the lack of air near the flame, air is sucked into the combustion from the bottom side. This air stream generates a mushroom cloud which is typical for carbon fires. The top of the flame named the fireball can get, depending on the amount of fuel involved, a considerable diameter.

2.4.2 VCE

Vapor Cloud Explosions (VCE) can occur when a vapor cloud is formed after a steady release from a pressure tank. The steady release can be caused a hole in the tank wall for example.

Due to the hole in the tank wall, the pressurized substance will be released and evaporates immediately. Because the releasing takes some time, a vapor cloud is formed which can surround nearby buildings and other obstacles. If the inventory of the tank is a flammable gas, ignition of the vapor cloud can occur. When the cloud ignites a flame front will travel trough the fuel air mixture. The volume of the burnt reactants is bigger than the volume of unburned reactants. This expansion pushes the surrounding air away and gives rise to a pressure wave. When the flame front encounters an obstacle, the flame front will be affected by turbulence. As a result the flame front will be stretched and accelerated which increases the pressure development. This type of explosion is self driven by the turbulence which is called positive feed back.

3 Literature Review

The purpose of the literature review is to investigate the energy content of explosions, depending on a number of factors. It is also meant to compare the methods from the Yellow Book with up to date literature. This literature review may show that the Publication Series on Dangerous Substances prescribes old methods, and thus all three of the instruments are based on out dated methods. This is of importance to determine the validity of the instruments.

The reviewed literature will be discussed in three separate parts. First, the literature about BLEVE's is discussed. Second, the literature about VCE's is reviewed.

In the last paragraph, literature about interaction of blast wave and urban geometries will be reviewed to study if the behavior of pressure waves is influenced by urban geometries.

3.1 BLEVE

The current method to calculate blast overpressure in the Publication Series on Dangerous Substances is the Baker method developed in 1977, described by Doormaal [2005] in the Yellow Book. This method is based on thermodynamics of an ideal gas, and calculates the internal energy difference before and after the expansion.

The TNT equivalence method, also described by Doormaal [2005] in the Yellow Book, is comparable with the Baker method. Also based on thermodynamics, the released expansion energy is recalculated to an equivalent weight of TNT. This TNT method is based on detonations, while industrial explosions are deflagrations. Detonations and deflagration differ in explosion mechanism, and will be discussed in chapter 3.3.1, Part II of this thesis. This mechanism makes a difference in the peak pressure in the near field results. For the far field results however, the difference is negligible.

According to van den Berg et al [2004], there is little knowledge about the amount of fuel released. In the previous methods, it is assumed that the complete tank inventory will be released. This paper shows that the release rate and flash rate are important factors in determining the peak pressure.

When the inventory is released due to an instantaneous failure, the peak pressure will be significantly higher than a nearly instantaneous release which may take only a fraction longer. A ductile failure can be seen as a nearly instantaneous release, and approaches the reality of tank failure better than an instantaneous release.

The flash rate is influenced by the cooling effect of the evaporation process. While liquid from the tank flashes into the gas state, the remaining liquid is cooled and flashes at a lower temperature and thus at a lower rate.

Planas-Cuchi et al [2004] considers the BLEVE an adiabatic and irreversible process. This describes the reality more in a sense that in previous methods an immediate equilibrium between liquid and vapor at atmospheric pressure and temperature is assumed. This means that there is less fuel which contributes to the expansion energy. The mass of fuel in the vapor cloud is smaller. Furthermore, calculations are performed with the real properties of the substance instead of average values.

According to Casal et al [2000], the super energy, which is the energy released in the explosion, is only 3.5 to 5% of the total energy content when the process is considered irreversible. Till now the released energy is estimated around 7 to 14% when the process is considered to be isentropic (adiabatic reversible process). The irreversible process approaches the reality better.

3.2 Vapor Cloud Explosions

The pressure effect of a VCE can be calculated with the use of the Multi Energy Method (MEM) developed in 1985 as described by Merck et al [2005] in the Yellow Book. The method assumes that only parts of a vapor cloud which are obstructed, generate pressure effects. The obstructed parts experience turbulence upon ignition, which is crucial for self driven combustions. The final peak pressure on a certain distance is determined by choosing the blast chart which is incorporated in the method of the Yellow Book.

Merkx et al [2000], reviews the MEM in an attempt to bring it more up to date. Flow field boundary conditions, material reactivity and the scale are presented in a parameter combination. The parameters however show poor results when compared with experimental data. Furthermore, this paper shows that the evaluation of the parameter combination is not always straightforward. The determination of flame path length and average obstacle diameter requires further research.

The pressure depends on the speed of combustion ie the flame front propagation. Baker et al introduces a method to determine the flame front propagation in which the obstruction, fuel reactivity and confinement are taken into account.

Clutter et al [2001] shows that a CFD tool with the implementation of a constant flame speed gives a good estimation of the blast strength. The flame speed depends on factors such as confinement and fuel reactivity.

The Shell Code for Overpressure Prediction in gas Explosions 3 (SCOPE 3) Puttock [2000] is based on physical effects like flame propagation and laminar and turbulent burning. This method, different from the method in the Yellow Book, is according to the authors, the most reliable model.

3.3 Interaction Blast Waves and Urban Geometries

The existing techniques for calculating the blast effects on buildings are based on the assumption that the building experiences a load, as if it was isolated in an open space. This is described in the Green Book part 2B [2003].

Remmenikov et al [2005] takes into account the presence of other buildings. A two building configuration test is carried out which shows the shadowing effect and the enhancement due to reflection. When compared with the isolated single building configurations, pressure en

impulse enhancement factors can be derived for shadowing and reflection effects. A second part of the paper deals with blast wave propagation in city streets. A configuration of a straight street and a T junction at the far end shows that the blast wave, when compared with the isolated configuration, is conserved due to confinement of the city street.

Rose et al [2001] takes the width of streets, and the building heights bordering the street, into account. When streets are too wide (scaled width: $w/W^{1/3} > 4.8 \text{ m/kg}^{1/3}$), and bordering buildings too high (scaled height: $h/W^{1/3} > 3.2 \text{ m/kg}^{1/3}$), no enhancement effects on the positive impulse phase will occur. The reflection is too slow, due to the width, to enhance the pressure. The negative impulse phase however, is less straightforward than the positive impulse phase. Due to clearing at the top of the building the negative impulse phase is enhanced. A scaled height of $h/W^{1/3} = 3.2 \text{ m/kg}^{1/3}$ can be considered the effective maximum. Finally, when a street exceeds a scaled distance of $2 \text{ m/kg}^{1/3}$ measured from the centerline, the negative impulse phase has a bigger amplitude than the positive impulse phase.

Rose [2003] presents the investigation of the influence of a few types of street junctions on blast wave impulses. This research was carried out with a constant street width, and a constant, infinite, building height. The degree of confinement determines the conservation of the blast wave after it passes the junction. A four road crossing has less confinement than a T junction. Furthermore, the stand off distance from charge to junction influences the extent of diffraction at the junction. Diffraction is greater at larger stand off distances. Finally, the portion of a blast wave which propagates through a 90 degree angle in a street shows the same propagation pattern as for a straight street.

The enhancement factors for the impulse can be of important influence. Impulse magnitude seems to be the governing factor in determining damage levels in confined blast wave scenarios. According to Smith et al [2000], impulses can increase three or fourfold, when compared with unconfined situations where the charge is at the same distance.

4 Methodology

In order to answer the research question a few steps are distinguished in the research process. These steps are further explained in 4.1.

4.1 Outline of the Research

The first step is the calculation of the physical effects of a warm BLEVE. The physical effects determine the results of both the deterministic and the probabilistic approach.

The second step is a deterministic approach. A deterministic approach is carried out to study how the different instruments calculate effects and risk contours. This also shows the influence of the effects on the risk contour plots.

The third step is the execution of the probabilistic approach. The probabilistic approach addresses the physical effects simulated in an urban area. This shows how the instruments take presence of population into account which is an important parameter when the result for the societal risk is desired. This also shows how the calculated risk contours in the probabilistic approach differ from the deterministic approach and may provide insight on decisive factors.

The execution of the various steps should provide enough insight to determine whether the applied instruments meet the criteria as set in the research question. An answer to the research question is provided in the conclusion.

4.2 Assumptions

From the previous it is already known that an accident with a pressure tank is of interest because a BLEVE study is desired. The BLEVE is chosen because the Publication Series on Dangerous Substances gives good guidance for the calculation of physical effects.

For the probabilistic approach railway transport is considered. This is done because there is a lot of transport activity in densely populated areas in the Netherlands, and rerouting of railway transportation is difficult given the limited availability.

The CBM calculations will be performed with MS Office Excel 2003, the RBM II calculations with v 1.1.1 build 7 and the SAFETI-NL calculations with SAFETI 6.5

4.2.1 Assumption Deterministic Approach

In order to calculate the physical effects, the following assumptions about the release of the tank inventory are made:

Containment (inventory)	Propane
Type of release	Instantaneous
Operating pressure	6,2 bar
Failure pressure	19,5 bar
Atmospheric pressure	1 bar
Tank capacity	49 tons 108 m ³ flammable gasses
Percentage of gas	30%
Shape of the tank	cylindrical placed horizontal

Propane is chosen because it is a flammable gas which is transported under pressurized conditions.

The release of the tank inventory is assumed to be instantaneous. This is also a conditional assumption when BLEVE's are studied.

The other figures are all taken from the example of the warm BLEVE as calculated by Doormaal [2005] in the Yellow Book.

The applied method to calculate the pressure effect is according to the Baker method, developed in 1977, as described by Doormaal [2005] in the Yellow Book.

The method to calculate the fire effect is according to the Cowley -Bagster method, developed in 1990, and described by Engelhard [2005] in the Yellow Book.

4.2.2 Assumptions Probabilistic Approach

In order to execute the Probabilistic approach additional assumptions are necessary.

The investigated case is the area around the train station of Tilburg west. The transport route intersects here through a densely populated residential area. Tilburg west is situated on the Brabant route, which connects the port of Rotterdam with the Ruhr area in Germany.

The probabilistic frequencies (pf) are according to the Purple Book part two.

The population present is accounted for by the assumption that in every house 2.4 persons are present. One house is assumed to have a surface area of 100m².

There is a distinction made between the apartment buildings en the residential area due to a difference in population density.

The number of transports of flammable gasses is set at 4400 wagons per year according to Blaas [2003]. ($N_{\text{trans}} = 4400$)

The damage models which determine the lethal dose of radiation are according to the Purple Book. The lethal dose of radiation is calculated and presented in paragraph 4.2, and is denoted from now as $\text{fraction}_{\text{lethal}}$ (f_{lethal}). In theory it is possible to calculate a lethal dose for distances with an infinitesimal small interval. In this case a discreet model is applied with a grid size of 8 x 8 m², which meets the requirements of the Purple Book.

Extra assumptions per method are sometimes necessary because of computational limitations. These extra assumptions are carefully considered to be able to compare the obtained results. These extra assumptions are mentioned for each of the methods in the subparagraph which addresses the results.

5 Case Study

The results of the case study are presented in this chapter. The case study is carried out with the assumptions from the previous chapter. The results for the deterministic approach are presented in 5.1. The results for the probabilistic approach can be found in 5.2

5.1 Deterministic Approach

The physical effects were calculated with the use of the following three instruments:

- Excel calculations based on the QRA guidelines which are imbedded in the Publication Series on Dangerous Substances. These calculations are denoted as CBM, and can be found in *Appendix A*
- RBM II, the output can be found in *Appendix B*
- SAFETI-NL output can be found in *Appendix C*

5.1.1 CBM Deterministic Results

Figure 4.1 shows the distance pressure diagram, calculated with the use of the CBM. The figure shows a very strong pressure decrease in the first 20 meters. This can be explained by the fact that the CBM calculates explosions as free field explosions. Free field explosions show a very rapid decay of pressure.

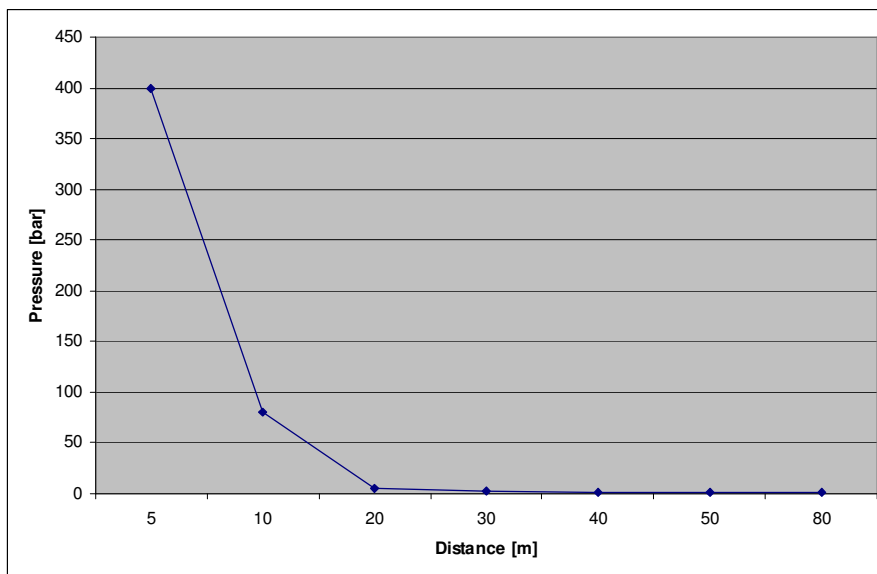

fig 4.1 Distance Pressure diagram according to CBM for a warm BLEVE

Figure 4.2 shows the distance Lethality diagram caused by the pressure effect. This is based on the damage models taken from the Purple Book. The figure shows a very strong decay in lethality on a very short distance interval. This is caused by the assumption of the Purple Book that people subjected to 0,3 barg ($0\text{m} < \text{distance} < 50\text{ m}$ from explosion) suffer lethal injury, and outside the 0,3 barg boundary have a 100% survival probability ($\text{distance} > 50\text{m}$).

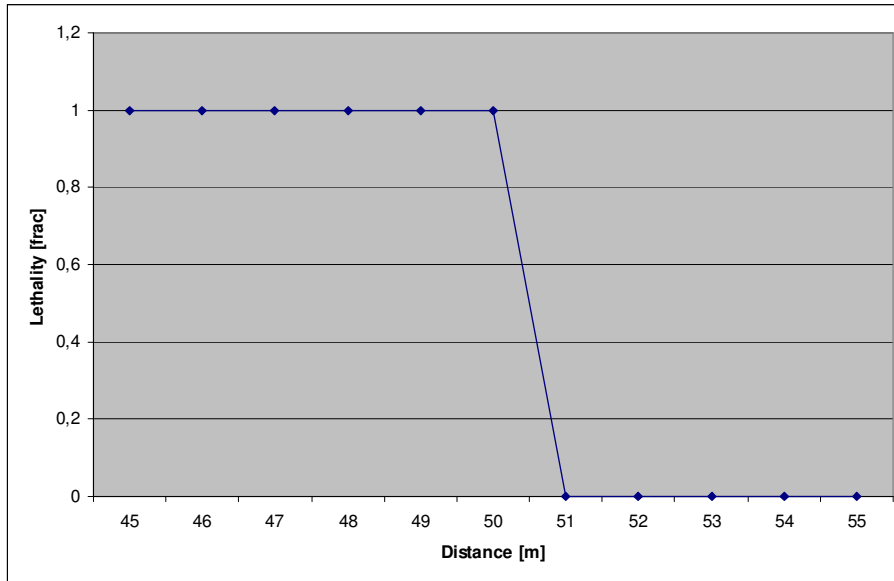

Fig 4.2 Distance Lethality diagram due to pressure effect according to CBM for a warm BLEVE

Figure 4.3 shows the distance radiation diagram caused by the fire effect of a warm BLEVE. The graph shows in the mid region a almost linear relation between distance an radiation.

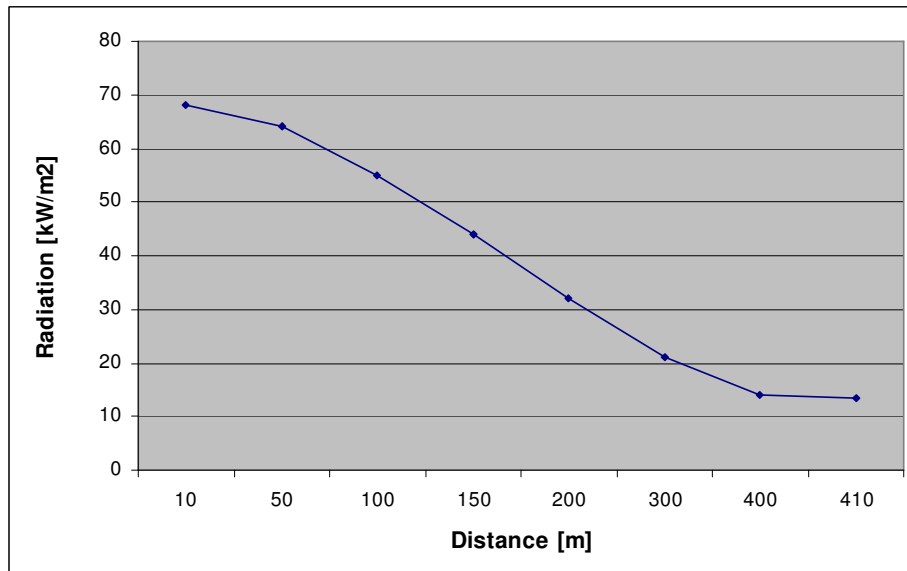

Fig 4.3 Distance Radiation diagram due to fireball according to CBM for a warm BLEVE

Figure 4.4 shows the Distance Lethality diagram caused by the fire effect of a warm BLEVE. The results show a very steep decay in the region between 200 and 300 meters. At approximately 200 meters the 100% lethality border is calculated. This is equal to a radiation dose of 35 kW/m². This explains why the first 200 m in fig 4.4 show a lethal probability of 1. The figure is created with the use of the damage models from the Purple Book. How physical effects are related to lethal probabilities is shown in *Appendix D*

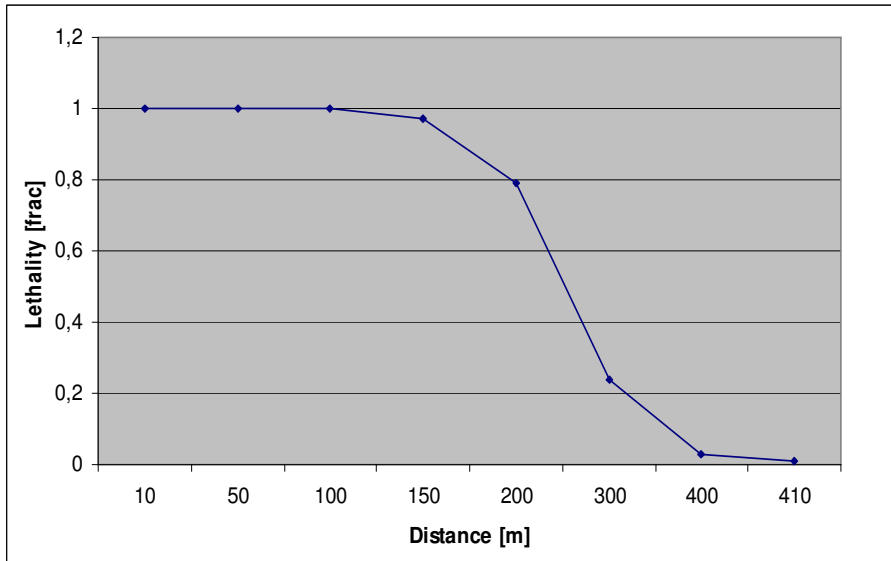

Fig 4.4 Distance Lethality diagram due to pressure effect according to CBM for a warm BLEVE

Figure 4.5 shows the distance lethality diagram for both the fire and pressure effect. This diagram shows that the fire effect is the dominant effect for lethality calculations for human beings, since lethality caused by fire spreads over a greater distance.

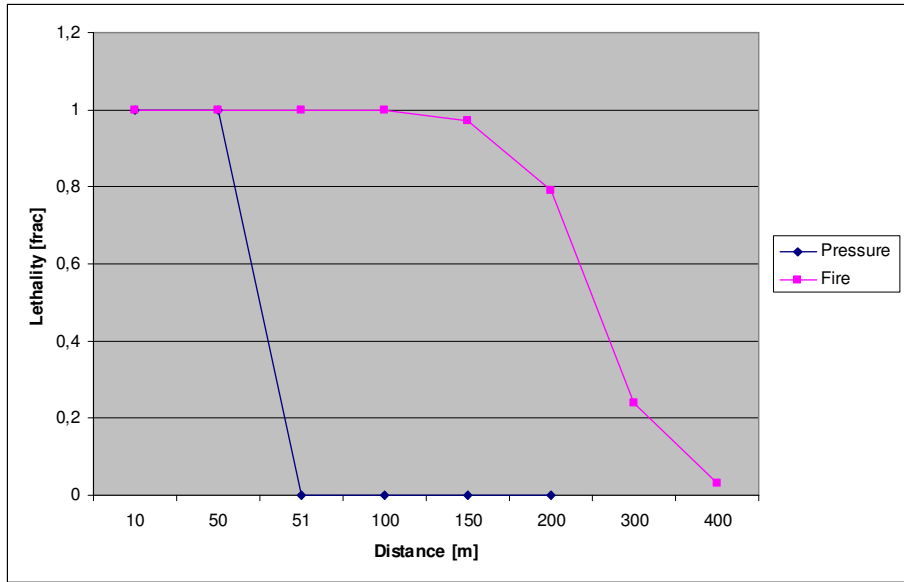

Fig 4.5 Distance Lethality diagram for both pressure and fire effects caused by a warm BLEVE

5.1.2 RBM II Deterministic Results

RBM II does not calculate pressure effects. The fire effect of a warm BLEVE are as shown in figure 4.6.

Figure 4.6 shows the Distance Radiation diagram for the fire effects according to the RBM II method. In the same diagram the results are shown according to the CBM.

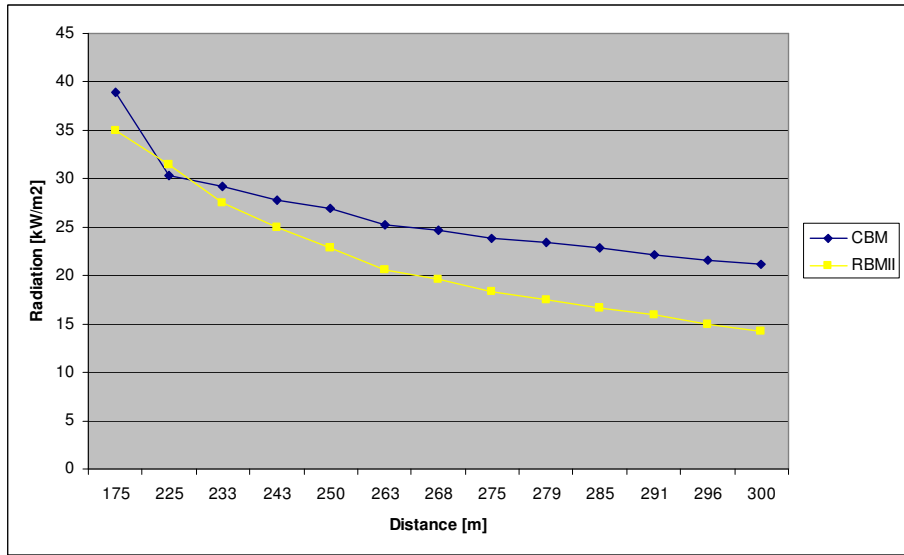

Fig 4.6 Distance radiation diagram due to fire effect for CBM and RBM II method

The methods do not show agreement, and the average difference of the measured points between the CBM and RBM II is approximately 18 %.

Figure 4.7 shows the distance lethality diagram according to the RBM II method and the CBM

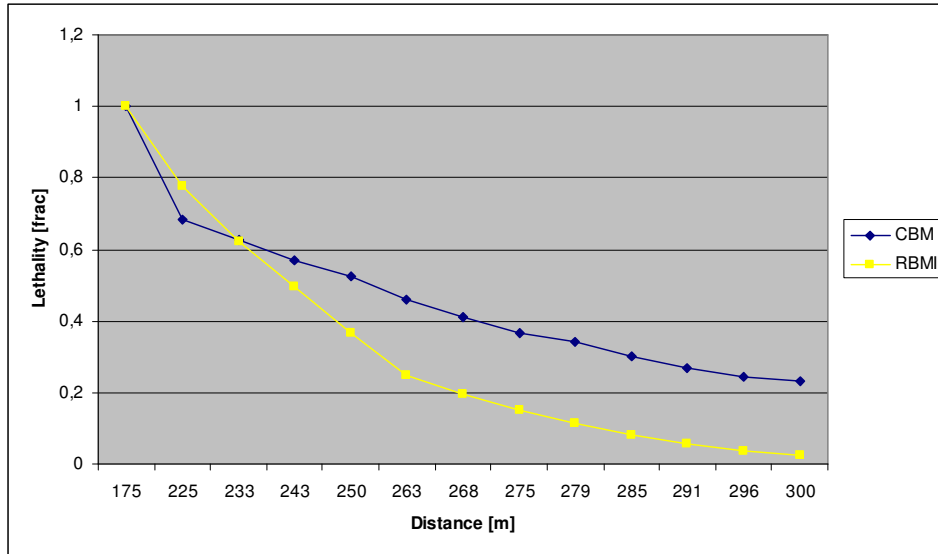

Fig 4.7 Distance Lethality diagram due to radiation according to CBM and RBM II method

The measured points in the distance lethality diagram differ on average 18 % from each other. Notice that in the calculation of the fire effect the CBM is more conservative when compared with RBM II. The Distance lethality diagram shows the same trend.

The determination of the lethality at a given distance is derived by the radiation dose at this distance. This is further explained in *Appendix D*

5.1.3 SAFETI-NL Deterministic Results

Figure 4.8 shows the result of the radiation calculation according to the SAFETI-NL method.

The diagram also shows the results of the CBM at the given distances. Both the methods are in good agreement with each other. The average difference between the measured points of the methods lays around 5%. The results of the CBM show higher figures for radiation and is therefore considered to be more conservative.

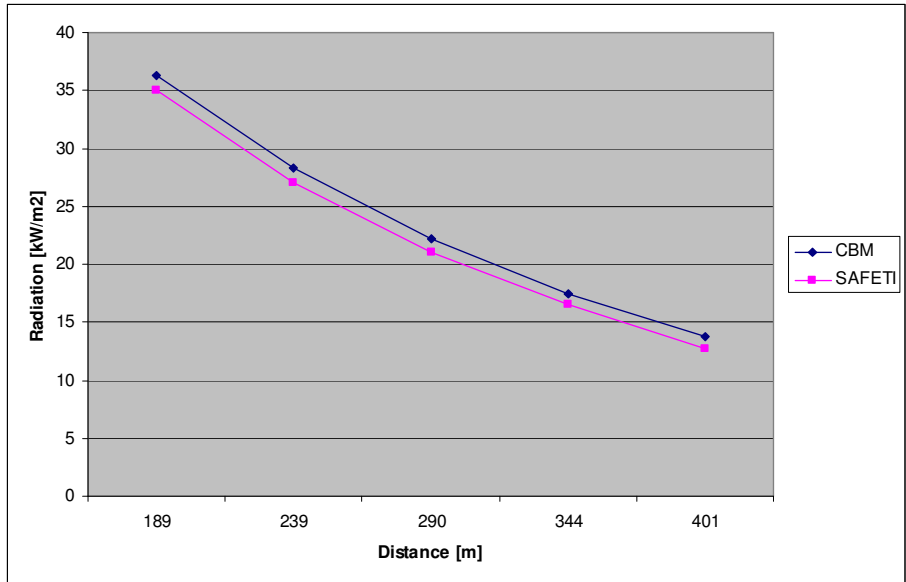

Fig 4.8 Radiation effect caused by warm BLEVE according to CBM and SAFETI-NL

Figure 4.9 shows the Distance Lethality diagram due to radiation dose, of both CBM and SAFETI-NL. The methods show a good agreement and the average difference in of measured points of the methods stays within 5%.

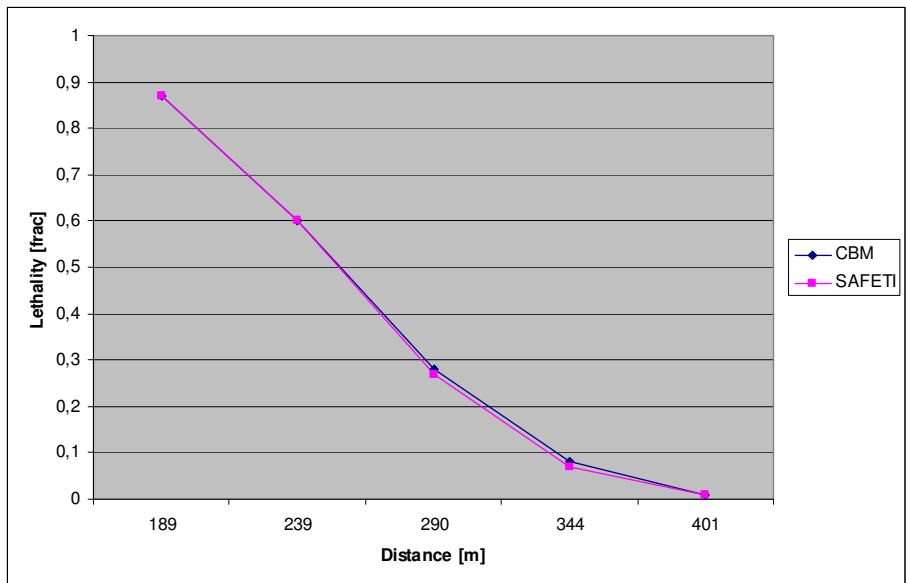

Fig 4.9 Distance Lethality diagram due to radiation dose according to CBM and SAFETI-NL

5.1.4 Results of Risk Contours

CBM

Figure 4.10 shows the CBM risk contour plot. This is directly derived from the Distance Lethality diagram as shown in fig 4.4:

Contour 1 lethal probability 100% at a distance of 196 meter

Contour 2 lethal probability 50% at a distance of 252 meter

Contour 3 lethal probability 10% at a distance of 330 meter

Contour 4, 5 and 6 lethal probability resp. 1×10^{-6} , 1×10^{-7} en 1×10^{-8} at a distance of approximately 400 meter.

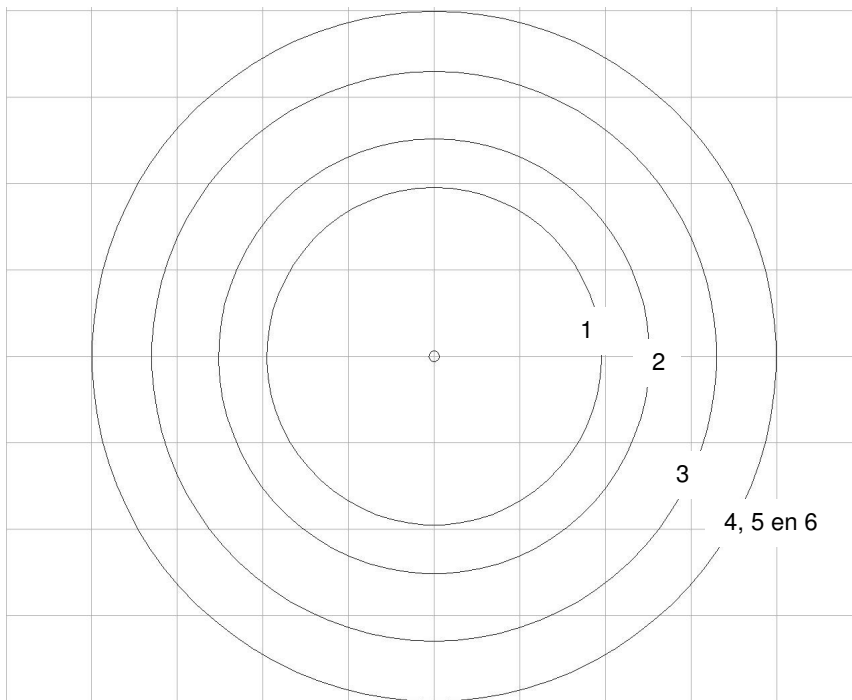
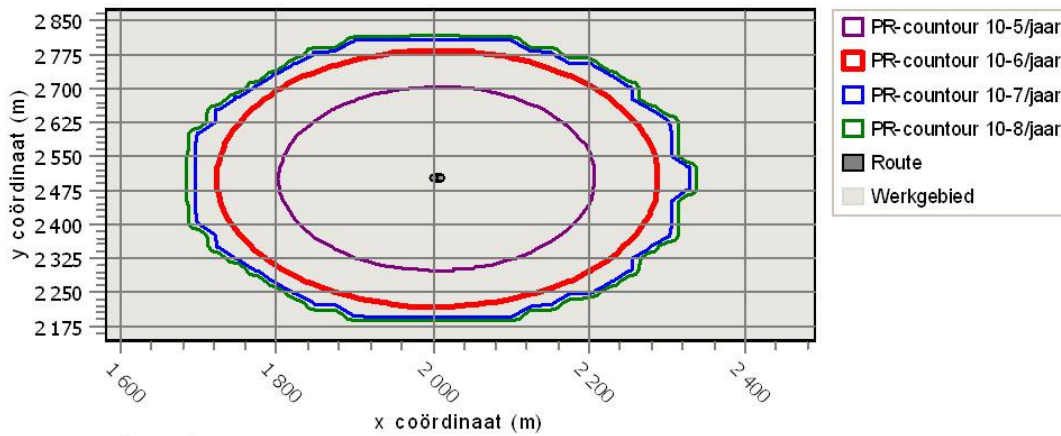

fig 4.10 Risk contour plot according to CBM on a 100 x 100 m² grid

RBM II

Figure 4.11 shows the risk contour plot according to the RBM II method. This should be directly derived from the the Distance Lethality diagram as shown in figure 4.7.



Figuur 1

1.2 Gemiddelde afstand tot de contouren

Contour	Afstand	Eenheid
10-5 contour	199	m
10-6 contour	279	m
10-7 contour	310	m
10-8 contour	320	m

fig 4.11 Risk contour plot according to RBM II SAFETI-NL

Figure 4.12 shows the risk contour plot according to the SAFETI-NL method. This plot should be directly derived from the distance lethality diagram as shown in figure 4.9.

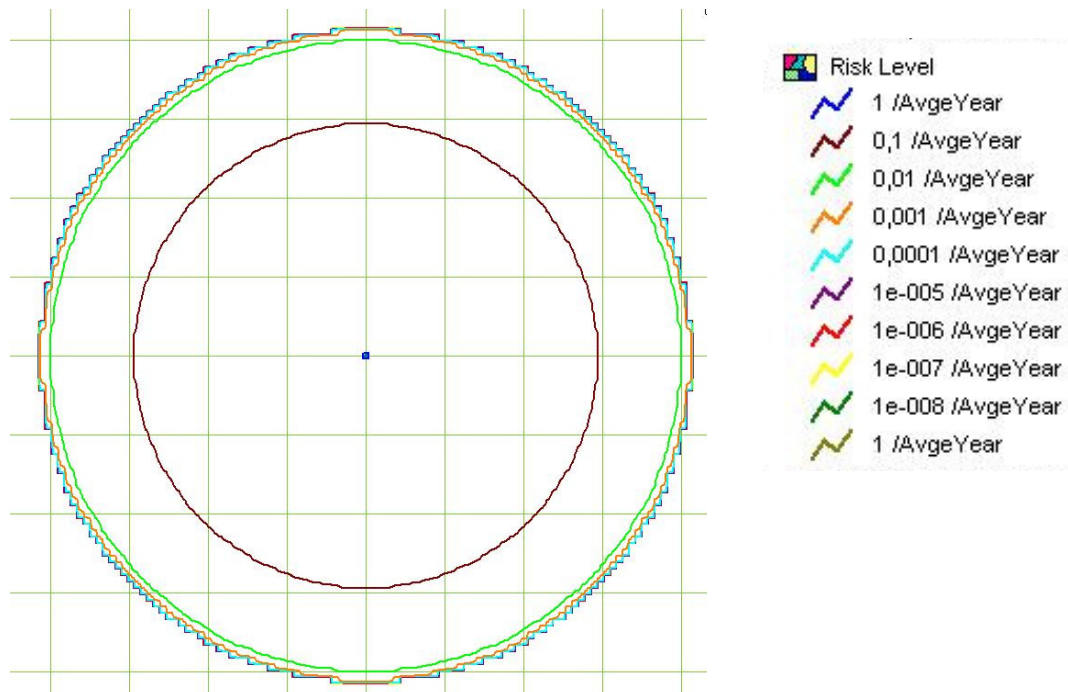

Fig 4.12 Risk contour plot on a 100 x 100 m grid according to SAFETI-NL

The 10% risk contour is plotted at a distance just under 300 meters. The remaining contours with a risk level of 1×10^{-2} , 1×10^{-3} , 1×10^{-4} and 1×10^{-5} average per year are plotted at approximately 400m.

5.1.5 Discussion of Deterministic Results

In this subparagraph the results of the deterministic approach are briefly discussed.

Assuming the CBM being the benchmark will not guarantee that the method is the best possible approach of the reality. This is also shown in the master thesis “Het risico van externe veiligheid” by J.H. Raemakers (Eindhoven University of technology 2007). The conclusion of this research is that the results of the CBM do not approach always the reality.

Furthermore, the methods applied to calculate the physical effects of a BLEVE are out dated, as shown by the literature review.

According to the Yellow Book, the fire effect will be dominant over the pressure effect. The pressure effect will stretch over a smaller distance, and will reach fewer casualties.

The physical effects calculated by RBM II are not in agreement with the CBM.

The average error for the radiation pre given distance is around 18%. The values calculated by RBM II, are systematically lower then the CBM values.

The distance lethality differ from the CBM as much as 20%, and the calculated values from RBM II are again systematically lower than the CBM values.

The plot of the risk contour levels should be solely dependent of the distance lethality calculations. The RBM II contour plot however, plots contours of small risk levels on places where the risk is actually bigger. This is due to the calculation procedure of the program. It spreads the risks over one year.

The effect calculations made by SAFETI-NL, are in good agreement with the CBM. For both the distance radiation as for the distance lethality values, the difference stays within 5%, where CBM is the more conservative one of the two.

The plot of the risk contour shows only for the higher risks a difference. The difference stays here within 10%, where the CBM is the conservative one. The lower risks are in agreement with the CBM.

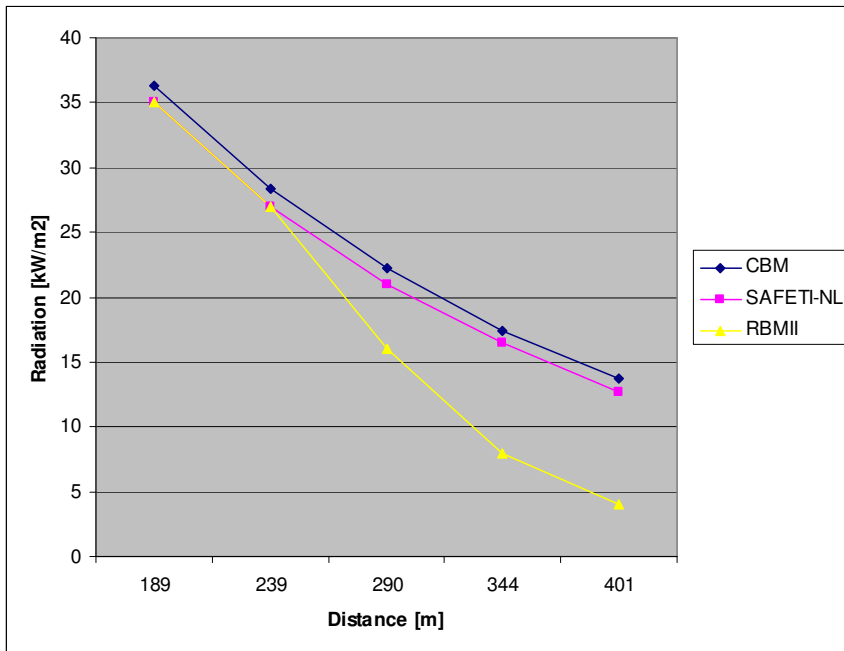

Fig 2.3 Distance Radiation diagram caused by a warm BLEVE

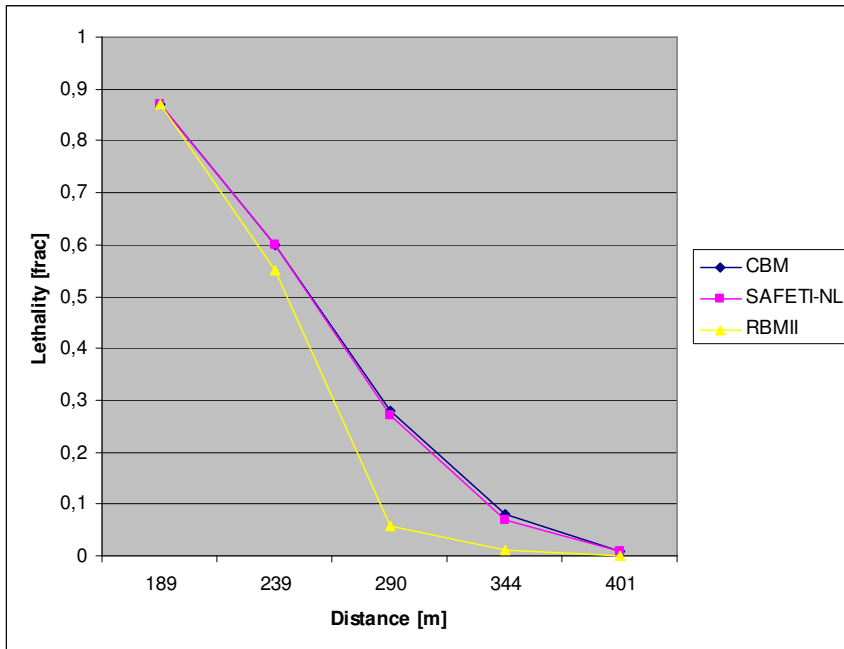

Fig 2.4 Distance Lethality diagram shows lethal radiation effect on people in the vicinity of a warm BLEVE

5.2 Probabilistic Approach

The physical effects are now known and can be used for the probabilistic approach. Neither the roughness of terrain, nor the whether has influence on the sequence of events when a BLEVE occurs or on the physical effects of a BLEVE.

5.2.1 CBM Probabilistic Results

For the calculations, see *Appendix A* for CBM

Extra assumptions

The frequency is set at 3.63×10^{-8} , for the failure of a tank wagon per traveled kilometer.

$$(2,2 \times 10^{-8} \times 1,26) + (3,3 \times 10^{-8} \times 0,26) = 3,63 \times 10^{-8}$$

The frequency is composed out of the following parameters

- Initial failure frequency $2,2 \times 10^{-8}$;
- Correction factor for speed 1,26;
- Correction factor for points $3,3 \times 10^{-8}$;
- Average number of points per kilometer 0,26.

Results CBM

Figure 4.16 shows the probabilistic risk contour plot according to the CBM

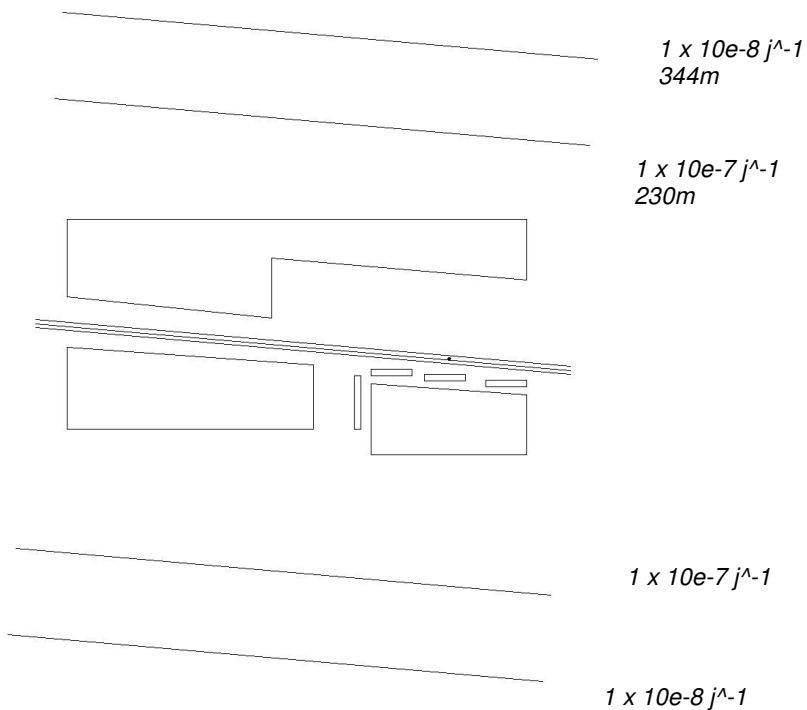

Fig 4.16 Probabilistic risk contours according to CBM

Figure 4.17 shows the FN curve for the propane case study.

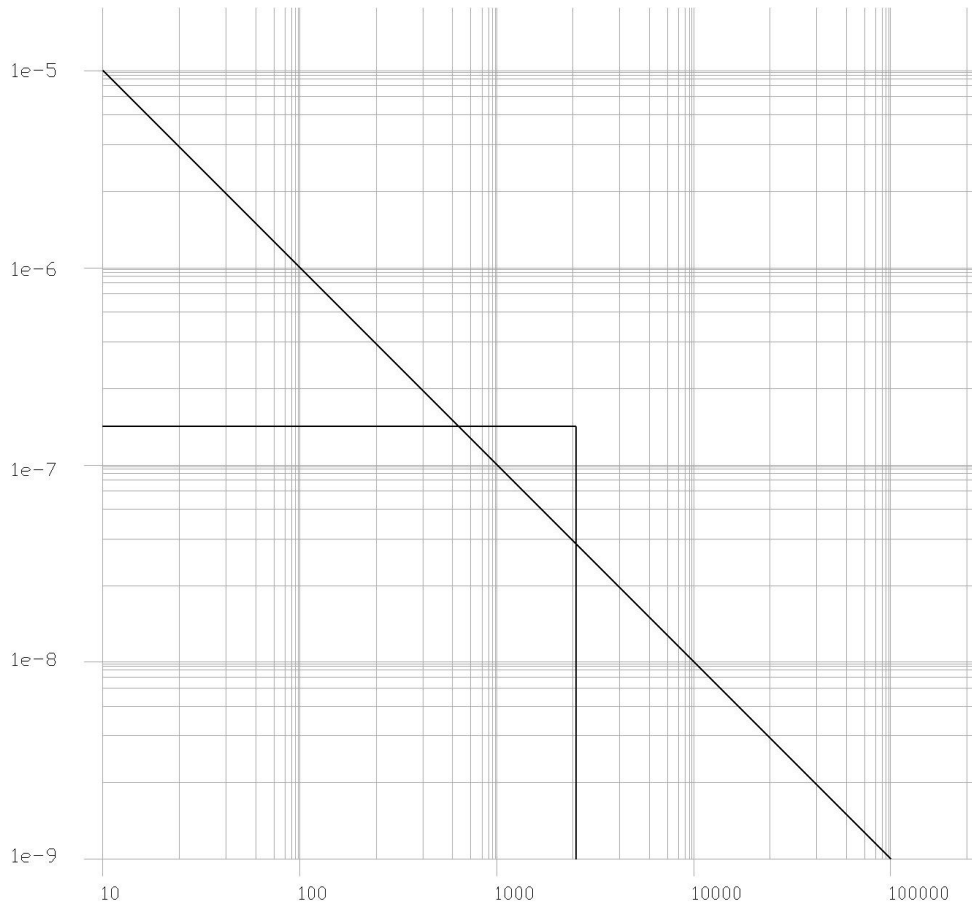

Fig 4.17 FN curve according to CBM

5.2.2 RBM II Probabilistic Results

For the calculations, see *Appendix E* for RBMII

Extra assumptions

Weather station	Gilze Rijen;
Type of railway track	High speed track ($V > 40$ km/h) correction factor for speed is applied automatically by the program;
Width of track	10 m (double track).
Frequentie	$2,2 \times 10^{-8} + (3,3 \times 10^{-8} \times 0,26) = 3,05 \times 10^{-8}$ Same as the CBM only without correction factor for speed

Population presence calculated per m² (in previous CBM pop precense was per 64 m²)
 Apartment buildings 6,4 pers / gridcel (= 64 m²)
 Residential area 1,82 pers / gridcel (= 64 m²)

Apartment buildings

Day 6,4 x 0,7 = 4,48 (0,7 present during the day as shown in table 5.1 Purple Book)
 4,48 / 64 = 0,07

Night 6,4 x 1 = 6,4 (1,0 present during the night as shown in table 5.1 Purple Book)
 6,4 / 64 = 0,1

Residential area

Day 1,82 x 0,7 = 1,27 (0,7 present during the day as shown in table 5.1 Purple Book)
 1,27 / 64 = 0,0199

Night 1,82 x 1 = 1,82 (1,0 present during the night as shown in table 5.1 Purple Book)
 1,82 / 64 = 0,028

Results RBM II

Figure 4.18 shows the result of the probabilistic risk contour plot.

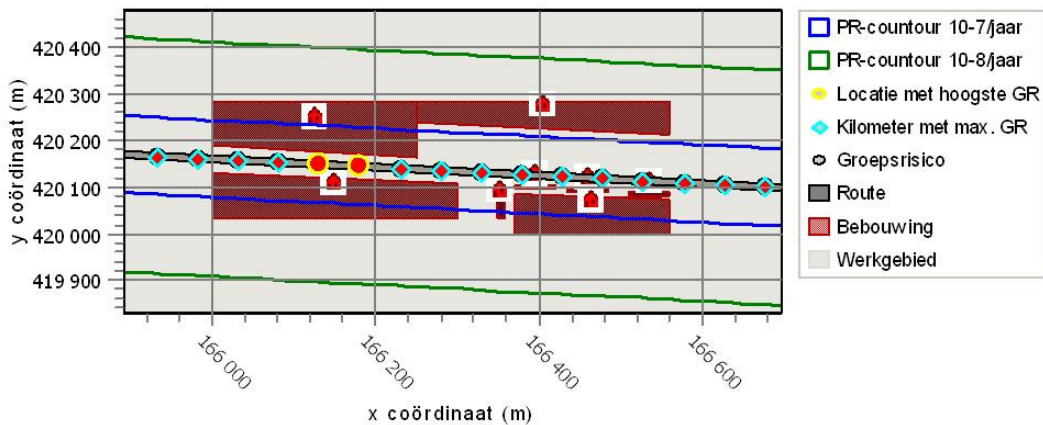

Figuur 1

1.2 Gemiddelde afstand tot de contouren

Contour	Afstand	Eenheid
10-5 contour	Niet aanwezig	
10-6 contour	Niet aanwezig	
10-7 contour	74	m
10-8 contour	242	m

Fig 4.18 Probabilistic risk contours according to RBM II

Figure 4.19 shows the FN curve for the propane case study as calculated by RBMII

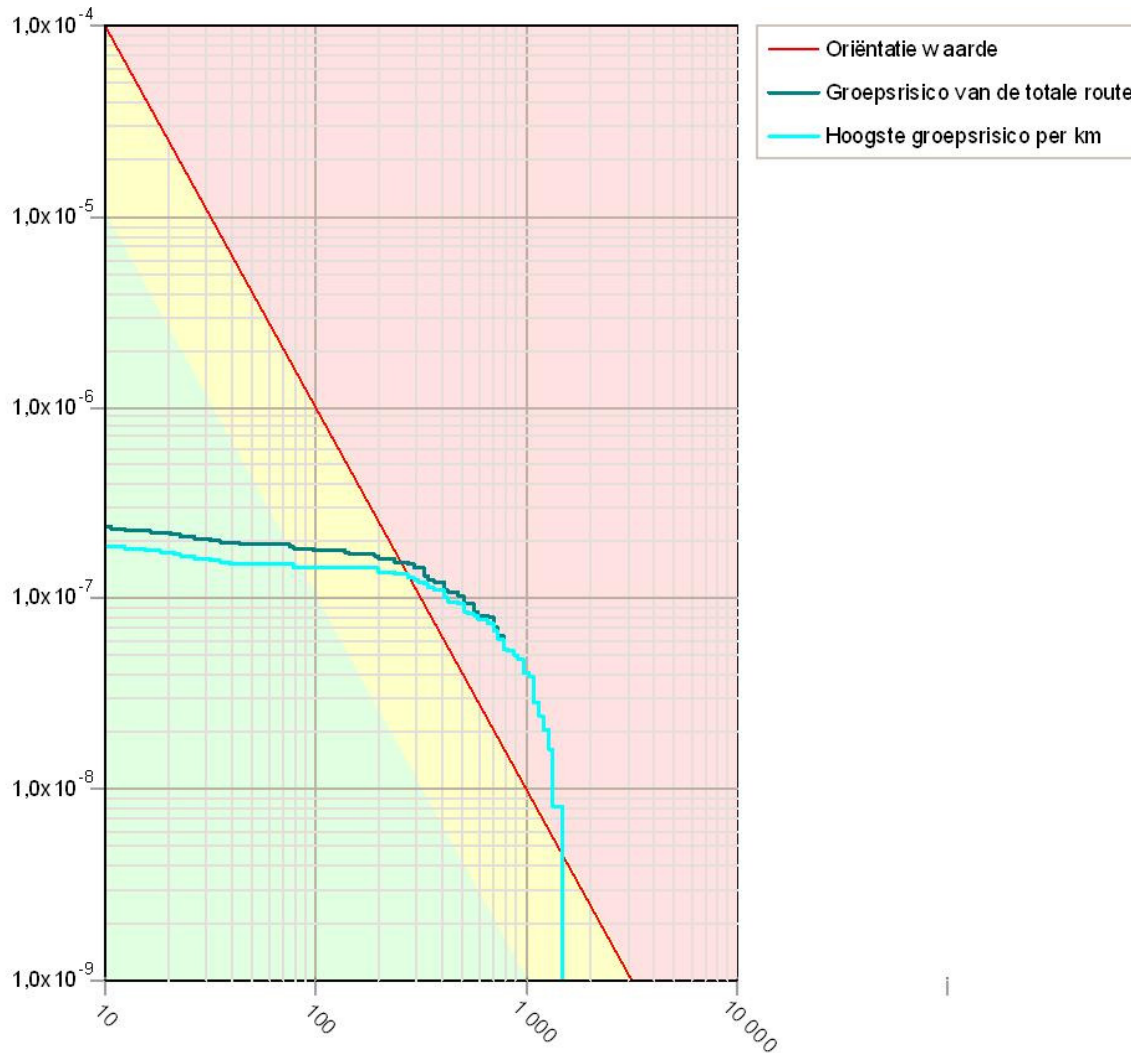

Fig 4.19 FN curve according to RBMII

5.2.3 SAFETI-NL Probabilistic Results

For the calculations, see *Appendix F* for SAFETI-NL

Additional assumptions

In order to model a transport installation, it is necessary to model a transport line in SAFETI-NL. On this transport line, a loss of containment event (LOC) has to be assigned on a fixed interval, in this case 1 km.

The ignition is modeled as a line ignition. This model represents the electric power line above the railway tracks.

Results SAFETI-NL

Figure 4.20 shows the probabilistic risk contours plotted on a 100 x 100 m² grid

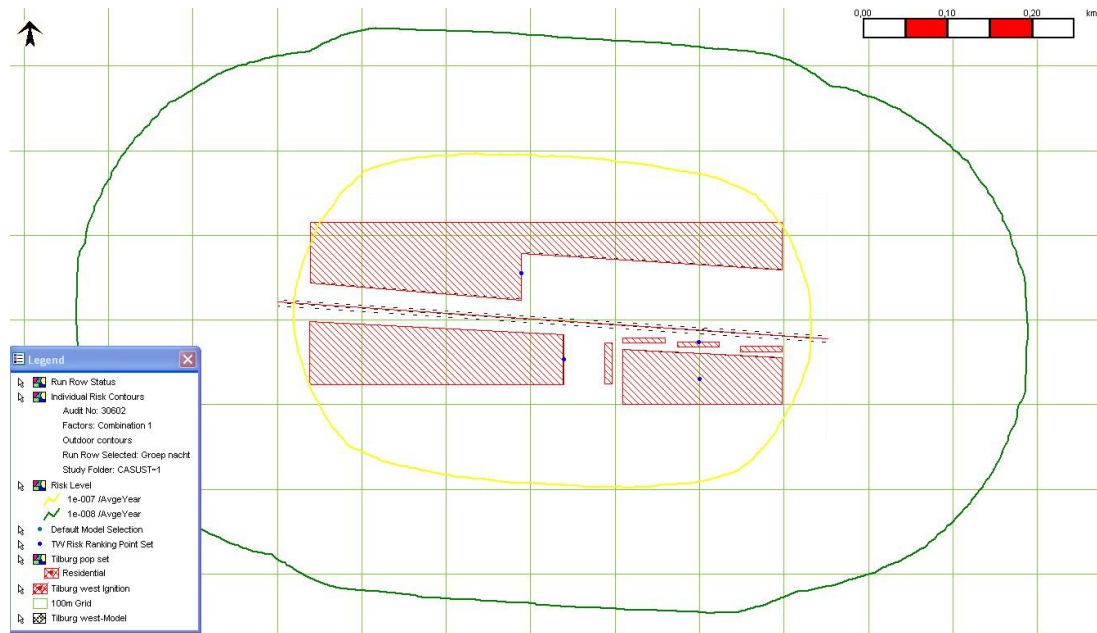

Fig 4.20 Probabilistic risk contours according to SAFETI-NL: 1×10^{-7} at app 200m, 1×10^{-8} at app 320m

Figure 4.21 shows the FN curve for the propane case study according to SAFETI-NL

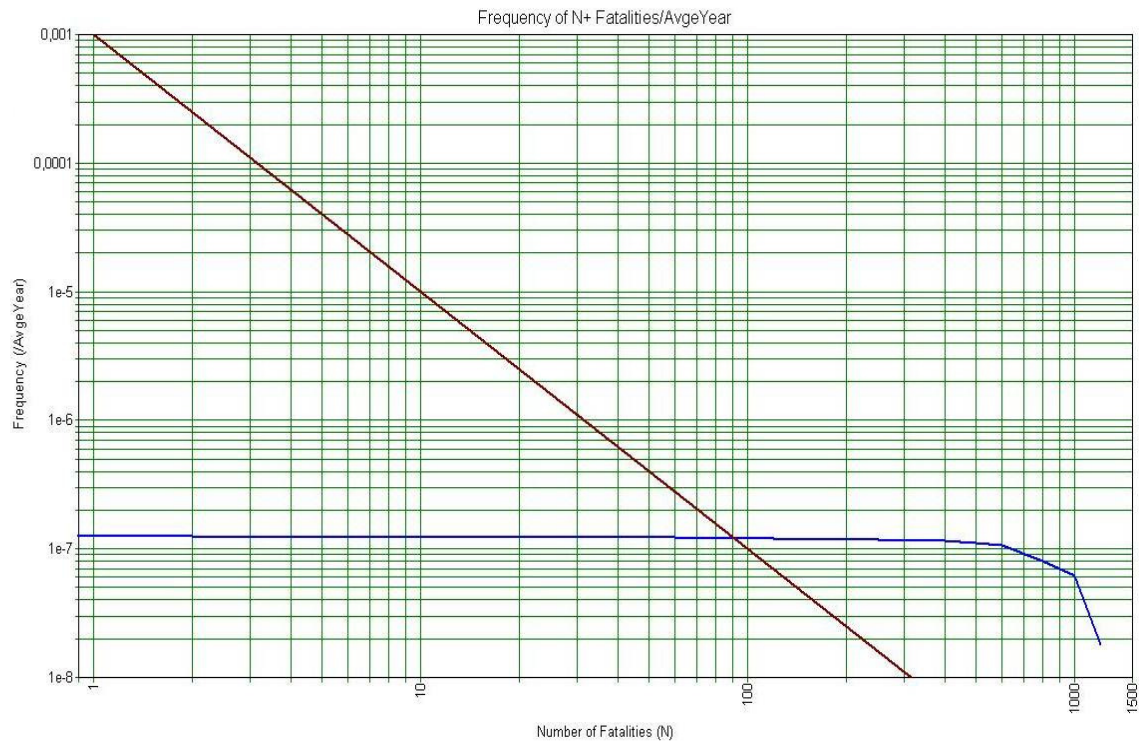

Fig 4.21 FN curve according to SAFETI-NL calculates app 1500 casualties

5.2.4 Discussion of Probabilistic Results

The calculation of the individual risk is based on the probability of death due to a lethal dose of heat radiation at a certain distance and the probabilistic frequency

The calculation for the societal risk shows that all the people in the case study (approx. 2200) will suffer fatal injury. When calculating the societal risk, the probability of death is dependant of the probability between two risk contours. The probability of death for people between two contours is determined by the lower value of the two contours. This leads to an underestimation of the probability of death for the people who are present closer to the upper value contour, then for the people present closer to the lower value contour.

The calculation performed by RBM II shows for the individual risks, as expected when conclusions of the deterministic risk contours are considered, a difference with the CBM.

The calculated scenario frequencies used for the calculation of the contours, are not in agreement with the Purple Book. The starting point however, the initial frequency, is kept the same as in the CBM calculations. The helpdesk of the program, explained the difference because of the number of C3 (flammable liquids) tanks in a train. The determination of a warm BLEVE depends also on the number of C3 tanks. This is not the same method as the Purple Book applies, where the accident frequency for a warm BLEVE is given by a ignition probability, and the type of train (not the number of different typed tanks). The calculation method of RBM II is explained in *Appendix G*

The calculation for the societal risk shows agreement with the CBM calculations, in case the numbers of fatalities is considered.

The calculation performed by SAFETI-NL shows for the individual risk agreement with the CBM. The difference is in the order of 13% for both of the calculated contours. SAFETI-NL draws the risk contours closer to the accident site then CBM.

The FN curve as the result of the societal risk calculation however shows a difference with the CBM. Where the CBM calculates that all the people in the case study will suffer a lethal heat radiation dose, SAFETI-NL calculates only 1000 to 1500 lethal casualties. According to the RIVM this is because there is no point on the transport route where the 100% lethal radiation dose (35 kW/m²) covers the entire population.

6. Conclusions & Recommendations

6.1 Conclusions

To determine whether the instruments fulfill the criteria stated in the research question, the test criteria are first to be defined:

- **Transparent:** is there clarity about the applied methods to which lead to the results?
- **Robust:** are the results reproducible by different users? Do the results depend on the version of the software used?
- **Verifiable:** Is the source which lies underneath the assumptions for the determination of failure frequencies and physical models still available?
- **Valid:** are the results of the calculations reliable?

6.1.1 Transparent

All three of the methods are based on the Publication Series on Dangerous Substances, and for all three of the methods are therefore known.

When the CBM is applied, the methods of calculation are known.

When RBM II is used for risk assessment, the methods for the calculation of the risk contours and the accident frequency is clear, but cannot be recalculated with the use of the Publication Series on Dangerous Substances. The method for the determination of the effects is known but shows a difference when compared with the CBM.

The SAFETI-NL method shows good agreement with the CBM. This allows the user to know which methods are used. This is the case for both the risk calculations and the calculations of physical effects.

CBM and SAFETI-NL are both transparent; RBM II is, due to difference in answers, not completely transparent.

6.1.2 Robust

When the societal risk is calculated the assumed number of people present during an accident can differ per user. People who are present in the risk zone who's staying is considered permanent, are accounted for in the risk analysis. People that are present in the vicinity of the accident area during a very short period, for instance people in cars or waiting for the train, can

be accounted for in different ways by different users since the Publication Series on Dangerous Substances gives no guidance. This difference in interpretation affects all three of the methods, and can only be avoided if there is a strict agreement about the assumptions of temporarily stays.

The accident frequency in RBM II can vary because of different options in the program. When the number of crossings is adjusted for example, the accident frequency is adjusted without notifying the user. When this parameter is changed back to its original value, the accident frequency stays unchanged. Users have to pay close attention to this.

This research is carried out with one version per software package. Therefore it is impossible to make a statement about the influence of the used version

All three methods are robust, under the condition that for all three of the methods the assumptions are exactly the same.

6.1.3 Verifiable

Since RBM II and SAFETI-NL are based on the Publication Series on Dangerous Substances, one could argue that the source is available and thus the methods are verifiable.

Some of the accident frequencies however, are not in all cases well known. The Purple Book is not able in all cases to give the source of these frequencies. Since this is the case for Publication Series on Dangerous Substances, the three methods based on this suffer the same problem.

The methods are not completely verifiable.

6.1.4 Valid

The physical effect calculations in the Publication Series on Dangerous Substances are based on out dated models, which do not approach the reality. All three of the methods described here suffer this problem of inaccurate physical effect modeling.

The RBM II frequency calculations are, as mentioned before, not according to the publication series of hazardous good. Furthermore, the calculation of the risk contours does not show any agreement with one of the other methods. The physical effects show no agreement with the other two methods. So on top of using out dated models RBM II gives also different results.

SAFETI-NL does show agreement with CBM.

The physical effect calculations are based on assumptions which do not approach the reality. Therefore the three methods give no satisfying evidence of validity.

6.2 Recommendations

6.2.1 Physical Effects

The calculation methods in the Yellow Book are outdated. The methods described for the calculations of fire effects were developed in the mid seventies. Due to lack of knowledge at that time certain assumptions were made which do not fully coincide with the actual event of a BLEVE. An example is the assumption made in the publication series of hazardous materials that the BLEVE process is reversible adiabatic. As shown in the literature review, the BLEVE can be assumed irreversible to get more accurate calculations of the overpressure.

An update of the Publication Series on Dangerous Substances is recommended in order to make more accurate predictions of the effects caused by BLEVE's.

The Publication Series on Dangerous Substances assumes that the fire effect is always dominant compared to the blast effect in case of a BLEVE. Even more: the software packages do not even calculate blast effect.

Literature shows that blast waves can be conserved in city streets, and can apply their destructive force on greater distance than just in the vicinity of the accident site.

More knowledge about blast wave propagation can be used as an instrument for urban development in order to avoid strong canalization, and thus conservation of blast waves in case of an accident.

A study in blast wave development is also useful to study the structural loadings on buildings, and the building response. When the loadings are known an attempt can be made to bring surrounding buildings to a higher safety level. The study into structural loadings can be of particular interest when safe shelters are considered. It is important to know the blast loading for these kinds of shelters. Little fire protection can be offered in case of severe blast damage.

A detailed research into blast wave propagation in city geometries is recommended. This research could be carried out with the use of Computational Fluid Dynamics

6.2.2 Injury and Damage Models

The injury models for fires in the Green Book are based on animal testing. Further research could be carried out to determine whether the damage models are also applicable for human beings.

The injury modeling of pressure effects are based on empirical data and data obtained from helmet manufactures. Research of blast effects on human beings could also be carried out with the use of crash test dummies, as used in the automotive industry.

The damage model for blasts requires some adjustment. The model shows that, when a person experiences 0,3 bargauge overpressure this will cause lethal damage. In the region between 0,3 and 0.1 barg, the probability of death is equal to zero. A smooth transition between zero and 100% lethality would approach a real situation better.

Further research into the injury and damage models is recommended.

Probabilistic modeling is probably sufficient for local governments to justify risks. In order to give permits for storage manufacturing or transporting goods, the probabilistic approach offers a insight of the risk of an accident to occur and takes into consideration the follow up effects of an accident on the one hand, and allows urban development on the other hand.

For emergency services, the whole probabilistic approach is quite useless. This approach only takes the lethal casualties between the reduced (probabilistic) risk contours into consideration. In case of an accident, the physical effects which cause lethal casualties will stretch beyond the limited risk contours. A deterministic approach seems to be more appropriate for emergency services. The deterministic approach however, only takes lethal casualties into consideration and goes beyond the target group of emergency services: the severely injured but living casualties. In order to prepare emergency services for an accident, a method to count surviving injuries is recommended.

Part II: Explosion Modeling With the Use of Computational Methods

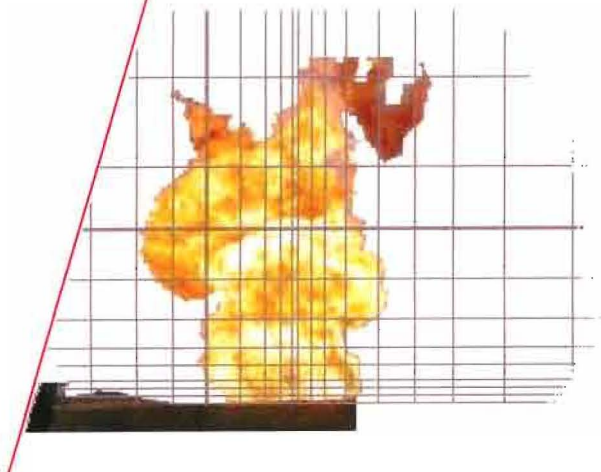

Part II: Explosion Modeling With the Use of Computational Methods

1. Introduction

When an accident with a pressure tank occurs, the tank can lose its inventory. If the inventory is released instantaneous a BLEVE will occur. When the inventory is released over a longer time period a vapor cloud will form in the vicinity of the accident site and can ignite. When the vapor cloud ignites, the burning of the vapor causes a pressure wave. This is also known as a Vapor Cloud Explosion (VCE).

The Publication Series on Dangerous Substances describes in the Yellow Book methods, of which the latest originates from the 1980's, to calculate the physical effects of the BLEVE and the VCE. The Yellow Book describes for the VCE a procedure to calculate the blast effects. The blast effects of the BLEVE are assumed as surface busts and thus ignored because the fire effects are assumed to be dominant for human casualty calculations, which is the main target for risk assessments.

The Publication Series on Dangerous Substances describes in the Green Book part 2B "Explosions Effects on Structures" a method to calculate the blast effects and the response on the structure. The Green Book only addresses simple urban configurations, namely a single building configuration.

The literature review of part one of this thesis shows that blast waves are affected by urban geometries. Blast waves can be conserved in street configurations, and can apply their destructive force at a greater distance when compared with surface blasts . Smith [1999, 2006], Rose [2002, 2003, 2006] and Remmenikov [2004, 2005]. Merckx [2000] shows that the prediction of overpressure in complicated configurations can be best estimated with CFD analysis to incorporate directional blasts.

It seems that the effect of blast waves in urban geometries is more complicated to predict than the straight forward method applied in the Green Book.

1.1 Problem Statement

The problem statement addressed in the underlying thesis is that, until now it is hard to predict the pressure development of blast waves in complicated urban geometries.

To study the blast wave propagation in urban geometries, data has to be obtained from experiments. Full scale and scaled tests are not feasible because this requires highly specialized recourses. This leaves the option for computer simulations to study airflows generated by explosions.

The study of numerical airflows can be carried out with the use of CFD codes. CFD stands for Computational Fluid Dynamics. A CFD code is a code, which solves an approximated form of the Navier Stokes equations numerically. The code provides the opportunity to simulate a wide range of problems in fluid mechanics.

There are many CFD codes available for licensed use for example: CFX, FLUENT, ANSYS etc. There are also codes available which deal specifically with gas explosions, for example: AUTOREAGAS, and the FLACS software package.

1.2 Research Question

The research question that needs to be answered is:

Is it possible to simulate a blast wave in an urban geometry, set off by a gas explosion, with the use of commercial numerical methods?

- In order to answer the research question a few sub questions are formulated:
- Which numerical methods are available?
- What are the limitations and disadvantages of these methods?
- Is it feasible to apply one of these methods in an urban geometry?

1.3 Scientific Relevance

The relevance lies in the fact that this thesis should provide insights in blast wave propagation in urban geometries. The study of blast wave propagation is of relevance when urban surroundings are designed.

The development of structural loadings, and the influence of the surrounding on the loadings, is also of relevance when the response of structures is studied. In order to develop buildings that can withstand blast waves, a detailed study of the building response is necessary.

1.4 Social Relevance

The social relevance of this research is the validation of the Publication Series on Dangerous Substances. The publication series shows in the Green Book, results for free air blasts and a calculation method to determine the loadings in case of a one building configuration. Validation will provide insights about the accuracy of the Green Book.

Further knowledge about blast wave development may show that physical blast effects reach further than currently assumed in the Yellow Book. This might lead in the long term in an adjustment of the physical effect calculation and will provide QRA assessments with a greater accuracy.

2 Literature Review

In chapter one, part II of this thesis it was established that the most appropriate way to study blast wave propagation in urban geometries is with the use of CFD software. This literature review is carried out to explore how blast waves are modeled in urban geometries using CFD and which problems arise when a numerical method is applied for modeling blasts. The issues discussed, focus on modeling blast waves and modeling the urban environment. This allows gaining knowledge about typical difficulties, and enabling to anticipate on these while this underlying research is carried out.

The current literature concerning explosion modeling in urban environments is carried out with supersonic models. There is no available literature found about subsonic gas explosions in urban environments. The literature review is therefore separated in different parts. A distinction is made between sub- and supersonic modeling and modeling the urban environment.

2.1 Subsonic Modeling

Van den Bergh et al [2004] uses for the investigation of blast effects of BLEVE's acoustic models. The acoustic models give a solution for the expression that relates the acoustic wave overpressure at some distance to the strength of the volume source. The used expressions however, only hold in the low (acoustic) overpressure regime. The manual of Ansys for example states that acoustic elements lose their accuracy when waves propagate with more than 100 m/s through them.

In the same paper van den Berg uses an Euler solver, which was developed by the author, to determine the peak pressure of the BLEVE blast effects.

Mercx et al [2000] uses CFD to investigate a parameter combination to take flow field boundary conditions into account for VCE's. The CFD package used is a special purpose software package for gas explosions called AUTOREAGAS. This code provides a gas explosion solver based on the Navier- Stokes equations or a blast solver (supersonic) based on the Euler equations.

The basic concept of a gas deflagration is according to Mercx modeled as a perfect gaseous fluid which expands as a consequence of heat addition.

Clutter et al [2001] shows a . A CFD tool with the implementation of a constant flame speed gives a good estimation of the blast strength, when compared with existing data. It is not known which CFD code Clutter uses for his study.

2.2 Supersonic Modeling

According to Mercx et al [2000] The inviscid Euler flow is justified for the computation of blast object interaction. In the literature supersonic flow problems (mach >1) are modeled with the use of compressible air.

A characteristic feature of blast flow fields is the presence of gas dynamic discontinuities like shocks for example. Proper computations of discontinuities or sharp gradients are a major challenge for CFD. To conquer this, higher order finite difference schemes can be applied but these show instable shock behavior. To deal with shock instability, a flux splitting scheme has to be introduced.

Wada et al [1997] gives an overview of the development of flux splitting schemes. Examples of flux splitting schemes are the Roe scheme, the van Leer scheme and the schemes developed by Gudonov. Recently added is the AUSM family by Liou and Steffen [1993]. AUSM stands for Advection Upstream splitting method. Further developments on the AUSM scheme are the AUSM+ and the AUSMDV scheme completes the family.

The research carried out by Smith [1999, 2006], Rose [2002, 2003, 2006] and Remmenikov [2004, 2005] all use the AUSMDV flux splitting scheme.

Smith, Rose and Remmenikov compare small scale high explosive (TNT) experiments with numerical simulations, in various street configurations, and attain satisfying results using the AUSMDV flux splitting scheme. The numerical simulations are based on detonations.

Supersonic flows or detonations can be considered as a self-propagating process where the state of the material is altered due to the compression of the shockwave according to Smith [2003]. The increase in pressure, temperature and density can occur in a very short time span and in a reaction zone which is very thin. This thin reaction zone is the shockwave and separates the compressed medium from the undisturbed medium. The high explosives which cause detonations are modeled in a group of computational (explosive) cells Smith [1999, 2006], Rose [2002, 2003, 2006] and Remmenikov [2004, 2005]. The explosive cells contain the energy, density, pressure and temperature of TNT. The detonation is initiated by the first time step. From that

time step onward, a shockwave propagates through the numerical domain. Time depended solutions require a transient solution.

The numerical simulations show good agreement with scaled experiments. The simulations are carried out with the use of AIR3d. This software package is not listed among the commercial software packages, and it is assumed that the software is developed by the authors.

All of the simulations are preceded by a Mesh refinement study in 1D and 2D in order to validate the modeled shock wave.

The research carried out by Smith [1999, 2006], Rose [2002, 2003, 2006] and Remmenikov [2004, 2005] makes use of the Jones Wilkins Lee (JWL) equation of state. “An equation of state describes for a given point in the fluid, the difference of the fluid in the initial state and a time dependent state. At any time there is a thermodynamic equilibrium at the given point. An equation of state is necessary to solve the system of conservation equations governing for the fluid flow” according to Wilkins [1999]. The JWL gave the best results for explosive detonation products.

Sklavounos et al [2004] also perform simulations of shock waves in urban areas. They make use of CFX multi purpose software to simulate an explosion propagating through an obstructed terrain in an attempt to validate computed shockwaves with scaled experiments. This paper also shows a table with important properties of high explosives:

Step function terms	Properties				
Physical quantities	Mass specific energy [kJ/kg]	Density [kg/m ³]	Detonation velocity [m/s]	Detonation duration [sec]	Power of explosion [J/s]
Input values	5876	1560	8500	5,3x 10 ⁻⁶	3,6 x 10 ¹¹

Table 2.1 High explosive properties

The time steps used are in the following sequence: initially 9×10^{-8} followed by 9×10^{-7} and 9×10^{-6} . This is done to include the energy release phase.

2.3 Urban Environment Modeling

Remmenikov [2005] concludes that using rigid non responding structures are applicable when the effects of the neighboring buildings, such as shadowing or enhancement are studied, i.e. blast wave propagation in urban geometries. This assumption shows good agreement with experiments.

2.4 Summary Literature Review

- No literature found concerning CFD subsonic gas explosion modeling in urban area's
- Subsonic gas explosion modeling in found literature, carried out with specific software and private developed solvers, very limited on data availability
- There is literature available concerning CFD supersonic detonation explosion modeling in urban environment
- Supersonic detonation explosion modeling makes little use of commercial software

3. Methodology

In this chapter the methodology for this research will be addressed. In 3.1 the research steps will be explained. The assumptions are discussed in 3.2.

3.1 Outline of the Research

3.1.1 Assumptions

The assumptions are the first step in the research process. They reduce the complicated problem as stated in the research question to a simplified problem which can be investigated. The assumptions will be based on what is learned in the literature review.

Furthermore, a reference is established as a benchmark, after the assumptions are made, to compare the results of the simulations.

3.1.2 Methods Investigation

The second step in the process is to consider the options for modeling a blast wave with the recourses available.

An overview of the available methods is made, to be able to select one method which suits the established criteria best. (See chapter 4) The selection of investigated methods is based on the fact that they can be executed with the use of CFD.

3.1.3 Results and Discussion

The results provide an overview of the executed simulations. The simulations are executed with the method selected in the previous step of the research. The discussion is to analyze the attained results (referring to reference) and to discuss weak and strong points.

3.1.4 Conclusions and Recommendations

The conclusion provides the answer on the research question. The last step is the recommendations for future research.

3.2 Assumptions

The assumptions reduce the complicated problem as stated in the research question to a simplified problem which can be investigated. The assumptions made to carry out the research are explained in this section

3.2.1 Free Air Explosion

The free air blast is chosen to simplify the problem at hand. The free air blast is a good reference to measure the influence of the ground effect, a so called surface blast. The surface blast can be validated with the Green Book. The surface blast in its turn is a good instrument to establish enhancement or shadowing factors for obstacles when further research, of blasts in urban environments, is carried out. This step by step approach allows gaining experience and expertise necessary for urban blast modeling. Starting the simulations with an urban environment is hard to model and validate when the knowledge is limited.

3.2.2 Two Dimensional Simulations

As a first step a 2D approach is chosen as a further simplification. It is expected that it is possible that a 2D approach is able to simulate a free air explosion without influences of obstruction and congestion

At this stage, it is not clear if a 1D approach (tube) might disturb the results because of reflection and congestion.

A 3D model could also be used for modeling an unobstructed blast wave, but requires more effort in generating a mesh and computational time.

3.2.3 TNT Equivalence

Industrial explosions, both BLEVE and VCE, can be represented by a TNT equivalence as shown in the literature review of part I. After the TNT assumption is adopted, they only differ in equivalent weight of TNT i.e. energy content. From this point onward the only distinction in the type of industrial explosions determined by the energy content.

This assumption is a simplification of subsonic gas explosions. See also 3.2.4

3.2.4 Supersonic, Inviscid, Laminar Flow

By choosing the TNT equivalence a supersonic, and simpler, approach is applied. The governing equations for supersonic flow, with a viscosity equal to zero, are simplified Navier Stokes equations. This may save some computation time.

The literature review, Merkx [2000] also shows that for the interaction of blast wave and (Urban) obstructions the assumption of inviscid flow is justified.

Turbulent fluctuations can be ignored because of the supersonic assumption. Pressure build up caused by a supersonic flow (detonation) is not affected by turbulence.

3.2.7 FLUENT

This software package is available at the Eindhoven University of Technology. For now, expensive special purpose software is not used.

The simulations will be carried out with FLUENT 6.3.26, developed by ANSYS.

3.3 Reference

With the established assumptions from paragraph 3.2, an expected, qualitative, result of the FLUENT simulations can be formulated. This qualitative result serves as a benchmark to compare the performed simulations. The simulations are a simplification of the initial problem of modeling pressure waves in urban geometries.

The intended result is a shock wave in free air. A definition of a shockwave has to be formulated, before a benchmark can be established.

Since there is no data available of free air shockwaves to validate, a qualitative reference is established.

3.3.1 Deflagration vs. Detonation

Deflagration is the term for subsonic combustion, which propagates by thermal conductivity. The flame front heats the layers of cold mixture material ahead and ignites it. The flame front can accelerate due to turbulence; the flame front is stretched and causes positive feedback to the flame speed.

Deflagrations are suited to move an object with the force of expanding gas. A car engine is an example of a deflagration process. Gas explosions such as LPG or propane explosions are also considered to be deflagrations. Deflagrations cause blast waves; a gradual build up over time in pressure and when the peak pressure is reached, a gradual decrease of pressure over time. Damage on surrounding buildings can occur however if the peak pressure and the impulse are too big.

Detonation is the term used for supersonic combustion, and moves forward due to an energy release in a reaction zone behind the shock wave. The shock compresses un-burned material beyond its auto ignition temperature, the ignited material burns behind the shockwave and supports it to propagate. Detonations cause a sudden increase in density, pressure and temperature in the medium in which they propagate. This increase causes a discontinuity which is called a shock wave. Therefore detonations are suited for demolition and warfare.

Deflagration can transform into detonation when the speed of sound is exceeded in the burning process due to turbulence for example. A car engine which "blows up" is an example of such a transition.

3.3.2 Shockwave

From a given off set distance, there must be a rapid increase in pressure, a peak pressure over a short time period followed by a gradual decay in pressure. Chronologically, the pressure gradient before the peak pressure must be steeper than the pressure gradient after the peak as shown in figure 3.1. A difference in density and temperature over time at the same off set distance is also required.

The pressure in a body of fluid can be identified regardless whether the fluid is in motion or not. If the fluid is not in motion, the total pressure equals the static pressure. If the fluid is in motion the total pressure equals the static pressure plus the dynamic pressure.

The dynamic pressure is of interest in this study. Dynamic pressure describes the kinetic energy of a fluid particle. Kinetic energy is defined as the amount of work needed to accelerate a certain body of mass from rest to its current velocity.

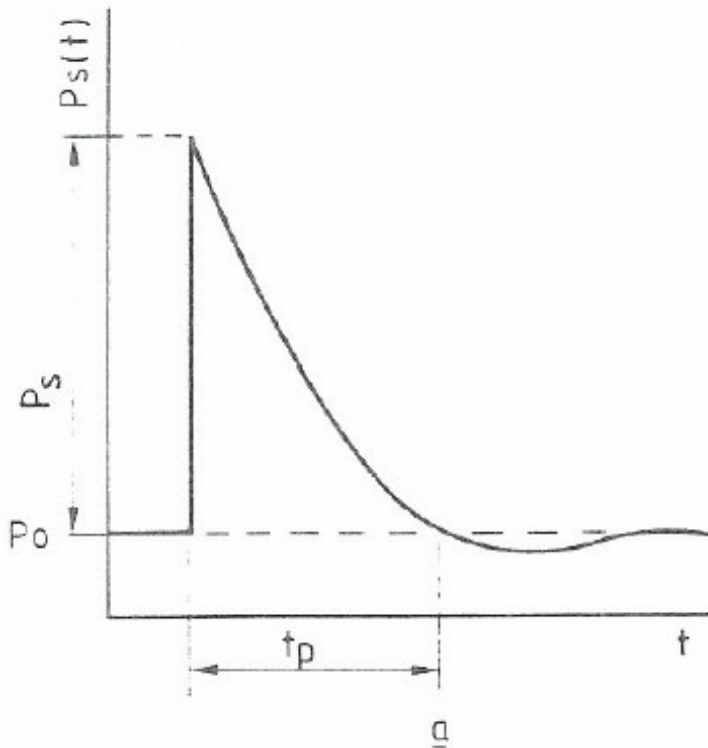

Fig 3.1 Reference shape of a shockwave Source: Explosion effects on buildings part 2B Green Book

4. Available Methods

In this chapter an overview is given of the available methods, which can be used to model 2D shockwaves with the given assumptions. The assumptions are the simplification of a gas explosion in an urban environment. All of the presented methods can be modeled in FLUENT. In order to select the best method for application a few criteria are formulated:

- The method should give accurate results
- The method should be based on plausible physical assumptions
- The method should be easy to apply, also for someone with little experience in the field

These criteria are also used by Doormaal [2005] in the Yellow Book to select methods for BLEVE calculations.

Method	Selection criteria		
	Accurate	Plausible	Easy
1 comb	y	y	n
2 prop	y	y	n
3 equil	y	y	y
4 accoust	n	n	nk

Table 4.1 Selection of method y=yes, n=no, nk=not known

In the next paragraphs the methods are described in more detail. The third method is chosen to execute the simulations, and further explained in paragraph 4.5.

4.1 Method 1: FLUENT Combustion Model

This method is studied because the FLUENT user guide states this model gives accurate results when fuel air mixtures are studied. The laminar finite rate model is applied. This model is suitable for combustions with a relatively slow chemistry and small turbulent fluctuations such as supersonic flames.

The combustion modeling is based on accurate physical assumptions of a fuel air mixture, because it can model the mixing and transport of chemical species by solving conservation equations for convection, diffusion and reactions of each component of the species.

Detonation is accomplished with high Arrhenius rates (burning velocities). The Arrhenius expression depends on the characteristics of the mixture. In order to determine the

characteristics of the mixture, all the species in the mixture should be defined as described in chapter 8 of the FLUENT manual.

In order to define all the species in the mixture, a good and profound knowledge of mixture chemistry and gas dynamics is necessary. A thorough investigation into these fields is beyond the scope of the thesis, and therefore does this model not meet the criteria of easy applicable for inexperienced users.

4.2 Method 2: FLUENT Propane Cloud Model

This method is similar to the first method discussed in paragraph 4.1, with the exception that the mixture to be modeled is a propane air mixture. FLUENT provides in its library the option for a propane air mixture. This option is investigated in an attempt to avoid the problems of defining mixture species as experienced with the first method.

The laminar finite rate model is applied, and detonation is accomplished with a high Arrhenius rate.

To express the reaction rate, the Arrhenius figure should be defined. By this the same sort of problem is introduced as with the first method; although all the species in the mixture may be predefined by FLUENT, the mixture mass fractions of the species are not. In order to establish the mass fractions in the mixture of each of the species, a profound knowledge of mixture chemistry is necessary. This model does not meet the criterion of easy applicable for inexperienced users.

4.3 Method 3: Equilibrium Model

Literature review of simulations carried out at Cranfield University, Smith [1999, 2006], Rose [2002, 2003, 2006] and Remmenikov [2004, 2005], show that this method gives accurate results when compared with small scale experiments.

This model seems to be relatively easy to apply. Only a few parameters have to be plugged in, and the method is based on plausible physical detonation assumptions.

The free air explosion is modeled on a computational grid, containing a small group of cells in the centre of the grid, filled with air TNT. The properties of this fluid type are adjusted to the properties of TNT as given by Smith et al in "Blast and Ballistic Loadings of Structures".

- Density: 1600 kg/m³
- Temperature : 3000 Kelvin
- Pressure: 200 kbar
- Energy content: 4080 kJ/kg

4.4 Method 4: Acoustic Shockwave Model

This method is considered because of the similarity between blast waves and sound waves.

The literature review however, shows that acoustic elements are applicable in situations with small amplitude and slow traveling waves. Blast waves caused by TNT explosions have a big amplitude and travel with more than 100 m/s (mach >1). The acoustic approach does not give accurate results in this case, and is, when high amplitude and high velocity blast waves are considered, not based on plausible physical assumptions.

4.5 Selected Method

Method 3 is selected to perform the simulations with because it meets all the criteria as stated in the beginning of this chapter.

A basic file is created which can serve as the template for all the simulations. Since the knowledge about FLUENT is limited at this stage, only the known options are used. This enables the use of the same parameters every time and determines the effect on the results of every added parameter.

This file is based on the mesh presented in paragraph 4.5.1. All of the assumptions stated in 3.2 are incorporated.

4.5.1 Mesh

The mesh applied for the simulation, shown in figure 4.1, is generated with the use of the program GAMBIT, which is a meshing tool compatible with FLUENT. This mesh is a numerical representation of a free air explosion.

A 2D free air explosion is assumed so a 2D mesh is generated without any form of congestion.

The domain is a free field of 100 × 100 m². In the center of the mesh, a group of cells of 2 × 2 m² is modeled. These cells are assigned with the values of air TNT (fluid 2). The cells in fluid zone 2

and around fluid zone 2 are meshed densely because a steep pressure gradient is expected here. The remaining of the domain is meshed with a gradually coarser mesh towards the outer boundaries of the domain, because a smaller pressure gradient is expected here. This is shown in figure 4.1.

The outer boundaries of the domain are assigned as outflow, in an attempt to approach a free air explosion as real as possible.

The remaining cells of the $100 \times 100 \text{ m}^2$ are assigned with normal air (fluid 1).

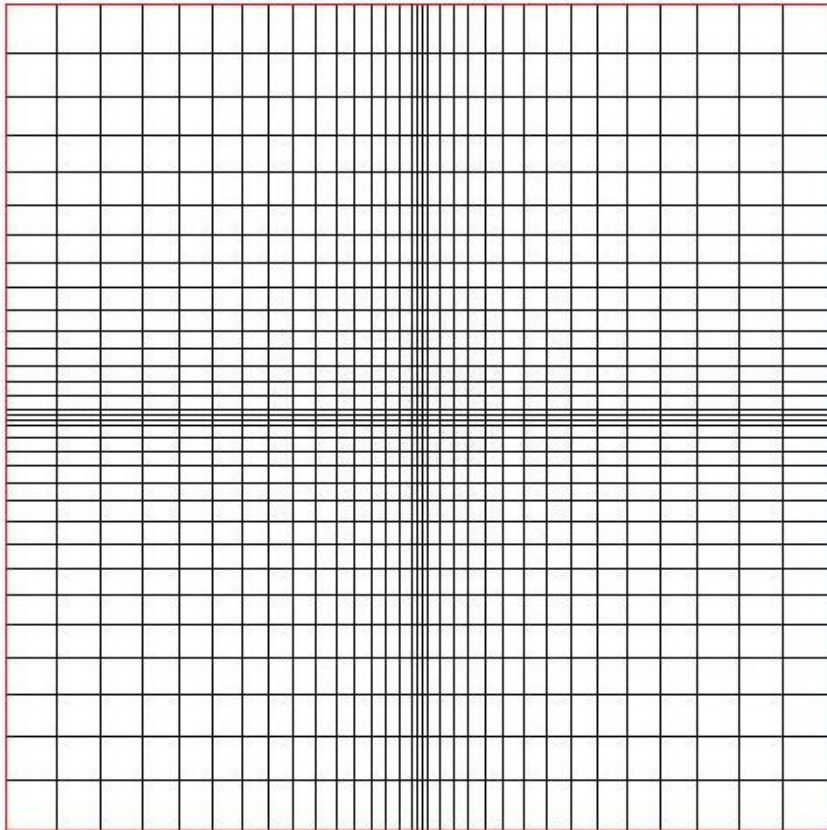

Fig 4.1 Mash of $100 \times 100 \text{ m}^2$ The center cells ($2 \times 2 \text{ m}^2$) are assigned with air TNT (fluid 2), the remaining cells are assigned with air (fluid 1) The outer boundaries are modeled under outflow conditions

4.5.2 Known parameters

The following parameters are plugged in:

Air TNT

- Density 1600 kg/m³
- Temperature 3000 K
- Pressure Not assigned
- Energy Not assigned

Air

- Density 1,2 kg/m³
- Temperature 300 K (atmospheric, in initialization panel)
- Pressure 101000 pa (atmospheric)
- Energy 0 kJ/kg

The solver is defined as an unsteady solver, which allows transient calculations. Time dependent simulation require a unsteady solution.

The energy equation is activated for the calculation of energy conservation.

The discretization methods used for the conservation laws are all second order, to get greater accuracy. Shock stability is accounted for by FLUENT with the use of the Roe flux splitting scheme, FLEUNT manual [2006].

The convergence criterion is set to absolute, and the criteria for continuity, x velocity and y velocity are set to 0.001. The energy convergence is set to 1×10^{-6} . All these values are the default values of FLUENT.

The time step size is set at 1×10^{-10} to be sure that the simulation starts before the occurring physical phenomena as pressure build up, and study their development.

The input file created so far provides the platform for further simulations discussed in chapter 5: Results and Discussion, and serves as the first simulation.

5. Results and Discussion

In this chapter the results of the various simulations, based on the method selected in chapter 4, and the assumptions made in chapter 3, are shown in 5.1. The simulations discussed in 5.2.

5.1 Results

Sim	Objective	Expected result	Obtained result	Problem	Feasibility	App
1	Equilibrium in density and temperature, attain pressure gradient due to temp	Equilibrium in density after a few timesteps, rise in pressure	Gradient in density and temperature, no pressure gradient	Pressure could not be assigned to specific fluid zone	No	H1
2	Pressure gradient by adding pressure in the initialization panel	Pressure gradient	Gradient in density and temperature, no pressure gradient	Pressure could not be assigned to specific fluid zone	No	H2
3	Model a detonation velocity by adding a X and Y velocity to fluid zone 2	Pressure gradient due to velocity of mass	No result	Floating point exception	No	H3
4	Model mass transport by large and fast movement in air	Pressure gradient due to velocity of mass	Gradient in density, temperature and pressure	Large underpressures in dynamic and static pressure cannot be explained and do not fulfill qualitative reference Strange and unknown scaling, not based on plausible physical laws Iteration does not converge	No	H4
5	Equilibrium in temperature, attain pressure gradient due to temp Study effect of compressible air	Pressure gradient	Gradient in temperature, no density or pressure gradient	No pressure content added Outerboundaries have to be changed to walls Equal density in both zones	No	H5
6	Pressure gradient by floating operating pressure	Pressure gradient	Gradient in density and temperature, no pressure gradient	Outerboundaries have to be changed to walls Pressure could not be assigned to specific fluid zone	No	H6
7	Pressure gradient by patching different fluid zones Pressure, and temperature assigned to specific fluid zone	Pressure gradient, Temperature gradient, Density gradient	Gradient in pressure, temperature and density Density With temp air = 0 K	No energy content Outerboundaries have to be changed to walls Iteration does not converge Floating point exception with Temp air = 300K Explosion velocity too slow	No	H7
8	Pressure gradient by patching different fluid zones Adding energy content to increase explosion velocity	As sim 7 but with higher velocity	As sim 7	Energy content has no influence on the results Iteration does not converge Floating point exception with Temp air = 300K	No	H8

Table 5.1 Results of the various simulations

The first column of table 5.1 shows the simulation number. The second column explains why the simulation is carried out with what objective. The third column shows the desired result, and the fourth column shows the actual result. The fifth column addresses problems which occurred during the simulation. The second to last column shows the feasibility of the result based accuracy of the input and encountered problems during the iteration process. Finally, the last column shows in which appendix more information about the simulation can be found.

There are 8 simulations carried out to explore the necessary know-how for modeling a shockwave, and gain knowledge about FLUENT. This means that the FLUENT manual was consulted throughout the execution of the simulations.

The results of the simulations 7 and 8, which fulfill the qualitative reference concerning pressure, are presented in more detail.

5.1.1 Simulation 7

The results show a gradient in temperature, density and pressure. To study the pressure build up over time, a time pressure diagram is composed at a stand off distance of 20m as shown in fig 6.1. The graph shows a significant pressure build up, from 1×10^{-2} sec to 5×10^{-2} sec, after that, the pressure decreases again. The peak pressure of this diagram is just above 80 bars.

The time steps of figure 6.1 are logarithmic to save computational time, and to get a quick estimation of the pressure development over a bigger time window.

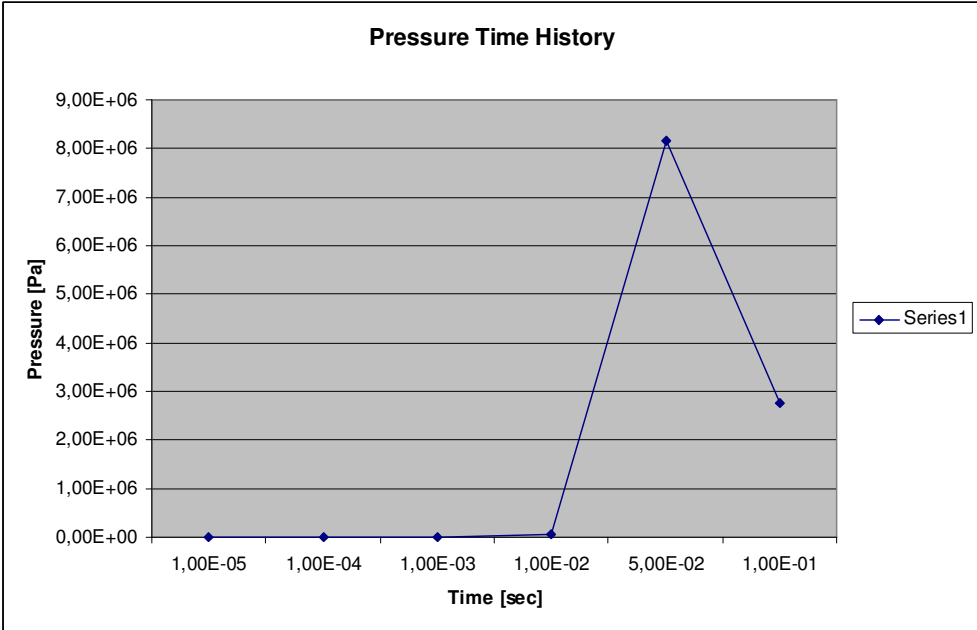

Figure 6.1: pressure time history simulation 7

The time window between 1 msec and 50 msec is subject for further study, to investigate the propagation of the blast wave, at a off set distance of 20 meters. The result for the dynamic pressure is shown in fig 6.2 and for the density in figure 6.3.

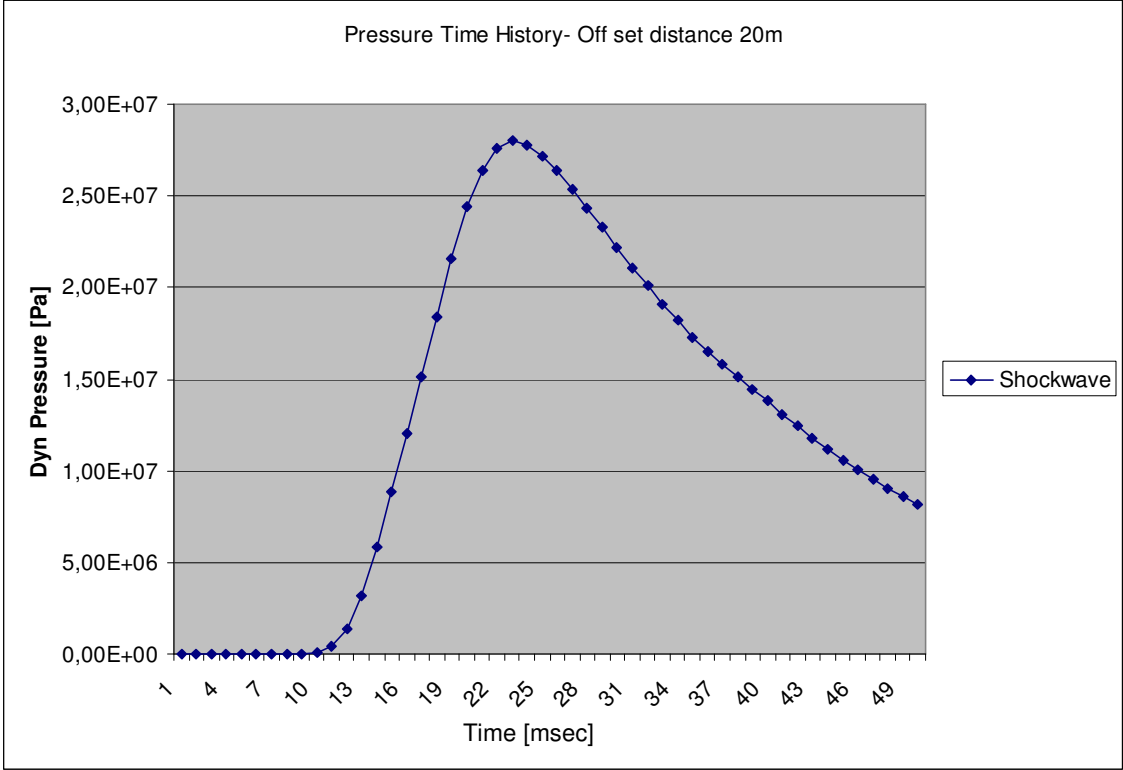

Figure 6.2 Pressure time history simulation 7

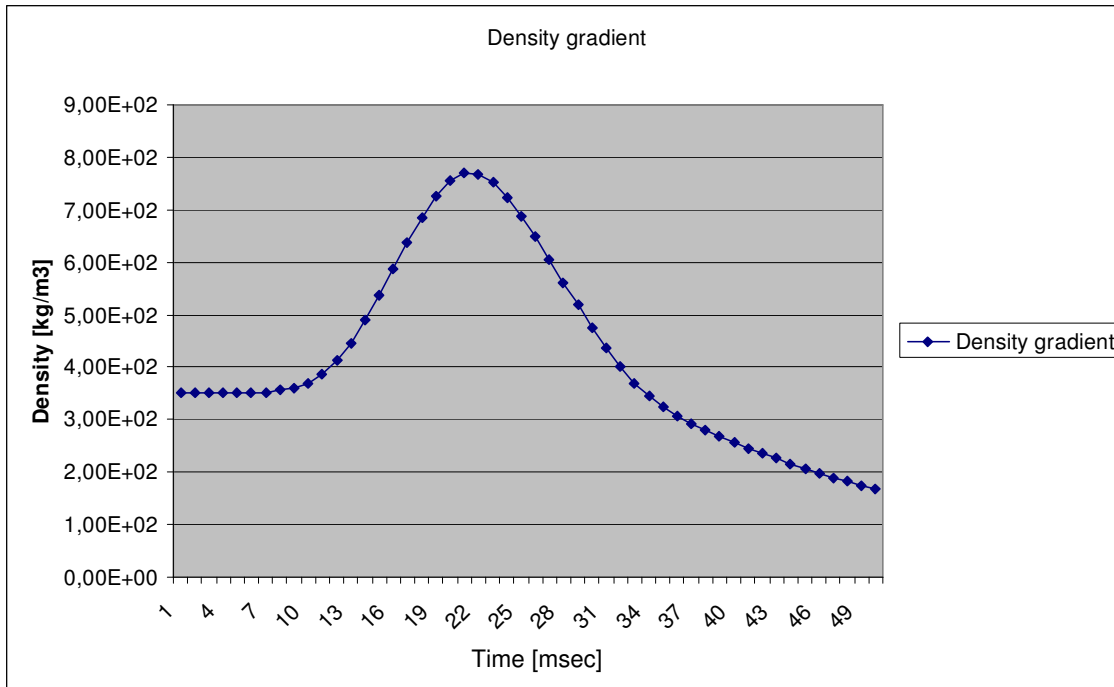

Figure 6.3 Density gradient simulation 7

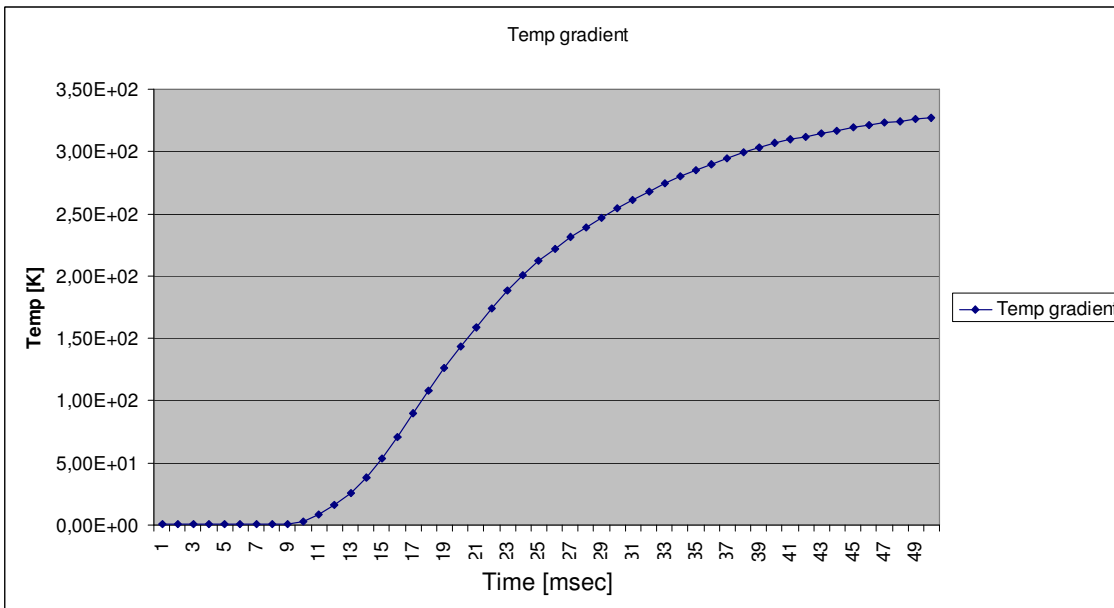
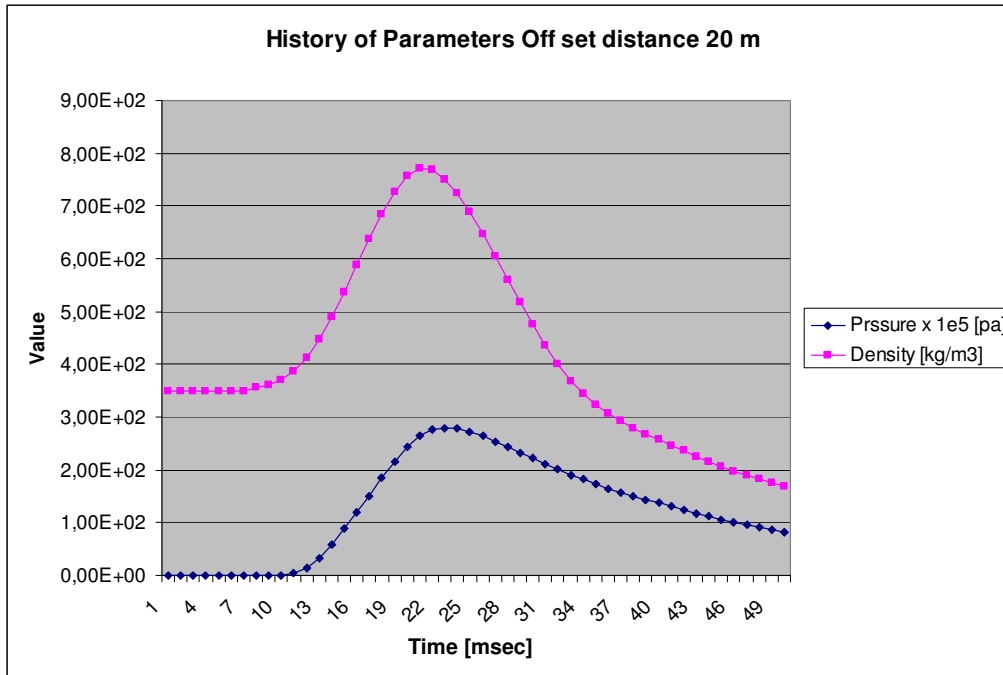

Figure 6.4 Temperature development simulation 7

The result for the temperature is shown in figure 6.4. The initial temperature is set at 0 K. If the initial temperature is set at 300 K (atmospheric), a floating point exception occurs and thus the simulation does not generate a result. This value of 0 K is physically impossible, given this; it is questionable if the generated results for the pressure and density are valid. This shows that it is not sure that the model is able to describe accurate physical laws.

Figure 6.5 shows the combined results for the two parameters, to investigate when they occur in time.



The shape of the shockwave fulfills the requirements as stated in 3.3 Reference. The pressure gradient before the peak pressure is steeper than the pressure gradient after the peak as shown in figure 6.2. A difference in density over time at the same off set distance is also recorded as shown in figures 6.3. Temperature influences however cannot be measured

Figure 6.5 shows the peak pressure and the peak density arrive at the same time at the given distance.

The explosion duration (positive phase) at the given off set distance is approximately 0,1 sec (0,1 ms till 100 ms = 99 ms) according to fig 6.1. The literature Sklavounos [2004] shows that the duration of a TNT explosion is approximately 5×10^{-6} sec (5×10^{-3} msec). This simulation seems to be too slow in pressure build up.

5.1.2 Simulation 8

This simulation is similar to simulation 7, only this simulation aims to accelerate the explosion and determine a size by adding a energy content. The energy content cannot be added in FLUENT as expected. The boundary conditions panel provides the opportunity to assign a

energy content to a specific fluid zone. The energy however is expressed in W/m^3 . The well known expression of energy is kJ/kg , where a kJ is a watt (W) per second. The energy content in FLUENT misses the time component. A simulation is carried out anyway to investigate the effect of the unknown energy content

Given the density of $1600 \text{ kg}/m^3$, the energy content is set at $7,2 \times 10^9 \text{ W}/m^3$. (with awareness of the missing time component)

Figure 6.7 shows the pressure time history of simulation 8. The results are similar to simulation 7, although a slightly higher pressure at each time step is found. The shape of the shockwave fulfills the requirements as stated in 3.3 Reference. The results are the same as simulation 7. A difference in density and temperature over time at the same off set distance is also recorded.

The energy content does not contribute to the velocity of the shockwave. Evidence for his can be found in the duration of the wave passing by, approximately $0,1 \text{ sec}$, and the time of arrival of the peak pressure at the given distance, still approximately at 1 ms equal to simulation 7.

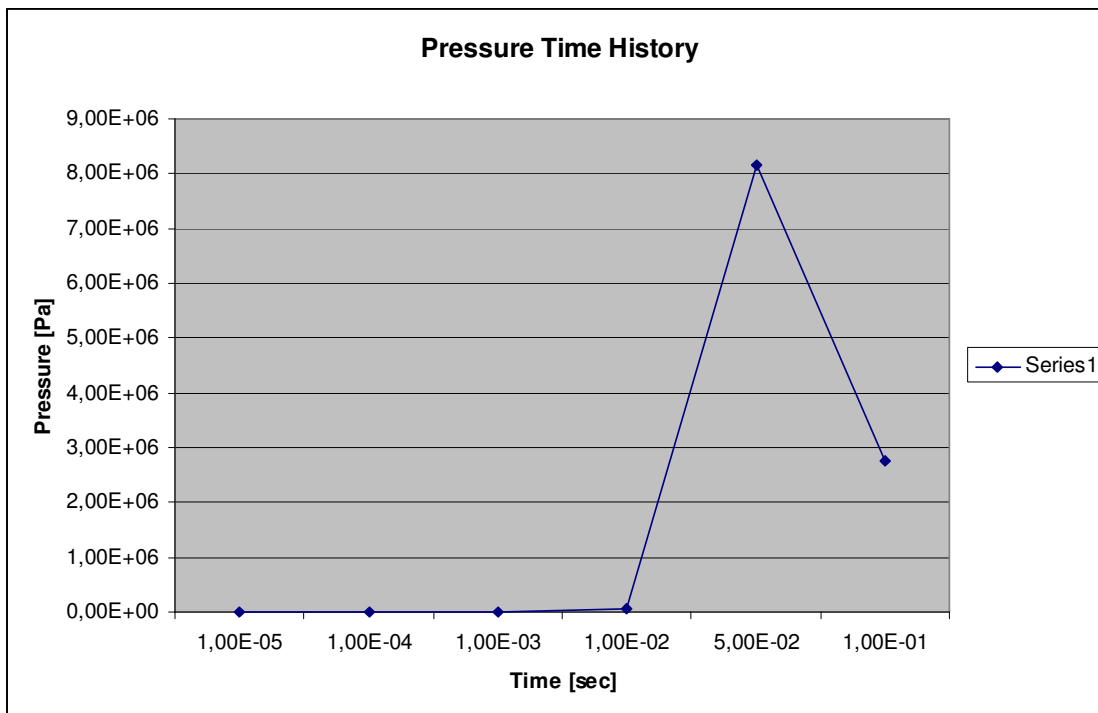

Fig 6.7: pressure time history simulation 8

5.2 Discussion

None of the executed simulations seem to be feasible to model a shockwave as stated in the reference. The shockwave assumption was adopted in section 3.2 of this thesis as a simplification of the initial problem: gas explosion in urban environments.

There are some issues of concern which affect the reliability of even this simplified 2D approach.

- The energy content in the TNT fluid zone.

It is not known from using FLUENT how to add the energy content in the right way, and yet it is the energy content which determines the size of the explosion. The simulated shockwaves (simulation 7 & 8) in this thesis are caused by an explosion with a unknown size, and cannot be determined.

- Iteration progress.

The results do not converge after the explosion is long gone. The scaled residuals are large which compromises the accuracy and validity of the answers.

- Detonation duration.

The velocity of the detonation is also of concern. The simulated explosion is too slow when compared with studies which were validated with small scale experiments.

- Numerical stability problems

Every mesh has its own maximum time step size. The more complex and denser a mesh is, the smaller is its maximum time step size. In this thesis variable time steps are used, because of time saving reasons. To perform calculations beyond the maximum time step size this maximum time step size determines the amount of time steps. The time steps are fixed in the simulation from this point onward. With the amount of time steps the accuracy of the answers improves, which in itself is not a problem. The problem however is that when a mesh is altered the answers are also different. This is a discrepancy of the general CFD rule that the results of a simulation should be independent of the mesh.

- Initial time step size

The initial time step size has an influence on the answers. When a simulation is started with a large initial time step, there is a risk of a floating point exception and thus no results.

- Dimensions

The dimensions of the computational domain for instance can influence the results, when changed to walls, and must be carefully established.

- Temperature

The development of the temperature shows that the results are not plausible for simulation 7 and 8, since a physically accurate temperature development cannot be simulated, and the influence of the temperature on the pressure and density is unknown.

All these considerations are valid for the simulation of shockwaves. Shockwaves caused by a TNT detonation are considered in this thesis to be subsonic inviscid flows, and are not affected by turbulence. The performed simulations are not feasible to describe a supersonic flow problem.

The supersonic flow problem in this thesis is the simplification for the initial problem of gas explosions in an urban environment.

Pressure waves caused by a subsonic gas explosion, which are assumed to be a deflagration, are influenced by viscosity and turbulence. This makes the models more complex and an even more profound knowledge about CFD and gas dynamics is required.

6. Conclusions & Recommendations

In this chapter the conclusions and recommendations will be addressed. In paragraph 6.1 the conclusions are discussed. In paragraph 6.2 the recommendations for future research in this field are highlighted.

6.1 Conclusions

- Modeling a supersonic inviscid non turbulent detonation in 2D requires a profound knowledge about gas dynamics and computational methods;
- The supersonic inviscid non turbulent detonation in 2D is already a weak simplification of the problem and is not feasible to apply when a subsonic viscid gas explosion flow which is effected by turbulence is desired;
- Modeling a subsonic, viscid gas explosion flow which is effected by turbulence requires a even more profound knowledge about gas dynamics, and has its drawbacks, as mentioned before concerning over estimation of flame thickness, when executed with commercial CFD software ;
- Given the previous points it seems that modeling a subsonic, viscid turbulent gas explosion in an urban geometry, with the use of commercial software, is far from possible at the moment, so accurate predictions of blast wave propagation cannot be made at this moment with the use of FLUENT.
- Special purpose software might be required to model viscid gas explosion flow which is effected by turbulence;
- The blast loading calculation methods from the Green Book cannot be validated with the use of a commercial CFD package, so effect distances of blasts influenced by urban geometries cannot be determined.
- Since subsonic flows are a great challenge to model. This is also true for toxic dispersion, also a vital part in risk assessments, is could be hard to predict with the use of commercial CFD software.

The answer on the research question:

Is it possible to simulate a blast wave in an urban geometry, set off by a gas explosion, with the use of commercial numerical methods?

The question has to be answered with No

6.2 Recommendations

It is recommended to:

- Model gas explosions with special purpose non commercial software. The software should be based on numerical codes such as matlab or C++. The best result attained by modeling a gas explosion is to model a fuel air mixture cloud which ignites. The right numerical method is a viscous and turbulent model with a fixed flame speed which travels through the mixture cloud. The flame speed depends on reactivity of the fuel, the congestion of the flame in the environment etc.
- Validate subsonic software (validated software) when it is defined. Validating with software from highly specialized institutions (validation software) is recommended. The validation software should be known to get good result when compared with (scaled) experiments. This method of validating is recommended because of a lack of experimental, gas explosion, data in the literature.
- Study blast wave propagation in urban geometries. Various types of complicated urban configurations could be studied and related to surface blasts. This allows enhancement factors to be formulated for, shadowing, clearing, congestion etc
- Study fuel reactivity when a reliable code is established. Then, enhancement factors can be applied for a wider range of substances.
- The Yellow Book can be adjusted to incorporate more complex urban geometries and thus to establish more accurate the distance of pressure effects, with the use of enhancement factors.
- To test damage models on humans with coupled simulations. The coupling could be made between sub sonic flow which causes pressure, and a FEM model of a human beings based on lagrangian equations (bone mechanics) to improve the poor damage models in the Purple Book
- Perform extensive research in the subsonic flow when toxic gasses are dispersed

- Study structural response. The assumptions in the Green Book for studying structural response and damage can be, validated.

References

- AGS Advice Committee on Dangerous Substances "QRA modellering voor vervoer van gevaarlijke stoffen" ISBN 90 77710 05 1, 2006
- Baker Q.A., Tang M.J., Scheier E.A., Silva G.J. "Vapour cloud explosion analysis" *Process Safety Progress* Volume 15, Issue 2, pp. 106-109, 1996
- Berg van den A.C, Voort van der M. M., Weerheijm J., Versloot N.H.A. "Expansion-controlled Evaporation: a Safe Approach to BLEVE Blast" *Journal of Loss Prevention in the process industries* Volume 17, Issue 6, pp. 397-405, 2004
- BEVI "Besluit Externe Veiligheid Inrichtingen" *Staatscourant* ", 2004
- Blaas E.P., "Prognose van het vervoer gevaarlijke stoffen per spoor" *Prorail capaciteitsplanning*, Rapport v1.0 051203, 2003
- Casal J., Salla J.M. "Using Liquid Superheating Energy for a Quick Estimation of Overpressure in BLEVE's and Similar Explosions" *Journal of Hazardous Materials*, Volume 137, Issue3, pp. 1321-1327 2000
- CFD online "FLUENT Frequent Asked Questions" 2008
- Clutter J.K., "A Reduced Combustion Model for Vapor Cloud Explosions Validated Against Full-scale Data" *Journal of Loss Prevention in the Process Industries*, Volume 14, Issue 3, pp.181-192, 2001
- Doormaal van J.C.A.M., Wees van R.M.M., Chapter 7: Rupture of Vessels *Publication Series on Dangerous Substances, Methods for the Calculation of Physical Effects Yellow Book CPR 14E*, Third edition, second revised print 2005
- Engelhard W.F.J.M. Chapter 6: Heat Flux from Fires *Publication Series on Dangerous Substances, Methods for the Calculation of Physical Effects Yellow Book CPR 14E*, Third edition, second revised print 2005
- FLEUNT manual "FLUENT 6.3 Documentation" FLUENT Inc., September 2006
- Green Book Assembled authors, Ch 1A Fire Effects on Persons, Ch 1B Fire effects on Structures, Ch 2A Explosion Effects on Persons, Ch 2B Explosions Effects on Structures Ch6 Population Presence *Publication Series on Dangerous Substances, Guideline for Quantitative Risk Assessment Green Book CPR 16*, 2003
- KPMG (Business Advisory Services), TNO (markt "Milieu Energie en Procesinnovatie" en de markt "Strategie, Technologie en Beleid") , ECORYS-NEI en CML

- “Integrale Ketenstudies Ammoniak, Chloor en LPG”, *Hoofdrapport*, 2004
- Liou M-S.**, Steffen C.J. Jr., “A New Flux Splitting Scheme” *Journal of Computational Physics*, Volume 107, Issue 1, pp 23-39, 1993
- Mercx W.P.M.**, Berg van den A.C., Hayhurst C.J., Robertson N.J., Moran K.C. “Developments in Vapor Cloud Explosion Blast Modeling” *Journal of Hazardous Material,s* Volume 71, Issue 1, pp. 301-319, 2000
- Mercx W.P.M.**, Berg van den A.C., Chapter 5: “Vapour Cloud Explosions”, *Publication Series on Dangerous Substances, Methods for the Calculation of Physical Effects Yellow Book CPR 14E*, Third edition, second revised print 2005
- Nota Ruimte** Ministries of VROM, LNV, VenW en EZ, “Nota Ruimte: Ruimte voor ontwikkeling” 2004
- Planas-Cuchi E.**, Salla J.M., Casal J. “Calculating Overpressure From BLEVE Explosions” *Journal of Loss Prevention in the process industries* Volume 17, Issue 6, pp. 431-436, 2004
- Purple Book** Uijt de Haag P.A.M., Ale B.J.M. *Publication Series on Dangerous Substances, Guideline for Quantitative Risk Assessment Purple Book CPR 18E*
- Puttock J.S.**, Yardley M.R., Cresswell T.M., “Prediction of vapour cloud explosions using the SCOPE model” , ” *Journal of Loss Prevention in the process industries* Volume 13, Issue 3, pp. 419-431, 2004
- Raemakers J.H.**, “Het risico van externe veiligheid, Het gebruik van de QRA”, *Master thesis Eindhoven University of Technology, Department of Technology Management Unit Technology and Policy*, 2007
- Remennikov A.M.**, Rose T.A. “Modelling Blast Loads on Buildings in Complex City Geometries” *Computers & Structures*, volume 83, Issue 27, pp.2197-2205, 2005
- Remennikov A.M.** “Evaluation of Blast Loads on Buildings in Urban Environment” *Structures Under Shock and Impact* , WIT press, ISBN 1-85312-706-X 2004
- Rose T.A.**, Smith P.D. “Influence of the Principal Geometrical Parameters of Straight City Streets on Positive and Negative Phase Blast Wave Impulses” *Interrnational Journal of impact engineering*, Volume 27, Issue 4, pp. 359-376, 2002
- Rose T.A.**, Smith P.D. “The Influence of Street Junctions on Blast Wave Impulses Produced by Vehicle Bombs” *The 11th international symposium on interaction of the effects of munitions with structures*, 2003.

Rose T.A., Smith P.D., May J.H. "The Interaction of Oblique Blast Waves With Buildings" *Shock Waves*, Volume 16, Issue 1, pp. 35-44, 2006

Sklavounos S., Rigas F., "Computer Simulation of Shock Waves Transmission in Obstructed Terrains", *Journal of Loss Prevention in the Process Industries*, Volume 17, Issue 6, pp 407-417, 2004

Smith P.D., Whalen G.P., Feng L.J., Rose T.A. "Blast Loading on Buildings From Explosions in City Streets". *Proceedings of the Institution of Civil Engineers Structures and Buildings*, volume 146, Issue 1, pp. 47-55, 2001.

Smith P.D., Rose T.A. "Blast Wave Propagation in City Streets- an Overview" *Progress in Structural Engineering and Materials*, Volume 8, Issue 1, pp. 16-28, 2006

Smith P.D., Hetherington J.G., "Blast and Ballistic Loadings on Structures" *Butterworth Heinemann Publications* , ISBN 0 7506 2024 2 First Published 1994

Stoffenbeleid InfoMill Senternovem website

<http://www.infomil.nl/asp/get.aspx?xdl=/views/infomil/xdl/page&ItmIdt=28253&SitIdt=111&VarIdt=82> 2007

Wada Y., Liou M-S., "An Accurate and Robust Flux Splitting Scheme for Shock and Contact Discontinuities" *Journal of Scientific Computing*, Volume 18, Issue 3, pp. 633-657, 1997

Wilkins M.L., "Computer Simulation of Dynamic Phenomena" *Scientific Computation*, ISBN 3-540-63070-8, Springer-Verlag Berlin Heidelberg 1999

Zachary J.L. "Introduction to Scientific Programming ", ISBN 0 387 94630 6, Springer-Verlag 1996

