

# Building performance simulation and characterisation of adaptive facades – adaptive facade network

**Citation for published version (APA):**

Favoino, F., Doya, M., Loonen, R. C. G. M., Goia, F., Bedon, C., & Babich, F. (Eds.) (2018). *Building performance simulation and characterisation of adaptive facades – adaptive facade network*. TU Delft Open.

**Document status and date:**

Published: 01/01/2018

**Document Version:**

Publisher's PDF, also known as Version of Record (includes final page, issue and volume numbers)

**Please check the document version of this publication:**

- A submitted manuscript is the version of the article upon submission and before peer-review. There can be important differences between the submitted version and the official published version of record. People interested in the research are advised to contact the author for the final version of the publication, or visit the DOI to the publisher's website.
- The final author version and the galley proof are versions of the publication after peer review.
- The final published version features the final layout of the paper including the volume, issue and page numbers.

[Link to publication](#)

**General rights**

Copyright and moral rights for the publications made accessible in the public portal are retained by the authors and/or other copyright owners and it is a condition of accessing publications that users recognise and abide by the legal requirements associated with these rights.

- Users may download and print one copy of any publication from the public portal for the purpose of private study or research.
- You may not further distribute the material or use it for any profit-making activity or commercial gain
- You may freely distribute the URL identifying the publication in the public portal.

If the publication is distributed under the terms of Article 25fa of the Dutch Copyright Act, indicated by the "Taverne" license above, please follow below link for the End User Agreement:

[www.tue.nl/taverne](http://www.tue.nl/taverne)

**Take down policy**

If you believe that this document breaches copyright please contact us at:

[openaccess@tue.nl](mailto:openaccess@tue.nl)

providing details and we will investigate your claim.

# Building Performance Simulation and Characterisation of Adaptive Facades – Adaptive Facade Network

Fabio Favoino  
Roel C.G.M. Loonen  
Maxime Doya  
Francesco Goia  
Chiara Bedon  
Francesco Babich



Building Performance Simulation and Characterisation of Adaptive Facades

Adaptive Facade Network



## Building Performance Simulation and Characterisation of Adaptive Facades – Adaptive Facade Network

This book is based upon work from COST Action TU 1403 adaptive facade network, supported by COST (European Cooperation in Science and Technology).

COST (European Cooperation in Science and Technology) is a pan-European intergovernmental framework. Its mission is to enable break-through scientific and technological developments leading to new concepts and products and thereby contribute to strengthening Europe's research and innovation capacities.

It allows researchers, engineers and scholars to jointly develop their own ideas and take new initiatives across all fields of science and technology, while promoting multi- and interdisciplinary approaches. COST aims at fostering a better integration of less research intensive countries to the knowledge hubs of the European Research Area. The COST Association, an international not-for-profit association under Belgian Law, integrating all management, governing and administrative functions necessary for the operation of the framework. The COST Association has currently 38 Member Countries.

[www.cost.eu](http://www.cost.eu)

### Publisher

TU Delft Open  
for the COST Action 1403 adaptive facade network

### Editors

Fabio Favoino, Roel C.G.M. Loonen, Maxime Doya, Francesco Goia, Chiara Bedon, Francesco Babich

### Layout and Co-Editing

Ashal Tyurkay, Uta Pottgiesser

### Design

Sirene Ontwerpers, Rotterdam

### Cover Image

Marcin Brzezicki, Wroclaw

The editors worked intensively to collect all copyrights of pictures/graphs. In the unforeseen case of using unauthorized pictures/graphs the editors ask to get in contact with them.

The scientific posters and fact sheets within the book do represent a documentation of scientific activities and results – they do not focus at individual pictures/graphs. Copyright of the posters are with the authors of the posters.

ISBN 978-94-6366-111-9

© 2018 TU Delft Open

This work is subject to copyright. All rights are reserved, whether the whole or part of the material is concerned, specifically the rights of translation, reprinting, re-use of illustrations, recitation, roadcasting, reproduction on microfilms or in other ways, and storage in data banks. For any kind of use, permission of the copyright owner must be obtained.



COST is supported by  
the EU Framework Programme  
Horizon 2020

# Building Performance Simulation and Characterisation of Adaptive Facades

**Adaptive Facade Network**

Fabio Favoino, Roel C.G.M. Loonen, Maxime Doya, Francesco Goia, Chiara Bedon, Francesco Babich

*TU Delft for the COST Action 1403 adaptive facade network*

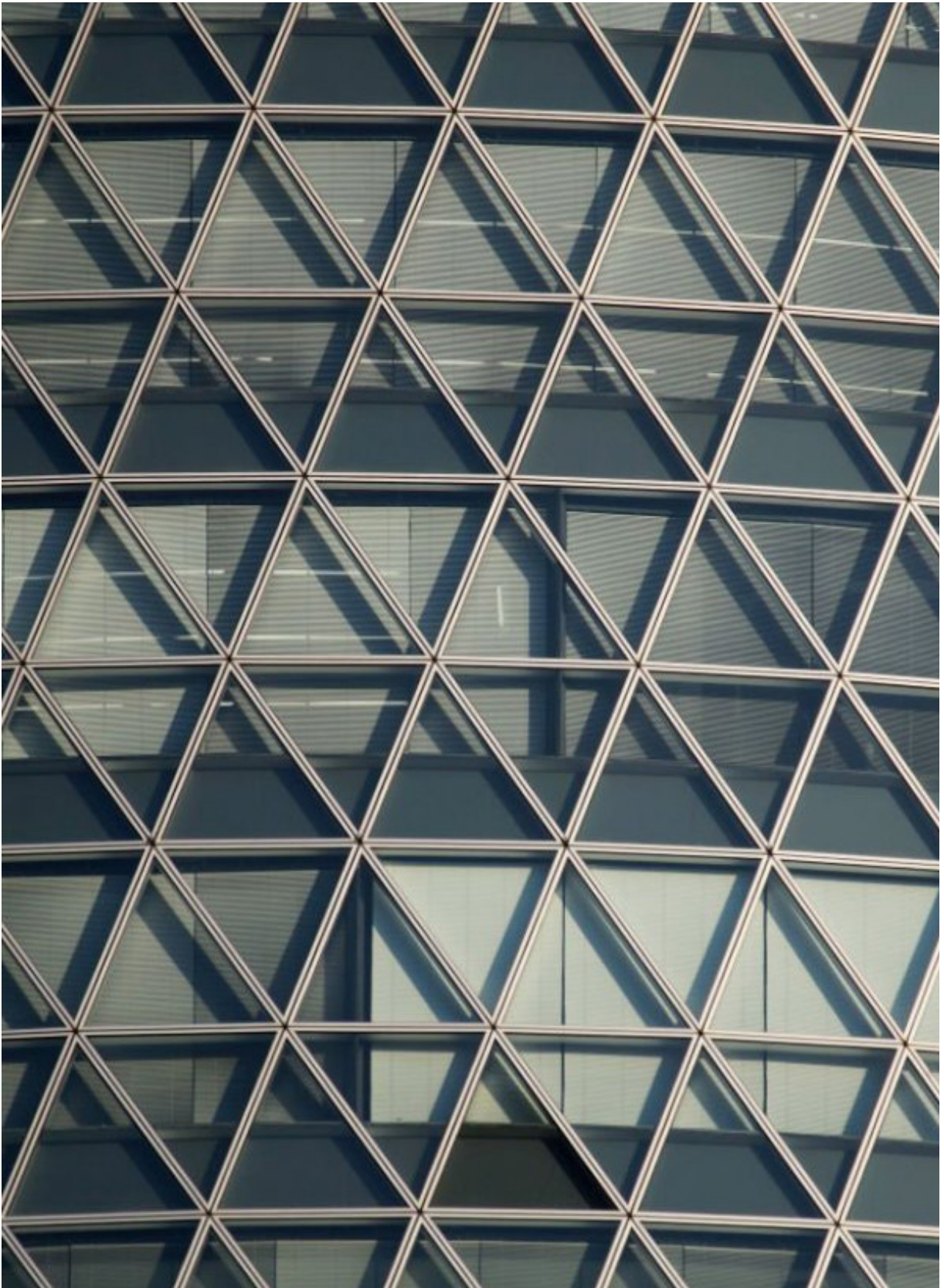

Mode-Gakuen Spiral Towers / Nikken Sekkei, Makoto Wakabayashi (image: M. Brzezicki)

# Preface

The book “Performance Simulation and Characterisation of Adaptive Facades” responds to the need of providing a general framework, standardised and recognised methods and tools to evaluate the performance of adaptive facades in a quantitative way, by means of numerical and experimental methods, in different domains of interest. This book represents the main outcome of the activities of the Working Group 2 of the COST Action TU1403 Adaptive Façades Network, “Components performance and characterisation methods”, by integrating in one publication the main deliverables of WG2 described in the Memorandum of Understanding: D 2.1. Report on current adaptive facades modelling techniques; D 2.4. Report on the validation of developed simulation tools and models; D 2.5. Report on the developed experimental procedures. These are extended by additional sections regarding structural aspects and key performance indicators for adaptive façade systems.

This book is a comprehensive review of different areas of research on adaptive façade systems and provides both general and specific knowledge about numerical and experimental research methods in this field. The fast pace at which building technologies and materials develop, is slowly but constantly followed by the development of numerical and experimental methods and tools to quantify their performance. Therefore this book focuses primarily on general methods and requirements, in an attempt to provide a coherent picture of current and near future possibilities to simulate and characterise the performance of adaptive facades in different domains, which could remain relevant in the coming years. In addition, specific know-how on selected cases is also presented, as a way to clarify and apply the more general approaches and methods described.

The present book is published to support practitioners, researchers and students who are interested in designing, researching, and integrating adaptive façade systems in buildings. It targets both the academic and the not-academic sectors, and intends to contribute positively to an increased market penetration of adaptive façade systems, components and materials, aimed at rationalising energy and material resources while achieving a high standard of indoor environmental quality, health and safety in the built environment.

*Fabio Favoino, Francesco Goia*





# Contents

Preface 5

Introduction 11

## Building Performance Simulation of Adaptive Facades 15

- 1 Current status, requirements and opportunities for building performance simulation of adaptive facades 21
- 2 Model requirements, approaches and validation for simulation of adaptive façade systems and technologies 49
- 3 Computational performance prediction of switchable windows 53
- 4 Computational performance prediction of dynamic complex fenestration systems with BSDF 59
- 5 Computational performance prediction of radiant glass 67
- 6 Computational performance prediction of adaptive insulation 71
- 7 Computational performance prediction of phase change materials in opaque components 77
- 8 Computational performance prediction of phase change materials in transparent components 83
- 9 Computational performance prediction of Double-Skin Ventilated Facade 89
- 10 Computational performance prediction of Double-Skin Opaque Ventilated Facade 95
- 11 Computational performance prediction of ventilative cooling 101
- 12 Computational performance prediction of green roofs and green facades 105
- 13 Computational performance prediction of solar thermal adaptive facade 113
- 14 Description of models for prediction of long-term facades performance 117

## Performance Characterisation of Adaptive Facades 125

- 15 Mapping of Test facilities to evaluate key performances of Adaptive Facade Components 127
- 16 Description of experimental test facilities, characteristics and methods 135
  - The Cube: Absolute and relative guarded test cell 137
  - ESTP outdoor test cell: Absolute guarded test cell 138
  - TWINS (Testing Window INnovative Systems): Façade full scale outdoor comparative test facility 139
  - ZEB Test Cells Laboratory: Absolute guarded test cell 140
  - Tipee Façade Test: Absolute and relative guarded test cell 141
  - LECE Building Component Energy Test Laboratory: Relative test-cells fully exposed to outdoor 142
  - PIV – Particle Image Velocimetry: Indoor measurement equipment 143
  - PSE ARFRISOL Energy Research Demonstrator Office Building Prototypes: In-situ real-scale buildings 144
  - GESLAB, Global Energy and Sustainable Laboratory in Building: Relative test-cells fully exposed to outdoor 145
  - Facade System Interactions Lab: Relative guarded test-cells 146
  - TRIUMF Laboratory: Two Room Indoor Environment & Energy Universal Façade 147
  - LABIMED Test Cell: Paslink test cell 148
  - Building Future Lab: Indoor Laboratory - Calibrated Hot-Box 149
  - Building Envelope and Solar Technologies Laboratory: Absolute and relative guarded test cell 150
  - Large Scale Vertical Building Envelope Climate Simulator: Climate simulator (indoor test cell) 151
  - Dual Air Vented Thermal Box (DAVTB) facility: Laboratory hot box 152
  - MATELab: Façade test cell to study occupant response 153
  - Passivhaus in Mascalucia (Sicily) - Zero Energy Building Living Lab: Outdoor real-scale facility 154
  - BPS Test Façade: Full-scale test Rooms with Reconfigurable Façade 155
  - HCU Studio for Room Comfort: Real-scale test Room with Reconfigurable Façade 156
  - Multifunctional Facade Lab: Indoor Lab - Guarded Hot-Box, Solar simulator for Active Facades 157
- Conclusions 158

KPI and structural aspects of Adaptive Facades 163

17 Key Performance Indicators (KPIs) Online Tool 164

18 Structural Characterisation and Performance Assessment 166

Biographies 179

Acknowledgements 183





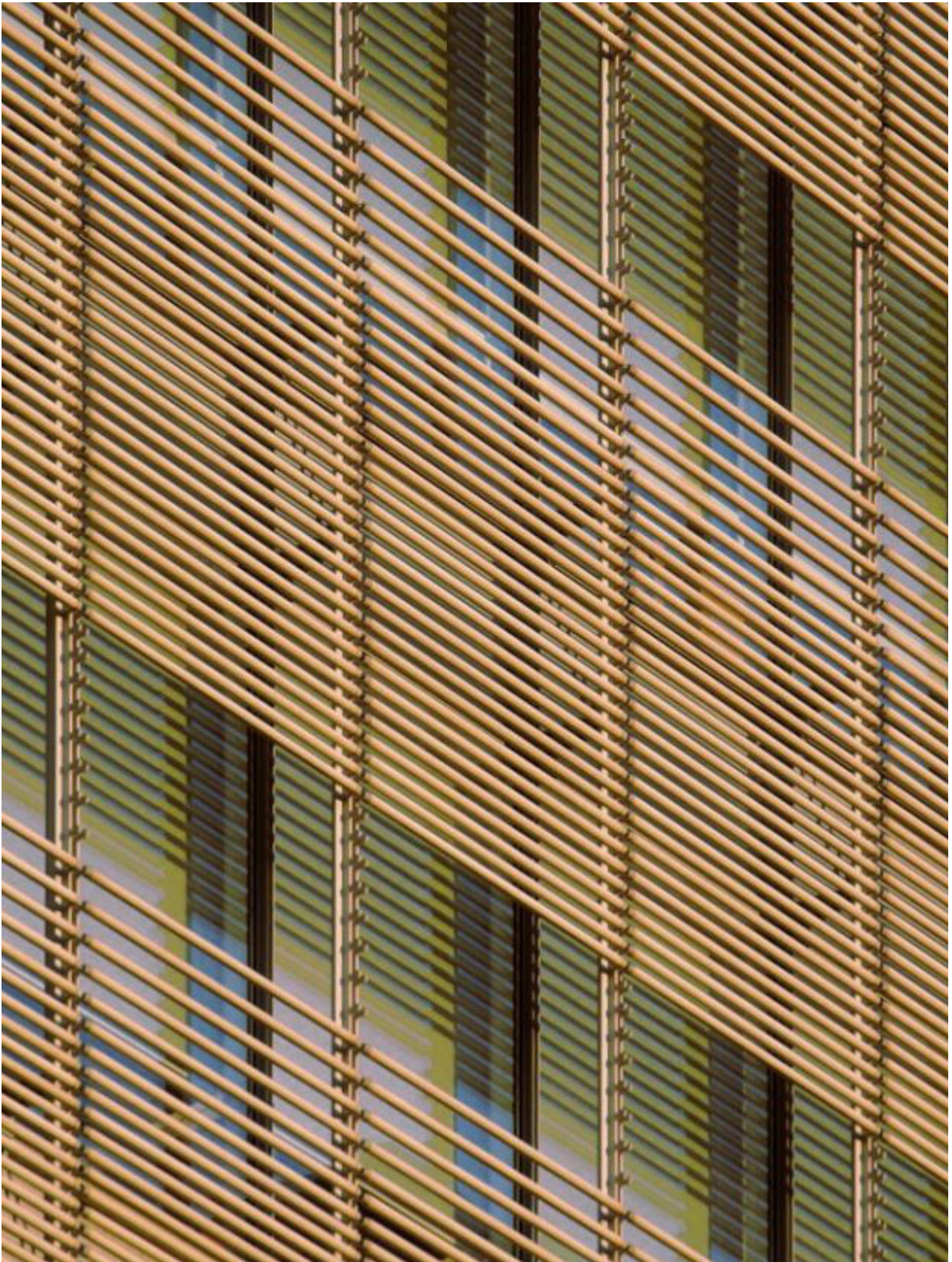

New York Times Building / Renzo Piano Building Workshop (image: M. Brzezicki)

# Introduction

Fabio Favoino, Politecnico di Torino; Francesco Goia, Norwegian University of Science and Technology (NTNU)

The unique feature of adaptive facades is their capability to adapt physical properties (i.e. thermo-optical, structural, etc.) in a reversible way as a response to and/or to adjust to transient boundary conditions (either external, such as climate, or internal, such as occupants' requirements), in order to respond to changing priorities (i.e. minimizing the building energy use, maximizing the use of natural light, etc.). The term 'adaptive' is often synonym to 'responsive', 'dynamic', 'switchable', 'smart', 'active' etc. Adaptive facades are a collection of very different systems that are evolving rapidly, and their rate of innovation is not easily followed by the development of the entire set of methods and tools necessary to comprehensively evaluate their performance. In such a context, the performance characterisation of adaptive facades is a challenging task because of a multitude of intrinsic and extrinsic reasons.

The intrinsic complexity of the dynamic behaviour of these systems, when compared to traditional building envelope components, leads to the fact that conventional simulation tools, experimental assessment methods, and key performance indicators cannot be fully adopted in the case of adaptive facades. Procedures for simulations and experiments, and corresponding assessment criteria are still evolving. The research community is therefore actively engaged in the definition of the necessary standardised approaches which can support the integration of adaptive facades in buildings.

The contents of this book reflect the efforts carried out in the framework of Working Group 2 (WG2) of the COST Action TU1403 Adaptive Façades Network, "Components performance and characterisation methods", in the search for fundamental knowledge to establish robust and shared methods, techniques, procedures and tools for the characterisation and performance evaluation of adaptive, multifunctional facades, at façade component and system levels.

In this context, the terms façade 'component' and 'system' level refer to a scale and an autonomy of behaviour/control that is greater than the material alone but smaller than the entire building. The term 'façade system' indicates the entire set of components of a façade (i.e. infill panels, structural supports and framing, material layers etc.) including the control systems that might be used to control adaptive features of the façade. The term 'façade component' describes a functional sub-system which, together with all the other components, contributes to define the façade system. This could be a single material layer (for example an insulation material) or a component made up of a number of smaller elements (for example a double glazed unit). The level tackled in these activities does not therefore include, on one extreme, the characterisation of bulk materials alone, or the modelling of the physical mechanisms (i.e. optical, chemical mechanisms etc.) inside a material layer, nor, on the other extreme, the overall performance of a complete façade in connection with the entire building, or taking the user into consideration.

The domain of interest of WG2 covered different aspects of the façade, ranging from energy use, to thermal and visual comfort, to structural-mechanical performance to durability. The main focus and objective of WG2 is to provide the basis for the development of a unified approach for the assessment of adaptive facades, therefore the researchers active in the WG2 have focused their



attention in three particular areas: i) the capability of replicating the behavior of adaptive facades through numerical models; ii) the possibility to experimentally evaluate the characteristics of adaptive facades; and iii) the metrics against which to measure their performance in different domains. The organisation of the book follows the three domains tackled by the Working Group.

In the first section (Chapter 1 to 14, edited by Fabio Favoino and Roel C.G.M. Loonen), requirements for building performance simulation (BPS) of adaptive façade technologies are described, and the capabilities of the main BPS tools are reviewed. While BPS tools have been developed to replicate the overall behaviour of a building, they are geared towards modelling traditional building envelope components. Modelling of more advanced features seen in adaptive facades is not a conventional task and often requires extensive use of workarounds, dedicated implementation of small sub-routines, or the use of co-simulation and/or data integration (i.e. the coupling of different BPS tools during simulation run-time, or the integration of BPS results in pre- or post-processing stage). Additionally, for a broad range of specific adaptive façade technologies, the activity of WG2 focused on describing specific simulation requirements, documenting the development of new models, sub-routines and workarounds (either developed by the researchers within the COST Action or found in literature), providing sources of data, validation information, points of attention and an outlook over future developments. Due to the level of integration that adaptive façades require in order to achieve the desired performance, it is not easy to confine the characterisation of their performance to the scale of the façade system and of its sub-components, as defined above. Therefore, this section of the book tends not to be limited to the façade system level, but it is also focusing at the methods, procedures and tools needed to characterise numerically the performance of adaptive façade at the whole building scale.

In the second section (Chapter 15 and 16, edited by Maxime Doya and Francesco Goia), the challenges represented by the characterisation through experiment of the behaviour of adaptive façade are presented. While there are standardised procedures to measure defined physical properties or metrics for conventional building envelope systems, adaptive facades are often outside the scope of these methodologies. The aim of this section was therefore to collect and analyse the different possibilities for testing adaptive facades available at the institutions of the participants in the COST Action. The focus was placed on full-scale test facilities, and a richness of typologies, characteristics, and functionalities has been revealed.

The third and concluding section (Chapter 16 and 17, edited by Chiara Bedon and Francesco Babich) reports the results of the activities investigating how the performance of adaptive facades can be described and communicated by the use of suitable metrics. Key performance indicators are often available for traditional building components, but once more, in the case of adaptive facades, these turn out to be insufficiently capable of addressing the complexity of these technologies. Furthermore, while for traditional solutions it is often possible to decouple different phenomena, and therefore separately address different aspects of the performance, adaptive facades are often characterised by interconnected performance, and therefore the adoption of (too) simple, mono-domain performance metrics can lead to an incomplete communication and evaluation of the effect of an adaptive facade on the built environment. Key performance indicators have been investigated for the energy, the comfort (thermal, visual), the structural, and the durability domain. When it comes to the energy and comfort domain, the main outcome of the work performed with this Action is a comprehensive structured repository of key performance indicators, which can be interrogated as an on-line tool via the internet from anywhere using computers, tablets or smartphones (<http://kpidb.eurac.edu/>). This tool has been designed to be easily usable and accessible and includes a large number of KPIs developed thanks to the contribution of different research projects and partners. This tool should enable a more accurate and unambiguous use

of performance metrics, especially in case of complex and less used key performance indicators. As far as the structural and durability domain is concerned, when adaptive facades are designed unconventional design issues need to be addressed. Even in the presence of extreme design loads, these dynamic systems should be able to properly react to an external input. Such a challenge, compared to traditional static facades, increases when kinematic boundaries and novel materials are used. On the other hand, no specific design regulations are available for the structural design characterisation of adaptive facades, with movable parts. In this regard, part of the WG2 activities and efforts were invested in the definition of classification rules for structural adaptive systems, as well as assessing the reliability of existing design methods, experimental testing approaches and numerical modelling techniques in use for traditional facades.





Elbphilharmonie / Herzog & De Meuron (image: M. Brzezicki)



# Building Performance Simulation of Adaptive Facades

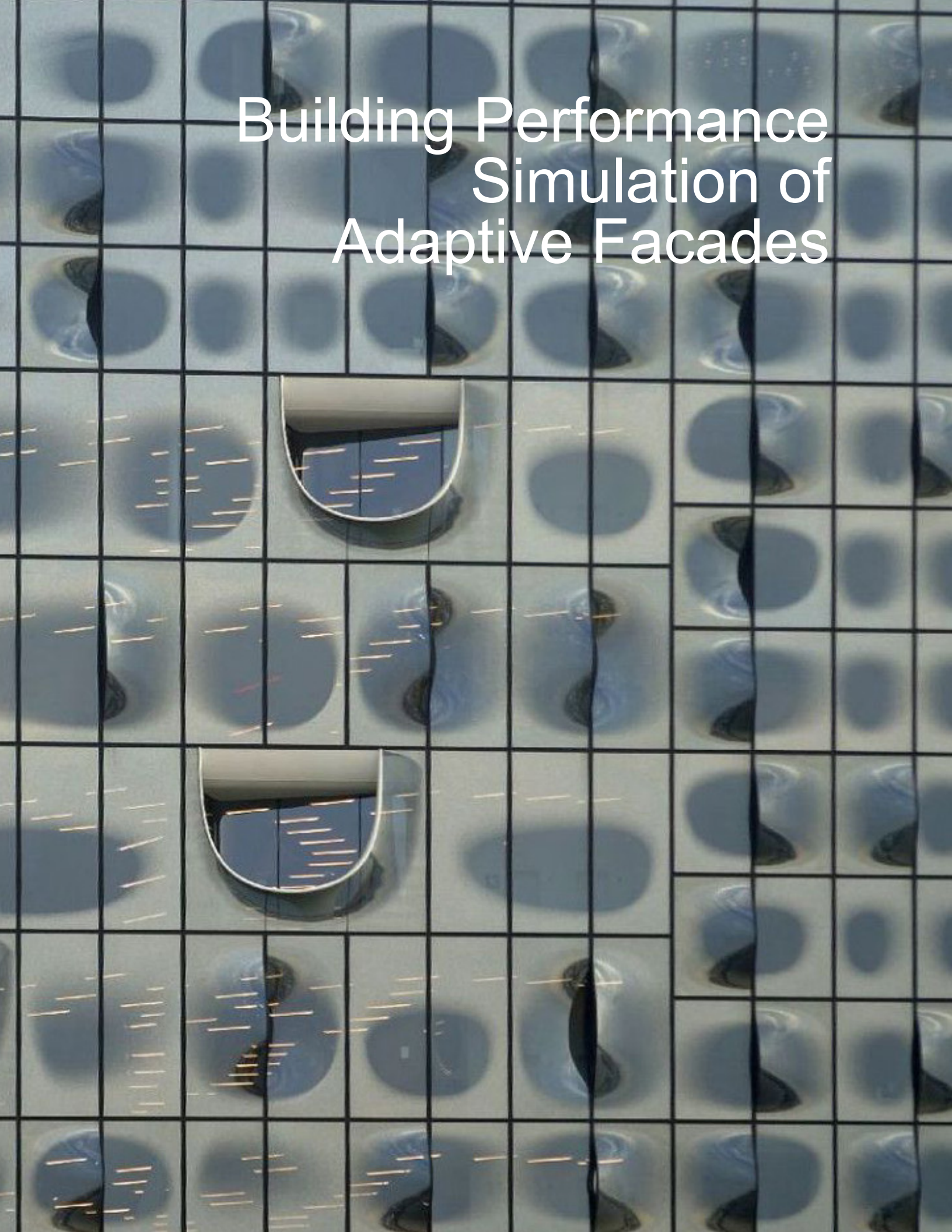





Environmental Energy Innovation Building / Yoshiharu Tsukamoto (image: M. Brzezicki)

# Building Performance Simulation of Adaptive Facades

Fabio Favoino, Politecnico di Torino; Roel C.G.M. Loonen, Eindhoven University of Technology

The development of adaptive façade systems and materials, as well as their penetration in the construction industry, can be accelerated with the use of modeling and simulation. Performance prediction using computer models can for example be used to investigate the impact of different adaptive materials or façade configurations on economic and environmental building performance, to assist in the optimization of dynamic façade control strategies and/or material design. When this is done in an appropriate way, it can make significant contributions to improving indoor comfort, design robustness, reducing energy use and improving energy flexibility of buildings.

Building performance simulation (BPS) is a well-established research discipline and a widely used design support tool in the field of building engineering. Several models for adaptive façade technologies had already been developed when the COST Action started. However, the performance prediction of adaptive facades is considered a challenging task. This is partly due to the fact that information on this topic is scarce and fragmented. There is very little guidance for newcomers about what modeling strategies they can best use to tackle the adaptive façade project they have at hand.

This first section of the book presents a critical review of the modelling methods, requirements and capabilities of current building performance simulation tools to accurately quantify the performance of adaptive facades. This is targeted at researchers and professionals interested in modelling a specific technology or evaluating a range of performance indicators, and/or to Master and PhD students who are approaching the problem of quantifying, in a numerical way, the effect of an adaptive façade on the built environment. This section presents the outcomes of the work carried out within WG2, by the Task Group 2.2 (*Task 2.2 Evaluate current simulation tools for adaptive facades performance assessment*) and 2.4 (*Task 2.4 Develop new simulation tools for the evaluation of the performance of novel and existing adaptive façade concepts*), and is composed of 14 chapters.

The first chapter represents deliverable 2.1 of WG2 “*D 2.1. Report on current adaptive facades modelling techniques*”, and provides an extensive literature review focused on the following aspects: i) simulation requirements based on intrinsic characteristics of adaptive façade technologies and their control during building operations; ii) abilities of building performance simulation software to respond to these requirements and ease of use / implementation; iii) advanced features for modelling adaptive facades, future outlook and implementation needs.

The second part of this first section, from Chapter 2 to 14, focuses on developing and documenting new simulation models and methods to assess the performance of adaptive facades, corresponding to deliverable 2.4 of WG2 “*D 2.4. Report on the validation of developed simulation tools and models*”. In particular, Chapter 2 provides a framework and format adopted in the following chapters, which are relative to a specific adaptive façade technology. Chapters 3 to 14, following the format of Chapter 2, present the features, implementation and validation of specific models, and future points of attention for the numerical modelling of specific adaptive façade technologies in





Oval / Ingenhoven Architekten (image: M. Brzezicki)

building performance simulation tools. These models were either developed by the WG members, or adopted by them during their research activity, or reviewed from literature. A questionnaire between the WG members enabled all the specific capabilities and expertise within the WG, and the current activities regarding the development of novel simulation methods and models for adaptive facades, to be mapped. This questionnaire also fostered the networking between different members, creating opportunities for STSMs dedicated to Task 2.4. The work of WG2 Task Groups 2.2 and 2.4 resulted from 27 contributors, from 8 different countries, from 12 universities and research institutions and 5 industry contributors, these are listed in Biographies.

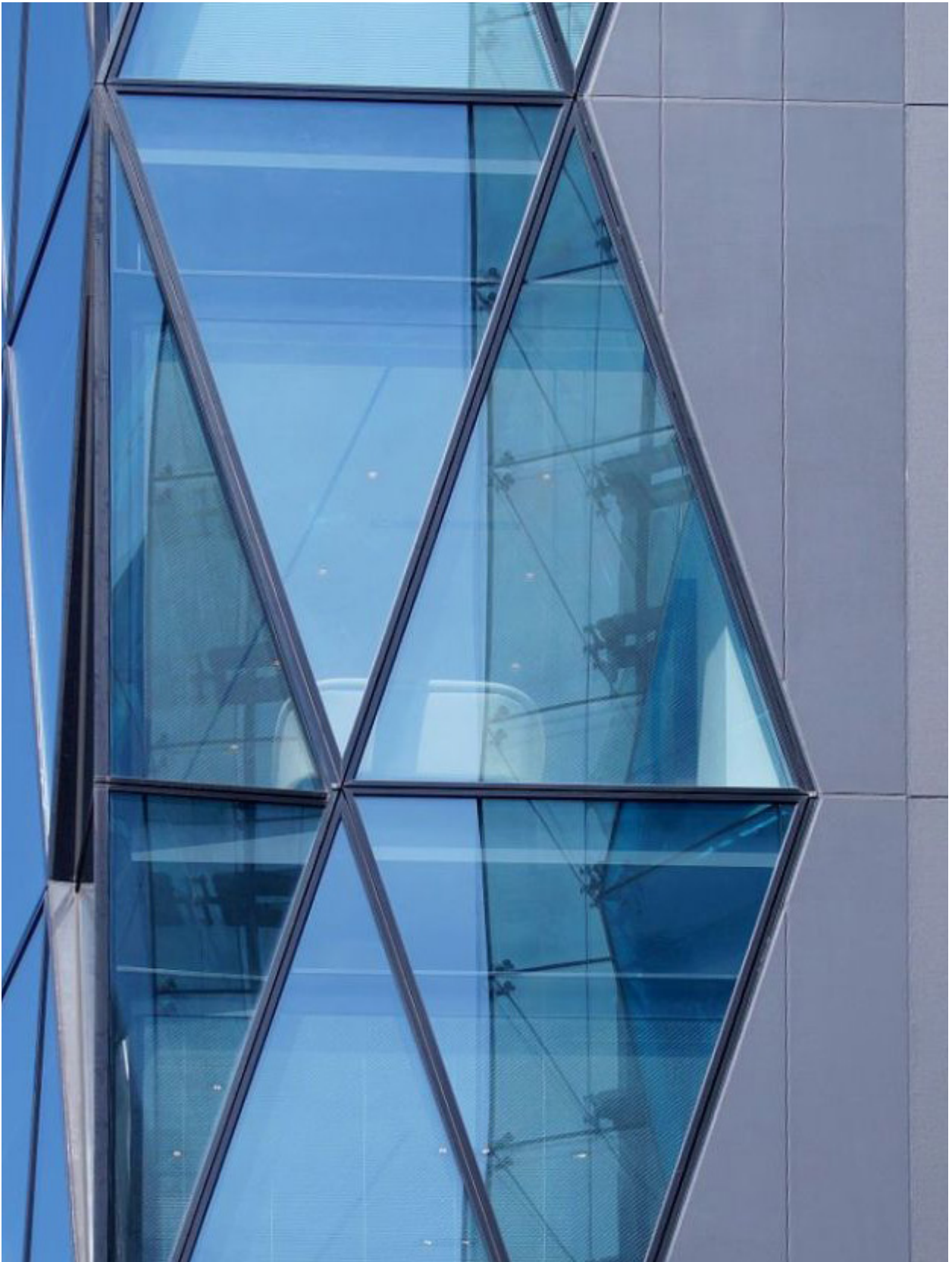

J6 Front / Matsuda Hirata design Inc. (image: M. Brzezicki)



# 1 Current status, requirements and opportunities for building performance simulation of adaptive facades

Roel C.G.M. Loonen, TU Eindhoven; Fabio Favoino, Politecnico di Torino; Jan L.M. Hensen, TU Eindhoven; Mauro Overend, University of Cambridge

## 1.1 Role of building performance simulation for design and operation of adaptive facades

To meet the sustainability targets that are set for the building sector, there is a need for continuing development of new building concepts, technologies and materials that can further improve the energy efficiency of buildings, while simultaneously enhancing the indoor environmental comfort of building occupants. The building envelope, or building facade, plays a key role in this process. In particular, the technologies that are able to, actively and selectively, manage the energy and mass transfer between the building and its external environment are considered to be of crucial relevance (IEA 2013, Perino and Serra 2015). These so-called adaptive building envelopes have the ability to (i) significantly reduce the energy use of buildings (Perino 2008), while (ii) improving the level of indoor environmental quality (Luable 2015), and (iii) having a positive impact on the match between on-site harvested renewable energy and building energy use (Reynders, Nuytten, and Saelens 2013).

The unique feature of adaptive building envelopes is the capability to adjust their thermo-optical properties in a reversible way to transient boundary conditions (either external, such as climate, or internal, such as occupants' requirements), in order to respond to changing priorities (i.e. minimizing the building energy use, maximizing the use of natural light, etc.). A state-of-the-art overview of various adaptive building envelope systems and components is presented in Loonen et al. (2013). Among the wide range of technology options, switchable glazing (Baetens, Jelle, and Gustavsen 2010), movable solar shading (Nielsen, Svendsen, and Jensen 2011), wall-integrated phase change materials (Kuznik et al. 2011), dynamic insulation (Kimber, Clark, and Schaefer 2014), and multifunctional facades (Favoino et al. 2014) are identified as the most promising adaptive building envelope systems. However, studies show that there is ample scope for further improvements (Favoino, Overend, and Jin 2015; Loonen et al. 2013).

Successful design of adaptive facades is a challenging task. In fact, they present a large technical potential, as demonstrated in scientific publications and testing reports, but low real-world uptake. This is partly due to a lack of thorough understanding of the benefits and possible risks, and the inability to measure them in a reliable way.

Adaptive building envelopes are complex systems that typically influence multiple physical domains simultaneously (e.g. thermal, luminous, air quality, etc.). Unlike most HVAC-dominated buildings, the performance of buildings with adaptive facades is to a very large extent determined by local climatic conditions and interactions with occupants and the other building systems. Traditional characterisation methods for building envelopes, such as U-value and g-value, are based on static assumptions. Therefore, due to the intrinsic time-varying behavior of adaptive facades, these

conventional metrics provide limited and potentially misleading information for these inherently dynamic systems. A more accurate and credible evaluation would instead determine their performance in terms of more comprehensive, whole-building performance indicators, such as total primary energy use and/or indoor environmental quality metrics.

Building performance simulation (BPS) has the potential to provide this type of information to several stakeholders, including building designers, material scientists, sustainable building consultants, control engineers and building services professionals (Clarke and Hensen 2015). The potential of the integration of modeling and simulation activities for performance analysis of adaptive facades can be illustrated in a number of different possible uses in the design and operation of buildings:

- Informed decision-making to support the design process of buildings with specific adaptive building envelope components, in particular when an optimal performance is required across occupant comfort, economic and environmental aspects;
- Prediction of energy saving potential compared to a baseline design as part of green building certification schemes such as LEED and BREEAM;
- Virtual rapid prototyping to evaluate different future-oriented systems/materials and identifying promising alternatives for further refinement and product development;
- Exploration of high-potential control strategies that maximise the performance of adaptive building envelopes during operation;
- HVAC system sizing and fine-tuning of the interaction between adaptive building envelope and other building services;
- Virtual testing of the robustness of adaptive facade systems with respect to occupant behavior and variable weather influences.

For these reasons, modeling and simulation can bring insights into the mutual influence between design and performance aspects of adaptive building envelopes, and can therefore strongly contribute to their spread into the building construction market, as well as to the development of innovative technologies. However, as we will demonstrate in this article, simulation of adaptive facades can be significantly more complex than performance prediction of conventional, static facades, because existing simulation tools were not originally developed for this purpose.

Designers, engineers and researchers who plan to use BPS for analyzing adaptive facades are faced with a number of challenges and should develop their simulation strategy accordingly. The currently available information about modeling approaches and issues regarding simulation of adaptive facades is fragmented. Simulation users therefore have limited guidance when it comes to factors such as software selection, availability of models for specific adaptive technologies, best-practice examples and important points of attention (such as modelling assumptions and strategies).

This chapter intends to provide researchers and designers, who are approaching the simulation of adaptive building envelope systems, with a critical overview of existing information, in order to enable them to choose the most suitable tool/method according to their needs and resources. This work was partly conducted in the Framework of European COST Action TU1403 – Adaptive Facades Network, within the Task group on building performance simulation of adaptive facades ([www.adaptivefacade.eu](http://www.adaptivefacade.eu)). The main aim of this Task group and of the work reported in this article is threefold: (i) to describe the current capabilities of BPS tools, (ii) to describe their current limitations and (iii) to specify the requirements of novel simulation strategies suitable for adaptive building envelope systems. In section 2, the general requirements and main challenges related to whole

building energy simulation of adaptive building envelope systems are described. Following, section 3 analyzes the opportunities and limitations of state-of-the-art simulation software at modelling adaptive building facades, based on their underlying assumptions and modeling methods. In section 4, we provide a detailed overview of the capabilities to model adaptive facades in five of the most widely-used building performance simulation tools, including an overview of simplified simulation strategies and workarounds. Finally, section 5 concludes the chapter by presenting ongoing trends and research needs that are expected to move modeling and simulation of adaptive building envelopes forward in the coming years.

## 1.2 Challenges for performance prediction of adaptive building envelopes

Modeling and simulation of adaptive building envelopes has to accurately represent a sequence of time-varying building envelope system states (or properties), instead of a static representation of the building enclosure. Moreover, for effective performance prediction of adaptive building envelope systems, it is essential to simultaneously consider multiple levels, in terms of (i) spatial scales, (ii) time resolutions, and (iii) physical domains. Compared to simulation-based analysis of conventional, static facades, two major additional requirements for performance prediction of adaptive systems are identified:

- Modeling time-varying facade properties: facade specifications (i.e. material properties or position of components) need to be changeable during simulation run-time to properly account for transient heat transfer and energy storage effects in building constructions (Loonen, Hoes, and Hensen 2014). Many state-of-the-art BPS tools have restricted functionalities for accomplishing this feature. These limitations, but also the various opportunities are further discussed in Section 4, together with some simplified simulation approaches used to overcome specific software constraints;
- Modeling the dynamic operation of facade adaptation: the dynamic interactions in adaptive building envelope systems give rise to a strong mutual dependence between design and control aspects (Loonen et al. 2013). The performance of adaptive systems fully depends on the scheduling strategy (i.e. control logic) for facade adaptation during operation. Moloney (2011) describes it as: “The design outcome in a project with kinetic facades is a process, rather than a static object or artifact”. Thus, to identify the characteristics of high-performance adaptive building envelope systems, it requires not only design considerations (i.e. facade system design parameters), but also insights into adequate automated and occupant-driven operation strategies of the dynamic facade. Moreover, effective design and operation of a dynamic facade system depends also on the integration with operations of the other building services. For example, limited lighting energy savings could be achieved if the operation of dynamic solar shading is not integrated with a lighting dimming system. Similarly, the integration with heating, ventilation and air-conditioning (HVAC), and renewable energy systems needs to be carefully considered. To explore such synergetic effects, it is important to take this integration into account in the simulation strategy.

## 1.3 Requirements and limitations of current BPS software

A large number of software tools are available for predicting the energy and comfort performance of buildings. Each program has unique features in terms of modeling resolution, solution algorithms, intended target audience, modeling options, ease-of-use vs. flexibility, etc. The simulation tools with most powerful modeling capabilities, and which have undergone most rigorous validation studies (e.g. EnergyPlus, ESP-r, IDA ICE, IES VE, TRNSYS), are all legacy software programs (Crawley et

al. 2008). Although these tools have active development communities, and receive regular updates and extension of modeling capabilities, their underlying concepts and basic software architecture do not change. Most tools stem from a time when adaptability of building components was not a primary consideration (Ayres and Stamper 1995; Oh and Haberl 2015). Consequently, the building shape and material properties are usually not changeable during simulation run-time in these tools, which restricts the options for modelling adaptive building envelope systems. The requirements and limitations of existing BPS tools can be grouped into five aspects as shown in Figure 1, based on their characteristics and underlying assumptions.

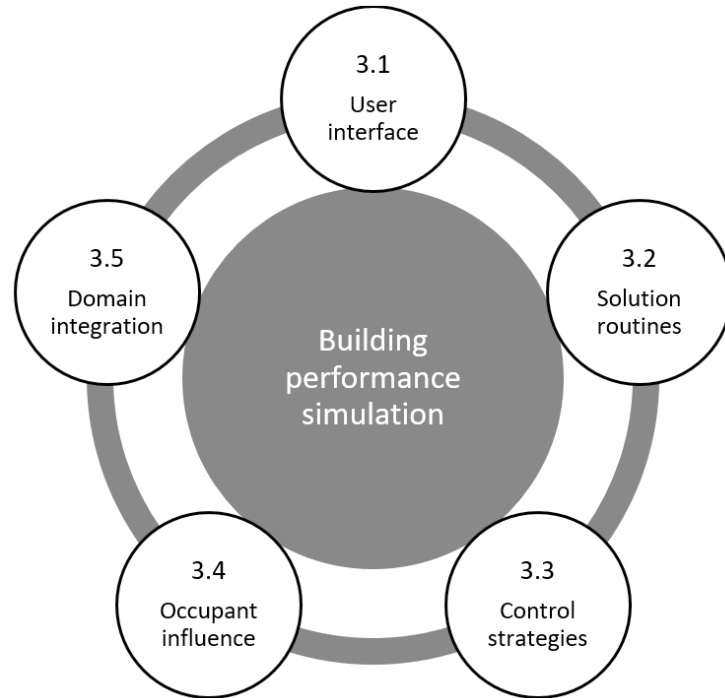

Figure 1 - Different modeling aspects playing a role in performance evaluation of adaptive building envelope systems (Loonen et al, 2017).

### 1.3.1 User interface

All modern BPS tools possess a graphical user interface (GUI) as a front-end for communication with simulation users. In these programs, the input for constructions and material properties is normally given in the form of scalar values. These parameters are either directly entered by the user, or imported from pre-configured databases. The same static representation is implemented for the size, geometry and orientation of the various surfaces that together form the building envelope. In the most common approach, this information is then processed once, prior to the actual simulation run, and is not updated further during the simulation. Users of the simulation tools have limited flexibility to extend the functionality for modelling adaptive building envelopes through the non-modifiable user interface and the restricted access to the source code of (proprietary) simulation tools. This is especially the case in the simulation tools that are geared towards the needs of architects (Attia et al. 2012).

Some exceptions to this rule also exist, in which two types of modeling features can be distinguished: (i) application-oriented and (ii) general-purpose features (Table 1). Application-oriented indicates that the modeling capability was implemented in the software with a specific

adaptive building envelope technology in mind and is labeled in the software as such. The adaptive mechanism and how it is triggered are therefore already embedded in the specific model, and users can activate it easily by means of the GUI, but are limited to the presets available. The general-purpose features, on the other hand, are not restricted to a specific technology, but offer flexibility for user-defined combinations of adaptive thermo-physical property variations and/or triggering mechanisms. This higher abstraction level affords more freedom for exploring innovative adaptive building envelope systems, although it requires the BPS user to define and code the control mechanism that triggers adaptation in the building element.

Table 1 - GUI modelling capabilities for adaptive building envelope technologies, pros (+) and cons (-) (Loonen et al, 2017).

Modelling capability	Features
Application-oriented	(+) Easy to use, robust (-) Restricted flexibility, limited number of options
General-purpose	(+) Offers more flexibility (-) Requires a high level of expertise and more input data from the BPS user

### 1.3.2 Solution routines for transient heat conduction through building elements

Many of the widely-used BPS tools adopt response factor techniques (e.g. Thermal Response Factors [TRF] or Conduction Transfer Functions [CTF]) to solve the differential equations governing the heat transfer phenomena through opaque building elements (Spitler 2011). These methods are optimised for computational efficiency, but by virtue of their design, they can only work with time-invariant thermo-physical properties (i.e. density, specific heat capacity, thermal conductivity) (Clarke 2001). This is because the coefficients that are used in the equations are constant and determined only once for each building envelope element at the beginning of the simulation. As such, response factor methods do not permit variations in thermo-physical material properties during simulation run-time (Delcroix et al. 2012; Pedersen 2007).

Other simulation tools use finite difference or finite volume methods for modeling transient conduction. These numerical methods adopt an iterative procedure, thereby allowing for updates of the matrix coefficients that describe heat transfer, as time steps of the simulation proceed. This makes the simulation of variable thermo-physical properties possible.

The models for calculating energy gains/losses through transparent portions of the building envelope, on the other hand, do not normally include thermal storage effects (Freire et al. 2011), so that it is easier to take dynamically changing window properties into account in the simulation, also in BPS tools adopting response factors techniques. A similar approach can be chosen for so-called massless layers (i.e. constructions with no or very low thermal capacity), which only affect thermal resistance, but do not influence the storage term in the heat balance equations.

### 1.3.3 Control strategies

Control strategies in BPS models provide the link between sensed variables and actuator actions

by means of a certain control logic. This feature is mostly used for control of HVAC systems but other opportunities also exist. The (non-)availability of actuator options is what in the end determines the types of adaptive facade technologies that can be modeled in a simulation tool. Figure 2 illustrates the general architecture for the control of building systems (including adaptive building envelope systems) in BPS tools, which can be divided into (i) sensors level (climatic boundary conditions, building internal boundary conditions, occupant preferences); (ii) control logic level; (iii) actuators level, i.e. any building component that can be controlled (including HVAC, artificial lighting and adaptive building envelope systems).

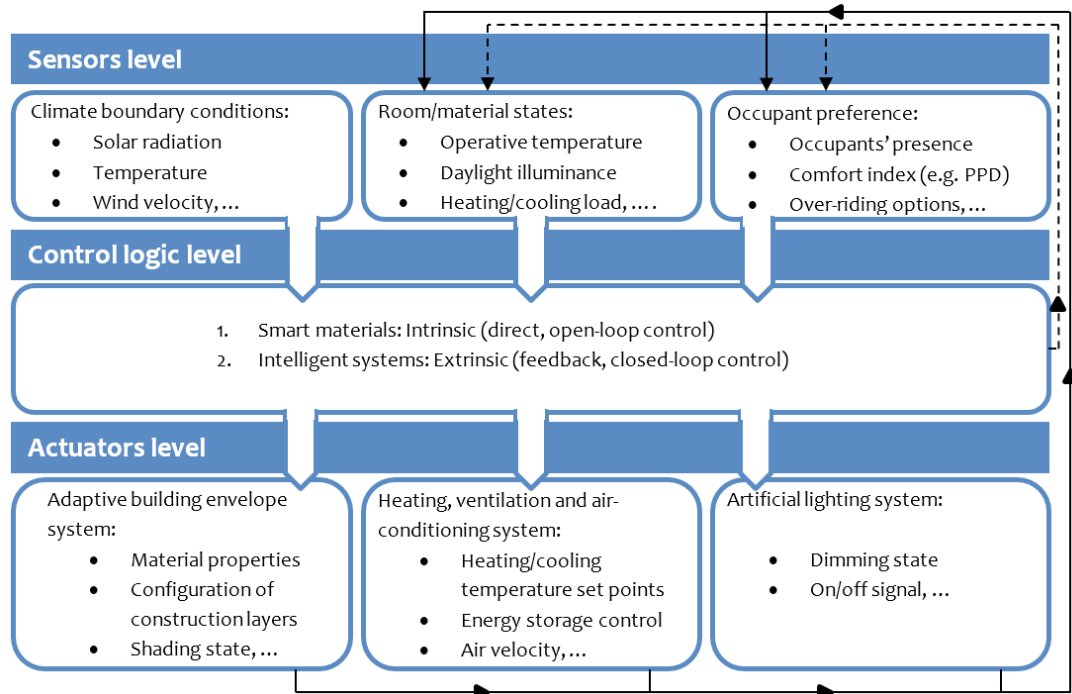

Figure 2 - Control architecture for building systems, including building services and adaptive facades: the continuous line represents active, closed-loop, control; the dashed line represents passive, open-loop, control (Loonen et al, 2017).

The control of adaptive building envelopes can be subdivided into (i) intrinsic and (ii) extrinsic concepts (Loonen et al. 2013). The term intrinsic indicates that the adaptive mechanism is automatically triggered by a stimulus (e.g. surface temperature, solar radiation, etc.). This intelligence is chemically embedded in the material and the switching mechanism is activated by a variation in its internal energy. This kind of control (dashed arrows in Figure 2) is also referred to as “direct” or “open-loop” control and the material is said to be “smart” (e.g. thermo-chromic, photo-chromic, phase change materials), as no intervention from an external system/user is required. In contrast, extrinsic refers to the presence of an external decision making component that is able to trigger the adaptive mechanisms according to a feedback rule (continuous arrows in Figure 2). This is the so-called “feedback” or “closed-loop” control type, and in this case, the adaptive system, which includes the adaptive building envelope component and the controlling system, is often referred to as “intelligent” (e.g. electro-chromic glazing, movable shading devices, kinetic facades, etc.). Hence, intelligent systems require a control management system in order to respond in an adaptive manner, consisting of sensors, processors and actuators.

The control options for adaptive building envelope systems available in BPS tools can be classified



into four groups: (i) hard-coded intrinsic, (ii) hard-coded extrinsic, (iii) time-scheduled, and (iv) script-based.

Hard-coded intrinsic control refers to control options for application-oriented modelling capabilities which are already implemented into the software and accessible through the GUI. This is the case, for example, for the actuation of thermo-optical properties of a fenestration system based on temperature (i.e. thermo-chromic windows), or for phase-changing materials, modeled via temperature-based changes in specific heat capacity.

Hard-coded extrinsic control, on the other hand, can usually be chosen from a limited number of fixed presets. These typically include if-then-else statements where the user can select (i) sensor types (e.g. incident solar radiation, room temperature, heating or cooling demand, etc., or combinations thereof) and (ii) control thresholds to actuate a specific adaptive technology.

Time-scheduled control shares many characteristics with hard-coded extrinsic control systems, but is different in the sense that control actions are pre-determined as a function of time, instead of being based on boundary conditions or simulation state variables.

Finally, more advanced intrinsic and extrinsic adaptive systems control options can be evaluated if a script-based control can directly be coded by the user in the simulation tool. Script-based control gives the possibility to test a specific control approach, replicating and extending the hard-coded direct or feedback preset options. The fundamental steps of modelling a script-based control are: (i) selecting from a list of available sensors (i.e. simulation state variables or boundary conditions); (ii) selecting from a list of possible actuators (chosen according to the specific adaptive technology/concept that needs to be simulated); (iii) coding a control algorithm, which translates sensor signals into actions, by means of simple algebraic and Boolean operators.

#### 1.3.4 Occupant influence

In contrast to conventional, static facades, adaptive building envelope systems can have an interdependent relationship with building occupants. For some applications, the simulation model needs to be able to evaluate not only how the adaptive building element affects occupant comfort conditions, but also how individual occupants may want to control a specific adaptive building envelope technology (Haldi and Robinson 2010) (Figure 2). This capability requires behavioral models that describe the interaction of building occupants with adaptive building envelope systems. For example, different deterministic and probabilistic models are available for occupants' operation of blinds and window openings (Haldi and Robinson 2010; Hoes et al. 2009). To date, such occupant interactions can only be implemented via script-based control approaches (Section 3.3) but efforts to integrate them more seamlessly into BPS tools are ongoing (Hong et al. 2015). The available information on the interaction of people with more advanced adaptive facade technologies is, however, still scarce (Bakker et al. 2014).

#### 1.3.5 Multi-domain integration and physical interactions

The influence of the building envelope on the indoor environment can be evaluated in different physical domains: e.g. thermal, visual and mass-flow (air and/or moisture). Moreover, to ensure

adequate levels of occupant comfort, there is a need to synchronise the actions of adaptive facades with the operation of building services. Because these multi-domain influences can be mutually interrelated, there may be a need to solve the differential equations that describe the relevant physical phenomena in a coupled way. Matching the required physical interactions of a specific adaptive facade technology with the capabilities of a BPS tool to assess the performance across these multiple domains is therefore an important requirement for selecting suitable simulation strategies.

The focus of this chapter is on the use of BPS tools to evaluate comprehensive building energy use and occupant comfort indicators. Most of these BPS tools are able to integrate thermal, airflow and building services (HVAC) domains, such as ESP-r, TRNSYS (Figure 3). A limited subset of them also integrates daylight models (and therefore artificial lighting models as well), such as EnergyPlus, IDA ICE, IES VE (Figure 3).

Whenever a BPS tool presents restricted cross-domain modelling capabilities, the exchange of information between different BPS tools across different domains, can be managed (i) before the simulation (data and process model integration) or (ii) during simulation run-time (data and process model co-operation) (Hensen et al., 2004), also called co-simulation (Trcka, Hensen and Wetter 2009) (cf. Section 5.3)

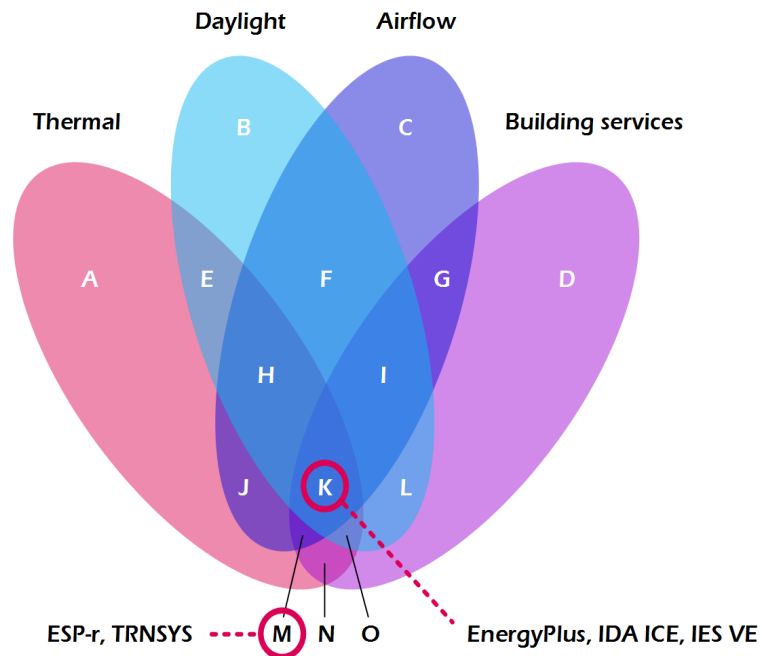

Figure 3 - Multi-domain integration required to model adaptive building facades in different BPS tools (Loonen et al, 2017).

#### 1.4 Capabilities of various building energy simulation software tools

The previous section has introduced several challenges and limitations, but at the same time also highlighted numerous opportunities for effective performance prediction of buildings with adaptive facades, based on BPS tool characteristics and underlying modelling assumptions. The main aim of this section is to develop these capabilities further by reviewing the specific adaptive envelope modeling capabilities of five widely-used BPS tools in more detail.

It should be noted, however, that simulation users have also developed various approaches to partially overcome or bypass the aforementioned limitations for modeling adaptive facade behavior in the simulation tool of their choice. The principles and possible pitfalls of such simplified approaches are described first (Section 4.1), before presenting the methodology (Section 4.2) and results of the review of application-oriented and general-purpose modeling features (Sections 4.3 and 4.4, respectively), and control options (Section 4.5).

#### 1.4.1 Simplified simulation strategies and workarounds

Building performance simulation is a field where modeling features, almost by definition, lag behind the newest breakthrough technological developments and most creative design proposals. Workaround simulation strategies therefore have a long tradition in this field (Brahme et al. 2009), and can be used for various legitimate reasons such as: the complete absence of existing models for certain adaptive building envelope technologies; a lack of user expertise/experience; limited project resources (time, money) to move towards more complex models; the absence of advanced control options for determining the optimal dynamic building envelope properties. In many of these cases, the ability to reuse validated, high-resolution models is an important argument in favour of using existing software instead of the development of custom-made simulation code from scratch (Wetter 2011a), such as the approach taken by Liu et al. (2014). A main drawback of using workarounds is that they tend to rely on approximations or simplifications that might infringe the physics of model representations and, consequently, also put the credibility of simulation outcomes at risk.

Arguably, the simplest approach for representing an adaptive building envelope system is by subdividing the simulation period (e.g. one year) into several simulation runs with shorter periods (e.g. seasons, months, weeks, etc.), each with distinct building properties (Kasinalis et al. 2014; Favoino, Jin, and Overend 2014; Joe et al. 2013; Hoes et al. 2011; Loonen, Trčka, and Hensen 2011) (Figure 4a). This discrete approach works well for facade systems with long adaptation cycles (e.g. seasonal), but it cannot accurately model short-term adaptive building envelope dynamics. This is due to shortcomings in the initialization of equations at the start of each simulation run, where the end states of one simulation (i.e. surfaces and construction nodes temperatures) are different from the starting conditions of the subsequent simulation.

An alternative approach uses separate models for the whole simulation period, each with static properties that represent different states of the adaptive building envelope system. At a post-processing stage, the results of these independent simulation models are combined in a single representation of the performance of the building, according to a certain control strategy for the adaptive facade (Figure 4b). This modelling approach can have the advantage of (i) mimicking more advanced building operation controls and/or (ii) simulating adaptive building envelope technologies and materials for which a model does not exist yet. Specifically, even though such a modeling method is well able to capture switching of instantaneous solar gains, e.g. due to changing window-to-wall ratio (Goia and Cascone 2014) or glazing properties (DeForest et al. 2013), it fails to account for the effect of delayed thermal response due to capacitance of building components (i.e. slabs, walls and internal partitions). Therefore in cases where thermal mass is involved in adaptive building envelope operations, the use of these approximate models would probably lead to significant errors in the results, because they do not correctly handle transient thermal energy storage effects (Erickson 2013). These inaccuracies may eventually compromise decision-making based on simulation outcomes, but little information about this issue is reported in literature.

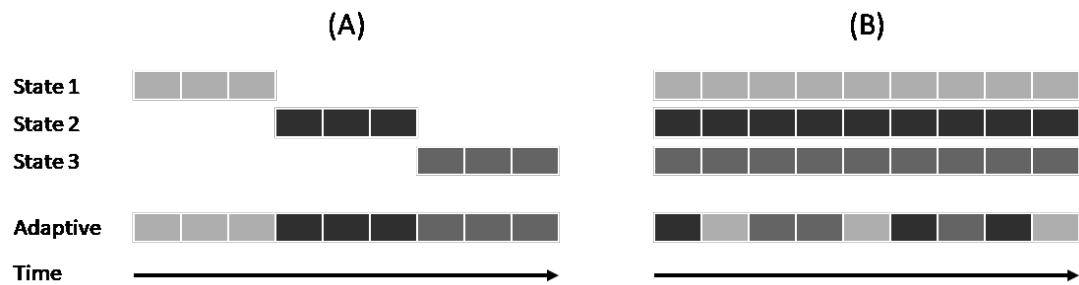

Figure 4 - Schematic representation of workaround strategies for modeling the performance of adaptive facades. Case A represents the discrete approach that combines a number of short term simulations. Case B represents the approach that assembles the results of simulations with static facades during post-processing (Loonen et al, 2017).

### 1.4.2 Overview of capabilities – methodology

A review of the opportunities for modeling adaptive building envelope systems in state-of-the-art BPS tools was conducted to compile an overview of the current capabilities and existing development needs. Based on literature review (Crawley et al. 2008; Attia et al. 2012) and first-hand experience, five simulation tools (presented in Table 2) were selected on the basis of the following criteria:

- Extensive building envelope modeling capabilities, as identified by Crawley et al. (2008);
- Subject to active development by their development team or user community;
- Thorough validation through compliance with ANSI/ASHRAE Standard 140 (BESTEST) and other quality assurance procedures;
- Use in both research and consulting engineering practice;
- International user base.

The analysis of capabilities is based on the information in user manuals, software tutorials, release notes and contextual help facilities of the BPS tools, as well as communication with their development teams. Furthermore, scientific articles, dissertations and the information exchange in mailing lists were used to gather input. The review outcomes are divided into (i) application-oriented, (ii) general-purpose, and (iii) control capabilities for each software, following the descriptions in sections 3.1 and 3.3.

The review is also presented in a tabular fashion, the notation used is indicated in Table 3 and includes: required and available relevant physical domains (T: thermal, V: visual, A: airflow), type of control (represented by the cell color), control options related to a specific technology (only for Table 6, indicating the modelling options for which this control is available), level of expertise required (in the form of a superscript for knowledgeable users and expert users). “Knowledgeable user” refers to the need to develop custom-made scripts within the software interface. “Expert user” requires an even higher level of proficiency as it indicates that either creative modeling approaches have to be used, that the features are not documented, or that small source code modifications are necessary.

### 1.4.3 Application-oriented capabilities

The software capabilities were assessed for 20 different adaptive facade technologies and

Table 2 - Characteristics of whole Building Energy Simulation tools with respect to performance prediction of adaptive building envelope systems (Loonen et al, 2017).

	<b>Conduction solution method</b>	<b>User Interface<sup>2</sup></b>	<b>Source code access and modification</b>	<b>Control simulation capabilities</b>	<b>Physical domain integration</b>
<b>EnergyPlus v8.3</b>	CTF, Finite difference <sup>3</sup>	IDF editor, DesignBuilder, Comfen, OpenStudio, Simergy, Sefaira, DIVA, AECOSim	X	Presets, Time-scheduled, Energy Management System	Thermal, Visual, Airflow
<b>ESP-r</b>	Finite volume	Graphic and text mode	X	Presets, Time-scheduled	Thermal, Airflow <sup>4</sup>
<b>IDA ICE v4.7</b>	Finite difference	Standard and advanced level	X	Presets, Time-scheduled	Thermal, Visual, Airflow
<b>IES v2015</b>	Finite difference	IES VE, SketchUp and Revit plug-ins <sup>5</sup>		Presets, Time-scheduled, Formula profile (APpro)	Thermal, Visual, Airflow
<b>TRNSYS v17.1</b>	CTF	TRNBuild, SketchUp plug-in	(X) <sup>6</sup>	Presets, Time-scheduled, user-defined <i>equations</i> in Simulation Studio	Thermal, Airflow

Table 3 - Legend for Tables 4 and 5 (Loonen et al, 2017).

<b>Expertise required</b>		<b>Control</b>	<b>Physical Domain</b>	
*	Knowledgeable user	Intrinsic	T	Thermal
**	Expert user	Extrinsic	V	Visual
			A	Airflow

corresponding application-oriented modeling features (Table 4); the main findings are discussed in this section.

Different types of switchable windows, including electrochromic glazing, are commercially available, and many research papers have been written about their application in buildings and architecture (Baetens, Jelle, and Gustavsen 2010). As a result of their presence in the market, options for modeling switchable glazing technologies are embedded in several simulation tools. All the software tools analyzed offer the possibility to control properties of the fenestration system during simulation run-time. The differences between the various implementations are the number of possible window states (e.g. on/off versus gradual transitions) and the simulation state variables that can be used for control of adaptation (e.g. room temperature, ambient temperature, incident radiation).

Thermo-tropic/chromic windows are slightly more complicated to simulate than other switchable window types because of their intrinsic control character; adaptation of the fenestration properties is directly triggered by window surface temperature instead of a control signal that is based on more general simulation variables. A provision for thermochromic window simulation was implemented in EnergyPlus (since v3.1, 2009) and ESP-r (Evans and Kelly 1996). The input of these models consists of sets of window properties at various temperatures. During the simulation, the thermochromic layer temperature of the previous time-step is automatically fed into a window control algorithm which then selects the window properties that best match with the given temperature. In IDA ICE and Trnsys, it is also possible to model thermo-tropic/chromic windows, but



a significantly higher level of work and expertise is required from the user side (Section A.3 for IDA ICE and A.5 for TRNSYS)..

Table 4 - Overview of application-oriented features for modeling adaptive building envelope systems (Loonen et al, 2017). See Table 3 for legend.

	#	Adaptive facade technology	Required Domains	Energy Plus	ESP-r	IDA ICE	IES VE	TRNSYS Type 56	
Transparent	Switchable glazing	4.1	Electro-chromic (EC), Liquid crystal, SPD	T-V	T-V	T	T-V	T-V	T*
		4.2	Photo-volta-chromic	T-V	T-V *	T*	T-V**		T*
		4.3	Independently tunable NIR-VIS EC	T-V					T**
		4.4	Thermo- tropic / chromic	T-V	T-V	T	T-V**		T*
		4.5	Photo-chromic	T-V	T-V *	T	T-V**	T-V*	T*
		4.6	Fluidglass	T-V					
	Shadings	4.7	Screens / roller shades	T-V	T-V	T	T-V	T-V	T
		4.8	Blinds with slat angle control	T-V	T-V	T	T-V		
		4.9	Bi-directional transmission control	T-V	T-V	T	T-V		T**
		4.10	Insulating shutters	T-V	T-V		T-V	T-V	
		4.11	Shading with dual-axis tracking	T-V					
		4.12	Phase change material	T-V			T-V		
	Opaque	4.13	Double skin facade	T-V-A	T-V-A*	T-A*	T-V-A*	T-V-A*	T-A*
4.14		Double skin facade	T-A	T-A*	T-A*	T-A*	T-A*	T-A*	
4.15		Trombe wall	T-A	T-A*	T-A*	T-A*	T-A*	T-A*	
4.16		Green roof	T	T	T			T**	
4.17		Green wall	T	T	T			T**	
4.18		Movable/switchable insulation	T	T		T			
4.19		Thermocollect	T						
4.20		Phase change material	T	T	T	T		T**	

Moveable internal and external solar shading is probably the most widely-used adaptive building envelope function. In all simulation tools that were included in this study, it is available in various forms. The GUIs of EnergyPlus, IDA ICE and IES VE offer the possibility to give dynamic shading devices additional thermal resistance properties. This makes it possible to simulate the performance of insulating solar shading systems (Hashemi and Gage 2012). In such an implementation, dynamic thermal insulation and solar shading are coupled, so that their separate effects cannot be analyzed. As the need for coupled analysis of thermal and daylight aspects gets increasingly recognised, the options for modeling more advanced optical facade systems in building energy simulation software are also expanding (Table 4). Recent additions in many tools include the possibility to control the slat angle of blind systems and the properties of light-redirecting complex fenestration systems.

Prediction models for wall-integrated phase change materials (PCM) are present in EnergyPlus (Tabares-Velasco, Christensen, and Bianchi 2012), ESP-r (Heim and Clarke 2004), IDA ICE (Plüss et al. 2014) and TRNSYS (Kuznik, Virgone, and Johannes 2010). These models influence heat transfer in constructions via either the 'effective heat capacity' or the 'additional heat source'/'enthalpy' method. The need to implement PCM features led the developers of EnergyPlus to abandon the CTF approach and introduce a numerical finite difference conduction algorithm (Pedersen 2007). This new algorithm includes a temperature coefficient that allows variable thermal conductivity during the simulation (Tabares-Velasco and Griffith 2012). Only a few applications of this latter model were found in literature. The performance of transparent/translucent PCM systems

can only be modeled in IDA ICE (Plüss et al. 2014) or with the use of reduced-order building models (Goia, Perino, and Haase 2012).

The capability of simulating double skin facades (either transparent or opaque, including Trombe walls and ventilated facades) is generally available in several whole building simulation tools (EnergyPlus, ESP-r, TRNSYS, IDA ICE, IES VE) (Hensen, Bartak, and Drkal 2002; Kim and Park 2011). Some BPS tools provide specific models for the simulation of double skin facades from the GUI (e.g. multi-skin in EnergyPlus), although their accuracy depends on the choice and availability of calculation methods for cavity heat transfer in terms of the mode of ventilation (buoyancy driven and/or mechanical), the ventilation air path (from outdoor to indoor, outdoor to outdoor, etc.), the type of solar shading in the ventilated cavity (Kim and Park 2011), and the spatial discretization of the air cavity (Mateus, Pinto, and Da Graça 2014). Additionally, it is generally possible to represent a multiple skin facade by coupling the thermal model with an airflow network, but additional modelling could be required in order to ensure reliability of the results (Favoino 2015).

EnergyPlus, ESP-r, and TRNSYS support the simulation of green walls and roofs. The models account for: (i) long-wave and short-wave radiative exchange within the plant canopy, (ii) plant canopy effects on convective heat transfer, (iii) evapotranspiration from the soil and plants, and (iv) heat conduction and storage in the soil layer (Sailor 2008; Djedjig, Bozonnet, and Belarbi 2015). In the EnergyPlus model, it is possible to include material properties that change over time with fluctuations in plant growth and moisture content (Sailor and Bass 2014).

Finally, EnergyPlus (Jin, Favoino, and Overend 2015) and IDA ICE (Bionda, Menti, and Manz 2014) can simulate the performance of building envelopes with moveable insulation. A controllable layer can be applied to the interior or exterior side of an opaque facade element to temporarily increase its thermal resistance. These materials are massless, which means that no thermal energy can be stored in a moveable insulation layer.

The suitability of a model for evaluating the performance of a particular adaptive building envelope system depends to a large extent on the flexibility that the BPS tool offers in terms of the control strategies that are available. This is especially the case for the application-oriented modelling features with extrinsic controls that are discussed in this Section. More attention to the implementation and availability of control options is given in a separate section (Section 4.5).

The review of application-oriented modelling options presented in this chapter focuses on software capabilities. It is not intended to provide a comprehensive review of existing adaptive building envelope materials, technologies and systems. In fact, the tendency of BPS tools to lag behind the market availability of adaptive technologies limits the number of application-oriented modelling capabilities available in a specific BPS tool, compared to what is technologically available. As such, there are many adaptive building envelope systems (either at prototype or product stage), whose performance cannot be evaluated yet with the existing application-oriented simulation models. Some examples are included in Table 4 for illustration (i.e. 4.3 (Llordés et al. 2013), 4.6 (Ritter 2014), 4.11 (Rossi, Nagy, and Schlueter 2012), 4.12 (Goia, Perino, and Haase 2012), 4.19 (Burdajewicz, Korjenic, and Bednar 2011)).

Therefore, from a product development point-of-view, it is more desirable to allow for bottom-up or general-purpose approaches to simulate emerging or not-yet-existing adaptive building envelope materials and technologies (Loonen et al. 2014).

### 1.4.5 General-purpose modeling options

General-purpose modeling options offer more flexibility than application-oriented features. A review of available general-purpose adaptive features is presented in this section and the results are summarised in Table 5. The discussion that follows provides the principal outcomes of this review. A more extensive description of the capabilities of each simulation tool is provided in Appendix A.

Table 5 - Overview of general-purpose modeling features for adaptive building envelope systems (Loonen et al, 2017). See Table 3 for legend.

#	Controllable property	Required Domains	EnergyPlus	ESP-r	IDA ICE	IES VE	TRNSYS
5.1	Visible optical properties	T-V	T-V*	T	T-V*	T-V*	T*
5.2	Solar optical properties	T-V	T-V*	T	T-V*	T-V*	T*
5.3	Emissivity	T	T*				
5.4	Surface heat transfer coefficient	T	T*	T*	T*	T*	T*
5.5	Solar absorption	T	T*				
5.6	Conductivity	T	T*	T*	T**		T**
5.7	Density / specific heat capacity	T		T*	T**		
5.8	Facade geometry	T-V					
5.9	Site rotation	T-V	T-V**	T*			T*
5.10	Evaporation at surface	T		T*			

**EnergyPlus** Of all software tools analyzed, EnergyPlus has had the largest growth in adaptive facade modeling capabilities since it was developed. Most notably, these developments have been driven by the introduction of the EnergyPlus Runtime Language (ERL) (Ellis, Torcellini, and Crawley 2007). With ERL, users can implement Energy Management Systems (EMS) of various kinds by linking sensors, control logic and actuators. Among the possible EMS actuators are various thermophysical building envelope material properties (Table 5). These actuators can be controlled with user-defined IF-ELSE statements during simulation run-time.

**ESP-r** ESP-r is a simulation tool with an open-source environment aimed at the research community. Since its first version, various groups have contributed general-purpose functionalities for modeling adaptive facade technologies. The capabilities include: (i) thermo-physical property substitution mode (MacQueen 1997), (ii) transparent multi-layer construction control, (iii) special materials (Evans and Kelly 1996), (iv) variable thermo-physical properties (Nakhi 1995), and (v) the use of roaming files to model rotating buildings with changeable orientation. Each of these models has unique characteristics as well as control restrictions, as described in Appendix A and Section 4.5.

**IDA ICE** Unlike most other simulation tools, IDA ICE works with symbolic equations instead of variable assignments (Sahlin 2004). This feature makes it relatively easy to upgrade existing modeling functionality, as was recently done for the finite-difference multi-layer wall model (“fdwall”) that can now account for time-varying thermo-physical properties (“fdwalldyn”) (Bionda, Menti, and Manz 2014). Other adaptive features in IDA ICE can be activated by defining custom control macros, and selecting the advanced-level instead of standard user interface.

**IES VE** IES VE is a commercial simulation tool with a closed software environment. The program gives limited flexibility for modeling adaptive facades beyond the application-oriented features that were discussed in section 4.3. Nevertheless, using APpro, the

module for time-scheduling and profiles in IES VE, there are some opportunities to link user-selected sensor values with time-varying facade property actuators (Table 5).

**TRNSYS** In TRNSYS, the multi-zone building model (TYPE 56) is one out of a large number of possible system components. The variable window id option and a controllable bi-directional scattering distribution function (BSDF) (Hiller and Schöttl 2014) are directly implemented in TYPE 56. All other adaptive features in TRNSYS can be activated by manipulating (i.e. switching on/off or modulating) the connections to and from the TYPE 56 building model. These functions include overhangs and wingwalls (TYPE 34), shading masks (TYPE 64), attached sunspaces (with or without movable thermal insulation) (TYPE 37), windows with variable insulation properties (TYPE 35) and photovoltaic modules (TYPES 94, 180 and 194). In addition, it is also possible to adjust the way that weather files and radiation processors are connected to model the effect of time-varying facade orientations (e.g. rotating buildings).

### 1.4.6 Control options

An overview of the control options, according to the definitions given in section 3.3 (hard-coded intrinsic, hard-coded extrinsic, time-scheduled and script-based), is provided in Table 6. The table provides different information for each of the four control options:

- hard-coded intrinsic: only available for application-oriented modelling capabilities, the reader is redirected to Table 4 for the specific passive technologies;
- hard-coded extrinsic: only available for application-oriented modelling capabilities. The rows indicate the different sensors options, and the number indicates the particular adaptive facade technology in Table 4 to which the specific control can be applied;
- time-scheduled: available for all hard-coded extrinsic application-oriented modelling capabilities;
- script-based: available for all application-oriented modelling capabilities (indicated as T4) and partially for general purpose modelling capabilities (indicated as a number in row 6.19 referring to Table 5). Row 6.18 indicates the availability of sensor options.

The script-based control approaches include EMS (EnergyPlus), user-defined control macros (IDA ICE), APpro (IES VE) and “equations” (TRNSYS). This control approach can also be applied, differently for each BPS tool, to the other three control options (hard-coded intrinsic and extrinsic, as well as time scheduled). This is indicated with a shaded cell in the Table 6.

Dynamic operation of building components is usually represented in BPS tools by means of hard-coded preset rules (6.2 – 6.16) or time-scheduled operations (6.17). These control options are related to application-oriented modelling capabilities, in which the control rule is often closely related to operating modes of the technology itself. The hard-coded preset control rules can be editable, if the specific technology allows for extrinsic control, by selecting from a limited number of sensor options in the GUI. Otherwise, if the specific technology modelled is a smart adaptive technology, that is, only intrinsic control is available, the preset control rule is fixed and cannot be edited (e.g. relationship between glazing thermo-optical properties and glass temperature for thermochromic glazing).

When adopting a general-purpose modelling approach, the user is required to explicitly model the way the adaptive mechanism is triggered by boundary conditions, by defining sensors, control algorithms (either intrinsic or extrinsic) and actuators, following the architecture represented in Figure 2. This can be done in the user interface of the specific BPS tool, by means of scripting and/or the use of graphical interfaces (Table 6, script-based control type). This approach, although requiring a higher level of user expertise, and more detailed information about how the adaptive building element/material is controlled, gives a higher level of flexibility for modelling innovative components with different and more advanced control strategies/algorithms.

Table 6 - (Loonen et al, 2017). Overview of control modeling features for adaptive building envelope systems, numbers in the table entries indicate the applicability of the control to a specific model (cf. Table 4 and 5).

#	Control type	Boundary condition	Sensor	EnergyPlus	ESP-r	IDA ICE	IES VE	TRNSYS
6.1	Hard-coded Intrinsic	Material state	NA	Cf. Table 4	Cf. Table 4	Cf. Table 4	Cf. Table 4	Cf. Table 4
6.2			Always on	All extrinsic	All extrinsic	All extrinsic		
6.3			Always off	All extrinsic	All extrinsic	All extrinsic		
6.4	Hard-coded Extrinsic	Climate	Outdoor air temperature	4.1, 4.2, 4.7-10, 4.13-15, 4.18	4.1, 4.2, 4.7, 4.8, 4.9	4.13-4.15		
6.5			Horizontal solar radiation	4.1, 4.2, 4.7-10				
6.6			Perpendicular solar radiation	4.1, 4.2, 4.7-10	4.1, 4.2, 4.7, 4.8, 4.9	4.1, 4.2, 4.7-10	4.1, 4.2, 4.7, 4.10	
6.7			Block beam solar radiation	4.1, 4.2, 4.7, 4.8				
6.8			Day/Night	4.18			4.10	
6.9			Wind speed	4.13-15			4.1, 4.2, 4.7-10	
6.10			Hard-coded Extrinsic	Building states	Heating load	4.18		
6.11	Cooling load	4.1, 4.2, 4.7-10, 4.18						
6.12	Zone air temperature	4.1, 4.2, 4.7, 4.10, 4.13-15, 4.18			4.1, 4.2, 4.7, 4.8, 4.9, 5.6-7			
6.13	Daylight level	4.1, 4.2, 4.7-4.10						
6.14	CO <sub>2</sub> concentration	4.13, 4.14			4.13, 4.15			
6.15	Occupants' presence	4.1, 4.2, 4.7-10, 4.13-15, 4.18						
6.16	Occupant		Visual comfort (e.g. glare)	4.1, 4.2, 4.7-10				
			Thermal comfort (e.g. PMV)	4.13-15				
6.17			Time scheduled	N/A	N/A	All extrinsic	All extrinsic	All extrinsic
6.18	Script-based		Sensor	Any output		Any output	Limited	Any output
6.19			Actuator	T4, 5.1-6, 5.9		T4, 5.1-2, 5.4, 5.6-7	T4, 5.1-2, 5.4	T4, 5.1, 5.2, 5.4, 5.6, 5.9

Design performance evaluation of adaptive building envelope systems could require the need for calculating metrics that may not be directly available as outputs of the simulation tool. For example double skin facades can be evaluated and/or operated according to their dynamic insulation efficiency or pre-heating efficiency (Zanghirella, Perino, and Serra 2011). Allowing the user to make



this intermediate step, by transforming simulation outputs into this type of custom performance metrics / control input could enable a more efficient design process, while simultaneously allowing the evaluation of more advanced control strategies. This can be done by means of script-based control strategies.

## 1.5 Specific BPS software capabilities

This section aims to provide a more comprehensive explanation of the general-purpose modelling capabilities and control options available in each of the BPS tools analyzed. By means of this section readers could investigate whether the specific BPS tool is suitable for their modelling purpose, if an application-oriented option is not available in the user interface already. This section is included as an Appendix in the paper Loonen et al. (2017).

### 1.5.1 EnergyPlus

EnergyPlus is a modular whole building energy simulation program based on the best features and capabilities of BLAST and DOE-2.1, developed under auspices of the US Department of Energy. Its modular structure was designed in order to integrate different simulation engines (building loads and systems) and models (i.e. heat and mass balance, thermal comfort, daylight, advanced fenestration, etc.). One of the main goals for developing this tool was to enhance the possibility of adding and validating new models. Thanks to this feature, different modelling capabilities have been included into EnergyPlus so far, which is reflected by the high number of releases from the first one (currently at version 8.3). This has enabled the implementation of application-oriented modelling capabilities for different technologies, which was presented in the previous section. Recently, EnergyPlus Runtime Language (ERL) was added to EnergyPlus (Ellis, Torcellini, and Crawley 2007) in order to replicate a building Energy Management System (EMS) in the simulation tool. The system is based, as in the real world, on the same elements of an EMS (sensors, control logics/algorithms and actuators). Since the latest release of the EMS system (US DOE 2015a), new actuators were introduced that enable control of thermo-optical properties at the building envelope level. The available actuators are able to control different building envelope adaptive components and properties, such as window shading devices, slat angle of the shading device, surface heat transfer coefficients, material surface properties, surface construction state (material construction properties), and surface boundary conditions. Moreover, any schedulable action in EnergyPlus can be controlled by means of an actuator within the EMS. A control algorithm can be designed in the EMS by means of IF-ELSE statements and simple algebraic operations, adopting the ERL programming language. The control algorithm can be used to control any actuator, based on data from sensors (wherein any output of EnergyPlus can potentially be treated as such). For example the surface construction state actuator can be used to simulate variable thermo-optical properties: different constructions can be created, characterised by different thermo-physical properties, to be used in sequence according to a user-defined control algorithm (Favoino, Overend, and Jin 2015). However the different constructions are required to have similar thermal capacity due to limitations of the solution routines for the transient conduction through the building envelope elements adopted in EnergyPlus (US DOE 2015a). The EMS can be used to simulate controllable building envelope properties, also of technologies for which a model is not available yet, or to implement more advanced control strategies which are not available in EnergyPlus as hard-coded presets. Moreover the EMS could be used to overcome some limitation at integrating smart glazing control

with the simulation of artificial lighting systems control (Favoino and Overend 2015). In fact it is not possible to simulate the control of the lighting systems for intermediate states of the smart glazing, when using the application-oriented modelling approach.

Due to the relatively new development, few documented applications of the use of EMS to model adaptive building envelope systems are available in literature. Moreover little evidence was found in literature about the reliability of the EMS modelling approach when applied to dynamic building envelope components. Although for the specific case of modelling smart glazing, negligible differences exist between the application-oriented model and the general-purpose one by means of the EMS modelling approach (Favoino et al. 2015).

### 1.5.2 ESP-r

ESP-r is a multi-domain research-oriented BPS tool with an active development community and a source code that is accessible and modifiable. Over the course of the years, several functionalities that can be used to model adaptive behavior in the building shell have been implemented by various research groups. Nevertheless, the use of these capabilities has remained limited, possibly because the features are (i) not well-documented or (ii) concealed somewhere in the distributed menu-structure of ESP-r. This section summarises five of such features:

One of the control laws in ESP-r is called thermo-physical property substitution mode. It is the only strategy that is not used for controlling the operation of HVAC systems. Instead of this, this control strategy can replace the thermo-physical properties ( $\lambda$ ,  $cp$ ,  $\rho$ ) of a construction during the course of the simulation. In essence, this control works like any other control algorithm in ESP-r, in the way that actions are triggered based on 'tests' applied to sensed variables during run-time (MacQueen 1997). Unfortunately, this feature does not allow for full flexibility since it only affects opaque wall elements and the only 'sensor variable' is indoor air temperature.

The previous feature dealt with opaque construction elements only, however, ESP-r also has a similar functionality available for modeling dynamic behavior of windows; transparent multi-layer construction control. This functionality can for example be used for performance prediction of switchable glazing technologies. Currently it is possible to replace window properties (.tmc-files) based on time, temperature, solar radiation level or illuminance level. Restrictions are that no more than two window states are supported without the possibility for gradual transitions. Recently, the capabilities of ESP-r have been further extended with the implementation of two new facilities for modeling transparent facade systems. Both the complex fenestration constructions (CFC) (Lomanowski and Wright 2012) and the advanced optics (Kuhn et al. 2011) module have powerful options for facade systems with dynamic fenestration properties.

In ESP-r, the special materials facility was introduced to model 'active building elements' (Evans and Kelly 1996). This universal functionality may be applied to any node within a multi-layer construction. The special material subroutines can actively modify the matrix coefficients of these specific nodes at every time-step. By doing this, it directly changes basic thermo-physical or optical properties and/or the associated energy flows at the equation-level, based on the respective physical relationships. Currently, the following special materials are implemented: building-integrated photovoltaics, ducted wind turbines, solar thermal collectors, thermochromic glazing, evaporating surfaces and phase change materials. It is possible to add new user-defined special materials; however this may require time-intensive programming work.

ESP-r offers the unique possibility to use roaming files. This facility is used to change the location of a building as a function of time, and was originally intended to be used for cruise ships. Because this roaming file not only includes coordinates but also orientation of the zone, it is very well suited for simulation of rotating buildings.

Nakhi (1995) introduced variable thermo-physical properties in ESP-r with the aim to model heat transfer in building slabs in a more accurate way. The model takes into account that the properties of most construction materials are not constant, but change as a function of temperature and/or moisture content. This dependency is implemented via transient thermo-physical material properties ( $\lambda$ ,  $c_p$ ,  $\rho$ ) that are linear or polynomial functions of layer temperature or moisture content. The same functionality can be used to model certain types of adaptive building envelopes.

### 1.5.3 IDA ICE

IDA Indoor Climate and Energy (IDA ICE) is a flexible, whole-building performance simulation tool that is mostly used in Nordic and Central European countries. It covers multiple physical domains, including models for building envelope heat transfer, flow networks, daylight illuminance and energy systems analyses. IDA ICE works with symbolic equations instead of variable assignments (as most other BPS tools do), and therefore it is relatively easy to extend the existing modeling functionality. For example, the finite-difference multi-layer wall model “fdwall” was recently extended with a new model “fdwalldyn” that allows for time-varying thermo-physical properties. The tool has both a standard and advanced level interface. This enables a separation of concerns where expert users can implement adaptive features and control strategies directly into the mathematical model using the latter approach. Especially the possibility to define custom control macros is a useful feature in the context of adaptive facades, as it enables simulation users to control the operation of various building systems, facade actuators included.

### 1.5.4 IES VE

Integrated Environment Solutions Virtual Environment is a consultancy oriented software, integrating different calculation modules in a comprehensive user interface. It integrates tools for thermal, airflow and daylight analysis, computational fluid dynamics (CFD), value engineering, cost planning, life-cycle and occupant safety analysis. This modularity allows to integrate building performance analysis in multiple domains (i.e. thermal, airflow and daylight). Although the daylight analysis can only be used in the thermal module to evaluate the effect of dimmable artificial lights, but not to control shading devices or smart glazing technologies. While the CFD module can only use the results from the thermal analysis as boundary conditions and not vice-versa. IES VE is a commercial program. Its code is not accessible and the user cannot add any additional simulation modules to enhance either application-oriented or general-purpose modelling capabilities. This limits the application of IES VE to application-oriented models already included in the software and to some alternative approaches described in Section 4.3 or approximate solutions such as for PCMs (Kendrick and Walliman 2007). Despite the limitations, a useful feature is found in the time-schedule module APpro. It enables simulation of rule-based control of a building system and of the adaptive building envelopes available (shading devices, cavity ventilation, electro-chromic glazing, etc.), even though it is limited by the availability of sensors. In fact only some of the software inputs and outputs can be used (cf. Table 6).

### 1.5.5 TRNSYS

The approach that TRNSYS takes towards managing complexity in the built environment is characterised by breaking down the problems into a series of smaller components. One of these components is a multi-zone building model — TYPE 56 — that can be connected to a large number of other components, including: weather data, HVAC systems, occupancy schedules, controllers, output functions, thermal energy storage, renewable (solar) energy systems, etc. This particular configuration allows the user to set up and manipulate the connections between the building and various other subsystems/components in the simulation environment.

TRNSYS TYPE 56 offers the possibility to change the thermal and optical window properties during run-time with a function called variable window ID. Additionally, it is also possible to control the ratio of window/frame area which influences the degree of transparent facade elements. In the near future, TRNSYS will be extended with a bi-directional scattering distribution function (BSDF) that can be changed at every time step of the simulation (Hiller and Schöttl 2014). All the other adaptive mechanisms in TRNSYS are not found in the (non-modifiable) building model itself, but in the connections with other components. Using equations in TRNSYS enables the application of Boolean logic and algebraic manipulations to almost all state variables in the simulation. This flow of information can then be used to drive a control algorithm that is able to dynamically 'switch on', 'switch off' or modulate e.g., overhangs and wingwalls (TYPE 34), shading masks (TYPE 64), attached sunspaces (with or without movable thermal insulation) (TYPE 37), windows with variable insulation properties (TYPE 35) and photovoltaic modules (TYPES 94, 180 and 194). In addition, it is also possible to adjust the connections with weather files and radiation processors. In this way, the effects of changing orientations (e.g. rotating buildings) can be mimicked.

The standard TRNSYS distribution already comes with an extensive library of components. Yet, one of the distinct benefits of TRNSYS' modular structure is the fact that it allows users to add content by introducing new components (McDowell et al. 2004). With some coding efforts it is possible to encapsulate the desired adaptive behavior in a new TRNSYS TYPE which can then be linked to the building model. Due to constraints in TRNSYS' CTF method, coupling of these new TYPES with the building envelope model works in a rather indirect way via the so-called 'slab-on-grade approach'. In TRNSYS it is not possible to substitute building shell constructions/properties during simulation run-time. Instead, developers can impose the desired behavior by overwriting the inside surface layer temperatures of adjacent zones and the respective heat transfer coefficients. With respect to adaptive facades, Kuznik et al. (2010) recently demonstrated this approach for a new PCM wallboard TYPE, and Djedjig et al. (2015) developed a model for green walls.

## 1.6 Conclusions, trends and future perspectives

This chapter has highlighted the potential of simulation-based analysis in various stages of design and development of buildings with adaptive building envelopes. The main requirements and challenges compared to performance prediction of conventional, static building envelopes were identified. On these bases, we have presented a comprehensive comparative overview of application-oriented, general-purpose and control capabilities for modeling and simulation of adaptive building envelopes in state-of-the-art whole building performance simulation software. It should be emphasised that simulation of adaptive facades tends to involve a high level of multi-domain interactions and corresponding reciprocal exchange with other energy systems in buildings. It is therefore important that users develop suitable simulation strategies, by carefully matching the

performance evaluation objectives with the capabilities and limitations of the different models and simulation tools at hand.

Relative to the well-established position of BPS in performance-based building design, the application of modeling and simulation for adaptive building envelope assessment is still at an early stage of development, with many more aspects of this field that have yet to be explored. This review has focused on the more advanced and comprehensive subset of available simulation tools, which are not always considered to be user-friendly, or suitable for early-phase design explorations. Various different GUIs have recently been developed, aiming at an easier integration of the simulation engines behind these BPS tools with the building design process. Due to interface limitations arising from the trade-off between ease-of-use and modeling complexity, the number of options for modeling adaptive facades in these user-friendly GUIs ranges from very limited to none. Extending such options is a clear target for future work. This section concludes the article by discussing four parallel trends and future perspectives that have the potential to further improve the impact of simulation-based design, research and engineering of adaptive building envelopes.

### **1.6.1 Advanced design support opportunities**

In both research and engineering practice, it is increasingly common to extend BPS studies with more advanced analysis techniques such as uncertainty propagation and sensitivity analysis methods (Clarke and Hensen 2015). Although the number of reports on the application of this type of analysis in combination with adaptive facades is still limited, there is potential for considerable progress also in this domain. Sensitivity analysis methods can be useful to identify the envelope design variables that have the largest influence on relevant building performance indicators (Tian 2013). Uncertainty analysis methods can additionally be used to make better-informed decisions by gaining in-depth understanding of the robustness of a particular adaptive facade design option with respect to possible scenarios regarding e.g. weather conditions and occupant behavior (Hopfe and Hensen 2011). Purposely-developed approaches such as dynamic sensitivity analysis can be helpful to deal with the time-varying features of adaptive facade problem configurations (Loonen and Hensen 2013).

Computational optimization is a second example of advanced design support that can assist in the performance assessment and design selection of adaptive building envelopes, as well as support the development and virtual prototyping of innovative adaptive facade technologies. The coupling of optimization algorithms with BPS tools allows for structured design space explorations that can help designers to find the most promising design solutions among the many possible alternatives (Evins 2013; Attia et al. 2013). Due to the close interaction between design and operational aspects of adaptive building envelopes, setting up the optimization formulation is a challenging task that requires novel approaches and further research (Favoino, Overend, and Jin 2015; Kasinalis et al. 2014).

### **1.6.2 Parametric and generative design tools**

The work presented in this article has mostly focused on the use of BPS as a tool for performance analysis. Recently, however, there is a growing interest in the use of these tools for performance-based generative design and architectural form finding (Shi and Yang 2013). These applications,

mostly driven by dedicated plug-ins that interface BPS programs with CAD tools such as Rhinoceros and Revit, can also have potential when applied to design of adaptive, especially kinetic facades. Existing work in this field has mostly addressed daylight aspects and innovative solar shading solutions (González and Fiorito 2015; Sharaidin, Burry, and Salim 2012). Future research could extend the scope to other performance aspects, and focus more on the design opportunities that the introduction of adaptive building envelopes brings along.

### 1.6.3 Co-simulation

Co-simulation is a simulation strategy in which two or more simulators solve systems of coupled equations, by exchanging data during simulation run-time (Trcka, Hensen, and Wetter 2009). This strategy could become particularly important for performance prediction of adaptive building envelope systems, as it promotes opportunities for (i) integrating the simulations over different interrelated physical domains using different coupled tools, (ii) evaluating emerging technologies for which models may not be directly available in the specific BPS tool used, and (iii) assessing the potential of advanced control strategies of adaptive building envelope systems in specialised control-oriented software. The co-simulation functionality can be enabled by means of middleware software, such as BCVTB (Wetter 2011b). An alternative development relates to the functional mock-up interface (FMI), which promises to make the coupling between building simulation tools even more flexible and versatile. (Nouidui, Wetter, and Zuo 2013)

### 1.6.4 Next-generation simulation tools

Whereas co-simulation tries to leverage and reuse the capabilities of existing simulation programs, there are also significant ongoing research efforts that aim at reconceiving BPS modeling approaches from the bottom up. At the center of these developments are the simulation libraries based on the Modelica modeling language (Wetter 2009). Within International Energy Agency (IEA) EBC Annex 60 New generation computational tools for building and community energy systems based on the Modelica and Functional Mockup Interface standards, these developments are coordinated at an international level. Modelica provides an equation-based, object-oriented approach that has potential to make modeling and simulation of complex building systems faster and more flexible. In the context of adaptive facades, it allows for high-resolution multi-domain analysis, rapid extension of modeling capabilities, as well as smooth interactions with other building-integrated energy systems. However, the development of Modelica for building performance simulation has not yet reached a mature phase. More research is needed to improve e.g. the robustness of component models, the interface with design tools, and simulation speed.

## References

- Attia, S., Hamdy, M., O'Brien, W., and S. Carlucci. 2013. "Assessing Gaps and Needs for Integrating Building Performance Optimization Tools in Net Zero Energy Buildings Design." *Energy & Buildings* 60: 110–24. doi:10.1016/j.enbuild.2013.01.016.
- Attia, S., Hensen, J.L.M., Beltrán, L., and A. De Herde. 2012. "Selection Criteria for Building Performance Simulation Tools: Contrasting Architects' and Engineers' Needs." *Journal of Building Performance Simulation* 5 (3): 155–69.



doi:10.1080/19401493.2010.549573.

- Ayres, JM, and E Stamper. 1995. "Historical Development of Building Energy Calculations." *ASHRAE Transactions* 101 (1): 841–49.
- Baetens, R, B.P. Jelle, and A Gustavsen. 2010. "Properties, Requirements and Possibilities of Smart Windows for Dynamic Daylight and Solar Energy Control in Buildings: A State-of-the-Art Review." *Solar Energy Materials and Solar Cells* 94 (2): 87–105.
- Bakker, L.G., E.C.M. Hoes-van Oeffelen, R.C.G.M. Loonen, and J.L.M. Hensen. 2014. "User Satisfaction and Interaction with Automated Dynamic Facades: A Pilot Study." *Building and Environment* 78 (August): 44–52. doi:10.1016/j.rser.2013.04.016.
- Bionda, D, U.P. Menti, and H Manz. 2014. "Kann Eine Gebäudehülle Mit Steuerbarem U-Wert Zur Reduktion Des Kühlenenergiebedarfs Beitragen?" In *Proceedings of BauSIM2014, the Fifth German-Austrian IBPSA Conference*, 649–55.
- Brahme, R., Z. O'Neill, W. Sisson, and K. Otto. 2009. "Using Existing Whole Building Energy Tools for Designing Net-Zero Energy Buildings – Challenges and Workarounds." In *Proceedings of Building Simulation 2009*, 9–16. Glasgow, Scotland.
- Burdajewicz, F, A Korjenic, and T Bednar. 2011. "Bewertung Und Optimierung von Dynamischen Dämmsystemen Unter Berücksichtigung Des Wiener Klimas." *Bauphysik* 33 (1): 49–58.
- Clarke, J.A. 2001. *Energy Simulation in Building Design*. Oxford: Butterworth-Heinemann.
- Clarke, J.A., and J.L.M. Hensen. 2015. "Integrated Building Performance Simulation: Progress, Prospects and Requirements." *Building and Environment*, 1–13. doi:10.1016/j.buildenv.2015.04.002.
- Crawley, D, J Hand, M Kummert, and B Griffith. 2008. "Contrasting the Capabilities of Building Energy Performance Simulation Programs." *Building and Environment* 43 (4): 661–73. doi:10.1016/j.buildenv.2006.10.027.
- DeForest, N., A. Shehabi, G. Garcia, J. Greenblatt, E. Masanet, E.S. Lee, S. Selkowitz, and D.J. Milliron. 2013. "Regional Performance Targets for Transparent near-Infrared Switching Electrochromic Window Glazings." *Building and Environment* 61 (March): 160–68. doi:10.1016/j.buildenv.2012.12.004.
- Delcroix, B, M Kummert, A Daoud, and M Hiller. 2012. "Conduction Transfer Functions in TRNSYS Multizone Building Model: Current Implementation, Limitations and Possible Improvements." In *Proceedings of SimBuild 20102, the Fifth National Conference of IBPSA-USA*, 219–26. Madison, WI.
- Djedjig, R., Bozonnet, E. and R. Belarbi. 2015. "Analysis of Thermal Effects of Vegetated Envelopes: Integration of a Validated Model in a Building Energy Simulation Program." *Energy and Buildings* 86: 93–103. doi:10.1016/j.enbuild.2014.09.057.
- Ellis, P. G., Torcellini, P.A. and D. B. Crawley. 2007. "Simulation of Energy Management Systems in EnergyPlus." In *Proceedings of Building Simulation 2007*, 1346–53.
- Erickson, J. 2013. "Envelope as Climate Negotiator: Evaluating Adaptive Building Envelope's Capacity to Moderate Indoor Climate and Energy." PhD Thesis, Arizona State University.
- Evans, M., and N. J. Kelly. 1996. *Modelling Active Building Elements with Special Materials*. ESRU Occasional Paper, University of Strathclyde, Glasgow.
- Evins, R. 2013. "A Review of Computational Optimisation Methods Applied to Sustainable Building Design." *Renewable and Sustainable Energy Reviews* 22 (June): 230–45. doi:10.1016/j.rser.2013.02.004.
- Favoino, F. 2015. "Assessing the Performance of an Advanced Integrated Facade by Means of Simulation: The ACTRESS Facade Case Study." *Journal of Facade Design and Engineering*, vol. Preprint, no. Preprint, pp. 1-23, 2015. DOI: 10.3233/FDE-150038
- Favoino, F., Cascone, Y., Bianco, L., Goia, F., Zinzi, M., Overend, M., Serra, V. and M. Perino. 2015. "Simulating Switchable Glazing with EnergyPlus: An Empirical Validation and Calibration of a Thermotropic Glazing Model." In *Proceedings of Building Simulation 2015*. Hyderabad, India.
- Favoino, F., Goia, F., Perino, M. and V. Serra. 2014. "Experimental Assessment of the Energy Performance of an Advanced Responsive Multifunctional Façade Module." *Energy and Buildings* 68 (January): 647–59. doi:10.1016/j.enbuild.2013.08.066.
- Favoino, F., Jin, Q., and M. Overend. 2014. "Towards an Ideal Adaptive Glazed Façade for Office Buildings." In *Proceedings of 6th International Conference on Sustainability in Energy and Buildings, 2014*, Energy Procedia,

Volume 62, 2014, Pages. Cardiff, Wales.

- Favoino, F., and M. Overend. 2015. "A Simulation Framework for the Evaluation of next Generation Responsive Building Envelope Technologies." In Proceedings of 6th International Building Physics Conference, IBPC 2015., Torino, Italy.
- Favoino, F., Overend, M., and Q. Jin. 2015. "The Optimal Thermo-Optical Properties and Energy Saving Potential of Adaptive Glazing Technologies." *Applied Energy* 156 (October 2015.): 1–15.
- Freire, R. Z., Mazuroski, W., Abadie, M.O., and N. Mendes. 2011. "Capacitive Effect on the Heat Transfer through Building Glazing Systems." *Applied Energy* 88 (12): 4310–19. doi:10.1016/j.apenergy.2011.04.006.
- Goia, F., and Y. Cascone. 2014. "The Impact of an Ideal Dynamic Building Envelope on the Energy Performance of Low Energy Office Buildings." *Energy Procedia* 58 (1876): 185–92. doi:10.1016/j.egypro.2014.10.427.
- Goia, F., Perino, M. and M. Haase. 2012. "A Numerical Model to Evaluate the Thermal Behaviour of PCM Glazing System Configurations." *Energy and Buildings* 54: 141–53. doi:10.1016/j.enbuild.2012.07.036.
- González, J., and F. Fiorito. 2015. "Daylight Design of Office Buildings: Optimisation of External Solar Shadings by Using Combined Simulation Methods." *Buildings* 5 (2): 560–80. doi:10.3390/buildings5020560.
- Haldi, F., and D. Robinson. 2010. "On the Unification of Thermal Perception and Adaptive Actions." *Building and Environment* 45 (11): 2440–57. doi:10.1016/j.buildenv.2010.05.010.
- Hashemi, A., and S. Gage. 2012. "Technical Issues That Affect the Use of Retrofit Panel Thermal Shutters in Commercial Buildings." *Building Services Engineering Research and Technology* 35 (1): 6–22. doi:10.1177/0143624412462906.
- Heim, D., and J Clarke. 2004. "Numerical Modelling and Thermal Simulation of PCM–gypsum Composites with ESP-R." *Energy and Buildings* 36 (8): 795–805. doi:10.1016/j.enbuild.2004.01.004.
- Hensen, J.L.M., M Bartak, and F Drkal. 2002. "Modeling and Simulation of a Double-Skin Facade System." *ASHRAE Transactions* 108 (2): 1251–59.
- Hensen, J.L.M., Djunaedy, E., Trcka, M & Yahiaoui, A. (2004). Building performance simulation for better design: some issues and solutions. In Wit, M.H. de (Ed.), Proceedings of the 21st PLEA International conference on Passive and low energy architecture, 19-21 September, pp. 1185-1190(vol.2). Eindhoven: Technische Universiteit Eindhoven.
- Hiller, M., and P. Schöttl. 2014. "Modellierung Komplexer Verglasungssysteme in Trnsys." In Proceedings of BauSIM2014, the Fifth German-Austrian IBPSA Conference, 387–94.
- Hoes, P, J.L.M. Hensen, M.G.L.C. Loomans, B De Vries, and D Bourgeois. 2009. "User Behavior in Whole Building Simulation." *Energy and Buildings* 41 (3): 295–302. doi:10.1016/j.enbuild.2008.09.008.
- Hoes, P., M. Trcka, J.L.M. Hensen, and B. Hoekstra Bonnema. 2011. "Investigating the Potential of a Novel Low-Energy House Concept with Hybrid Adaptable Thermal Storage." *Energy Conversion and Management* 52 (6): 2442–47.
- Hong, T., D'Oca, S., Turner, W.J.N., and S. C. Taylor-Lange. 2015. "An Ontology to Represent Energy-Related Occupant Behavior in Buildings. Part I: Introduction to the DNAs Framework." *Building and Environment* 92: 764–77. doi:10.1016/j.buildenv.2015.02.019.
- Hopfe, C. J., and J. L M Hensen. 2011. "Uncertainty Analysis in Building Performance Simulation for Design Support." *Energy and Buildings* 43 (10): 2798–2805. doi:10.1016/j.enbuild.2011.06.034.
- IEA. 2013. Technology Roadmap - Energy Efficient Building Envelopes. International Energy Agency.
- Jin, Q., Favoino, F., and M. Overend. 2015. "Study in the Potential of Opaque Adaptive Façade for Office Building in a Temperate Climate." In Proceedings of Building Simulation 2015. Hyderabad, India.
- Joe, J., Choi, W., Kwon, H. and JH Huh. 2013. "Load Characteristics and Operation Strategies of Building Integrated with Multi-Story Double Skin Facade." *Energy and Buildings* 60 (May): 185–98. doi:10.1016/j.enbuild.2013.01.015.
- Kasinalis, C., R.C.G.M. Loonen, D. Cóstola, and J.L.M. Hensen. 2014. "Framework for Assessing the Performance Potential of Seasonally Adaptable Facades Using Multi-Objective Optimization." *Energy and Buildings* 79 (August): 106–13. doi:10.1016/j.enbuild.2014.04.045.
- Kendrick, C., and N. Walliman. 2007. "Removing Unwanted Heat in Lightweight Buildings Using Phase Change Materials in Building Components: Simulation Modelling for PCM Plasterboard." *Architectural Science Review* 50 (3): 265–73. doi:10.3763/asre.2007.5032.

- Kim, D. W., and C. S. Park. 2011. "Difficulties and Limitations in Performance Simulation of a Double Skin Façade with EnergyPlus." *Energy and Buildings* 43 (12): 3635–45. doi:10.1016/j.enbuild.2011.09.038.
- Kimber, M., W.W. Clark, and L. Schaefer. 2014. "Conceptual Analysis and Design of a Partitioned Multifunctional Smart Insulation." *Applied Energy* 114 (February): 310–19.
- Kuhn, T. E., Herkel, S., Frontini, F., Strachan, P., and G. Kokogiannakis. 2011. "Solar Control: A General Method for Modelling of Solar Gains through Complex Facades in Building Simulation Programs." *Energy and Buildings* 43 (1): 19–27. doi:10.1016/j.enbuild.2010.07.015.
- Kuznik, F., David, D., Johannes, K. and J. J. Roux. 2011. "A Review on Phase Change Materials Integrated in Building Walls." *Renewable and Sustainable Energy Reviews* 15 (1): 379–91. doi:10.1016/j.rser.2010.08.019.
- Kuznik, F., Virgone, J., and K. Johannes. 2010. "Development and Validation of a New TRNSYS Type for the Simulation of External Building Walls Containing PCM." *Energy and Buildings* 42 (7): 1004–9. doi:10.1016/j.enbuild.2010.01.012.
- Liu, M., Wittchen, K.B., and P. K. Heiselberg. 2014. "Development of a Simplified Method for Intelligent Glazed Façade Design under Different Control Strategies and Verified by Building Simulation Tool BSim." *Building and Environment* 74 (April): 31–38. doi:10.1016/j.buildenv.2014.01.003.
- Llordés, A., Garcia, G., Gazquez, J., and D. J. Milliron. 2013. "Tunable near-Infrared and Visible-Light Transmittance in Nanocrystal-in-Glass Composites." *Nature* 500: 323–27. doi:10.1038/nature12398.
- Lomanowski, B.A., and J.L. Wright. 2012. "The Complex Fenestration Construction: A Practical Approach for Modelling Windows with Shading Devices in ESP-R." *Journal of Building Performance Simulation* 5 (January): 185–98. doi:10.1080/19401493.2011.552735.
- Roel C.G.M. Loonen, Fabio Favoino, Jan L.M. Hensen & Mauro Overend, 2017. "Review of current status, requirements and opportunities for building performance simulation of adaptive facades, *Journal of Building Performance Simulation*, 10:2, 205-223, DOI: 10.1080/19401493.2016.1152303
- Loonen, R.C.G.M., and J.L.M. Hensen. 2013. "Dynamic Sensitivity Analysis for Performance-Based Building Design and Operation." In *Proceedings of Building Simulation 2013*.
- Loonen, R.C.G.M., P. Hoes, and J.L.M. Hensen. 2014. "Performance Prediction of Buildings with Responsive Building Envelopes - Some Challenges and Solutions." In *Proceedings of Building Simulation and Optimization, IBPSA BSO14*, 1–8. London, UK.
- Loonen, R.C.G.M., S. Singaravel, M. Trčka, D. Cóstola, and J.L.M. Hensen. 2014. "Simulation-Based Support for Product Development of Innovative Building Envelope Components." *Automation in Construction* 45 (September): 86–95.
- Loonen, R.C.G.M., M. Trčka, D. Cóstola, and J.L.M. Hensen. 2013. "Climate Adaptive Building Shells: State-of-the-Art and Future Challenges." *Renewable and Sustainable Energy Reviews* 25 (September): 483–93.
- Loonen, R.C.G.M., M. Trčka, and J.L.M. Hensen. 2011. "Exploring the Potential of Climate Adaptive Building Shells." In *Proceedings of Building Simulation 2011*, 2148–55. Sydney, Australia.
- Luiblé, A. 2015. "COST Action 1403." In *Proceedings of Energy Forum 2015*. Bern, Switzerland.
- MacQueen, J. 1997. "The Modeling and Simulation of Energy Management Control Systems." PhD Thesis, University of Strathclyde, Glasgow.
- Mateus, N. M., Pinto, A. and G. Carrilho Da Graça. 2014. "Validation of EnergyPlus Thermal Simulation of a Double Skin Naturally and Mechanically Ventilated Test Cell." *Energy and Buildings* 75: 511–22. doi:10.1016/j.enbuild.2014.02.043.
- McDowell, T.P., D.E. Bradley, J.W. Thornton, and M. Kummert. 2004. "Simulation Synergy: Expanding TRNSYS Capabilities and Usability." In *Proceedings of SIMBUILD 2004, IBPSA-USA Conference on Building Sustainability and Performance Through Simulation*, 1–6.
- Moloney, J. 2011. *Designing Kinetics for Architectural Facades: State Change*. Routledge.
- Nakhi, A.E. 1995. "Adaptive Construction Modelling within Whole Building Dynamic Simulation." PhD Thesis, University of Strathclyde, Glasgow.
- Nielsen, M. V., Svendsen, S., and L. Bjerregaard Jensen. 2011. "Quantifying the Potential of Automated Dynamic Solar Shading in Office Buildings through Integrated Simulations of Energy and Daylight." *Solar Energy* 85 (5): 757–68. doi:10.1016/j.solener.2011.01.010.

- Nouidui, T., Wetter, M., and W. Zuo. 2013. "Functional Mock-up Unit for Co-Simulation Import in EnergyPlus." *Journal of Building Performance Simulation* 7 (February): 192–202. doi:10.1080/19401493.2013.808265.
- Oh, Sukjoon, and Jeff S. Haberl. 2015. "Origins of Analysis Methods Used to Design High-Performance Commercial Buildings: Whole-Building Energy Simulation." *Science and Technology for the Built Environment* 4731 (October): 1–20. doi:10.1080/23744731.2015.1063958.
- Pedersen, C O. 2007. "Advanced Zone Simulation in EnergyPlus: Incorporation of Variable Properties and Phase Change Material (PCM) Capability." In *Proceedings of Building Simulation 2007*, 1341–45. Beijing, China.
- Perino, M., ed. 2008. IEA ECBCS Annex 44. State of the Art Review. Volume 2A Responsive Building Elements.
- Perino, M., and Serra, V. 2015. "Switching from static to adaptable and dynamic building envelopes: A paradigm shift for the energy efficiency in buildings." *Journal of Facade Design and Engineering*, vol. Preprint, no. Preprint, pp. 1-21.
- Plüss, I., P. Kräuchi, D. Bionda, M. Schröcker, S. Felsenstein, and G. Zweifel. 2014. "Modellbildung Eines Phasenwechsel-Fassadenelements in IDA ICE." In *Proceedings of BauSIM2014, the Fifth German-Austrian IBPSA Conference*, 374–78.
- Reynders, G., T. Nuytten, and D. Saelens. 2013. "Potential of Structural Thermal Mass for Demand-Side Management in Dwellings." *Building and Environment* 64 (June): 187–99. doi:10.1016/j.buildenv.2013.03.010.
- Ritter, V. 2014. "Challenges in the Development of the Adaptive Solar Thermal Facade System Fluidglass." In *Proceedings of Façade2014 – Conference on Building Envelopes*. Luzern, Switzerland.
- Rossi, D., Nagy, Z., and A. Schlueter. 2012. "Adaptive Distributed Robotics for Environmental Performance, Occupant Comfort and Architectural Expression." *International Journal of Architectural Computing* 10 (2): 341–60.
- Sahlin, P. 2004. "Whole-Building Simulation with Symbolic DAE Equations and General Purpose Solvers." *Building and Environment* 39 (8): 949–58. doi:10.1016/j.buildenv.2004.01.019.
- Sailor, D.J. 2008. "A Green Roof Model for Building Energy Simulation Programs." *Energy and Buildings* 40 (8): 1466–78. doi:10.1016/j.enbuild.2008.02.001.
- Sailor, D.J., and B. Bass. 2014. "Development and Features of the Green Roof Energy Calculator (GREC)." *Journal of Living Architecture* 1 (3): 36–58.
- Sharaidin, K., Burry, J. and F. Salim. 2012. "Integration of Digital Simulation Tools With Parametric Designs to Evaluate Kinetic Façades for Daylight Performance." In *Physical Digitality: Proceedings of the 30th eCAADe Conference*, 2:701–9.
- Shi, X., and W. Yang. 2013. "Performance-Driven Architectural Design and Optimization Technique from a Perspective of Architects." *Automation in Construction* 32: 125–35. doi:10.1016/j.autcon.2013.01.015.
- Spitler, J.D. 2011. "Thermal Load and Energy Performance Prediction." In *Building Performance Simulation for Design and Operation*, edited by J.L.M. Hensen and R. Lamberts, 84–142. Spon Press.
- Tabares-Velasco, P.C., Christensen, C., and M. Bianchi. 2012. "Verification and Validation of EnergyPlus Phase Change Material Model for Opaque Wall Assemblies." *Building and Environment* 54 (August): 186–96.
- Tabares-Velasco, P. C., and B. Griffith. 2012. "Diagnostic Test Cases for Verifying Surface Heat Transfer Algorithms and Boundary Conditions in Building Energy Simulation Programs." *Journal of Building Performance Simulation* 5 (5): 329–46. doi:10.1080/19401493.2011.595501.
- Tian, W. 2013. "A Review of Sensitivity Analysis Methods in Building Energy Analysis." *Renewable and Sustainable Energy Reviews* 20 (April): 411–19.
- Trcka, M., J.L.M. Hensen, and M. Wetter. 2009. "Co-Simulation of Innovative Integrated HVAC Systems in Buildings." *Journal of Building Performance Simulation* 2 (3): 209–30. doi:10.1080/19401490903051959.
- US DOE. 2015a. "Application Guide for EMS Energy Management System - User Guide." [http://nrel.github.io/EnergyPlus/EMS\\_Application\\_Guide/EMS\\_Application\\_Guide/](http://nrel.github.io/EnergyPlus/EMS_Application_Guide/EMS_Application_Guide/).
- US DOE. 2015b. "Building Energy Software Tools Directory." [http://apps1.eere.energy.gov/buildings/tools\\_directory/](http://apps1.eere.energy.gov/buildings/tools_directory/).
- Wetter, M. 2009. "Modelica-Based Modelling and Simulation to Support Research and Development in Building Energy and Control Systems." *Journal of Building Performance Simulation* 2 (2): 143–61. doi:10.1080/19401490902818259.
- Wetter, M. 2011a. "A View on Future Building System Modeling and Simulation." In *Building Performance Simulation for Design and Operation*, edited by J.L.M. Hensen and R. Lamberts.



- Wetter, M. 2011b. "Co-Simulation of Building Energy and Control Systems with the Building Controls Virtual Test Bed." *Journal of Building Performance Simulation* 4 (3): 185–203. doi:10.1080/19401493.2010.518631.
- Zanghirella, F., Perino, M., and V. Serra. 2011. "A Numerical Model to Evaluate the Thermal Behaviour of Active Transparent Faades." *Energy and Buildings* 43 (5): 1123–38. doi:10.1016/j.enbuild.2010.08.031.

The work presented in this Chapter was entirely published in the open access (CC-NY) paper "Current status, requirements and opportunities for building performance simulation of adaptive facades", published by the same authors in the *Journal of Building Performance Simulation* (most read paper of the journal, as accessed in November 2018). For consistency the word "paper" is substituted by the word "chapter", and the Appendix A is integrated as Section 1.5. To cite the present chapter of this book, please refer to the following citations:

*"Roel C.G.M. Loonen, Fabio Favoino, Jan L.M. Hensen & Mauro Overend (2017) Review of current status, requirements and opportunities for building performance simulation of adaptive facades, Journal of Building Performance Simulation, 10:2, 205-223, DOI: 10.1080/19401493.2016.1152303"*

*1 The database of building energy analysis software maintained by the U.S. Department of Energy currently consists of 453 different tools (US DOE 2015b)*

*2 Options for modeling adaptive facades are significantly limited when the simulation engine is accessed through one of the third-party GUIs*

*3 By default, EnergyPlus uses the CTF method, but it was recently extended with a new finite difference scheme for conduction, to allow for modelling temperature- or time-dependent material properties (Pedersen 2007; Tabares-Velasco and Griffith 2012). The usage of this new approach has been large unexplored in literature.*

*4 Daylight performance predictions with ESP-r are possible but require setting up a co-simulation with the Radiance solver. It is therefore not included in this overview.*

*5 Additional modelling is needed in IES VE in order to perform a simulation, but some preliminary early-stage analysis could be performed via the plug-ins directly.*

*6 Excluding dynamic building model Type 56*



German Historical Museum / I.M. Pei (image: M. Brzezicki)

# 2 Model requirements, approaches and validation for simulation of adaptive façade systems and technologies

Fabio Favoino, Politecnico di Torino; Roel C.G.M. Loonen, TU Eindhoven

## 2.1 Introduction

A large number of adaptive technologies are present in scientific literature and in the market, with each having its own characteristic features as related to their working principle. As time goes by, novel materials and components that can give building envelopes the ability to respond to interior and exterior boundary conditions are continuously being proposed. Hence, a large number of simulation models and approaches are available, either as: i) application oriented modelling option in building performance simulation tools; ii) surrogate models / approaches able to replicate the main working principle of a specific adaptive façade technology; iii) general purpose modelling approaches; iv) ad-hoc developed models which can be integrated into a building performance simulation tool.

The Task 2.4 “New simulation tools for the evaluation of the performance of novel and existing adaptive façade concepts” is reported in the present section by documenting the different models which were developed for each specific adaptive technology, with a particular focus on model types i), ii) and iii) as mentioned above.

The report is presented in the form of separate chapters related to a specific adaptive technology, authored by one or more BPS experts with extensive experience in the modelling of the described adaptive system. Section 2 of this Chapter presents the methodology that was followed, and section 3 gives an overview of the adaptive façade technologies that were considered in this Task.

## 2.2 Methodology

A common methodology was followed to collect and process information about the various modelling and simulation approaches for adaptive facades. The process started by establishing clusters of the most relevant and representative adaptive facade systems and technologies. Subsequently, working group members with extensive experience in the use and development of models for that specific façade technology were identified and invited to prepare their contribution. A common template (Table 1) was developed to harmonize the way of presenting the results. The template was designed to elucidate first-hand experiences in the use of different models. In particular, it aims at communicating aspects that cannot easily be found in scientific papers and software documentation, and apart from presenting benefits, is scrupulous to also highlight drawbacks and unresolved issues. A special section in the template is reserved for a discussion about validation and quality assurance issues.

After collecting the written contributions from the various working group members, an intra-group

peer review activity was set up, aspiring to complement the reports with additional interesting information, and to homogenize the individual contributions as much as possible.

Table 1 - Template for chapters 3 to 13 describing methods for computational performance prediction of different adaptive facade technologies.

<p><b>1. &lt;Insert adaptive facade technology&gt; for high-performance buildings</b> Short description of the technology. Potential benefits of the system/material, and describe typical performance indicators at component and/or building level.</p>
<p><b>2. Simulation requirements</b> Important aspects of the technology that need to be taken into account in the models, including things like control strategies, time steps, physical domains, etc.</p>
<p><b>3. Implementations in building performance simulation software</b> Description of how the material / façade system can be modelled in existing simulation programs, or which simulation approach was developed in-house. Reference is given to application oriented approaches, and general purpose ones and even ad-hoc develop models which are or can be integrated in whole building energy simulation tools.</p>
<p><b>4. Validation</b> Information and references regarding the validation of the different models described in the previous section. Special attention is given to the validation of the adaptive/dynamic features.</p>
<p><b>5. Points of attention and future outlook</b> Future outlook addressing the following points. Has everything already been solved? How about the trade-offs between model complexity, accuracy, and ease-of-use? Try to include some information here that is interesting from a user point-of-view, but that is not typically found in scientific publications or software manuals. What are interesting ongoing developments and directions for future research?</p>
<p><b>6. References</b> List of cited reference publications</p>

## 2.3 Adaptive façade technologies

Twelve different contributions were developed, the majority covering different combinations of the five subdomains, solar radiation, airflow, thermal storage, evapotranspiration and heat transfer (Figure 1). Each of these contributions is presented as a chapter in this booklet. The last chapter (Chapter 14) presents a slightly different structure, as it is not related to a specific façade technology, but describes a methodology to analyse long-term facade performance.



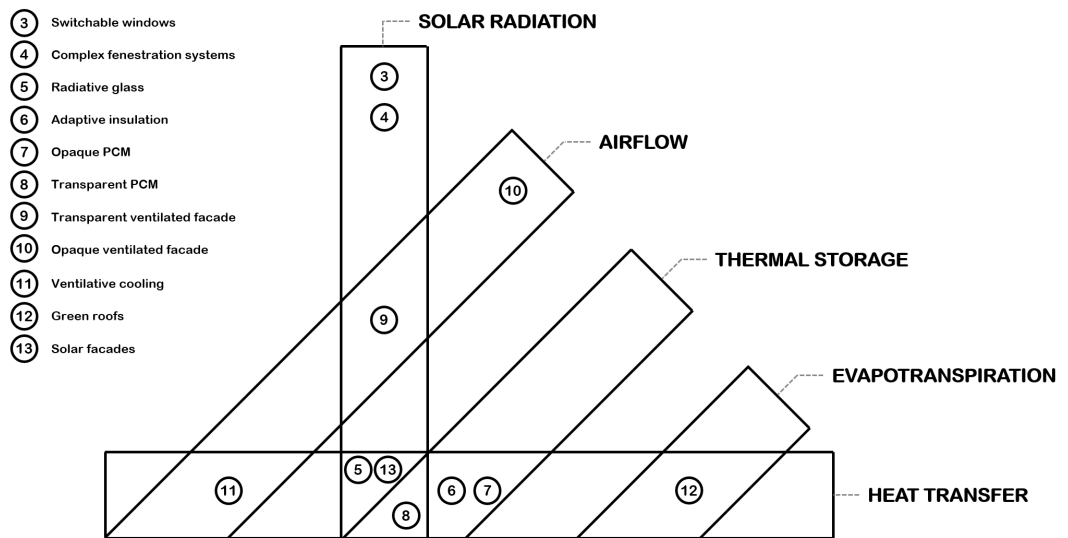

Figure 1 - Schematic representation of adaptive façade technologies in the next chapters and related heat and mass transfer phenomena (and their combination).



Nordic Embassy Complex / Berger + Parkkinen (image: M. Brzezicki)

# 3 Computational performance prediction of switchable windows

Roel C.G.M. Loonen, TU Eindhoven; Fabio Favoino, University of Cambridge

## 3.1 Switchable windows for high-performance buildings

Switchable windows have the ability to modulate the admission of daylight and solar gains to interior spaces. By controlling the solar transmission and reflection/absorption of a fenestration systems, these switchable windows aim at improving indoor environmental conditions in terms of visual (e.g. daylight utilization, glare discomfort, view to outside) and thermal (e.g. overheating in summer) comfort aspects.

Different materials and systems are used as functional layers to modulate thermo-optical properties in switchable windows, including, chromogenic materials (e.g. thin-film metal compounds), liquid crystals and suspended particles. The main differences between various types of switchable windows can be summarized with the following features:

**Control mechanism:** referring to the terminology in (Loonen, Trčka, Cóstola, & Hensen, 2013), extrinsic, using an external signal (i.e. electrochromic and liquid crystal devices), or intrinsic, when the adaptive behavior is an essential feature of the material, e.g. as a function of temperature (i.e. thermochromic, thermotropic) or incident light (i.e. photoelectrochromic, photovoltachromic).

**Wavelength range:** Switchable windows can modulate thermo-optical properties in the whole solar spectrum, or only in the visible part, non-visible part or independently in both parts of the solar spectrum (Loonen & Hensen, 2015).

**Optical properties:** To modulate transparency of the glazing, the remaining solar radiation can either be reflected to outside or absorbed. Depending on the variation of the refractive index of the materials embedded in the functional layer a switchable glazing could have a diffusive behavior when activated (as the thermotropic devices) instead of maintaining the specular state, contributing to reduce glare risk from direct solar radiation and to distribute light more uniformly in the indoor space.

Different types of switchable windows are commercially available on the market (Fig. 1, Fig. 2). For example, Baetens et al. (2010), Jelle et al. (2012), and Favoino et al. (2015) provide extensive overviews of the state-of-the-art in this field.

## 3.2 Simulation requirements

Switchable windows have an impact on visual and thermal performance aspects. The interactions between both these physical domains need to be taken into account to predict the performance of switchable glazing in an appropriate way. Accurate modelling of specular or diffusive behavior is in some cases required to evaluate how the light is distributed in the indoor environment and how

the visual comfort may be affected. In addition, the impact on artificial lighting and HVAC systems needs to be considered.

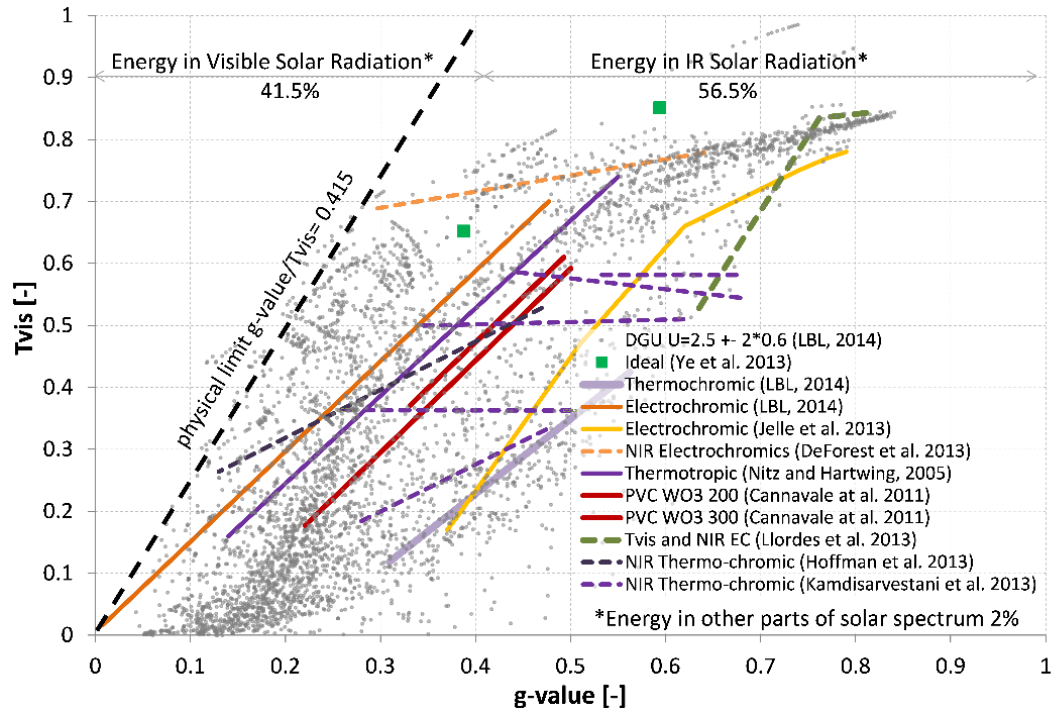

Figure 1 - Comparison of switchable glazing integral solar properties compared with conventional double glazing units (grey data points) (Favoino, 2016).

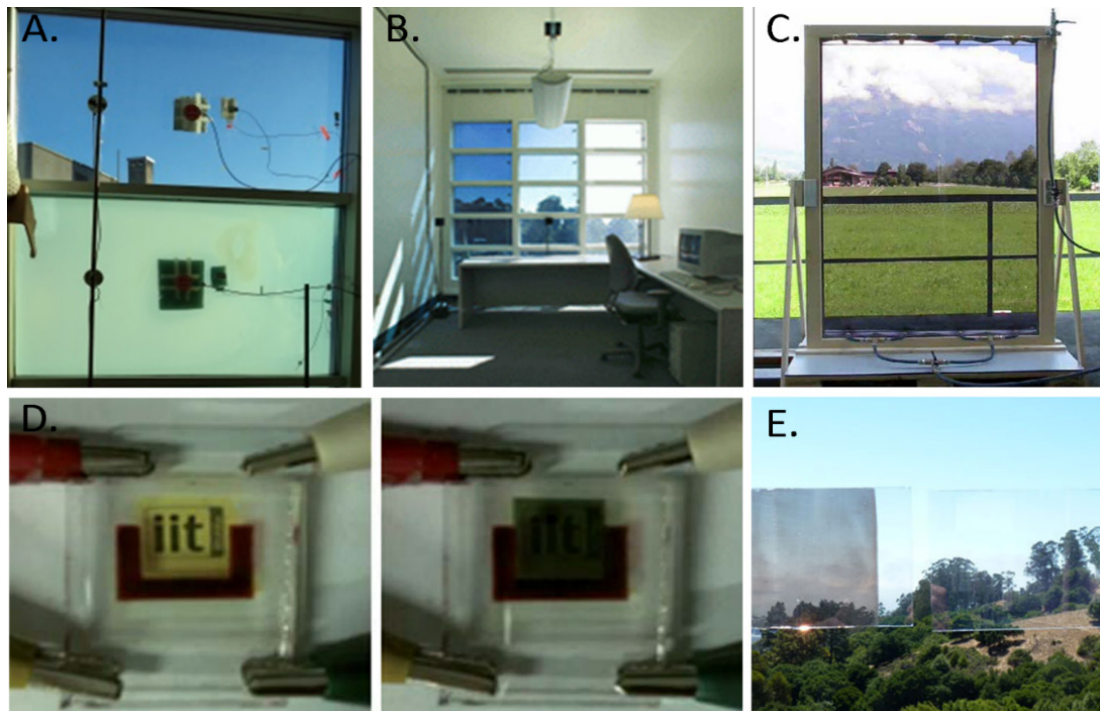

Figure 2 - View of different smart glazing technologies: A) thermo-tropic, B) electro-chromic, C) Fluidglass, D) Photo-Volta-Chromic, E) Tunable Visible-Infrared Reflector (Favoino, 2016).

It is important that the switching of window properties happens during simulation run-time, because the changing amount of solar radiation that enters the zones leads to a different transient thermal response of the space.

### 3.3 Implementations in building performance simulation software

As a result of their presence in the market, options for application oriented modelling of switchable glazing technologies are embedded in many of the widely-used simulation tools (Loonen, Favoino, Hensen, & Overend, 2016). Such implementations offer the possibility to control the properties of the building model's fenestration systems during simulation run-time. The differences between the various implementations are the number of possible window states (e.g. on/off versus gradual transitions) and the simulation state variables that can be used for the control of adaptation (e.g. room temperature, ambient temperature and incident radiation).

Thermotropic/chromic windows are slightly more complicated to simulate than other switchable window types because of their intrinsic control character; adaptation of the fenestration properties is directly triggered by window material temperature instead of a control signal that is based on more general simulation variables. A provision for thermochromic window simulation is implemented in EnergyPlus since v3.1, 2009) and ESP-r. The input of these models consists of sets of glazing thermo-optical properties at various temperatures. During the simulation, the thermochromic layer temperature of the previous time step is automatically fed into a window control algorithm, which then selects the window properties that best match with the given temperature. In IDA ICE and Trnsys, it is also possible to model thermotropic/chromic windows, but a significantly higher level of work and expertise is required from the user side because a script for the control strategy needs to be manually developed by the simulation user.

Thermotropic / chromic windows present an additional complication, which is represented by an hysteresis in optical properties between the heating and cooling cycles (Warwick & Binions 2014). Warwick et al. (2016) used EnergyPlus switchable glazing model, in order to assess the effect of the hysteresis on energy use of office buildings, although with a surrogate model correlating glazing temperature to solar radiation intensity. The latter was finally used to control the optical properties of the glazing in an hysterical way. The approach adopted by Warwick et al. (2016) was not validated. More recently Giovannini et al. (2018) developed a methodology within EnergyPlus, by adopting the EMS system (US DOE, 2015), which is able to accurately simulate the hysteresis within a thermochromic glazing component. This was integrated in a more comprehensive simulation strategy, which couples EnergyPlus with Radiance software in order also to account the effect of the thermochromic glazing and its hysteresis on daylight aspects (illuminance distribution in the indoor space and glare).

Input data for switchable windows is available at glazing manufacturers such as View Inc and SAGE, and via the International Glazing Database (IGDB) that is linked to the LBNL Window software.

### 3.4 Validation

Despite the large number of published simulation case studies that use/investigate switchable



windows, there been relatively little attention for validation studies at the whole building level.

- Assimakopoulos et al. (2004) observed a “quite good” agreement between measured and predicted zone air temperature in a space with electrochromic windows. However, their validation study was not very extensive, and did not address the switching behavior of the window.

Favoino et al. (2015) investigated the accuracy of the application oriented models of a thermotropic window in EnergyPlus, and compared it to a general oriented model with the same tool. The study shows a good qualitative and quantitative agreement of both models with experimental data from a monitoring campaign in real climate conditions. Moreover the switching behavior is analyzed in more details, showing a small time difference between the switching process in the two models, which may results in differences in the energy use and visual comfort evaluation. This is due to the fact that only the glazing surface temperatures can be used by the general purpose modelling approach to model the intrinsic adaptive behavior, instead of the material temperature. It is concluded that the application oriented model is more accurate than the general oriented one (with EnergyPlus) in cases when the smart material is not included in the external or internal glass layer of a window system (i.e. middle layer of a triple glazing unit), unless this is not accounted for in the modelling task. The accurate prediction of window-related heat transfer and solar energy gains in building performance simulation is a topic that has been widely researched using both analytical and empirical methods (Lomas, Eppel, Martin, & Bloomfield, 1997; Manz et al., 2006). Although such studies were carried out for static windows, it is assumed that these quality assurance procedures are also valid for switchable windows, provided that proper input data for glazing properties are given.

### 3.5 Points of attention and future outlook

Although switchable windows are one of the most mature adaptive façade technologies when it comes to integration in building performance simulation tools, there are still some issues that require further research:

- It is currently not always possible to model the effects of windows that can independently control switching in various parts of the solar spectrum.
- Many switchable window coatings have special angular-dependent optical properties that are different from regular, specular glazing systems. It is not always straightforward to introduce such effects in building performance simulation tools.
- Some switchable window technologies, especially electrochromic materials have a delay of 10 to 20 minutes between actuation and actual coloration of the window. This effect may have significant impact on window performance, particularly for visual comfort and glare; it is nevertheless not possible to take this effect into account in most simulation tools.
- It is not always straightforward and sometimes not possible to perfectly integrate the control of switchable glazing with the control of HVAC and artificial lighting systems.

### References

Assimakopoulos, M. N., Tsangrassoulis, A., Guarracino, G., & Santamouris, M. (2004). Integrated energetic approach for a controllable electrochromic device. *Energy and Buildings*, 36(5), 415–422. doi:10.1016/j.enbuild.2004.01.040

- Baetens, R., Jelle, B. P., & Gustavsen, A. (2010). Properties, requirements and possibilities of smart windows for dynamic daylight and solar energy control in buildings: A state-of-the-art review. *Solar Energy Materials and Solar Cells*, 94(2), 87–105.
- Favoino F. (2016). Simulation-based Evaluation of Adaptive Materials for Improved Building Performance, in: Nano and Biotech Based Materials for Energy Building Efficiency Editors: Pacheco Torgal, F., Buratti, C., Kalaiselvam, S., Granqvist, C.G., Ivanov, V.(Eds.) , DOI: 10.1007/978-3-319-27505-5, ISBN: 978-3-319-27503-1
- Favoino, F., Cascone, Y., Bianco, L., Goia, F., Zinzi, M., Overend, M., ... Perino, M. (2015). Simulating switchable glazing with EnergyPlus: an empirical validation and calibration of a thermotropic glazing model. In *Proceedings of Building Simulation 2015*. Hyderabad, India.
- Favoino, F., Overend, M., & Jin, Q. (2015). The optimal thermo-optical properties and energy saving potential of adaptive glazing technologies. *Applied Energy*, 156(October 2015.), 1–15.
- Giovannini L., Serra V., Lo Verso V., Pellegrino A., Zinzi M., Favoino F., (2018) A novel methodology to optimize visual comfort and energy performance for transparent adaptive façades, Proceedings of 18th IEEE International Conference on Environment and Electrical Engineering ICEEE, 12-16th June, Palermo, Italy.
- Jelle, B. P., Hynd, A., Gustavsen, A., Arasteh, D., Goudey, H., & Hart, R. (2012). Fenestration of today and tomorrow: A state-of-the-art review and future research opportunities. *Solar Energy Materials and Solar Cells*, 96(7465), 1–28. doi:10.1016/j.solmat.2011.08.010
- Lomas, K. J., Eppel, H., Martin, C. J., & Bloomfield, D. P. (1997). Empirical validation of building energy simulation programs. *Energy and Buildings*, 26(3), 253–275. doi:10.1016/S0378-7788(97)00007-8
- Loonen, R. C. G. M., Favoino, F., Hensen, J. L. M., & Overend, M. (2016). Review of current status, requirements and opportunities for building performance simulation of adaptive facades, *1493*(March), 1–42. doi:10.1080/19401493.2016.1152303
- Loonen, R. C. G. M., & Hensen, J. L. M. (2015). Smart windows with dynamic spectral selectivity - a scoping study. In *Proceedings of Building Simulation 2015* (pp. 2158 – 2165). Hyderabad, India.
- Loonen, R. C. G. M., Trčka, M., Cóstola, D., & Hensen, J. L. M. (2013). Climate adaptive building shells: State-of-the-art and future challenges. *Renewable and Sustainable Energy Reviews*, 25, 483–493. doi:10.1016/j.rser.2013.04.016
- Manz, H., Loutzenhiser, P., Frank, T., Strachan, P. A., Bindi, R., & Maxwell, G. (2006). Series of experiments for empirical validation of solar gain modeling in building energy simulation codes-Experimental setup, test cell characterization, specifications and uncertainty analysis. *Building and Environment*, 41(12), 1784–1797. doi:10.1016/j.buildenv.2005.07.020
- US DOE. (2015). "Application Guide for EMS Energy Management System - User Guide." [http://nrel.github.io/EnergyPlus/EMS\\_Application\\_Guide/EMS\\_Application\\_Guide/](http://nrel.github.io/EnergyPlus/EMS_Application_Guide/EMS_Application_Guide/).
- Warwick M.E.A. and Binions R. (2014), "Advances in thermochromic vanadium dioxide films", *J. Mater. Chem. A*, vol. 2(10), pp. 3275-3292.
- Warwick M.E.A., Ridley I., and Binions R., (2016), "Variation of thermochromic glazing systems transition temperature, hysteresis gradient and width effect on energy efficiency", *Build.*, vol. 6(2), no. 22, pp. 1-20.

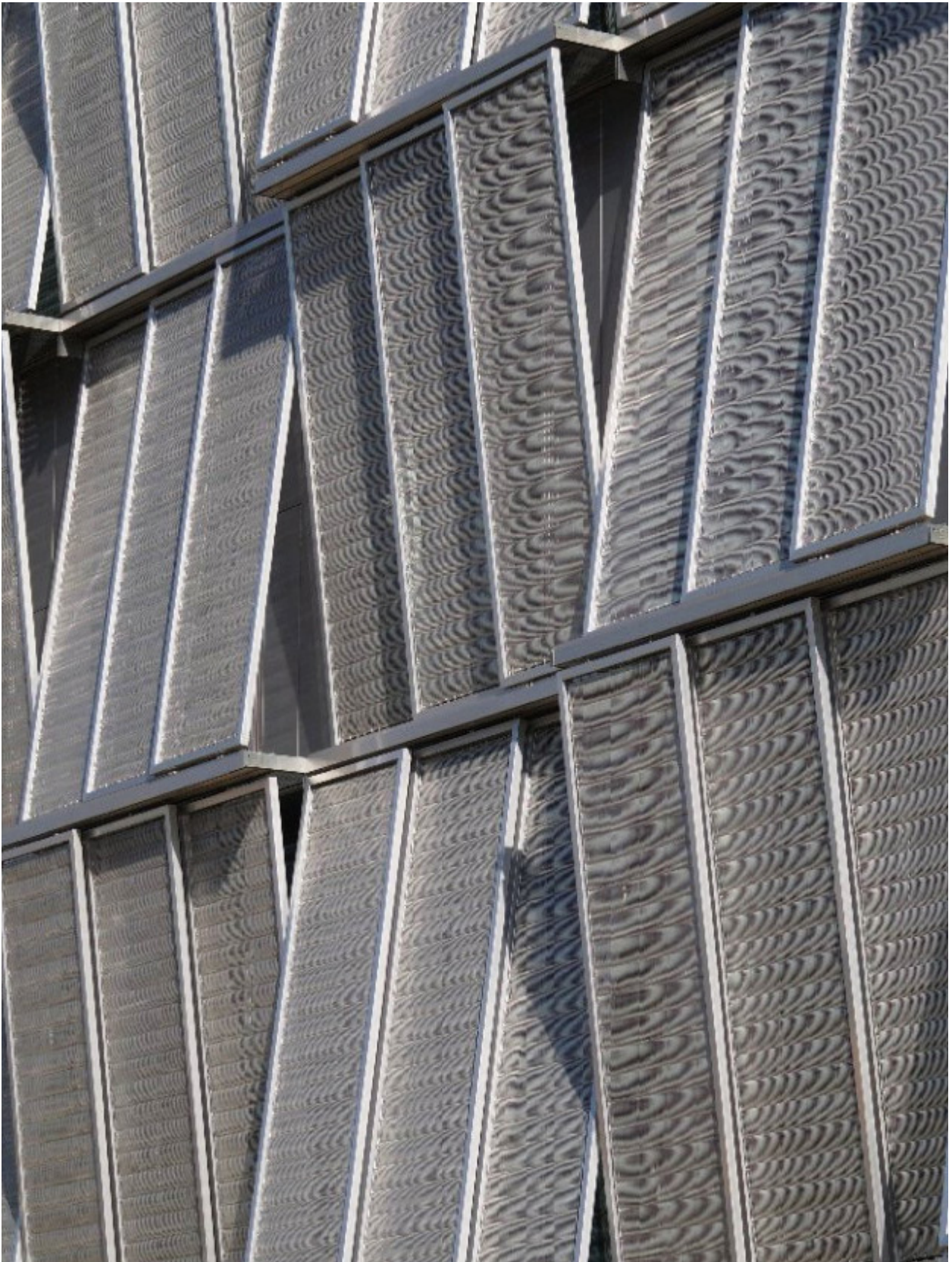

The Institute for Mechanical Engineering at EPFL / Dominique Perrault (image: M. Brzezicki)



# 4 Computational performance prediction of dynamic complex fenestration systems with BSDF

Giuseppe De Michele, Free University of Bolzano / Eurac Research; Roel C.G.M. Loonen, TU Eindhoven; Hemshikha Saini, TU Eindhoven; Fabio Favoino, Politecnico di Torino; Stefano Avesani, Eurac Research; Luca Papaiz, glassAdvisor; Andrea Gasparella, Free University of Bolzano

## 4.1 Complex fenestration systems for high-performance buildings

Contemporary building facades are expected to be increasingly multi-functional. They should not only provide shelter and protection, but often simultaneously also take care of energy conservation, daylight admission, glare prevention and mitigation of overheating. In response to these high-performance requirements, a growing interest in facades with light redirecting elements or layers with light scattering properties can be observed (Appelfeld, McNeil, & Svendsen, 2012; Gong, Kostro, Motamed, & Schueler, 2016; Saini, Loonen, & Hensen, 2018; Vera, Uribe, & Bustamante, 2017). Examples include venetian blinds, glass frits, prismatic films, etc. Unlike conventional glazing, these systems usually exhibit non-specular transmission. Moreover, their transmission properties idiosyncratically depend on the position of the sun or wavelength of the incoming radiation. To distinguish these fenestration systems from specular glazing systems, they are often referred to as complex fenestration systems (CFS) (Figure 1). CFSs are not by default always adaptive, in the sense that the optical properties of these systems do not need to change over time. There is, however, also a category of adjustable, retractable or movable CFS systems. This latter class of systems is the focus of this chapter.

The product development of such innovative façade systems can greatly benefit from knowledge gained through the use of building performance simulation (BPS) tools (Loonen, Singaravel, Trčka, Cóstola, & Hensen, 2014). Such computational tools can also aid in the adoption of CFS in the design phase of new buildings, by providing opportunities for informed decision-making.



Figure 1 - a) Adaptive Fritted Glass, Adaptive Building Initiative <http://www.hoberman.com/abi.html> (accessed in May 2018); b) IGU Cavity integrated solar shading lamellas <https://performanceglass.co.uk/pellini-blinds/venetian-blinds/> (accessed in May 2018); c) Prismatic PCM system, GlassX <http://glassx.ch/index.php> (accessed in May 2018)

## 4.2 Simulation requirements

A number of challenges are associated with modeling and simulation of CFS, deriving from their physical characteristics as well as lack of flexibility in the standard simulation workflows to sufficiently model these characteristics. This often leads to development of dedicated models with higher resolution and implementation of workarounds in the BPS tool used. The list below provides an overview of key physical characteristics of majority of the CFS and their corresponding implementation requirements within BPS tools:

- **Solar angle dependency of optical and thermal properties (e.g. scattering/diffusing layers and Venetian blinds):** achieve an appropriate representation of two-dimensional angular dependency (due to the shape and/or the movement of the components) of optical and thermal properties of the fenestration system, such as visible transmittance (VT) and solar heat gain coefficient (SHGC).
- **Spectral/temperature dependency of optical/thermal properties (e.g., switchable glazing/ phase change material (PCM)):** achieve an appropriate representation of spectral/thermal response of both optical and thermal properties (VT and SHGC) of the fenestration system.
- **Adaptiveness of the façade:** when the physical properties of the components of the façade system can be controlled to meet different performance requirements, it is important that the control logic (either intrinsic or extrinsic) can be implemented during simulation run-time, because the changing amount of solar radiation that enters the zones leads to a different transient thermal response of the space.

An appropriate representation of two-dimensional angular dependency of optical properties (VT) and thermal properties (SHGC) of the fenestration system remains the main challenge in modelling and simulation of CFS. The most commonly-used way of representing the two-dimensional angular dependency of solar properties (transmission and reflection) of CFS is via Bi-directional Scattering Distribution Functions (BSDF).

The BSDF method was proposed by Klems (Klems, 1994) to calculate solar transmission of multi-layered CFSs through matrix multiplication. In this method, front and back hemisphere of the CFS layer is discretized into 145 patches, for each of these, optical properties are specified depending on azimuth and altitude angle. The BSDF dataset containing file describes transmission (Bi-directional Transmission Distribution Function, BTDF) and reflection (Bi-directional Reflectance Distribution Function, BRDF) properties of a complex glazing system by a 145 x 145 matrix according to incident and outgoing angles using Klems' angle basis (Figure 2).

BSDF files (in XML format) for a variety of window materials and daylighting systems can be obtained from the LBNL complex glazing database (CGDB). This resource contains more than 100 systems, such as shading devices and materials (e.g., venetian blinds, roller shades, drapes, cellular shades, shade fabrics, etc.), light redirecting materials (e.g., prismatic films, etc.) and scattering glazing (e.g., diffuse glass, glazing frits, decorative glass, etc.). With this database, customized multi-layer glazing systems for different configurations of a façade system (e.g. shades up, down and/or tilted) can be created using the Berkeley Lab WINDOW program. From this program, data files can be exported for use in a number of whole building performance simulation programs.

Especially when innovative fenestration systems are considered, it may happen that the optical behavior of the fenestration system is not yet available in the CGDB. In this scenario, two options are available to obtain the necessary bi-directional optical data:



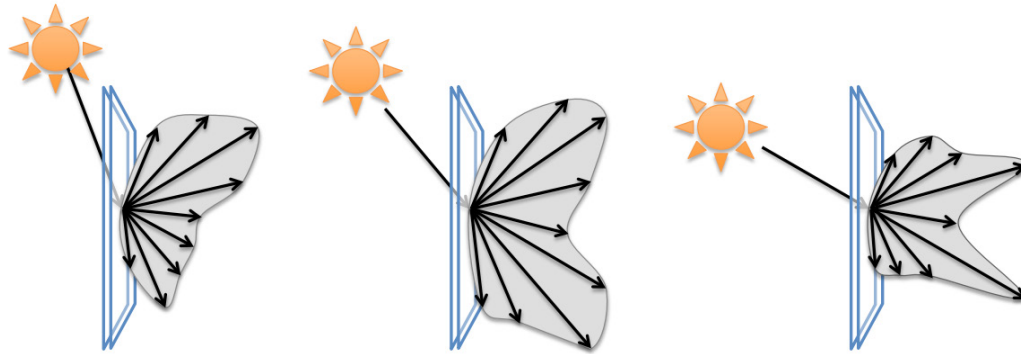

Figure 2 - A BSDF file describes the directional transmission and reflection for many different combinations of ingoing and outgoing directions. Source credit: Christian Kohler, LBNL

- **Measurements:** a photometric equipment, such as a goniophotometer is needed to characterize the angular transmission and reflection properties. This equipment is available in only a few research labs around the world. Experimental characterization is practically possible for small-scale CFS with homogenous scattering properties.
- **Simulations:** For macro-scale CFS with complex geometry e.g. louvers and specular blinds, the incident light source of photometric equipment cannot take into account variations in CFS sufficiently. BSDF files for such systems can be created by applying radiosity or ray-tracing algorithms on a geometrical model of the shading system or daylighting device in Window 6/7 or TracePro/genBSDF respectively. For a simplified geometrical model and lambertian systems Window 6/7 can be used, while for complex geometries and/or non-lambertian surfaces TracePro or genBSDF should be used (Konstantoglou et al., 2011). TracePro is a commercial software with a 3D CAD-based graphical user interface for design and analysis of optical and illumination systems. genBSDF, part of the Radiance daylight simulation suite, is a free and open source tool that generates BSDF file from a Radiance or MGF scene description. (McNeil et al., 2013).
- **Combining measurements and simulations:** It is possible to extend the simulation method with detailed measured data of the shading material. For this specific application, the opaque material reflectance can be characterized through a spectral curve or BRDF. The first data is an hemispherical measure of the material reflection, which is reliable for materials that behave or can be assumed as lambertian; while the BRDF is suitable for materials whose reflection presents complex behavior (e.g. high reflective or retro-reflective material) and an angular distribution is required.

In order to use the spectral data within WINDOW and Radiance, the data have to be integrated on the solar and visible ranges. The integrated values are directly set in the WINDOW material library, while in Radiance, they are adopted by using the plastic material. Then, the material has to be applied to a geometry that represents the shading device. Regarding the BRDF, such data can be used in Radiance by applying the BSDF material to a 3D geometry.

Within WINDOW, the shading layer can be directly joined to the glass layers in order to generate the BSDF of the whole system. Using Radiance, genBSDF generates an xml file that contains the BSDF data of the shading device. The xml file is then imported in WINDOW to compute the entire fenestration component.

### 4.3 Implementations in building performance simulation software

CFS systems have an impact on visual and thermal performance aspects. The interactions between both these physical domains need to be taken into account to predict the performance of such fenestration elements in an appropriate way. Accurate modelling of specular or diffusive behavior is in some cases required to evaluate how the light is distributed in the indoor environment and how the visual comfort may be affected. In addition, the impact on artificial lighting and HVAC systems needs to be considered.

In the BPS tools that evaluate the whole building energy performance by means of thermal networks (i.e. Energy Plus, TRNSYS, ESP-r, etc.), the main practice to consider the thermal and optical properties of a complex fenestration system is to use calculation algorithms according to ISO 15099 for the layer-by-layer heat transfer. In the ISO 15099 standard, the analytical algorithms for the optical modelling are restricted to simplified models, such as planar or curved blinds that have ideal diffusely reflection factors. For this reason, the algorithms relative to the optical modelling have been completely replaced with a BSDF data in most of these BPS tools.

A detailed review of capabilities shows that the following building performance simulation programs can be used to simulate complex fenestration systems using BSDFs:

- **EnergyPlus:** Since version 7.2, the BSDF functionality is part of EnergyPlus as one of the optical representations of fenestration systems. This implementation relies on the strong integration between EnergyPlus and LBNL Window software that allows the export/import of .idf files. The Construction:ComplexFenestrationState can be controlled using simulation run-time, by making use of the EMS functionality. The BSDF function is also integrated in COMFEN, a user-friendly interface to the EnergyPlus/Radiance engines.
- **ESP-r:** ESP-r is the only tool with an in-house developed model for complex fenestration systems, based on the AGSL shading model; not BSDF. It is aptly named the CFS functionality (Lomanowski and Wright, 2012). Alternate property sets for different fenestration/shading states can easily be changed using TMC control or the BCVTB-ESP-r control functionality (Hoes et al., 2012).
- **Fener:** Fener is a dedicated tool that was developed to ease the modeling and simulation of CFS systems (Bueno et al., 2015). It combines Radiance with a reduced-order RC network approach for thermal calculations on a time step basis. One of the specific strengths of Fener is its flexibility for implementing shading control algorithms, based on e.g. daylighting variables, such as illuminance and glare, thermal variables, such as indoor temperature and energy load, or weather variables, such as wind and solar radiation.
- **IDA ICE:** A validated implementation of the Radiance three-phase method with BSDF for complex fenestration system has recently been introduced in the thermal simulation environment of IDA ICE. More information is available in Karlsen et al., (2014).
- **Trnsys:** A new Trnsys type for daylight performance prediction with BSDF systems has recently been developed at Eurac research (TypeDLT) (De Michele et al., 2014). These daylight predictions can be coupled with the multi-zone thermal model (Type 56), but currently, a bi-directional functionality is not yet available in Trnsys's thermal building model. Such a BSDF capability, fully integrated in the TRNBuild graphical user interface is currently in testing phase, and scheduled for the next release (v18) of Trnsys (Hiller and Schottl, 2014).

#### 4.4 Validation

A curved commercial blind produced by Pellini ScreenLine® with a highly reflective coating (see Figure 3 and Table 1 for dimensions) is used to demonstrate both a simplified approach without using the BSDF method and a detailed modelling approach using the BSDF method. Based on the characteristics of the CFS and the type of questions the simulation study seeks to investigate, one of the two approaches should be carefully chosen as they can lead to different conclusions.

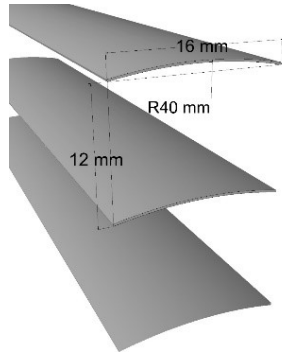

Figure 3 - Blind 3D geometry

Table 1 - Blind dimensions

Blind width	16	mm
Blind thickness	0.2	mm
Pitch	12	mm
Blind tilting	15 - 30	°
Raise	1	mm

**Simplified approach.** The shading model has been completely generated within the Berkeley Lab WINDOW software. The coating behavior was assumed Lambertian in order to use the material definition of WINDOW. In particular, the measured spectral data of the coating have been imported into WINDOW as shade materials. Table 2 shows the integrated reflectance values of the coating and the emissivity used as material for the blinds. The blind geometry has been precisely reproduced using the built-in functionality of WINDOW to generate custom horizontal venetian blinds; Figure 5 shows the lamellas' definition within the *Shading Layer Library*.

Table 2 - Coating characterization within WINDOW

Conductance	100 W/m k
Thickness	0.2 mm
Integrated values	
Solar Reflectance Front	0.901
Solar Reflectance Back	0.840
Visual Reflectance Front	0.959
Visual Reflectance Back	0.823
Emissivity Front	0.150
Emissivity Back	0.450

**Detailed approach.** This modeling is performed using angular measured data and Radiance. The high reflective coating has been characterized by means of measured angular reflectance values (BRDF) for Visible and Near Infrared wavelengths. The BRDFs were applied as material to the 3D geometry of the blinds within Radiance. The function genBSDF was then used to describe the geometry of the shade and the complex coating in the form of BSDF, with Klems resolution, for solar and visible spectrum. Additionally, a third BSDF for the infrared (IR) wavelength has been created using the plastic material of Radiance and assuming as coefficient of reflection the

complement to 1 of the emissivity front and back in Table 2. This last step was required in order to evaluate the hemispherical emissivity front and back and the infrared transmission of the system. Finally, an XML file that collects all the previous information was generated and imported in WINDOW.

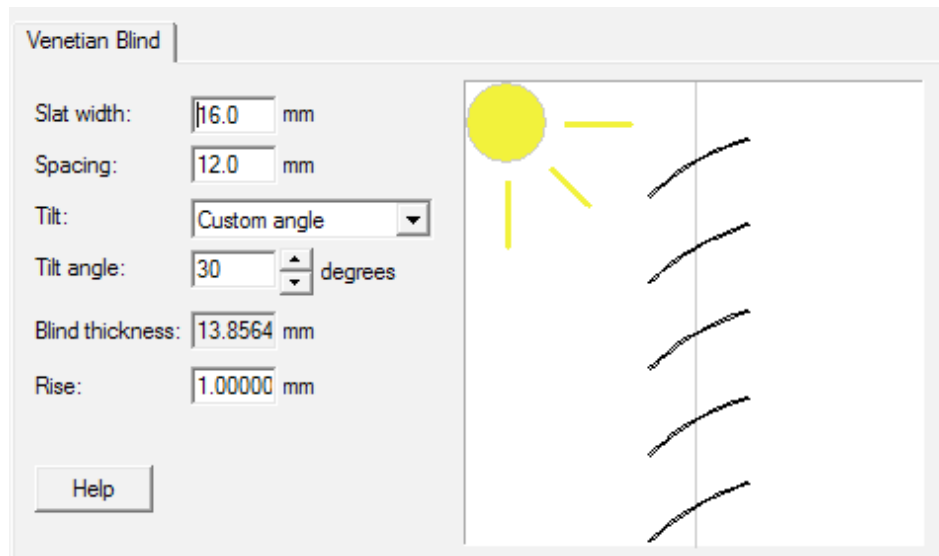

Figure 4 - Blinds geometry in WINDOW

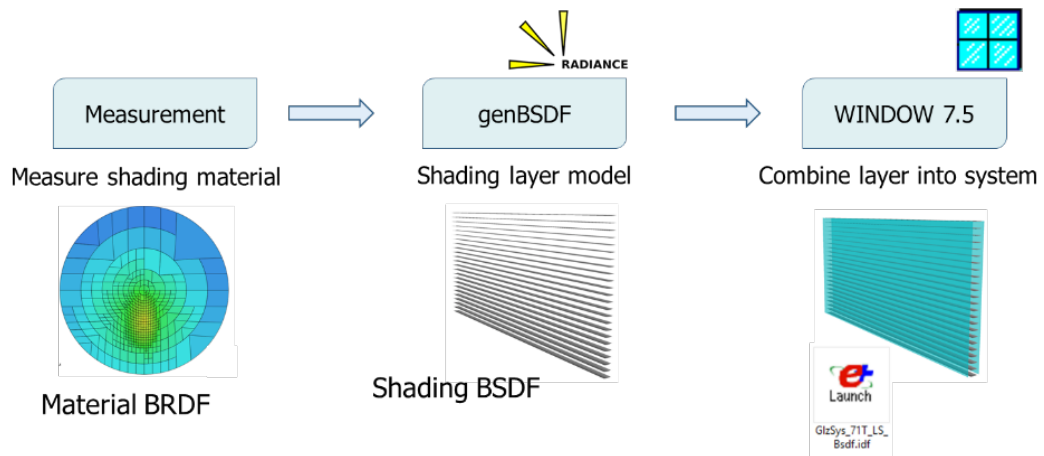

Figure 5 - Workflow of the detailed modeling procedure of the shading system

#### 4.5 Points of attention and future outlook

- The paucity of measurement facilities accompanied with expensive and time consuming measurements for generating BSDF data is a main challenge that can prevent widespread use of modeling and simulation of CFS systems.
- It should also be noted that users should be careful when using BSDF data files for modeling specular glazing systems, because of the limited angular resolution (10o – 15o) of the Klems discretization of the sky hemisphere.
- For glare assessment and determination of work plane illuminance for a particular time-step, current low resolution BSDF data format are not reliable, higher resolution BSDF format should be used.

- It is not always straightforward and sometimes not possible to perfectly integrate the control of CFS systems with the control of HVAC and artificial lighting systems.
- The modeling of non-standard shading is a complex topic and requires the competences of an expert user. There is no standard procedure as the one implemented in WINDOW, and the user has to create by himself the several input and merge all the information. The use of different tools is needed with a good chance of errors.
- Data required for the shading modeling can be difficult to obtain, e.g. the BRDF file used as material for the 3D geometry.
- The model ISO15099 has some known problems related to the convective calculation, some studies are investigating the problem for interior shade [5], other studies to define the limits of the standard and to propose if improvements are necessary.

## References

- Appelfeld, D., McNeil, A., & Svendsen, S. (2012). An hourly based performance comparison of an integrated micro-structural perforated shading screen with standard shading systems. *Energy and Buildings*, 50, 166–176. <http://doi.org/10.1016/j.enbuild.2012.03.038>
- Bueno, B., Wienold, J., Katsifaraki, A., & Kuhn, T. E. (2015). Fener: A radiance-based modelling approach to assess the thermal and daylighting performance of complex fenestration systems in office spaces. *Energy and Buildings*, 94, 10-20.
- De Michele, G., Oberegger, U., & Baglivo, L. (2014). Coupling Energy and Daylighting Simulation for Complex Fenestration Systems. In 13th International Radiance Workshop 2014.
- Gong, J., Kostro, A., Motamed, A., & Schueler, A. (2016). Potential advantages of a multifunctional complex fenestration system with embedded micro-mirrors in daylighting. *Solar Energy*, 139, 412–425. <http://doi.org/10.1016/j.solener.2016.10.012>
- Hart, R., Goudey, H. & Curcija, D.C., 2017. Experimental validation and model development for thermal transmittances of porous window screens and horizontal louvred blind systems. *Journal of Building Performance Simulation*, 0(0), pp.1–15. Available at: <https://doi.org/19401493.2017.1323010>.
- Hiller, M., & Schöttl, P. (2014). Modellierung komplexer Verglasungssysteme in TRNSYS. In *Proceedings of BauSIM2014*, the Fifth German-Austrian IBPSA conference (pp. 387-394).
- Hoes, P., Loonen, R.C.G.M., Trcka, M. & Hensen, J.L.M. (2012). Performance prediction of advanced building controls in the design phase using ESP-r, BCVTB and Matlab. Paper presented at the First IBPSA-England conference Building Simulation and Optimization(BSO12) 10-11 September 2012, Loughborough, UK
- Karlsen, L., Grozman, G., Heiselberg, P., & Bryn, I. (2015). Integrated design of daylight, thermal comfort and energy demand with use of IDA ICE. In *Proceedings of 7. Passivhus Norden | Sustainable Cities and Buildings*.
- Klems, J.H. (1994). New method for predicting the solar heat gain of complex fenestration systems- 2. Detailed description of the matrix layer calculation. *ASHRAE Transactions*, 100(1), pp.1073-1086.
- Konstantoglou, M., Jonsson, J.C., Lee, & E. (2011). Simulating complex window systems using BSDF data. Lawrence Berkeley National Laboratory. Lawrence Berkeley National Laboratory: Lawrence Berkeley National Laboratory. LBNL Paper LBNL-4416E. Retrieved from: <https://escholarship.org/uc/item/86v03086>
- Lomanowski, B. A., & Wright, J. L. (2012). The Complex Fenestration Construction: a practical approach for modelling windows with shading devices in ESP-r. *Journal of Building Performance Simulation*, 5(3), 185-198.
- Loonen, R.C.G.M., Favoino, F., Hensen, J.L.M., Overend, F. (2016) Review of current status, requirements and opportunities for building performance simulation of adaptive facades. *Journal of Building Performance simulation*. <http://dx.doi.org/10.1080/19401493.2016.1152303>
- Loonen, R. C. G. M., Singaravel, S., Trčka, M., Cóstola, D., & Hensen, J. L. M. (2014). Simulation-based support for product development of innovative building envelope components. *Automation in Construction*, 45. <http://doi.org/10.1016/j.autcon.2014.05.008>



- McNeil, A., Jonsson, C. J., Appelfeld, D., Ward, G., & Lee, E. S. (2013). A validation of a ray-tracing tool used to generate bi-directional scattering distribution functions for complex fenestration systems. *Solar Energy*, *98*, 404-414.
- Saini, H., Loonen, R. C. G. M., & Hensen, J. L. M. (2018). Simulation-based performance prediction of an energy-harvesting façade system with selective daylight transmission. In *Proceedings of ICAE2018 - International Congress on Architectural Envelopes*. San Sebastian, Spain.
- Vera, S., Uribe, D., & Bustamante, W. (2017). Optimization of a fixed exterior complex fenestration system considering visual comfort and energy performance criteria. *Building and Environment*, *113*(June), 11–14. <http://doi.org/10.1016/j.buildenv.2016.07.027>

# 5 Computational performance prediction of radiant glass

Giuseppe La Ferla, Universidad Politécnica de Madrid

## 5.1 Radiant glass for high-performance buildings

Radiant glass (RG) is an adaptive façade technology that uses a low emissivity double pane glass of commercial insulating curtain wall as heating device. It is also known as electrically heated glass.

This type of glass has a good transparency and electrically conductivity property, and if electric power is inducted into its transparent conductive oxide layer, it produces heat radiation by radiant energy due its semiconductor property and acts as heating device (La Ferla et al., 2016).

The all extension of the glass in the façade is performing as surface exchange between the heating source and the environmental space. This condition permits the low increasing between the superficial inner glass temperature and the operative temperature, keeping the glazed pane temperature near interior ambient temperature (La Ferla et al., 2016).

The benefit to operate on the mean radian temperature permits to control the radiant asymmetry between the glass and the inner spaces, increasing thermal human comfort and avoiding typical local discomfort to the occupants caused by glass envelopes.

## 5.2 Simulation requirements

Radiant glass has an impact on thermal performance aspect and on thermal comfort of the glazed façade. To calculate the heat transfer through the glass and the behaviors of the system, is needed to evaluate the thermal domain taking in account the surroundings conditions, glasses and cavity physical properties, geometrical configuration of boundary configuration. The main question to model and simulate the RG is to have an accurate representation of the thermal heat transfer between all the system panes and the contribution of the heated low emissivity layer.

To build up correctly this model has been used the mathematical equations developed in the ISO 15099 (2003) for the energy balance on each glass pane surface, and to calculate the contributions of low-e to the system has been used the methodology developed by Moreau et al. (2008).

In this model the surfaces temperatures ( $\theta_i$ ) and the electrically power  $P$  (applied to the low-e) are the unknowns factors that must be calculated alternatively to solve the equations.

## 5.3 Implementations in building performance simulation software

The RG is marginally present in the market, and maybe for this reason, ad hoc simulation tools

have not yet included in the widely spread commercial building simulation softwares. So that, currently its property and thermal behaviours are not adequately studied and developed in terms of radiant heating device, thermal comfort property, and energy consumption.

In the work of La Ferla (2016) was developed a simulation tool to predict the surfaces temperatures of the glasses and the electrically power fed to the RG system, and has been used the energy balance model based on the same methodology proposed by Moreau et al. (2008) work. The problem was to define and solve the mathematical model of no linear  $n$  equations with  $n$  variables (figure 1), which better represent the bi-directional thermal balance of the glass, according the ISO 15099 (2003). The Newton-Raphson method was used to solve the problem considering successive interactions of an associated Jacobian matrix.

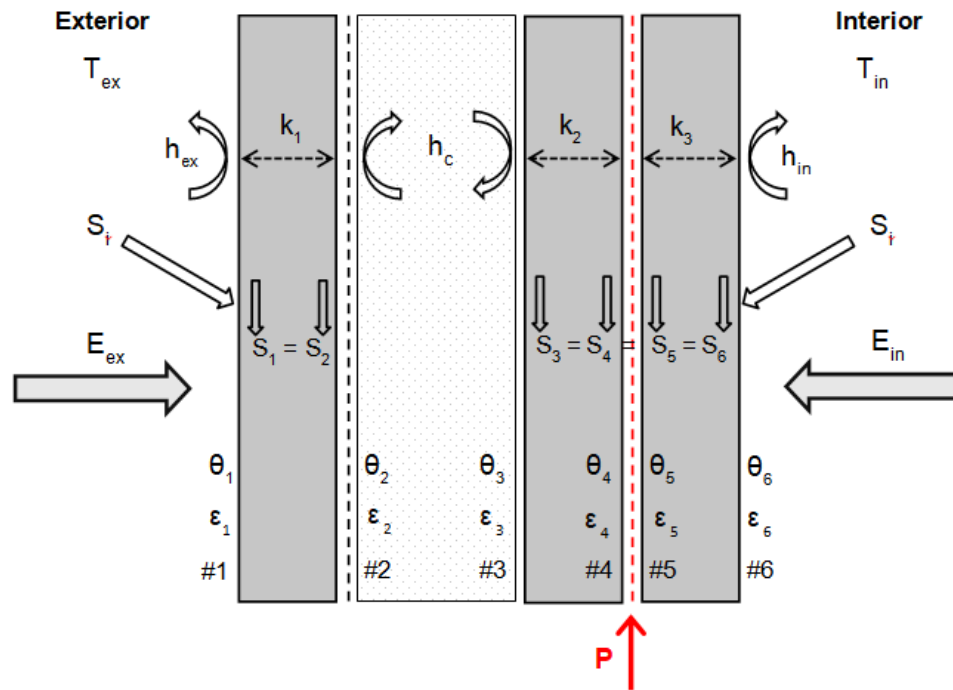

Figure 1 - Radiant glass configuration and variables used in the thermal balance model.

All the glass physical characteristics and the optical parameters data for the façade were extracted from the International Glazing Database (IGDB) by the LBNL and was used the WINDOW 6 software program developed by the Berkeley Laboratory.

The complexity of the thermal interaction of double low emissivity glasses and switched low-e layer, boundary conditions and solar been incident interaction, needs an elaborate dynamic tool with more appropriate energy simulations program like TRNSYS, EnergyPlus and others well known softwares, that still it have not been done.

## 5.4 Validation

Very few studies have been done to validate the energy balance model used for the RG simulations.

Moreau et al. (2008) has developed and validated his model in two steps: firstly he had compared the results of the simulations of the model (setting the P supply power switch-off and considering inactive the RG) with the WINDOW (by LBNL) calculation results for the same glasses; Secondly the author compared the model with the results obtained on tests conducted at Hydro-Quebec's Research Institute in a dual climate chamber.

Both analyses permitted to validate the energy balance model with an accurate prediction of the simulation with regard to the experimental data.

However the windows used for the tests had have a small dimensions of the glass panes, were done in controlled climate conditions and for a short period of test.

Kurnitski et al. (2004) has developed an energy balance model to calculate the efficiency of the RG. The validation of the model had been conducted in the Finnish Research Center VTT and was repeated in another laboratory, with measurements on radiant window with triple-glazing. Nevertheless the results of those two diverse experiments were significantly different.

To have more experimental data to validate and increase the confidence in the model as tool capable to simulate the RG behaviours, a large campaign of tests have been done by La Ferla et al. (2016) in the tests facility of the Universidad Politécnica de Madrid with two equal external cell boxes (figure 2), in real exterior weather condition, considering a long period of time and in different seasons.



Figure 2 - External cell boxes equipped with radiant glass façade in UPM Campus.

There were performed measurements of inner and exterior temperatures of the glazed façade, ambient and exterior surrounding temperatures, humidity, atmospheric pressure, solar irradiance, wind velocity and other characteristic values, although the results are not definitely available yet.

## 5.5 Points of attention and future outlook

Even if radiant glass technology can be found in the construction façade market, there are still lots of issues that need to be further investigated and validated, especially in the simulation field:

- Very few research campaigns have been conducted till now and where they have been done, they were made in extreme cold climate conditions.
- Currently it is not possible to simulate this technology with the most common building simulation software, because these types of tools have not yet been integrated into them.
- It is not possible to have an adequate dynamic simulation performance of the system in a validated building model.
- Research conducted till now based on energy balance model have investigated analytical behaviours of thermal model, but not the benefits on thermal human comfort, especially if we considered different types of buildings (residential, office, etc.)
- It have not been studied the real electrical consumption and the energy need of large scale building, and it is still not possible to have a comprehensive energy saving and sustainability performance of the system.

In spite of the difficulty to have tools and adequate dynamic simulations of the system, it can be said that the thermal and comfort effect during the experimental procedure are easy to measure and to determinate during the validation issue.

## References

- ISO 15099 (2003). Thermal performance of windows, doors and shading devices — Detailed calculations. Standard ISO 15099:2003 (EN). Revised on 2016
- La Ferla, G., Acha, C., Roset, J. (2014) El vidrio calentado eléctricamente y su eficiencia energética como sistema de calefacción en una envolvente acristalada. Primer Congreso Internacional Sobre Investigación en Construcción y Tecnología Arquitectónicas. Madrid: Esquela Técnica Superior de Arquitectura Madrid.
- La Ferla, G., Roset, J., Lopez, A. (2016) Electrically heated glass in Mediterranean climate. In Smart Energy Regions. Skills, knowledge, training and supply chains. Editors J. Roset Calzada, I. Kaltenecker et al. The Welsh School of Architecture, Cardiff University. February 2016. pp. 333-338.
- Kurnitski, J., Jokisalo, J., Palonen, J., Jokiranta, K. Y Seppänen, O. (2004) Efficiency of electrically heated windows. Energy and Buildings. 36, pp. 1003–1010.
- Moreau, A., Sansregret, S. Y Fournier, F. (2008) Modelling and Study of the Impacts of Electrically Heated Windows on the Energy Needs of Buildings. In 6th IASME / WSEAS International Conference on Heat Transfer, Thermal, Engineering and Environment (IHTE'08). Rhodes: Greece.



# 6 Computational performance prediction of adaptive insulation

Fabio Favoino, Politecnico di Torino

## 6.1 Adaptive insulation systems for high performance buildings

Adaptive insulation technologies have the ability to modulate the overall heat transfer between the indoor and outdoor space. Modulation of heat transfer, by means of controlling conduction, radiation and convection heat transfer, in a sealed building envelope component, aims at minimizing the energy use of the building for heating and cooling, and at maximizing the overall thermal comfort of occupants, avoiding overheating risk and reducing the risk of local thermal discomfort (i.e. radiant temperature asymmetry etc.). Double Skin Façades are not included in this classification, because the cavity of the system is not sealed to the outdoor and/or indoor environment, therefore the insulation level is influenced by the property of the air entering the cavity.

Different materials and systems are used to achieve controllable heat transfer across a building component for adaptive insulation. The main differences between various types of adaptive insulation can be summarized with the following features:

- Control mechanism: adaptive insulation can be achieved by controlling the opening or closing of a screen (made of insulating material) in an opaque or transparent component (Hashemi and Gage 2012). Other alternative ways are controlling the convection of a fluid in a closed cavity, either at the micro scale level (controlling the pressure of a gas in a nano-porous or micro-encapsulated material), or at a macro-scale level (controlling the convection inside one or more air cavities sealed to the outdoor or indoor environment). More recent systems are capable of controlling radiation by modulating the emissivity of a surface, or conduction by modulating the thermal conductivity of a re-orientable material. The controllable insulation level is usually achieved with an extrinsic control, i.e. the component is operated by an external building management system.
- Insulation range: adaptive insulation technologies can modulate different material and/or flow properties (i.e. emissivity, orientation of particles, pressure, flow velocity). This ultimately affects the adaptive insulation range achievable at the slab level (minimum and maximum insulation level in the off- and on-state respectively), and the speed at which the adaptive component is able to modulate the insulation level.

There are very few technological solutions available on the market, and many are still either at concept, laboratory or research and development stage. Favoino et al. (2017) provide an extensive overview of the state-of-the-art in this field. Figure 1 shows the capability of different adaptive insulation technologies in terms of their range of thermal conductance or equivalent thermal resistance.

## 6.2 Simulation requirements

Adaptive insulation has an impact on thermal performance aspects, if it is included in an opaque

component, and may have an impact on visual aspects as well, if it is integrated into a transparent one. In the latter case, when the insulation level is modulated, the optical properties of the component can vary as well. If this is the case, then it is important that thermal and visual aspects are co-simulated (cf. switchable glazing).

It is important that the modulation of heat transfer through the façade happens during simulation runtime, as it affects the amount of heating and cooling energy needed to keep a comfortable level of indoor environmental conditions by means of the HVAC system of the building.

### 6.3 Implementations in building performance simulation software

Only a restricted number of BPS tools provides application oriented modelling options to simulate adaptive insulation systems. A controllable layer can be applied to the interior or exterior side of an opaque facade element to temporarily increase its thermal resistance. These materials are massless, which means that no thermal energy can be stored in a moveable insulation layer. But if adopted as an external or internal layer of a heavyweight construction, it is possible to investigate the joint effect of coupling adaptive insulation with thermal mass in particular for the exploitation of solar energy for heating purposes. EnergyPlus (Jin et al. 2015) and IDA ICE (Bionda et al. 2014) can simulate the performance of building envelopes with adaptive insulation (moveable or switchable insulation model).

The GUIs of EnergyPlus, IDA ICE and IES VE provide the option to give dynamic shading devices additional thermal resistance properties. This makes it possible to simulate the performance of insulating solar shading systems (Hashemi and Gage 2012). In such an implementation, dynamic thermal insulation and solar shading are coupled, so that their separate effects cannot be analyzed.

Moreover whenever the insulating solar shading system is used during daytime, the coupled thermal and visual effects need to be assessed.

Adaptive systems that adopt convection to vary their equivalent thermal resistance, by means of closed or open loop ventilation (as per Pflug et al. 2017 and Koenders et al. 2018), could be simulated by means of a surrogate model in EnergyPlus. This is an ad-hoc modification of the ventilated slab model, which was developed by Chae and Strand (2013), to represent a closed loop ventilative adaptive insulation system. The implementation of this modelling approach is described in Koenders et al. (2018).

Application oriented models of switchable insulation, both for opaque systems and for insulating solar shading systems, provide a limited number of control sensor possibilities to choose from in order to control the adaptive components. These are usually indoor and outdoor temperature, heating or cooling demand, scheduled actions, and in case of insulating solar shading systems also control based on solar radiation may be available.

Favoino et al. (2017) adopted the EnergyPlus model switchable insulation model to simulate and compare the performance of the different systems described in Fig. 1, in a specific climate and building typology, varying the control methodology. This was done by coupling the switchable insulation model with the EMS system within EnergyPlus, in order to optimize the control methodology aimed at the minimization of both total energy use and occupant discomfort.

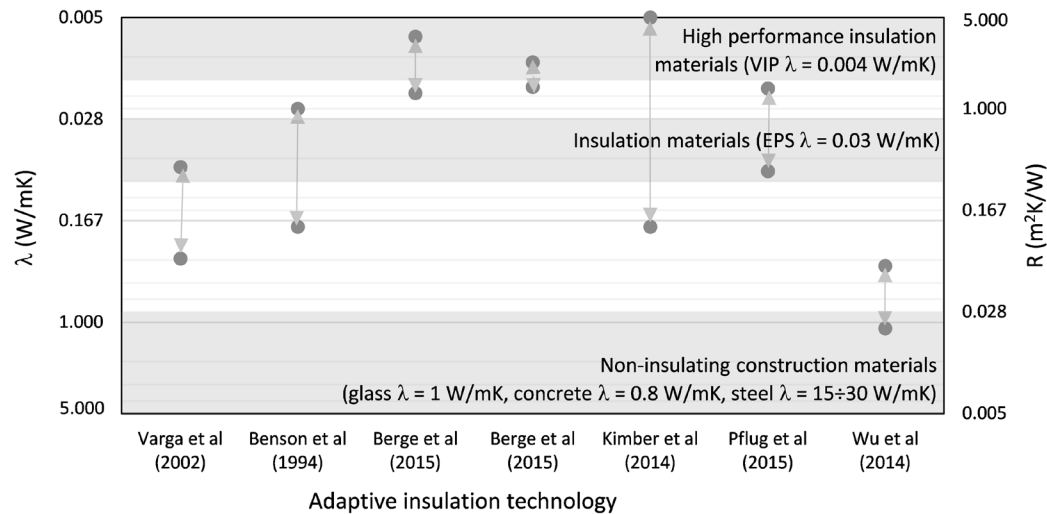

Figure 1 - Thermal conductivity ( $\lambda$ ) and R-value modulation of adaptive insulation materials and technologies (y-axis with logarithmic scale), compared to conventional static construction materials (insulating and non-insulating). Where only one indicator is found in literature (i.e. only the U-value or only  $\lambda$ ), the other one is calculated assuming a 2.5 cm thickness of the insulation layer (Favoino et al. 2017).

#### 6.4 Validation

No validation study exists for any of the modelling approaches documented. In particular, there has never been a comparison between experimental measurement and simulated data for a specific adaptive insulation system. In order to prove the reliability of the simulation results of adaptive insulation systems, in depth quality checks were carried out by different researchers on the numerical results of the analysed systems.

In particular Favoino et al. (2017) verified the reliability of modelling the adaptive insulation as a massless layer with the “SurfaceControl:MovableInsulation” class list within EnergyPlus. Although this relies on the accuracy of the EnergyPlus building envelope model, which is documented in US DoE (2015), the main purpose of this analysis was to compare the temperatures at the interface between the insulation layer and the concrete, and along the concrete layer, for winter and summer cases. In particular, the temperature at different thicknesses along the building envelope were compared (outdoor air, external surface, insulation layer, interface surface between insulation and concrete layer, at 4 points along the thickness of the concrete layer, and internal surface), for a typical sunny winter day (low temperature and high solar radiation) and a typical summer sunny day (high temperature and solar radiation). The results of this comparison are shown in Figure 2 (Winter case, left, thermal resistance set to 0 between 10 AM and 4 PM, and Summer case, right, thermal resistance set to 0 between 7 PM and 4 AM).

Similarly, in Koenders et al. (2018), before conducting building-level dynamic simulations, the model implemented was verified in a case with known boundary conditions. In particular the U-value of adaptive insulation system is numerically determined by mimicking a hot box situation. Two hot box simulations were performed (for the system in on and off state) showing a perfect match with the values obtained by hand calculations following the assumptions in ISO standards.

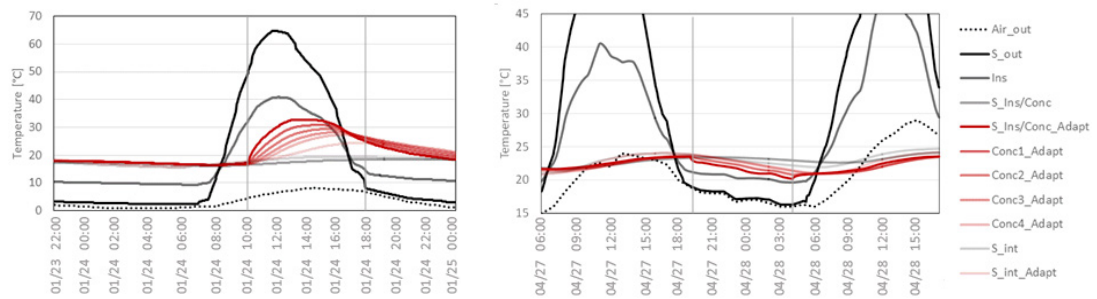

Figure 2 - Temperature variation along construction thickness for static insulation construction modelled with EnergyPlus building envelope model and adaptive insulation modelled with EnergyPlus “SurfaceControl:MovableInsulation” class list for winter case (left) and summer case (right). Favoino et al. (2017).

## 6.5 Points of attention and future outlook

Although application oriented modelling options can provide simulation support for the design and control of adaptive insulation systems, there are still some issues that require further research:

- It is currently not possible to simulate adaptive insulation layers as intermediate layers of a multilayered building envelope component, but only as either internal or external layers, unless an additional thermal zone is introduced in the model within the wall construction. Although careful validation of the results is needed in the latter case.
- It is currently not possible to simulate a delayed response of the adaptive insulation system to the control stimulus (such as time delayed response of the thermal conductivity), this could be the case for systems controlling the insulation level by modulating the gas pressure inside a microporous structure (Berge et al. 2015).
- It is not always straightforward to understand which is the most appropriate control to improve building performance for an adaptive insulation system, especially for heavyweight building envelope elements, due to delay between the controlled action and the thermal response of the building system. Moreover application oriented models provide very few control sensors options, and limited to no flexibility as far as the design of the control algorithm is concerned.

## References

- Al-Nimr, M.A., K.R. Asfar, and T.T. Abbadi. (2009). Design of a Smart Thermal Insulation System, *Heat Transfer Engineering* 30 (9), 762–769.
- Benson, D. K., Potter, T. F., Tracy, C. E., (1994). Design of variable conductance vacuum insulation. Proceedings of SAE 1994, Detroit, US.
- Berge, A., Hagentoft, C., Wahlgren, P., Adl-Zarrabi, B., (2015). Changing Internal Pressure to achieve variable thermal conductivity in Thermal Insulation. Proceedings of Advanced Building Skins 2015, Graz, Austria.
- Bionda, D, U.P. Menti, and H Manz (2014). “Kann Eine Gebäudehülle Mit Steuerbarem U-Wert Zur Reduktion Des Kühlenergiebedarfs Beitragen?” In Proceedings of BauSIM2014, the Fifth German-Austrian IBPSA Conference, 649–55.
- Brunsell, J., (1995). The performance of dynamic insulation in two residential buildings. *Air Infiltration Review* 16:4, 7-11.
- Buckley, S., (1978). Thermic diode solar panels for space heating. *Solar Energy* 20:495–503.
- Chae, Y.T., Strand, R.K., 2013. Modeling ventilated slab systems using a hollow core slab: implementation in a whole building energy simulation program, *Energy Build.* 57, 165–175. doi:10.1016/j.enbuild.2012.10.036.

- Fabio Favoino, Qian Jin, Mauro Overend, Design and control optimisation of adaptive insulation systems for office buildings. Part 1: Adaptive technologies and simulation framework, *Energy* 127, Pages 301-309, ISSN 0360-5442, <https://doi.org/10.1016/j.energy.2017.03.083>.
- Gan, G., (2000). Numerical evaluation of thermal comfort in rooms with dynamic insulation. *Building and environment* 35: 445-453.
- Hashemi, A., and S. Gage (2012). "Technical Issues That Affect the Use of Retrofit Panel Thermal Shutters in Commercial Buildings." *Building Services Engineering Research and Technology* 35 (1): 6–22. doi:10.1177/0143624412462906.
- Kimber, M., W.W. Clark, and L. Schaefer (2014). "Conceptual Analysis and Design of a Partitioned Multifunctional Smart Insulation." *Applied Energy* 114 (February): 310–19.
- Koenders, S.J.M. , Loonen, R.C.G.M., Hensen, J.L.M., 2018. Investigating the potential of a closed-loop dynamic insulation system for opaque building elements, *Energy and Buildings* 173, 409-427, ISSN 0378-7788, <https://doi.org/10.1016/j.enbuild.2018.05.051>.
- Pflug, T., Kuhn, T.E., Nörenberg, R., Glück, A., Nestle, N., Maurer, C., (2015). Closed translucent façade elements with switchable U-value—A novel option for energy management via the facade, *Energy and Buildings* 86, 66-73, ISSN 0378-7788, <http://dx.doi.org/10.1016/j.enbuild.2014.09.082>
- U.S. DOE, 2015. EnergyPlus 8.3.0-b45b06b780 Testing with Building Thermal Envelope and Fabric Load Tests from ANSI/ASHRAE Standard 140-2011
- Varga, S., Armando, C.O., Afonoso, C.F., (2002). Characterisation of thermal diode panels for use in the cooling season in buildings, *Energy and Buildings* 34: 227-235.
- Xenophou, T., (1976). System of using vacuum for controlling heat transfer in building structures, motor vehicles and the like, US Patent No. 3,968,831
- Wu, Z., Feng, Z., Sundén, B., & Wadsö, L. (2014). A comparative study on thermal conductivity and rheology properties of alumina and multi-walled carbon nanotube nanofluids. *Frontiers in Heat and Mass Transfer*, 5.
- Zheng, R., Gao, J., Wang, J., & Chen, G. (2011). Reversible temperature regulation of electrical and thermal conductivity using liquid–solid phase transitions. *Nature communications*, 2, 289.





Lausanne Opera House / DL-A Devanbéry & Lamunière Architectes (image: M. Brzezicki)

# 7 Computational performance prediction of phase change materials in opaque components

Albert Castell, Marc Medrano, Sergi Vall; University of Lleida

## 7.1 Phase change materials in opaque components for high-performance buildings

Phase change materials (PCM) are materials that present the ability to change its phase within a desired temperature range in order to store and release energy. The process must be reversible and stable to ensure that all energy absorbed can be released in a later process. Therefore, PCM are used for energy storage and/or thermal inertia, using their latent heat. Latent heat presents high energy densities over a narrow temperature range. When compared to sensible heat for the same temperature range latent heat is much higher, thus reducing the amount of required material and volume to store the same amount of energy. The most commonly used phase change is the solid-liquid one due to the energy storage density and the low volume expansion. The operating principle of PCM is simple. When the temperature of the material increases, the PCM changes its phase from solid to liquid absorbing energy. When the temperature of the material decreases, the PCM changes its phase from liquid to solid releasing heat. The use of PCM in opaque wall components aims at reducing the indoor temperature fluctuations as well as at delaying the air temperature peaks, thus increasing the thermal comfort and/or reducing the energy consumption.

Different materials and systems can be used to act as thermal inertia in building opaque envelopes. When related to PCM, the main parameters to consider are:

- Material: Different types of materials can be used as PCM. The most common ones can be classified as organic or inorganic. Cabeza et al. 2011 presents an extensive overview of materials and their main characteristics.
- Thermo-physical properties: The most important properties of the PCM to consider are the latent heat of fusion (which determines the amount of energy that can be stored per unit volume or mass), and the phase change temperature range (which determines the temperature level of the energy stored). Other significant properties to consider are reviewed in Cabeza et al. 2011.
- Charging/discharging method: The method used to charge and discharge the energy in the storage component will define the operating principle of the system. These methods can be: (1) active (Navarro et al. 2016a), where the heat exchange is driven by forced convection heat transfer and/or mass transfer; or (2) passive (Navarro et al. 2016b), where the heat transfer is driven without any mechanical input (solar radiation, temperature difference, etc.).
- Integration system: The PCM can be integrated into the building envelope in different ways and locations. The integration system will depend on the material, its encapsulation, its thermal behaviour, and on construction considerations. Integration systems are classified and reviewed in (Navarro et al. 2016b).

## 7.2 Simulation requirements

Phase change materials integrated in opaque building components have an impact on thermal performance aspects. Thus, accurate modeling of PCM must be linked and performed in conjunction with building thermal simulation, since the behavior of the PCM directly affects the thermal comfort and/or energy consumption of the building.

The dynamics of melting and solidification involve a moving boundary that separates the two different phases with drastically different transport properties. Moreover, the PCM behavior is highly non-linear when changing phase, since its enthalpy (energy storage capacity) changes dramatically with temperature. Therefore, numerical methods are required, and simplified techniques such as conduction transfer functions (CTF) are not suitable (Cabeza 2015).

Some numerical models attempt to approximate the solution to simplified Stefan problems. This so-called “strong formulations” determine the moving solid-liquid boundary and the temperature profiles. Both fixed and variable grid methods have been proposed to track the melting front. A review of such methods is available in Hu and Argyropoulos 1996. However, these formulations, although crucial to understand the fundamental behavior of the phase change, require too much computational effort for practical applications. Therefore, the so-called “weak formulations” are commonly used to capture the essential behavior of a PCM system, being able to represent the absorption and release of energy. Some of these formulations are the effective heat capacity method, heat integration method, source based method and the enthalpy method. Nowadays, the effective heat capacity method and the enthalpy method are the most extended ones (Voller 1997). Figure 1 presents the different models implemented in building simulation programs (BSP) as a function of the formulation used to simulate the PCM behavior.

To avoid numerical problems and/or phase-change jumping, these methods require of relatively short time steps, as well as relatively fine discretization of the physical domain.

To ensure an accurate modeling of the PCM system, special attention must be paid in the determination of the temperature-enthalpy curve. Moreover, other physical phenomena can also be introduced in the models, such as convection heat transfer inside the PCM container, subcooling of the PCM and enthalpy hysteresis. The necessity of the model to incorporate such effects must be considered for each case study. Figure 2 presents the different models implemented in building simulation programs capable to simulate such phenomena.

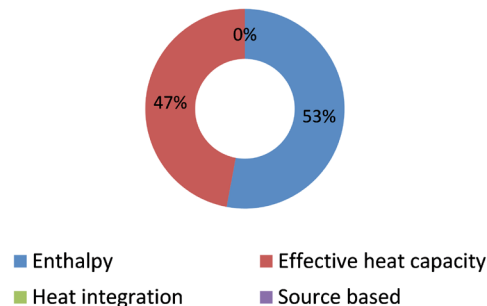

Figure 1 - PCM models implemented in BSP as a function of the formulation used.

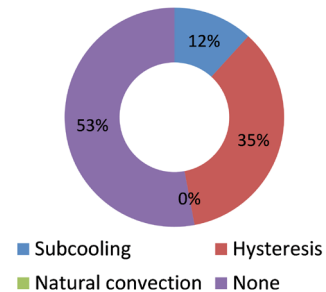

Figure 2 - PCM models implemented in BSP capable to simulate specific phenomena.

Finally, control strategies are also of great importance for the simulation of PCM systems. For passive systems no control strategy is applied, since the phase change process is controlled by the boundary conditions. On the other hand, for active and hybrid systems different control strategies can be applied, and their influence in the PCM behavior is very important (de Gracia et al. 2013, de Gracia et al. 2015a, de Gracia et al. 2015b).

### 7.3 Implementations in building performance simulation software

There are many numerical models available, capable to simulate the inclusion of PCM in opaque building envelopes. The most widely used are in Trnsys and EnergyPlus (Figure 3). However, attention must be paid to their experimental validation (Figure 4) and physical phenomena considered (such as hysteresis). As an example, one can consider the EnergyPLUS package described and experimentally validated in Tabares-Velasco 2012, or the Trnsys type described and validated in Kuznik et al. 2010. These kinds of models usually require the Temperature–Enthalpy curve, the thermal conductivity, and the specific heat of the PCM as input data. These models are application oriented and integrated in Building Energy Simulation (BES) software. On the other hand, there are many other ad-hoc models available in the literature, which can be used for specific component simulations.

The accuracy of the Temperature–Enthalpy curve of the PCM is of great importance for the simulation. BES programs usually require this information to be introduced in the form of a single discrete table for both melting and solidification (thus not considering hysteresis). The selection of the measurement technique used to determine this curve is therefore crucial, and one must ensure to obtain this information from the manufacturer when using a commercial PCM.

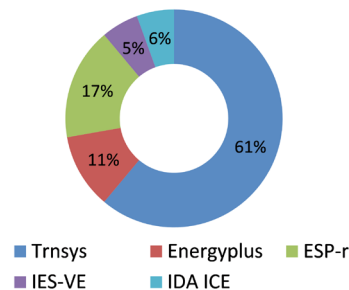

Figure 3 - PCM models implemented in different Building Simulation Programs.

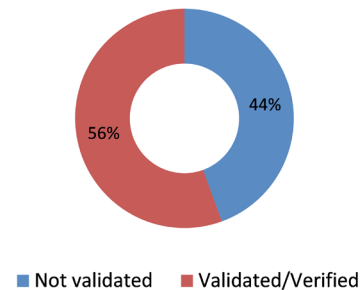

Figure 4 - Validation of PCM models implemented in different Building Simulation Programs.

### 7.4 Validation

The validation process has become crucial to ensure accuracy, precision and reliability of numerical simulations and models. Although validation generally refers to direct comparison between experimental data and simulation results by means of concepts as average errors or relative maximum errors, other processes are also used, such as analytical validation and model verification. Analytical validation consists in comparing the simulation results of a simple case with its analytical solution, while model verification consists in comparing the simulation results with those of a validated model.

In a validation process, experimental errors must be considered, as well as errors in input data. For PCM simulation, errors in weather/ambient conditions as well as in PCM thermo-physical properties are of great importance and must be carefully evaluated (Dolado et al. 2011). Moreover, some physical phenomena of the PCM may not be captured by the model, such as hysteresis or subcooling, thus resulting in significant deviations in the results.

When validating a PCM model an important aspect to consider is the variable to analyze; in some cases it can be a PCM variable (energy stored/released, PCM temperature evolution, etc.), or a variable of the system (internal temperature of the building, energy demand of the building, etc.). In the latter case it is important to remember that the validation is not oriented to the PCM only, but to its effect in the system. Thus, other components of the system can generate errors, and errors of the PCM model can be hidden by the whole system behavior.

Finally, when PCM is used as a passive system (intrinsic control), attention must be paid to the whole system error, since errors in the system may result in temperature errors in the PCM and a complete different behavior.

BES programs usually attempt to experimentally validate their models (Kuznik and Virgone 2009, Kuznik et al. 2010, Tabares-Velasco 2012). However, these validations can be limited to certain situations and, thus attention must be paid to the validity range and conditions. Moreover, stand-alone and own-developed models are mostly not validated against experimental data. Standardization for PCM model validation would be an interesting issue to develop, as well as detailed and reliable experimental data.

## 7.5 Points of attention and future outlook

The use of PCM in opaque building envelopes has traditionally been focussed in intrinsic controlled systems (passive systems). In such systems, the PCM is passively charged and discharged by either solar energy/external temperature or an internal heat source in order to reduce the energy demand of the building and/or improve the thermal comfort. However, such systems require of very specific designs to achieve a suitable performance and, thus, difficult the design process and the PCM selection. For operating conditions different from the design ones (different weather conditions, use and occupation of the building, etc.), the behaviour of the PCM will change, and its phase change temperature may not be suitable anymore, reducing or even eliminating its benefits.

Moreover, the accuracy of the building model as a whole dramatically affects the behaviour of the PCM. Accumulated errors in the building model result in PCM requirements (such as phase change temperature) that may not be accurate enough, resulting in inefficient designs.

Additionally, the possibility to recharge the PCM in such applications is sometimes limited, which limits the potential benefits of the system. Therefore, extrinsic control systems (active systems) are advisable in order to solve some of these problems.

Finally, other important issues in the simulation of the PCM are still to be solved. The inclusion of some physical phenomena such as hysteresis, supercooling, and aging must be considered in the development of new models.



## References

- Cabeza, L.F., Castell, A., Barreneche, C., de Gracia, A., Fernández, A.I. (2011). Materials used as PCM in thermal energy storage in buildings: A review. *Renewable and Sustainable Energy Reviews* 15, 1675–1695. doi:10.1016/j.rser.2010.11.018.
- Ed. Cabeza. (2015) *Advances in Thermal Energy Storage Systems. Methods and Applications*. Woodhead Publishing. ISBN: 978-1-78242-088-0.
- de Gracia, A., Navarro, L., Castell, A., Ruiz-Pardo, A., Álvarez, S., Cabeza, L.F. (2013). Thermal analysis of a ventilated facade with PCM for cooling Applications. *Energy and Buildings* 65 (2013) 508–515. doi.org/10.1016/j.enbuild.2013.06.032.
- de Gracia, A., Navarro, L., Castell, A., Cabeza, L.F. (2015a). Energy performance of a ventilated double skin facade with PCM under different climates. *Energy and Buildings* 91 (2015) 37–42. doi.org/10.1016/j.enbuild.2015.01.011.
- de Gracia, A., Fernández, C., Castell, A., Mateu, C., Cabeza, L.F. (2015b). Control of a PCM ventilated facade using reinforcement learning techniques. *Energy and Buildings* 106 (2015) 234–242. doi.org/10.1016/j.enbuild.2015.06.045
- Dolado, P., Lázaro, A., Marín, J.M., Zalba, B. (2011). Characterization of melting and solidification in a real scale PCM-air heat exchanger: Numerical model and experimental validation, *Energy Conversion and Management* 52 (4), 1890-1907. doi.org/10.1016/j.enconman.2010.11.017
- Hu, H., Argyropoulos, S.A. (1996). Mathematical modelling of solidification and melting: a review. *Modelling Simulation Material Science and Engineering* 4, 371–396.
- Kuznik, F., Virgone, J., Johannes, K. (2010). Development and validation of a new Trnsys Type for the simulation of external building walls containing PCM. *Energy and Buildings* 42(7), 1004-1009. doi.org/10.1016/j.enbuild.2010.01.012
- Kuznik, F., Virgone, J. (2009). Experimental investigation of wallboard containing phase change material: Data for validation of numerical modeling. *Energy and Buildings* 41 (5), 561-570. doi.org/10.1016/j.enbuild.2008.11.022
- Navarro, L., de Gracia, A., Colclough, S., Browne, M., McCormack, S.J., Griffiths, P., Cabeza, L.F. (2016a). Thermal energy storage in building integrated thermal systems: A review. Part 1. active storage systems. *Renewable Energy* 88, 526-547. doi.org/10.1016/j.renene.2015.11.040
- Navarro, L., de Gracia, A., Niall, D., Castell, A., Browne, M., McCormack, S.J., Griffiths, P., Cabeza, L.F. (2016b). Thermal energy storage in building integrated thermal systems: A review. Part 2. Integration as passive system. *Renewable Energy* 85, 1334-1356. doi.org/10.1016/j.renene.2015.06.064
- Tabares-Velasco P.C. (2012). Verification and validation of EnergyPlus phase change material model for opaque wall assemblies. *Building and Environment* 54, 186-196. doi.org/10.1016/j.buildenv.2012.02.019
- Voller, V.R. (1997). An overview of numerical methods for solving phase change problems, in Minkowycz, W.J. and Sparrow, E.M. (Eds), *Advances in Numerical Heat Transfer*, Vol. 1, Taylor & Francis, Basingstoke.



Fire And Police Station / Sauerbruch Hutton Architects (image: M. Brzezicki)

# 8 Computational performance prediction of phase change materials in transparent components

Francesco Goia, Norwegian University of Science and Technology (NTNU)

## 8.1 Phase Change materials in transparent components for high-performance buildings

Phase Change Materials (PCM) are materials that exhibits a phase change (usually the solid-to-liquid transition in building applications) within a desired temperature range, suitable to exploit the latent heat of the phase change for thermal energy storage purpose. Most often PCM are employed in opaque building envelop components (see the dedicated paper on computational performance prediction of phase change materials in opaque components for more information and references on materials, systems by Castell et. al.).

However, R&D is also focusing on application of PCM in transparent building components. The main aim of this application is to increase the thermal inertia of glazed components and to improve the overall performance of glazed components in terms of energy and comfort. In other words, this concept is aimed at better managing the direct solar gain (that can cause overheating problems) and at minimizing the heat loss, thanks to the buffer effect provided by the PCM layer, but still allowing the exploitation of daylighting. The PCM layer is used to absorb and store (thanks to the latent heat) the large part of the short-wavelength infrared (SWIR) radiation, near infrared (NIR) radiation and part of the visible (VIS) radiation, and to let part of the VIS radiation enter the indoor environment in order to provide daylighting.

There exist very few commercially available products that integrate PCMs into a transparent building envelope system. Applications of these products have been primarily seen in cold-dominated climates, with the aim of improving solar energy exploitation for space heating purpose.

## 8.2 Simulation requirements

Phase change materials integrated in transparent building envelope components have an impact on thermal and visual performance of a building. In comparison to simulation requirements for PCM in building opaque components (c.f. Chapter 8), the performance simulation of transparent components requires advanced knowledge of the optical (in the solar spectrum range) properties of the simulated PCM layer.

In addition to a temperature dependent enthalpy curve to account for the phase change on the thermal side (or alternative approaches to model the phase change, such as for example the effective heat capacity method), optical properties such as solar/light transmittance, absorptance and reflectance need to be defined as temperature (and angular) dependent quantity (Figure 1), as they radically change between the solid state and the liquid state of aggregation. This requirement

poses quite a few challenges in terms of characterization of these quantities and reliability of data to be used as input in the simulation tool.

The most accurate approach to the simulation of the heat transfer phenomena in a semi-transparent component requires the (analytical, where possible, or numerical) solution of the general form of the radiative transfer equation (RTE) (Ishimaru, 1978), which accounts for the attenuation of the radiation caused by the absorption and the scattering within the layer, the increased radiation in the selected direction due to the scattering phenomenon, and the source term due to emission (the latter part can be usually neglected). The full set of (wavelength-dependent) material properties that affects the problem includes: the absorption coefficient and the scattering coefficient (which give, together, the extinction coefficient), the emissivity, and the phase function (which gives the probability that radiation with a certain propagation direction is scattered into the solid angle along that direction). The solution of the equation is rather complicated and some simplifications are often employed (e.g. adopting the diffusion approximation) to decrease the complexity of the system. However, even with these simplifications, the numerical solution of RTE under dynamic boundary conditions, which includes a phase change, is clearly not suitable for integration in software tools for building performance simulation.



Figure 1 - Appearance of a double glazed unit filled with PCM when in solid state (left) and in liquid state (right), together with the spectral transmittance in the solar range for the two states of aggregation. Source: Goia et al. (2015).

Furthermore, in case of PCMs, the optical properties of the materials across the phases of aggregation represent an additional challenge in the simulation, as the change is quite drastic between the solid phase and the liquid phase. Moreover, it is important to highlight that the aggregation process leading to the solid state is highly dependent on a large series of conditions (e.g. nucleation sites) that are almost impossible to foresee with high accuracy, and that leads to a behavior that is highly inhomogeneous and, to some extent, with low repeatability (Goia et al. 2015).

Aside from the replication of the optical part of the problem, the simulation of the behavior of PCM in a transparent component also requires a suitable modelling of the dynamic of the melting and solidification process, and heat transmission through the material. These phenomena can only be replicated by using rather articulated modelling approaches (among which the most common are the effective capacity method and the enthalpy method (Voller 1997) and numerical methods, as already highlighted for the PCM in opaque components).

Following the example of PCM in opaque components, the possibility to simulate an adequate range of control strategies is also of great importance for the simulation of PCM systems. In particular, when it comes to PCM integrated in transparent components, the main requirement is associated to the control of shading devices and/or the possibility to replicate systems capable of changing the solar transmission/absorption properties  $m$  – for example to couple a PCM layer to a shading system (Manz et al. 1997), or to combine a PCM layer with a smart glass pane (Bianco et al. 2017a, 2017b).

### 8.3 Implementations in building performance simulation software

As highlighted in the previous section, the computational performance prediction of PCM in transparent systems is far from being a straightforward problem because of the interaction of two already complicated models – the optical and the thermal model. When it comes to the thermal model, references are made herewith to the paper by Castell et. Al. Instead, when it comes to the optical model, it is a very common procedure to treat the PCM layer as a “conventional”, homogenous optical material characterized by optical properties (solar/light transmittance, reflectance, absorbance) that depend on the temperature of the bulk material (used as a probe for the state of aggregation of the PCM). Such a simulation approach requires particularly robust dataset for optical properties of PCM layers, since the optical behavior of the PCM is not replicated in the simulation tool, but “hidden” in the experimental data that are used as input parameter in the numerical model.

When integrated in transparent or semi-transparent components exposed to solar radiation, non-linearity is also seen in the optical properties of the PCM layer, which become an important variable in the simulation as they determine the interaction with the solar radiation – and ultimately most of the amount of solar energy intercepted by the layer. In general, the optical behavior of these systems can be modelled with different degrees of accuracy, ranging from the solution of the full radiative heat transfer equation (Ishimaru, 1978) with the 3-flux approximation (Weinläder et al. 2005) by use of a scaling concept (McKellar and Box, 1981), to modelling strategies that reduce the computational effort in the simulation by always treating the PCM layer as a non-diffuse medium (Goia et al 2012, Gowreesunker et al 2013, Li et al. 2016, Liu et at. 2016) – but incorporating the complexity of the optical behavior in the solar coefficient used in the models. These optical properties need anyway to be temperature dependent.

Modelling based on raytracing techniques through the bulk material (and in the adjacent room) are mandatory when detailed daylighting analysis (both in terms of natural light distribution and of visual comfort) are to be carried out. In these cases (Giovannini et al. 2017), the full set of optical properties for the solar range (i.e. the absorption coefficient, the scattering coefficient, which give, together, the extinction coefficient and the phase function, which gives the probability that radiation with a certain propagation direction is scattered into a certain solid angle around the direction) are necessary. Alternatively, the uses of experimentally characterized (Andersen et al. 2005) Bidirectional (Optical) Distribution Functions (in the visible range) can represent a suitable alternative that reduces the simulation complexity by avoiding the modelling of the light rays paths within the bulk of the material.

Further assumptions on the optical properties of the PCM layer, supported by spectrophotometric analysis (Goia et al. 2015), may lead to consider a PCM layer with a thickness greater than few mm as a perfectly diffusive material, when in solid state, and as a fully homogeneous and non-scattering material, when in liquid state. In such an approach, the modelling the PCM layer can be carried out by considering it as a Lambertian surface (in solid and musky state) and a conventional non-scattering material when in liquid state (Giovannini et al. 2017).

However, it is necessary to highlight that there is currently no software for building performance simulation that integrates, in a publicly available release, a module, routine, algorithm or any other procedure to allow the simulation of PCM in transparent components.

There are not evidences in the literature of the direct modelling of transparent systems incorporating PCMs in the most common software tools for building performance simulation.



A Matlab-based model of a PCM layer within a double skin façade has been coupled with TRNSYS to replicate the behavior of this advanced façade solution (Elagra et al. 2016, 2017), though through the so called “ping-pong” coupling (Hensen 1999) implemented by means of Type 155. Furthermore, given the possibility to compile an on-purpose Type, it seems reasonable to expect that a dedicated Type could be developed in the future, based on the different numerical models available in literature for PCM glazing systems.

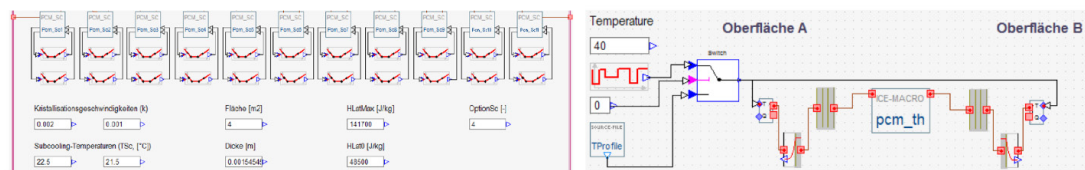

Figure 2 - Screenshots of the custom model implemented in IDA-ICE for the simulation of a PCM glazed unit. Source: Plüss et al. (2014).

No example of models or approaches developed in the EnergyPlus environment are currently seen in the literature. The so-called Conditioned Cavity Method (Kendrick & Walliman 2007) might be used in combination with EMS functions and glass panes characterized by (controllable) dynamic optical properties, as a suitable strategy to carry out this modelling. However, the complexity of such an approach would probably be very high and some intrinsic limitations in EnergyPlus might limit the verifications of the results too. The Conditioned Cavity Method could also be a possible way to model transparent PCM systems with ESP-r and with IES-VE, even if it does not seem that attempts to carry out this modelling in any of these simulation environments were carried out.

For the time being, the only published simulation approach that integrates a PCM transparent layer in a whole building simulation tool is custom model for IDA-ICE developed and validated by Plüss et al. (2014), and used to estimate the effect of PCM transparent glazed system by Bionda et al. (2015). This model is the only known model to replicate PCM in transparent envelope components that is integrated (though through a custom version) in a software for BPS. The model, written in NMF, uses a 1-D formulation, discretizing the PCM layer into 11 layers (Figure 2), and is aimed at accurately representing sub-cooling effects (as it was developed to reproduce the behavior of a salt hydrate-based system), based on the equivalent capacity method. The optical part of the model is based on the work developed by Weinläder and co-authors (Weinläder 2003; Weinläder et al. 2015).

## 8.4 Validation

The largest majority of the research activities available in the literature on transparent PCM systems is carried out either through experimental activities, or through in-house, on-purpose developed numerical models (and very often by a combination of the two methods). This is, for example, the approach used in some of the first activities within this field (Manz et al. 1997; Weinläder et al. 2005) but also still used in the latest research activities (Goia et al. 2012; Gowreesunker et al. 2013, Liu et al. 2018).

It is common that simulation activities base on on-purpose developed numerical models are coupled with validation of the numerical tool. Examples of combined model development and experimental validation of numerical tools are reported in Manz et al. (1997), Weinläder et al. (2005), Goia et al. (2012), Plüss et al. (2014), Zhong et al. (2015), Li et al. (2016), Liu et al. (2016).

## 8.5 Points of attention and future outlook

Simulation of translucent building components integrating PCMs has gained momentum in the last ten years, though this type of application has been investigated in the last twenty-five years, both numerically and experimentally.

Presently, there is not a easily accessible model/algorithm for the simulation of such systems in a whole building performance simulation tool. This is probably because these applications are not gaining popularity and only few products are available, and have been used in few project. Traditionally, the development of building performance simulation tools usually follows the spread of a building technology or system, in order to enable professionals to design and assess the systems when integrated into the entire building energy concept. For this reason, it is realistic to expect that the implementation of models for transparent PCM-based systems in BPS tools will not be fostered until the technology has not reached a sufficient diffusion in the building sector.

On the other hand, there is a relatively long list of (more or less) available numerical modelling approaches to replicate the behavior of translucent PCM-based systems. These models have been published in the scientific literature and have been used to investigate the performance of these systems under different configurations or boundary conditions.

Models developed so far are all 1-D, but PCM-based systems also show high inhomogeneity in the behavior, especially when it comes to the optical behavior of different regions of the components. For example, it is common that the melting process is completed first along the edges of the system, due to the higher heat transfer rate in that region. Conversely, the solidification process might start relatively randomly in different areas of the components, depending on kinetic aspects that are impossible to predict. These limitations lead to the fact that the simulation only can represent the “average” behavior of the component (hence the reason to develop monodimensional model for the time being).

Future research direction might include the understanding of the need to scale up to a 2-D (or even 3-D) model to better replicate the entire performance of the system.

Investigations on the impact of PCM systems on different domain than the thermal energy performance (and thermal comfort performance), such as daylighting and visual comfort might also require the development of more detailed models to take into account the radiative heat transfer within the material using raytracing techniques.

## References

- Andersen, M., Roecker, C., Scartezzini, J. L. (2005). Design of a time-efficient video-goniophotometer combining bidirectional functions assessment for transmission and reflection. *Solar Energy Materials and Solar Cells* 88(1), 97-118. Doi: 10.1016/j.solmat.2004.10.009
- Bianco, L., Cascone, Y., Goia, F., Perino, M., Serra, V. (2017a). Responsive glazing systems: Characterisation methods and winter performance. *Solar Energy*, 155, 372–387
- Bianco, L., Cascone, Y., Goia, F., Perino, M., Serra, V. (2017b). Responsive glazing systems: Characterisation methods, summer performance and implications on thermal comfort. *Solar Energy*, 158, 819–836.
- Castell, A., Medrano, M., Vall, S. (2017) Computational performance prediction of phase change materials in opaque components. COST Action TU1403 – WG2

- Elarga, H., Goia, F., Zarrella, A., Dal Monte, A., Benini, E. (2016). Thermal and electrical performance of an integrated PV-PCM system in double skin façades: A numerical study. *Solar Energy* 136, 112-124.
- Giovannini, L., Goia, F., Lo Verso, V.R.M., Serra, V. (2017). Phase Change Materials in glazing: implications on light distribution and visual comfort. *Energy Procedia* 111, 357–366.
- Goia, F., Perino, M., Haase, M. (2012). A numerical model to evaluate the thermal behaviour of PCM glazing system configurations. *Energy and Buildings* 54, 141–153.
- Goia F., Zinzi, M., Carnielo, E., Serra, V. (2015). Spectral and angular solar properties of a PCM-filled double glazing unit. *Energy and Buildings* 87, 302–312.
- Gowreesunker, B.L.; Stankovic, S.B.; Tassou, S.A.; Kyriacou, P.A. (2013). Experimental and numerical investigations of the optical and thermal aspects of a PCM-glazed unit. *Energy and Buildings* 61, 239–249.
- Hensen, J.L.M. (1999). A comparison of coupled and de-coupled solutions for temperature and air flow in a building. *ASHRAE Transactions* 105 (2), 962–969.
- Ishimaru, A. (1978). Wave propagation and scattering in random media. In: *Single Scattering and Transport Theory*, 1. Academic Press, California, USA.
- Kendrick, C., Walliman, N. (2007). Removing unwanted heat in lightweight buildings using phase change materials in building components: Simulation modelling for PCM plasterboard. *Architectural Science Review* 50(3), 265-273.
- Li, D., Ma, T., Liu, C., Zheng, Y., Wang, Z., Liu, X. (2016). Thermal performance of a PCM-filled double glazing unit with different optical properties of phase change material. *Energy and Buildings* 119, 143-152.
- Liu, C., Zheng, Y., Li, D., Qi, H., Liu, X. (2016). A Model to Determine Thermal Performance of a Non-ventilated Double Glazing Unit with PCM and Experimental Validation. *Procedia Engineering* 157, 293-300.
- Liu, C., Wu, Y., Zhu, Y., Li, D., Ma, L. (2018). Experimental investigation of optical and thermal performance of a PCM-glazed unit for building applications. *Energy and Buildings* 158, 794-800.
- Manz, H., Egolf, P., Suter, P., Goetzberger, A. (1997). TIM-PCM external wall system for solar space heating and daylighting. *Sol. Energy* 61, 369–379.
- McKellar, B.H.J., Box, A.M. (1981). The scaling group of radiative transfer equation. *Journal of Atmospheric Science* 38, 1063–1068.
- Plüss, I., Kräuchi, P., Bionda, D., Schröcker, M., Felsenstein, S., Zweifel, G. (2014). Modellbildung eines Phasenwechsel-fassadenelements in IDA-ICE. *Proceedings of BAUSim: Fifth German-Austrian IBPSA Conference RWTH Aachen University* (paper 1166, 1-5) (in German).
- Voller, V.R. (1997). An overview of numerical methods for solving phase change problems, in Minkowycz, W.J. and Sparrow, E.M. (Eds), *Advances in Numerical Heat Transfer*, Vol. 1, Taylor & Francis, Basingstoke.
- Weinläder, H. (2003). Optical characterization of phase change materials for daylighting. *Dissertation Julius-Maximilians-Universität Würzburg* (in German).
- Weinläder, H., Beck, A., Fricke, J. (2005). PCM-facade-panel for daylighting and room heating. *Solar Energy* 78, 177–186.
- Zhong, K., Li, S., Sun, G., Li, S., Zhang, X. (2015). Simulation study on dynamic heat transfer performance of PCM-filled glass window with different thermophysical parameters of phase change material. *Energy and Buildings* 106, 87-95.

# 9 Computational performance prediction of Double-Skin Ventilated Facade

Olena Kalyanova Larsen, Mingzhe Liu; Aalborg University

## 9.1 Double-skin ventilated façade for high-performance buildings

Double-skin ventilated façade (DSVF) is normally associated with a façade construction that consists of two layers of fenestration (glass skins) separated by a ventilated air gap (cavity). Different types of DSVFs can be found in the literature and in practice. This is due to multiple options available in the façade design and operation. For instance, the geometry of the facade (narrow/wide cavity), choice of fenestration system, ventilation concept, etc. determine the generic performance of the system. Classification structure for various types of double-façade constructions is suggested by several authors (Saelens, 2002, Arons & Glicksman, 2001), meanwhile, DSVFs are often classified according to the origin and destination of the air in the cavity (Loncour, Deneyer, Blasco, Flamant, & Wouters, 2004). An outline of buildings with double-skin facades is provided by Poirazis (Poirazis, 2006).

The main topic of scientific research on double-skin façades consists of the assessment of the thermal field within the air gap (Baldinelli, 2009), which involves a large number of parameters, namely, solar radiation intensity, ventilation rate in the cavity, nature of the driving forces, outdoor air temperature, presence of solar shading device, etc. Therefore the modeling approach for this type of envelope must accommodate the following areas: the optics of layer sequence, thermodynamics and fluid dynamics in the cavity (Manz & Frank, 2005).

A possibility of integration a shading device within the cavity is seen as one of the advantages of DSVF systems (Barbosa & Ip, 2014). However, performance assessment of DSVF with the presence of solar shading device is considerably more difficult (Dijk and Oversloot, 2003).

## 9.2 Simulation requirements

Thermodynamics, fluid dynamics and optics require particular attention when designing buildings with DSVF envelope (Manz & Frank, 2005). At this point, the airflow rate, induced by natural driving forces is vital for performance evaluation of ventilated envelopes but remains challenging within the field of building physics. Similarly, the knowledge within the flow pattern, temperature distribution and the convective heat exchange in the cavity is not yet sufficient (Kalyanova, 2008).

Dynamics of DSVF systems must be addressed in the simulation tools (Dama & Angeli, 2015). In particular, if they are naturally ventilated. This is due to significant fluctuations in the airflow rate of high magnitude compared to the volume of the cavity (Kalyanova, Jensen, & Heiselberg, 2007).

Finally, not one, but several mathematical models, developed for specific operational modes of DSVF are required in order to describe a broad range of DSVF performance within one simulation tool.

### 9.3 Implementations in building performance simulation software

Normally, commercial building simulation software tools do not include a general purpose model for simulation of DSVF or similar systems. In most of the cases, users of these software tools build a model representing the performance of such an envelope system to the best of their knowledge. An example of such exercise can be found between the DSVF models developed in the framework of IEA SHC Task 34 /ECBCS Annex 43 “Testing and Validation of Building Energy Simulation Tools”. DSVF model in external air curtain, transparent insulation and preheating mode (Error! Reference source not found.) were built using ESP-r, IDA ICE 3.0, VA114, TRNSYS-TUD and BSim tools (Kalyanova et al., 2009).

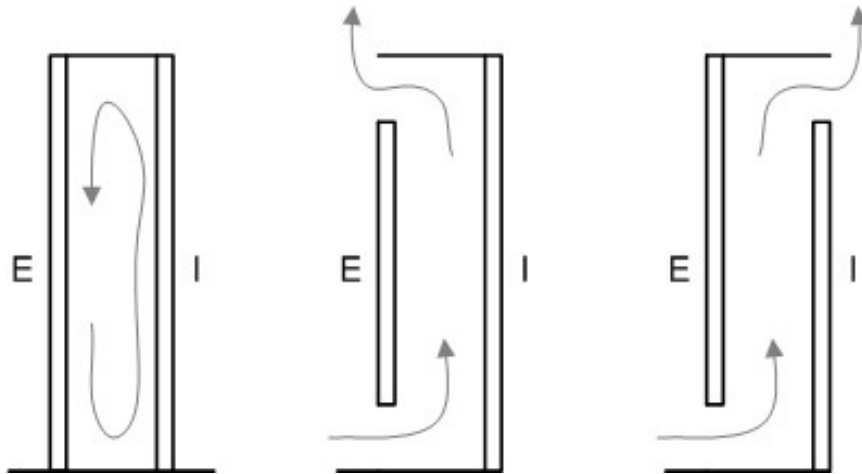

Figure 1 - Transparent insulation mode (left), external air curtain mode (centre) and preheating mode (right).

Modeling DSVF systems using commercial tools within the Annex 34/43 demonstrate that performance evaluation of ventilated façade is a difficult task which can be facilitated if general or application based models are introduced within the software tools.

In Annex 34/43 modeling exercise, the heat flux through the internal skin of DSVF was frequently underestimated (compared to experimental data), which is most likely explained by:

- underestimation of DSVF cavity air temperature
- errors in the prediction of cavity mass flow rate for naturally ventilated cavity
- underestimation of solar gains to DSVF and/or the room behind the facade

These challenges, to some extent can be resolved if the DSVF cavity in the model is split into several thermal zones for improved calculation of vertical temperature gradients; thermal model addresses convective and flow regimes in the cavity, as well as dynamics of DSVF processes; natural ventilation model is adjusted for application with ventilated façades.

Looking upon numerical models for performance simulation of ventilated façade (application oriented models), a recent review by De Gracia and coauthors (De Gracia, Castell, Navarro, Oró, & Cabeza, 2013) provides the state of the art within the topic.



## 9.4 Validation

There have been many validation studies that have helped to increase confidence in the use of existing design tools for the performance assessment of conventional buildings, but their accuracy for prediction of ventilated façades performance has not been tested to the same extent (Kalyanova et al., 2009).

Until now, the attempts to validate building simulation tools for DSF modeling purposes have been limited, many of them are known as validation of models for specific case studies (Mei, Infield, Eicker, & Fux, 2003; Takemasa et al., 2004; von Grabe, 2002). In the literature, these are explained by the lack of experimental data and difficult measurements, which do not allow performing accurate validation (Gertis, 1999).

An empirical validation of building models with DSFV, performed with various building simulation tools (ESP-r, IDA ICE 3.0, VA114, TRNSYS-TUD and BSim) was carried out in the framework of earlier mentioned IEA SHC Task 34 /ECBCS Annex 43. The experimental data for the validation was gathered in a full-scale outdoor test facility (Error! Reference source not found.). The empirical data sets comprise the key-functioning modes of DSF: 1. Thermal buffer mode (closed DSF cavity) and 2. External air curtain mode (naturally ventilated DSF cavity with the top and bottom openings open to outdoors).



Figure 2 - The Cube, outdoor test facility with DSFV.

In this work, the measurements of the mass flow rate and air temperatures in the cavity and adjacent zone were supported with detailed information on the input parameters for a building thermal simulation tool. The experimental data for the DSFV-buildings, contains rare results of the mass flow rate measured in a naturally ventilated cavity.

By carrying out the empirical tests, it was concluded that all models experience difficulties in predictions during the peak solar loads. None of the models was consistent enough when comparing simulation results with experimental data for the ventilated cavity. However, some models showed reasonable agreement with the experimental results for the thermal buffer mode.

## 9.5 Points of attention and future outlook

In the section of simulation requirements, the main areas that require improvement for performance

evaluation of DSVF are emphasized. These are also the focus areas of DSVF research in the recent years. Most of the researchers agree that more effort is needed in order to reach significant advances in modeling of such façade technologies.

For example, naturally ventilated façade systems are characterized by high variation in airflow magnitude, small differences in the wind pressure distribution at the openings, presence of wind washout, flow reversal and recirculation. All of these effects distinguish DSVF air flow from traditionally ventilated spaces. However, there are no models that fully address these effects in combination with highly dynamic boundary conditions and flow conditions in the cavity.

Convective heat transfer and flow pattern in the cavity are poorly studied due to high complexity in the measurement of naturally induced flow, velocity profiles and difficulties for flow visualization. There is no yet one technique that can allow flow visualization in the presence of solar radiation. On the other hand, several publications emphasize governing effect of boundary layer flow for the mass and heat transfer in DSVF cavity.

## References

- Arons, D. M. M., & Glucksman, L. R. (2001). Double skin, airflow facades: Will the popular european model work in the USA? Proceedings of ICBEST 2001, International Conference on Building Envelope Systems and Technologies, Ottawa, Canada. , vol. 1 203-207.
- Baldinelli, G. (2009). Double skin façades for warm climate regions: Analysis of a solution with an integrated movable shading system. *Building and Environment*, 44(6), 1107-1118. doi:<http://dx.doi.org/10.1016/j.buildenv.2008.08.005>
- Barbosa, S., & Ip, K. (2014). Perspectives of double skin façades for naturally ventilated buildings: A review. *Renewable and Sustainable Energy Reviews*, 40, 1019-1029. doi:<http://dx.doi.org/10.1016/j.rser.2014.07.192>
- Dama, A., & Angeli, D. (2015). Modelling mechanically ventilated double skin facades with integrated shading device. *Building Simulation 2015 : Proceedings of the 14th International Building Performance Simulation Association Conference*, Hyderabad, India.
- De Gracia, A., Castell, A., Navarro, L., Oró, E., & Cabeza, L. F. (2013). Numerical modelling of ventilated facades: A review. *Renewable and Sustainable Energy Reviews*, 22, 539-549. doi:<http://dx.doi.org/10.1016/j.rser.2013.02.029>
- Gertis, K. (1999). A critical review of double glazing facades under aspects of building physics. *German Journal Bauphysik*, 21, 54-66.
- Kalyanova, O. (2008). Double-skin facade: Modelling and experimental investigation of thermal performance (PhD Thesis). . (17).
- Kalyanova, O., Heiselberg, P., Felsmann, C., Poirazis, H., Strachan, P., & Wijsman, A. (2009). An empirical validation of building simulation software for modelling of double-skin facade (DSF). *Building Simulation 2009 : Proceedings of the 11th International Building Performance Simulation Association Conference*, Glasgow.
- Kalyanova, O., Jensen, R. L., & Heiselberg, P. K. (2007). Measurement of air flow rate in a naturally ventilated double skin facade. *Proceedings of Roomvent 2007*, Helsinki, Finland.
- Loncour, X., Deneyer, A., Blasco, M., Flamant, G. & Wouters, P. (2004). Ventiladed double facades - classification & illustration of facade concepts. Retrieved from <http://www.bbri.be/activefacades/new/download/VentiladedDoublesFacades-Classification&illustrations.dvf2-final.pdf>
- Manz, H., & Frank, T. (2005). Thermal simulation of buildings with double-skin façades. *Energy and Buildings*, 37(11), 1114-1121. doi:<http://dx.doi.org/10.1016/j.enbuild.2005.06.014>
- Mei, L., Infield, D., Eicker, U., & Fux, V. (2003). Thermal modelling of a building with an integrated ventilated PV façade. *Energy and Buildings*, 35(6), 605-617. doi:10.1016/S0378-7788(02)00168-8

- Poirazis, H. (2006). Double skin facades. A literature review. ().Lund University, Lund Institute of Technology, Department of Architecture and Built Environment.
- Saelens, D. (2002). Energy performance assesment of single storey multiple-skin facades. PhD thesis.
- Takemasa, Y., Hiraoka, M., Katoh, M., Tsukamoto, H., Tanabe, M., & Tanaka, H. (2004). Performance of hybrid ventilation system using double-skin facade and vertical airshaft. ( No. 52). Japan: Annual Report. Kajima Technical Research Institute, Kajima Corporation.
- von Grabe, J. (2002). A prediction tool for the temperature field of double facades. *Energy and Buildings*, 34(9), 891-899. doi:10.1016/S0378-7788(02)00065-8



House of Representatives (Deutscher Bundestag Office) / Lieb + Lieb Architekten BDA (image: M. Brzezicki)

# 10 Computational performance prediction of Double-Skin Opaque Ventilated Façade

Emanuela Giancola, CIEMAT

## 10.1 Double-skin opaque ventilated façade (open joint ventilated façade) for high-performance buildings

Many terms exist that are synonymous with ventilated façade, such as active façade, double envelope, rainscreen or Double-Skin Façade (DSF), the European standard EN 13119:2007 “Curtain walling. Terminology”, associates the term DSF to the existence of glass skins separated by a cavity but not to the need for a ventilated cavity. Ventilated façades with opaque cladding (OVF) are generally characterised by the presence of one continuous insulation layer next to the internal mass and another external layer of protective cladding which is fastened to the wall using mechanical systems. A naturally ventilated channel is thus created between the insulation layer and the cladding. There are two kinds of external cladding on ventilated facades: continuous (closed joint) or discontinuous (open joint). While in the case of continuous ventilated façades (closed joints) the upward flow is continuous, homogeneous and symmetrical along the wall (Patania et al., 2010), open joint ventilated façades (OJVF) are marked by localized discontinuities at the joints, which turn the flow much more complex, inhomogeneous and asymmetrical (Sanjuan et al., 2011; Giancola et al., 2012). As a result of solar radiation on the slabs and the ensuing convection within the cavity, the upward air flow creates a ventilation effect that helps removing the heat from the façades. As a consequence of this mass exchange through the openings, the heat transfer problem turns more complex: air motion and thermal field are strongly coupled and therefore highly dependent on geometric characteristics of the wall. Apart from the constructive difficulties, the existence of open joints has a great influence in the fluid and thermal behaviour of this façade system in comparison to other continuous ventilated façades, such as double glazed ventilated façades (DGVF), whose behaviour is rather well known, as detailed in the studies made by (Manz, 2009; Safer et al., 2005; Baldinelli, 2009; Fuliotto et al., 2010; Coussirat et al., 2008) among other authors.

## 10.2 Simulation requirements

OJVF have an impact on thermal performance, natural ventilation and convection. The description of the heat and mass transfer phenomena confirms the fact that the complexity of the fluid flow in the regions near the joints and along the ventilated cavity defies analytical methods, making compulsory the use of advanced fluid dynamic simulation techniques. Temperature gradients, turbulence, radiation, convection in terms of identification of the flow patterns and convective heat exchange in the cavity need to be taken into account and need to be improved like control strategies. Fig. 1 shows the most used meshing detail and the material properties generally imposed in the CFD model.



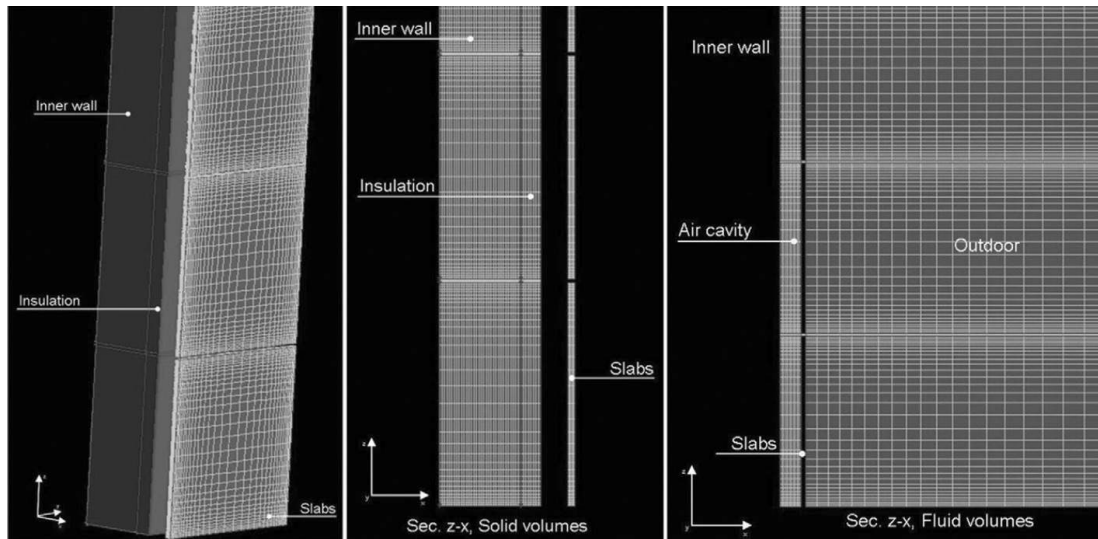

CFD model dimensions and thermal properties of façade layers (from outside to inside).

Element	$\rho$ (kg/m <sup>3</sup> )	$C_p$ (J/kg/K)	$K$ (W/m K)	Thickness (m)	Emissivity
Slabs	2800	1000	3.5	0.01	0.9
Air	1.145	1010.17	0.025	0.04	
Insulation	40	1674	0.029	0.03	0.85
Brick wall	1800	840	0.52	0.12	
Gypsum	1800	831	0.81	0.001	

Figure 1 - CFD model domain. Meshing details and material properties of the CFD model. (Giancola, 2012).

### 10.3 Implementations in building performance simulation software

The current building standards consider this façades, by default, as ordinary ventilated or slightly ventilated air chamber façades without taking into account their fluid behaviour. Griffith, 2006 proposed a model that was later adopted by the Energy Plus simulation package. Moreover, the commercial building energy simulation software such as VisualDOE, TRNSYS or Energy Plus has not yet included a general purpose model to simulate these façade systems. As a consequence, its actual fluid dynamic behaviour and its performance in terms of energy saving and comfort conditions is not yet sufficiently known.

Inside the ventilated cavity of an OJVF, and although the exterior coatings are made of opaque materials, a non negligible part of the heat transfer is produced by radiation exchange. For this reason it is very important to select the most adequate model. The existing simulation models of OJVF is based in previous works of Sanjuan et al., 2011; Giancola et al., 2012 and González et al., 2008. According to those and Coussirat et al., 2008 the Discrete Ordinates (DOs) model (Chui and Raithby, 1993) is the better choice to model the radiation. The DO radiation model meets the following requisites: air as participating medium in the radiative balances, take into account wall emissivities, allow to model semi-transparent walls, impose radiation boundary conditions, use of internal heating sources, and the radiation division in different length wave intervals to differentiate the long and short wave percentage of incoming radiation. These features allow introducing the incident radiation on the façade slabs in two different ways: (a) by including the absorbed radiation as an internal source of the slabs, or (b) by entering the solar radiation into the domain by using semitransparent wall boundary conditions; solar height and diffuse fraction need to be detailed in each simulation case. The second approach has the advantage that the radiation entering the computational domain impacts not only in the facade but also in the ground, so it is possible to take

into account the radiation reflected by the ground on the façade. Turbulence effects need to be included using the RNG K-epsilon model. Sanjuan et al., 2011; Chen, 1995 and Coussirat et al., 2008 have found out that this model obtains better results than others in similar problems. The “differential viscosity” option need to be used and activated to take into account the viscosity effects for small Re numbers, and the turbulence generation due to buoyancy need to be included in the model. To minimize numerical errors, the set of equations are normally solved using a pressure-based double-precision solver, and second order upwind discretization schemes are imposed on all the transport equations. Gravitational body forces is included within the momentum equation (Coussirat et al., 2008), using the Boussinesq approximation (Gray and Giorgini, 1976) to model buoyancy effects. This approximation assists the convergence of the solution when free convection is the main force driving the fluid, and helps to reduce computation time. To calculate the heat transfer to the room (building interior) a convective boundary condition need to be set, corresponding to indoor air flow conditions according to the ASHRAE. Fig. 2 shows a sketch of the most used boundary conditions and the energy performance of an OJVF during winter and summer time.

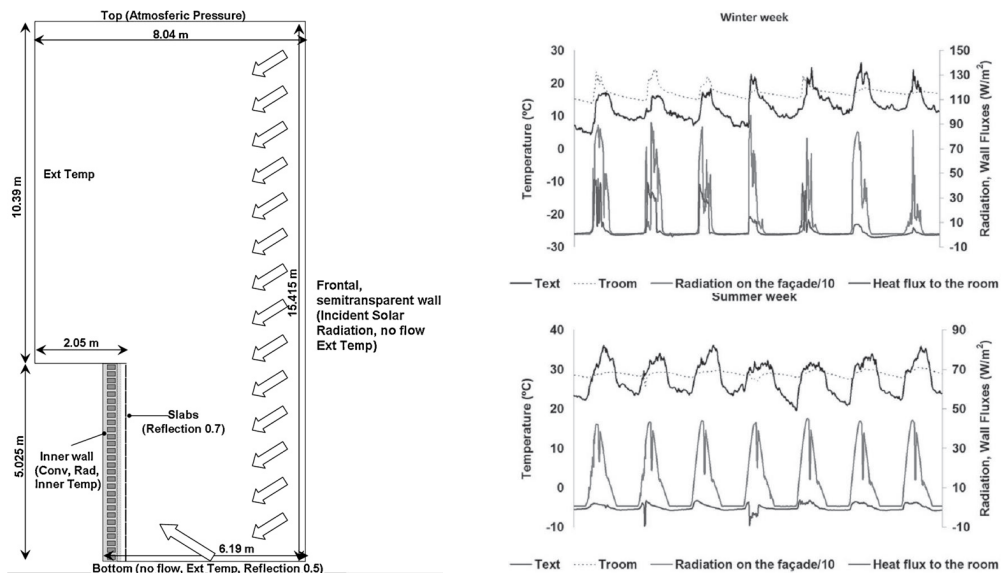

Figure 2 - CFD model domain. Dimensions and boundary conditions and energy performance of an OJVF during winter and summer time (Giancola, 2012).

## 10.4 Validation

Even if a large number of papers have been focused on the numerical thermal analysis of the ventilated façades (Peci López et al., 2012; Mootz and Bezia, 1996; Soto et al., 2013) large discrepancies there exist between the numerical predictions and the experimental results and this point demonstrates that the performance of this kind of wall is generally difficult to predict due to the strong influence of many external parameters, like the variable outdoor conditions, the air flow pattern configurations, the variable radiative behaviour of the external and internal surfaces.

Simulation models were validated with experimental data by Sanjuan et al., 2011 and Sanchez et al., 2013. The authors tested several turbulence and radiation models available in the commercial computational fluid dynamic codes and compared the results to particle image velocimetry (PIV) measurements in laboratory conditions. Regarding measurements in real buildings, Marinosci et al., 2011 investigated experimentally and numerically the thermal behaviour of a real OJVF in winter

conditions. The authors performed temperature, radiation, and velocity measurements in an OJVF. The modelling of the façade was made using the software ESP-r and three different air flow nodal network models were tested. However, the good agreement was restricted to conditions of calm wind, and important deviations were found between experimental and numerical results for windy conditions. To improve the limited experimental data available in the literature in the work of Giancola et al., 2012 an OJVF has been monitored in a location characterized by very high levels of solar radiation, hot summers and warm winters. Experimental data based on temperature, heat fluxes, and radiation along the façade, have been collected during one year, the monitoring campaign data was used to validate a simplified CFD model, under quasi-stationary conditions. Using this model, two different treatment of solar radiation have been tested, one based on previous numerical studies on OJVF, and another considering the zenith and the azimuth angles of the incident radiation; as shown in Fig. 3.

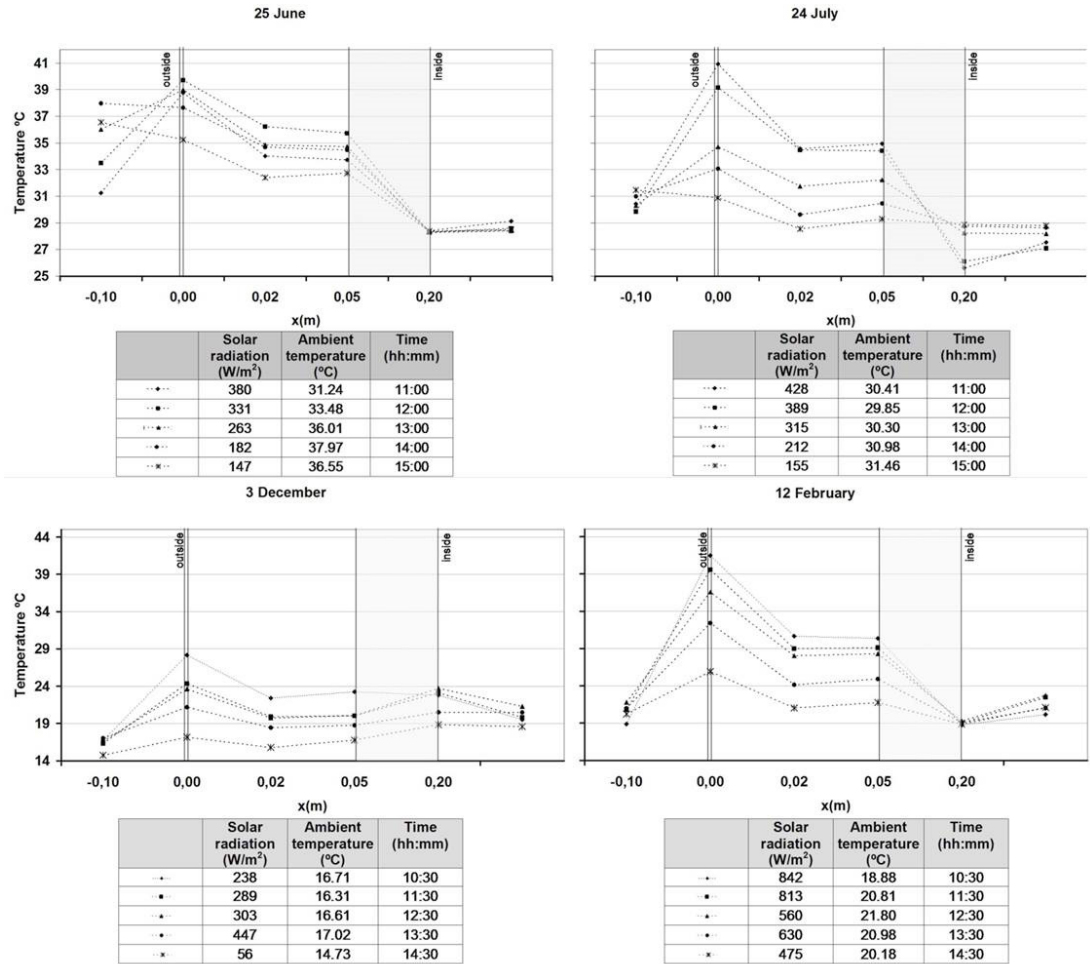

Figure 3 - Trend of measured temperature in the different layers of OJVF for different hours, different outdoor radiation and temperature conditions. Summer and winter conditions (Giancola, 2012).

### 10.5 Points of attention and future outlook

Dynamic behaviour and performance in terms of energy saving and comfort conditions of OJVF are not yet sufficiently known. For these reasons, an extensive research of the thermal and fluid behaviour of open joint ventilated façades is thus required in order to turn into reality the claimed

advantages (their ability to reduce cooling thermal loads) of these construction systems. Parametrical studies can provide some valuable information (mass flow through the joints, ventilation mass flow and pressure profiles) that could serve as benchmarking data to validate other models such as those already developed to calculate double glazed ventilated façades: models based on energy balances (analytical like in Von Grabe, 2002; adimensional like in Balocco, 2004 or lumped models like in Park et al., 2004), models based on nodal airflow networks, or models based in control volume discretization. The wind influence has normally not been taken into account because, from the design point of view, that is the worst condition for ventilated facades (Nore et al., 2010 and Defraeye et al., 2011). It is not always possible to perfectly integrate the control of OJVF with the control of HVAC.

## References

- ASHRAE Fundamentals Handbook (S.I.), American Society of Heating, Refrigerating and Air Conditioning Engineers Inc., 1985.
- Baldinelli, G. (2009). Double skin facades for warm climate regions: analysis of a solution with an integrated movable shading system, *Building and Environment*, 44 (6), 1107–1118.
- Balocco, C. (2004). A non-dimensional analysis of a ventilated double façade energy performance, *Energy and Buildings*, 36, 35–40.
- Chen, Q. (1995). Comparison of different  $\epsilon$ - $\epsilon$  models for indoor airflow computations, *Numerical Heat Transfer, Part B*, 28, 353–369.
- Chui, E.H., Raithby, G.D. (1993). Computation of radiant heat transfer on a nonorthogonal mesh using the finite-volume method, *Numerical Heat Transfer, Part B*, 23, 269–288.
- Coussirat, M., Guardo, A., Jou, E., Egusquiza, E., Cuerva, E., Alavedra, P. (2008). Performance and influence of numerical sub-models on the CFD simulation of free and forced convection in double-glazed ventilated facades, *Energy and Buildings*, 40, 1781–1789.
- Defraeye, T., Blocken, B., Carmeliet, J. (2011). Convective heat transfer coefficients for exterior building surfaces: existing correlations and CFD modelling. *Energy Conversion and Management* 52, 512-22.
- EUROPEAN STANDARD, Curtain Walling-Terminology. EN 13119, European Committee For Standardization, Brussels, Belgium, 2007.
- Fuliotto, R., Cambuli, F., Mandas, N., Bacchin, N., Manara, G., Chen, Q. (2010). Experimental and numerical analysis of heat transfer and airflow on an interactive building façade, *Energy and Buildings*, 42, 23–28.
- Giancola, E., Sanjuan, C., Blanco, E., Heras, M.R. (2012). Experimental assessment and modelling of the performance of an open joint ventilated façade during actual operating conditions in mediterranean climate. *Energy and Buildings*, 54, 363-75.
- González, M., Blanco, E., Pistono, J. (2008). Adjusting an energy simulation model by means of CFD techniques to analyze open-joint ventilated façades energy performance, in: *Proceedings of WREC08, World Renewable Energy Congress X and Exhibition, Glasgow, Scotland, United Kingdom*.
- Gray, D.D., Giorgini, A. (1976). The validity of the Boussinesq approximation for liquids and gases, *International Journal of Heat and Mass Transfer*, 19, 545–551.
- Griffith, B. (2006). A model for naturally ventilated cavities on the exteriors of opaque building envelopes, in: *Proceedings of SIMBUILD2006, Cambridge- Massachusetts, USA*.
- Manz, H. (2009). Airflow patterns and thermal behaviour of mechanically ventilated glass double façades, *Building and Environment*, 39, 1023–1033.
- Marinossi, C., Strachan, P.A., Semprini, G., Morini, G.L. (2011). Empirical validation and modelling of a naturally ventilated rainscreen façade, *Energy and Buildings*, 43, 853–863.
- Mootz, F., Bezia, J.J. (1996). Numerical study of a ventilated façade panel, *Sol. Energy*, 57, 29–36.

- Nore, K., Blocken, B., Thue, J.V. (2010). On CFD simulation of wind-induced airflow in narrow ventilated façade cavities: coupled and decoupled simulations and modelling limitations. *Building and Environment*, 45, 1834-46.
- Park, C.S., Augenbroe, G., Messadi, T., Thitisawat, M., Sadegh, N. (2004). Calibration of a lumped simulation model for double-skin façade systems, *Energy and Buildings*, 36, 1117–1130.
- Patania, F., Gagliano, A., Nocera, F., Ferlito, A., Galesi, A. (2010). Thermofluid-dynamic analysis of ventilated facades, *Energy and Buildings*, 42, 1148– 1155.
- Peci López, F., Jensen, R.L., Heiselberg, P., Ruiz de Adana Santiago, M. (2012). Experimental analysis and model validation of an opaque ventilated façade, *Build. Environment*, 56, 265–275.
- Safer, N., Woloszyn, M., Roux, J.J. (2005). Three-dimensional simulation with a CFD tool of the airflow phenomena in single floor double-skin facade equipped with a Venetian blind, *Solar Energy*, 79 (2), 193–203.
- Sánchez, N., Sanjuan, C., Suárez, M.J., Heras, M.R. (2013). Experimental assessment of the performance of open joint ventilated façades with buoyancy-driven airflow. *M. Solar Energy*, 91, 131–144.
- Sanjuan, C., Suárez, M.J., González, M., Pistono, J., Blanco, E. (2011). Energy performance of an open-joint ventilated façade compared with a conventional sealed cavity façade, *Solar Energy*, 85 (9), 1851–1863.
- Soto, V.M., Sarabia, E.J., Pinazo, J.M., Bannier, E., Cantavella, V., Silva, G. (2013). Modeling of ventilated façades for energy building simulation software, *Energy and Buildings*, 65, 419–428.
- Von Grabe, J. (2002). A prediction tool for the temperature field of double facades, *Energy and Buildings*, 34 (9), 891–899.



# 11 Computational performance prediction of ventilative cooling

Annamaria Belleri, Eurac Research

## 11.1 Ventilative cooling for high-performance buildings

Ventilative cooling refers to the use of natural or mechanical ventilation strategies to cool indoor spaces.

Adaptive facades can contribute to the overall building ventilative cooling strategies by integrating vents and openings, which can be either manually or automatically controlled.

The effective use of outside air reduces the energy consumption of ventilation and cooling systems while maintaining thermal comfort and ensuring an acceptable indoor air quality.

At building level, typical performance indicators are cooling and ventilation consumption for mechanically cooled and ventilated buildings, overheating degrees and severity for naturally ventilated buildings, air change rates and comfort related indicators.

At component level, typically openings, the performance indicators are the free area and the discharge coefficient, which determine the effective opening area used for airflow calculation.

## 11.2 Simulation requirements

Main important aspects to be taken into account in the models are:

- Coupling between thermal and airflow physics in dynamic mode
- Effect of material inertia
- Time steps (shall be lower than 15min)
- Room geometry
- Control strategies depending on outdoor and indoor conditions
- Reaction time of automated parts

## 11.3 Implementations in building performance simulation software

Common dynamic simulation tools (EnergyPlus, TRNSYS, ESP-r, IES, TAS, CoolVent) allow users to couple the thermal analysis with the airflow model in order to:

- consider interactions between airflow and thermal calculations;
- assess infiltration rates;
- evaluate hybrid ventilation systems.



Figure 1 - Automated openings integrated in a façade element. Source: CommONEnergy project

The coupling becomes fundamental to predict passive cooling performance, where a higher ventilation rate can avoid overheating and improve thermal comfort. Although for winter ventilation design the airflow can be considered uncoupled from the thermal behaviour of the building, for summer natural ventilation a coupled model become fundamental.

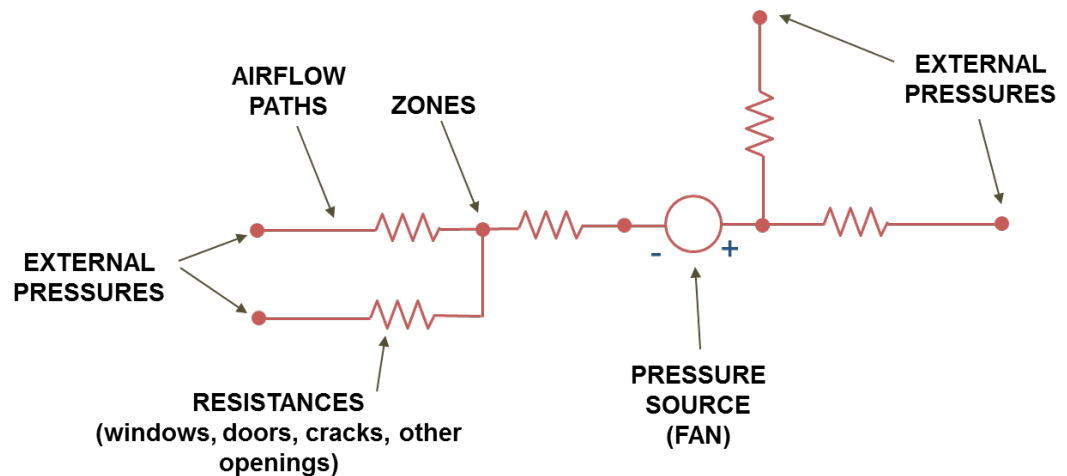

Figure 2 - Lumped parameter modelling of airflow through building zone. Source: IBPSA BemBook

Different ways exist to avoid computationally intractable fully coupled models: in the ping-pong approach, the thermal model uses the results of the airflow model at the previous time step and vice versa; in the onion approach thermal and airflow model iterate within one time step until

satisfactory small error estimates are achieved. In some instances there are multiple solutions to the coupled equations. Care must be exercised in the initial conditions to produce stable, realistic solutions.

Although the coupling allows to consider interactions between airflows and building thermal behaviour, the convection heat transfer modelling is still too simplified for night cooling effect predictions. Furthermore, models for components like wind catchers or solar chimneys are not included in the airflow network models.

## 11.4 Validation

Several previous studies attempted to evaluate airflow models reliability by comparing AirFlow Network (AFN)- Building Energy Simulation (BES) predicted and measured performances. Zhai J. et al. (2011) performed airflow models evaluations by comparing predicted airflow from EnergyPlus, CONTAM and ESP-r airflow network models with measured airflow in laboratory experiments across 8 defined scenarios at steady conditions. They concluded that all the models yielded similar airflow predictions, which are within 30% error for the simple cases evaluated. The worst results were obtained for buoyancy driven single-sided, wind driven cross ventilation and combined buoyancy and wind driven natural ventilation configuration, whereas buoyancy driven cross ventilation error is less than 10%. It is well known that airflow network models cannot generally well represent single-sided ventilation, as it is mainly driven by turbulent fluctuations of wind pressures, neglected in nodal models. Zhai et al. (2011) also compared measured indoor temperatures of three naturally ventilated buildings with detailed EnergyPlus model output data. The EnergyPlus model performed excellently for simple and well defined cases, but less accuracy is observed in cases with complex geometry. Due to the lack of available information (on site measured weather data, measured volume flow rates, level of thermal mass, effective area and discharge coefficient of openings, wind pressure coefficient data), it was not possible to assess the accuracy of model coupling. Belleri et al. (2014) compared early-design-stage natural ventilation performance predictions from an EnergyPlus model with measured data including on-site weather and measured air change rates. Airflow predictions were highly sensitive to input parameters like internal gains, occupancy profile and of course to window opening control. With sufficient input data about window control, employing EnergyPlus in combination with an airflow network can provide informative predictions of natural ventilation performance.

## 11.5 Points of attention and future outlook

- Airflow network models coupled with the most commonly used building energy simulation tools allow to predict natural ventilation strategies performance. Although the coupling allows to consider interactions between airflows and building thermal behaviour, the convection heat transfer modelling is still too simplified for night cooling effect predictions. Furthermore, new features/types to model new solutions and technologies like wind catchers and solar chimneys are needed.
- Airflow predictions are obviously highly sensitive to window opening controls. In case of manual controls, it is necessary to include more detailed occupant comfort based stochastic window control algorithm. In case of automatic controls, the integration of predefined control strategies would support designers in choosing the most effective control for a particular climate and/or design
- CFD simulations provide the users with a large amount of information that can be handled with the

desired spatial and temporal resolution. CFD simulations are useful to study local comfort, air velocity throughout the room or within the façade air cavity. Given the long calculation time, the high dependency on boundary condition and effort needed, it is often counter-productive to use transient CFD to predict natural ventilation strategies within the whole building.

The recent developments in BES-CFD-AFN coupling are very promising and revealed the advantages of the integrated building simulation over the separated building energy and CFD applications, which are:

- CFD receives more precise and real-time thermal boundary conditions and can predict the dynamic indoor environment conditions that are important for the assessment of indoor air quality and thermal comfort.
- BES obtains more accurate convection heat from enclosures and can provide more accurate estimation of building energy consumption and dynamic thermal behaviours of building envelopes.

## References

- IEA Annex 62, Ventilative cooling – state-of-the-art review edited by Maria Kolokotroni and Per Heiselberg <http://venticool.eu/wp-content/uploads/2013/09/SOTAR-Annex-62-FINAL.pdf>
- Zhai J., Krarti M., Johnson M.H., "Assessment of natural and hybrid ventilation models in whole-building energy simulations," *Energy & Buildings* 43, pp. 2251 - 2261, 2011.
- Belleri A., Lollini R., S.M. Dutton, "Natural ventilation design: an analysis on predicted and measured performance," *Building and Environment*, *Building and Environment* 81, 123-138, 2014.

# 12 Computational performance prediction of green roofs and green facades

Alice Gorrino, Valentina Serra; Politecnico di Torino

## 12.1 Green roofs and living walls for high-performance buildings

A green roof is a roof covered by a vegetative external coating. Usually, green roofs are classified into two main types: extensive and intensive. These types differ in term of thickness of soil, types of vegetation, cost and maintenance. Extensive green roofs are characterized by thin growing media (6-25 cm), small plants and they usually require a minimum maintenance. Intensive green roofs are heavier and thicker (15–70 cm) and they can support different types of plants such as small trees, shrubs and bushes. Also semi-intensive roofs are sometimes introduced into the classification as the green roof with intermediate properties. Usually they consist of the following main layers, from the outer to the inner side: vegetation, growing medium, filter membrane, drainage membrane, root barrier and waterproof layer (Lin and Lin, 2015).

Green roofs may provide benefits both in winter and in summer period. Saadatian et al. (2013) gives an extensive review of the implications of the green roofs on the energy related aspects.

During the heating period, the soil layer increases the thermal resistance of the bare roof while the canopy layer reduces the heat losses by convection on the external side. This effect is much more evident when the roof is poorly thermally insulated.

During the cooling period, the main benefits are induced by the thermal mass of the soil layer, the evapotranspiration phenomena of both vegetation and soil and the shading effect of the foliage layer. The soil layer, characterized by a high thermal capacity, allows to attenuate and shift the heat flux through the component and the evapotranspiration phenomena allows a favorable evaporative cooling. This coupled effect reduces the inner surface temperature of the green roofs with a positive effects on the thermal comfort and on the cooling energy demand for air conditioning.

To quantify the performance of the green roofs under dynamic conditions, several studies have been performed following different approaches. Capozzoli et al. (2013) calculated an equivalent periodic thermal transmittance through the application of a simulation model in order to evaluate the performance of the component for a summer design day. Bevilacqua et al. (2016) used both experimental results and simulations to characterize the green roof by dynamic thermal parameters (time lag and decrement factor). A dynamic U-value has been evaluated by Kotsiris et al (2012) through measurements on a semi-intensive roof.

Green facades, living walls or vertical greenery systems are general terms identifying a vertical wall hosting plant species, which is becoming more and more common in urban environments, due not only to aesthetical and architectural choices, but to different environmental benefits as far as outdoor and indoor spaces are concerned. The main difference among vertical greenery systems is the presence of a growing media and irrigation system attached to the opaque wall structure. Whenever there is such a growing media (i.e. modular pocket systems, hydroponic systems or vegetation mats), these are known as living walls. While if the support structure on the opaque



wall only supports climbing vegetation or cascading groundcovers, these are so-called double skin green facades or indirect green facades (Kalani et al. 2017).

Depending on the type of vertical greenery system, different performance improvements could be achieved. In fact the main effect of green facades lies in the shading effect of the building envelope and in reducing convective and radiative heat exchange with the outdoor environment. Therefore they are mainly used to reduce peak surface temperatures in summer and cooling loads. Moreover, a great amount of latent heat is released by the plants due to the evapotranspiration phenomenon, which clearly distinguishes green walls from other shading devices.

On the other hand, living walls, due to the presence of a growing media (which can be a mix of natural textile materials and soil) and of an irrigation system, can have a much higher impact on both heating energy demand as well as cooling, analogously to green roofs. In fact the increased insulation properties of the growing media and increased inertia could reduce and shift heat losses and gains, while the moisture transfer through the vegetated building envelope could significantly reduce surface temperatures (Serra, 2017).

Different studies have shown the impact of green and/or living walls on building performance, by means of experiment and simulation. Djedjig et al. (2015) shows that the correct design of the green cladding can lead to a reduction in the cooling energy consumption from 5% to 20% for living walls facing North and West respectively. According to a study of Wong et al. (2009) the impact of the variation of green wall design parameters (vegetation and growing media) on the annual energy consumption can go up to 15%.



Figure 1 - Image of a typical living wall (left), Caixa Forum (Madrid), and of a green roof (right), EnviParK (Torino) (from <http://www.greenroofs.com/projects/environment-park-envipark/> in Oct 2018).

## 12.2 Simulation requirements

Green roofs, green walls and living walls impact on buildings energy efficiency, on outdoor thermal comfort and on Urban Heat Island. A simulation tool should take these interactions into account.

It is important that both sensible and latent heat balance are considered, taking into account both the foliage and the soil layers.

At the foliage layer, the latent heat flux is governed by the process of transpiration of the plants. Transpiration is the process through which a plant takes water from the soil to its leaves for photosynthesis. This process regulates the amount of water that changes phase from liquid to vapor, affecting the energy balance of the leaves layer. Another phenomenon to be taken into account at the foliage layer, is the absorption of the incident solar energy by the leaves. This amount is directly proportional to the area of the foliage covering the soil. Leaf Area Index (LAI) is the parameter used to characterize the density of the foliage layer. The foliage layer can affect also the sensible heat flux modifying both the radiative and convective heat transfer (Frankenstien and Koenig, 2004).

Considering the soil layer, unlike the generic building materials, the moisture transfer phenomenon has a strong impact on the thermal heat transfer because the soil layer is characterized by a high porosity. Moreover, the thermal properties of the soil layer (thermal conductivity, heat capacity, density, albedo) vary strongly with the moisture content.

From the above mentioned phenomena it derives that the thermal characterization of a green roof varies significantly during the daytime, seasonally and depending on climate conditions and irrigation methods.

The time step of the heat transfer calculation should be short enough to better consider the moisture transfer phenomena and thermal properties varying with the moisture content. Moreover, the irrigation schedule should be considered and coupled with the green roof model considering different irrigation control strategies.

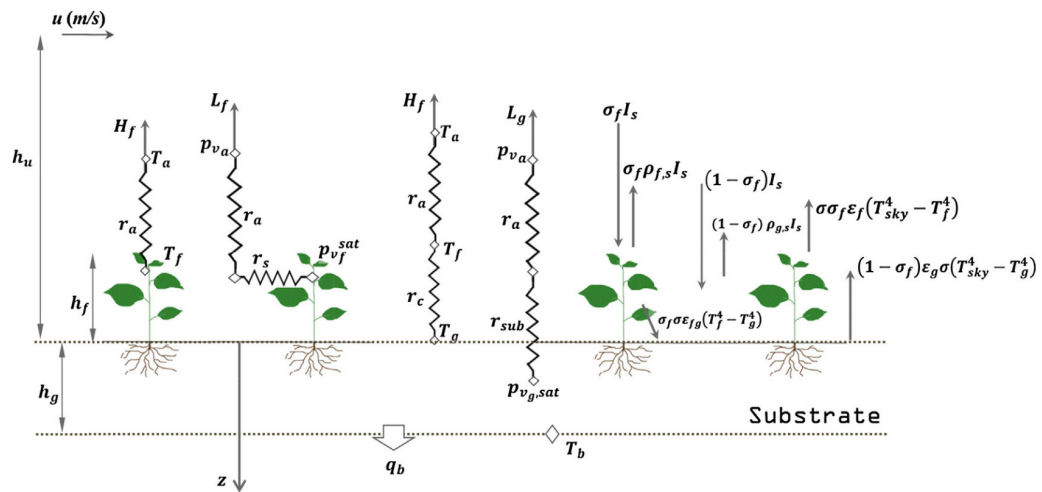

Figure 2 - Model scheme of a vegetated envelope module (green façade, living wall or green roof) and corresponding heat and vapor transfer resistances (Djedjig et al. 2015)

### 12.3 Implementations in building performance simulation software

The green roof technology can be modelled with an application oriented approach in Energy Plus. The energy balance model of a vegetated roof is based on the Army Corps of Engineers' FASST vegetation models and Fast All-season Soil Strength (FASST) model (2004). As implemented in Energy Plus by Sailor (2008), the green roof tool allows to model this technology as the upper layer of a roof. The "roof vegetation" layer contains both the parameters of the canopy and of the soil layer.

As regards the foliage layer, the following data are required: height of plants, Leaf Area Index (LAI) that is the projected area of the leaf surfaces on the horizontal plane, Leaf reflectivity and emissivity, minimum stomatal resistance that is a property governing the rate of the moisture content that the plant can transpire through its stomata.

The soil layer is characterized by: roughness, thickness, conductivity of dry soil, density of dry soil, specific heat of dry soil, thermal absorptance, solar absorptance, saturation volumetric moisture content, residual volumetric moisture content, initial volumetric moisture content.

The FASST model suggests default values for the properties of both soil and foliage layers. Moreover many in fields studies are aimed at measuring real values to be implemented into the model.

Sailor et al. (2008) measured thermal conductivity, specific heat capacity, thermal emissivity, albedo and density of 8 soil samples varying the moisture content. This study shows that the thermal properties of an ecoroof soil vary significantly from the properties of a naturally occurring soil, because the ecoroof soil contains more lightweight aggregate. Moreover, the soil properties vary both seasonally and diurnally as a function of the moisture content as well as of the soil compaction. These results are shown in Sailor and Hagos (2011), Abu-Hamde and Reeder (2000) through experimental investigations. The variation of the thermal conductivity and of the specific heat as a function of the density of the soil has been obtained by Farouki (1986) and Zhao et al. (2014).

Many parameters analysis have been developed to evaluate the effect of these parameters on the energy performance of the buildings through simulation and experimental analysis. Sailor (2008) performed a sensitivity analysis to explore the FASST model response to the variation of the afore mentioned parameters. The soil thickness and LAI have the largest impact on the energy use of a test building.

Palomo Del Barrio (1998) performed one of the first model described in literature and identified as relevant parameters LAI, soil density, its thickness and moisture content.

During the last decade, several models based on a dynamic heat and mass transfer have been developed using general purpose tools (MATLAB) and/or coupled with energy simulation software (TRNSYS e.g.). Generally, the complexity of the phenomenon needs a dynamic detailed model including mathematical and partial differential equations to be solved with an iterative approach. To name a few, Lazzarin et al. (2005) developed a model in TRNSYS stressing the importance of the evapotranspiration phenomenon; Tabares-Velasco and Srebric (2012) presents a quasi-steady state heat and mass transfer model; Djedjig et al. (2012) and Ouldboukhitine et al. (2011) implemented the Sailor's model with a water balance equation affecting the thermal conductivity of the soil.

As far as the green walls and living walls are concerned only few simulation studies on energy performance of buildings are found, which include or developed a model integrated within a BPS tool (application oriented modelling method).

Green walls are often modeled only through their shading effects (Jim & He, 2011; Stec et al. 2003). Wong et al. (2003) adopted TAS BPS software tool to determine the effect of a vertical greening systems on thermal comfort and building energy use. However, the influence of greening systems on buildings was modeled only through shadings coefficient linked to the leaf area index. This

modelling approach regards plants as a conventional shading device, without taking into account the evapotranspiration effect and other biophysical effects of plants (Kalani et al. 2017).

Only recently different models of living walls were integrated into BPS tools, considering also evapotranspiration effect of the foliage, effect of growing media on heat transfer and effect of water content on thermal properties of the growing media.

In particular Djedjig et al. (2015) developed a TRNSYS model (Fig. 3) taking into account the major thermal, aeraulic and hydric phenomena, overcoming limitations of previous modeling approaches that assume quasi-steady state heat transfer and neglect the effect of water transfer on heat transfer, which can be applied to both green roofs and living walls modeling. The developed green module model, written in Python programming language, is coupled to the multizone building model component (Type 56) through a new TRNSYS Type named VegEnvelope (Djedjig et al., 2015). This model was applied to account for the effect of vertical vegetation on building energy use and reduction of temperature in urban canyons.

Kalani et al. (2017) instead adopted a general purpose modelling approach, by implementing a script based model by means of ERL programming language, into the EMS system of Energyplus. The heat balance equations of the developed model are based on the validated green roof module in EnergyPlus, FASST vegetation models by Frankenstein and Koenig (2004) and on the validated green wall hygrothermal model by Malys et al. (2014). The developed model accounts for short-wave and long-wave radiation received by foliage and by soil, latent heat flux sensible heat flux exchange with air in the canopy and substrate. In particular the model calculates the temperatures of the living wall system for each time step, based on foliage and substrate parameters and EnergyPlus weather data, while the EMS actuator is used to override the calculated temperatures into the modeled building.

## 12.4 Validation

All the proposed developed models have been validated through experimental analysis, usually by comparing only one physical quantity. Lazzarin et. al (2005) compared the calculated and measured evapotranspiration; Sailor (2008) compared the soil surface temperature; Djedjig et al. (2012) compared the soil temperature and the degree of saturation of the substrate.

Tabares-Velasco and Srebric (2012) performed a complete validation of their model measuring and calculating separately evapotranspiration, convection, conduction, substrate temperature, plant surface temperature and net radiation. In this way, the validation procedure has been used to estimate separately the amplitude of the model to simulate a specific phenomenon.

Djedjig et al. (2015) validated its TRNSYS VegEnvelope subtype by comparing it to measured temperatures with simulated ones for one month in August, showing good agreement (nearly 0.3 deg C average bias and 1.4 deg C mean root square error) of the same order of the Energyplus green roof model FASST (2004).

The validation procedure needs that the input data of the models are measured to have coherent results. Since the input data of the models (weather data and properties of the green roof components) are numerous, usually some of them are monitored and some are fixed. Moreover the vegetated building envelope may noticeably modify the weather data at a local scale.

A complete set of climatic data has been monitored by Oulboukhitine et al. (2011) with a weather station that measures air humidity, short and long wave radiations, precipitation, speed and wind direction. Also the above mentioned properties of the soil and foliage layers should be measured to decrease the degrees of freedom of the model.

## 12.5 Points of attention and future outlook

Since the green roofs technology belongs to a multidisciplinary sector, the future developments involve different fields of knowledge such as the building physics and the agricultural sectors.

Future developments for the application oriented tools are related to the following aspects:

- Despite different correlations between the thermal properties of the soil and the moisture content have been defined, they are not included into the simulation tools;
- There is no control type associated to the irrigation of the green roofs: a controlled “smart irrigation” may be introduced (Sailor, 2008);
- The effect of the drainage layer has not been taken into account in the application oriented tools.

Moreover, even if different in field studies are being performed to define the thermal properties of both soil and canopy layer, a large and shared database is still missing. In particular, LAI values for green roof application are not commonly available and no seasonal behavior of plants is taken into account.

Another key issue to be faced is related to the boundary conditions. The presence of a vegetated building envelope may noticeably modify the weather data. Iterative process should be thus carried out since air temperature and relative humidity are highly connected with the evapotranspiration phenomena and external surface temperatures affect the surface resistances (convective and radiative exchange).

From the building scale and the building energy models (BEMS) it is thus necessary to move to the micro-scale and meso-scale models. Among these the most adopted approaches are on one hand those based on the resolution through CFD techniques of the airflow patterns around and within the buildings; on the other hand those adopting the urban canopy model, which represents a built-up area as a street canyon, two facing buildings, and a road and where the energy budget is decoupled from the airflow model (Mirzaei, 2018). On the basis of solar azimuth angle and canyon orientation the surface temperature and energy budget are calculated for each wall and the effects of canyon aspect ratio (height-to-width ratio) and reference wind direction on canyon wind speed are duly taken into account (Imram 2018).

In order to model the microclimate four main software tools can be adopted: Rayman (Matzarakis, 2010), Solweig (Lindberg, 2008), Solene (Morille, 2015) and ENVI-met (Bruse, 1998).

Rayman and Solweig allow to calculate surface temperatures, radiant mean temperature, short-wave and long-wave radiation but were not specifically developed to take into account the evapotranspiration related to vegetated surfaces (Janicke, 2015).

The numerical tool SOLENE-Microclimate is able to take into account green walls and roofs which can modify both radiation exchanges and meteorological conditions outside the building and has



the main advantage of representing both the unsteady building thermal behavior and the whole urban environment

ENVI-met, specifically designed for modelling the interaction at the urban level among plants surfaces and air and is under continuous development in order to properly characterize the effects of greenery located on building surfaces. Specific models related to vegetation have been developed, considering the exchange of CO<sub>2</sub> and water vapor at the leaf level (Simon 2018).

Thanks to its features ENVI-met is actually a widely used software, mainly adopted in order to estimate the effects of green roofs and walls on both urban heat island and outdoor comfort at the pedestrian level (Dwivedi, 2018).

## References

- Abu-Hamde, N.H., Reeder R.C. (2000). Soil thermal conductivity: effects of density, moisture, salt concentration and organic matter. *Soil Science Society of America Journal* 64, 1285-1290.
- Bevilacqua, P., Mazzeo, D., Bruno, R., Arcuri, N. (2016). Experimental investigation of the thermal performance of an extensive green roof in the Mediterranean area. *Energy and Buildings*, 122, 63-79.
- Bruse, M., & Fleer, H. (1998). Simulating surface-plant-air interactions inside urban environments with a three dimensional numerical model. *Environment Modelling & Software*, 13(3-4), 373-384.
- Capozzoli, A., Gorrino, A., Corrado, V. (2013). Thermal characterization of green roofs through dynamic simulation. In *Proceedings of Building Simulation 2013*. Chambéry, France.
- Djedjig, R., Ouldboukhitine, S-E., Belarbi, R., Bozonnet, E. (2012). Development and validation of a coupled heat and mass transfer model for green roofs. *International Communications in Heat and Mass Transfer*.
- Djedjig, R., Bozonnet, E., Belarbi, R., 2015. Analysis of thermal effects of vegetated envelopes: integration of a validated model in a building energy simulation program. *Energy Build.* 86, 93-103. <http://dx.doi.org/10.1016/j.enbuild.2014.09.057>
- Djedjig, R., Bozonnet, E., Belarbi, R., 2016. Modeling green wall interactions with street canyons for building energy simulation in urban context, *Urban Climate* 16, 75-85, <http://dx.doi.org/10.1016/j.uclim.2015.12.003>
- Dwivedi, A., Mohan, B.K. (2018), Impact of green roof on micro climate to reduce Urban Heat Island, *Remote Sensing Applications: Society and Environment*, 10, 56-69.  
DOI: 10.1016/j.rsase.2018.01.003
- Imran, H.M., Kala, J., Ng, A.W.M., Muthukumaran, S. (2018). Effectiveness of green and cool roofs in mitigating urban heat island effects during a heatwave event in the city of Melbourne in southeast Australia. *Journal of Cleaner Production*, 197, 393-405. DOI: 10.1016/j.jclepro.2018.06.179
- Farouki OT. (1986). Thermal properties of soils. Clausthal-Zellerfeld, Germany: Trans Tech Publications.
- Frankenstein, S., Koenig, G. (2004). Fast All-season Soil Strength (FASST). Cold Regions Research and Engineering Laboratory, US Army Corps of Engineers (ERDC/CRREL SR-04-1).
- Frankenstein, S., Koenig, G. (2004). FASST Vegetation Models. Cold Regions Research and Engineering Laboratory, US Army Corps of Engineers (ERDC/CRREL SR-04-25).
- Jänicke B., Meier F., Hoelscher M., Scherer D. (2015). Evaluating the Effects of Façade Greening on Human Bioclimate in a Complex Urban Environment, *Advances in Meteorology*, vol. 2015, Article ID 747259, 15 pages, 2015. <https://doi.org/10.1155/2015/747259>.
- Jim C.Y., He H., (2011). Estimating heat flux transmission of vertical greenery ecosystem, *Ecological Engineering* 37, 1112-1122, <http://dx.doi.org/10.1016/j.ecoleng.2011.02.005>.



- Kalani K.W.D. , Dahanayake C., Cheuk Lun Chow, (2017). Studying the potential of energy saving through vertical greenery systems: Using EnergyPlus simulation program, *Energy and Buildings* 138, 47–59, <http://dx.doi.org/10.1016/j.enbuild.2016.12.002>
- Kotsiris, G., Androutsopoulos, A., Polychroni, E., Nektarios, P.A. (2012). Dynamic U-value estimation and energy simulation for green roofs. *Energy and Buildings*, 45, 240-249.
- Lazzarin, R.M., Castellotti, F., Busato, F. (2005). Experimental measurements and numerical modelling of a green roof. *Energy and Buildings*, 37, 1260-1267.
- Lin, B.-S., Lin, Y.-J. (2015). Cool green roofs for reducing building cooling needs. In: *Eco-efficient Materials for Mitigating Building Cooling Needs. Design, Properties and Applications*. Editors: Pacheco-Torgal, F., Labrincha, J., Cabeza, L., Granqvist, C.G, ISBN: 978-1-78242-380-5.
- Lindberg F., Holmer B., Thorsson S. (2008), "SOLWEIG 1.0—modelling spatial variations of 3D radiant fluxes and mean radiant temperature in complex urban settings," *International Journal of Biometeorology*, vol. 52, no. 7, pp. 697–713
- Malys L., Musy M., Inard C., (2014). A hydrothermal model to assess the impact of green walls on urban microclimate and building energy consumption, *Build. Environ.* 73, 187–197, <http://dx.doi.org/10.1016/j.buildenv.2013.12.012>.
- Matzarakis A., Rutz F., Mayer H. (2010) "Modelling radiation fluxes in simple and complex environments: basics of the RayMan model," *International Journal of Biometeorology*, vol. 54, no. 2, pp. 131–139, 2010
- Mingjie, Z., Tabares-Velasco P.C., Srebric, J., Komarneni, S., Berghage, R. (2014). Effects of plant and substrate selection on thermal performance of green roofs during the summer. *Building and Environment*, 78, 199-211.
- Morille B., Lauzet N., Musy M. (2015). SOLENE-microclimate: A Tool to Evaluate Envelopes Efficiency on Energy Consumption at District Scale., *Energy Procedia*, 78, 1165-1170, ISSN 1876-6102, <https://doi.org/10.1016/j.egypro.2015.11.088>.
- Ouldoukhitine, S-E., Belarbi, R., Jaffal, I., Trabelsi, A. (2011). Assessment of green roof thermal behavior: A coupled heat and mass transfer model. *Building and Environment*, 46, 2624-2631.
- Saadatian, O., Sopian, K., Salleh, E., Lim C.H., Riffat, S., Saadatian, E., Toudeshki, A., Sulaiman, M.Y. (2013). A review of energy aspects of green roofs. *Renewable and Sustainable Energy Reviews*, 23, 155-168.
- Sailor, D.J. (2008). A green roof model for building energy simulation programs. *Energy and Buildings*, 40, 1466-1478.
- Sailor, D.J., Hutchinson, D., Bokovoy, L. (2008). Thermal property measurements for ecoroof soils common in the western U.S. *Energy and Buildings*, 40, 1246-1251.
- Sailor, D.J., Hagos M. (2011). An updated and expanded set of thermal property data for green roof growing media. *Energy and Buildings*, 43, 2298-2303.
- Serra, V., Bianco, L., Candelari, E., Giordano, R., Montacchini, E., Tedesco, S., Larcher, F., Schiavi, A. (2017). A novel vertical greenery module system for building envelopes: The results and outcomes of a multidisciplinary research project, *Energy and Buildings*, 146, pp. 333-352. DOI: 10.1016/j.enbuild.2017.04.046
- Simon H., Lindén J., Hoffmann D., Braun P., Bruse M., Espera J. (2018). Modeling transpiration and leaf temperature of urban trees – A case study evaluating the microclimate model ENVI-met against measurement data. *Landscape and Urban Planning*, 174, June 2018, 33-40
- Stec W.J., Van Paassen A.H.C., Maziarz A., (2005). Modeling the double skin facade with plants, *Energy and Buildings* 37 (2005) 419–427.
- Tabares-Velasco, P.C., Srebric, J. (2012). A heat transfer model for assessment of plant based roofing systems in summer conditions. *Building and Environment*, 49, 310-323.
- Wong N., Tan A.Y.K., Tan P.Y., Wong N.C., (2009). Energy simulation of vertical greenery systems, *Energy and Buildings* 41, 1401–1408, <http://dx.doi.org/10.1016/j.enbuild.2009.08.010>.
- Zhao, M., Tabares-Velasco P.C., Srebric, J., Komarneni, S. (2014). Effects of plant and substrate selection on thermal performance of green roofs during the summer. *Building and Environment*, 78, 199-211.

# 13 Computational performance prediction of solar thermal adaptive façade

Stefano Avesani, Giuseppe De Michele, Francesco Babich; Eurac Research

## 13.1 Façade integrated air-based sorption collector for high-performance buildings

The strict energy requirements are boosting the integration of renewable systems and technologies into the façade. One frequent design option considers solar thermal collectors installed on the building envelope in order to heat up a heat transfer carrier, which can be used for space heating and Domestic Hot Water (DHW). Especially for high-rise buildings, the availability of the rooftop areas is a relevant constraint for the covering of the target load parts. In this sense, Building Integrated Solar Thermal (BIST) is a widely investigated topic. A key reference in terms of technological development can be found at the IEA Task 41 product catalogue (IEA- SHC - Task 41 - Task 51, n.d.).

The BIST development has been critically analysed in (Cappel et al., 2014; Maurer et al., 2015). One of the highlighted obstacles for the spread into the market of BIST for facades is the need for hydraulic or aeratic networks interacting with the collector in the façade, which lead to elevated investment and maintenance costs, as well as high design complexity. In this sense, an interesting technological concept is the decentralization of the generation and the distribution (air- or water-based). In other words, the generation (micro-heat pumps, solar thermal and photovoltaic panels...) and distribution (ventilation machines, radiant panels ...) of the heating and cooling can be done in facade using smaller and locally controlled components. Due to the extrinsic control of the components – under the definition of (Loonen et al., 2013), this kind of concept can adapt to changes in the indoor and outdoor boundary conditions guaranteeing indoor comfort as well as maximizing the energy saving. In the literature, some concepts can be found on this line, such (Adaptiwall project, 2013; Alessio Passera, 2017; Avesani et al., 2015).

One of these decentralised system generating and distributing heating and cooling is the so-called façade-integrated sorption collector (Avesani, 2016; Avesani et al., 2015; Paolo Bonato et al., 2016), which can be shortly described as a decentralized solar-thermal-based adaptive façade. The sorption collector is the product obtained from the engineering of the sorption tubes technology merged into a vacuum tube solar collector (Hallstrom and Földner, 2015). On the back of this unit, which is able to heat and cool a heat transfer carrier (air in this case), an aeratic unit has been designed. Fans and dampers let the air fluxes circulating inside the air-channels' network depending on the outdoor and indoor conditions. A control-board extrinsically commands all the actuated components.

The whole assembly, adequately insulated, has been integrated into the spandrel of a curtain wall, and it is able to provide hot or cold air generated locally by the sorption collector.

The expected benefits, assessed in (Avesani, 2016) by means of transient simulations, can be expressed by means of the following key performance indicators (KPIs). The electric energy efficiency of the heating and cooling generation is expected to drop due to the significant reduction of pressure losses compared to standard centralized air-based heating and cooling systems. The

solar fraction in cooling assures elevated energy savings in the energy consumption compared to non-renewable energy sources (RES) based cooling system. Avoiding the use of the heating and cooling pipelines as well as the terminals could lead to interesting Pay Back Times.

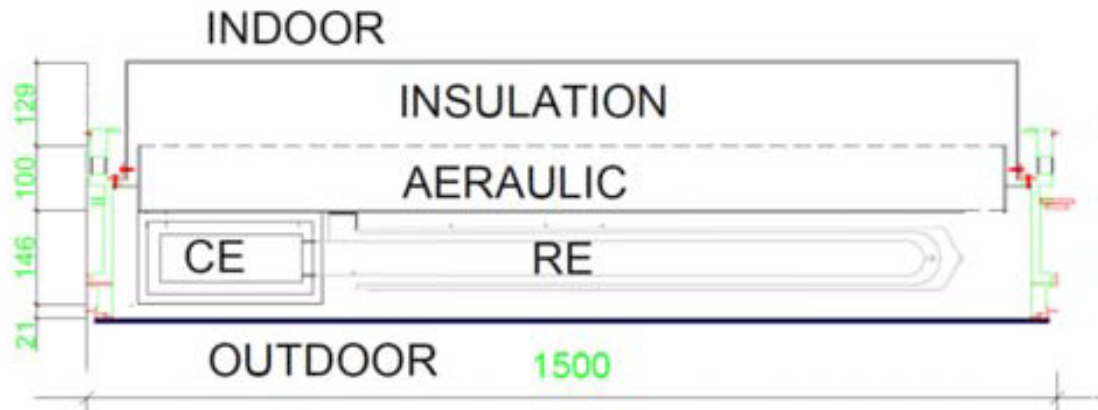

Figure 1 - Horizontal section of the façade-integrated sorption collector (spandrel). The sorption tube is composed by two parts, the Condenser/Evaporator (CE) and the REactor (RE).

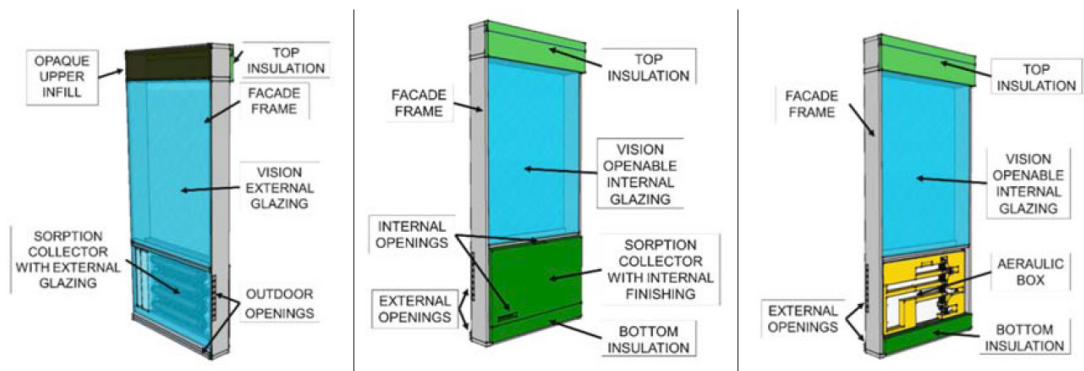

Figure 2 - 3D rendering of the whole assembly of the façade with the sorption collector integrated in the spandrel

### 13.2 Simulation requirements

Simulations play a fundamental role in the current phase of development in order to assess the cost-effectiveness of such integration compared to the benchmark. To do so, the simulations have to rely on a comprehensive modelling.

The first aspect to be taken into consideration is the absorption processes occurring in the sorption tubes and their thermal interaction with the solar radiation impinging on the Sydney tubes-like absorbers. Secondly, the heat transfer exchanged between the sorption working pair (LiCl + water) and the heat transfer between the medium (air) in the sorption collector's reactor and condenser/evaporator have to be carefully modelled and evaluated. In particular, fans and dampers have to be modelled under optimized control strategies, which have a very relevant impact on the KPIs. Finally, the building physic of a transparent component with movable shading system has to be taken into account in the modelling as it determines the heating and cooling energy demand of the indoor space.

To fulfil these requirements, a tool capable of performing energy transient simulations at fine time steps (below 15 minutes) and including different typologies of heat transfer is needed.

### 13.3 Implementations in building performance simulation software

The modelling of the opaque part is very complex due to the presence of many different mutually dependant physics. The sorption collector influences the room thermal behaviour and vice versa. Specifically, the sorption collector tends to have less thermal losses on the backside during operation due to the presence of the aeraulic unit layer - and the room - instead of the outside air. On the other side, the room receives an incoming heat flux due to the presence of the aeraulic and the sorption tubes. This behaviour is even more complex due to the difference in operational temperatures between the two sides of the sorption tubes (CE and RE as represented in Figure 8), along the façade width. Furthermore, the collector air outlet cools or heats the indoor environment through a mass exchange (ventilation).

Within the simulation environment TRNSYS, an existing model of the sorption collector was built. Type 827 (Hallström et al., 2014) offers a model capable of simulating the sorption collector energy behaviour in a free field installation with an heat exchanging surface on the back. However, the importance of a thermal coupling among the sorption collector, its aeraulic unit, the internal insulation layer, and the room has to be assessed. In (Avesani, 2016) a detailed thermal Finite Element Model (FEM) analysis of the aeraulic unit has been performed in order to assess a first estimation of the steady-state impact of the façade-integrated sorption collector on the indoor space. As a hypothesis for a pre-design study, considering the whole heating and cooling energy demand has been considered as not relevant. Hence, the final model used to pre-design the potentiality of the façade integrated sorption collector considers only the effect of the “hot” and “cold” airflow – generated by the sorption collector – on the reference room. Consequently, neither the presence of a heated/cooled environment on the sorption collector performance, nor the influence of the temperature of the collector internal surface on the indoor environment have been taken into account.

In order to take into account the presence of controlled thermal zone, within TRNSYS, the Type 827 has been coupled with the Type 56 (building thermal model) through a series of other sub-models addressing the aeraulic unit fans and dampers. More than eight extrinsic control strategies have been defined modelled using the equation and hysteresis (Type 2b) TRNSYS types. As a result, the model can calculate the amount of heating and cooling - in terms of air mass flow rates and temperatures, exchanged between the sorption collector and the indoor environment throughout the aeraulic unit.

### 13.4 Validation

Unfortunately, a specific model of the facade-integrated sorption collector has not been developed due to the lack of experimental data needed to validate the model itself. A FEM of the aeraulic unit, coupling Computational Fluid Dynamic (CFD) and heat transfer in solids, has been used to investigate the hypothesis of neglecting the mutual interaction between the indoor environment and the collector back surface.

However, the implementation of the extrinsic control strategies of fans and valves has been verified using a double check of the control signals. In other words, the generation of the expected control signal has been firstly done in a dedicated simplified model with the whole set of possible boundary conditions. The resulting control signal has been verified with the expected one.

### 13.5 Points of attention and future outlook

One possible simplified modelling approach to take into account the mutual effects of the indoor environment on the sorption collector assembly (and vice versa) from a building physic perspective is the use of a “black-box model” of the opaque active façade, determined based on a parametric set of FEM simulations. A set of equations can be derived, for which the dependent variable is the heat flux through the internal surface of the sorption collector, and the independent variable are the operation mode, the outdoor and indoor temperature, as well as the sorption collector ones.

Another approach would be to modify the Type 827 model. Specifically, the indoor environment node has to be added and connected to the resistance and capacitance network describing the sorption collector thermal behaviour. However, the need for an experimental campaign on a façade-integrated sorption collector specimen would be necessary in both improved approaches in order to characterize the heat transfer through the whole active spandrel assembly and to calibrate the models.

### References

- Adaptiwall project, 2013. Adaptiwall [WWW Document]. URL [www.adaptiwall.eu/](http://www.adaptiwall.eu/) (accessed 3.20.18).
- Alessio Passera, 2017. Developing a tool to assess the business concept of solar thermal façades (PhD Dissertation). Politecnico di Milano.
- Avesani, S., 2016. Design of a solar façade solution with an integrated sorption collector for the systemic retrofit of the existing office buildings (PhD Dissertation). Universität Innsbruck. Institut für Konstruktion und Materialwissenschaften, AB Energieeffizientes Bauen.
- Avesani, S., Hallström, O., Földner, G., Fedrizzi, R., 2015. Integration of Sorption Collector in Office Curtain Wall: Simulation Based Comparison of Different System Configurations. International Solar Energy Society, pp. 1–10. <https://doi.org/10.18086/eurosun.2014.07.01>
- Cappel, C., Streicher, W., Lichtblau, F., Maurer, C., 2014. Barriers to the Market Penetration of Façade-integrated Solar Thermal Systems. Energy Procedia, Proceedings of the 2nd International Conference on Solar Heating and Cooling for Buildings and Industry (SHC 2013) 48, 1336–1344. <https://doi.org/10.1016/j.egypro.2014.02.151>
- Hallstrom, O., Földner, G., 2015. Integration of Sorption Modules in Sydney Type Vacuum Tube Collector with Air as Heat Transfer Fluid. Energy Procedia 70, 445–453. <https://doi.org/10.1016/j.egypro.2015.02.146>
- Hallström, O., Földner, G., Spahn, H.-J., Schnabel, L., Salg, F., 2014. Development of Collector Integrated Sorption Modules for Solar Heating and Cooling: Performance Simulation. Energy Procedia 48, 67–76. <https://doi.org/10.1016/j.egypro.2014.02.009>
- IEA- SHC - Task 41 - Task 51, n.d. Innovative solar products for building integration [WWW Document]. Innov. Sol. Prod. Build. Integr. URL <https://leso2.epfl.ch/solar/index.php> (accessed 3.14.18).
- Loonen, R.C.G.M., Trčka, M., Cóstola, D., Hensen, J.L.M., 2013. Climate adaptive building shells: State-of-the-art and future challenges. Renew. Sustain. Energy Rev. 25, 483–493. <https://doi.org/10.1016/j.rser.2013.04.016>
- Maurer, C., Cappel, C., Kuhn, T.E., 2015. Methodology and First Results of an R&D Road Map for Façade-integrated Solar Thermal Systems. Energy Procedia, International Conference on Solar Heating and Cooling for Buildings and Industry, SHC 2014 70, 704–708. <https://doi.org/10.1016/j.egypro.2015.02.179>
- Paolo Bonato, Matteo D'Antoni, F., Roberto Fedrizzi, 2016. Integration of a sorption collector coupled with a decentralized mechanical ventilation unit in curtain wall module.

# 14 Description of models for prediction of long-term façades performance

Anna Sandak, Jakub Sandak; CNR-IVALSA Trees and Timber Institute / InnoRenew CoE / University of Primorska

## 14.1 Introduction

The façades are important element of the building since are influencing its comfort, safety and aesthetics. The complexity of façades evolved over a time in order to accommodate wide range of functionalities. Martinez et al. (2015) listed several functions as relevant for façades: security, air and water infiltration mitigation, thermal and acoustical insulation, solar control, daylighting, glare control, the provision of views, and aesthetics. The current problems related to building façades performance are related to poor design of construction details, inadequate choice of materials, their wrong application and not proper maintenance (Flores-Colen et al. 2010). It is estimated that façades system require maintenance and partial renovation around 20-30 years after being build (Martinez et al. (2015). Modern design standards address nowadays the service life objectives and have been adopted into building codes and specifications. Designers are choosing the solutions that improve durability and reduce maintenance requirements. Materials suppliers are developing better performing products more resistant to deterioration processes. Owners are more aware of the importance of maintenance. Finally, contractors have developed quality control procedures to improve construction practices that are aiming to improve durability. However, the interaction between time and the elements that constitute the façade system, the interaction between the materials applied in the façade and the environmental exposure conditions, and the potential effects of changes in material's service in the overall performance of the assembly is rarely taken into account (Fagerlund 1985). The intensity of degradation depends on exposure level, orientation/ position of assembly, architectural details, location and related to it microclimate and material itself. Deterioration process is valid for all building materials, also those used for adaptive façades, since all materials require cleaning, maintenance and finally replacement. Consequently, even if many efforts are directed toward prediction of the building use phase, still reliable prediction of service life performance is problematic.

## 14.2 Service life definition

The ISO meaning of reference service life, it defined as a "service life of a product / component / assembly / system that is known to be expected under a particular set, e.g. a reference set, of in-use conditions and which may form the basis of estimating the service life under other in-use conditions" (ISO 15686-1). In other words, service life is a period of time after construction in which a structure maintains or exceeds minimum performance requirements without unforeseen or extraordinary maintenance or repair (ISO 15686-1). In the last decades, special attention on determination of durability and service life of materials, components, installations, structures and buildings is observed (Hovde 2002). Service life of façades depends on many variables, some of which are environmental and, as a result, beyond the control of the designers and owners. In order to minimize decline of general performance of building it is necessary to achieve the optimum balance between functionality, investment costs and maintenance efforts.



### 14.3 Service life categories

The service life of buildings can be distinguished into three main categories: physical (technical) service life, functional service life and economic service life (Kelly 2007). The physical or technical service life is related to the deterioration of the materials and building elements. The deterioration occurs systematically, which means that its failure rate increases over time. The physical deterioration of buildings is mainly due to the action of the degradation agents (whether conditions, physical, chemical or mechanical sources) and the natural ageing process of used materials. Both, design and construction errors, and the application of not suitable materials, can contribute to the reduction of the physical service life of buildings. The functional service life is related to the expectation and demands of users. Trends or fashions to use certain type of materials should be considered while designing of building (Ebbert and Knaack 2007). In many cases motivation for façade (or façade elements) replacements is not dependent on their in-service performance but is stimulated by personal motivation to follow certain tendencies (Rametsteiner et al. 2007). Survey research performed by Martinez et al. (2015) states, that the aesthetics is the main motivation for façades retrofitting - 74% of the total responses, followed by energy performance (65%), and remediation (56%). Economic service life is defined as the time between beginning of building utilization and its replacement with more cost effective solution. Economic service life is reached when cost of new architectural solutions require less economical efforts then maintaining the existing façades (Silva et al. 2016).

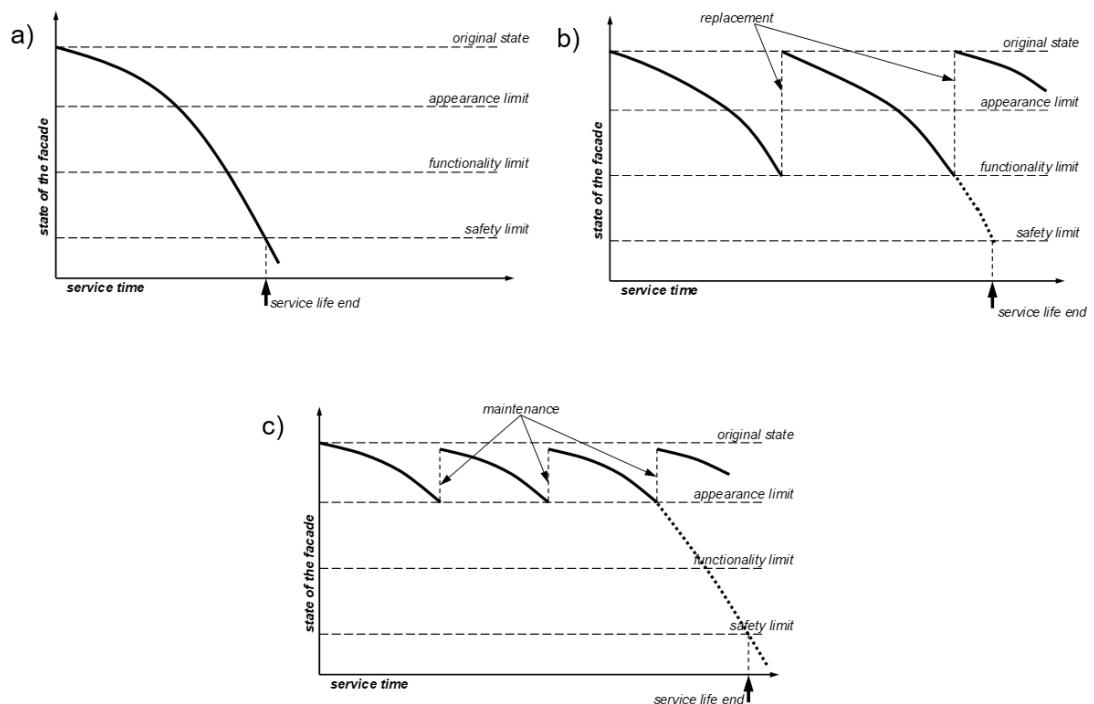

Figure 1 - Estimation of the service life time according to different scenarios; no any repairs (a), replacement (b) and frequent maintenance (c) (Sandak et al. 2017a)

### 14.4 Serviceability, durability and performance over time

In order to evaluate overall building performance several criteria should be considered, such as heat and mass transfer, acoustics, light, fire resistance, cost, sustainability and service life (Hendriks et al. 2000). While energy performance is often considered while simulating building

design and use phases, the service life related to the biological, chemical and physical attacks is often neglected. Service life aspects influence several indicators related to façades performance, such as durability (lifespan, decay resistance, material quality), adaptability (maintenance flexibility, environmental impact), affordability (maintenance costs, refurbishment costs) and well-being (e.g. aesthetics) (Jin et al. 2013). Figure 1 presents estimation of service life according to three different scenarios. The estimated service life (ESL) end is reaching the minimal acceptable value depending on certain requirements. In the real cases, the aesthetic requirements are normally reached before functional lose and reduction of safety level. Three approaches are presented depending on the mitigation action used for façade protection. In the first case (Figure 1a) the loss of safety performance is reached fast, sine no maintenance and/or replacements are performed. In the second case (Figure 1b) the service life is elongated as the replacement action is foreseen. It can be seen in Figure 1c that the maintenance action scheduled regularly will allow substantial extension of the service life. It is challenging, however, to establish optimal levels of appearance, functionality and safety limits (states of the façade) being compromise between expected functional requirements, performance as well as operational and maintenance costs.

#### 14.5 Methods for estimation of service life duration

Several approaches are used for estimating service life duration. The most frequently used is a factorial method according to the ISO standard (ISO 15686-1). It bases on weighting approach of reference service life as related to differences between several factors associated to specific and reference usage conditions (Hovde 2002, Hovde 2005). Factor method calculate the service life by considering characteristics of the construction element. However, it ignores the degradation condition of the single element and neglects the fact that the degradation phenomenon is variable over time. In consequence small variations in the quantification of the durability factors can lead to a very large range of estimated service lives. Factor method provides an absolute value and does not provide information related to the results scatter (Silva et al. 2016). Moreover such methods, seems in many cases too complex to be directly applied in everyday practices.

Deterministic methods use mathematical and/or statistical formulations for description of the relationship between the degradation factors and the building condition. Those methods intends to obtain the function that best fits a set of random data. Such approach is only efficient when large and representative data sets are available. Shohet et al (1999) proposed four deterioration patterns being typical effects of the common degradation agents: concave, convex, s-shape and linear. Examples of those patterns basing on experimental data related to bio-based materials weathering are presented in Figure 2 (Sandak et al. 2017a).

Alternative might be experimental methods, used directly in-situ or in the laboratory conditions during accelerated tests to evaluate effect of specific agent of deterioration. Empirical methods are usually supported by in-field survey of degradation factors followed by determination of the life cycle expectancy (Flores-Colen et al 2010). However, acquisition of data in real service life conditions is in many cases problematic due to highly varying time constrains (Galbusera et al 2014).

Performance of façades materials depends on various physical and chemical related phenomena and most of parameters responsible for deterioration are uncertain (Verma et al. 2014). Models based on probability or statistical concepts are suitable for modelling of such complex processes. According to Li et al (2007) three steps can be distinguished in probabilistic analysis: definition of failure limit states and corresponding models, quantification of the statistics of the random

variables, and calculation of the desired results as, e.g. failure probabilities. Verma et al. (2014) proposed broad classification for probabilistic methods; however, we propose to follow typology proposed by Silva et al. (2016), who divides them into two groups: scholastic methods and computational methods.

Scholastic methods allow creating an empirical relationship between variables through the estimation of parameters whose statistical robustness can be tested (Silva et al. 2016). Those methods predict uncertainty and provide information about the risk of failure. Basing on building elements characteristics they predict the most probable failure time. Such information are very valuable, especially for the definition of maintenance strategies. The most popular examples of scholastic methods are logistic regression and Markov chains. Logistic regression evaluates the probabilistic transition between degradation conditions over time considering specific facades' characteristics. It provides probability of the façade to reach the end of their service life. The Markov chain leads to obtain similar results like those obtained by logistic regression, but analyses processes in selective way. It is not able to produce context-dependent results, since does not consider the overall context. The following phased of process (degradation in this case) are analyzed separately, not as a sequence.

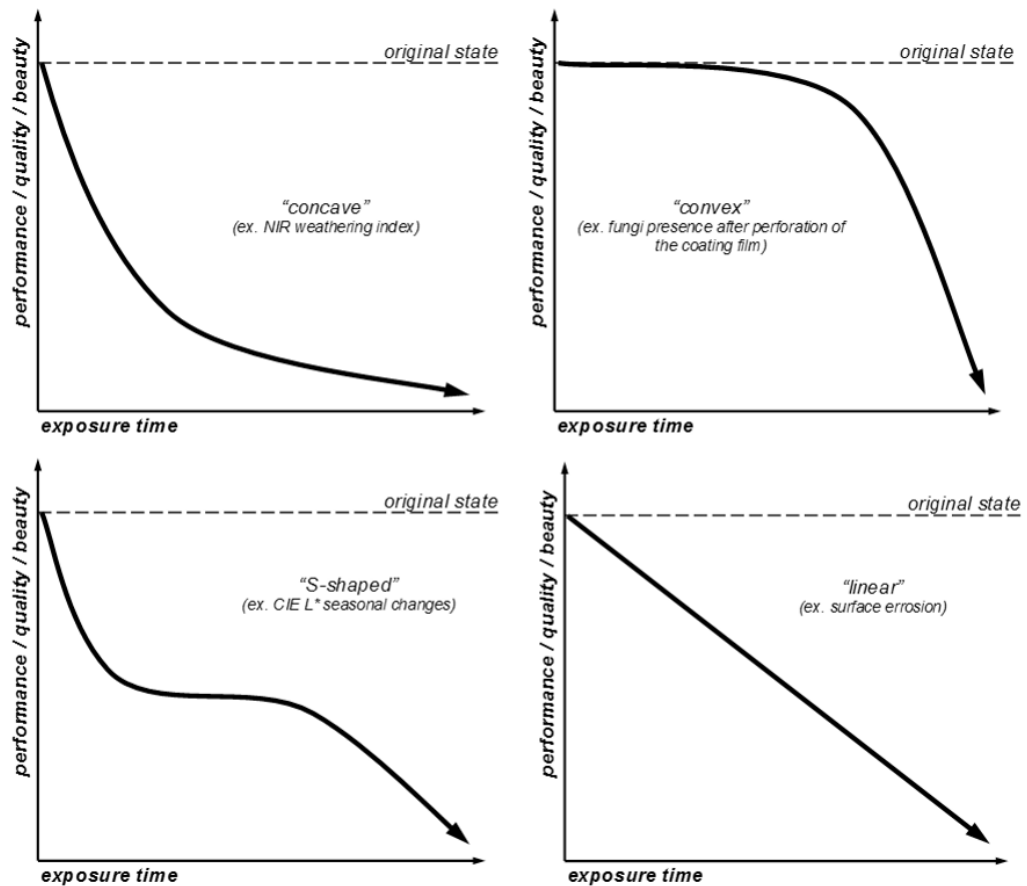

Figure 2 - Various deterioration patterns observed in weathering of biomaterials (Sandak et al. 2017a)

Computational methods rely on using mathematical models for description of complex system by means of computer simulations. They might be used for prediction of certain behavior of building elements for specific cases, when intuitive analytical solutions are not available. They use learning approach basing on previous data to find the best fitting models. Those methods are particularly

useful while dealing with inaccurate data and with samples with outliers. The most popular techniques are artificial neural networks (ANNs) and fuzzy systems (fuzzy logic). ANN applies previous knowledge related to the reality that one intends to model, transforming raw data into models easy to apply. Fuzzy logic based models are able to deal with the uncertainty associated with complex phenomena such as degradation of construction elements with higher precision and better performance than conventional linear models (Silva et al. 2016). Numerical modeling is often used to predict time of weathering, which is the primary process of façades deterioration (Sandak et al. 2017b). Such model allows design options to be tested under various environmental circumstances. On that base a rational decisions can be made to improve durability assuring still reasonable costs. The time to first repair can be estimated for various scenarios, allowing a comparison of initial and maintenance costs. Dedicated sophisticated modeling tools are recently under development (Sandak et al. 2018). It is foreseen, that they will allow similar analyses linking the façades performance with certain environmental conditions.

#### **14.6 Specific requirements for modeling of long-term performance of adaptive façades**

Adaptive building envelopes, comparing to traditional one are more complex systems, that typically influence multiple physical domains simultaneously (Loonen et al. 2017). In many cases, standard methods used for assessment façades performance are not accurate since base on static assumptions. In consequence, many numerical tools designed for evaluation of static façades fails. According to Loonen et al. (2017) two requirements are necessary for realistic modeling of adaptive façades. The first requirement is related to the possibility to model dynamic materials properties, that are changing during building use phase. The second requirement is to consider operational strategies, both automated and occupant-driven. The majority of available software available for modelling of energy and comfort performance, often neglects variation in building shape and materials properties during operations. The comprehensive review provided by Loonen et al. (2017) highlighted that “the simulation of adaptive façades tends to involve a high level of multi-domain interactions and corresponding reciprocal exchange with other energy systems in buildings”. Advanced analysis techniques, such as uncertainty propagation, sensitivity analysis and computational optimization are proposed in order to deal with complexity of performance simulation of adaptive façades. Those might be useful for identification of design variables influencing building performance (Tian 2013), assessment of occupant behavior, evaluation of influence of meteorological conditions (Hopfe et al. 2011), support design process and development of virtual prototyping.

#### **14.7 Points of attention and outlook**

Existing methods for modeling long-term degradation and performance of building façades have different levels of complexity and reliability. The tools based on factor methods even if easy for implementation, tend to oversimplification of the degradation processes. These do not take into account at all the variability of the factors involved in the ageing of the structure or component modeled. On the other hand, probabilistic methods are often far too complex to be used in routine practices. Probabilistic methods describe the service life under the exact conditions and are mostly based on the theory of probability (Moser et al. 2002). Computer based simulation tools usually require detailed knowledge of the software and significant skills in building physics, therefore many of the available tools are developed and used mainly by researchers for research purposes (Vullo

et al. 2018). There is an emerging necessity for development of simple but reliable modeling tools, being hybrid of all methods mentioned above.

## References

- Ebbert, T., Knaack, U. (2007) A flexible and upgradeable façade concept for refurbishment. In: Proceedings of the SB07 Lisbon - Sustainable Construction, Materials and Practices: Challenge of the Industry for the New Millennium, ed. Bragança, L, Pinheiro, M, Jalali, S, Mateus, R, Amoêda, R and Guedes M C Rotterdam, Netherlands, 2, 147-154.
- Flores-Colen, I., de Brito, J. (2010) A systematic approach for maintenance budgeting of buildings façades based on predictive and preventive strategies, *Construction and Building Materials*, 24(9):1718–1729
- Fagerlund, G. (1985): Essential data for service life prediction. Problems in service life prediction of building and construction materials. NATO ASI series, 95:113–138.
- Galbusera, M.M, de Brito, J., Silva, A. (2014) The importance of the quality of sampling in service life prediction. *Construction and Building Materials*, 66:19-29
- Hendriks, L., Hens, H. (2000) *Building Envelopes in a Holistic Perspective*. Amsterdam, Netherlands: Laboratorium Bouw-fysica
- Hopf, C.J., Hensen, J.L.M. (2011) Uncertainty Analysis in Building Performance Simulation for Design Support. *Energy and Buildings* 43(10):2798–2805
- Hovde, P.J. (2002) The Factor Method For Service Life Prediction From Theoretical Evaluation to Practical Implementation. 9DBMC International Conference On Durability of Building Materials and Components, Brisbane, Australia.
- Hovde, P.J. (2005) The Factor Method – a simple tool to service life estimation. 10 DBMC International Conferences On Durability of Building Materials and Components, Lyon, France
- ISO 2000, ISO 15686 Part 1. Buildings and constructed assets – Service life planning – Part 1: General Principles. International Organization for Standardization, Geneva, Switzerland.
- Jin, Q., Overend, M. (2014) A prototype whole-life value optimization tool for façade design, *Journal of Building Performance Simulation*, 7(3):217-232
- Kelly, D.J. (2007) *Design life of buildings - A scoping study*. Scottish Building Standards Agency
- Li, Y., Vrouwenvelder, T. (2007) Service life prediction and repair of concrete structures with spatial variability, *Heron*, 52(4):251–267
- Loonen, R.C.G.M., Favoino, F., Hensen, J.L.M., Overend, F. (2016) Review of current status, requirements and opportunities for building performance simulation of adaptive façades. *Journal of Building Performance simulation*. 10:2, 205-223
- Martinez, A., Patterson, M., Carlson, A., Noble, D. (2015) Fundamentals in Façade Retrofit Practice. *Procedia Engineering* 118:934 – 941
- Moser, K. Edvardsen, C. (2002) Engineering Design Methods for Service Life Prediction. 9DBMC International Conference On Durability of Building Materials and Components, Brisbane, Australia.
- Rametsteiner, E., Oberwimmer, R., Gschwandtl, I. (2007) Europeans and wood: What Do Europeans Think About Wood and its Uses? A Review of Consumer and Business Surveys in Europe. ISBN: 978-83-926647-0-3
- Sandak, A., Sandak, J. (2017a) Prediction of service life – does aesthetic matter? Proceedings IRG Annual Meeting (ISSN 2000-8953) IRG/WP 17-20618
- Sandak, J., Sandak, A., Burud, I. (2017b) Modelling of weathering. In: Jones, D., Brischke, C. (eds) *Performance of Bio-based Building Materials*, pp. 502-510. Elsevier
- Sandak, J., Sandak, A. Grossi, P. Petrillo, M. (2018) Simulation and visualization of aesthetic performance of bio-based building skin. Proceedings IRG Annual Meeting (ISSN 2000-8953), IRG/WP 18-20633
- Silva, A., de Brito, J., Gaspar, P. L. (2016) *Methodologies for Service Life Prediction of Buildings with a Focus on Façade Claddings*. Springer International Publishing

- Tian, W. (2013) A Review of Sensitivity Analysis Methods in Building Energy Analysis. *Renewable and Sustainable Energy Reviews*, 20:411–419
- Verma, S.K., Bhadauria, S.S., Akhtar, S. (2014) Probabilistic Evaluation of Service Life for Reinforced Concrete Structures *Chinese Journal of Engineering*, Article ID 648438, 8 p.
- Vullo, P., Passera, A., Lollini, R., Prada, A., Gasparella, A. (2018) Implementation of a multi-criteria and performance-based procurement procedure for energy retrofitting of façades during early design. *Sustainable Cities and Society*, 36:363-377





PV facade (image: M. Brzezicki)



# Performance Characterisation of Adaptive Facades





40 Mercer / Ateliers Jean Nouvel (image: M. Brzezicki)

# 15 Mapping of Test facilities to evaluate key performances of Adaptive Façade Components

Maxime Doya, Tipee S.A.S & University of La Rochelle; Francesco Goia, NTNU

## 15.1 Introduction

Adaptive façades, components, and systems are very promising technologies to improve energy and environmental performance of building. The characterization and analysis of their thermophysical and optical behaviour is of fundamental importance in order to increase the effectiveness of these systems and to promote both their development and implementation.

Characterization tests for adaptive façade systems and components are usually performed in large-scale facilities, such as real-scale buildings, indoor and outdoor test cells. In this section, twenty-one different facilities, mostly outdoor test-cells, developed for testing of adaptive façade solutions are presented. Features, advantages, limitations, and possible experimental activities for each typology of test cell are reported.

## 15.2 Overview of the experimental facilities

Buildings are crucial for the implementation of EU's energy efficiency policies, as nearly 40% of final energy demand and 36% of greenhouse gas emissions depend on houses, offices, commercial and other buildings. A fundamental way to reduce this environmental load is reducing space heating and cooling energy needs, as well as to improve the exploitation of daylighting, and of solar energy in general, by improving buildings' envelope performance. Material science is continuously providing new solutions that could potentially improve energy performance of the building envelope. Advancement in prefabrication, assembling and manufacturing technologies are providing new envelope systems incorporating several functions. A common characteristic of some emerging solutions is the adaptability to climate and eventually to users, i.e. a dynamic (active or passive) behaviour.

In order to develop further these solutions and to evaluate their performance to address designers and users aims and needs, there is a clear need to refine existing characterization/diagnostic tests to make them more useful, usable and consistent, and to develop new experimental methodologies [1] particularly suitable to address the capabilities of these systems to dynamically respond to different boundary conditions. The experimental assessment procedure may be performed by means of three main facility categories [2], each of these characterized by pros and cons: 1) outdoor real-scale facilities, 2) laboratory indoor facilities, and 3) outdoor test cells.

- Real-scale facility may give results for whole building performance and the effect of occupant behaviour, but their use to characterize the thermophysical behaviour of envelope components is usually complicated.

- Steady state tests may instead be performed in indoor laboratories under well controlled boundary conditions. These facilities may, sometimes, also be used to simulated dynamic (usually periodic) boundary conditions, however substantial limitations exist for solar radiation simulation in terms of geometry, power, time, and consequently costs for the tests. Furthermore, these systems usually do not allow user interaction to be studied.
- Outdoor test cells fill the gap between the two solutions since they may be used to perform calorimetric tests or comparative tests on building envelope components under real weather conditions. Test cells may also provide hygro-thermal characterization of elements; they may test materials weathering, rain tightness and frost damage. User interaction can also be analysed with these systems. As the results are strongly correlated with the local climate and the weather variability during tests, monitoring period can be very long and no standardization with acceptable uncertainties have been proven yet. The extrapolation of results to other configurations is sometimes complicated notably for the solar radiative gains (as a combination of geometrical and environment reason).

These outdoor facilities may perform both absolute tests, if only one test cell is available, or comparative tests, if two or more are instead installed. The PASSYS/PASLINK projects [3] developed a model for calorimetric tests based on well-defined envelope and system characteristics, while other research centres develop a guarded zone approach to minimize the error during calorimetric tests [4].

### 15.3 Starting point for mapping out the available structures

The Work Group 2 of the COST Action on Adaptive Facades (WG2) has proposed to establish a Mapping of Test facilities to evaluate key performances of Adaptive Façade Components. Surveying the partners within the Working Group 2, three main domains of competences were identified:

- Structure (Structure, Fire & Safety performances)
- Building physics (Thermal, Acoustic, Visual & Energy)
- On-site inspection

As these three domains can be characterized by very different objectives and representative features, it was decided to develop separated state-of-the-arts for each category. This section relates to Building physics with a strong hue on the field domains of thermal, visual and energy efficiency. Comfort evaluated as Indoor Environmental Quality (IEQ) can be extended to indoor air quality issues notably with façade components integrating a ventilation functionality.

As a solid basis for this work, Cattarin, Causone, Pagliano and Kindinis wrote a literature review about outdoor test-facilities to characterize building envelope. The paper contains a classification of existing test-cells according to the characterization method used to evaluate the tested components. The categories and subcategories are named as in Table 1 [5].

As a first attempt, following the above classification, a map of more than twenty one test-facilities was issued on a free mind-mapping software (Freemind) and a user manual (both available on the COST TU 1403 webshare server). This tool is very detailed trying to map out the location, type and number of sensors needed to establish low uncertainties energy budget on available test-facilities. The mapping was first populated after the review of scientific publications and then filled with specific details from the test-facility developers.

For a better readability, this mapping representation was transformed into a more condensed database (xlsx files also available on the COST TU 1403 webshare server), on which a few more contributions were added (Nearly forty test-facilities in total). Finally, nineteen test-facilities are presented in details in this booklet. Thermal performance characterization from full-scale measurement has been a leading subject for the past decades.

Table 1 - Classification of test-facilities according to energy performance evaluation

Main Categories	Sub-categories	Standard protocol
Tests in controlled laboratories	Guarded and calibrated Hot-box	ISO 8990
	Climate facilities	Other
Outdoor real-scale facilities	With occupancy	IPMVP, Comfort survey panels
	Without occupancy	Other, Qub, Isabele
Outdoor test cells	Test cells for comparative measurement	Other
	Guarded test cells for absolute measurement	Other
	Comparative & Guarded test cells for absolute measurement	Other
	Calibrated test cells for absolute measurement	PaSSYS - PaSLINK
	Outdoor test boxes	Other

Several research programmes with different experimental facilities performing from controlled laboratory test (Passys-paslink) to in-situ buildings (IEA Annex 58 - Reliable Building Energy Performance Characterisation Based on Full Scale Dynamic Measurements) were performed with success.

The test-facilities which have been retained for detailed presentation within this booklet are either recent developments having taken full advantage of the conclusions of previous results or long-working developments that have focused on adaptive components.

In the xlsx DataBase, other facilities were identified and are not highlighted in the prior paragraphs of the section. For example, the HIVE (University of Bath, UK) or VELIET (K.U. Leuven, BE) are more oriented on hygrothermal performance, with focus on materials and can be coupled with flooding and structure load aspects for the Hive. On the same basis, some PASLINK test-cells have been upgraded with humidity control systems (CEA, Chambéry, F). All these facilities could cope with adaptive technologies that are driven or controlled on vapor pressure differences between indoor and outdoor environments.

Outdoor real-scale houses without occupation such as INCAS in Chambéry, FR, or the EnergyFlexHouse in Taastrup, DK have available envelope technologies (Thermal brickwork with aerogel insulating render, timber frame, cast concrete, concrete block) and also permit occupant emulation in terms of energy and IEQ: heat, humidity and CO2. Those test-facilities were used to develop identification methodologies for building heat loss coefficient of in-situ buildings.

SolarBEAT (Solar Building Elements Application Testing) and the Test Façade of Vertigo Building in TU/e, Eindhoven, NL have vertical and sloped testbeds to evaluate the performances of BIPV technologies. An IEA annex report on BIPV research teams and facilities gives a thorough view of the worldwide existing force.



Calorimetric test facilities for transparent envelope are usually developed as indoor laboratory, and use a well-controlled solar simulator. The Fraunhofer in Holzkirchen, D, has however developed an outdoor prototype used to evaluate façade and roof components according to angle-dependent properties (platform can be tilted and rotated) while a robot with assembled sensors positioned in the calorimetric cell can map out the whole volume.

Indoor laboratories inclined to produce standard test were also identified mainly in the climate chamber or guarded and calibrated hot-box categories. Some have integrated features such as solar simulator (INTENT, Bozen, I) or dynamic control of temperature (LCCE Hot-box, Vitoria-Gasteiz, SP) and humidity for research purposes.

## 15.4 Why full-scale testing?

While the building construction field is facing the diffusion of a wide variety of complex building envelope components (passive, active, bioclimatic, biomimetic) claiming to contribute to the reduction of building energy use or to improve the occupant comfort, few were actually characterize according to dynamic responses to climatic solicitations.

The inner features they are claiming make them difficult to assess by a unique value of Solar Heat Gain Coefficient or Thermal transmittance evaluated in steady-state laboratory conditions. These components need to be monitored under dynamic weather conditions, the recording protocols have to be clearly stated to ensure a correct model of their thermal behavior, of their effectiveness in real conditions and of their impact on energy saving and IEQ.

Researchers are now challenged in finding experimental characterization of innovative envelope components which performance evolves throughout the day and / or the year. An explicit description of experimental procedures addressing particular objectives should be brought to the community with a clear understanding of underlying measurement uncertainties. Moreover, certain adaptive components might need substantial energy to switch from one configuration to another, keeping functional needs with a minimum energy input being a major requirement. This aspect draws attention in the protocols.

Because changes in complex building elements may take place at different components/systems levels (driving factors at macro or micro scale) and interdependency among different performance aspects (e.g. energy, lighting and acoustical) it is important to well identify the metric to be evaluated prior to start setting up an experiment. A well-defined experiment can also highlight possible conflicts in terms of performances.

The choice of measurement protocols used in the investigated test-facilities has to be linked with the 2 other tools created in the framework of WG2:

- Metrics and requirements database (xls sheets - Task 2.1 Avesani)
- Numerical method capabilities (xls sheets – Task 2.2 and 2.4 Favoino)

Performance metrics should be selected to answer specific questions. The performance metrics must be directly related to the performance objectives.

Clear, consistent, and accurate performance metrics help researchers to understand what drives

building energy performance, help designers and owners to build and operate more efficient buildings, and help policy makers to formulate meaningful performance goals and track progress toward those goals.

While the question of numerical method capabilities is still open, the care provided to recording (precision, uncertainties) is not identical when using the values to verify, tune or validate CFD results or BES results. Long-term experimental evaluation can catch the response associated with phenomena of different scale duration, from short-term (sunspot control) to long-term properties (drift over time due to wear).

The mapping of the test-facilities itself is built like a catalogue of available test-facilities to perform experimental characterization of considering different metrics and requirements at component level for Adaptive Façade and shall be used by:

- Scientific community in order to compare results or as starting elements to build a new test-facility,
- Industrials, engineers and architects in order to find an experimental facility and organization to characterize their products,
- Developers of numerical code in order to find an experimental data to validate their model.

## 15.5 Metrics and categories of test-facilities

As pointed out in Metrics and requirements database, amongst typical metrics used to describe energy-related aspects at component scale, the performance are generally characterized by Solar factor  $g$  [-], Solar transmission  $\tau$  [-], U-value [ $W/m^2.K$ ], Correction factor  $b$  [-], Pre-heating efficiency  $\eta$  [-], Dynamic insulation efficiency  $\varepsilon$  [-] while comfort is evaluated through Top [ $^{\circ}C$ ], PMV [-], Solar adjusted PMV\* [-].

The first two performance indicators are usually measured at material-scale in laboratory conditions and then extrapolated at component scale through numerical calculation. These tests not being evaluated steady state and mono-dimensional heat flux for U-value, in presence of standardized solar source for g-values, do not take into account their variability in real-outdoor climate. However, in a protocol of comparison of different elements under similar boundary conditions, these tests remain the most robust.

The following twenty one test-facilities, present outdoor test-cells, controlled indoor laboratory experiments (in which effect of outdoor weather conditions can be partly mimicked by dynamic schedules) and real-scale building demonstrators which results can be used with cautious sensitivity to compare standardized values (U, g) to exposed findings or real-use (i.e. real buildings under operation) which are mainly for validation of BES tools or influence of users because it is hard to isolate a single variable while both external, internal and interactive factors are acting on the measured system.

Sub-categories that mainly have been attributed to outdoor test-cells can be of 3 types as in Figure 1 [5]:

- Category I allows the minimisation of the side heat flow by insulating the side walls. Heat flow through the component is deduced from calibration with a reference test component for a range of operating conditions.

- Category II reaches the minimisation of the side heat flow by minimising the temperature difference across the internal walls. Heat flow through the component is deduced from the measurement of the active plant.
- Category III implies that Similar conditions must be ensured (prior to real-test). Thus, the performance of the component with respect to a reference element being tested at the same time can be assessed.

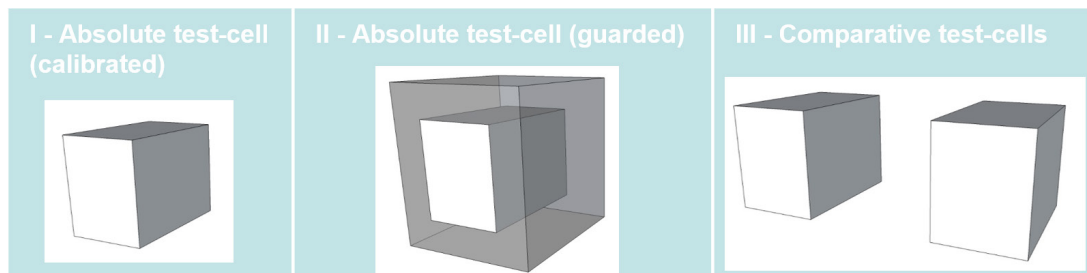

Figure 1 - Illustration of the three Outdoor Test-cell categories

The sub-category of the test-facility will be found in the “Construction and Boundaries” section of each contribution.

## 15.6 Accurate setup fitting drawn objectives

All the test-facilities described in the booklet may evolve to a certain extent to adapt the experimental protocol to a specific envelope element. Under careful preparation and using the right calibrated sensors, fine data and nice analysis can be obtained.

However each test-facility has defined features that more likely to adapt to the displayed objectives of a certain technology. These features include: dimensions (representatively of the indoor space), geometry capabilities (thermal bridges created by a particular configuration), thermal performance of the construction (for example evaluating a component with higher thermal transmittance than the test-cell walls would prove being difficult), management of boundary conditions (toward standardized evaluation), monitoring capabilities (available sensors that are expensive to maintain into rightful calibration state), exposure (tilt changing convective heat transfer conditions and orientation (modifying storage/release or wetting/drying cycles), climate (stochastics on heat-related, wind, rain, freeze-thaw events) and HVAC capabilities (ventilation strategies, coupling with specific heating/cooling modes, such as radiant, air transported, electrical, etc.).

The monitoring material is always prepared to perform the full closure of an energy budget on a determined element (component) or volume (test-cells, building). The budget can be illustrated as:

$$Q_{int} + Q_{sol} + Q_{trans\ ext} + Q_{trans\ GZ} + Q_{infiltr} + Q_{heating/cooling} = 0 \text{ (Figure 2)}$$

The solar budget within a test-room is often difficult to manage, calorimeter configurations are often necessary to reduce the uncertainties (water bearing absorbers). The internal gains are usually reduced to a minimum or mimicked through electric coil or thermal mannequin, and usually measured. The heat transfer through the adiabatic walls can be verified with heat tiles (PAS method [14]) and special care shall be given to thermal bridges (which are often much greater than in a normal building because of the surface to volume ratio of a test cell). Infiltrations have to be regularly checked and corrected at each new component setup. The heat transfer on the exposed component is generally handled by surface temperature measurements, as well as, heat flux

measurements. The uncertainty can, in some specific situations, be of relatively higher level because of the intrusiveness of sensors more than to the calibration method itself.

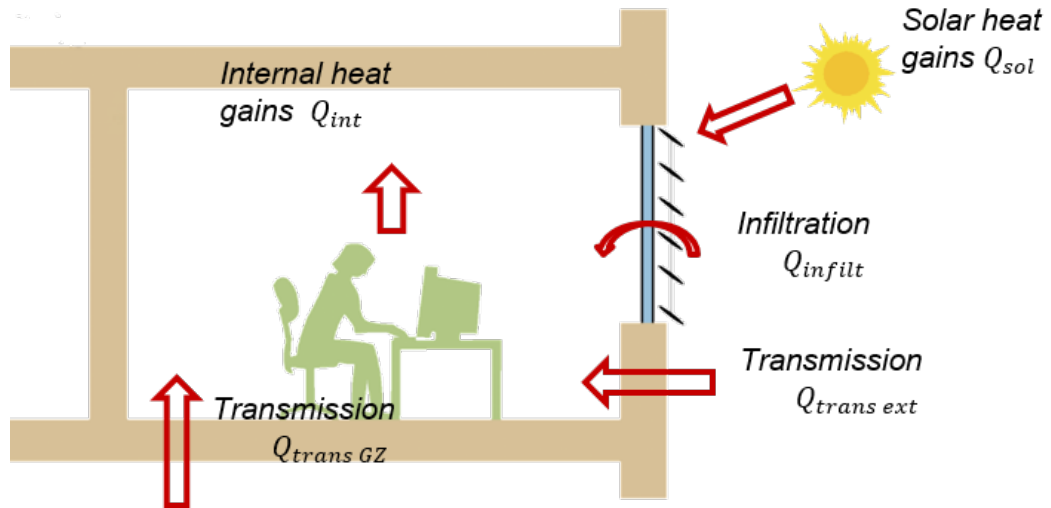

Figure 2 - Scheme of Heat balance under steady-state conditions

In real-scale rooms, investigators panel can be parallelly used to assess/ rate their sensations to levels of Comfort model or Glare model defined according to measured physical properties [6].

The choice of the sensors (time response, accuracy, calibration method adapted to the environment in which they are used), their configuration, and number is often relative to the theoretical model to be compared with. The influence of the sensor and possible modification of heat and mass transfer phenomenon relate directly to the finesse of the studied geometrical scale. Furthermore, as most of the Building Energy Simulation models are multizonal, the representativeness of averaged values in a zone is important. In order to review the capabilities of each test-facility, their ongoing monitoring equipment is fully described.

Usually, each test campaign, each facility configuration is initially programmed aiming to a significant modularity, after a few experimental campaigns, the acquired experience and the refined uncertainty budgets allow the performance of the facility and its specificity to be refined. Ideally, the weakest part of the set-up is also identified by the researcher, and the flaw can be corrected by using the right sensor or cross-verifying some results with other techniques. An overview of the twenty one facilities and their specificity is given in Table 2.

The climate information is based on the Köppen-Geiger classification, the summarized outdoor test-facilities covers real climate ranging from, Hot-summer Mediterranean climate (Csa), Humid subtropical climate (Cfa), Temperate oceanic climate (Cfb), Warm-summer Mediterranean climate (Csb), Warm-summer humid continental climate (Dfb), Sub-arctic climate (Dfc) and Hot semi-arid climates (Bsh).

Table 2 - Overview of the twenty-one detailed test-facilities

Name	Location	Climate	Specificity	Typology
The Cube	Aalborg, DK 57°02'N; 10°0'E	Dfb		OTC with guarded volume
ESTP outdoor test cell	Cachan, F 48°79'N; 2°33'E	Cfb		OTC with and without guarded volume
TWINS facility	Torino, I 45°06'N; 7°66'E	Cfa	Positioned on wheels allowing any orientation	Two comparative OTC
ZEB Test Cells Laboratory	Trondheim, N 63°41'N; 10.41'E	Dfc		Two comparative OTC with two independent guarded volumes
Tipee testing facility	La Rochelle, F 46°14'N; 1°16'E	Cfb	Double-height absolute guarded test-cell (9 m high)	Five OTC (two comparative) with guarded volume
LECE Building Component Energy Test Laboratory	Tabernas (Almería), ES 37.1°N, 2.4°W	BSh		Four OTC fully exposed to outdoor. OTC for roofs Single solar chimney. Monozone building.
PIV Particle Image Velocimetry	Madrid, ES Indoor laboratory	NA	fully-equipped laboratory for Optical method of flow visualization and quantification of instantaneous velocity fields	Indoor laboratory
PSE ARFRISOL Research Energy Demonstrator Office Building Prototypes	Almería, ES, 36°50'N, 2°24'W Tabernas, 37.1°N, 2.4°W Madrid, 40°27'N, 3°44'W San Pedro de Anes, 43°25'N, 5°42'W Cubo de la Solana, 41°36'N, 2°30'W	BSh Csa Cfb Csb	Office building fully instrumented for energy research under 5 spanish climatic regions (Almería, Madrid, Asturias, Soria)	Outdoor Real-scale Building Prototypes
GESLAB, Global Energy and Sustainable Laboratory in Building	Pozuelo de Alarcón, Madrid, ES 40°24'N 3°50'W	Csa	Eight adiabatic prototypes for facade solutions and three for roofs solutions. Five solar houses with 40 Kwh monitored grid.	Eight OTC fully exposed to outdoor. Five Real-scale Building Prototypes
Multilab	Bolzano, I 46°29' N 11°20'E	Cfa	Cells are controlled in temperature and humidity and they are positioned on a rotational platform allowing any orientation	Two comparative OTC with guarded volume
TRIUMF Laboratory	Aalborg, DENMARK 57°02'N; 10°0'E	Dfb	Full modification of ventilation terminals possible	Two comparative OTC with guarded volume
Labimed Test-cell	Florence, I, 43°79'N; 11°25'E	Csa	Paslink OTC on a rotational platform allowing any orientation	OTC fully exposed to outdoor.
Building Future Lab	Reggio Calabria, I	Csa	Possible operation outdoor	Indoor laboratory
Building Envelope and Solar Technologies Laboratory	Moret-Loing-et-Orvanne, F 48°22'N 2°50'E	Cfb	Well-adapted to renovation of residential building stock	Twelve OTC (four comparative) with guarded volume
Large Scale Vertical Building Envelope Climate Simulator	Trondheim, N	NA	Climate simulator	Indoor laboratory
Dual Air Vented Thermal Box	Milano, I	NA	Designed to study permeable façades	Indoor laboratory
MATELab	Cambridge, UK 57°02'N; 10°0'E	Dfb	Designed for human comfort evaluation	Outdoor real-scale room
ZEB Living Lab	Milano, I	Csa	Fully instrumented NZEB laboratory	Outdoor real-scale Building
HCU Studio for Room Comfort	Hamburg, GE 53°32'N; 10°0'E	Cfb	Full scale test room with reconfigurable façade, designed for user interaction and acceptance tests	Outdoor real-scale test room
PS Test Façade	Eindhoven, NL 51°26'N; 5°29'E	Cfb	Full-scale test Rooms with Reconfigurable Façade, designed for user interaction and acceptance tests	Outdoor real-scale test room
Multifunctional Façade Lab	Bolzano, Italy	NA	Guarded Hot-Box, Solar simulator and measuring system adapted to Analyse the performance of multifunctional facades	Indoor laboratory



# 16 Description of experimental test facilities, characteristics and methods

Francesco Goia, NTNU; Maxime Doya, Típee S.A.S & University of La Rochelle

The development of common, standardised infrastructures and procedures for the characterisation of adaptive façade technologies is a complicated task. This is in particular due to the very large range of technologies and aspects that are classified as adaptive. Nonetheless, when the focus is placed on the energy and indoor environmental performance of adaptive facades, there is a common understanding in the research community on the need of tests and analysis on full-scale prototypes. These tests need to be carried out in field or, preferably, in test facilities capable of replicating the complex dynamic behaviour of both the outside and the inside environment in a predictable and controllable way.

Such a requirement led to the growing development of full-scale test facilities. These are research infrastructures that may have different characteristics (in terms of geometry, systems, controls, etc.) but are all aimed at making the performance assessment of envelope systems characterized by dynamic behaviours, such as adaptive facades (Table 2, Figure 1), possible.

This chapter gives a wide vision of this class of experimental test facilities adapted to evaluate the thermal performance or comfort levels for adaptive technology components. The different aspects of performances highlighted by each system are thoroughly explained as well as the control phenomenon. Twenty-one test facilities are studied in this section, and provide a good overview of the different typologies and systems available in Europe. Each of these facilities was (or is now) developed in the context of scientific research, and thus aimed at assuring high quality and repeatable results. However, these systems are not only used for testing of existing solutions, but also play a crucial role in the development of new technologies.

The design (and operation) of a test facility is always a challenging exercise, where different requirements are to be taken into account, resulting in a final solution that is often a compromise between different radically opposing concepts. This is done in search of the greatest flexibility in the use of the facility in order to allow the widest possible range of tests to be carried out without impairing the quality of the measurements. This inevitably leads to the development of very different systems, each one with its own characteristics, potentials, and limitations, which are highlighted in the detailed description of each system. In general, all these systems aim to make it possible to carry out performance characterisation tests under controlled boundary conditions, and in relation to adaptive facades, also to test dynamic control strategies.

The development of common experimental protocols is also another, very interesting (and challenging) topic, which goes hand in hand with the development of the test facilities. The following elements should always be included in the design of the experiment (and of the experimental facility), and in its execution:

- Reasons for choosing a particular typology of test-facility
- Measurement and data analysis characteristics
- How to use the results for quality assessment (shared performance indicators)

- Reliability of results: evaluation of measurement and modelling errors, with threshold values giving a sound assumption for device calibration needs

The contribution to the test facilities and methods is complemented with a bibliography section where specific research works on the establishment of experimental protocols or the characterization of adaptive technology performances are reported. This aims to stimulate further scientific discussion and the developments of more comprehensive guidelines for both test apparatus and procedures.



Figure 1 - Locations of twenty-one test facilities in the COST Action

# The Cube

## Absolute and relative guarded test cell

► Aalborg University, Aalborg, DENMARK

### Aim of the test facility

The Cube (Figure 1) is an outdoor full-scale test facility located near to the main campus of Aalborg University, Denmark. Initially, the test facility was envisioned as a way to study the actual size façade solutions under real weather conditions. Later on, it was modified to allow investigation of following systems as a stand-alone solution or in combination with each other:

- a window or a façade system (i.e. double-skin façade) with or without shading solution;
- radiant wall terminals;
- ventilation system combined with or without active chilled beams.

### Description of the test facility

The Cube consists of several domains, illustrated in the Figure 1. A test room, with one wall connected to the outdoor environment and remaining walls attached to a guarded zone is constructed within the experiment room. Façade elements, cooling, heating, lighting and ventilation principle in the test room can be adjusted according to the required boundary conditions.

The west wall of the test room is equipped with six radiant panels, resulting in a total dimension of the activated surface equal to 3.6 m x 1.9 m (length x height). The radiant panels are composed of capillary pipes (3.35 mm diameter and 10 mm spacing) mounted at the back of a plasterboard. The cooling capacity has been measured under experimental conditions and is equal to 21 W/m<sup>2</sup> floor (for  $\Delta\theta = 8\text{ }^\circ\text{C}$  (EN 1264-3 2009)).

The active chilled beam unit is located in the middle of the ceiling and has the dimensions of 0.6 m x 0.6 m. The water flow in the cooling coil varies between 100 and 200 l/h, and the cooling capacity of the active chilled beam is equal to 25 W/m<sup>2</sup> floor (for  $\Delta\theta = 8\text{ }^\circ\text{C}$ ).

The ventilation air is supplied to the room using the same unit as the active chilled beam. If the inlet air temperature is required to be constant, then the ventilation air is supplied from the guarded zone, which is temperature controlled. The infiltration and exfiltration rate between the guarded zone and the test room is minimized by keeping zero pressure difference between the test room and the guarded zone. The infiltration rate is below 0.3 l/(s · m<sup>2</sup> floor) at 50 Pa.

### Monitoring and control system

Seven energy meters are mounted: one for the active chilled beam and six for the radiant panels (one meter per panel). Each meter has been calibrated and the uncertainty of the measurement has been estimated to  $\pm 0.9\text{ L/h}$  for the flowmeters and  $\pm 0.06\text{ K}$  for the Pt-500 sensors. Airflow through the ventilation system is measured using an orifice plate located before the inlet (total uncertainty  $\pm 7.5\%$ ).

The outdoor boundary conditions are measured with equipment placed locally at the test facility. Irradiance is measured on the roof of the building

(global, 3% uncertainty and diffuse, uncertainty max 10%) and on the southern façade (total, 3% uncertainty). Wind speed and wind direction may be measured at 6 different heights above the ground on a wind mast near the building. A large carpet is placed on the ground in front of the southern façade of the Cube to achieve uniform reflection from the ground (carpet reflectance is 0.14).

The test room is equipped with a large range of sensors (over 300), which can be adjusted depending on the purpose of the set-up. Thermocouples and thermopiles have been placed in the construction elements (type K thermocouples, with uncertainty  $\pm 0.15\text{ }^\circ\text{C}$ ). Air temperature is measured using silver-coated thermocouples, and protected by mechanically ventilated silver shield, in order to avoid influence of solar radiation. Anemometers, lux meters, relative humidity sensors, thermal manikins, power meters can then be added to the set-up. All sensors are individually calibrated and the logging frequency is varying between 0.1 Hz up to 5 Hz depending on the type of measurement. As a result, it is possible to establish a complete heat balance for the test room.

All data are logged using LabVIEW. This interface is also used to control the different equipment of the test-room. The modularity of this software makes the set-up highly flexible.

### Construction and boundaries

Walls are made of Plasterboard + EPS + Mineral Wool for a U-value of 0.13 W/m<sup>2</sup>·K. Thermal Guarding zone confines all walls in the test room, except for the exterior façade wall.

**Number of test beds** – 1, with possibility for modification

**Exposure** – South

**Climate** – Aalborg, 57°02'N; 10°0'E - Dfb

**Heating** – Heating coil, Radiant panels

**Cooling** – Cooling coil, Radiant panels

**Ventilation** – Independent mechanical fans for Intake and exhaust [0-4 Vol.h<sup>-1</sup>]

### Dimensions and capabilities

The internal dimensions of the test room are 2.76 m x 3.60 m x 2.75 m (width x length x height), resulting in a floor area of approx. 10 m<sup>2</sup>.

Anchorage of the tested wall is made on wooden beam.

### Involved person(s):

Olena Kalyanova Larsen,  
Per Heiselberg

### Operating since: 2018

### Contact person(s):

Olena Kalyanova Larsen [ok@civil.aau.dk](mailto:ok@civil.aau.dk)

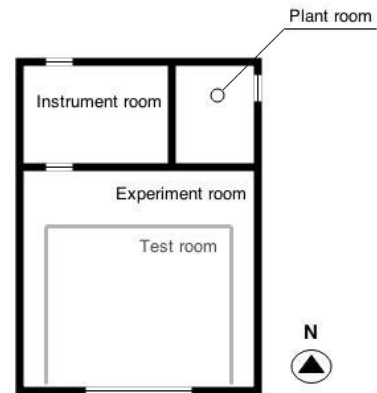

► Fig. 1: Plan drawing of the Cube

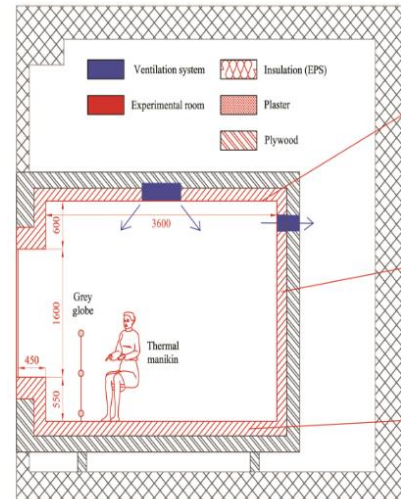

► Fig. 2: Vertical section of the Cube with details on construction elements



► Fig. 3: Façade test beds

# ESTP outdoor test cell

## Absolute guarded test cell

► Institut de Recherche en Constructibilité, Université Paris-Est ESTP, FRANCE

### Aim of the test facility

The outdoor test facility under development in Paris at the Ecole Spéciale des Travaux Publics, du Bâtiment et de l'Industrie (ESTP) in collaboration with the end-use Efficiency Research Group of Politecnico di Milano, will allow to obtain reliable estimates of thermal performance indicators of transparent and opaque building elements. A detailed discussion of design choices and early simulation results can be found in [7]. The major design aim is to build a facility with high accuracy for calorimetric tests but also flexible enough to be used for indoor environmental quality (IEQ) investigations.

### Description of the test facility

In order to optimize both calorimetric measurements and IEQ campaigns, the first step is the decoupling of the two test typologies. This has led to a configuration by which the calorimetric tests are carried out in a dedicated metering box, while the IEQ tests are carried out in a larger room. The "room" works as a guard zone during the calorimetric tests. A scheme of both configurations for the operation of the test cell is presented in [7] and can be seen in Figure 2.. When the guard zone is used as an office space, it is possible to apply a false ceiling to be used as a technical space for ventilation and lighting systems.

The proposed cooling system consists of a high-stability distilled-water storage (keeping water in a range of  $\pm 0.1$  °C) which feeds both the terminal units of the guard zone and the metering box. In particular, the metering box is equipped with a solar absorber and an auxiliary cooling battery.

The solar absorber, consists of two stainless steel (AISI 304) sheets welded and inflated at high pressure in order to generate internal channels for the passage of distilled water. Distilled water is chosen for the possibility to accurately know its specific heat capacity at constant pressure (cp), needed for the computation of the cooling power. The absorber plate will be coated with a selective TiNOX® coating with solar absorption coefficient  $\alpha \sim 95$  % and thermal emissivity  $\varepsilon \sim 4$  %. The solar absorber is also used as baffle in order to help keeping nearly-constant convection conditions on the internal surface of the test element.

The facility will be positioned with its south façade facing an open meadow, thus the hypothesis of unobstructed exposition is well met. A ground reflectance of 0.25, typical of short grass lawns, will be considered. A dedicated structure will protect the guard zone envelope from snow loads and rain and it will shade it from solar irradiance, with the only exception of the south façade where the test sample is installed.

### Monitoring and control system

The monitoring system considers all the most relevant heat flux and environmental quantities contributions:

- heating power and electrical powering of

circulation fans and active sensors: measured by means of a high-precision wattmeter (accuracy  $\pm 0.02$  %);

- cooling power: calculated from the measurement of the water mass flow (Coriolis-based mass-flow meter, accuracy  $\pm 0.5$  %); and the temperatures at the envelope of the metering box (Pt100 resistance temperature detectors (RTDs), accuracy  $\pm 0.07$  °C);

- weather conditions: a dedicated weather station is placed on a roof of the ESTP campus, and allows the direct measurement of: global and diffuse solar irradiance, air temperature, relative humidity, wind speed and direction and rainfall water.

- Indoor Environmental Quality main parameters will be monitored during comfort tests. The set of available sensors includes Pt100, T-type thermocouples, omnidirectional anemometers, capacitance relative humidity sensors, globo-thermometers, luxmeters and a gas phase photoacoustic spectroscopy unit. More sensors will be used for dedicated visual and acoustic comfort tests.

The monitoring and control of the facility will be performed by means of an integrated National Instruments system. As concerns the control logics, they are presently being tested by means of a thermal model described with more details in [7].

### Construction and boundaries

The envelopes of the metering zone and the guard zone are constructed with prefabricated sandwich panels, formed by two 0.6 mm stainless steel sheets and 15 cm thick injected-polyurethane foam. The resulting thermal conductance is equal to  $0.153 \text{ W}\cdot\text{m}^{-2}\cdot\text{K}^{-1}$ . A particular care is taken in order to minimize the thermal bridges around the entrance door and the interface where the test component is installed.

**Number of test beds – 1**

**Exposure – South**

**Climate – Cachan, 48°79'N; 2°33'E - Cfb**

**Heating – Heating coil, Radiant panels**

**Cooling – Cooling coil, Radiant panels**

**Ventilation – No Data**

### Dimensions and capabilities

The internal dimensions of the metering box used for calorimetric measurements are (WxLxH): 3.0 m x 1.2 m x 3.0 m, while the internal dimensions of the guard zone are (WxLxH): 4.1 m x 6.2 m x 4.0 m



► Fig. 1: 3D perspective of the new test cell facility under construction at ESTP (Paris)

► **Involved person(s):**

Andrea Kindinis

► **Operating since:**

Construction in progress

► **Contact person(s):**

Andrea Kindinis [akindinis@estp-paris.eu](mailto:akindinis@estp-paris.eu)



# TWINS (Testing Window INnovative Systems) Façade full scale outdoor comparative test facility

► Department of Energy, Politecnico di Torino, ITALY

## Aim of the test facility

TWINS (Testing Window Innovative Systems) is a measurement facility built up with the main aim to test the actual performance under real boundary conditions of advanced active transparent/opaque façades and, more in general, responsive building envelope components integrated with HVAC systems [8]. Data are collected mainly in order to assess the energy performance of the façade at the component scale (analysis on the overall energy consumption of the cell cannot be performed); analyses on thermal comfort and of lighting and acoustic related aspects can be also carried out. Moreover different numerical models of responsive façades (Transparent Ventilated Double Skin façades with cavity solar shading [9] and Smart glazing [10]) were validated adopting this test cells. Among the different measurements also a method for non calorimetric characterisation of total solar energy transmittance (g-value) for transparent façade was developed and validated [11].

## Description of the test facility

The experimental test rig consists of two identical outdoor test cells (Figure 1). In the original idea one cell had to be used for reference purposes, adopting a conventional double glazed façade, and the other cell was designed to host different configurations and typologies of responsive façades. The use of two guarded volumes instead of a single surrounding volume increases flexibility in experimental procedures and experimental activities, allowing to make direct comparisons among various configurations and to perform sensitivity analyses even when the boundary conditions were not exactly the same, i.e. assessing the impact on the façade overall energy performance due to different façade features, parallel tests of the same building envelope technology/equipment with different indoor air temperature set-points, occupancy schedules or operations. In the latest years, the high number of components to be tested made it necessary to use the two test cells independently, reserving nonetheless a fraction of the façade to host a reference sample.

## Dimensions and capabilities

The internal sizes of the test cells were chosen accordingly to the IEA-SHC TASK 27 specifications reproducing the typical façade modules of office buildings. Each TWINS is 1.6 m wide, 3.6 m long and 2.5 m high. Smaller façade components can be hosted in the façade frame as well.

## Construction and boundaries

Walls, floor and ceiling are made up of 48 mm thick sandwich panels, in double painted sheet-steel with expanded polyurethane, with a U-value of 0.43 W/m<sup>2</sup>K.

The test cells are located on a flat roof, in a position which is not shadowed along the entire year. They are mounted on wheels in order to be rotated to change the façade orientation, but so far most of the experimental activities were done for South-exposed façades.

## Monitoring and control system

The indoor air temperature of both cells is controlled, with a tolerance of 1 °C, by means of a full air system. Usually the temperature set point is fixed at 20 °C in winter, 23 °C during the mid-seasons and 26 °C in summer. The air from the AHU is distributed through a perforated textile channel as uniformly as possible in order not to negatively influence the response of the sensors located on the internal facing surface of the façade. The ventilation system is completely independent of the air conditioning system (for indoor air temperature control), and the air changes can be adjusted as needed.

The measurement apparatus consists of thermocouples, heat flux meters and pyranometers connected to a data logger. The number and typology of sensors depend on the façades features and they change according to the investigated technology and the purpose of the experimental activity (e.g. a comprehensive investigation of the thermal and fluid dynamics phenomena involved, or the characterization of the performance of the façade, both in terms of energy efficiency and thermal comfort). The measurement chain is preliminary calibrated and/or verified in the laboratory; resulting accuracies are 0.3 °C as far as temperature is concerned, and 5 % for heat flux measurements, 3 % for the solar radiation measurements. During the design and set up of the probes, particular attention is paid to the problem of the measurement of temperatures and heat fluxes in the presence of incident solar radiation and, in order to reduce the errors which can arise under these conditions, particular care must be taken to properly shield the sensors.

The following sensors are usually adopted: thermocouples (T/J type) to measure the temperature of the indoor air and the surface temperatures; ventilated thermocouples (T/J type) to measure the air temperature in the air gap; a Pt 100 probe to measure the outdoor air temperature; heat flux meters to measure the thermal flux through the façade; pyranometers located vertically on the plane of the façade and behind the façade to measure the solar irradiance. The measurements are typically performed with a scan rate of 15 min and the readings are stored in an internal memory with a capacity of about 1 month of monitoring or directly downloadable through a website. Comprehensive outdoor climate data are also measured at another location within the University site.

**Number of test beds – 2**

**Exposure – South** (can be rotated)

**Climate – Torino, Italy, 45°06'N; 7°66'E - Cfa**

**Heating – Electric heating coil, full air system.**

**Cooling – Cooling coil, full air system.**

**Ventilation – Primary Ventilation, Variable Air Volume System.**



► Fig. 1: View of the TWINS test facility.

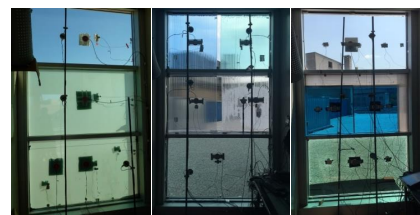

► Fig. 2: Internal view of TWINS test facility, while testing different switchable glazing technologies [12]

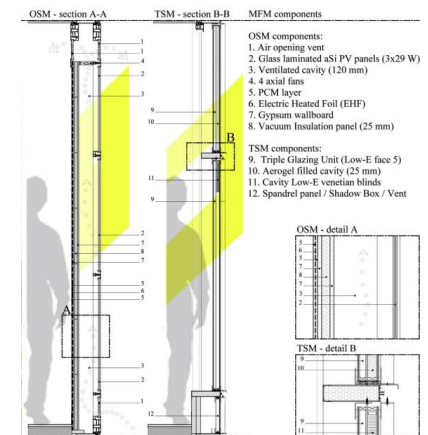

► Fig. 3: Scheme of the façade monitoring system of the TWINS test bed [13].

## Involved persons:

Fabio Favoino,  
Valentina Serra,  
Marco Perino,  
Alfonso Capozzoli

► **Operating since:** 2001

## Contact persons:

Fabio Favoino [fabio.favoino@polito.it](mailto:fabio.favoino@polito.it),  
Valentina Serra [valentina.serra@polito.it](mailto:valentina.serra@polito.it),  
Marco Perino [marco.perino@polito.it](mailto:marco.perino@polito.it)

## Website:

[www.tebe.polito.it](http://www.tebe.polito.it)

# ZEB Test Cells Laboratory

## Absolute guarded test cell

► Norwegian University of Science and Technology (NTNU) & SINTEF, Trondheim, NORWAY

### Aim of the test facility

The ZEB Test Cells Laboratory is an experimental facility developed within the Research Centre on Zero Emission Buildings at the Norwegian University of Science and Technology, a joint-project between NTNU and SINTEF, with the support of several partners of the Research Centre.

The primary aim of the Test Cells Laboratory is the testing of full-scale building envelope components (opaque and transparent, adaptive or conventional), under real outdoor and indoor boundary conditions, in a Nordic climate context. However, the facility is characterized by a certain degree of flexibility, which allows interaction between building envelope components and HVAC terminal units to be tested too, as well as the interaction between building envelope, building equipment and building technologies (e.g. influence of thermal inertia, finishing of indoor surfaces). Furthermore, indoor environmental quality analyses, with or without the presence of users in the test cells, are also possible in this research facility.

### Description of the test facility

The test facility architecture is based on two identical test cells surrounded by two independent guarded volumes. The walls, ceiling and floor of each test cell are made of prefabricated panels with 0.6 mm stainless steel sheets and 10 cm thick injected-polyurethane foam.

The façade test area (2.4 m x 3.3 m) is exposed to outdoor conditions and faces south. The two cells are suspended from the floor of the main building (0.5 m). The temperature of the air surrounding the test cells is kept at the same level of the test cell indoor air temperature so that, if the inertial phenomena are neglected, the test cells envelope should act as an adiabatic surface, and the energy variations in the indoor air volume of the cell are only due to energy flows through the façade element under test.

Thermal energy for cooling and heating of the two test cells and two surrounding volumes is managed by four independent Air Handling Units (AHUs). At the time being, no control over the relative humidity is installed, but plans for future configuration of the AHU to control latent load have been developed.

In order to allow experiments with users in the test cells, fresh air is supplied to the two test cells through two of the AHUs, while the other two (controlling the temperature of the guarded volumes) are acting on recirculated air. A smaller, independent AHU provides fresh air intake to the other spaces of the test cell building (a meeting room, a kitchen and a WC) and to the two guarded volumes.

Each test cell is also equipped with terminals of one hot-water and one cold-water circuit for installation of different HVAC terminal (with possibility to control the supply temperature and flow rate of the hot/cold water).

### Monitoring and control system

The monitoring and control system of the test facility are integrated in just one hardware and software system, based on the National Instrument CompactRIO family and on the programming language LabVIEW, respectively. Acquisition of signals for both control and monitoring, as well as control signals, are managed centrally by one controller, while a network of distributed chassis for data acquisition systems allow the total length of sensors and control wires to be reduced to a minimum extent, still allowing a very robust management the entire installation – all the sensors and actuators interacts with just one controller.

The code for data acquisition and control of the HVAC components is developed in LabVIEW environment and allows a high degree of flexibility to be achieved.

The list of sensors installed in the test cells at the time of the opening includes: TJ thermocouples (for walls internal/external surface temperature) with accuracy of  $\pm 0.5$  °C; four-wire PT100 (accuracy of  $\pm 0.1$  °C in the environmental temperature level range) for indoor air temperature, globe thermometer, and sensors in the HVAC plant for control; hot-wires sensors and differential pressure sensors for monitoring of supply/extract airflow through different procedures (accuracy  $\pm 10$  %); thermal energy meters (made of PT100 and ultrasonic flow meter) for monitoring of waterborne heating/cooling thermal energy demand (accuracy  $\pm 1$  %); a weather station for monitoring of boundary conditions, including solar radiation on different planes; several sensors for monitoring of thermophysical and lighting performance of façade components (among which, thermocouples, heat flux meters, pyranometers, luxmeters).

### Construction and boundaries

The structure with two independent guarded volumes instead of a single surrounding volume increases flexibility in experimental procedures and experimental activities, enabling for example parallel tests of the same building envelope technology/equipment with different indoor air temperature set-points, occupancy schedules or operations.

### Number of test beds – 2

### Exposure – South

**Climate** – Trondheim, 63°41'N; 10.41'E - Dfc

**Heating** – Airborne power (test cell): 3.0 kW

**Cooling** – Airborne power (test cell): 1.0 kW

**Ventilation** – Variable airflow (test cell) up to 490 m<sup>3</sup>/h

### Dimensions and capabilities

Each test cells has the following internal dimensions (W x L x H): 2.4 m x 4.2 m x 3.3 m.



► **Fig. 1:** Exterior view of the ZEB Test Cells Laboratory, with the two cells on the left-hand side of the building.

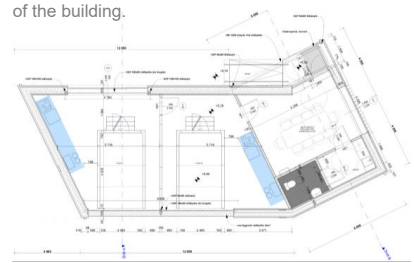

► **Fig. 2:** Plan of the ZEB Test Cells Laboratory. The twin test cells and the two control volumes can be seen on the left-hand side of the plan.

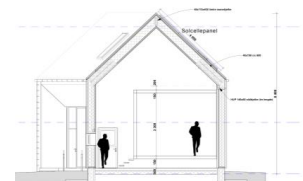

► **Fig. 3:** Vertical section of the ZEB Test Cells Laboratory with one test cell and one guarded volume.



► **Fig. 3:** View of the inside of one of the twin test cells.

- **Involved person(s):** Francesco Goia  
Alessandro Nocente  
Steinar Grynning  
2016
- **Operating since:**
- **Contact person(s):** Arild Gustavsen  
arild.gustavsen@ntnu.no  
Terje Jacobsen  
terje.jacobsen@sintef.no
- **Website:** [www.zeb.no/index.php/en/laboratories](http://www.zeb.no/index.php/en/laboratories)



# Tipee Façade Test

## Absolute and relative guarded test cell

► Tipee S.A.S & University of La Rochelle, La Rochelle, FRANCE

### Aim of the test facility

A test-facility for roof and façade components is developed in the Tipee Platform affiliated with La Rochelle University. This real-scale room facility provides in-situ tests (outdoor real conditions) of building envelope components through measuring energy budgets within a controlled cell. The facility is developed in order to evaluate component performances according to measuring in-situ energy budget through developed procedures of identification of dynamic thermal properties. PASLINK testing procedures [14] can be pursued but new identification inverse methods can be tested.

Experimental campaigns provide data to adjust the numerical models of the studied component, taking into account the dynamic effects that occur within the developed technology. Seasonal thermal behavior can be studied in different periods and associated cooling and heating demand can be characterized.

### Description of the test facility

Five cells are implemented, i.e. five independent tests could be carried out simultaneously. Two pairs of twin cells (for both façade and roof) are required in technical specifications assuming comparison purposes might be needed for scientific evaluation of 2 technologies. The last test bed is built over a double height and will be used to test component requiring an application on large volumes (industrial buildings, ventilated façade...). Façades rigs are oriented south-southwest.

Special attention is given to design ties technology to bond the test component to cells. The concept is such as the technology should allow an evaluation of thermal performances of most of building envelope's technical solutions with or without their original ties. This feature means that the studied envelope solutions can be regarded with or without thermal bridges (near 1-D conductive heat transfer).

The primary framework developed to tie the test-component to the cell is made of reinforced concrete but could be done with metallic profile which could be filled with insulation foam. The thermal guard is made out of walls of concrete insulated from inside with 15 cm of polystyrene panels.

Heating energy is assured by a moveable fan coil unit which can be positioned on purpose. The cooling system is composed of a fixed fan coil unit with oversized surface of evaporator coil in order to work with temperatures above the dew-point temperature and avoid condensation.

Ventilation systems are designed in order to meet with the requirements of the monitoring protocol based on thermal comfort or in-situ coupled energy performances. Minimum ventilation rate for hygienic reason will be performed, alternated to mechanical free-cooling/natural ventilation to evaluate the thermal efficiency of different ventilation strategies. A vertical shaft within the thermal guard behind the cells is provided for such purposes. An inlet air duct with supply fan is also positioned on the left side of each cell.

### Monitoring and control system

Each cell is equipped with a switching panel composed of enough measurement channels to receive a set of sensors for a cell and its movable component. Basic set is composed by Pt100 sensors (accuracy:  $\pm 0.1$  °C) for different temperatures (surface, air, globe thermometer) measurements, relative humidity probes ( $\pm 3$  %), heat flux meter (with sensitivity up to  $500 \mu\text{W}/(\text{m}^2)$ ) and could be completed for special purposes with additional sensors. Heat flux plates shall be used to give qualitative audit of the fluxes heterogeneity.

HVAC Systems are equipped in order to accurately measure energy consumptions and injected powers. Pt100 probes measure the inlet and outlet water temperatures of the cooling coil system along with a flowmeter. An accurate voltmeter assures the recording of heater power. The energy brought by air ventilation and infiltration is also evaluated.

The acquisition system is placed in the thermal guard zone, it is constituted of a mix of Keysight, and NI datalogger plus RS-485 concentrator. HVAC systems are controlled in view of keeping an accurate set-point temperature of the indoor environment and to produce ROBLs sequences of heating power.

### Construction and boundaries

The test cells are cold-room wall technology made of 2 sandwich polyurethane panels of 20 cm with white metallic finishing. The whole cells are integrated within a controlled temperature building acting as a thermal guard.

### Number of test beds – 5 (3 façades, 2 roofs)

### Exposure – SSW and horizontal

### Climate – La Rochelle, 46°14'N; 1°16'E - Cfb

### Heating – Electrical coiled element – 1.5 kW

### Cooling – 7-15°C cool water loop -2 kW, the primary coil allows to set up a relatively high supply temperature to avoid condensation and refine the measure energy budget.

### Ventilation – Independent mechanical fans for Intake and exhaust [0-6 Vol.h<sup>-1</sup>]

### Dimensions and capabilities

Three changeable walls anchored to a polymeric structure with metallic or reinforced concrete frames:

- A single test bed, 9 m high, 3 m wide with maximum mass of 10 tons. The test cell is partitioned at middle height with gratings that can be loaded with thermal mass to mimic intermediary slab.
- Twin test beds, 3 m high, 3 m wide with maximum weight of 5 tons.

Exposure is due South for façades. The room behind the element is 5.4 m deep giving volumes similar to standard office size.



► Fig. 1: Full view of test facility

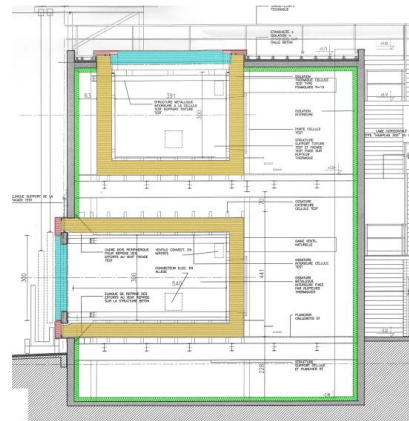

► Fig. 2: Sectional front view of the test facility



► Fig. 3: Façade test beds

### Involved persons:

Maxime Doya  
Jérôme Le Dréau  
Manon Rendu

### Operating since: 2018

### Contact person:

Maxime Doya  
[maxime.doya@plateforme-tipee.com](mailto:maxime.doya@plateforme-tipee.com)

### Website:

<https://www.plateforme-tipee.com/>

# LECE Building Component Energy Test Laboratory

## Relative test-cells fully exposed to outdoor

► Energy Efficiency in Buildings Unit, CIEMAT, SPAIN

### Aim of the test facility

The Building Component Energy Test Laboratory (LECE), (Fig. 1, 2), one of the facilities at the "Plataforma Solar de Almería" (PSA), is part of the Energy Efficiency in Building R&D Unit (UIE3) in the CIEMAT Energy Department's Renewable Energies Division. The LECE has several experimental outdoor devices built up to study full scale construction systems under real weather conditions and indoor boundary conditions, using data analysis, system identification and time-series-analysis techniques. These measurement devices are PASLINK and other test cells, a Solar Chimney, and Monozone Building, all of them are located in a particular climate conditions, usually sunny with cold winters and warm summers. LECE activities may be classified as:

- Experiments in the CIEMAT Energy Efficiency in Building R&D Unit's research projects.
- Collaboration with and services for building materials and component manufacturers.
- Experimental support for preparation of standards and regulations.

### Description of the test facility

The test facility integrates several devices with different capabilities as summarised below:

#### Test-cells

The LECE has three test cells, all made up of a highly insulated test room and an auxiliary room. Their internal dimensions are (WxLxH): 2.76 m x 5 m x 2.75 m. These facilities are located in a large open area separated enough in distance not to cast shading one to another. Their south facing wall is the component to be tested, covering it completely (2.76 m x 2.75 m). The walls, ceiling and floor of each test cell are made of prefabricated panels with 0.2 mm stainless steel sheets and 40 cm thick PS30. The cells are all equipped with air conditioning systems and instrumentation for testing full-scale building components.

#### PASLINK Test-cell

The Spanish PASLINK test-cell incorporates the Pseudo-Adiabatic Shell (PAS) Concept. This system detects heat flux through the test-cell envelope by means of a thermopile system, and compensates it by a heating foil device. The inner surface in the test room consists of an aluminium sheet which makes it uniform to avoid thermal bridging. It also has a removable roof that enables horizontal components to be tested. The cell is installed on a rotating device for testing in different orientations. The internal dimensions of each test room are: 2.56 m x 4.90 m x 2.65 m. Walls, ceiling and floor are the same that the conventional test cells plus 10 cm thick PS30.

#### CETeB Test-cell

The design of this test cell solves some practical aspects related to roof testing, such as accessibility and structural resistance. The test cell architecture is based on an underground thermally insulated and sealed with respect to the outside test room, having about 1 m height from the ground level, this architecture allow easy access to the test component.

#### Solar Chimney

This is a real-size solar chimney prototype, monitored since its construction under real weather conditions. This was constructed for empirical modelling experiments and validating theoretical models. The dimensions of the solar chimney absorber wall are 4.5 m high, 1.0 m wide 0.15 m thick with a 0.3-m-deep air channel and 4mm thick glass cover. Both the inlet and outlet area are 0.25 m<sup>2</sup> and the air inlet is located at a height of 0.5 m from the floor. The inlet air flow is collimated by a laminated array so that the air flow is in the x-direction only.

#### Monozone building

Small south-oriented workshop of 32 m<sup>2</sup>, tailored with the following external dimensions: 4.60 m x 6.95 m x 3.65 m. It is a monozone area building and constructed in an open area free of other buildings and obstacles around that could shade it except for a twin building located 2 m from its east wall. The building was designed to reduce energy demand in both winter and summer using the following passive techniques:

- Fixed shading devices for solar control that avoid solar gains in summer and maximise them in winter.
- Double-glazed windows.
- Windows diagonally placed in a north-south arrangement in order to produce natural ventilation
- Building envelope including thermal mass.
- External insulation
- High ceilings

Its simplicity facilitates detailed exhaustive monitoring and setting specific air conditioning sequences, that simplify its analysis for in-depth development and improving experimental energy evaluation methodologies for buildings [15].

#### Monitoring and control system

Most of the measurements devices are based in PASLINK specification while improvements have been introduced taking into account modernised technical possibilities, and optimisations according the local climate conditions.

The list of installed sensors includes: shielded and ventilated four-wire PT100 sensors, 1/10 DIN, for outdoor air temperature measurements. For surface measurement an element model 2.1252.000 manufactured by Thies Klima is used. The measuring element is a four-wire Pt100 sensor, IEC 751 accuracy of  $\pm 0.5^\circ\text{C}$ , embedded between two 0.05 mm thick polyimide foils. The used device for global solar irradiance is a pyranometer, model CM11. For longwave Radiation: Pyrometer, model CGR4. It incorporates a four-wire PT100 sensor to measure housing temperature. Model Windsonic, manufactured by GILL INSTRUMENTS LTD, a 2-axis ultrasonic wind sensor, provides wind speed and direction data via two analogue outputs, with accuracy  $\pm 2\%$  in wind speed and  $\pm 3^\circ$  in wind direction. 4.20 mA outputs are directly measured. Heating power: Wattmeter model SINEAX DME 440 manufactured by Camille Bauer, class 0.25 to IEC 688:1992, 4.20 mA output directly measured.

Heat flux density: Sensor model HFP01 manufactured by Hukseflux, accuracy of sensitivity coefficient 5%, voltage output measured directly by differential connection. This device is based on a thermopile embedded within a black plastic material.

#### Construction and boundaries

- Four single test cells (with one Paslink) fully exposed to outdoor.
- Single CETeB Test cell for roofing components

#### Exposure – South

**Climate –** Tabernas (Almería), 37.1°N, 2.4°W-Bsh

#### Heating – Heating coil

#### Cooling – Cooling coil

#### Ventilation – No Data

#### Dimensions and capabilities

Load-bearing walls (concrete based)



► Fig. 1: Building Component Energy Test Laboratory (LECE)

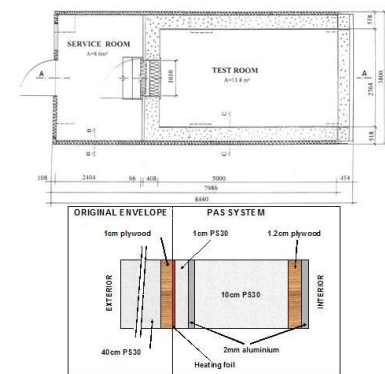

► Fig. 2: Plan drawing of the LECE Test Cells and section detail of walls

► **Involved persons:** Emanuela Giancola

► **Operating since:** 1986

► **Contact persons:**

Emanuela Giancola  
[emanuela.giancola@ciemat.es](mailto:emanuela.giancola@ciemat.es)

M. Jose Jimenez Taboada  
[mjose.jimenez@psa.es](mailto:mjose.jimenez@psa.es)

► **Website:**

<http://www.psa.es/en/laboratorios/lece.php>

# PIV – Particle Image Velocimetry Indoor measurement equipment

► Energy Efficiency in Buildings Unit, CIEMAT, SPAIN

## Aim of the test facility

Particle Image Velocimetry (PIV) is an optical method of flow visualization and quantification of instantaneous velocity fields, measuring two velocity components in an area of analysis. Two images of the same area, shortly captured one after each other, are registered. One micron olive oil droplets are usually used as tracer particles, ensuring acceptable flow tracking for most seeding materials in typical turbulent or high speed gas flows. Statistical correlations are used to find average tracer particle displacement (illuminated by a sheet of light) within this time. From the known time difference and the measured displacement, the instantaneous velocity field is calculated.

Stereo-PIV (2D3C) unlike PIV (2D2C) uses two points of view at different angles (two cameras) and images are recorded simultaneously by left and right cameras. It is used to obtain the three-component velocity field in the planar region illuminated by a laser light sheet. A numerical model describing how objects in 3-dimensional space are mapped onto the 2-dimensional image (recorded by each of the cameras) is used to estimate the third velocity component in the area of analysis (Figure 1).

## Description of the test facility

The Experimental Laboratory for the characterization of fluid-dynamic behavior in bioclimatic systems, is located in CIEMAT-Moncloa territorial center. The laboratory dimensions are 15 square meters floor area and 2.7 m high, distributed in a single room. It has an individualized air conditioning system independent from the rest of the building, which makes it possible to guarantee stable environmental conditions in the laboratory, so that repeatability can be ensured in the tests.

The indoor laboratory is fully-equipped with a double cavity Nd:YAG (YAG120-BSL) pulsed laser light beam that delivers energy of 120 mJ per pulse at a wavelength of 532 nm and a pulse repetition rate of 15 Hz. Another important rig is the Laser Pulse Synchronizer TSI-610034 that automates the control of laser pulses, cameras and timing to external signals. Two CCD cameras (630159 Power View 4MPlus) with 4 Mega pixel resolution with chip pixel dimensions of 2048 pixels x 2048 pixels and dynamic range of 12 bit output. The cameras are connected to a PC equipped with a 64 bit frame grabber that acquires 16 frames per second.

The laser and the cameras can be horizontally and vertically displaced by means of 2-dimensional positioning structures that permit to set the exact position for different runs.

The PIV software platform is capable of controlling a wide range of hardware (high speed cameras, and lasers) for precise image capture and providing many algorithms for accurate PIV analysis. CIEMAT uses INSIGHT™ 3G Global Imaging, Data Acquisition, Analysis and Display software.

Finally, tracer particles are nebulized by a six jet atomizer 9306A from TSI.

## Key points in the System Operation

PIV technique requires optical access to the flow, to illuminate the analysis plane and to record the images.

The CDD camera active area have an order of magnitude of 1dm x 1dm. If the area of fluid analysis is greater than this dimension, it is impossible to capture the whole geometry in one single image, and it is necessary to perform different experimental runs at different positions.

In these cases, regions are delimited in each stage so that whole fluid structures are within this region (i.e. recirculation vortices).

A correct system spatial calibration is critical to avoid large misalignments between calibration plate and laser light sheet. To make the target alignment process more sensitive select a high value of the lens aperture of the camera, even if the depth of field is reduced. If necessary use Scheimpflug lens adapter in Stereo-PIV measurements, to keep both image planes in focus, increasing the active area.

The tracer particles must verify the following conditions: correctly follow the flow (neutrally buoyant), good light dispersion, and correct density. CIEMAT uses olive oil tracer particles of one micron of diameter. The tracer particles are partially confined and sprinkled through two-three minutes before starting the data acquisition in order to have enough seeding particles density and homogeneity.

## Example of activities

Several studies evaluating the fluid dynamic performance of different constructed opened joint ventilated façade (OJVF) models were developed at the laboratory facilities. OJVF model design is based on simplified real façades required for experiments in a laboratory setting. Initial studies evaluated OJVF with horizontal open joints applying 2D-PIV [16]. Recently, a Stereo-PIV measurement to evaluate OJVF with both horizontal and vertical open joints was performed [17]. These experimental results help to validate CFD models [18] to predict accurately the heat transferred to the building. Besides, additional studies considering different radiation conditions and several relevant constructive parameters have to be done.

## Exposure – Indoor Facility

**Location** – Madrid, 40.5°N, 3.7°W- Csa

**Heating** – no system

**Cooling** – cooling coil,

**Ventilation** – no system

## Dimensions and capabilities

The laboratory has the following internal dimensions (W x L x H): 3.6 m x 4.2 m x 2.7 m

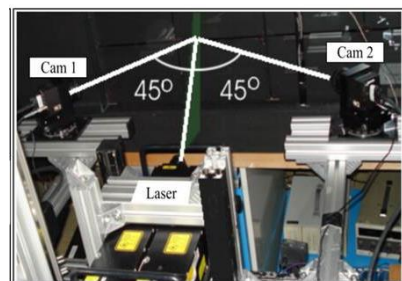
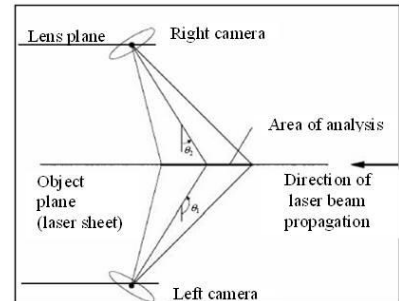

► Fig. 1: Schematic of the angular displacement system in Stereo-PIV (up) and real system image (down)

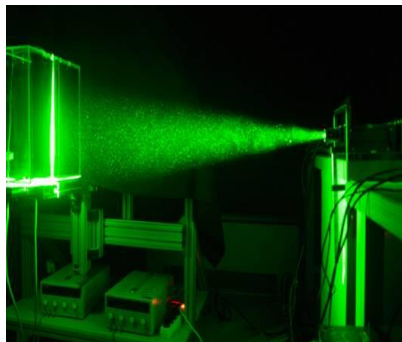

► Fig. 2: General view of PIV system in operation

► **Involved person(s):** Emanuela Giancola

► **Operating since:** 2008

► **Contact person(s):**

Emanuela Giancola [emanuela.giancola@ciemat.es](mailto:emanuela.giancola@ciemat.es)

M. Nuria Sánchez [nuria.sanchez@ciemat.es](mailto:nuria.sanchez@ciemat.es)

► **Website:**

<http://www.ciemat.es/cargarSubLineaInvestigacion.do?identificador=62&idArea=1&idLinea=6>



# PSE ARFRISOL Energy Research Demonstrator Office Building Prototypes In-situ real-scale buildings

► Energy Efficiency in Buildings Unit, CIEMAT, SPAIN

## Aim of the test facility

The PSE ARFRISOL Energy Research Demonstrator Office Building Prototypes (C-DdI) are part of the test facilities of the Energy Efficiency in Building R&D Unit (UiE3) belonging to CIEMAT Energy Department's Renewable Energies Division.

The PSE ARFRISOL C-DdIs are fully instrumented, in use and monitored continuously by a data acquisition system. Each of them is an approximately 1000m<sup>2</sup> built area office building. They are in different representative locations of Spanish climates (Fig. 1). These C-DdIs are designed to minimize energy consumption using renewable energy systems for heating and cooling, whilst maintaining optimal comfort levels. They therefore include passive energy saving strategies based on architectural and construction design, have active solar systems that supply most of the energy demand (already low), and finally, conventional auxiliary systems to supply the very low demand that cannot be supplied with solar energy, using renewable energy resources, such as biomass insofar as possible. These prototypes were built for high-quality measurements recorded during monitoring to support research activities on thermal comfort, energy performance analysis and both active and passive systems integration in buildings, identification of deviations between simulations and experimental measurements, characterization and evaluation of the building envelope, and evaluation of active systems.

## Description of the test facility

The C-DdI PSE-ARFRISOL, have the following passive strategies common to all of them:

- Use of envelope and structure thermal inertia.
- Optimized direct solar gain through glazed openings.
- Optimized indirect solar gain through opaque walls.
- Similarly, all C-DdIs, integrate the following common active solar strategies:
- Solar thermal collectors for hot water, heating and cooling.
- Absorption refrigeration pumps.
- Integrated photovoltaic modules.

## Example of activities

These building prototypes are regularly used as office buildings. Taking into account the typical pattern of use of this type of buildings they have several possibilities for test campaigns:

- Long test campaigns in occupancy conditions corresponding to the regular use of the buildings, with indoor conditions within the comfort limits, occupants free to use the buildings. In these periods perturbations in the normal life of the users are forbidden.
- Shorter test campaigns with the buildings empty corresponding to periods of holidays, when it is possible to use heating and cooling system to generate power sequences, to

optimise the data analysis. If necessary the buildings can be out of the comfort bands in these test periods.

- Taking into account the buildings size, a detailed monitoring of each room was considered not affordable, and some rooms were selected according their representativeness into the building. A comprehensive set of sensors is installed in order to be able to quantify all the contributions to the energy balance into the selected rooms in both cases: empty building and occupancy conditions

The experiment set up was inspired in the experiment set up carried out in PASLINK tests by this team. However this set up was adapted to take into account the main differences between test cells and in use buildings which are mainly related to boundary conditions and presence of users as follows:

- The boundary conditions are not controlled, then the following measurements are included for each monitored room: air temperature in the adjacent rooms, temperature of the floor surface, temperature of the glass surface, water flow and inlet and outlet temperatures associated with cooling and heating, temperatures below the ground at different levels, one just under the floor tiles and the other 1m buried.
- The users influence the building performance as ventilation rate can be changed by the operation of doors and windows. Then it is recorded: if doors and windows are closed or "not closed".
- There is a contribution to the energy balance into the room due to the users' metabolic activity. So the following measurements are included in each room: concentration of CO<sub>2</sub>, relative humidity, electric consumption due to computers and lighting.
- Air leakage is not negligible, so the following measurements are included: Outdoors wind speed and direction, indoor and outdoor CO<sub>2</sub> concentration. It is also recorded if doors and windows are closed or "not closed".

In summary the experimental measurements available in the main monitored rooms are: air temperature, relative humidity, CO<sub>2</sub> concentration, temperature of the walls, floor and glass surfaces, water flow and inlet and outlet temperatures associated with cooling and heating system, electric consumption due to computers and lighting, temperatures below the ground at different levels. It is also recorded if doors and windows are closed or "not closed". Data are recorded every minute, although other recording intervals are available.

**Climate**—The five different building prototypes (C-DdI) are:

- C-DdI CIESOL: located at the campus of the University of Almeria where weather is humid Mediterranean [19].
- C-DdI ED70 CIEMAT: located Madrid where weather is a moderate continental.
- C-DdI PSA; located at the Plataforma Solar de Almeria (PSA) in Tabernas (Almeria) in a semi-arid climate with large day-night temperature variations is a prototype of a new plant.
- C-DdI F. Barredo: located in San Pedro de Anes, Asturias, in a humid continental climate.
- C-DdI CEDER CIEMAT: located in Cubo de la Solana, Soria, with continental climate which is considered extreme regarding Spanish climate.



► Fig. 1: PSE ARFRISOL C-DdIs geographic location.

- **Involved person(s):** Emanuela Giancola
- **Operating since:** 2007
- **Contact person(s):**  
Emanuela Giancola [emanuela.giancola@ciemat.es](mailto:emanuela.giancola@ciemat.es)  
M. Rosario Heras [mrosario.heras@ciemat.es](mailto:mrosario.heras@ciemat.es)
- **Website:** <http://www.arfrisol.es/ARFRISOLportal/>

# GESLAB, Global Energy and Sustainable Laboratory in Building

## Relative test-cells fully exposed to outdoor

► Departamento de Construcción y Tecnología Arquitectónicas, ETSAM, Universidad Politécnica de Madrid, SPAIN

### Aim of the test facility

The aim of GESLAB is to become an open laboratory for all research groups and PhD teams of Polytechnic University of Madrid, as well as to all companies interested in utilizing the facility for improving knowledge according to GESLAB's purpose.

The GESLAB outdoor facility's structure came from previous research projects (since 2005) as a result of the collaboration of TISE group (Técnicas Innovadoras y Sostenibles en la Edificación) and different companies, SOLAR DECATHLON and SOLAR DECATHLON EUROPE teams since 2007 to 2012.

They are located in the International Campus of Excellence of the UPM in Montegancedo and are composed of two equipped platforms (Figure 9) which include:

- Eight identical adiabatic directable prototypes for façade technical solutions tests.
- Three identical adiabatic modules for roof technical solutions tests.
- Five prototypes of solar decathlon houses for the experimentation of technology solutions for zero energy buildings.

### Description of the test facility

The eight prototype-cells for façade tests have identical characteristics and can be used two by two for independent tests, or with different configurations depending on the project and availability. The idea is to use one of them as a reference purpose and the others equipped with any different configuration of façade technologies as test cells. The equal boundary conditions and construction typology allow accurate comparisons between a variety of façade configurations and to carry out accurate analysis.

The cells have exterior dimensions of 3.3 m Wide, 3.3 m Long and 3.3 m High, and 2.12 m (WxLxH) interior dimensions. Usually they are south-exposed oriented, although they are assembled on wheels in order to have the capacity to change the orientation of the façades, which one of them can be equipped with technology to be tested.

The five walls of the test-cells are heavily insulated.

The indoor temperature of the cells is managed with an HVAC split unit system with 2650 W cooling and 3050 W heating capacity, 460 m<sup>3</sup>/h, 39 dB(A) and 1 °C of tolerance for temperature set. No control on humidity level is performed.

### Monitoring and control system

The monitoring systems consist of different typology of sensors that can change and adapt to the necessity and the purpose of the experimental activities according to the research requirements:

- Heating and cooling consumption power by means of two single phase multi-function energy meter, precision class I active / class II reactive.
- Heat flux by means of thermocouple (TJ type)

to measure the temperature of the indoor and exterior surface temperatures with accuracy of  $\pm 0.5$  °C.

- Indoor environmental quality by means of thermo-hygrometer-CO<sub>2</sub> sensor with accuracy of  $\pm 0.5$  °C for temperature between 10-35 °C;  $\pm 2\%$  of precision between 0-95% of RH;  $\pm 2\%$  of ppm between 0-2000 range.
- Omnidirectional probe tip anemometer with accuracy of 0.05 to 0.5 m/s.
- Luxmeter as interior light level sensor with accuracy of  $\pm 5\%$  of 0-1000 and 0-200 lux range.
- Axial extractor fan with 160 mm of diameter.
- Whether boundary conditions monitored by means of a weather station located on a roof of one cell that can measure: Barometric pressure (mmHg); Exterior temperature (°C); Wind velocity (km/h); Wind average (km/h); Wind angle (°); Heat index (°C); Rain fall (mm/h); Ultraviolet radiation index (index); Solar radiation (W/m<sup>2</sup>); Rain rate (mm/h).

Each cell has an exterior control cabinet with an independent acquisition data system with access points to Ethernet network. The system is equipped with thermocouple card (therm), thermistor card (rtd), data acquisition card (analog), CPU TJ-monitor for data acquisitions and manages, for all the sensors.

### Construction and boundaries

The five faces (walls, floor and flat roof) are around 600 mm of thickness and are made of (from outside to inside) grey metallic mini-wave panel as rain screen, EPDM waterproofing, 80 mm of extruded polystyrene panel (XPS), 16 mm OSB wood panel, 90 mm glass wool between steel frame structure, 200 mm XPS, 16 mm OSB panel and for a total U-value of 0,077 W/m<sup>2</sup> K.

### Number of test beds – 8

**Exposure** – South,

**Climate** – Pozuelo de Alarcón, Madrid, 40°24'N 3°50'W - Csa

**Heating** – Heating coil,

**Cooling** – Cooling coil,

**Ventilation** – No Data

### Dimensions and capabilities

Each test cell has the following internal dimensions (W x L x H): 3.3 m x 3.3 m x 2.12 m.



► Fig. 1: View of platform (1 to 3) and View of the eight cells (4)

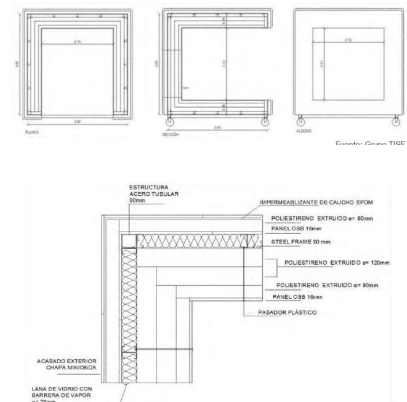

► Fig. 2: Drawings of plan, section, front view and detail of adiabatic walls.

► **Involved person(s):** Giuseppe La Ferla

► **Operating since:** 1987, rehabilitation

► **Contact person(s):**

Giuseppe La Ferla  
[g.laferla.licitra@gmail.com](mailto:g.laferla.licitra@gmail.com)



# Facade System Interactions Lab

## Relative guarded test-cells

► Eurac, Institute for Renewable Energy, Bolzano, ITALY

### Aim of the test facility

The "Facade systems interactions lab", known also as "MultiLab", is an innovative experimental facility that has two main purposes: testing building envelope components such multifunctional façade systems, and conducting analysis on human thermal comfort and, more broadly, on indoor environmental quality.

In the MultiLab, there are two identical environmental chambers, and it has been designed to guarantee an accurate control of the environmental conditions in the two test chambers. Moreover, the whole laboratory can rotate to obtain the desired orientation.

### Description of the test facility

MultiLab comprises four indoor spaces (Figure 1), namely two identical environmental chambers, a technical room which contains part of the HVAC system and that is used to access the two test chambers, and a narrow corridor located between the two test rooms.

One façade of each environmental chamber can be changed in order to test different façade samples. Moreover, the whole laboratory can rotate around its vertical axis, and can be therefore orientated in any desired direction (360°, that is achieved by a ±180° rotation). This enables for instance to conduct experiments in which the façade sample is exposed to different orientations and therefore solar radiations.

The net internal floor dimensions of the two environmental chambers are 4.00 m x 4.00 m, and their internal height (floor to ceiling) is 3.00 m. The floor, ceiling, and non-replaceable walls (thus, three walls per chamber) of environmental chamber cell are equipped with radiant panels in order to be able to control their surface temperature. Each surface can have a different set-point temperature. Moreover, it is possible to hang additional radiant panels to the ceilings. These panels can partially or entirely cover the ceiling surface depending on the purpose of the experiment.

The ventilation system can deliver fresh air at a chosen set-point temperature to each test chamber. The set-point temperature can be different in the two cells, and the air flow can be supplied (and extracted) at ceiling and floor level, as required by each experimental design. In the technical room, the climatic conditions are controlled by using a dedicated air conditioning system (split and heat pump). This is essential since the control and monitoring equipment (such as data loggers) located in this technical room might be severely affected by significant temperature variations.

There is also an additional water circuit in environmental chamber that can be easily and quickly connected to a fan coil unit if this is integrated in the façade sample.

### Monitoring and control system

The temperature of the water and therefore of the

radiant surfaces can be controlled in five different ways: (i) as a function of the surface temperature sensors of one or more surfaces; (ii) as a function of the outdoor air temperature; (iii) as a function of the air temperature in the chamber; (iv) as a function of an external signal; (v) a fixed values set by the user. The peak power of the radiant system is 150 W/m<sup>2</sup>, and the surface temperatures can be controlled from 15°C to 40°C; it is actually possible to set a wider range of values, but the accuracy of the system decreases. Within the 15-40°C range, the maximum temperature difference between two randomly chosen points on a surface must be within 4K.

The cooling and heating system of the whole lab has been designed in a way such that the air temperature in the test chamber can be controlled down to 20°C in summer and up to 25°C in wintertime. Also in this case, depending on the actual external conditions, it might be possible to extend this thresholds, but the accuracy of the system would decrease.

The maximum air flow that can be delivered to each environment is 750 m<sup>3</sup>/h, and it is possible to control the air flow by setting the speed of the fans, and the temperature and relative humidity of the air supplied to the room. Several inlet/outlet configurations are possible with in the chambers:

- (i) inlet at floor level along the longer side of the room, and outlet on the ceiling (in the center);
- (ii) inlet at ceiling level along the longer side of the room, and outlet on the ceiling (in the center);
- (iii) inlet at ceiling level along the longer side of the room, and outlet at floor level along the longer side of the room.

The maximum air speed in the ducts is 2.5 m/s near the inlets, and 3.5 m/s in the central ducts.

### Construction and boundaries

The U-value of the outdoor facing walls is 0.15 W/m<sup>2</sup>K, while the U-value of the internal walls and doors is 0.8 W/m<sup>2</sup>K. The airtightness of each environmental chamber is tested with a blower door test mounted on the replaceable wall (that is the position of the façade sample), and the air changes per hour at a 50 Pa (n50) are not greater than 1.5.

### Number of test beds – 2

**Exposure** – changeable,

**Climate** – Bolzano, 46°29'N 11°20'E- Cfa

**Heating** – Heating coil,

**Cooling** – Cooling coil,

**Ventilation** – Inlet and Exhaust up to 15 vol.h<sup>-1</sup>

### Dimensions and capabilities

The dimensions of one façade sample are height 2.80 m, width 3.75 m, and maximum thickness 0.38 m. The weight of the façade sample must not exceed 5,500 kg.

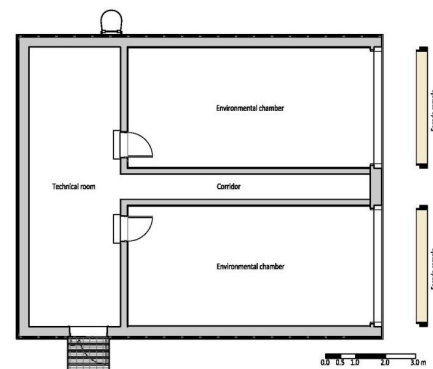

► Fig. 1: MultiLab - floor plan

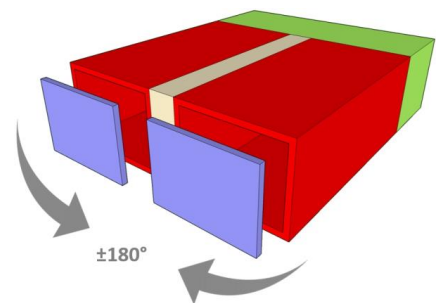

► Fig. 2: 3D view of MultiLab

► **Involved person(s):** Francesco Babich, Stefano Avesani, Roberto Lollini

► **Operating since:** 2018, under construction

► **Contact person(s):** Francesco Babich  
[Francesco.Babich@eurac.edu](mailto:Francesco.Babich@eurac.edu)

► **Website:** <http://www.eurac.edu/en/research/technologies/renewableenergy/Pages/default.aspx>

# TRIUMF Laboratory

## Two Room Indoor Environment & Energy Universal Façade

▶ Aalborg University, Aalborg, DENMARK

### Aim of the test facility

TRIUMF Laboratory (acronym for “Two Room Indoor Environment & Energy Universal Façade”) is the new facility at Aalborg University. The laboratory is designed with purpose of performance assessment of real-scale façade components exposed to outdoor environment on one side and accurately controlled boundary conditions on the interior side.

Performance assessment of façade elements is expected to have diverse research objectives, including such topics as:

- Empirical validation of numerical models
- Dynamic thermal performance of façade components
- Integration of façade elements with chilled beams, radiant terminals or other HVAC systems
- Development of control strategies
- User interaction
- Investigation of indoor environment, etc.

TRIUMF Laboratory is the follow-up to several already existing laboratories at AAU and was therefore designed and equipped according to experience gained from building and operation of full-scale outdoor test facility the Cube, which Aalborg University had operated for the past 10 years.

### Description of the test facility

The TRIUMF Lab contains of two fully separated rooms (twin rooms) that are located on a 5th floor of the Department of Civil Engineering (Fig. 1). The building is located in an open area with no obstructions from the surroundings on the South.

The elevation of the twin rooms can be controlled by the car lift that allows swift access to the ceilings if necessary modification of ventilation terminals or similar tasks must take place. Fig. 3 illustrates the vertical section of the rooms. And Fig. 4 illustrates the horizontal section.

Façade openings are facing directly to South. The openings allow flexible installation or replacement of façade elements for performance testing. Twin rooms have a guarded zone each with separate HVAC system. In this way, it is possible to obtain an accurate energy balance through the façade elements. All necessary properties of the energy balance are measured along with the outdoor conditions. The façade opening in each room available for testing purposes is 5 x 3 m<sup>2</sup>. Floor area of each room, excluding guarded zone is approximately 15 m<sup>2</sup>.

Interior walls of twin rooms are made of DC system insulation panels. It is light construction with metal as interior cladding which functions as a vapor barrier. Elimination of moisture transport in the constructions was one of the goals for this laboratory, in order to reduce uncertainties in the energy balance due to moisture transport and accumulation in the constructions.

### Monitoring and control system

At the moment TRIUMF Laboratory is being finalized thus control and monitoring strategies are not fully in place.

The outdoor boundary conditions are measured at the site. Total irradiance is measured on the roof of the building (global, 3% uncertainty and diffuse, uncertainty max 10 %). Total solar irradiance on the Southern façade is measured as well. Wind speed and wind direction are measured at the height of the building.

Similar to the Cube, equipment in the TRIUMF can be adjusted on demand and may include hot-sphere anemometers, lux meters, PIV-system, thermal manikins, power meters, etc.

All data are logged using LabVIEW. This interface is also used to control the different equipment of the test-room. The modularity of this software makes the set-up highly flexible.

### Construction and boundaries

Thermal guarding zone confines all walls in the test room, except for the exterior façade wall.

### Number of test beds – 2

#### Exposure – South

#### Climate – Aalborg, 57°02'N; 10°0'E - Dfb

#### Heating – Heating coil

#### Cooling – Cooling coil

#### Ventilation – Separate ventilation system for each guarded zone

### Dimensions and capabilities

The internal dimensions of the test room excluding guarded zone is 4.7 m x 2.9 m x 3.08 m (width x length x height)



▶ Fig. 1: Department of Civil Engineering, AAU.



▶ Fig. 2: TRIUMF Laboratory on the roof of the Department of Civil Engineering, AAU.

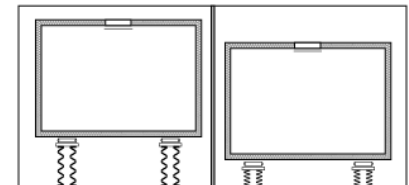

▶ Fig. 3: Vertical section of the twin rooms

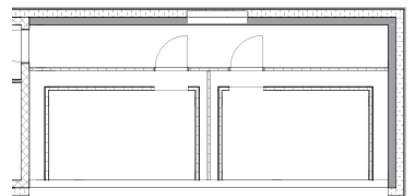

▶ Fig. 4: Horizontal section of the twin rooms

▶ **Involved person(s):** Rasmus L. Jensen

▶ **Operating since:**

Construction in progress, (2019)

▶ **Contact person(s):**

Rasmus L. Jensen [rlj@civil.aau.dk](mailto:rlj@civil.aau.dk)

# LABIMED Test Cell

## Paslink test cell

▶ ABITA research Centre, University of Florence, Italy

### Aim of the test facility

LABIMED Test Cell is an outdoor test facility for the Mediterranean climate developed within the research project Abitare Mediterraneo (www.abitaremediterraneo.eu), funded by the Tuscany Region as part of the POR CREO Fesr 2007-2013 and developed by the Department of Architecture of the University of Florence, jointly with 12 regional companies of building sector. The aim of LABIMED is to assess the energy performance of opaque and transparent building envelope components testing full scale façade system by means of dynamic measurements under real weather conditions.

It has been designed according to PASLINK methods, but some improvements were achieved to overcome some critical aspects such as overheating, thermal bridges effects, problems due to infiltrations, not insulated frame.

### Description of the test facility

LABIMED Test Cell has a wooden structure realized in platform frame with an insulated removable structure to mount the test sample.

The test cell is mounted on a routable system to carry out experimental test on building components performance corresponding to different orientations.

LABIMED Test Cell is currently equipped with a heating system and an axial fan, which has the function to heat the air volume of the Test Room and to ensure the indoor air convection to prevent indoor temperature stratifications. During the test, indoor ambient conditions of test room can be considered homogeneous with a high degree of control during the test thanks to the airtight and the high insulation of test room envelope. The direct heat flow rate measurement is possible thanks to Heat Flux Tiles installation, that represents the main improvement introduced by PASLINK dynamic methodology and consists of 230 prefabricated heat flux sensors in form of tiles covering all the inner surfaces of the test room except the test wall. The main improvement of LABIMED concerns the development of a new configuration for the HFS tile (8.55 thick) using Peltier cell as sensitive element (dimensions 40x40 mm and 4 mm thickness), applied in the centre of the tile into a filling structure composed of two layers of different materials which have the same overall thermal conductivity as the Peltier cell ( $\lambda=0.8$  W/mK), interposed between two aluminium layers of 3 mm thickness.

### Monitoring and control system

Monitoring system of LABIMED consists of the set of sensors required by PASLINK procedures and protocol. The basic monitoring equipment installed inside the test room consists of:

- 6 platinum 4-wire PT100 for air temperature measurements;
- 26 T type thermocouples for surface temperature measurements (5 for each wall, 3 on the roof and 3 on the floor of the test room).
- 230 heat flux meter tiles (mV output) covering the overall test room envelope;

- 1 relative humidity and air temperature miniature probe placed in the center of the test room;
- 1 probe globe thermometer (PT100 sensor) for radiant temperature measurement placed in the center of the test room.

The test wall sample requires an additional set of sensors (thermocouples, heat flux sensors, humidity sensors, air speed sensors, etc): type: number and position of additional sensors on each layers of the test sample depending on the test purposes identified at the beginning of the operational phase of the product testing procedure.

A weather station located nearby the test sample of the Test cell displays and records weather data including following sensors:

- 1 atmospheric pressure sensor ;
- 2 anemometers for wind speed (m/sec) and angle measurements(°);
- 1 pyranometer for measuring the horizontal global solar radiation (W/m<sup>2</sup>) ;
- 1 rainfall sensor (mm/h);
- 1 shielded probe for relative humidity (%) and air temperature (°C);

The global solar radiation over the plane of test wall is recorded by means of a pyranometer ( $\pm 1.0$  accuracy) located on the vertical plane of test sample

A workstation unit inside the service room allows to manage monitoring apparatus during the test and includes control and measuring devices equipped with a Data Logger Agilent 34980A which is also able to control the switching mode (on and off) of the heating system inside the test room. Data acquisition and control system is developed in LabVIEW software.

### Construction and boundaries

The U-value of all the envelope components (walls, floor and roof) is 0.32 W/m<sup>2</sup>K. The test cell is provided of a wooden external solar shading screen to avoid overheating which could affect the accuracy of results during the test.

### Number of test beds – 1

### Exposure – changeable

### Climate – Florence, 43°79'N; 11°25'E - Csa

### Heating – Heating coil 500 W

### Cooling – No Data

### Ventilation – Axial fan 50 W

### Dimensions and capabilities

The test room has the following internal dimensions (W x L x H): 2.8 m x 5.0 m x 2.8 m The test wall has dimensions of 2.8 m x 2.8 m (L x H) and up to 0.30 m thick.

The weight of the test sample must not exceed 5,000 kg.



▶ Fig. 1: View of LABIMED Test cell at University of Florence



▶ Fig. 2: Overview of the Heat Flux Tiles System inside the Test room

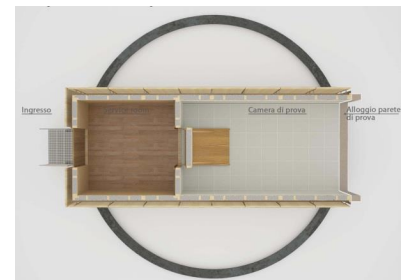

▶ Fig. 3: Plan view of Test room and Service room

### ▶ Involved person(s):

prof. M. Sala, prof. P. Gallo, ing. A. Donato, arch. R. Romano

### ▶ Operating since: 2016

### ▶ Contact person(s):

Paola Gallo [paola.gallo@unifi.it](mailto:paola.gallo@unifi.it)

### ▶ Website: <https://www.centroabita.unifi.it/>

# Building Future Lab Indoor Laboratory - Calibrated Hot-Box

► BFL – Building Future Lab, dArTe department, Mediterranea University of Reggio Calabria, ITALY

## Aim of the test facility

Test Cell is a laboratory equipment related to one of the sections of the BFL – Building Future Lab, which has as main objective to test components and building envelope systems in full scale in compliance with the requirements of current legislation. The specific measurement that can be carried out in Test Cell are:

- measurement of dynamic thermal transmittance of opaque closures,
- steady-state measurement of walls,
- analysis of thermal bridges by thermography,
- measurement of the performance of thermal insulation paints.

It can be used both indoors and outdoors.

## Description of the test facility

Test Cell it is composed of three independent units installed on a support platform and managed by a control PC. The three units are: a fixed half-cell, a sample holder and a mobile half-cell.

The fixed half-cell is composed by a structure in aluminum profiles maintaining walls made of expanded polystyrene panels of 160 mm, internally lined with melamine of 10 mm, with a matt black finishing. Front wall opening was specifically designed to be coupled to the sample holder under test.

The sample holder is composed by a structure in aluminum profiles with four wheels with v-groove bearings and by two frames in aluminum profiles. An aluminum frame is fixed to the trolley while the second can be positioned according to the thickness of the sample, which can change from the minimum value of 100 mm to the maximum value of 400 mm.

The mobile half-cell is identical in design to the fixed half-cell except for the ventilators, installed in the lower part of the cell (upward airflow) and for the possibility of moving it from the support platform through a support with 4 wheels.

The half-cells can be just coupled independently to the sample allowing for example thermal evaluation by IR thermography or to set the mobile part to an outdoor exposure and run it just as an outdoor test-cell).

## Monitoring and control system

We can also distinguish three parts with different functions that allow operation and monitoring of the test, such as :

- the control compartment, an area used to the control of tests through a PC and containing the main electrical panel and an emergency button.
- the technical compartment, where are installed both the connections of the Test Cell to the power and both the box for the connection of the measurement sensors and the mobile panel.

- test area, with the two half-cells and the sample holder.

In each of the two chambers formed by the half-cells it is possible to create defined climatic conditions.

Test Cell it is also equipped with a motor for the rotation around its axis for an angle maximum of  $\pm 20^\circ$ .

Inside the cell, for the correct execution of the test and the monitoring, are also installed three evaporators with direct expansion of refrigerating fluid provided with defrost heaters, three electric resistance heaters; a deflector and two tangential fans to create adequate airflow on the exposed face of the sample.

The internal bulkhead divides the cell into two parts: the rear part where are installed the evaporators and the electrical resistance heaters and in the front part are installed 18 temperature sensors and an air-speed meter.

The bulkhead is not full-height so as to create two windows of communication between the two parts: an upper one where the two fans are installed and a lower one for the passage of air moved by the ventilators (flow of descending air).

## Construction and boundaries

It is possible to select if the cold set point must be "fixed" or "cycle", in the case of cycle the variation law is sinusoidal with 24 hours period; the dynamic set point is cut within the physical limits of the cells (from  $-10^\circ\text{C}$  to  $+60^\circ\text{C}$ ); the position of the air deflector can be set (0% there is no air on sample, 100% all air is on sample), normal value 60%; the speed of ventilator can be set from 0% to 100% (5 m/s) and while the scrolling interval of the Chart can also set up, the normal value being 10 s.

## Number of test beds – 1

## Exposure – changeable

**Climate** – Reggio Calabria,  
38°6' 41" 40 N  
15°39'43"56 E, Csa

## Heating – Electrical heating coil element

## Cooling – Cooling coil

**Ventilation** – Tangential ventilator, the fan speed can be set from 0 to 5 m/s.

## Dimensions and capabilities

The dimensions of one façade sample are height 1.65 m, width 1.44 m, and maximum thickness 0.40 m.

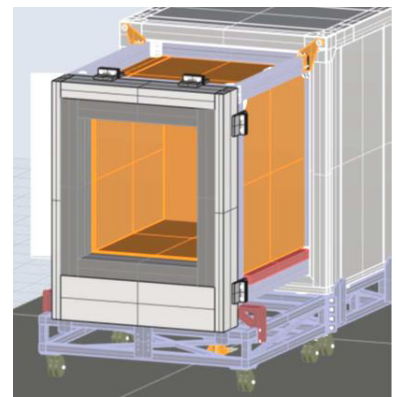

► Fig. 1: 3-D view of Test Cell

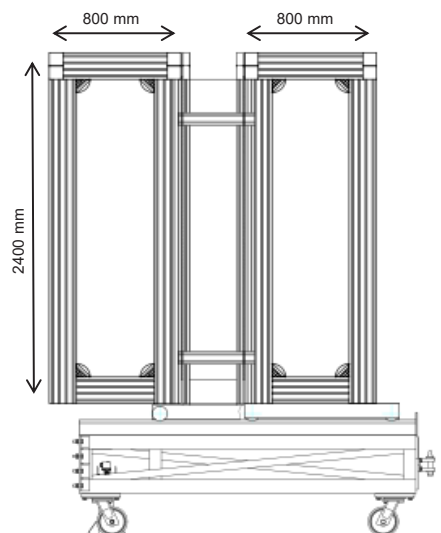

► Fig. 2: Cross-section of Test Cell

## Involved person(s):

Prof. Martino Milardi,  
Prof. Corrado Trombetta

► **Operating since:** 2018

## Contact person(s):

Martino Milardi [mmilardi@unirc.it](mailto:mmilardi@unirc.it)  
Corrado Trombetta [ctrombetta@unirc.it](mailto:ctrombetta@unirc.it)

## Website:

<https://www.unirc.it/ricerca/laboratori.php?lab=69>



# Building Envelope and Solar Technologies Laboratory

## Absolute and relative guarded test cell

► EDF Lab Les Renardières, Moret-Loing-et-Orvanne, FRANCE

### Aim of the test facility

The BESTLab (Building Envelope and Solar Technologies Laboratory) is an outdoor full-scale test facility located in the EDF (*Electricité de France*) research center of *Les Renardières*. This facility provides experiments on technologies associated to or connected to the building envelope (insulation / wall-building materials and systems, windows, HVAC equipment, power generation technologies, monitoring...). They are tested separately or combined at full scale under real weather conditions thanks to construction work as for a real building. Each façade is connected to a test-cell the size of a dwelling room with temperatures monitored on the internal side.

Thermal behavior can be studied at different times of the year and the associated cooling and heating demand can be characterized.

The experimental data are used to adjust numerical models of the studied component, accounting the outdoor climate and the induced dynamic effects.

### Description of the test facility

Twelve cells with test façades are implemented in the laboratory. Hence, twelve independent tests can be carried out simultaneously. Six of them are at ground level with vertical test façades, and six are on the first floor with sloped roof test façades (Fig. 2). Each level is distributed according to three sun's orientations: one cell facing East, four cells facing South and one facing West (Fig. 3). The 2x4 southern test façades allow scientific evaluation and comparison of several technologies (up to 4) at the same time.

All test façades can be fully removed or new designs can be built within reinforced concrete frames of initial available tested walls. They are maintained against the wall laboratory with steel brackets and stud bolts. Thermal bridges due to the laboratory wall connections are minimized thanks to high level of internal insulation and can be analyzed with temperature sensors sunk in the concrete slab and modelling work.

Each test cell has one test façade. The other walls are over-insulated ( $U$  value  $< 0.1 \text{ W/m}^2/\text{K}$ ) and are in contact with a thermal guard zone maintained at a given temperature (usually  $20^\circ\text{C}$ ) all year round. The impact of these walls on the overall thermal balance of the cell is minimized. Each test cell is thus thermally independent from the rest of the laboratory. The cells are designed to minimize air permeability values. During a test, all thermal phenomenon are due to the interaction between the inside of the cell and the outside climate through the test façade.

### Monitoring and control system

Each test cell is equipped with its own HVAC system (Fig. 4), which is monitored by a set-point temperature. Multiple air outlets ensure temperature homogeneity inside the cell. The existing HVAC system can be removed for special needs of an experiment (specific system to be tested, air stratification studies etc.) Each HVAC system is equipped to accurately measure energy consumptions and injected

powers. Pt100 probes measure the inlet and outlet water temperatures of the cooling coil system along with a flowmeter. The electric resistor and fan consumptions are also measured.

All cells and the thermal guard zone are equipped with a permanent set of sensors ensuring the thermal state control of the lab and basic acquisition data for experiments: surface temperature sensors within the cells walls (test façades and test cells walls), air temperature in test cells (air and globe thermometer) and thermal guard zone near the test cells.

Each cell is equipped with a switching panel composed of enough measurement channels to receive additional sensors for experiment special needs: relative humidity probes, heat flux plates, pyranometers, lux meters, power meters, etc.

Two dedicated weather stations are located respectively on the roof of the lab and in the nearby field. They are both independent and fully equipped: temperature, humidity, solar irradiance (direct, diffuse, reflected, infrared), atmospheric pressure, rainfall, wind speed and direction. In addition, the roof weather station has a fisheye camera.

Additional climate sensors (wind, temperature, solar irradiance) are mounted near test façades and measure close outdoor climate.

A centralized acquisition system is placed in the thermal guarded zone. It is constituted of 7 Agilent 34980A acquisition units, and NI datalogger plus RS-485 concentrator. The whole sensors data of the lab are recorded every minute continuously.

### Construction and boundaries

Over-insulated walls are made of Plasterboard + Mineral Wool + XPS + EPS for a  $U$ -value less than  $0.1 \text{ W/m}^2/\text{K}$ . All cells are integrated within a controlled temperature building acting as a thermal guard.

**Number of test beds** – 12 (6 vertical façades, 6 sloped roofs)

**Exposure** – East, South, West

**Climate** – Moret-Loing-et-Orvanne,  $48^\circ22'N$   $2^\circ50'E$ , Cfb

**Heating** – Electrical resistor inside each cell

**Cooling** – Air conditioning inside each cell

**Ventilation** – Mechanical fan inside each cell that mixes the air. No air exchange between inside and outside of the cell

### Dimensions and capabilities

Two types of test façades and cells:

- Vertical façades on cubic cells (approx.  $3.30\text{m} \times 3.60\text{m} \times 2.9\text{m}$  – length x width x height)
- Sloped roof façades on attic cells (approx.  $3.90\text{m} \times 3.40\text{m} \times 4.6\text{m}$  – length x width x maximum height)



► Fig. 1: view of BESTLab (South-West orientation)

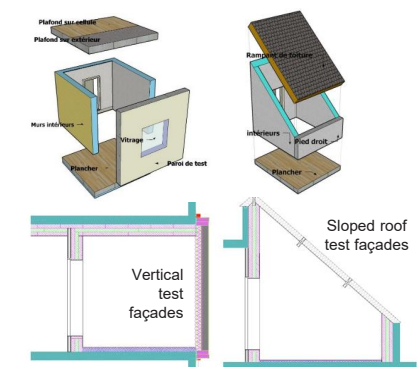

► Fig. 2: 3D view and vertical cross-section of cells

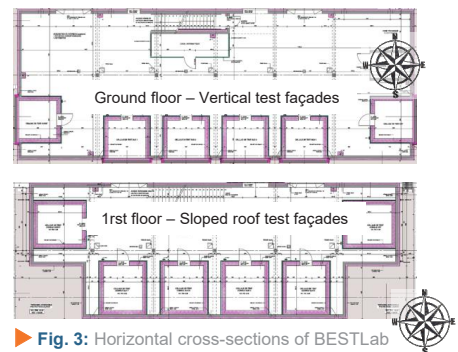

► Fig. 3: Horizontal cross-sections of BESTLab



► Fig. 4: View of inside of a cell with existing HVAC system

### Involved person(s):

Mathilde Colmet Daàge  
Matthieu Baranzini

► **Operating since:** 2011

► **Contact person(s):**

mathilde.colmet-daage@edf.fr



# Large Scale Vertical Building Envelope Climate Simulator

## Climate simulator (indoor test cell)

► Norwegian University of Science and Technology (NTNU) & SINTEF, Trondheim, NORWAY

### Aim of the test facility

The Large Scale Vertical Building Envelope Climate Simulator (Climate Simulator) is an experimental facility that belongs to the Advanced Materials and Component Laboratories co-owned by NTNU and SINTEF.

The primary aim of the Climate simulator is the testing of full-scale building envelope components (opaque and transparent, adaptive or conventional), under controlled, simulated outdoor and indoor boundary conditions. The system is capable of setting dynamic boundary conditions at the two sides of a building envelope component under test, in terms of air temperature, air humidity contents, and solar irradiation. While originally developed for testing of exterior walls and elements (with a height of up to 3.9 m), including testing of walls and facades with integrated, technologies as photovoltaics and ventilation ducts, the facility can also be used for testing indoor partition systems, as well as, accelerated ageing tests and rain durability tests.

### Description of the test facility

The test facility architecture is based on two coupled test cells, where the test wall/façade sample is positioned between the two chambers. The two test cells are independently accessible. An internal ventilation system is installed in each chamber to force air circulation in order to achieve a good temperature uniformity in each chamber. The air circulation is vertical type, from the ceiling to the floor.

The test cell that functions as the outdoor environment is equipped with a solar simulator, a matrix of 9 metal-halide lamps (0.4 m x 0.4 m each) for a total size of 2.4 m x 2.4 m, which delivers an irradiance of 1000 W/m<sup>2</sup> at 0.8 mm distance from the lamps plane with a spectrum that follows that of the solar radiation. The solar simulator can be dimmed in the range 40 % to 100 %, and draws up to approximately 44 KVA.

The wall/façade under test is installed in a removable steel or wooden frame.

The heating and cooling units of each test cell can keep the air temperature in the range -28 °C to +80 °C, and +5 °C to +50 °C, for the outdoor and in the indoor test cell, respectively, with an accuracy of ± 0.3 °C. Relative humidity can also be controlled in the range 20 % to 95 % (and in the range 20 % to 50 % when the solar simulator is used), with an accuracy of ± 3 %. Air temperature, relative humidity, and irradiation level setpoints can be variable during the test, so that dynamic profiles of air temperature, relative humidity, and irradiation can be realized.

A maximum differential pressure of 100 Pa can be realized between the two cells for testing phenomena driven by air pressure difference.

The facility is equipped with a rain test system, composed by a set of nozzles placed on the lateral wall of the chamber to ensure a good rain amount on the device under test. The rain intensity that can be achieved is in the range 10 to 100 dm<sup>3</sup>/(m<sup>2</sup> h), with droplet size in the range 15 to 35 microns. Rain tests are not compatible with control of the temperature and humidity.

### Monitoring and control system

The monitoring and control system of the test facility is integrated in just one hardware and software system, developed by the facility manufacturer in C language. It allows a real-time control of the digital and analogue signals (both input and output) needed for a correct programming of the test bed activity, implemented via a dedicated interface board. A graphic mode is available for user's interaction by keyboard, which allows a continuous monitoring of the chamber functions and actual measuring. It allows the set and programming operations, program managing, thermal cycles execution and parameters regulation by means of PID (proportional-integrative-derivative) algorithms. The software is organized in three levels of accessibility (operator, administrator and service operations) with associated different level of control features.

The monitoring and control system of the test bed makes use of capacity probes with accuracy of ± 1 % and Class A (accuracy ± 0.1 °C.), 3-wire PT100 probe, for relative humidity and air temperature measurements, respectively.

Additional sensors can be installed to monitor physical quantities on the sample under tests. These sensors can be either digital or analogue, and can be either connected to the controller of the Climate Simulator, or to an independent controller/data acquisition device.

### Construction and boundaries

The walls, ceiling and floor of each test cell are made of vapour tight prefabricated panels with high density polyurethane foam injection and stainless steel structure/interior 120 mm thick.

An automatic system assures the movement of one of the two chambers on rails in order to allow the placing of the wall/façade to be tested. The sealing between the fix chamber, the wall/façade sample, and the mobile chamber is ensured by special gaskets that are pressed by special pneumatic mechanical clamps.

The facility is installed in the Advanced Materials and Component Laboratories hall, which is an indoor space with controlled temperature.

### Number of test beds – 1

**Exposure** – NA (indoor facility)

**Climate** – NA (indoor facility)

**Heating** – up to 8 to 10 kW (each chamber)

**Cooling** – up to 25 kW

**Ventilation** – fully recirculation air

### Dimensions and capabilities

Each chamber has the following internal (useful)

dimensions (W x D x H): 3.7 m x 1.5 m x 3.3 m

The total dimensions of the test facility are (W x D x H): 7.0 m x 4.4 m x 3.9 m

The wall/façade sample under test can be up to 3.9 m (H) x 3.6 m (W), and a thickness of up to 0.8 m



► Fig. 1: External view of the Climate Simulator, with the outdoor cell on the left-hand side and the indoor cell on the right-hand side



► Fig. 2: View of the two rooms of the Climate Simulator on the left hand side, the cold room with solar simulator, on the right hand the warm room.



► Fig. 3: View of a sample facade and frame structures for installation in the Climate Simulator

- **Involved person(s):** Francesco Goia  
Alessandro Nocente  
Steinar Grynning
- **Operating since:** 2011
- **Contact person(s):** Arild Gustavsen  
arild.gustavsen@ntnu.no  
Terje Jacobsen  
terje.jacobsen@sintef.no
- **Website:** [www.zeb.no/index.php/en/laboratories](http://www.zeb.no/index.php/en/laboratories)

# Dual Air Vented Thermal Box (DAVTB) facility Laboratory hot box

► Department of Energy, Politecnico di Milano, ITALY

## Aim of the test facility

The Dual Air Vented Thermal Box (DAVTB) is a laboratory setup that allows to perform experimental analyses on building envelope technologies, both permeable (i.e. Dynamic Insulation, Breathing Walls [20]) and non-permeable to airflow. The test facility is able to reproduce user-defined operative temperature boundary conditions, both in steady [20] and unsteady [21] state. Data are collected to evaluate building envelope components energy performance under real boundary conditions.

## Description of the test facility

The test rig is mainly composed by two insulated chambers, with the sample located in between, and connected by the air recirculation system. The operative temperature is controlled in each chamber separately through a dedicated heating and cooling plant and the airflow crossing the sample is regulated in terms of both average velocity and direction.

Each chamber is 1.5 m wide, 1.29 m long and 1.5 m high. The envelope consists of a polystyrene layer, protected by 4 mm laminated on each side, for a total thickness of 140 mm and an overall conductance of  $0.23 \text{ W}/(\text{m}^2 \cdot \text{K})$ . The sample is accommodated in a metal frame ( $1.5 \text{ m} \times 1.5 \text{ m}$ ) located between the chambers and insulated on the perimeter. The net sample area is thus about  $1 \text{ m} \times 1 \text{ m}$ , allowing a maximum thickness of 33 cm of the test samples that can be tested. The air flows into a chamber and out of the other through two circular openings with a diameter of 20 cm, placed on the back side of each box and connected to the airflow loop.

Temperature control inside the chambers is achieved through an hydronic plant, working both as a heating and cooling system, linked to the central supply of the Energy Department building (primary plant) through two water tanks, where the maximum and minimum temperatures achievable in the hot and cold tank are  $70 \text{ }^\circ\text{C}$  and  $10 \text{ }^\circ\text{C}$  respectively. The secondary plant consists of three parallel water loops: two are connected to the radiant panels (superficial emissivity of  $0.92 \pm 0.94$ ) in each chamber; the third one supplies a water-to-air heat exchanger inside the air recirculation plant. Supply water temperature to terminals is independently controlled and defined by the user according to the desired thermal conditions: hot and cold water coming from the tanks are mixed in suitable proportion to obtain the desired supply temperature, by acting on two servo-valves for each circuit (a mixing valve and a diverter).

Along with the heat exchanger, the air recirculation plant can be divided into two more sections. One is the fan section, designed to control the airflow in terms of velocity and direction. It consists of two parallel centrifugal fans facing opposite directions and two butterfly shutters for each one. The other section of this system consists of a 2 m long PVC tube used to measure the airflow rate.

## Monitoring and control system

Measurement and control in the DAVTB apparatus are done through of a multifunctional switch unit (Agilent 34980A), equipped with three kinds of modules: voltage and current measurement (34921A/T), proportional controller and waveform generator (34951A/T), ON/OFF controller (34938A/T). The remote control is based on a LabVIEW algorithm. All the electrical devices in the facility (water pumps, hydraulic valves and butterfly shutters) are activated using the ON/OFF switches, while the proportional modules are used to regulate mixing valves and diverters in the hydraulic plant, to control the proportional shutters in the air recirculation plant and, finally, to produce the waveform regulating the rotational velocity of the fans through PWM controller ( $48 \pm 560 \text{ Pa}$  at  $30.6 \pm 106.2 \text{ m}^3/\text{h}$ ).

The environmental parameters are measured using various probes. A two-directional fan anemometer (a vane wheel sensor in the measurement section able to record velocities in the range  $(0.4 \pm 20) \text{ m/s}$ ) to evaluate the airflow rate through the sample. The overall measurement chain, including the multimeter, the PVC pipe and the fan anemometer, has been calibrated, obtaining a measurement accuracy of  $1.3 \cdot 10^{-4} \text{ m/s}$ .

All temperatures are measured using T-type thermocouples. In the hydronic plant water temperatures are measured using needle thermocouples, collecting data in two points of each tank and in the main locations of every loop of the secondary plant. Air temperature is measured in nine points of each Box to assess any thermal stratification, using probes shielded from the radiative heat exchange. Moreover, a globe thermometer has been installed in the geometrical center to measure the operative temperature. According to the features of the wall sample under investigation, it is possible to measure temperature distribution across its section and on its surfaces. All thermocouples have been calibrated in a temperature range from  $0 \text{ }^\circ\text{C}$  to  $70 \text{ }^\circ\text{C}$ , using a Pt100 as a reference, achieving correlation errors in the interval  $0.02 \text{ }^\circ\text{C} \pm 0.16 \text{ }^\circ\text{C}$ .

Heat flux density is measured on the sample surface using gSKIN® sensors with a nominal calibration accuracy of 3%.

## Construction and boundaries

The experimental setup is able to reproduce both steady and unsteady state thermal conditions, in the range  $15 \pm 45 \text{ }^\circ\text{C}$  and with an observed precision of  $\pm 0.2 \text{ }^\circ\text{C}/\pm 0.6 \text{ }^\circ\text{C}$  in steady/periodic conditions. Airflow rate through the sample can be controlled in direction and velocity ( $0\text{-}13 \text{ mm/s}$  across the sample wall).

**Number of test beds – 1**

**Exposure – indoor facility**

**Climate –** user defined thermal conditions

**Heating –** radiative panels, heat exchanger

**Cooling –** radiative panels, heat exchanger

**Ventilation –** recirculation  $30.6 \pm 106.2 \text{ m}^3/\text{h}$

## Dimensions and capabilities

Each chamber has the following dimensions (W x L x H):  $1.5 \text{ m} \times 1,29 \text{ m} \times 1,5 \text{ m}$ .



► Fig. 1: Dual Air Vented Thermal Box (DAVTB)

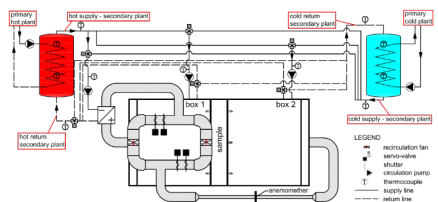

► Fig. 2: Basic layout of the overall setup, with a schematic representation of both hydronic plant and air recirculation system

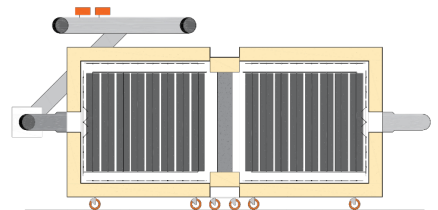

► Fig. 3: Vertical section of the two chambers and the sample along the longitudinal axis

- **Involved person(s):** Andrea Alongi  
Adriana Angelotti  
Livio Mazzarella  
2016
- **Operating since:** 2016
- **Contact person(s):** Adriana Angelotti  
adriana.angelotti@polimi.it
- **Website:** <http://www.energia.polimi.it/en/energy-department/laboratories/research/building-physics-laboratory/>

# MATELab

## Façade test cell to study occupant response

► University of Cambridge, Cambridge, UK

### Aim of the test facility

MATELab (Mobile Adaptive Technologies Experimental Lab) is a novel bespoke experimental facility for assessing the holistic effects of façades on occupant comfort, satisfaction and productivity (Figure 1). MATELab represents an intermediate step between high precision, but unrealistic lab-scale tests and realistic, but difficult to control real-office environments. MATELab is designed to capture occupant response in a controlled environment, reducing the bias of highly-controlled laboratory chambers whilst allowing accurate monitoring of the environmental and contextual variables affecting occupant response.

### Description of the test facility

MATELab is an office-like space of approximately 30 square metres with three glazed façades oriented towards south, east and west and designed to host up to three occupants. The location has been chosen to provide an open and green view from indoors (Figure 2). The design concept was to develop a flexible facility for assessing alternative façade technologies, either simultaneously by dividing the chamber in two parts (A in Figure 3), or separately but in three different orientations (B,C and D-Figure 3). MATELab is not rotatable, however the glazed façades can be easily changed and covered with opaque insulated panels in order to test alternative façade technologies in different orientations and according to research needs. MATELab is a flexible facility, also allowing changes in internal desks and furniture layout or to assess the façade effect at different distances.

All environmental services in MATELab have been designed to avoid any local discomfort for occupants, providing sufficient levels of light when daylight is not available, or providing comfortable appropriate temperatures and ventilation rates. MATELab can be transformed into a natural ventilated office, however it has been decided to start the investigations with a mechanically ventilated HVAC system in order to provide larger control on the environmental parameters. The HVAC system is an Under Floor Air Displacement system (UFAD) for Ventilation, heating and cooling. The artificial lights are a LED technology suitable for computer work, complying with EN-12464 and with tunable white for adjustable colour temperature in relation to the time of the day.

### Monitoring and control system

MATELab has been equipped with a wide range of sensors in order to capture the holistic effect of façades on thermal, visual, acoustic, air quality comfort and, additionally, the interaction of the occupant with the intelligent or static façade. The main parameters of each type of comfort are monitored at the façade level and in three alternative workstation positions (Figure 4).

High frequency vibrations, such as the one caused by services or underground, can be induced to assess the occupant response to them.

Occupant response is captured by direct and indirect means. Direct means account for: polling stations, surveys and interviews. Indirect means consist in facial recognition, thermal image pictures of occupant and physiological sensors.

All data is logged in a secured database, using LabVIEW. Artificial lighting and HVAC can be controlled according to the desired scenario.

Each half cell has been equipped with individual energy meters for each power load.

### Construction and boundaries

Walls are made of Steel + Sandwich PIR Foam panels 100 mm + Wood panels for a U-value of 0.12 W/m<sup>2</sup>.K

**Number of test beds** – 1 or 2

**Exposure** – South, West and East

**Climate** – Cambridge, 57°02'N; 10°0'E - Dfb

**Heating** – UFAD

**Cooling** – UFAD

**Ventilation** – Mechanically ventilated. The test cell can be divided in two chambers with two independent UFAD ventilation systems.

### Dimensions and capabilities

The internal dimensions of the test room are 5 m x 6 m x 2.50 m (width x length x height), resulting in a floor area of approx. 30 m<sup>2</sup>.

All the frames of the tested façades are made of wooden beam.



► Fig. 1: View of the west side of MATELab



► Fig. 2: View from the inside of MATELab

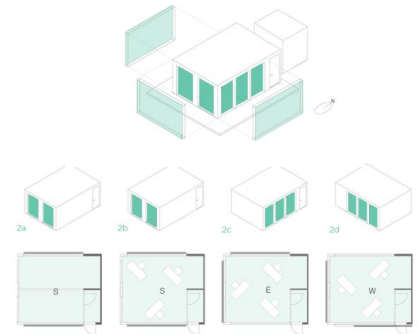

► Fig. 3: Plan and view of the alternative potential orientations

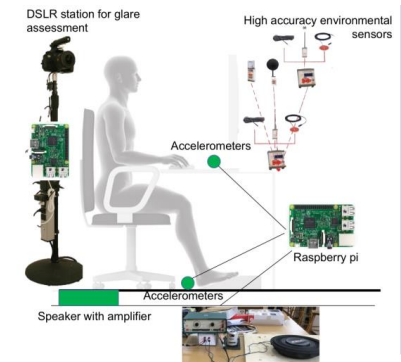

► Fig. 4: Methods for environmental monitoring

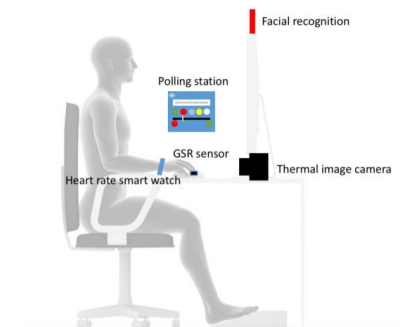

► Fig. 5: Occupant response monitoring systems

### ► Involved person(s):

Alessandra Luna-Navarro,  
Mauro Overend

► **Operating since:** 2018

### ► Contact person(s):

Alessandra Luna-Navarro  
[al786@cam.ac.uk](mailto:al786@cam.ac.uk)

### ► Website:

[www.gft.eng.cam.ac.uk](http://www.gft.eng.cam.ac.uk)



# Passivhaus in Mascalucia (Sicily) - Zero Energy Building Living Lab

## Outdoor real-scale facility

► eERG Group - Politecnico di Milano

### Aim of the test facility

The building is a single family detached house located in the municipality of Mascalucia (Catania), in Sicily. The building (Fig. 1) follows the requirements of the Passivhaus certification in term of energy need for space heating lower than 15 kWh/m<sup>2</sup>/year, energy need for cooling and dehumidification lower than 15 kWh/m<sup>2</sup>/year, primary energy for all domestic uses lower than 120 kWh/m<sup>2</sup>/year and air tightness lower than 0.6 ACH. The design is based on extensive optimization studies for the envelope, the earth to air heat exchanger (EAHE) and the control logic [40; 41; 42]. It represents an example of nearly Zero Energy Building (nZEB) in Mediterranean climate and it was conceived as a living lab, offering the opportunity to test different logic and control strategies for building services systems, and for transparent adaptive façade elements; moreover, it is meant to study the user response to and interaction with them [43; 44].

### Description of the test facility

The building is a single-storey house (Fig. 1) including a basement in which technical (Fig. 2) and parking spaces are located. It is equipped to perform both as a passive house or with an active cooling/heating system. The high envelope performance is complemented by the local production of renewable energy by means of PV modules, solar thermal system and by an EAHE (Fig. 3). The PV system (8.14 kW peak electric power) is installed on the roof and its electricity production is continuously monitored and compared with the instantaneous energy use of the building and the delivered energy (from the grid). An electrical air-to-water heat pump serves the heating/cooling coil in the main inlet ventilation duct and a thermal storage tank (500 litres of hot water), which is also fed by the thermal solar panels integrated in the roof (7 m<sup>2</sup> of flat collectors). Also the air conditioning system is fed by the reversible air-to-water heat pump. During the heating phase it may work by heating the technical storage tank or by supplying the coil in the ventilation system, whereas in cooling mode it can produce chilled water to directly supply the coil in the ventilation system. The EAHE provides the possibility for pre-heating or pre-cooling the ventilation air, which may then pass through a heat recovery unit before being treated by the heating/cooling coils and distributed to the rooms. The exhaust air is extracted from the bathrooms and the kitchen in order to remove the internal pollutants. The EAHE can be excluded from the ventilation system by means of a by-pass duct, if required, according to the chosen control strategy. The outdoor window surfaces are protected by mechanical solar shading systems, which can be controlled manually or through an automatic system. In order to guarantee an adequate monitoring of the internal microclimate (thermal comfort and air quality), each room is equipped by temperature, relative humidity and CO<sub>2</sub> concentration sensors (the latter chosen as an indirect indicator of the air quality) (Fig. 4).

### Monitoring and control system

A system has been designed and installed to provide adequate monitoring and control of the building and of its service systems. It allows also for the detailed monitoring of energy and comfort performance. The control and monitoring system consists of two main parts, developed and integrated at different times. The first one handles indoor environmental parameters monitoring, the basic control of shading devices and of the heat pump. It is based on the Konnex (KNX) standard and communication protocol. The second part integrates and supervises the first and it is based on the BACnet communication protocol. It includes the monitoring of a high number of sensors positioned in different sections of the building systems, and it allows for the implementation of further control algorithms for the heat pump and the ventilation systems. Finally, the thermal energy meters, installed along all the hydraulic loops, are communicating by means of the Meter-Bus (M-Bus) standard also integrated and supervised by the BACnet system. All the control strategies and the parameters can be monitored through the integrated management platform Desigo™. The parameters are recorded at a fixed frequency of 5 minutes, except for the opening of the windows and the position of the solar shadings, which are recorded at each change of status.

### Location

Mascalucia (Catania) - Sicily, Italy

### Building type

Detached single family house

### Construction type

Structural concrete and masonry, with mineral wool thermal insulation

**Conditioned floor area:** 144 m<sup>2</sup>

**External walls thermal transmittance** – 0.13 W/(m<sup>2</sup>K)

**Roof thermal transmittance** – 0.13 W/(m<sup>2</sup>K)

**Basement thermal transmittance** – 0.23 W/(m<sup>2</sup>K)

**Windows thermal transmittance** – 0.90 – 1.10 W/(m<sup>2</sup>K)

**Envelope air tightness (n50)** < 0.60 volume/h

### ► Involved person(s):

Prof. Lorenzo Pagliano  
Prof. Francesco Causone  
Marco Pietrobon  
Anita Tatti

► **Operating since:** 2013

► **Contact person(s):**

lorenzo.pagliano@polimi.it  
francesco.causone@polimi.it

► **Website:**

[http://www.eerg.it/index.php?p=Progetti\\_-\\_Botticelli](http://www.eerg.it/index.php?p=Progetti_-_Botticelli)



► Fig. 1: External view of the house



► Fig. 2: Part of the installed sensors in the mechanical ventilation system



► Fig. 3: View of the earth to air heat exchanger (EAHE)



► Fig. 4: Indoor thermal comfort monitoring sensors

# BPS Test Façade

## Full-scale test Rooms with Reconfigurable Façade

► Eindhoven University of Technology, Eindhoven, THE NETHERLANDS

### Aim of the test facility

The test façade of the Unit Building Physics and Services (BPS) at Eindhoven University of Technology is primarily used for daylight and façade-user interaction studies. The full-scale laboratory is exposed to ambient conditions and has a modular façade that is easily replaceable to accommodate a wide range of façade technologies, fenestration systems and solar shading products. By changing the position and lay-out of interior partitions, it is possible to create up to five single person office spaces for side-by-side comparisons of the performance of different façade variants.

Over the past years, research has been carried out for a variety of purposes:

- Photometric characterization of innovative facade systems;
- Empirical validation of simulation models;
- Development of new control strategies for adaptive facades;
- Development of new sensor systems;
- Perception studies;
- Assessment of façade-user interaction strategies and interfaces;
- Investigation of indoor environment.

### Description of the test facility

The test facility is integrated in the building of the Department of the Built Environment and is part of a larger laboratory with spaces that can be furnished and conditioned as standard office rooms. The facility was not designed for detailed thermal characterization studies, but focuses on daylighting and user interaction studies. The ceiling of the spaces can easily be adjusted to test the influence of combined daylight and artificial lighting solutions. The test facade is located at the second floor with an unobstructed view and is accessible from the outside via a dedicated balcony structure (Fig. 1). A West-facing location was chosen to enable the investigation of glare discomfort issues at low sun angles.

Example projects include:

- A pilot study, investigating the impact of automated façade control strategies on user acceptance and perception of indoor environmental quality (Fig. 2). Different operation strategies were tested, such as: fully automated vs. manual override; different rates-of-change and adaptation frequencies; random vs. meaningful changes in façade configuration.
- Combined qualitative and quantitative research to identify occupants' preferences regarding visual light transmittance in relation to visual comfort and performance (Fig. 3).
- Development and testing of an innovative control strategy for switchable windows. The tested algorithm knows the positions of the occupant and follows the sun position to reduce window transparency of glazing

surfaces that would lead to glare discomfort while allowing valuable diffuse sunlight to enter the space (Fig. 4).

### Monitoring and control system

Outdoor boundary conditions are measured at the site. Global horizontal irradiance and diffuse irradiance are measured with 'Spectrally Flat Class A' pyranometers at the solar measurement station at the roof of the building. Direct beam solar irradiance is also measured with a pyrheliometer. Dry bulb temperature, relative humidity, wind speed and wind direction are recorded at the height of the building.

Measurement equipment at the BPS Test Façade is usually selected on a per project basis and may include hot-sphere anemometers, thermocouples, heat flux sensors, illuminance sensors, HDR camera etc. Expertise is available to write special software for soliciting occupant feedback and registering user override actions.

### Construction and boundaries

Modular test façade exposed to ambient conditions and an office-like indoor environment.

**Number of test beds** – up to five

**Exposure** – West

**Climate** – Eindhoven, 51°26'N; 5°29'E - Cfb

**Heating** – Air-based heating system and electric radiators

**Cooling** – VAV system

**Ventilation** – Separate modular ventilation system for each zone

### Dimensions and capabilities

The dimensions of the test façade are (w x h) 11.8 x 2.7 m. The depth of the office rooms is max. 5.4 m. The most typical lay-out is a dual test office configuration with an acclimatization zone separating the two testing spaces.



► Fig. 1: BPS Test Façade, TU/e.

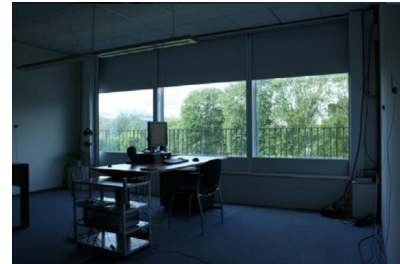

► Fig. 2: User satisfaction and interaction with automated dynamic facades [xx].

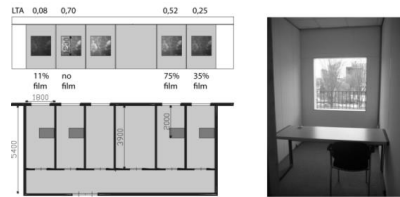

► Fig. 3: User acceptance of glazing with different visible light transmittance [yy]

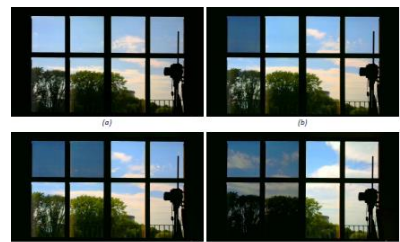

► Fig. 4: Development of novel control strategy for liquid crystal switchable windows [zz].

- **Involved person(s):** Jan Diepens  
Roel Loonen  
Alex Rosemann
- **Operating since:** 2003
- **Contact person(s):** j.f.l.diepens@tue.nl  
r.c.g.m.loonen@tue.nl
- **Website:** www.tue.nl/bps



# HCU Studio for Room Comfort

## Real-scale test Room with Reconfigurable Façade

► Façade Systems and Building Envelops Unit, HafenCity University, Hamburg, GERMANY

### Aim of the test facility

The Façade Systems and Building Envelops Unit is focusing of interdisciplinary research with architects, civil engineers, and building physicists. The areas of research cover design and materials, construction and reliability, as well as energy efficiency and room comfort. The unit is equipped with expert software (e.g. ANSYS research) and multiple test facilities:

- Acoustic studio
- Laboratory for building materials
- Laboratory for mechanical component testing
- Studio for room comfort

The studio for room comfort is primarily used to develop and test façade systems, components, and control strategies for optimized energy efficiency and user comfort.

### Description of the test facility

The studio for room comfort is integrated in the building of the HafenCity University (Fig. 1) and is furnished and conditioned as a standard office room (Fig. 2).

The studio is located at the third floor with an unobstructed view. A south-facing location was chosen to enable the investigation of summer overheating and cooling by natural ventilation.

The first project starting in 2014 included:

- Design and installation of a new type of "bypass double façade" with adaptive natural ventilation options. Bypass channels enable natural ventilation directly from the outside without gaining additional heat in the cavity.
- Bypass channels are designed for natural ventilation with high noise reduction. Acoustic absorbers are installed inside of the channels to reduce the sound pressure level with contemporaneous natural ventilation.
- Equipping the studio with different sensors. This includes two weather stations for monitoring the climate; multiple temperature sensors in the cavity (Fig. 3), the office room, adjacent rooms, concrete slabs and building surfaces; acoustic sensors for monitoring the efficiency of the bypass channels; humidity and illuminance sensors; monitoring the energy consumption for heating, artificial lightning and other equipment as well as a self developed people counter to calculate the internal gains.
- Creating a computer model in a building simulation tool for modelling the office room with the bypass double skin façade. The measured data from more than two years are used to validate this model.
- Development and testing of an innovative control strategy. The algorithm controls the motors based on actual measured room comfort metrics as well as future metrics calculated with the validated room model based on the weather forecast.
- Parameter study including approx. 10,000 different configurations based on the validated model.
- Based on the parameter study, different design

nomograms for bypass double façades are developed (Fig. 4). These nomograms include three climate regions in Germany, the room width, internal gains, the cavity depth, the window size for interior, exterior and bypass windows as well as the building orientation. The potential overheating [h/a] and the energy demand for heating can be estimated using these nomograms.

### Monitoring and control system

In total 97 metrics are recorded. All sensors and control units are connected to a KNX bus system and controlled via an OPC server. In 30 second intervals the sensors are read and logged in a MySQL database.

The server is running the previously mentioned façade control software. Manual control commands by occupants are always prioritized for 30 minutes. Then, the software takes over the control again based on the current and future room behavior.

**Exposure** – South (164° from North)

**Climate** – Hamburg 53°32'N; 10°00'E – Cfb humid warm temperature climate

**Heating** – water-based heating system

**Cooling** – not yet installed

**Ventilation** – natural ventilation

### Dimensions and capabilities

The dimensions of the test façade are  $w \times h = 6.30 \times 3.25$  m. The cavity depth is 1.13 m. The depth of the office rooms is 6.00 m.



► Fig. 1: HCU Hamburg, South façade

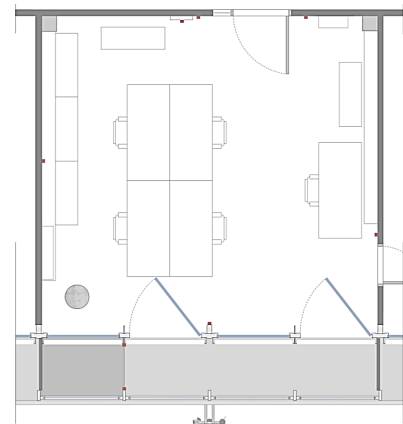

► Fig. 2: Studio for thermal comfort, ground floor

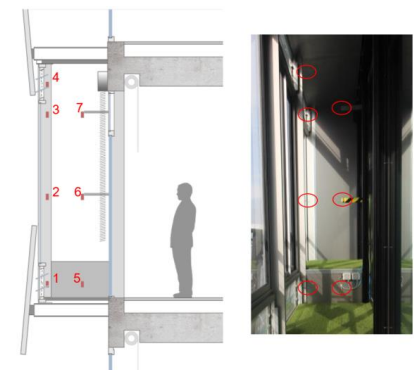

► Fig. 3: Bypass Double Façade, vertical section with air temperature sensors in façade cavity

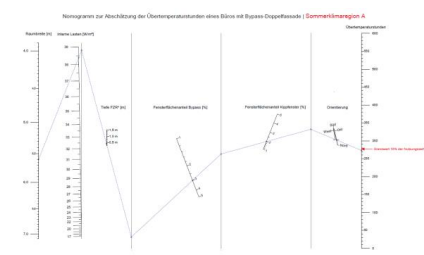

► Fig. 4: Exemplary design nomogram for bypass double skin façades

### Involved persons:

Frank Wellershoff  
Matthias Friedrich  
Klaus Schweers

### Operating since:

2014

### Contact person(s):

frank.wellershoff@hcu-hamburg.de  
matthias.friedrich@hcu-hamburg.de  
klaus.schweers@hcu-hamburg.de

### Website:

www.hcu-hamburg.de/wellershoff

# Multifunctional Facade Lab

## Indoor Lab – Guarded Hot-Box, Solar simulator for Active Facades

► EURAC Research, Institute for Renewable Energy, NOI Techpark, Italy

### Aim of the test facility

This test Cell evaluates, either in dynamic or static mode, the thermal and energy performance of traditional building components (e.g. walls, windows and doors) and of innovative building envelope systems, such as walls and floors that integrate active solar systems for energy production or radiant circuits.

### Description of the test facility

The test Cell is composed of a double chamber with: a guard-ring (the Guarded Hot-Box) built in accordance with standards UNI EN ISO 8990 and UNI EN ISO 12567-1; a solar simulator with lamps that emulate solar radiation; an external hydraulic circuit for evaluating the energy performance of hydraulic systems integrated in building components; a detailed monitoring system of sensors and data acquisition instruments that measure significant physical parameters with the aim of determining the characteristics of the test sample.

### Monitoring and control system

When conducting the tests, the specimen is inserted into a frame located between the two climate chambers (a hot box consisting of a guard box (no.1) and a measurement box (no.2) and exterior air conditions (cold box, no.3) by controlling the temperature, humidity and air velocity.

The solar simulator (no.6) reproduces the irradiation conditions on the external surface of the test sample while the hydraulic circuit controls any active hydraulic systems integrated in the sample.

The indoor laboratory equipment tests standard building elements in accordance with the requirements of standard UNI EN ISO 8990. The aperture in the panel at the bottom of the cold-box and the solar lamps permit the evaluation of the energy performance and thermal properties of active envelope elements with solar systems, in both static and dynamic modes.

The hydraulic circuit can be used to calculate the heat absorbed by the active element as well as the heat removed or delivered throughout systems embedded in the construction element. For testing activated building systems (radiant wall / ceiling / floor systems), connection to the hydraulic circuit and local measurement of heat flows allow the evaluation of the static and dynamic yield performances of the element.

### Construction and boundaries

In the guarded hot box, the temperature is continuously controlled and can vary with a maximum gradient of 0.2°C per minute. The measurement box is equipped only with an electrical heating device. The guarded box and the cold box have air conditioning systems for both heating and cooling.

The relative humidity in the hot boxes (guarded

and measurement) can be maintained under 15%RH as prescribed in the reference standards, while in the cold box it can be controlled for temperatures ranging between 20°C and 40°C.

The air velocity can either be mechanically regulated by varying the dimensions of the channels (no.4) in which the air is conveyed or automatically by regulating the speed of the installed fans.

In the Solar simulator, the power of the solar radiation on the surface of the test sample can be continuously controlled in the specified interval.

The hydraulic circuit can maintain constant inlet temperature and flow rate as specified and can be used to measure the thermal power exchange between the inlet and outlet flows[W]. In addition pressure losses can also be measured.

### Number of test beds – 1

Exposure – NA (indoor facility)

Climate – NA (indoor facility)

Heating – Heating coil



► Fig. 1: Test Cell

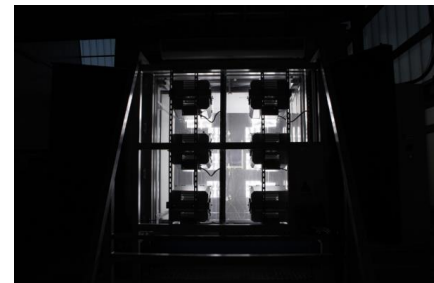

► Fig. 2: Test Cell with active sun simulator

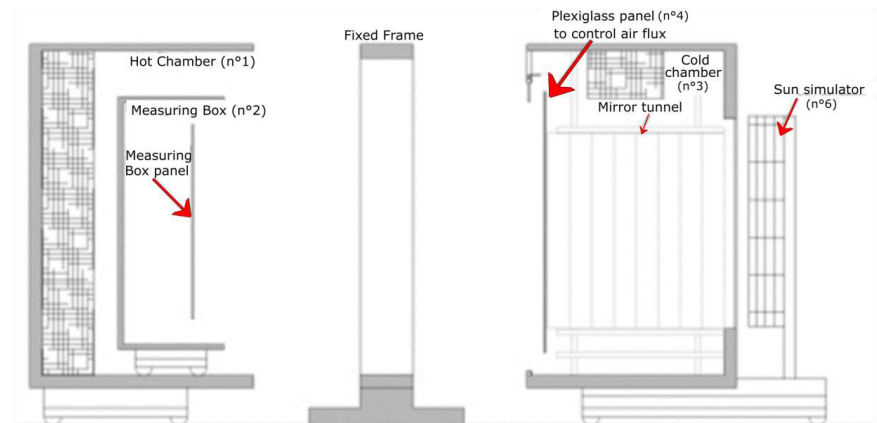

► Fig. 3: Section of Test Cell

Cooling – Air conditioning (cold chamber only)

Ventilation – Used only to keep uniform the thermal conditions within the chambers

### Dimensions and capabilities

The maximum dimensions of one façade sample are height 3.00 m, width 3.00 m, and maximum thickness 0.50 m. Under certain circumstances, depending on the sample and on the aim of the test, smaller limits may apply.

► **Involved person(s):** Giordano Miori  
Roberto Lollini  
Francesco Babich  
Stefano Avesani

► **Operating since:** 2010

► **Contact person(s):** Giordano Miori - [Giordano.Miori@Eurac.edu](mailto:Giordano.Miori@Eurac.edu)

► **Website:** <http://www.eurac.edu/en/research/technologies/renewableenergy/Infrastructure/Pages/Building-Systems-Test-Facility.aspx>

# Conclusions

## Example of research activities

The Cube was built in the fall of 2005 in the frame of IEA ECBCS ANNEX 43/SHC Task 34 for experimental investigation of double-skin façades [22-23]. Later on, it has been adapted to different purposes i.e. characterisation of intelligent glazed façades [24-25]; performance assessment of radiant walls and chilled beams in dynamic conditions with solar exposure [26]; investigation of thermal and visual comfort for different control strategies of solar shading, performance characterisation of different solar shading devices, etc.

At ESTP, the test cell is now under development. Candidate technologies for the future experimental campaigns include pre-fabricated façade elements for new buildings and retrofits, integrating, for example, active elements (such as photovoltaic and concentration photovoltaics modules or solar thermal collectors) or decentralized mechanical ventilation systems with heat recovery. Other likely candidates are advanced glazing systems presenting thermochromic, thermotropic or electrochromic properties and highly insulating layers such as aerogels. The dynamic behaviour of materials such as air-permeable concrete and organic/inorganic phase change materials, and the cooling properties of highly reflective coatings could also be tested under real solar radiation and wind conditions.

In the last 10 years the TWINS facility has been extensively used to carry out monitoring campaigns on advanced adaptive façades. A relevant activity has been devoted to the experimental characterisation of active transparent façades, in particular climate (mechanically ventilated) and hybrid (fan assisted) façades [8-9]. An extensive monitoring was performed on a new multifunctional façade module (MFM), called ACTRESS (ACTive, RESponsive and Solar) [10]. Different dynamic glazing systems have been tested and some are still under investigation: a simple PCM window prototype [27], thermotropic and PCM-filled glazing units (assessed both independently and when coupled together) [28], a polycarbonate panel filled with PCMs used as shading device. Presently, an opaque modular ventilated façade, made of wood and lightweight components (as cardboard and/or cork), is also monitored.

In Típee Platform, commissioning of roof and façade test facility started in March 2018. A calibration period with reference component is under monitoring to identify a "blank" thermal response of test-cells and evaluate the similarity in response of twin cells used for comparison. This step draws out calibration coefficients in order to correct the model raw thermal responses from particular phenomenon (mainly thermal bridges effects and sensor response). Following that, experimental campaigns will start on roof and facade elements which target to integrate evaporative cooling function within these envelope elements. Potential research activities of such equipment could be focused on studying: 1) the effects of the implementation of envelope systems (mimicking common errors and evaluating their consequences through measurement); 2) the physics phenomena at smaller time scale than current hourly step basis (solar spot) with the aim to use the results to refine numerical codes in dynamic simulation; and 3) roof and façade's performance led on different real-scale within oceanic European climate.

In LECE, the test facilities have been used to experimentally support the following studies:

- Experimental energy analysis of empty monozone reference building applying system identification tools. The analysis focused in the effect of heat exchange with the soil [29].
- Analysis of opaque and window components tested in a test cell. Proposal for uncertainty estimation according GUM, analysis of problems related to tests in sunny weather and solution of these problems [15, 30].

The lab equipment has been in use since 1989 for CIEMAT services to external clients and funded research projects. Many of these projects dealt with developing and setting up the test facilities and tests procedures. Some supported by the EU were: PASSYS II (1989-1992) [31], COMPASS (1992-1995); PASLINK (1992-1994), PV-HYBRID-PAS

(1996-1998), IQ-TEST (2000-2003), etc. In other projects, the test facility participated by giving experimental support to research, such as PASCOOL (1992-1995) about Passive Cooling, APISCO (1996-1998) analysing the effect of plants in thermal comfort, and ARCHINT (1999-2001) on architectural integration of solar collectors. The LECE participates to the network organizations DYNASTEE, and IEA EBC ANNEX 58 for Reliable Building Energy Performance Characterisation Based on Full Scale Dynamic Measurements [32].

Regarding connection of real-scale facilities such as the AFRISOL buildings in Spain or the ZEB Living Lab in Italy to adaptive facades, it is currently limited to a double-skin façade for Spain and the shading device system, and its control interference with natural ventilation and lighting for Italy.

However the focus of those buildings is to test control strategies and technologies interaction in such a particular environment, and future retrofitting operations might be led and their effect on a real, though highly monitored, building could be tested (even through small rehabilitation such as adding new "adaptive windows technologies"). Moreover user-interaction with new technology might be tested.

Since 2005 the facilities included in the GESLAB platforms were utilized for several research projects generally founded and supported by public calls. These research activities were the INVISIO (Industrialización de Viviendas Sostenible) project [33], which includes the APOLO, PROFIT projects regarding steel frame and multi-layered and light opaque and transparent façades. BALI (Building Acoustics for Living) project regarding healthy and acoustic efficient construction systems and buildings [34]. SIREIN (Sistema Integral de Rehabilitación Energética) project which was part of the INNPACTO National Program [35]. Several PhD thesis were developed based on the tests conducted in the Geslab facilities regarding:

- Multi-layer light steel frame opaque façade [36];
- Analytic indicators for energetic efficient glazed façade [37];
- Optimization of passive opaque and translucent solutions for latent thermal storage energy [38];
- Interior ventilation air quality and efficiency in energy retrofit residential buildings [39].

Currently more campaigns of tests are conducted for three new PhD thesis concerning Green wall to improve the air quality; Energy efficiency retrofitting with EIFS systems; Adaptive radiant glass façade.

"MultiLab" has not been completed yet (Summer 2018), and therefore no tests have been conducted so far. However, the research activities that can be performed using this experimental facility are as follows. The duration of the tests may vary from a few days to several weeks, as required.

Firstly, it is possible to investigate the performances of building envelope components in real outdoor conditions. In this case, it is possible to perform thermal and energy analyses of façade systems and components by measuring the heat fluxes and calculating the energy balance. Secondly, visual and thermal comfort experiments can be conducted. In the former case, the focus is on daylighting and glare. In the latter, human participants are exposed to a range of thermal conditions (such as different air speed, temperature, relative humidity, and radiant temperature). Mainly for this type of tests, the lab has been designed to look as similar as possible to a normal room (e.g. presence of windows, internal painting, etc.), and not to a test cell. It is then possible to test active components integrated into the façade samples, the floor and roof, to analyze mechanical and natural ventilation systems (by measuring the air changes per hour, and the air distribution and composition), and also to perform hygro-thermal analyses of façade samples.

At NTNU/SINTEF, the Climate Simulator has been used for testing of both conventional and adaptive façade systems (Grynning 2014). Future tests are planned for the thermo-physical characterisation of different types of double skin facades under mechanical and natural ventilation mode.

# Conclusions

The ZEB Test Cells, Norway has been used for tests on advanced facades in combination with users, aiming at assessing implications on thermal and visual comfort. Future plans include testing on transparent facades with integrated shading-PV systems, in combination with a multi-domain characterisation. A numerical model of the test cell (Cattarin 2018) is also available and can be used for planning of experiments and validations.

## Outcomes

In this section, twenty one test-facilities are presented. These systems have been developed to suit different types of tests and characterization activities on building envelope components, including adaptive facades. Primarily, two layouts of test rig can be identified (single cell vs. double/twin cell) and combined with two configurations of controls for boundary conditions (guarded volume or no control). The type of test cell depends mainly on the type of tests that are planned, though all these facilities try to be flexible enough to be able to carry out different measurements (e.g. calorimetric tests and indoor environmental quality tests). In the section, the geometrical and material configuration of each test facility is illustrated, together with the description of the equipment for environmental control, as well as the monitoring and control system. Many of the facilities have very similar HVAC technologies and data acquisition systems, giving space for possible collaboration in development of common test procedures.

## References

- [1] Zero Carbon Hub (ZCH), 2014, Closing the gap between design & as-built performance – End of term report, Zero Carbon Hub.
- [2] Strachan PA and Vandaele L. Case studies of outdoor testing and analysis of building components. *Building and Environment* 2008, 43, 129-142.
- [3] BBRI. The PASSYS Test Cells. A common European outdoor test facility for thermal and solar building research, 1990.
- [4] Manz H, Loutzenhiser PG, Frank T, Strachan PA, Bindi R and Maxwell GM. Series of experiments for empirical validation of solar gain modelling in building energy simulation codes – Experimental setup, test cell characterization, specifications and uncertainty analysis. *Building and Environment* 2006, 41, 1784-1797
- [5] G. Cattarin, F. Causone, A. Kindinis, and L. Pagliano, "Outdoor test cells for building envelope experimental characterisation – A literature review," *Renew. Sustain. Energy Rev.*, vol. 54, pp. 606–625, Feb. 2016.
- [6] Wienold J, Christoffersen J, Evaluation methods and development of a new glare prediction model for daylight environments with the use of CCD cameras, *Energy and Buildings* 38 (2006) 743–757
- [7] Cattarin, G., Causone, F., Kindinis, A. Pagliano, L. Design choices and thermal simulations of a new test cell facility. 10th Conference on Advanced Building Skins, 03-04 November 2015, Bern, Swiss.
- [8] Serra, V., Zanghirella, F., & Perino, M. (2010). Experimental evaluation of a climate façade: Energy efficiency and thermal comfort performance. *Energy and buildings*, 42(1), 50-62.
- [9] Zanghirella, F., Perino, M., & Serra, V. (2011). A numerical model to evaluate the thermal behaviour of active transparent facades. *Energy and Buildings*, 43(5), 1123-1138.
- [10] Favoino, F., Cascone, Y., Bianco, L., Goia, F., Zinzi, M., Overend, M., ... & Perino, M. (2015). Simulating switchable glazing with energyplus: an empirical validation and calibration of a thermotropic glazing model. In *Proceedings of building simulation 2015*.
- [11] Francesco Goia, Valentina Serra, (2018), Analysis of a non-calorimetric method for assessment of in-situ thermal transmittance and solar factor of glazed systems, *Solar Energy* 166, 458-471, ISSN 0038-092X, <https://doi.org/10.1016/j.solener.2018.03.058>.
- [12] Bianco, L; Cascone, Y, Goia F, Perino M, Serra V (2017) Responsive glazing systems: Characterisation methods, summer performance and implications on thermal comfort, In: SOLAR ENERGY, pp 819-836
- [13] Favoino F, Goia F, Perino M, Serra V (2016) Experimental analysis of the energy performance of an ACTIVE, RESPONSIVE and SOLAR (ACTRESS) façade module, In: SOLAR ENERGY, pp 226-248
- [14] Paul H. Baker, H.A.L. van Dijk, PASLINK and dynamic outdoor testing of building components, February 2008, *Building and Environment* 43(2):143-151
- [15] Jiménez, M. J. Porcar, B., Heras, M. R. (2008). Estimation of UA and gA values of building components from outdoor tests in warm and moderate weather conditions. *Solar Energy*. 82(7), pp. 573-587.
- [16] Sánchez M.N., Sanjuan C., Suárez M.J., Heras M.R.. Experimental assessment of the performance of open joint ventilated facades with buoyancy-driven airflow. *Solar Energy* 2013; 91:133-44.
- [17] Sánchez, M.N., Giancola, E., Suárez, M. J., Blanco, E., Heras, M. R.: Experimental evaluation of the airflow behaviour in horizontal and vertical Open Joint Ventilated Facades using Stereo-PIV. *Renewable Energy* 109, 613-623 (2017)
- [18] Giancola, E., Sanjuan, C., Blanco, E., Heras, M. R. (2012). Experimental assessment and modelling of the performance of an open joint ventilated facade during actual operating conditions in Mediterranean climate. *Energy and Buildings*, 54, pp. 363–375.
- [19] Heras, M. R: at all. (2013). In Spanish. HACIA UNA NUEVA GENERACIÓN DE EDIFICIOS DE CONSUMO ENERGÉTICO CASI NULO Y CERO EMISIONES. Proyecto Singular Estratégico sobre ARquitectura Bioclimática y FRío SOLar - PSE-ARFRISOL (Heras, M.R.; Bosqued, R., ed.), ISBN: 978-84-7834-712-4, Editorial CIEMAT, Madrid, Spain.
- [20] Alongi A., Angelotti A, Mazzarella L. (2017). Experimental investigation of the steady state behaviour of Breathing Walls by means of a novel laboratory apparatus. *BUILDING AND ENVIRONMENT*, 123, p. 415-426.
- [21] Alongi A., Angelotti A, Mazzarella L. (2018). Measuring Breathing Walls effectiveness and dynamic behavior. *Proceedings of RoomVent & Ventilation 2018*, 2-5 June 2018, Espoo, Finland.
- [22] Kalyanova, O (2008). Double-skin façade. PhD Thesis, Department of Civil Engineering, Aalborg University, Denmark.
- [23] Larsen, OK, Heiselberg, P & Jensen, RL 2014, Experimental data and boundary conditions for a Double-Skin Facade building in external air curtain mode. DCE Technical Memorandum, nr. 38, Department of Civil Engineering, Aalborg University, Aalborg.
- [24] Winther, FV (2012). Intelligent Glazed Façades. PhD Thesis, Department of Civil Engineering, Aalborg University, Denmark.
- [25] Liu, M, Wittchen, KB, Heiselberg, P & Winther, FV (2014). Development and sensitivity study of a simplified and dynamic method for double glazing façade and verified by a full-scale façade element. *Energy and Buildings*, vol 68 Part A, 432-443.
- [26] Le Dreau, J, Heiselberg, P & Jensen, RL (2015). A full-scale experimental set-up for assessing the energy performance of radiant wall and active chilled beam for cooling buildings. *Building Simulation*, 8, 39-50.
- [27] Goia, F., Perino, M., Serra, V. (2014), Experimental analysis of the energy performance of a full-scale PCM glazing prototype, *Solar Energy*, 100, pp. 217-233.
- [28] Goia, F., Bianco, L., Cascone, Y., Perino, M., Serra, V. (2014), Experimental analysis of an advanced dynamic glazing prototype integrating PCM and thermotropic layers, *Energy Procedia*, 48, pp. 1272-1281.
- [29] Porcar, B (2009). In Spanish. Evaluación energética de edificios construidos: aplicación de metodologías de identificación de sistemas". PhD Thesis, Department of Atomic, Molecular and Nuclear Physics and Renewable Energies, Complutense University, Madrid, Spain.
- [30] Jiménez, M. J. (2005). In Spanish. Caracterización de cerramientos constructivos mediante células de ensayo de Intemperie. Aplicación del cálculo de incertidumbres a la optimización de los ensayos". Ph. D. Thesis, Department of Applied Physics, University of Almería, Spain.





Reichstag / Foster And Partners (image: M. Brzezicki)



# Conclusions

- [31] The PASSYS Services. Summary report of the PASSYS Project. Eds. P. Wouters, L. Vandaele, BBRI, EC DG XII, Brussels, 1994. EUR 15113 EN.
- [32] Jiménez, M. J. LECE-UIE3-CIEMAT Test Facilities. 2011. Full scale test facilities for evaluation of energy and hygrothermal performances. (A Janssens, S. Roels, L. Vandaele, ed.), ISBN 978-94-9069-584-2, BFG, UGent, Belgium.
- [33] J. Queipo, J. M. Navarro, M. Izquierdo, A. del Águila, D. Guinea, M. Villamor, Sergio Vega, J. Neila (2009). Proyecto de investigación INVISIO: industrialización de viviendas sostenibles. Informes de la Construcción. Vol. 61, nº 513, pp. 73 – 86.
- [34] Proyecto PSE (Singular y Estratégico): "BALI (Building Acoustics for Living): Sistemas y Edificios Acústicamente Eficientes y Saludables" (2008 – 2011).
- [35] Proyecto INNPACTO 2011: "SIREIN: Sistema Integral de Rehabilitación Energética" (IPT-2011-1980-920000) (2011 – 2014).
- [36] Letzai Ruiz, Eva Gómez, Alfonso García Santos, Sergio Vega (2010). Study of light-multi-layered façades. Engineering, Construction and Architectural Management. Vol.17, 1, pp. 65 – 77.
- [37] E. Rodríguez-Ubinas, L. Ruiz-Valero, S. Vega Sánchez, F.J. Neila González (2011). Latent heat thermal energy storage systems in lightweight construction. Sustainable Development and Planning V. pp. 935-946.
- [38] Rodríguez-Ubinas, L. Ruiz-Valero, S. Vega Sánchez, F.J. Neila González (2012). Applications of Phase Change Material in highly energy-efficient houses. Energy and Buildings. Vol.50, pp. 49 – 62 .
- [39] L. Ruiz, E. Delgado, F. J. Neila, Sergio Vega (2012). Comparativa del comportamiento acústico entre fachadas multicapas ligeras y fachadas tradicionales. Materiales de Construcción. Vol. 62, pp. 307, 397-409.
- [40] Carlucci, S., Pagliano, L., Zangheri, P. (2013). Optimization by discomfort minimization for designing a comfortable net zero energy building in the mediterranean climate. Advanced Materials Research, 689, 44-48.
- [41] Carlucci, S., and Pagliano, L.. 2013. An optimization procedure based on thermal discomfort optimization to support the design of comfortable net zero energy buildings. In BS2013: 13th Conference of International Building Performance Simulation Association. Chambéry, France
- [42] Carlucci, S., Cattarin G., Pagliano, L. and Pietrobon, M. (2014). "Optimization of the Installation of an Earth-to-Air Heat Exchanger and Detailed Design of a Dedicated Experimental Set-Up." Applied Mechanics and Materials 501–504 (January): 2158–61.
- [43] Causone, F., Carlucci, S., Pagliano, L., Pietrobon, M. (2014). A zero energy concept building for the Mediterranean climate. Energy Procedia, Vol. 62, pp. 280 – 288.
- [44] Causone, F., Pietrobon, M., Pagliano, L., Erba, S. (2017). A high performance home in the Mediterranean climate: from the design principle to actual measurements. Energy Procedia, 140, 67 – 79.



520 West 28th Street / Zaha Hadid (image: M. Brzezicki)

# KPI and structural aspects of Adaptive Facades





# 17 Key Performance Indicators (KPIs) Online Tool (<http://kpidb.eurac.edu/>)

► Eurac, Institute for Renewable Energy, Bolzano, ITALY

## Aim of the tool

Key Performance Indicators (KPIs) are precisely these indices as a KPI is defined as a quantifiable measure used to evaluate the performances of a given element, but also activity or process. Therefore, by definition, each KPI has its unit of measurement, a scale, and therefore enables to make a quantitative assessment and comparison of the performances of a certain building or a part of the building. It is worth highlighting that a KPI is not a feature of a material, such as its density or thermal conductivity, but it usually refers to a system. A basic example of KPI is the annual energy demand for space heating that is stated in the energy performance certificates of buildings. This KPI is a unique value, usually expressed in kWh/m<sup>2</sup>year, that can be used to classify the building according to certain energy bands or just to compare two buildings. The KPI has to be representative for a single specific characteristic of the system under investigation. This feature is very useful when talking about specific technologies, because it helps to easily identify the technology main features and how good the system is performing on that aspect. As an example, traditional building façades are thermally characterized by the U-value and the g-value as their ability to transfer heat with and without the presence of solar irradiance. On the

other hand, innovative façade systems and components need new or modified KPIs being able to describe their key features and their performances. The INTERREG ITA-AUT project "FACEcamp" ([www.facecamp.it](http://www.facecamp.it)) and the COST ACTION 1403 "Adaptive Façade Network" (<http://tu1403.eu>) have dedicated one entire working task each on the collection and the analysis of KPIs for adaptive façade technologies. For such complex system, the traditional façade KPIs are not anymore representative of the actual system performance. New or modified KPIs are needed to characterize the adaptivity of adaptive façade as well as their performance in terms of traditional KPIs.

## Description of the tool

The tool is a website that can be accessed via the internet from anywhere using computers, tablets or smartphones (<http://kpidb.eurac.edu/>). It has been designed to be easily usable and accessible, it includes a large number of KPIs, and many research projects and partners have supported its development.

In order to make the comparison possible, each KPI must be clearly defined so that everyone then calculates it exactly in the same way and using the same units. Using again the example of the annual energy demand for space heating, for

instance the floor area (m<sup>2</sup>) must always be calculated with the same assumptions (such as net area, gross area, etc.). Thus, the aim of the developed tool is being a comprehensive repository of the KPIs used in the built environment, and it includes, for each KPI, at least its univocal definition, its units of measurement, and how it is calculated.

## The user interface

The website contains three main tabs, namely "home", "database", and "projects and partners" (Figure 1). As its name suggests, in the "home" tab there is an introduction to explain the main aim of this tool, what KPIs are, and how the contents included into the KPI database have been selected. The second tab, "database", is where the user can search to find out the exact meaning of a given KPI, or to what KPIs should be used for a given purpose identify. The third and last tab, "projects and partners", provides an overview of the research projects that supported, at different levels, the implementation of this website. Lastly, at the bottom of the page, there are some general information about contact details, registration, how to cite this tool, and the license agreement.

eurac  
research

KPI Database



The tool is a repository of KPIs for buildings/district and cities collected from European projects, standards and scientific papers

► Fig. 1: KPIs tool homepage

# 17 Key Performance Indicators (KPIs) Online Tool (<http://kpidb.eurac.edu/>)

► Eurac, Institute for Renewable Energy, Bolzano, ITALY

As mentioned, the KPIs' database can be accessed from the "database" tab (Figure 2). At the top of the page, there is the possibility to look for a certain KPI by using keywords. These could be the name of the KPIs as well as other relevant words. The remaining part of the page is dedicated to the filters that can be selected to interrogate the database. When the user starts to set the first filters, such as "building" in the "macro scale" filter, then the subsequent filters became active according to these initial choices. In other words, a nested selection procedure was chosen to guide the user in the use of the database.

The filters cover several areas such as intended use of building, type of system or components, target group (who is more likely to use a certain KPI), and some broader thematic areas (e.g. thermal comfort, economy, energy, etc.). The basic idea is that this filtering process leads to the identification of the most appropriate KPI, or set of KPIs, for a given purpose for a specific user. The output of the query is a table (Figure 3) that summarizes all the KPIs that match the selected filters. Unregistered users have access to a limited number of results per query, while this restriction does not apply to the registered ones. Moreover, after having completed the registration and login, the users can also vote the KPIs, add comments, and suggest new KPIs. However, these will not be displayed and accessible to everyone until the website's administrators approve them.

## Website architecture

In order to create a more reliable and maintainable website, in this project, the content management system (CMS) Drupal was chosen. A CMS is essentially a software installed onto a web server that is used to manage the whole website with little or no knowledge of specific programming languages such as PHP or HTML. The webmaster can add, edit and remove contents performing simple operations such as text editing or image uploading. The use of an appropriate CMS also ensures that the website is properly displayed, and that its layout is automatically adapted to the device used by each user. For this reason, the use of tables has been avoided as it is difficult to adapt them to various screen dimensions and resolutions.

In this project, Drupal was chosen in particular for its flexibility, and the support available in-house and on the internet. The former enabled to accurately structure the graphical interface (Figure 1) and the visualization of the contents according to the project needs. The latter was important to ensure the correct functionality of the tool today, and to ease its long-term maintenance. For instance, regular updates are released for Drupal's themes, enhancing the capabilities of the website and fixing bugs and security issues. Unless the code of theme, and therefore its structure, is intentionally edited, future updates will automatically be installed without compatibility issues.

► Fig. 2: Filters for database interrogation

Name	Description
Annual Electric energy per net area or volume	Electric energy demand for square meter
Annual energy loss (Ventilation)	Thermal annual energy loss due to ventilation
Daily energy	Integral of energy transferred to the indoor in 24h
Energy Signature	Plot of the energy consumption of a building versus the mean ambient air temperature, usually on a daily basis
Latent heat thermal energy storage efficiency	Ratio of energy stored in the facade and energy collected from solar over 24h
Normalized electricity consumption of light	Electric consumption of light normalized by visual comfort and Area
Total system heat efficiency	Ratio between the 24h integrals of the total energy transferred to the indoor and the collected solar energy
Usable heat efficiency	Ratio between energy delivered to the indoor and the one stored in one day

Some results have been hidden to anonymous users, [register](#) to see them all.

► Fig. 3: Output of a query

## Acknowledgment

This work has been supported by:

- COST ACTION TU1403 "Adaptive Façade Network"
- and financially supported by:
  - Project H2020 ExcEED – European Energy Efficient building & district Database: from data to information to knowledge (grant agreement n. 723858)
  - European Regional Development Fund and Interreg ITA AUT programme within the project FACEcamp n. ITAT1039

► **Involved person(s):** Francesco Babich, Stefano Avesani, Daniele Antonucci, Wilmer Pasut

► **Operating since:** 2018

► **Contact person(s):** Francesco Babich  
[Francesco.Babich@eurac.edu](mailto:Francesco.Babich@eurac.edu)

► **Website:** <http://kpidb.eurac.edu/>



# 18 Structural Characterisation and Performance Assessment

## Introduction

Chiara Bedon, Martina Eliášová, Dániel Honfí, Marcin Kozłowski, Klara V. Machalická, Miroslav Vokáč, Filipe Santos, Mislav Stepinac, Thomas Wüest

Modern adaptive facades can significantly improve energy and thus cost, efficiency of both new and refurbished buildings by responding to the changes in the outdoor conditions. Furthermore, they can provide healthy and comfortable indoor environment to the building occupants, by adjusting the response to their needs.

As the main function of facades is to separate the indoor from the outdoor environment, their performance has a major impact to the building's energy usage is extremely important for reaching the European Commission's ambitious climate and energy targets by 2020, as well as to follow the 2050 energy roadmap goals.

However, another important function of facades is to transfer various design loads (to the building skeleton) and to accommodate movements due to the same actions, being characterized by different features as in the case of self-weight, wind, earthquake loads, as well as thermal actions, extreme mechanical loads, etc.

Depending on the type and level of adaptivity of a given facade, such a structural demand could lead to challenges during the overall design process.

On the other hand, structural adaptivity can lead to a more efficient static and dynamic response under varying loading conditions, i.e. increase resistance in case of extreme events and/or provide fail-safe collapse mechanisms, thereby enhancing structural robustness.

This document collects some major outcomes and feedback from the "Structural" Task Group within the WG2 - COST Action TU1403.

### References

- Kormaníková, L., Kormaníková, E., & Katunský, D. (2017). Shape Design and Analysis of Adaptive Structures. *Procedia Engineering*, 190: 7-14
- Marysse, C. (2016). *Structural Adaptive Facades*, Master thesis, Ghent University, Belgium. Available online (accessed August 2018): <https://lib.ugent.be/en/catalog/rug01:002300621>
- Ribeiro Silveira, R. (2016). *Flexible transparency: A study on thin glass adaptive façade panels*. Master Thesis, Delft University of Technology, The Netherlands. Available online (accessed August 2018): [uid:fd32f4fc-6dab-4468-83f2-53abcc12e715](https://www.researchgate.net/publication/312446883)



► Fig. 1: Flexible thin glass (Ribeiro, 2016)



► Fig. 2: Pneumatic actuators (Kormaníková et al., 2017)



► Fig. 3: Pneumatic cells (Marysse, 2016)

# 18 Structural Characterisation and Performance Assessment

## Design loads in structural adaptive facades

Chiara Bedon, Martina Eliášová, Dániel Honfi, Marcin Kozłowski, Klara V. Machalická, Miroslav Vokáč, Filipe Santos, Mislav Stepinac, Thomas Wüest

### Adaptivity & extreme loads

- ...as a part of full buildings and structural assemblies
- New structural design challenges
- Hazard mitigation

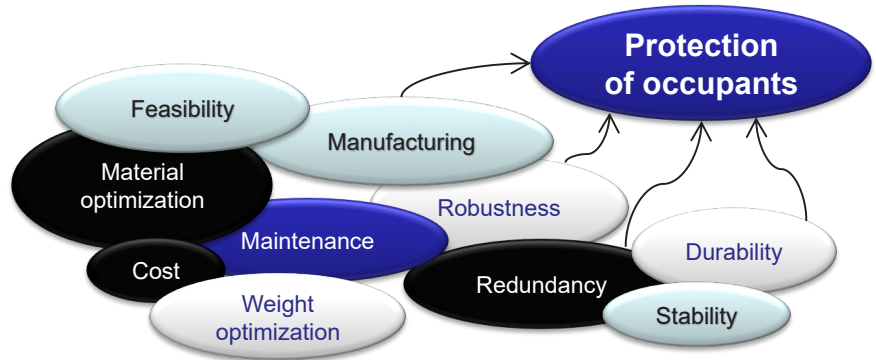

### Adaptivity & materials

#### Traditional vs. smart solutions

- Structural glass
- Responsive skins
- New forms of adaptivity
- Hybrid systems
- Bio-mimetic materials inspired by animals and plants...

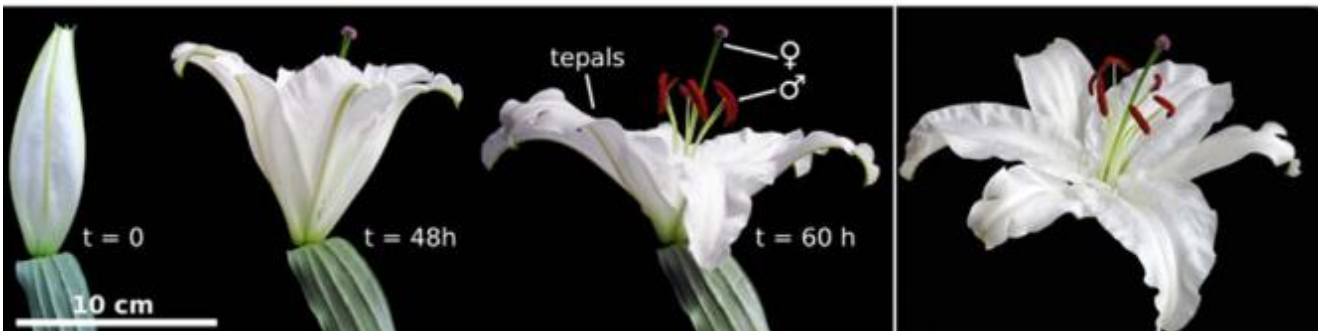

# 18 Structural Characterisation and Performance Assessment

## Design loads in structural adaptive facades

Chiara Bedon, Martina Eliášová, Dániel Honfí, Marcin Kozłowski, Klara V. Machalická, Miroslav Vokáč, Filipe Santos, Mislav Stepinac, Thomas Wüest

### Engineering perspective

Façade is the main parameter that influences the energy performance of buildings, façade elements needs to be designed to provide the buildings the necessary flexibility needed in terms of energy flow and thermal comfort. Nevertheless, key aspect of every structure is to have sufficient load-bearing capacity and stability. Adaptive structures must be systems with the ability to manipulate their internal force distribution or to influence their external loads – varying over time. Adaptive façades consist of multifunctional highly adaptive systems, where the physical separator between the interior and exterior environments is able to change its functions, features or behaviour over time in response to transient performance requirements and boundary conditions with the aim of improving the overall building performance (Loonen et al., 2015).

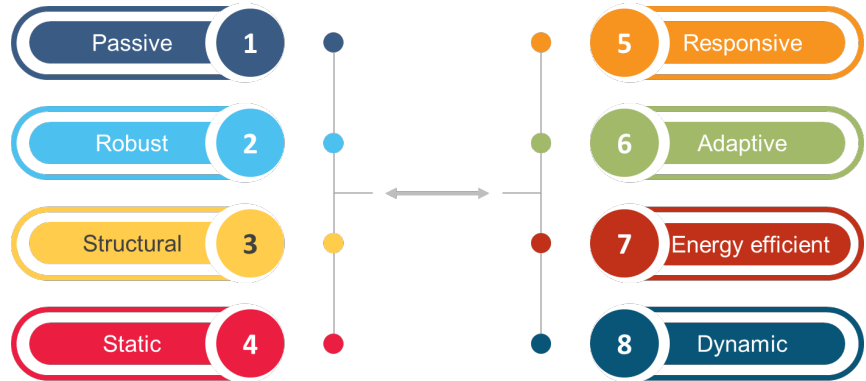

► Fig. 3: Design process of "normal" vs. adaptive structure



► Fig. 1: Engineering process in designing a structure

### Structural design

Main concerns in structural design are to define how to carry the loads and how to react to these loads. Adaptive facades must be able to manipulate the loads or the originated force distribution in a way that maximum peak forces are decreased and a homogeneous force and stress distribution can be obtained.

The goal for the structural design is to deliver a structure accomplishing safety and serviceability requirements.

Safety is accomplished by the structural system itself, while the serviceability does so by the control system.

Among issues such as seismic/wind-induced loading uncertainty, nonlinear structural performance, real-time response feedback, control algorithm implementation, etc., one of the main obstacles for the massive application of active control in civil structures is the reliability on the power supply.

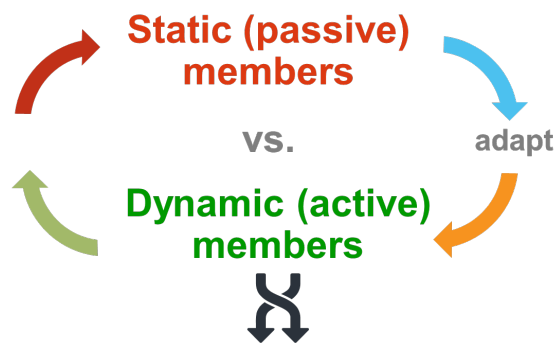

### New type of structural system

should be designed and created as smart from the earliest stages in the process of design

► Fig. 4: New types of elements regarding the different state of stresses

- Manipulation of external loads  
Adapt the shape of the structure to wind load
- Manipulation of the response of the structure  
Adapt material and element properties (stiffness, length, damping)
- Combination

► Fig. 2: Manipulation of loads in adaptive structures

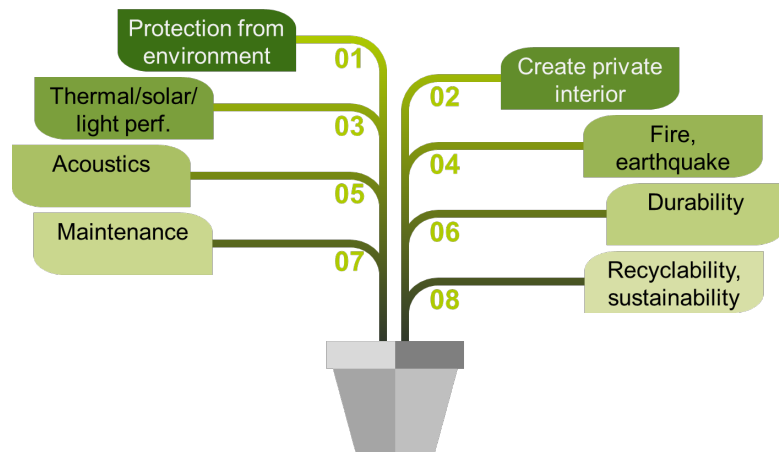

► Fig. 5: Requirements for a design of a facade



# 18 Structural Characterisation and Performance Assessment

## Design loads in structural adaptive facades

Chiara Bedon, Martina Eliášová, Dániel Honfí, Marcin Kozłowski, Klara V. Machalická, Miroslav Vokáč, Filipe Santos, Mislav Stepinac, Thomas Wüest

Current standards require building envelopes to behave as energy efficient mechanical systems, able to react to non-continuous, changing external conditions. The only conclusion from the definition is that façades need to change or adapt. It must be dynamic, developed with smart materials and need to optimize buildings' systems relative to climate, energy balance and human comfort.

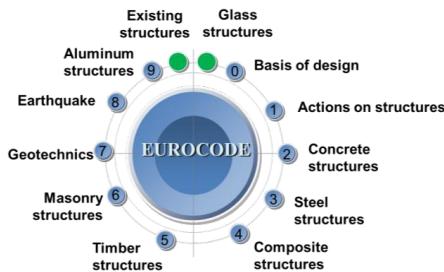

► Fig. 6: Current standards "EUROCODE"

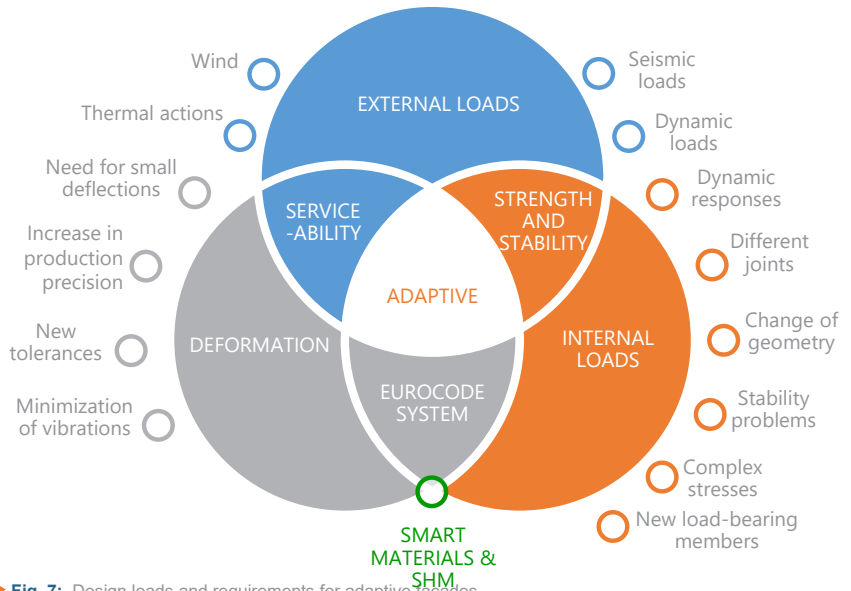

► Fig. 7: Design loads and requirements for adaptive facades

### Actions on the structure

self-weight, wind, snow, explosion, earthquake, thermal actions, **dynamic behavior due to moving**

**Static model, Implementation of dynamic loads**

**ULS – stress levels, buckling, ?**

**SLS – deformations, displacements, vibration, ?**

**Optimization if SLS is not fulfilled**

**Optimization of the structural response regarding energy consumption**

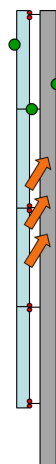

### Resistance of glass elements

**ULS and SLS of substructure**

**Connection system**

**Additional loads due to movable structure**

**ULS and SLS of substructure**

**Connection system (resistance, durability, fatigue...)**

**Robustness**

**Standards?**

**Experimental testing + numerical modelling**

**"What if" scenarios**

► Fig. 8: Differences between actions and requirements for adaptive facades

# 18 Structural Characterisation and Performance Assessment

## Classification of structural adaptive facades: A new proposal

Chiara Bedon, Martina Eliášová, Dániel Honfí, Marcin Kozłowski, Klara V. Machalická, Miroslav Vokáč, Filipe Santos, Mislav Stepinac, Thomas Wüest

### General classification

Based on Wada et al. (1990), also Morales-Beltran & Teuffel (2013) proposed a general framework for categorizing adaptive structures (Figure 1). In the framework, kinetic structures are equipped with actuators capable of changing geometry or other structural characteristics. Sensory structures are equipped with a monitoring system to detect external/internal changes. In adaptive structures - based on the sensors input - a control system determines the actuators behavior. Smart and intelligent systems are considered as subgroups of adaptive structures.

### Classification proposed by Velasco et al.

More specific classification on adaptive facades systems was proposed by Velasco et al. (2015).

Accordingly, two aspects of the response are considered, namely movement and control (Figure 2).

### Classification proposed by TG members

New classification rules were then suggested by the 'Structural' TG members in Bedon et al. (2018) and Bedon et al. (2018a). According to the TG classification, as shown in Figure 2, a key role is assigned to three different aspects/level, namely represented by system changes, activation type and loading conditions. Their features and effects (including possible combinations) should be properly taken into account at the design stage, since these are responsible for multi-phase configuration changes (even cyclic) during the whole life-time of a given facade. The first main aspect of

classification relates to possible 'system changes' regarding geometry and stiffness (i.e., being explicitly related to the adopted facade details, and hence responsible of different types of deformations under the assigned design loads). The second main aspect then refers to the 'activation system', where the classification could be carried out by distinguishing facade systems with prevalent self-change materials (i.e. thermo-sensitive materials like shape memory alloys, thermo-bimetals, etc.), rather than mechanical actuators or inflatable systems. The latter solution can include soft pneumatic actuators or consist of full pneumatic chambers and air cushions.

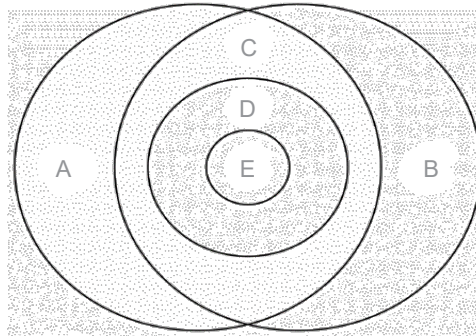

► Fig. 1: Framework for the classification of adaptive structures, in accordance with (Morales-Beltran & Teuffel, 2013)

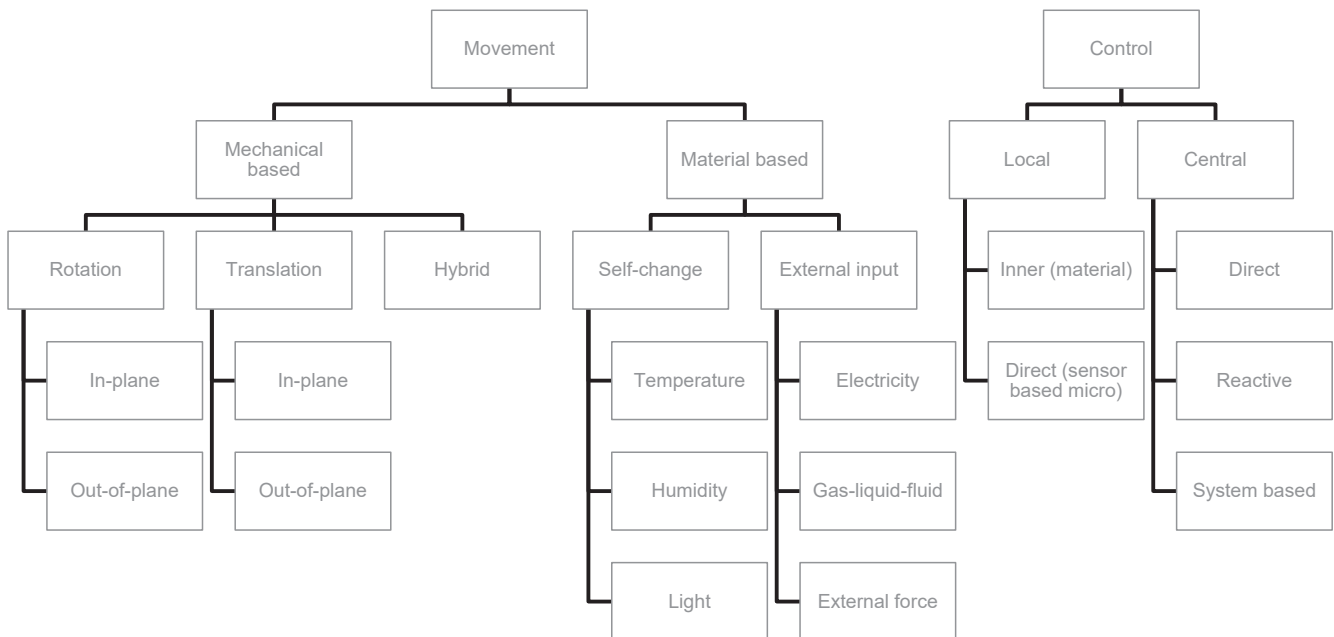

► Fig. 2: Classification system of adaptive facades, as proposed (Velasco et al., 2015)



# 18 Structural Characterisation and Performance Assessment

## Classification of structural adaptive facades: A new proposal

Chiara Bedon, Martina Eliášová, Dániel Honfí, Marcin Kozłowski, Klara V. Machalická, Miroslav Vokáč, Filipe Santos, Mislav Stepinac, Thomas Wüest

In both cases, inflatable facades should be separately investigated, since these are typically characterized - with respect to the other types of envelopes - by pressurized units composed of novel/unconventional materials whose performance should be properly assessed, in which both mechanical and thermal loads apply (i.e., load sharing phenomena in the air cavities, etc.).

The third aspect focuses then on the 'triggering events', where possible loading scenarios of interest for the full life-time of the structure should be properly evaluated, including ordinary thermo-mechanical actions and possible extreme events (even natural or accidental).

### References

- Wada, B.K., J.I. Fanson and E.F. Crawley, 1990. Adaptive structures. *Mech. Eng.*, 112: 41-46, DOI: 10.1177/1045389X9000100202
- Morales-Beltran, M. and P. Teuffel, 2013. Towards smart building structures: adaptive structures in earthquake and wind loading control response-a review. *Intell. Build. Int.*, 5: 83-100, DOI: 10.1080/17508975.2013.778193
- Velasco, R., A.P. Brakke and D. Chavarro, 2015. Dynamic Façades and Computation: Towards an Inclusive Categorization of High Performance Kinetic Façade Systems. Proceedings of the 16th International Conference, Computer-Aided Architectural Design Futures, Jul. 8-10, São Paulo, Brazil, pp: 172-191, DOI: 10.1007/978-3-662-47386-3\_10
- Bedon, C., D. Honfí, M. Kozłowski, K. Vokáč, Machalická, F. Santos, T. Wüest, M. Eliášová, M. Vokáč, 2018. Key Structural Aspects for Adaptive Facades - Activity Progress from the EU-COST Action TU1403 'Structural' Task Group. *International Journal of Structural Glass and Advanced Materials Research*, DOI: pending (published online)
- C. Bedon, D. Honfí, M. Kozłowski, M. Eliášová, K. Vokáč, Machalická, M. Vokáč, F. Santos, T. Wüest, 2018. An insight on possible classification and metrics, experimental testing and numerical modelling for adaptive facades - Activity report from the 'Structural' Task Group. Proceedings of the FAÇADE 2018 Final conference of COST TU1403 "Adaptive Facades Network" (accepted, published online)

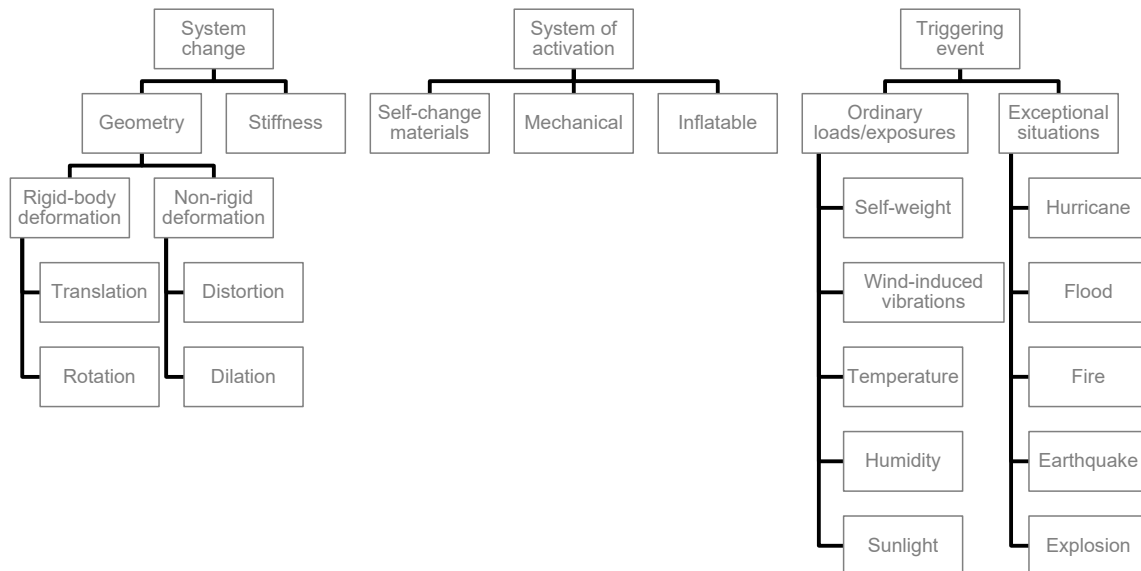

► Fig. 3: Classification system of adaptive facades ('Structural' TG proposal)

# 18 Structural Characterisation and Performance Assessment

## Experimental testing for the structural characterisation

Chiara Bedon, Martina Eliášová, Dániel Honfí, Marcin Kozłowski, Klara V. Machalická, Miroslav Vokáč, Filipe Santos, Mislav Stepinac, Thomas Wüest

### Introduction

Experimental testing of facades offers valuable insights to a façade's performance under extreme conditions. Furthermore, some experimental testing are required for several purposes, in example EN 13830 testing for CE-marking, CWCT recommendations for safety issues and many more. The common feature of all these test procedures is, that they are designed for traditional, static façade systems. The performance accordance of adaptive façade systems, which react to different boundary conditions and change their features, might not be covered by these standard procedures. Therefore, the structural Task Group decided to tackle the problem and preserve possible approaches for successful experimental testing of adaptive facades.

### Standard test procedures

All products within the European Economic Area (EEA) has to be in conformity with relevant EU standards to allow free movement and sale of these products. For facades, EN13830 'Curtain walling - Product standard' is the most relevant for facade testing, which is product standard for CE marking in EEA. Another relevant document is ETAG 034 'Guideline for European Technical Approval of Kits for External Wall Claddings' issued by European Organization for Technical

Approvals (EOTA).

The EN 13830 specifies technical characteristics and requirements on curtain walls, and defines different experimental test procedures for facade performance classification. The main test procedure includes air permeability, water-tightness, wind load serviceability, air permeability II, water-tightness II and wind load resistance. This procedure has to be performed in one run for the classification. The EN13830 test facility at Lucerne University of Applied Science and Arts is shown in Fig. 1.

The ETAG 034 defines both requirements and corresponding test methods in fields of mechanical resistance and stability, safety in case of fire, hygiene, health and environment, safety in use, protection against noise, energy economy and heat retention, aspects of durability and serviceability. From the point of view of the structure reliability, the ETAG 034 defines a number of mechanical tests of cladding. There is also prescribed a method of evaluating test results in order to obtain characteristic value for structural design, i.e., breaking force. This method is in accordance with EN 1990 where principles for design based on experiments are given, too. These principles shall be met even in the case of adaptive facades. Typical test arrangement of facade cladding fixing according to the ETAG 034 is shown in Fig. 2a.

The ETAG 002 'Structural Sealant Glazing Systems' provides test methods for adhesive

bonding glazing in order to redistribute loads to the facade structure via a structural sealant and a structural sealant support frame, see Fig. 2b where tensile load (i.e., wind suction) is applied on adhesively bonded joint of facade structure.

### Challenges for adaptive facades

The above-mentioned standards and procedures were developed for traditional static facades. On the other hand, the development of standard testing procedures for an adaptive, moveable, dynamic, kinetic, responsive, switchable, interactive, etc. façade is neither feasible nor promising. Therefore, the applicability of standard testing and the considerable boundary condition has to be examined case-by-case. In addition, negative interaction of adaptive behaviour and performance criteria must be considered. In the case of adaptive facades, these are unique structural systems whose testing may require procedures that are not listed in current standards. Non-standard connection test of the façade glass panel is shown in Fig. 3. There are probably various options to customize test facilities to the adaptive behaviour. Therefore, a careful preparation and a lot of 'what if'-thinking is the key factor for satisfactory adaptive facade tests.



▶ Fig. 1: EN 13830 test facility at Lucerne University of Applied Science and Arts, Horw Switzerland

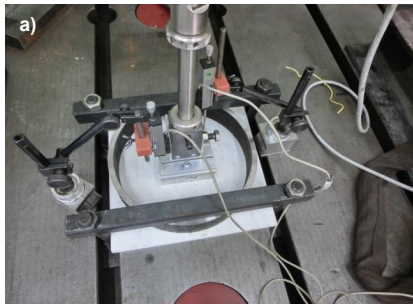

▶ Fig. 2: Experimental test of facade fixing according to ETAG 034 and ETAG 002 performed at Klokner Institute, CTU in Prague



▶ Fig. 3: Non-standard connection tests of the façade glass panel performed at Klokner Institute, CTU in Prague

# 18 Structural Characterisation and Performance Assessment

## Experimental testing for the structural characterisation

Chiara Bedon, Martina Eliášová, Dániel Honfí, Marcin Kozłowski, Klara V. Machalická, Miroslav Vokáč, Filipe Santos, Mislav Stepinac, Thomas Wüest

### Interaction scenarios

Fig. 4 shows some possible influences for adaptive facade testing according to EN 13830, which are further explained in the following paragraphs.

For example, if a facade changes the form due to wind load or other reasons, it is possible that joints could offer lower air permeability or water-tightness.

In contrast, structural additivity is proposed to enlarge wind load resistance, what will also affect the load deflection behavior and, therefore, air permeability or water-tightness. In addition, the serviceability criteria, usually deflection limits, have to be fulfilled in one or both structural cases.

From the structural point of view, attention should also be paid to the durability, dynamic response and fatigue of individual facade structural elements.

Adaptivity on material level can be reached in various ways, such as colour change or light

transmission properties, which are not necessarily relevant for test procedures. Others, for example form change or changes in flexibility certainly lead to influences of main test criteria's.

### References

- EN 13830: 2003. Curtain walling - Product standard. CEN - European Committee for Standardization, Brussels, Belgium
- ETAG 034: 2012. Guideline for European Technical Approval of Kits for External Wall Claddings. EOTA - European Organisation for Technical Assessment, Brussels, Belgium
- EN 1990 - Eurocode - Basis of structural design. CEN - European Committee for Standardization, Brussels, Belgium
- ETAG 002: 1999. Guideline for European Technical Approval for structural sealant glazing systems (SSGS). EOTA - European Organisation for Technical Assessment, Brussels, Belgium

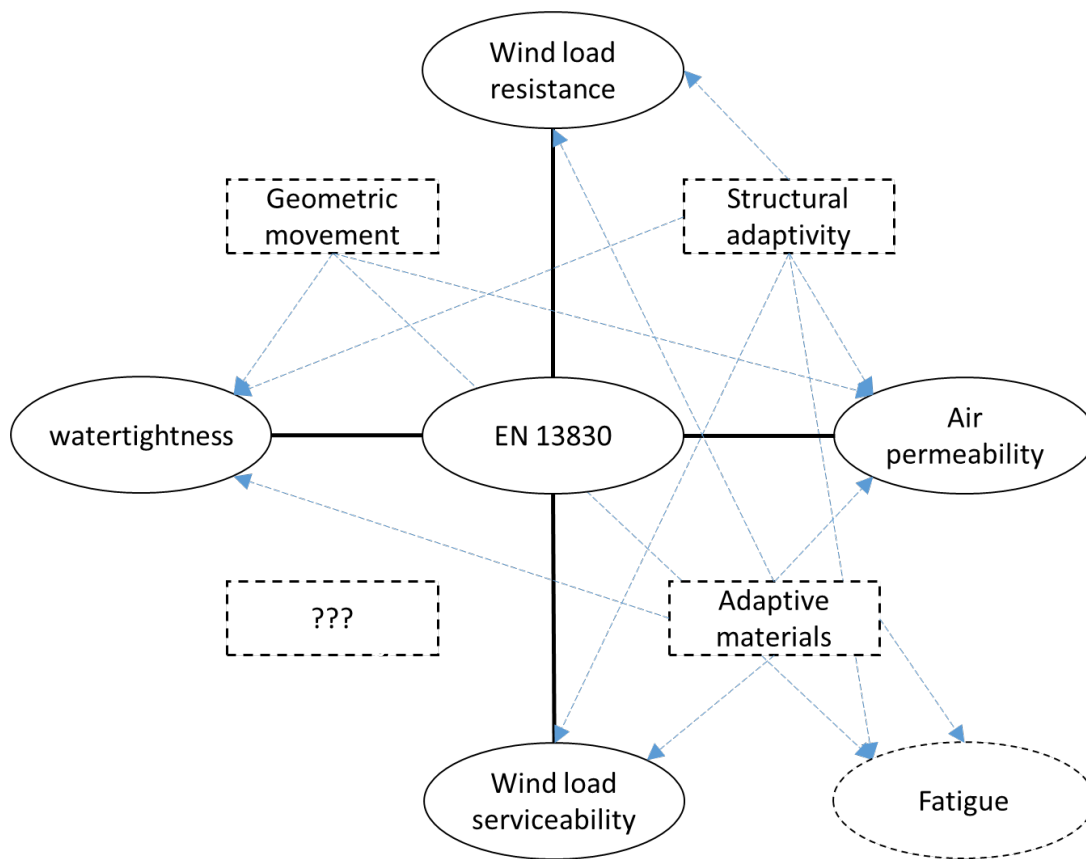

► Fig. 4: Influence diagram for EN13830 testing of adaptive facades

# 18 Structural Characterisation and Performance Assessment

## Finite Element numerical modelling: Issues & potentials

Chiara Bedon, Martina Eliášová, Dániel Honfí, Marcin Kozłowski, Klara V. Machalická, Miroslav Vokáč, Filipe Santos, Mislav Stepinac, Thomas Wüest

### Introduction

Numerical modelling has an important role in designing and developing adaptive facade systems. From a structural perspective, Finite Element (FE) simulations can be extremely beneficial by providing a robust and reliable tool for both supporting and sometimes even replacing testing of components, sub-systems or entire systems. Since full scale testing can be both time consuming and costly, advanced modelling can realize significant savings and enable project completion on time. As far as the reliability of FE estimations is strictly related to input parameters and modelling assumptions, the complexity of the structural system to analyze is strictly related to the increasing number of critical aspects to properly assess at the FE modelling stage. So far, several researchers focused on the FE analysis of traditional curtain wall facades or cable-supported facade systems, under ordinary as well as exceptional loads.

### Finite element numerical models for structural adaptive facades

The complexity of the numerical simulations is much higher when considering adaptive facade systems, where a multitude of aspects should be properly taken into account. Generally speaking, such a complexity and uncertainty can originate from several key aspects, including material properties as well as kinematics for these complex assemblies (see for example an adaptive glass panel with SMA wires in Fig.1). Actually, most of the numerical studies related to adaptive systems are in fact focused on energy and thermal efficiency considerations, while the current lack of modelling recommendations and guidelines often represents the major obstacle for the reliable structural assessment of adaptive systems via FE tools.

### Some preliminary recommendations

The FE analysis of an adaptive facade differs significantly from a traditional one, since the analysis should properly define some key aspects which are representative for various input parameters. On the other hand, several other questions should be considered, including:

- material properties. The most appropriate constitutive law (i.e., linear elastic, damage model, degradation of mechanical properties under cyclic loads and/or time / temperature variations, etc.) should be preliminarily selected, depending on the expected adaptive behaviour. In this regard, an attempt towards a possible FE modelling standardization for glass facades and windows under explosions can be found in (Larcher et al., 2016)

- mechanical interaction between the facade components. Connections and joints should be properly reproduced (even in a simplified / ideal way), so to allow a reliable description of the actual structural response of each facade component, as well as the reciprocal mechanical interaction between components (as parts of the full adaptive assembly object of analysis)
- loading condition. Even in presence of ordinary design loads only, adaptive facades are first

associated to cyclic and / or kinematic behaviors. In this regard, the FE model should be able to actually reproduce (at the component and / or assembly level) such a kind of performance (i.e., including possible fatigue effects and degradation of input properties)

- boundaries. Being generally described via ideal restraints, special care in FE modelling of adaptive facades should be spent for restraints and supports. In most of the cases, such structural details can in fact be responsible of possible premature failure mechanisms (i.e., due to local peaks of stresses, etc.).

### References

- Santos, F., Bedon, C., & Sacadura, M. (2016). Adaptive glass panels using shape-memory alloys. *Glass Structures & Engineering*, 1(1): 95-114, doi: 10.1007/s40940-016-0016-3
- Larcher, M., Arrigoni, M., Bedon, C., et al. (2016). Design of blast-loaded glazing windows and facades: a review of essential requirements towards standardization. *Advances in Civil Engineering*, article ID 2604232, <https://www.hindawi.com/journals/ace/2016/2604232/>

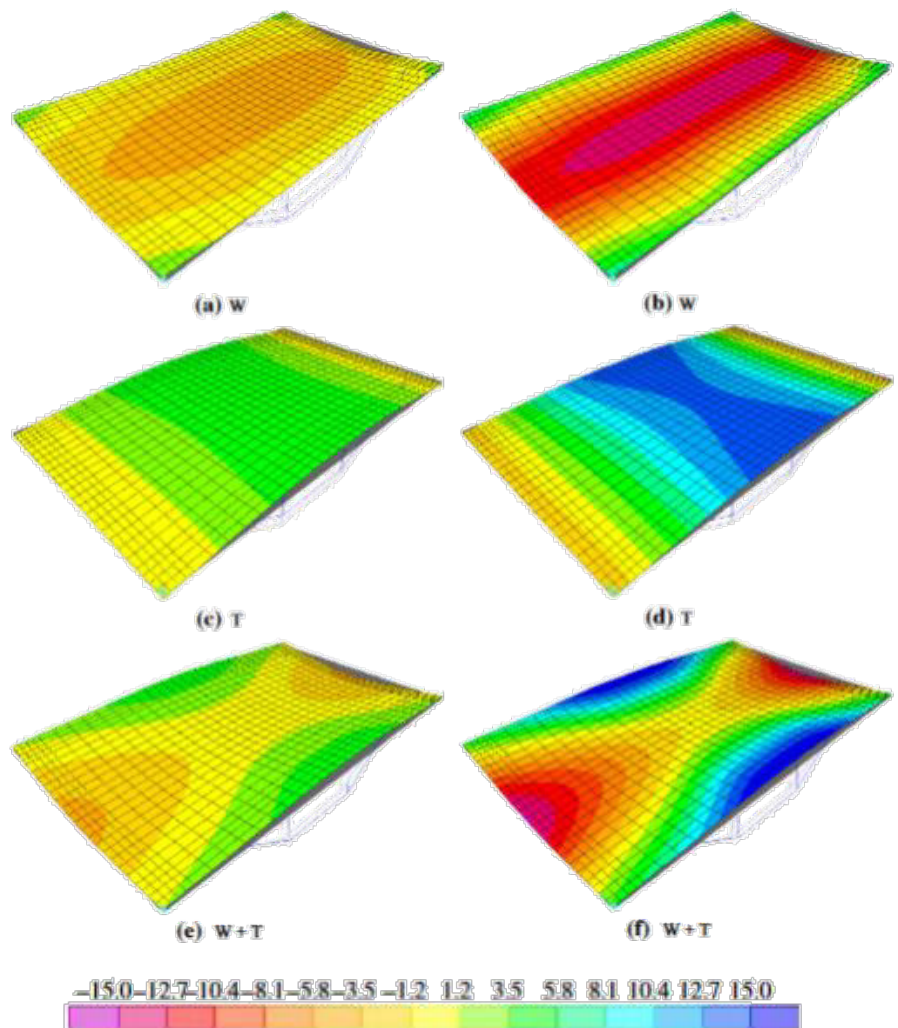

► **Fig. 1:** Adaptive glass panel, according to (Santos et al., 2016). Maximum displacements of the glass panel (legend values in mm) under a mean wind pressure, axonometry (SAP2000).  
(a) Wind (W), monolithic;  
(b) Wind (W), layered;  
(c) Control (T), monolithic;  
(d) Control (T), layered;  
(e) Total (W+T), monolithic;  
(f) Total (W+T), layered.



# 18 Structural Characterisation and Performance Assessment

## Metrics & Key Performance Indicators

Chiara Bedon, Martina Eliášová, Dániel Honfí, Marcin Kozłowski, Klara V. Machalická, Miroslav Vokáč, Filipe Santos, Mislav Stepinac, Thomas Wüest

### Summary of design concepts, standards and guidelines

Building envelopes are commonly required to resist self-weight, environmental actions (i.e. thermal effects and wind load), natural (i.e. earthquake) and man-made (i.e. impact and explosion) hazards. Moreover, structural design of adaptive facades has to resolve structural consequences due to adaptive / movable systems, together with structural and cost consequences for the supporting substructures. Wind loading, for example, is an highly dynamic phenomenon and therefore a very interesting driver for adaptive architecture. Actuators of adaptive facades can also significantly affect dead loads to account for design: mechanically driven kinematic systems will lead to heavy complex construction components, while lightweight shape morphing elements are possible to construct with smart materials (Lignarolo et al. 2011).

For building envelopes and components, structural criteria are specified at different levels: general harmonised conditions for construction products in Europe (EU 2011), national building standards (EN 1990) and recommendations from facade organisations. The most general regulatory framework for the performance of all the building products in Europe is represented by the Construction Products Regulation (EU 2011). It specifies basic requirements for construction works, namely related to mechanical resistance and stability, safety in case of fire, hygiene, health and environment, safety and accessibility in use, protection against noise, energy economy and heat retention, sustainable use of natural resources. The EN 1990 document defines then the conventional requirements for safety, serviceability and durability of structures, including regulations for the design, verification and reliability of structural systems. While inclusive of reference design loads for structures, however, the EN 1990 does not account for specific aspects of facades and envelopes, and moreover should be used in conjunction with specific standards related to fire design, accidental situations (i.e., earthquakes) and execution. The Centre for Window and Cladding Technology (CWCT) is an example of industry funded centre providing more specific performance criteria for facades. It publishes both standards and guidelines developed together by leading architects, consultants, contractors and manufacturers.

### Structural performance metrics for facades

In building engineering, 'metrics' are conventionally assumed to represent - for facades and envelopes - specific performance parameters that are strictly related to the thermal comfort, energy performance and lightning response of a given cladding system, with respect to the whole building it belongs to. In the last years, the increasingly development of adaptive systems attracted the attention of several research studies. Compared to 'static' performance metrics for thermal and lightning

assessment of facades (i.e., U-value, g-value, daylight factor, etc.), a series of 'dynamic performance metrics' have been proposed in the literature (see for example (Reinhart et al. 2006; Wagdy et al. 2016; Goia et al. 2013; etc.)), so as to properly capture and optimise the expected behaviours, towards enhanced sustainability and comfort levels.

Structurally speaking, the overall performance of a traditional facade is conventionally optimised - under the assigned ordinary design loads (i.e. self-weight, wind, crowd, etc.) - so as to accomplish specific deflection values in service conditions ( $M1$ ), that should be implicitly accounted for appropriate resistance performances of the load-bearing components. The same deflection limits, at the same time, are generally recommended by design standards so as to provide reasonable comfort for the building occupants (i.e. limitation of perceived movements and minimisation of potential failure risk). Another key structural performance parameter to account in the design is then represented by the weight ( $M2$ ) of the structural (and non-structural) components.

A series of additional (and more specific) performance metrics can then be defined and accounted for the optimal design of a given facade typology, especially adaptive facades. Horn (2015), for example, focused on the design of truss facade structures and emphasised how 'structural performance metrics' can be merged and related to 'buildability metrics', so as to enhance their cost and efficiency. In doing so, Horn proposed six additional metrics, namely related to ( $Mi$ ) a standardised length for the facade members, ( $Mii$ ) trucking requirements, ( $Miii$ ) number of structural connections to build on-site, ( $Miv-Mv$ ) structural joints geometry and connectivity, ( $Mvi$ ) variations in the cross-sectional features of the load-bearing components.

### Special considerations for adaptive facades

Actually, the lack of specific regulations and guidelines to standardise the load-bearing mechanisms and performance of adaptive facades represents one of the major issues for their optimal design. Differing from traditional static facades (namely consisting in regular structural schemes), the variability in possible kinematic effects, materials (and related properties), morphology (including free-form facade systems), on the other hand, does not allow and facilitate the possible grouping of adaptive facade systems by boundary conditions.

Given the intrinsic features of adaptive facade systems, however, both the  $M1$  and  $M2$  metrics previously recalled can be reasonably accounted as reliable performance parameters. The  $M2$  minimisation, in particular, is herein recommended especially in presence of kinematic mechanisms involving rotations and torsional effects, that could induce fatigue phenomena. The trouble arises indeed in terms

of deflection limit values ( $M1$ ), since static facades are required to satisfy specific deformations that are strictly related to their loading and boundary condition (i.e. curtain walls, cable-supported facades, etc.). In this context, lateral deflection limits in adaptive systems should be generally related to the involved shape change and joint detailing, being responsible of local and global stress peaks that can be hardly controlled via standardised reference values. For preliminary estimations, the limit of 1/100 the bending span could be taken into account for adaptive facades. Even if experimental testing and / or numerical modelling can provide further support and feedback to design, in addition, lateral deflections should be related to stress peaks in the structural components, so to ensure (depending on the used materials) minimum stress-to-resistance ratios in operational conditions, and sufficiently wide safety levels.

Given the intrinsic features of adaptive systems, ( $M3$ ) vibrations are then recommended as potential metrics for optimal structural performances. According to the EN 1991-1-4:2005 provisions, for example, glazing facades and roofs with natural frequency lower than 5Hz (condition that typically occurs for glazed spans smaller than 3m) should be properly verified against vibration effects, even due to ordinary wind pressures. A specific calculation method is provided for these systems in the Annex F - Dynamic characteristics of structures.

Special care, finally, should be spent for ( $M4$ ) fatigue phenomena. In this case, however, specific probabilistic studies are required, for each facade typology, being fatigue effects strictly related to boundaries, loads and materials. In addition, no standardised design methods for fatigue assessments are available for (even static) facades, being explicitly calibrated in the literature - in most of the cases - for bridges under vehicle loading. Nakagami (2003), in this regard, proposed a new method to account for the loading cycle of wind pressures in traditional glazing envelopes. The research investigations highlighted that such a probabilistic method can be very effective when the resonance component for a given facade system is relevant, compared to the assigned load wind spectrum. Extended analyses should be however carried out, for adaptive facade systems.





40 Bond Street HdeM / Herzog de Meuron (image: M. Brzezicki)

# 18 Structural Characterisation and Performance Assessment

## Metrics & Key Performance Indicators

Chiara Bedon, Martina Eliášová, Dániel Honfí, Marcin Kozłowski, Klara V. Machalická, Miroslav Vokáč, Filipe Santos, Mislav Stepinac, Thomas Wüest

### References

- LEM Lignarolo, CMJL Lelieveld, P Teuffel (2011). Shape morphing wind-responsive facade system realized with smart materials. Proceedings of Adaptive Architecture: An International Conference (London, UK, March 3-5, 2011), 12 pages, <https://repository.tudelft.nl/islandora/object/uuid:be165d55-9acb-4f1a-9cc1-5685d33676f1?collection=research>
- European Parliament (2011). Regulation (EU) No. 305/2011 of the European parliament and of the council of 9 March 2011 laying down harmonised conditions for the marketing of construction products and repealing Council Directive 89/106/EEC. Official J. European Union, 88: 5-43
- EN 1990 - Eurocode - Basis of structural design. CEN - European Committee for Standardization, Brussels, Belgium
- A Horn (2015). Integrating constructability into conceptual structural design and optimization. Master Thesis, Massachusetts Institute of Technology (MIT), Cambridge (MA), USA. Available online (accessed August 2018): <http://hdl.handle.net/1721.1/99598>
- CF Reinhart, J Mardaljevic, Z Rogers (2006). Dynamic daylight performance metrics for sustainable buildings. The Journal of the Illuminating Engineering Society, 3(1): 7-31, doi: 10.1582/LEUKOS.2006.03.01.001
- A Wagdy, F Fathy, S Altomonte (2016). Evaluating the daylighting performance of dynamic facades by using new annual climate-based metrics. Proceedings of PLEA 2016 Los Angeles - Cities, Buildings, People: Towards Regenerative Environments, 32th International Conference on Passive and Low Energy Architecture, 11-13 July
- F Goia, L Bianco, V Serra, M Perino (2013). Energy performance assessment of advanced integrated facades by means of synthetic metrics. Proceedings of the 8th International Symposium on Heating, Ventilation and Air Conditioning. Lecture Notes in Electrical Engineering, vol. 263. Springer, Berlin, Heidelberg, doi:10.1007/978-3-642-39578-9\_3
- EN 1991-1-4:2005 - Eurocode 1: Actions on structures - Part 1-4: General actions - Wind actions. CEN - European Committee for Standardization, Brussels, Belgium
- Y Nakagam (2003). Probabilistic dynamics of wind excitation on glass facade. Ph.D. Thesis, Technische Universität, Darmstadt, Germany. Available online (accessed August 2018): <http://tuprints.ulb.tu-darmstadt.de/343/>

### Acknowledgment

This section summarises the final result of a joint collaboration between the members of the WG2 - COST Action TU1403 - "Structural" Task and further international experts.



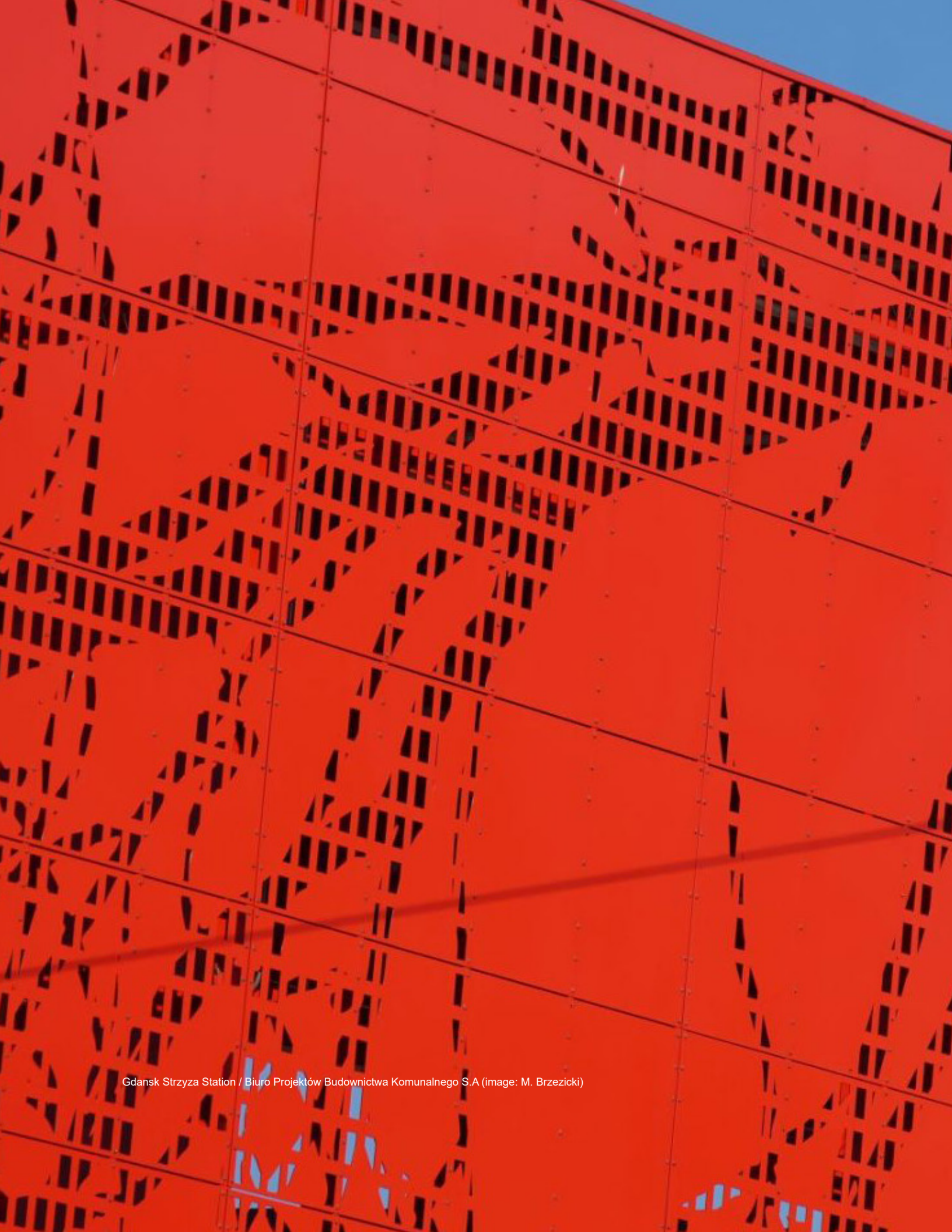

Gdansk Strzyza Station / Biuro Projektów Budownictwa Komunalnego S.A (image: M. Brzezicki)



# Biographies





### **Francesco Babich**

Francesco works as Senior Researcher at Eurac Research within the Energy Efficient Group (Renewable Energy Institute), and his R&D activity focuses on thermal comfort and indoor environmental quality, and facade systems. He successfully defended his PhD at Loughborough University (within LoLo CDT) in December 2017. His field of interest is numerical modelling, including CFD, human thermal physiology, and dynamic thermal modelling, and experimental research. His work at Eurac is linked to both research and commercial R&D projects. Francesco also received awards and recognitions such as the “Best paper award” at BSA2017 conference and as postgraduate student of the year at The Built Environment Awards 2018. His list of publications is available on Google Scholar (<https://goo.gl/YPcV1x>). He is currently also reviewer for a number of scientific journals such as Building and Environment, Science and Technology for the Built Environment, Journal of Façade Design and Engineering, and Indoor and Built Environment.



### **Chiara Bedon**

Dr. Chiara Bedon is Assistant Professor at University of Trieste, Department of Engineering and Architecture, Italy, where she chairs the course of “Structural Analysis”. Early Career Investigator (PhD degree in 2012), since 2009 she is involved in European projects and networks (JRC-ERNICIP, NATO-SPS, COST, etc.) including the “Structural” sub-group of COST Action TU1403. She achieved (April 2017) the Italian National scientific qualification for the position of Associate Professor in Structural Engineering. Her research activities are focused on structural glass; design/ analysis of structures under exceptional loads, including explosions and fire; use of innovative structural materials; optimization problems; advanced Finite Element numerical modelling. With more than 180 peer-reviewed scientific publications, she collaborated with more than 70 international co-authors. Dr. Bedon joins several Editorial board committees for ISI international journals. Editor-in-Chief for the open access International Journal of Structural Glass and Advanced Materials Research.

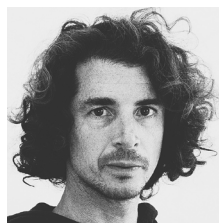

### **Maxime Doya**

Maxime Doya obtained a PhD at University of La Rochelle which analyses the impact of façade radiative properties for building energy efficiency in a dense urban environment. He has participated in national and European projects on strategies that can mitigate the urban heat island (ACCLIMAT, REPUBLIC-MED, MAIN, DESCARTES, VEGDUD) where he developed aggregation models for optical properties and performed sensitivity studies of urban microclimate models. He is author or co-author of 10 articles in international journals or conferences. Since 2012, he is project manager at the Típee platform, he participates in the development of experimental protocols on laboratory at material scale and on real-climate test-facility at roof and facade components scale. His work includes also using of inverse numerical identification methods and performing numerical simulations at city scale or building scale, including numerical methods to coupling thermal and mass transfers.



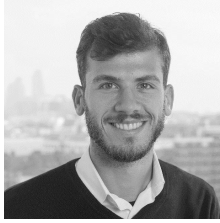

### **Fabio Favoino**

Dr. Fabio Favoino is Assistant Professor of Building Physics at Politecnico di Torino, within the Technology Energy Building Environment research group at the Department of Energy. His research and teaching activity focuses on the evaluation of the building performance of building envelopes, and particularly of high performance and adaptive facades, by means of both numerical and experimental methods and tools. Fabio's professional activity has been articulating between academia and building industry: after his university studies (2005-2010) at Politecnico di Torino (BSc and MSc), Milano (double degree MSc) and TU Delft (LLP Erasmus during MSc), he collaborated with different engineering and architectural firm in Italy and internationally as façade and building performance consultant (2011-2016). In 2016 he achieved his PhD degree in Façade Engineering at University of Cambridge (2013-2016), and after that he worked as a Senior Façade Consultant at Eckersley O'Callaghan in London (2016-2018) designing high performance building envelopes for offices, educational, retails, exhibition and residential buildings. He is a co-author of the Cost Action TU1403 – Adaptive Façade Network and Task Leader for the Building Performance Simulation task group in the WG2.



### **Francesco Goia**

Francesco Goia is Associate Professor of Building Physics at the Department of Architecture and Technology of the Norwegian University of Science and Technology, NTNU Trondheim. With a background in architecture and construction engineering, and material science, he holds a Ph.D. in Energetics from the Polytechnic University of Turin and a co-joint Ph.D. in Architecture from the Norwegian University of Science and Technology. Francesco is a passionate for technology and innovation and works to promote a more sustainable built environment. Presently, his main research activity concerns the ideation and assessment of strategies, technologies and systems for energy efficient buildings, with a focus on the dynamic building envelope components and integration of technologies and systems for renewable energy source harvesting. He is and has been involved in experimental, laboratory and numerical activities aimed at developing new technologies for responsive buildings, for solar energy and daylighting exploitation and for building energy management.



### **Roel C.G.M. Loonen**

Roel Loonen is Assistant Professor at the Unit Building Physics and Services, Eindhoven University of Technology, the Netherlands. His research and teaching focus on the development and application of modeling and simulation strategies to provide decision support for designing buildings that combine high indoor quality with low or no impact on the environment. Roel collaborates with SMEs in various R&D projects, aspiring to accelerate the process of bringing innovative building envelope technologies and renewable energy systems to the market. Many of his projects have dealt with the advancement of adaptive facades, both from a theoretical and a more practice-oriented perspective. Roel is (co-)author of 14 ISI journal publications, 2 book chapters, and more than 30 peer-reviewed papers in the proceedings of international conferences.



Museum of Art, Architecture and Technology | MAAT / Amanda Levete (image: M. Brzezicki)

# Acknowledgements

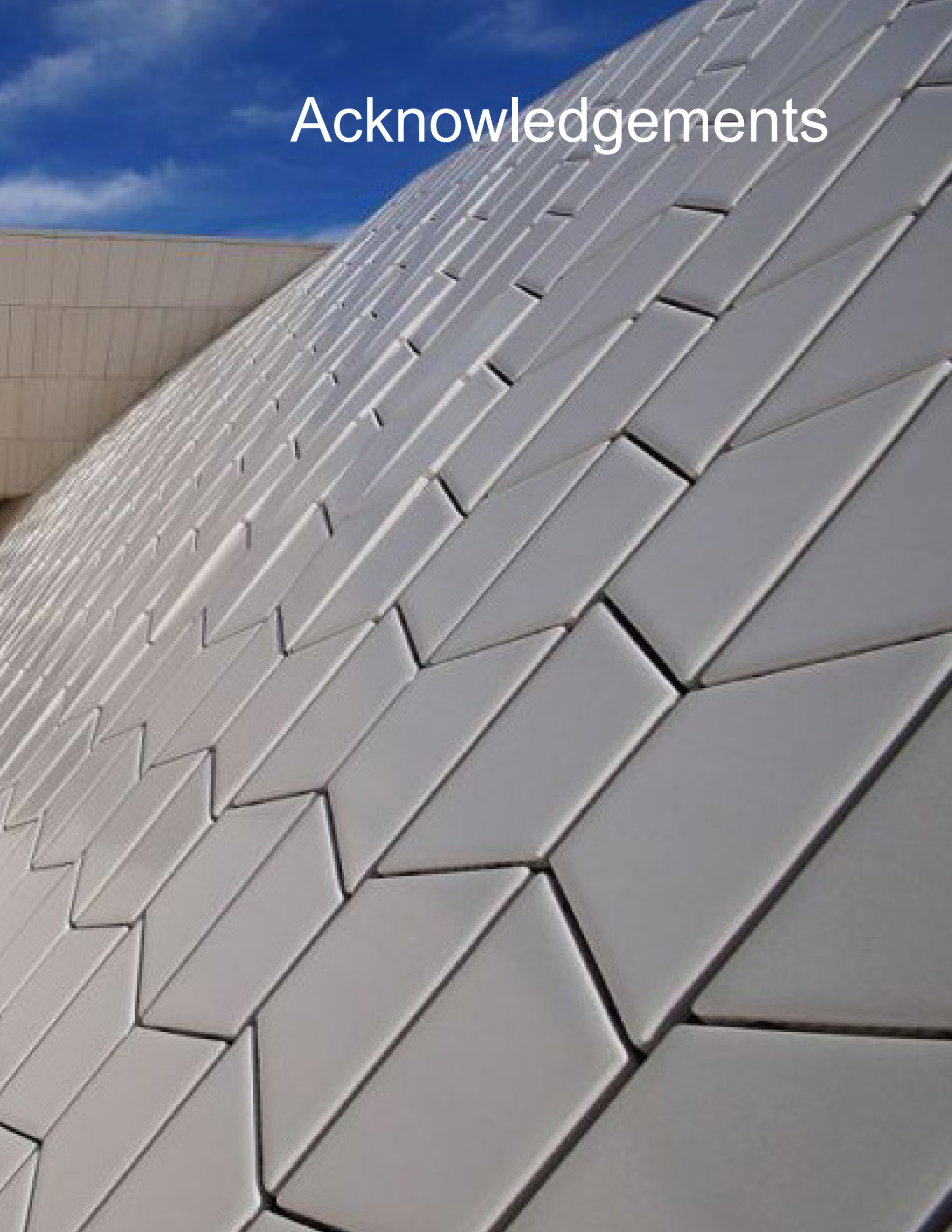

# Acknowledgements

The editors of the book would like to express their gratitude to the authors of the contributions presented in this volume, which are listed below. All the editors and authors are thankful to the EU for the support provided through the COST-Action, which established a network among researchers and practitioners in the field of adaptive facades, providing a unique opportunity for networking, rationalising and spreading expertise and knowledge, which will extend beyond the boundaries of this project.

Moreover, the editors and authors are grateful to the private companies who supported the activities of the WG2, in particular to Eckersley O'Callaghan Ltd., Chapman Taylors Ltd., InnoRenew CoE and EURAC Research. The Cost-Action TU1403 also benefitted from the activities carried out during the H2020 research project "ExcEED – European Energy Efficient building & district Database: from data to information to knowledge" (grant agreement n. 723858, Partners: Eurac Research, Wattics, BPIE,3E,Hoval) and the project FACEcamp (European Regional Development Fund and Interreg ITAUT programme, project n. ITAT1039, partners: Eurac Research, IDM Suedtirol - Alto Adige, Universität Innsbruck, HELLA Sonnen- und Wetterschutztechnik GmbH, Bartenbach GmbH, Glassadvisor Srl, Frener & Reifer Srl).

The editors and authors would like to express a special thanks and appreciation to Ashal Tyurkay, for her valuable and fundamental work in the editing and formatting of this book.

## Building Performance Simulation of Adaptive Facades

### Chapter 1: Current status, requirements and opportunities for building performance simulation of adaptive facades

Roel Loonen and Jan Hensen,  
Building Physics and Services, Eindhoven University of Technology, the Netherlands

Fabio Favoino  
Technology Energy Building Environment research group, Department of Energy, Politecnico di Torino, Italy  
(Former: Eckersley O'Callaghan Ltd., London, United Kingdom)

Mauro Overend  
Glass and Façade Technology research group, Department of Engineering, University of Cambridge, UK

### Chapter 2: Model requirements, approaches and validation for simulation of adaptive façade systems and technologies

Fabio Favoino  
Technology Energy Building Environment research group, Department of Energy, Politecnico di Torino, Italy  
(Former: Eckersley O'Callaghan Ltd., London, United Kingdom)

Roel Loonen  
Building Physics and Services, Eindhoven University of Technology, the Netherlands

### Chapter 3: Computational performance prediction of switchable windows

Fabio Favoino  
Technology Energy Building Environment research group, Department of Energy, Politecnico di Torino, Italy  
(Former: Eckersley O'Callaghan Ltd., London, United Kingdom)

Roel Loonen  
Building Physics and Services, Eindhoven University of Technology, the Netherlands

### Chapter 4: Computational performance prediction of dynamic complex fenestration systems with BSDF

Giuseppe De Michele and Andrea Gasparella  
Free University of Bolzano/Bozen, Faculty of Science and Technology, Italy

Roel Loonen and Hemshikha Saini  
Eindhoven University of Technology, Department of the Built Environment, the Netherlands

Stefano Avesani  
Institute for Renewable Energy – Eurac Research, Energy Efficient Buildings group, Italy

Fabio Favoino  
Technology Energy Building Environment research group, Department of Energy, Politecnico di Torino, Italy  
(Former: Eckersley O'Callaghan Ltd., London, United Kingdom)

Luca Papaiz  
glassAdvisor, Italy



**Chapter 5:** Computational performance prediction of radiative glass

Giuseppe La Ferla

Universidad Politécnica de Madrid, Departamento de Construcción y Tecnología Arquitectónicas, Madrid, Spain

**Chapter 6:** Computational performance prediction of adaptive insulation

Fabio Favoino

Technology Energy Building Environment research group, Department of Energy, Politecnico di Torino, Italy  
(Former: Eckersley O'Callaghan Ltd., London, United Kingdom)

**Chapter 7:** Computational performance prediction of Opaque Phase Change Materials

Albert Castell, M. Medrano and S. Vall

Department of Computer Science and Industrial Engineering, University of Lleida, Spain

**Chapter 8:** Computational performance prediction of Phase Change Materials in transparent components

Francesco Goia

Department of Architecture and Technology, Faculty of Architecture and Design, Norwegian University of Science and Technology (NTNU), Trondheim, Norway

**Chapter 9:** Computational performance prediction of Transparent Ventilated Façade

Olena Kalyanova Larsen and Mingzhe Liu

Department of Civil Engineering, Aalborg University, Aalborg, Denmark

**Chapter 10:** Computational performance prediction of Opaque ventilated façade

Emanuela Giancola

Department of Energy, Energy Efficiency in Buildings Research Unit, CIEMAT, 28040 Madrid, Spain

**Chapter 11:** Computational performance prediction of Ventilative cooling

Annamaria Belleri

Institute for Renewable Energy, Eurac Research, Bolzano, Italy

**Chapter 12:** Computational performance prediction of Green roofs and green facades

Valentina Serra and Alice Gorrino

Technology Energy Building Environment research group, Department of Energy, Politecnico di Torino, Italy

**Chapter 13:** Computational performance prediction of Solar thermal adaptive facades

Stefano Avesani, Giuseppe De Michele, Francesco Babich

Institute for Renewable Energy, Eurac Research, Bolzano, Italy

**Chapter 14:** Description of models for long-term adaptiveness and performance degradation

Anna Sandak and Jakub Sandak

CNR-IVALSA Trees and Timber Institute, via Biasi 75, 38010 San Michele all'Adige (TN), Italy

InnoRenew CoE, Livade 6, SI-6310 Izola, Slovenia

University of Primorska, Faculty of Mathematics, Natural Sciences and Information Technology, Glagoljaška 8, 6000 Koper, Slovenia

## Performance Characterisation of Adaptive Facades

### Chapter 15: Mapping of Test facilities to evaluate key performances of Adaptive Façade Components

Maxime Doya  
Tipee S.A.S & University of La Rochelle, La Rochelle, France

Francesco Goia  
Department of Architecture and Technology, Faculty of Architecture and Design, Norwegian University of Science and Technology (NTNU), Trondheim, Norway

### Chapter 16: Description of experimental facilities, characteristics and methods

#### **The Cube** – Absolute and relative guarded test cell

Olena Kalyanova Larsen and Per Heiselberg  
Department of Civil Engineering, Aalborg University, Aalborg, Denmark

#### **ESTP outdoor test cell** – Absolute guarded test cell

Andrea Kindinis  
Ecole Spéciale des Travaux Publics, du Bâtiment et de l'Industrie (ESTP Paris), Paris, France

#### **TWINS (Testing Window INnovative Systems)** – Façade full scale outdoor comparative test facility

Fabio Favoino, Marco Perino, and Valentina Serra  
Technology Energy Building Environment research group, Department of Energy, Politecnico di Torino, Italy

#### **ZEB Test Cells Laboratory** – Absolute guarded test cell

Francesco Goia and Alessandro Nocente  
Department of Architecture and Technology, Faculty of Architecture and Design, Norwegian University of Science and Technology (NTNU), Trondheim, Norway

Steinar Grynning  
SINTEF Building and Infrastructure, Trondheim, Norway

#### **Tipee Façade Test** – Absolute and relative guarded test cell

Maxime Doya,  
Tipee S.A.S

Jérôme Le Dréau, and Manon Rendu  
University of La Rochelle, La Rochelle, France

#### **LECE Building Component Energy Test Laboratory** – Relative test-cells fully exposed to outdoor

Emanuela Giancola  
Energy Efficiency in Buildings Unit, CIEMAT, Madrid, Spain

#### **PIV (Particle Image Velocimetry)** – Indoor measurement equipment

Emanuela Giancola  
Energy Efficiency in Buildings Unit, CIEMAT, Madrid, Spain

**PSE ARFRISOL Energy Research Demonstrator Office Building Prototypes** – In-situ real-scale buildings

Emanuela Giancola  
Energy Efficiency in Buildings Unit, CIEMAT, Madrid, Spain

**GESLAB, Global Energy and Sustainable Laboratory in Building** – Relative test-cells fully exposed to outdoor

Giuseppe La Ferla  
Departamento de Construcción y Tecnología Arquitectónicas, ETSAM, Universidad Politécnica de Madrid, Madrid, Spain

**Facade System Interaction Lab**– Relative guarded test-cells

Francesco Babich , Stefano Avesani and Roberto Lollini  
Institute for Renewable Energy, Eurac Research, Bolzano, Italy

**TRIUMF Laboratory** – Two Room Indoor Environment & Energy Universal Façade

Rasmus L. Jensen  
Department of Civil Engineering, Aalborg University, Aalborg, Denmark

**LABIMED Test Cell** – Paslink test cell

Marco. Sala, Paola Gallo, Alessandra Donato, and Rosa Romano  
ABITA research Centre, University of Florence, Italy

**Building Future Lab** – Indoor Laboratory - Calibrated Hot-Box

Martino Milardi and Corrado Trombetta  
BFL – Building Future Lab, dArTe department, Mediterranea University of Reggio Calabria, Reggio Calabria, Italy

**Building Envelope and Solar Technologies Laboratory** – Absolute and relative guarded test cell

Mathilde Colmet Daâge and Matthieu Baranzini  
EDF Lab Les Renardières, Moret-Loing-et-Orvanne, France

**Large Scale Vertical Building Envelope Climate Simulator** – Climate simulator (indoor test cell)

Francesco Goia and Alessandro Nocente  
Department of Architecture and Technology, Faculty of Architecture and Design, Norwegian University of Science and Technology (NTNU), Trondheim, Norway

Steinar Grynning  
SINTEF Building and Infrastructure, Trondheim, Norway

**Dual Air Vented Thermal Box (DAVTB) facility** – Laboratory hot box

Andrea Alongi, Adriana Angelotti, and Livio Mazzarella  
Department of Energy, Politecnico di Milano, Italy

**MATELab** – Façade test cell to study occupant response

Alessandra Luna-Navarro and Mauro Overend  
Glass and Façade Technology research group, Department of Engineering, University of Cambridge, UK

**Passivhaus in Mascalucia (Sicily) - Zero Energy Building Living Lab** – Outdoor real-scale facility

Lorenzo Pagliano, Francesco Causone, Marco Pietrobon, and Anita Tatti  
eERG Group - Department of Energy, Politecnico di Milano, Italy

**BPS Test Façade** – Real-scale test Rooms with Reconfigurable Façade

Jan Diepens, Roel Loonen, and Alex Rosemann  
Building Physics and Services, Eindhoven University of Technology, the Netherlands

**HCU Studio for Room Comfort** – Real-scale test Room with Reconfigurable Façade

Frank Wellershoff, Matthias Friedrich, Klaus Schweers  
Façade Systems and Building Envelops Unit, HafenCity University, Hamburg, Germany

**Multifunctional Façade Lab** – Guarded Hot-Box, Solar simulator for Active Facades (indoor lab)

Giordano Miori, Roberto Lollini, Francesco Babich, Stefano Avesani  
EURAC Research, Institute for Renewable Energy, NOI Techparch, Italy

## **KPI and structural aspects of Adaptive Facades**

### **Chapter 17: Key Performance Indicators (KPIs) Online Tool**

Francesco Babich, Stefano Avesani, Wilmer Pasut, Daniele Antonucci and Roberto Lollini  
Institute for Renewable Energy, Eurac Research, Bolzano, Italy

### **Chapter 18: Structural characterisation and performance assessment of adaptive facades**

Chiara Bedon  
Department of Engineering and Architecture, University of Trieste, Trieste, Italy

Martina Eliášová  
Faculty of Civil Engineering, Czech Technical University in Prague, Prague, Czech Republic

Dániel Honfi  
RISE – Research Institutes of Sweden, Gothenburg, Sweden

Marcin Kozłowski  
Faculty of Civil Engineering, Silesian University of Technology, Gliwice, Poland

Klara V. Machalická, Miroslav Vokáč  
Klokner Institute, Czech Technical University in Prague, Prague, Czech Republic

Filipe Santos  
CERIS, ICIST e Departamento de Engenharia Civil da Faculdade de Ciências e Tecnologia, Universidade NOVA de Lisboa, Caparica, Portugal

Mislav Stepinac  
Faculty of Civil Engineering, University of Zagreb, Zagreb, Croatia

Thomas Wüest  
Institute of Civil Engineering, Lucerne University of Applied Sciences and Arts, Lucerne, Switzerland