

The use of finite-element software to solve hygrothermal building physical problems related to insulating high rise buildings facades

Citation for published version (APA):

Schellen, H. L., Schijndel, van, A. W. M., & Neuhaus, E. (2008). The use of finite-element software to solve hygrothermal building physical problems related to insulating high rise buildings facades. In J. Hensen (Ed.), *IBPSA-NVL 2008 Event* (pp. 1-9). International Building Performance Simulation Association (IBPSA).

Document status and date:

Published: 01/01/2008

Document Version:

Publisher's PDF, also known as Version of Record (includes final page, issue and volume numbers)

Please check the document version of this publication:

- A submitted manuscript is the version of the article upon submission and before peer-review. There can be important differences between the submitted version and the official published version of record. People interested in the research are advised to contact the author for the final version of the publication, or visit the DOI to the publisher's website.
- The final author version and the galley proof are versions of the publication after peer review.
- The final published version features the final layout of the paper including the volume, issue and page numbers.

[Link to publication](#)

General rights

Copyright and moral rights for the publications made accessible in the public portal are retained by the authors and/or other copyright owners and it is a condition of accessing publications that users recognise and abide by the legal requirements associated with these rights.

- Users may download and print one copy of any publication from the public portal for the purpose of private study or research.
- You may not further distribute the material or use it for any profit-making activity or commercial gain
- You may freely distribute the URL identifying the publication in the public portal.

If the publication is distributed under the terms of Article 25fa of the Dutch Copyright Act, indicated by the "Taverne" license above, please follow below link for the End User Agreement:

www.tue.nl/taverne

Take down policy

If you believe that this document breaches copyright please contact us at:

openaccess@tue.nl

providing details and we will investigate your claim.

1 **THE USE OF FINITE-ELEMENT SOFTWARE TO SOLVE HYGROTHERMAL**
2 **BUILDING PHYSICAL PROBLEMS RELATED TO INSULATING HIGH RISE**
3 **BUILDING FACADES**

4
5 Henk Schellen¹, Jos van Schijndel¹, and Edgar Neuhaus²
6 ¹Eindhoven University of Technology, The Netherlands
7 ²Physitec, The Netherlands
8
9
10

ABSTRACT

In The Netherlands high rise buildings from 1960 and before were hardly insulated. To improve the thermal performance of the buildings the facades may be insulated afterwards. The energy loss will be reduced and thermal comfort will be improved by higher indoor surface temperatures.

Problems however may be introduced by thermal bridge effects of anchors, floors and indoor walls. Furthermore the outer facade surface will be colder during winter time. Frost damage and internal condensation may be the deleterious building physical effects. The purpose of the work is to prevent damages which may result from insulating retrofitting of building facades.

For this kind of building physical problems specific software has been developed and is in use all over the world. The coupling of heat, air and moisture (HAM) transport, however, has not been solved most of the times. An attempt has been made to solve this kind of coupled problems by the use of COMSOL (Comsol 2006).

As an example of this kind of coupled problems the thermal bridge effect of an anchor in an uninsulated and afterwards insulated facade of a high rise building has been examined. The air flow calculation in the cavity was coupled to the thermal and hygric diffusion process. The results of the separately uncoupled COMSOL simulations (like thermal bridge calculations) were compared with results from third party software and the coupled simulation results were compared with infrared thermographs.

The conclusion of the paper is that the use of COMSOL in this kind of problems may solve the problem of coupled building physical effects in building constructions.

INTRODUCTION

The building case introduced here is an office building in Eindhoven, The Netherlands (Pernot et al. 2007). The building is a high rise building, counting 10 floors and dating from the 1960's (figure 1). The construction of the building consists of concrete floors and breastwork of concrete and masonry (figure 2).

The outer facade is finished with natural stone slabs with a thickness of 40 mm. An air gap of about 60 mm is in between. The reduction of energy consumption related to this building is of great importance. Therefore the thermal resistance of the facade should be improved. The higher indoor surface temperatures will also improve thermal comfort and decrease the mould and condensation risk. To retrofit the construction by insulation, a choice has to be made for the type of insulating material and the position in relation to the facade materials. For the type of insulation material a choice can be made out of a number of materials: mineral wool, expanded or extruded polystyrene, polyurethane. For a decision on the location of the insulation material it can be situated at the inside or in the gap in between the facade slab and the concrete or masonry breastwork.



FIG. 1: Building façade

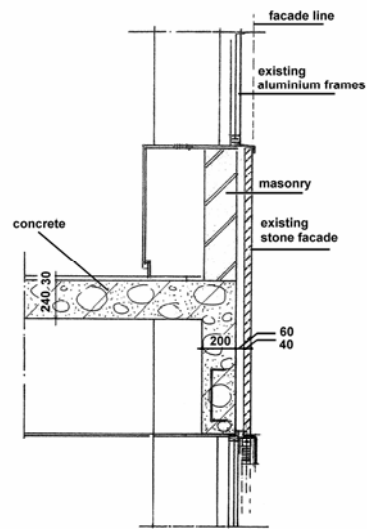

FIG. 2: Vertical section of the façade (dimensions in mm)

A building physical analysis should be made of the thermal and hygric effects of these choices. Until now third party software has been developed to calculate energy losses, thermal bridge effects and moisture effects of this kind of constructions. The coupling however of the thermal, hygric and air flow effects in this type of constructions has not been solved in this software. In this article an attempt has been made to solve this type of coupled problems by the use of COMSOL. parts of the paper

METHOD

The method of research was the following: First, an impression of the thermal performance of the facade construction was made by infrared thermal imaging. Second, modeling of the 2D thermal bridge effect of the original and afterwards insulated facade construction was compared, using third party software and COMSOL. Third, moisture effects were introduced using a coupled 2D heat and moisture transport model in COMSOL. Finally the effect of air flow in the construction was modeled with COMSOL.

MEASUREMENTS

To get an impression of the thermal quality and thermal performance of the building infrared thermal images of the exterior and interior of the facade have been made during a relatively cold winter period. In these thermal images a relatively large heat loss at the outside surface is visible as an increase in surface temperature. From the inside the larger heat loss is seen in a reduction of the surface temperature, leading to a reduced thermal comfort experience, an increased risk of mould growth and sometimes even condensation.

FIG. 3: Infrared thermal image of the façade (scale -6 to 6 °C)

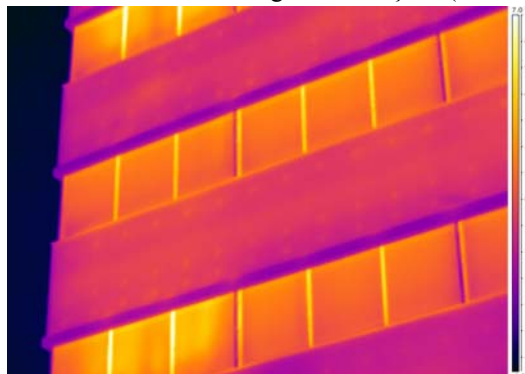

The infrared thermo graphic measurements took place during a cold winter period on February 7th 2007 in the morning. The sky was clouded and the air temperature was about 1 °C. Conclusions from the infrared images are the following: The facade is hardly thermal insulated. A well insulated facade would appear with a temperature in the order of the outdoor temperature. The thermal quality of the facade is in the order of its simple double glazing. The U-value of the aluminum frame is larger (i.e. worse) than the U-value of the double glazing.

CALCULATIONS

Thermal bridge calculations

To evaluate the retrofitting effects of insulating a construction afterwards it is quite usual to use so-called thermal bridge calculations. Since the 1980's specific software has been developed to calculate the 2- and 3D thermal bridge effects in building constructions. The computer program BISCO (Physibel 2002) e.g. is a well known computer code to calculate the 2D effects of a thermal bridge. Its calculations are based on 2D stationary heat conduction, mathematically described by the Laplace equation:

$$\nabla(-\lambda \nabla \theta) = 0 \quad (1)$$

θ = Temperature [°C]
 λ = Thermal conductivity [W/m.K]

The BISCO and COMSOL software have been used to calculate the thermal bridge effect when insulating the cavity between the facade slab and the construction behind, or insulating the construction from the inside. The material properties, as they were used in the calculations, are taken from literature and are summarized in table 1.

TABLE 1: Thermal and hygric properties of building materials

Material	Thermal conductivity λ [W/(m·K)]	Density ρ [kg/m ³]	Diffusion resistance μ [-]
Brick	0.6	1900	10
Natural stone	2.3	2440	140
PUR	0.035	33	50
Concrete	1.6	2300	180
Mineral wool	0.040	60	1.3
XPS	0.034	30	100

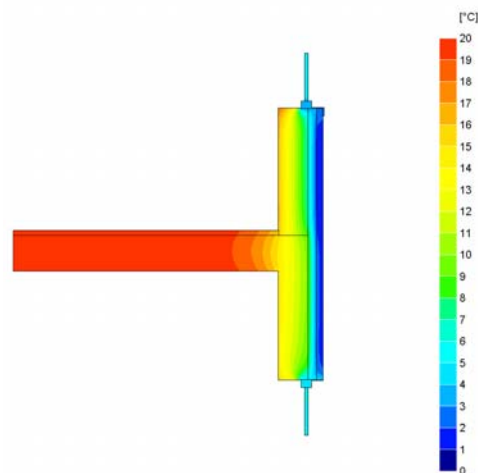

FIG. 4: Thermal bridge calculations in BISCO of the insulated construction

From the results it is clear that the interior construction will become warmer after insulating the cavity. The outer natural stone slab, however, will decrease in temperature. The results from the BISCO and COMSOL calculations were nearly identical within a range of less than 0.1 % difference.

Temperature factor

To reduce the risk on surface condensation and mould growth Dutch standards demand a calculation of the so called temperature factor. This factor is a dimensionless number, representing the lowest temperature of the thermal bridge. It is defined by

$$f = \frac{\theta_{si, \min} - \theta_e}{\theta_i - \theta_e} \quad (2)$$

Indices:

si,min: interior surface, minimum; i: interior; e: exterior

For office buildings in The Netherlands an f-factor is required of at least 0.50.

The table below gives the results of the calculated inside surface temperatures and the resulting temperature factor as they were calculated using BISCO (or COMSOL).

TABLE 2: Temperature factor at the connection upper surface floor-facade

Insulation variant	$\theta_{si, \min}$	f	Ok?
1. Original non insulated facade	12	0.60	yes
2. PUR insulation in cavity	18	0.90	yes
3. XPS at the inside surface	13	0.65	yes
4. XPS as 3 with additional material	16	0.80	yes

Linear U-value

Due to thermal bridge effects there is an increased heat loss through the building construction, compared with the 1-dimensional heat loss without thermal bridges. The extra heat loss can be defined by a linear U-value Ψ . The linear U-value is the extra heat loss for a 2D thermal bridge with a length of 1 meter exposed to a temperature difference across the construction of 1 K.

Making use of the heat loss as it was calculated by BISCO (or COMSOL) the linear U-value can be calculated from:

$$\psi = \frac{\phi}{\theta_i - \theta_e} - U_1 l_1 - U_2 l_2 \quad (3)$$

ψ	=	Extra heat loss compared to 1D heat loss per mK	[W/mK]
ϕ	=	Total heat loss through construction per m	[W/m]
$U_{1,2,..,n}$	=	1D overall heat transfer coefficient of construction	[W/m ² K]
$l_{1,2,..,n}$	=	Length of constructions	[m]

The table below summarizes the linear U-values as they were calculated using BISCO (or COMSOL).

TABLE 3: Linear U-values

Insulation variant	Linear U-value [W/m·K]
1. Original non insulated facade	0.56
2. Insulation in gap	0.15
3. XPS with additional material	0.57

Conclusions from thermal bridge calculations

Conclusion from the thermal bridge calculations is that the thermal bridge effect is minimal for variant 2 with gap insulation. The results from the thermal bridge calculations show that insulating the gap between external slab and interior building construction results in higher interior surface temperatures. Thermal comfort therefore will be improved and the risks on mould growth will be reduced. The slab temperatures however will be lower. Furthermore, due to the insulation material in the gap the ventilation will be reduced and the slab material will

get wetter. Together with lower slab temperature effects the deterioration risk by freezing of the slab will increase. That is why a combination of thermal and hygric effects should be included in the calculations.

Hygrothermal calculations

For the calculation of the coupled thermal and hygric transport throughout a facade section the Fraunhofer Institute in Germany e.g. developed a computer code WUFI (Künzel 2006). The drying effects in the ventilated gap, however, were not included in older versions of this kind of model. That is why COMSOL was used to calculate the coupled thermal, hygric and air flow effects.

The COMSOL model is based on the following equations for steady state conditions:

Thermal transport by conduction and convection:

$$\nabla \cdot (-\lambda \nabla \theta) = -\rho c_p \vec{u} \nabla \theta \quad (4)$$

ρ	=	Density	[kg/m ³]
c_p	=	Constant pressure specific heat	[J/kg.K]
\vec{u}	=	Air velocity	[m/s]

Vapour transport by diffusion and convection:

$$\nabla \cdot \left(-\frac{\delta}{\mu} \nabla c \right) = -\frac{\vec{u}}{RT} \nabla c \quad (5)$$

c	=	Vapour concentration	[kg/m ³]
δ	=	Water vapour permeability	[s]
μ	=	Vapour diffusion resistance number	[-]
R	=	Specific gas constant for water vapor	[J/kg.K]
	=	462	J/kgK

Incompressible air flow:

$$\rho \vec{u} \nabla \vec{u} = \nabla \cdot [-pI + \eta(\nabla \vec{u} + (\nabla \vec{u})^T)] \quad (6)$$

$$\nabla \cdot \vec{u} = 0 \quad (7)$$

I	=	Identity matrix	[-]
p	=	Pressure	[Pa]
η	=	Dynamic viscosity air	[Pa.s]
	=	1.7E-5	Pa.s

The stationary boundary conditions were:

Thermal:

$$q = h_o \cdot (\theta_o - \theta_s) \quad (8)$$

q	=	Heat flux at surface	[W/m ²]
h	=	Heat transfer coefficient	[W/m ² .K]
h_i	=	7.7	W/m ² .K
θ_i	=	20	°C
h_e	=	25	W/m ² .K
T_e	=	0	°C

Hygric:

$$g = \frac{\beta_o}{\rho} \cdot (c_o - c_s) \quad (9)$$

g	=	Vapor flux at surface	[kg/m ² s]
β	=	Vapor transfer coefficient	[kg/m ² s]
β_i	=	7.1E-3	kg/m ² s
c_i	=	0.5*csat(θ_i)=0.0088	kg/m ³
β_e	=	22.9E-3	kg/m ² s
c_e	=	csat(θ_e)=0.0035	kg/m ³
$csat$	=	Saturation concentration	[kg/m ³]

Air flow:

- u_o = inlet velocity [m/s]
- u_o = 0 (no ventilation)
- u_o = 0.1 (no insulation in gap, assumed on basis of earlier cavity measurements)
- u_o = 0.01 (mineral wool in gap, assumed)

Indices:

- o,i,e : environmental
- s : surface

Variant study

The coupled thermal and hygric calculations were evaluated for a number of 4 relative simple variants. Until now, the calculations are stationary and wind-driven rain, solar radiation and long-wave radiation are not included in the model.

Variants: 1: the original non insulated façade; 2: mineral wool in gap; 3: Polyurethane (PUR) in gap; 4: inside surface insulation with extruded polystyrene (XPS);

Results

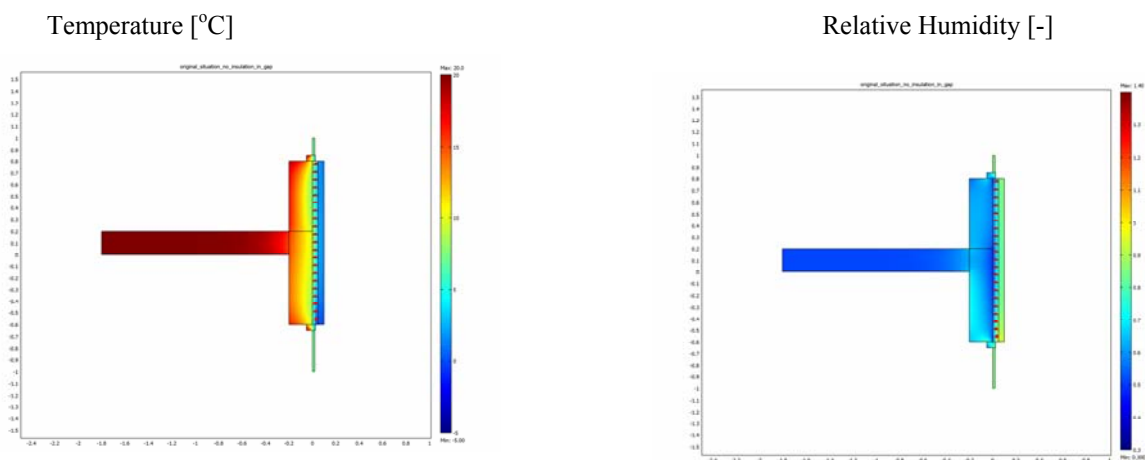

FIG. 5: variant 1, the original non insulated facade

Variant 1: The non insulated construction shows indoor construction surface temperatures which are rather low ($\theta_{min} < 16$). Due to the vapor flux from indoor to outdoor condensation will occur in the gap at the cold outdoor slab. Drying of this slab will take place by ventilation of the cavity ($RH < 0.95$).

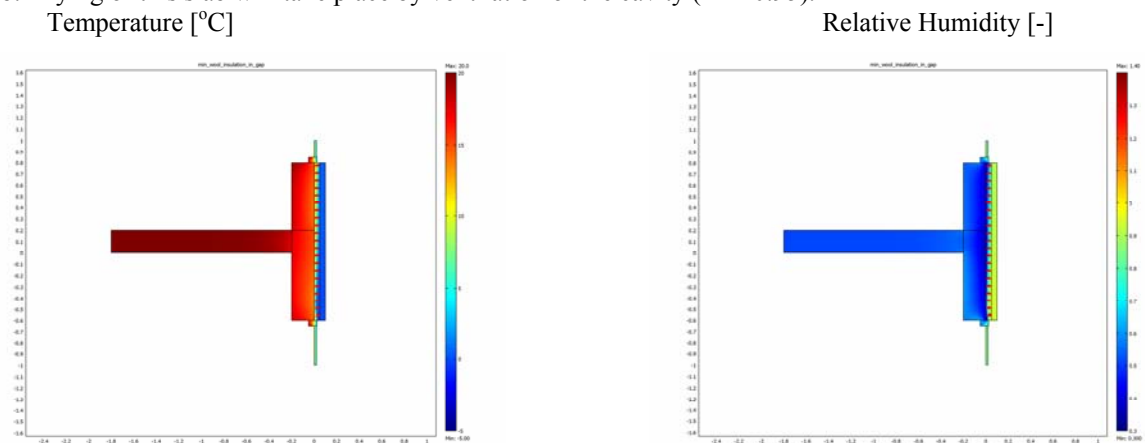

FIG. 6: variant 2, mineral wool in gap

Variant 2: Due to the insulation material in the gap the construction surface temperatures at the inside will remain rather high ($\theta_{min} > 18$). The outside slab however will get colder and higher relative humidities will occur at the slab surface in the gap. The density of the mineral wool is low and some air flow by ventilation will still remain ($RH < 0.95$).

Variant 3: Polyurethane in the cavity will give construction temperatures which are likewise as variant 2 ($\theta_{\min} > 18$). The ventilation of the gap, however, is not possible anymore. The intrinsic vapor resistance is much larger than in the mineral wool case. The result will be a rather high vapor resistance and low relative humidity at the cross section of the concrete breastwork ($RH < 0.6$).

Temperature [°C]

Relative Humidity [-]

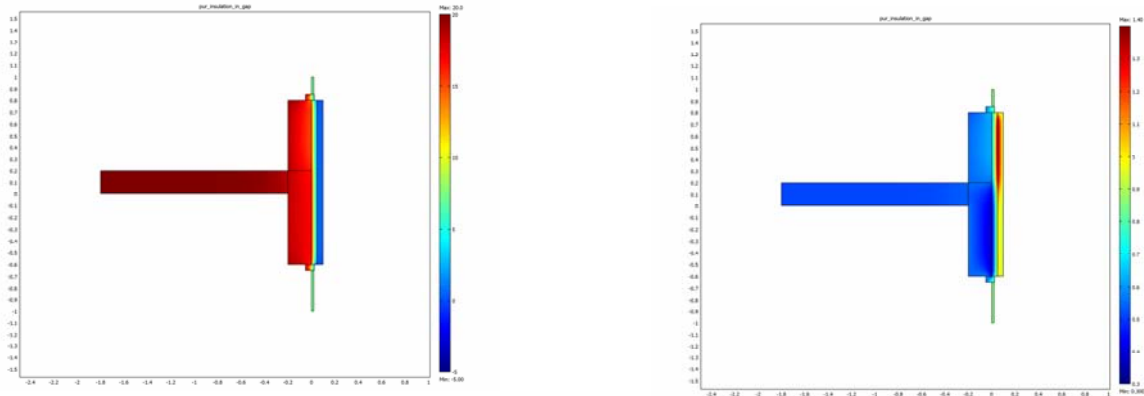

FIG. 7: variant 3, polyurethane in the cavity

Variant 4: Insulation at the inside surface with a rather vapor resistant material like extruded polystyrene will lead to rather low construction temperatures behind the insulation material ($\theta < 10$). The vapor flow into the material, however, will be low. The natural ventilation of the cavity will remain intact and the relative humidity in the gap will remain low ($RH < 0.9$). The ventilation with cold air will cool down the construction at the inlet. This is the reason for an increasing relative humidity at the inner construction part ($RH > 0.9$).

Temperature [°C]

Relative Humidity [-]

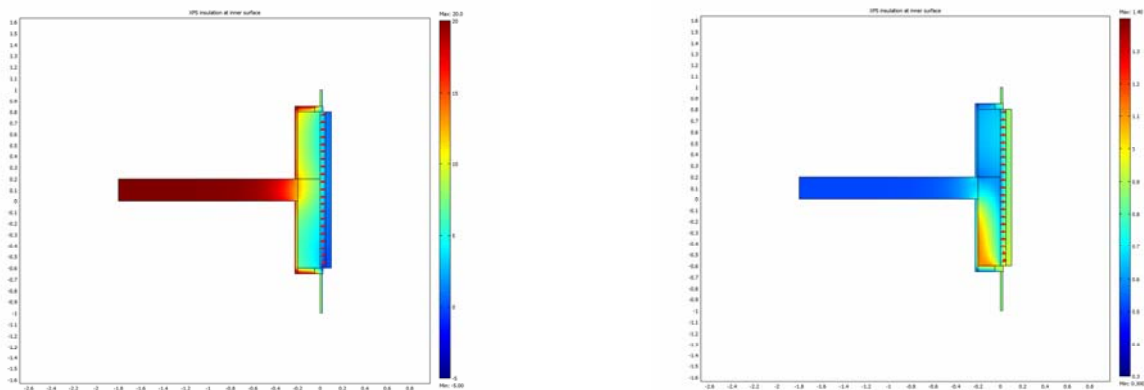

FIG. 8: variant 4, inside surface insulation with XPS

CONCLUSION

Cavity insulation, either fully-filled or partially-filled, belongs to a special class of envelope design. It has its advantages and disadvantages, some of the latter may lead to severe adverse consequences to the performance and durability of the envelope (Straube et al. 1997). Hygrothermal numerical modelling has been done to optimize retrofitting options (Djebbar 2002). Thermal and hygric simulations in this paper show that the occurrence of condensing moisture at the slab surface in the gap depends on the choice of insulation material and the place it is installed. The drying of the natural stone exterior cladding construction depends on the ventilation of the gap. Therefore it is important to make use of coupled thermal, hygric and air flow calculations in the simulation study. Most of the known building physical simulation tools do not include this coupling. Therefore the use of general finite-element software like COMSOL for these situations may be important in future. Validation of the results on the moisture aspects and a time dependant transient analysis, however, is important for future work.

ACKNOWLEDGEMENTS

The authors like to thank the municipality of Eindhoven, The Netherlands, for their involvement and support.

REFERENCES

- Physibel (2002), BISCO, computer program to calculate two-dimensional steady state heat transfer in free-form shaped objects using the energy balance technique, BISCO 6.0W manual
- Künzel H.M., Schmidt T. & Holm A. (2006), WUFI Pro 4.1: Programm zur instationären berechnung des ein-dimensionalen Wärme und Feuchtetransports in Bauteilen, Fraunhofer Institut für Bauphysik, Holzkirchen
- Künzel H.M. (1995), Simultaneous Heat and Moisture Transport in Building Components. - One- and two-dimensional calculation using simple parameters. Fraunhofer IRB Verlag
- Pernot C., Neuhaus E. & Schellen H.L. (2007), GGD-toren Stadhuisplein 2 te Eindhoven: adviesrapport inzake de gevelrenovatie, Technische Universiteit Eindhoven, BPS-rapport 07.04
- Comsol (2006), COMSOL 3.3 Multiphysics User's Guide, COMSOL Inc, Los Angeles USA
- Straube, J.F., and Burnett, E.F.P., (1997), Field testing of filled-cavity wall systems, ICBEST, Int. Conf. Building Envelope, Science and Tech. '97, Bath, UK, April 15-17, pp. 429-434.
- Djebbar, R.; Kumaran, M.K.; Van Reenen, D.; Tariku, F. 2002. Use of hygrothermal numerical modeling to identify optimal retrofit options for high-rise buildings. 12th International Heat Transfer Conference. Grenoble, France, pp. 165-170, August 2002.

IBPSA-NVL 2008 Event

I or we, the author(s) of the attached paper, have read the following Copyright Transfer and Disclaimer, and agree to them by submitting the attached paper.

(2) If the paper is accepted, the author(s) will automatically grant to IBPSA a nonexclusive, royalty-free, perpetual, worldwide, irrevocable, sub-licensable, and transferable license to publish the paper (in unmodified form) in any fashion (including but not limited to inclusion in the IBPSA-NVL 2008 Event CD proceedings and abstract book, via electronic means such as the world wide web, and inclusion in future compilations of papers). This "nonexclusive" license means that the author(s) are not restricted as to future use of the material except that exclusive rights cannot be granted to another.

(3) The author(s) affirm that they have the right to grant the license specified in (2), that is, publication by IBPSA or its licensees will not be in conflict with copyright or other restrictions.

(4) The author(s) acknowledge that acceptance of the paper does not imply IBPSA's endorsement of or agreement with the ideas presented. Under no circumstances shall IBPSA be liable for any damages resulting from use information included in the paper.

Figure 2 The authors are required to accept these conditions and to include this figure in the body of their mail when they submit their paper.