

Manufacturing systems considered as time domain control systems : receding horizon control and observers

Citation for published version (APA):

Roset, B. J. P. (2007). *Manufacturing systems considered as time domain control systems : receding horizon control and observers*. [Phd Thesis 1 (Research TU/e / Graduation TU/e), Mechanical Engineering]. Technische Universiteit Eindhoven. <https://doi.org/10.6100/IR628930>

DOI:

[10.6100/IR628930](https://doi.org/10.6100/IR628930)

Document status and date:

Published: 01/01/2007

Document Version:

Publisher's PDF, also known as Version of Record (includes final page, issue and volume numbers)

Please check the document version of this publication:

- A submitted manuscript is the version of the article upon submission and before peer-review. There can be important differences between the submitted version and the official published version of record. People interested in the research are advised to contact the author for the final version of the publication, or visit the DOI to the publisher's website.
- The final author version and the galley proof are versions of the publication after peer review.
- The final published version features the final layout of the paper including the volume, issue and page numbers.

[Link to publication](#)

General rights

Copyright and moral rights for the publications made accessible in the public portal are retained by the authors and/or other copyright owners and it is a condition of accessing publications that users recognise and abide by the legal requirements associated with these rights.

- Users may download and print one copy of any publication from the public portal for the purpose of private study or research.
- You may not further distribute the material or use it for any profit-making activity or commercial gain
- You may freely distribute the URL identifying the publication in the public portal.

If the publication is distributed under the terms of Article 25fa of the Dutch Copyright Act, indicated by the "Taverne" license above, please follow below link for the End User Agreement:

www.tue.nl/taverne

Take down policy

If you believe that this document breaches copyright please contact us at:

openaccess@tue.nl

providing details and we will investigate your claim.

Manufacturing Systems Considered as
Time Domain Control Systems:
Receding Horizon Control and Observers

PROEFSCHRIFT

ter verkrijging van de graad van doctor aan de
Technische Universiteit Eindhoven,
op gezag van de Rector Magnificus, prof.dr.ir. C.J. van Duijn,
voor een commissie aangewezen door het College voor
Promoties in het openbaar te verdedigen op
donderdag 27 september 2007 om 16.00 uur

door

Bas Johannes Petrus Roset

geboren te Eindhoven

Dit proefschrift is goedgekeurd door de promotoren:

prof.dr. H. Nijmeijer

en

prof.dr.ir. J.E. Rooda

Copromotor:

dr. M.K. Çamlıbel MSc

A catalogue record is available from the Eindhoven University of Technology Library

ISBN: 978-90-386-1089-4

Contents

1	Introduction	5
1.1	Manufacturing systems	5
1.2	Manufacturing systems and their control	8
1.3	MPC: History and basic principle	10
1.4	Manufacturing systems as discrete event systems	13
1.5	Fluid models of manufacturing systems	14
1.6	Objective outline and contributions	16
1.7	Interaction between chapters and publications	19
2	Preliminaries	21
2.1	Mathematical preliminaries	21
2.2	Lyapunov stability	31
2.3	Input-to-state stability	36
3	Nonlinear model predictive control: sub-optimality and robustness	41
3.1	A discrete-time MPC formulation	43
3.2	Input-to-state stable nonlinear MPC	45
3.3	Feedback to disturbances	64
3.4	Decentralized manufacturing control	69
3.5	Summary	81
4	Robustness results for constrained nonlinear closed-loop systems	85
4.1	Robustness to measurement errors	87
4.2	Robustness to measurement errors and actuator noise	91
4.3	Robustness in manufacturing system control	96
4.4	Summary	105
5	Nonlinear model predictive control: output feedback	107
5.1	Nonlinear observers	109
5.2	Problem formulation	116
5.3	Controller design	120
5.4	Observer design	121
5.5	Interconnection results	125
5.6	Manufacturing example	130
5.7	Summary	132

6	Event driven manufacturing systems as time domain control systems	133
6.1	Manufacturing systems in time domain	134
6.2	Manufacturing systems in event domain	137
6.3	Interconnecting event and time domain	139
6.4	Input/state models	143
6.5	A time domain MPC setup	149
6.6	Summary	160
7	An event domain controller design approach for manufacturing systems	161
7.1	Design of robustly stabilizing event domain controller	162
7.2	Causality problem	175
7.3	An event domain observer design approach	178
7.4	Observer-based output feedback control for manufacturing lines	185
7.5	Summary	189
8	Conclusions and future research	191
8.1	Conclusions	191
8.2	Directions for future research	195
	bibliography	206
	Summary	207
	Samenvatting	209
	Acknowledgements	211
	Propositions	213
	Curriculum vitea	215

For a successful technology, reality must take precedence over public relations, for Nature cannot be fooled.

Richard Feynman



Introduction

In this thesis manufacturing systems and model-based controller design, as well as their combinations are investigated. Due to increasing industrial complexity and the costs involved, the need for efficient model-based manufacturing feedback control strategies, to guarantee that the manufacturing system operates in an optimal way, becomes stronger.

1.1 Manufacturing systems

A manufacturing system, is a transformation system in which the actual fabrication of products takes place. In this sense manufacturing systems are defined as the means for transforming or converting raw material inputs into useful product outputs. The input-conversion-output sequence is a useful way to conceptualize manufacturing systems, beginning with the smallest unit of production activity, which one commonly refers to as an *operation* [1]. An operation is the smallest production step in the overall process of producing a product that leads to the final output. A *resource* is necessary for the execution of an operation. A *process* is a set of consecutive operations which complete a significant stage in the manufacturing of a product. Material is the operand that undergoes the process. The materials used as input to a manufacturing system are called *raw materials*, while the outputs of a manufacturing system are called *products*. Products are created by different operations on one or more raw materials. The way these operations are performed is defined by a *recipe*. A recipe is a list of operations that have to be executed. A recipe tells which operations have to be performed, what raw material is involved and in which order the operations have to be executed.

A rough classification of manufacturing systems can be made by considering the universality of the resources and the route flexibility inside the manufacturing system. This results in the classes *flow shop* and *job shop* [2]. A flow shop is characterized by dedicated and a fixed route. Flow shops are product-oriented manufacturing sys-

tems. In a job shop there are universal resources which can be used for many different operations and many possible routes. Job shops are process-oriented manufacturing systems. The producing of high-volume standardized products in a flow shop results in continuous use of the facilities. In contrast the production of small-batch variant products in a job shop results in intermittent demand for the system's facilities, and the material flows from one process to the next is intermittently.

In order to explain the basic "physics" of manufacturing systems a simple funnel model is introduced. The funnel model for manufacturing systems is proposed in [3]. The model, which is based on the idea that every work station in a manufacturing system can be abstracted into a *funnel*, see the left part of Figure 1.1. The funnel model

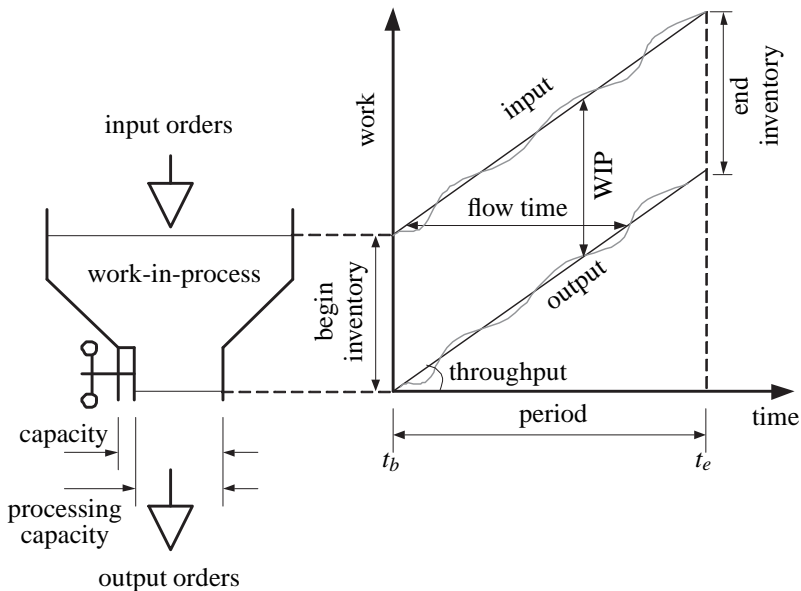

Figure 1.1: Funnel model of manufacturing systems and throughput diagram.

can be employed as a tool to help in understanding the manufacturing process. All the input orders want to pass the funnel, but they cannot get through at once because of the capacity limit. The output orders correspond to the processing capacity. Hence, part of the input orders form an inventory of waiting orders, which is depicted as work-in-process in Figure 1.1. The mean flow time (or lead time) of an order is proportional to the work-in-process, and it is inverse proportional to the capacity. The throughput diagram, presented in the right part of Figure 1.1, represents the work input and output at the work station over a period of time. At the start of the observation period t_b , one

has to draw the input trend curve. The input trend curve is obtained by adding up the input order work contents over time within the period. The output curve is constructed by adding up the completed order work contents over time within the period. At the end of the observation time t_e there is also a certain inventory, i.e. an *end inventory* in Figure 1.1, which can be seen as the begin inventory for the next observation period. Further, the throughput diagram shows how the key values of work-in-process, flow time and throughput (production rate) are related. Flow time is defined as the time period between the time when an order arrives at the funnel and the time when it leaves the funnel. The mean flow time is determined by calculating the arithmetic mean of individual flow times. For a manufacturing system in *steady state* operation the funnel model of the manufacturing system can be described by the so-called funnel formula also known as Little's law [4, 5]

$$W_m = \varphi_m \cdot \delta_m, \quad (1.1)$$

where W_m is the mean Work-In-Progress (WIP), φ_m is the mean flow time, and δ_m is the mean throughput [output orders/period].

A typical manufacturing problem that one could be interested in is how to meet the demands of customers meanwhile keeping a high profit for the company. One of the measures is to have a reliable short delivery time of orders with a high production rate (throughput) of the manufacturing system. Reliable short delivery times can be ensured by reliable short flow times. The objectives of manufacturing are to obtain short mean flow times of orders and reasonable high throughput of the system. Both mean flow time and throughput can be adjusted by altering the mean work-in-process. A high WIP generally results a high throughput, but leads to long flow times. Low WIP may lead to short flow time, but it results in a low throughput. Obviously mean throughput and mean flow time have a conflicting relation. For a manufacturing system in *steady state* operation a graphical relation between throughput and mean flow time as function of the mean work-in-progress can be obtained resulting in Figure 1.2 [5]. If the WIP is varied within a wide range, a corresponding variation of the mean flow time will be the result, see Figure 1.2. The so-called *critical points* on the idealized mean flow time and throughput curves correspond to a WIP at which the manufacturing system operates at its full capacity, i.e. maximum throughput, whereas the flow time attains its minimum value which is equal to the mean processing or operation time. By increasing the WIP from this point the throughput does not change and equals the capacity of the manufacturing system, but the mean flow time increases proportionally with respect to the WIP. Note that the idealized curves in Figure 1.2 obey Little's law given in (1.1). By decreasing the WIP from the critical point the flow time will remain constant and equal to the processing time of the manufacturing system, while the throughput will proportionally decrease. Hence, the characteristic curves in

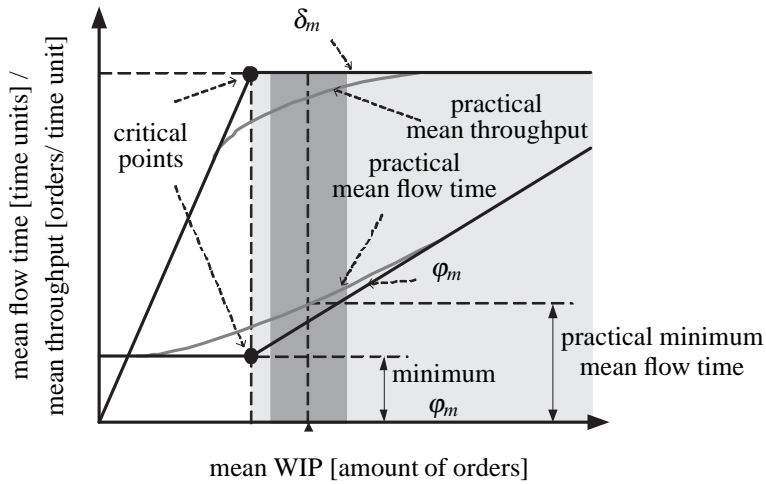

Figure 1.2: The characteristic curves.

Figure 1.2 are divided into two parts. The shadowed part and the unshadowed part. Within the unshadowed part machines in the manufacturing system will be idle or waiting for orders from time to time. The shadowed part represents the case in which the manufacturing system is always busy. The critical points indicated in Figure 1.2 are obviously the desired *steady state* working points. The *practical* critical points are expected somewhat different from the theoretical ones and are more shifted to the right (due to variability that is present in the system in practice). The dark shadowed part indicates a desired *steady state* working region for the manufacturing system. One of the goals of *control* in the context of manufacturing systems is to dynamically stabilize the manufacturing system to the desired *steady state* working points. In the next section control is introduced in the context of manufacturing systems.

1.2 Manufacturing systems and their control

In the field of manufacturing systems, control is an important issue, which appears at various operation levels. At the process level, for example, control is necessary in order to assure properly working processes. At an intermediate level, sequencing and scheduling rules are used to decide which of the products that are waiting, in front of a machine, should be processed first. At the top level of a manufacturing system, the product streams through the system are controlled to satisfy customer demands in some optimal sense. Here, the definition of optimal can be interpreted

in various ways, such as “with the least possible costs in terms of money”, “in the shortest possible time”. In this thesis, the attention is focussed on the top level of control as just defined. The word control related to manufacturing systems should in the remainder of the thesis therefore be interpreted in this context.

Many heuristic methods such as Just-In-Time production (JIT), Kanban pull system, Material Requirements Planning (MRP), Manufacturing Resource Planning (MRP II), Queueing Models and Load Oriented Order Release (LOOR), see e.g. [2] and references therein, appear in the literature in relation to manufacturing system control. From a strictly system theoretical point of view one could argue whether the word control in relation to the just mentioned heuristic is justified. In many cases the heuristic methods do not even have a clear *feedback mechanisms*, which is necessary when one wants to react meaningfully on unforeseen changes and perturbations occurring in the system. Although the usage of the word control might be abused in relation to the afore mentioned heuristics it is employed just for the ease of formulation.

The application of MRP to manufacturing control is considered as the big breakthrough in the 1970's within the manufacturing society. This approach ties together in a computer program all the parts that go into complicated products. This enables production planners to quickly adjust production schedules and inventory purchases to meet changing demands for final products [6]. As soon as MRP considered resources as well as materials, it was called MRP II. JIT production is clearly the major breakthrough in manufacturing philosophy in the 1980's. JIT is an integrated set of activities designed to achieve high-volume production using minimal inventories of parts that arrive at the workplace “just-in-time”. The Kanban pull system is simple and self-regulating, which provides good management visibility. This system is designed to produce only the number of parts needed by “pulling” the products through the system. The Kanban pull system of inventory control works particularly well in situations where standardized parts and products are cycled in the manufacturing systems, as for example in an assembly environment.

Nowadays, the afore mentioned heuristic methods are still being used in combination with operator experience for management of resources and planning of production. However, as the complexity of the manufacturing systems rapidly increases, the (simple) heuristic methods and operator experience will at some point become incapable of finding an “optimal” control strategy.

In this dissertation the potential of considering manufacturing system control from a system theoretic control point of view is investigated, with the ultimate goal of eventually obtaining a more constructive way to address controller design for manufacturing systems. One of the famous existing theoretical control frameworks for (discrete-event) manufacturing systems is based on automata theory as proposed in [7]. However, one of the main drawbacks of this framework is the unsolved problem of state

explosion. Among different existing control methods, in this dissertation the optimal control framework with its receding horizon implementation often referred to as Model Predictive Control (MPC), e.g. see [8, 9, 10, 11, 12] and references therein, is chosen. The major reasons to investigate the model predictive control principle as a control strategy for manufacturing systems are the potential of simultaneously

- to enforcing *optimality*,
- to handle *constraints*,
- to introduce *feedback*.

Since in manufacturing systems a lot of physical system constraints are involved, like for example *finite* machine process capacities, *finite* product storage capacities, *finite* product arrival rates, etc., the capability for a manufacturing control strategy to handle those constraints is a necessity. Furthermore, feedback is important to deal with all kinds of unforeseen or unpredictable chances or perturbations occurring in the manufacturing system, like machine break downs. Other important motivations to investigate the model predictive control principle in relation to manufacturing systems are

- the capability of allowing for the mixed continuous and discrete model structures. Model structures with mixed continuous and discrete nature are sometimes referred to as hybrid models, which often are encountered when models of manufacturing systems are derived.
- the intuitive principle on which the control strategy is based on and the way manufacturers work in practice,

1.3 MPC: History and basic principle

Model Predictive Control (MPC), also referred to as receding horizon control, is a control strategy that offers appealing solutions for the control of a broad class of systems that can be described by (piecewise) continuous (or discrete) time differential (or difference) equations. One of the key characteristic elements of model predictive control that distinguishes itself from other existing control strategies is the ability of handling constraints, which are almost always present in (manufacturing) applications. Within a relatively short time, model predictive control has reached a certain maturity because of the continuously increasing interest for this distinctive part of control theory. This is not only illustrated in many articles and books see, for example, [8, 9, 10, 11, 12] and references therein, but also in many successful implementations in industry of which some examples will follow in the sequel.

The initial model predictive control algorithms utilized only linear input/output models. In this framework, several solutions have been proposed both in the industrial

world and in the academic world: IDCOM - Identification and command (later MAC - Model algorithmic control) at ADERSA [13] and DMC - Dynamic matrix control at Shell [14], which use step and impulse response models, MUSMAR - Multistep multivariable adaptive regulator [15] - the first model predictive control formulation that is based on state-space linear models, and EPSAC - Extend predictive self-adaptive control [16]. Generalized frameworks for setting up model predictive control algorithms based on input/output models were also developed later on, from which the most significant ones are GPC - Generalized predictive control [17] and UPC - Unified predictive control [18]. The next step of the academic community was to extend the model predictive control algorithms based on state-space models to continuous (smooth) nonlinear systems, which includes the following approaches: nonlinear model predictive control with zero state terminal equality constraint [19], dual-mode nonlinear model predictive control [20] and quasi-infinite horizon nonlinear model predictive control [21]. More recent general set-ups for synthesizing stabilizing model predictive control algorithms for smooth nonlinear systems can be found in [22, 23]. Another issue that makes model predictive control an attractive control strategy is that it can in principle cope with hybrid model formulations. The first model predictive control approach for the control of hybrid systems has been reported quite recently in [24, 25].

One of the reasons for the fruitful achievements of model predictive control algorithms consists in the intuitive way of addressing the control problem. In comparison with conventional control, which often uses a pre-computed state or output feedback control law, predictive control uses a model of the system to obtain a prediction of its future behavior. This is done by applying a set of control trajectory to a model, with the measured state as initial condition, while taking into account the constraints. An optimization problem built around a performance oriented cost function is then solved to choose an optimal control trajectory from all feasible trajectory. A feedback mechanism is then obtained in a receding horizon manner by applying to the system only the first part of the computed optimal control trajectory, and repeating the whole procedure at a next discrete-time step. Summarizing the above discussion, one can conclude that model predictive control is built around the following principles:

- The explicit use of a model of the system to be controlled for calculating predictions of the future system behavior;
- The optimization of an objective function subject to constraints, which yields an optimal control trajectory;
- The receding horizon strategy (which induces feedback), according to which only the first part of the optimal control trajectory is applied on-line.

The model predictive control methodology involves solving on-line an finite horizon

optimal control problem subject to system and control trajectory constraints. A graphical illustration of the basic concept is depicted in Figure 1.3. Based on measurements

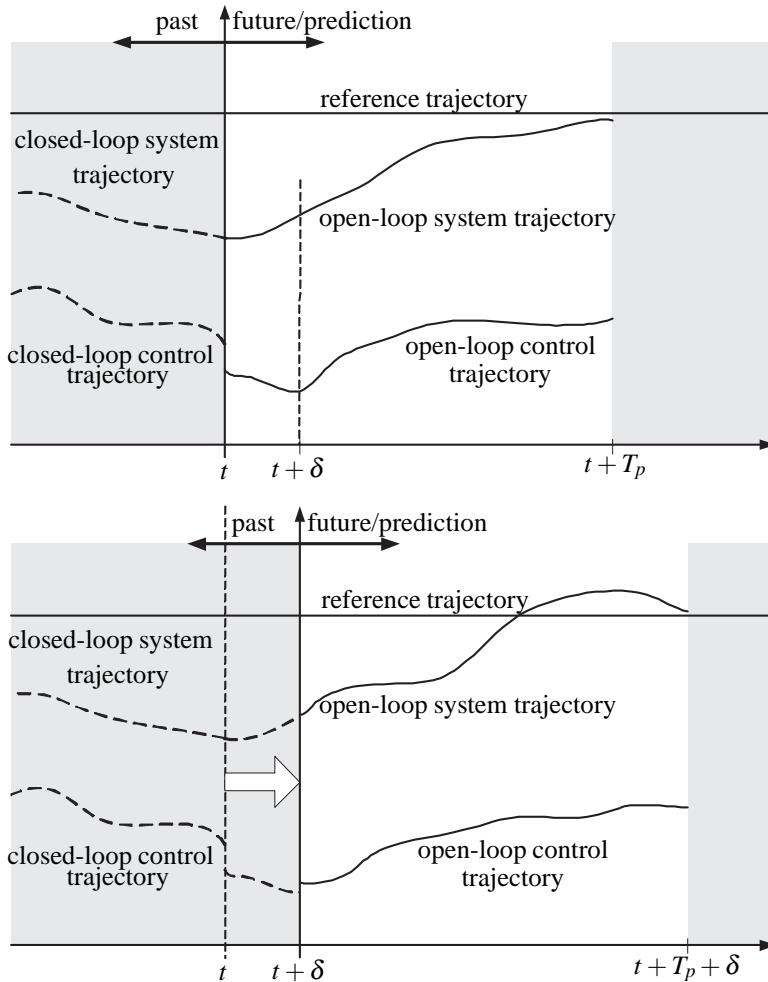

Figure 1.3: Principle of the model predictive control strategy.

obtained at time $t \in \mathbb{R}_+$, the controller predicts the dynamic behavior of the system over a prediction horizon $T_p \in \mathbb{R}_+$ into the future and determines the control trajectory such that a predetermined open-loop performance objective is minimized. If there were no disturbances and no model mismatches, and if the optimization problem could be solved over an infinite horizon, then the control trajectory found at $t = 0$ could be

injected to the system for all $t \in \mathbb{R}_+$. However, due to disturbances, model mismatch, and the finite prediction horizon the actual system behavior is different from the predicted one. To incorporate feedback, the optimal open-loop control trajectory is injected into the system only until the next sampling instant $t + \delta$ ¹. At the next sample instant $t + \delta$ new measurements from the physical system are available and the whole procedure - prediction and optimization - is repeated, moving the prediction horizon forward.

In Figure 1.3 the open-loop optimal control trajectory is depicted as a (piecewise) continuous function of time. To allow a numerical (approximate) solution of the open-loop optimal control trajectory the control is often parameterized by a finite number of basis functions, leading to a finite dimensional optimization problem. In practice often a piecewise constant control trajectory is employed, leading to T_p/δ decisions for the control trajectory over the prediction horizon.

Depending on what kind of modeling framework one considers, there are various ways of formalizing the model predictive control problem. Although continuous-time models can be employed, see [9, 11] and Chapter 6 of this thesis, model predictive control is often considered from a discrete-time perspective. One of the benefits of considering model predictive control from a discrete-time perspective is that the optimal control trajectory does not have to be parameterized as to obtain a finite dimensional optimization problem. Furthermore, the stability analysis in discrete-time is in general less complex. One of the disadvantages of considering model predictive control from a discrete-time perspective is the fact that it is usually hard to obtaining discrete-time nonlinear models since, in general, the description of physical systems leads to continuous-time models.

Clearly, modeling of the system to-be-controlled is an important issue in case the model predictive control principle is employed. Modeling issues for control purposes of manufacturing systems is therefore introduced next.

1.4 Manufacturing systems as discrete event systems

Manufacturing systems are mostly modeled and considered as a discrete event system (DES), see e.g. [26]. Unlike continuous- or discrete-time dynamical systems, discrete event systems are “driven” only by *occurrences* of different types of events instead of time. An event, in the context of a manufacturing system, is a *change* of the “mode of being” of the manufacturing system that takes place at a certain point in time, such as the arrival of a product at a buffer in front of a process, or a machine or process becoming available to process a product. Note that, for example, product transport and processing of a product by a machine are not events. They induce a change *over*

¹Note that in general the time between each new optimization, the sample time δ , can vary.

time in the system, however they do not *change* the “mode of being” of the system. The start and end of such an action however are events. At each event the mode of being of the manufacturing system changes; between two events the mode of being remains unchanged.

Discrete event systems can be specified or described by logic rules, see e.g. [27, 28]. Events satisfy these logical specifications. Generally speaking, one can consider discrete event systems that can evolve, i.e. events occur, without time elapsing. A class of discrete event systems, which the manufacturing systems that are considered in this thesis also belong to, are timed discrete event systems. In this class of discrete event systems, some time has to elapse after some finite number of events have occurred. In other words although the system is event driven events occur over time.

One of the major difficulties of analyzing discrete event systems from a system theoretic point of view is the fact that those systems are hard to tackle in a *time domain* based mathematical framework as there exists for continuous- or discrete-time dynamical systems. However, there exists a mathematical machinery, see e.g. [29, 30, 31], for a subclass of discrete event systems. A disadvantage, however, is that the mathematical machinery can only be employed if the system modeling is performed in the so called *event domain*. In *event domain* descriptions, the evolution of time labels associated to certain events are considered along a discrete *event axis*. Since, all system theoretic notions and control objectives are time domain related a compatibility and/or causality problem emerges. One of the contributions of the thesis is having established insight in the relation between the event domain and the time domain way of modeling. This result makes it possible to utilize event domain related mathematical tools to solve time domain control problems. This has been illustrated in the context of a model predictive control problem and on an observer problem for a class of discrete-event manufacturing systems in Chapters 6 and 7 of the thesis.

1.5 Fluid models of manufacturing systems

Another way of looking at discrete-event manufacturing systems is to approximate the relatively detailed nature of the discrete-event system description. In particular if there are a lot of products being processed by the manufacturing system, think for example about mass fabrication of products, then from a modeling point of view it could be justified to consider the product streams in the manufacturing system as fluid streams, see e.g. [32, 33].

The idea of approximating discrete-event manufacturing systems is motivated by the potential of the directly utilizing “conventional” existing control theory to synthesis controllers for manufacturing systems. This approach is visualized in Figure 1.4, see e.g. [34, 35]. In Figure 1.4 one can observe conversion blocks between the con-

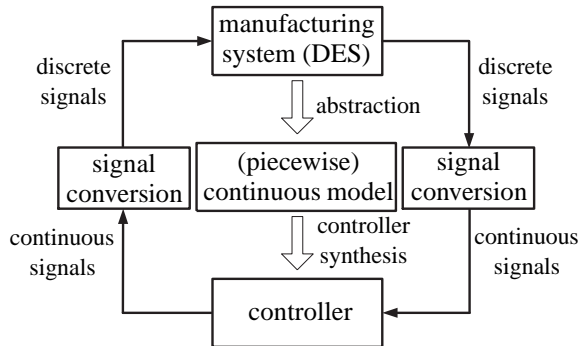

Figure 1.4: Framework of controller synthesis based on (piecewise) continuous model abstraction of discrete event manufacturing system.

troller and the discrete event manufacturing system. These represent conversion algorithms that are needed to establish compatibility between the discrete event system and the controller. That is, discrete signals from the discrete event system must be converted to signals that are compatible with those the controller needs for feedback and control signals the controller generates must be converted to compatible commands, i.e. control signals, for the discrete event system.

An important issue, which is induced by the conversion blocks, is a quantization problem. Quantization errors are introduced due to the fact that the discrete nature of a manufacturing system is approximated by something (piecewise) continuous of nature. More details about this issue will follow later in the thesis, i.e. Chapter 4.

It is well known that a feedback law designed to be globally asymptotically stabilizing for the system in absence of quantization errors may lead to instability if this control law is implemented on the system where quantization errors are present, see e.g. [36]. One reason for this is saturation: If the quantized signal is outside the range of the quantizer, then the quantization error is large, and the control law designed for the ideal case of no quantization may lead to instability. Another reason is deterioration of performance near the equilibrium: As the difference between the current and the desired values of the state becomes small, higher precision is required, and so in the presence of quantization errors asymptotic convergence is typically lost. Hence, finding a stabilizing controller in the framework as depicted in Figure 1.4 is not sufficient to guarantee stabilizing behavior of the designed controller in closed-loop with the manufacturing system as depicted in Figure 1.4. Note that the above discussion also holds for nonlinear model predictive controller design for manufacturing systems

using the framework as depicted in Figure 1.4.

From the above discussion, it follows that it is important that the quantization errors, for example, in the measurements employed in the controller are taken into account in the controller design. However, existing (nonlinear) model predictive control schemes cannot cope with this issue. This is the motivation to investigate how to design nonlinear model predictive control schemes in which this issue can be taken into account. In Chapter 4 robustness results are obtained that can be employed in this matter.

Recently a result on manufacturing control employing fluid models has appeared in [37]. In [37] an LMI approach is followed to design controllers for manufacturing systems. However, the approach followed by [37] can only capture linear fluid models of manufacturing systems while fluid models for manufacturing systems are often nonlinear and might exhibit discontinuous, i.e. hybrid model structures. The approaches proposed in this thesis can to some extent cope with the later model structures.

1.6 Objective outline and contributions

The objectives of the research presented in this thesis are

- The development of computationally friendly robust model predictive control techniques for a class of nonlinear hybrid systems suitable for manufacturing system control;
- The development of observer-based output feedback model predictive control techniques for nonlinear systems;
- The development of model predictive control techniques for discrete event manufacturing systems.

Next it is explained how each chapter relates to the research objectives.

Chapter 2 “*Preliminaries*” In this chapter mathematical notation and definitions are given, which will be used throughout the remainder of the thesis. Furthermore, stability properties for discrete-time nonlinear difference inclusions such as Lyapunov stability [38, 39] and input-to-state stability [40, 41] are defined in this chapter. Sufficient conditions for stability that allow for discontinuous system dynamics, non-uniqueness of solutions and discontinuous candidate Lyapunov functions are given.

Chapter 3 “*Nonlinear model predictive control: sub-optimality and robustness*” This chapter focuses on the synthesis of computationally friendly sub-optimal model predictive control algorithms for hybrid nonlinear with guaranteed robust stability of the closed-loop system, i.e. input-to-state stability of the closed-loop system with respect to additive disturbances. For the analysis of robustness of the to-be-controlled

system in closed-loop with the model predictive controller the input-to-state stability framework introduced in Chapter 2 is employed. Opposed to existing input-to-state stabilizing model predictive control schemes simple stabilizing constraints, that can be implemented as a finite number of linear inequalities, lead to a reduction of on-line computational complexity of the controller. Besides that the designed model predictive controller renders the close-loop system input-to-state stable with respect to additive disturbances also *suppression* of the additive disturbance is established by incorporating a mechanism which gives feedback to disturbances. It is illustrated how the developed model predictive control algorithm in this chapter can be employed to efficiently solving a manufacturing network control problem in a decentralized way.

Chapter 4 “*Robustness results for control and state constrained closed-loop systems*”

The in Chapter 3 mentioned newly proposed model predictive control scheme can a priori guarantee robustness, i.e. input-to-state stability, of the closed-loop system with respect to *additive disturbances*. However, does this also imply that the resulting closed-loop system is, for example, input-to-state stable to *state measurement errors* and *actuator noise*? For state and control constrained nonlinear systems controlled by nonlinear model predictive controllers, which result in control laws that are possibly discontinuous and/or set-valued, the mentioned question is still open. However, a result on this issue is given in this chapter. Note that the afore mentioned question is one that does not necessarily has to be asked in the context of model predictive control but can be stated in general. However, since model predictive control is one of the few control strategies to deal in a systematic way with constraints, the result is in particularly interesting in this field. The result in this chapter gives mild conditions under which the afore mentioned question can be answers with yes. The value of this result is emphasized due to the fact that nonlinear model predictive controller synthesis methodologies that result in closed-loop systems that are input-to-state stable with respect to *state measurement errors* (and *actuator noise*) are rare, while there is a relatively rich literature on how to synthesize model predictive controllers that can cope with *additive disturbances*, see e.g. Chapter 3 of this thesis and [42, 43, 44, 45, 46, 47]. Then, based on the result in this chapter all model predictive control design methodologies in for example [42, 43, 44, 45, 46, 47] can, not only be employed to render the closed-loop system input-to-state stable with respect to *additive disturbances*, but they can also be employed to render the closed-loop system input-to-state stable with respect to *state measurement errors* and *actuator noise*. Furthermore, in the context of manufacturing system control it is shown how the issue pointed-out in the end of Section 1.5 can be treated employing the robustness result obtained in this chapter.

Chapter 5 “*Nonlinear model predictive control: output feedback*” The focus in this part of the thesis is on how to synthesize stabilizing output feedback nonlinear model predictive controllers. In contrast to Chapter 3, where knowledge of the full state of

the to-be-controlled system is required, in this chapter one requires less information of the to-be-controlled system to be available for feedback. That is, only knowledge of the *output* is required. An observer-based approach is followed to solve the output feedback nonlinear model predictive control problem. It is shown how to *separately* design a nonlinear observer and a nonlinear model predictive controller, which represents a possibly discontinuous state feedback control law, such that, by employing the certainty equivalence principle, a stabilizing *output feedback* nonlinear model predictive controller is obtained. For the analysis the input-to-state stability framework introduced in Chapter 2 is employed.

Chapter 6 “*Event driven manufacturing systems as time domain control systems*” In contrast to the previous chapters, i.e. Chapters 3, 4, where manufacturing systems are controlled employing the model predictive control principle based on *fluid models* of manufacturing systems, in this chapter the focus is on employing the model predictive control principle directly based on the *discrete-event* description of the manufacturing system. It is shown how besides time domain modeling, the discrete-event property of manufacturing systems opens the opportunity to model manufacturing systems from an *event domain* perspective. It is shown that in contrast to relatively complex time domain models, that are obtained when modeling manufacturing systems, event domain modeling facilitates obtaining relatively simple (analytical) difference equations as descriptions of discrete-event manufacturing systems. Furthermore, it is shown that under some conditions there exists a bijective mapping between the event and time domain modeling frameworks. This opens possibilities to employ the relatively simple event domain models to do controller computations for manufacturing systems controlled in time domain. This is illustrated on a discrete-event manufacturing system controlled in time domain by employing the model predictive control principle. A continuous time model predictive control setup is formulated and it is shown how the optimization problem involved can be solve via the event domain in a tractable way.

Chapter 7 “*An event domain controller design approach for discrete-event manufacturing systems*” In Chapter 6 a continuous time model predictive control setup is formulated and it is shown how in case of discrete-event manufacturing systems the involved optimization problem can be solved efficiently via the event domain, which is introduced in Chapter 6 of the thesis. However, a major open issue that remains, is to formally prove closed-loop stability following the time domain model predictive control setup in Chapter 6. To facilitate stability analysis, in this chapter a model predictive control setup for discrete-event manufacturing systems is formulated in event domain. Since in the event domain the description of the manufacturing system dynamics can be described as difference equations (as is shown in Chapter 6) this approach allows one to employ “conventional” discrete-time stability analysis of the resulting event domain closed-loop system. It is shown that the approach leads to

event domain controllers that are stabilizing in the event domain. However, a disadvantage of this approach is that the obtained controllers cannot straightforwardly be employed in the time domain due to a causality problem that emerges. It is pointed out how in case of manufacturing lines this causality problem can be taken care of by using an observer.

1.7 Interaction between chapters and publications

The interactions between the chapters in the thesis is graphically presented by means of a block diagram presented in Figure 1.5. Most of the material that is presented in

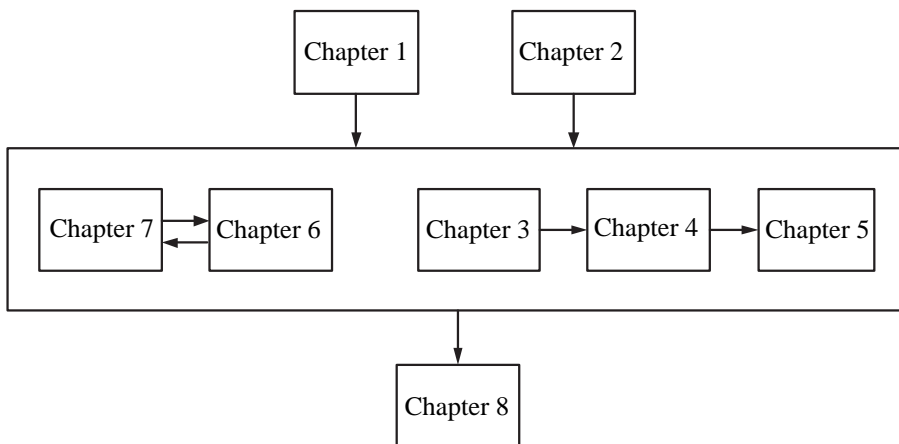

Figure 1.5: The interaction between chapters.

the chapters of this Ph.D. thesis is published, or accepted for publication, in journals or conference proceedings. Some of the material has been submitted for publication recently. Below it is indicated to which chapter of the thesis these publications belong to.

- Chapter 3 is based on [43, 44].
- Chapter 4 is based on [48, 49].
- Chapter 5 is based on [50, 51, 52, 53].
- Chapter 6 is based on [54, 55].

*Any man whose errors take ten
years to correct is quite a man.*

Robert Oppenheimer

2

Preliminaries

In this chapter stability properties for discrete-time nonlinear difference inclusions such as Lyapunov stability and input-to-state stability are defined. Sufficient conditions for stability that allow for discontinuous system dynamics, non-uniqueness of solutions and discontinuous candidate Lyapunov functions are given. Before treating the stability properties for discrete-time nonlinear difference inclusions, first some mathematical notation and definitions are given, which will be used throughout the remainder of the thesis.

2.1 Mathematical preliminaries

In this section, some basic mathematical notation and standard definitions are given.

Sets and operations with sets

- The sets \mathbb{R} , \mathbb{R}_+ , \mathbb{Z} and \mathbb{Z}_+ denote the set of real numbers, the set of non-negative reals, the set of integers and the set of non-negative integers, respectively;
- For a set $\mathcal{S} \subseteq \mathbb{R}^n$ or $\mathcal{S} \subseteq \mathbb{Z}^n$ and some $n \in \mathbb{Z}_{>0}$.
 - $\mathcal{S}_{\geq c_1}$ denotes the set $\{s \in \mathcal{S} | s \geq c_1\}$ for some $c_1 \in \mathcal{S}$;
 - $\mathcal{S}_{> c_1}$ denotes the set $\{s \in \mathcal{S} | s > c_1\}$ for some $c_1 \in \mathcal{S}$;
 - $\mathcal{S}_{\leq c_1}$ denotes the set $\{s \in \mathcal{S} | s \leq c_1\}$ for some $c_1 \in \mathcal{S}$;
 - $\mathcal{S}_{< c_1}$ denotes the set $\{s \in \mathcal{S} | s < c_1\}$ for some $c_1 \in \mathcal{S}$;
 - $\mathcal{S}_{[c_1, c_2]}$ denotes the set $\{s \in \mathcal{S} | c_1 \leq s \leq c_2\}$ for some $c_1 \in \mathcal{S}$, $c_2 \in \mathcal{S}_{\geq c_1}$;
 - $\mathcal{S}_{(c_1, c_2]}$ denotes the set $\{s \in \mathcal{S} | c_1 < s \leq c_2\}$ for some $c_1 \in \mathcal{S}$, $c_2 \in \mathcal{S}_{> c_1}$;
 - $\mathcal{S}_{[c_1, c_2)}$ denotes the set $\{s \in \mathcal{S} | c_1 \leq s < c_2\}$ for some $c_1 \in \mathcal{S}$, $c_2 \in \mathcal{S}_{> c_1}$;

- $\mathcal{S}_{(c_1, c_2)}$ denotes the set $\{s \in \mathcal{S} \mid c_1 < s < c_2\}$ for some $c_1 \in \mathcal{S}$, $c_2 \in \mathcal{S}_{>c_1}$;
- For two arbitrary sets \mathcal{S}_1 and \mathcal{S}_2 , $\mathcal{S}_1 \subset \mathcal{S}_2$ denotes “ \mathcal{S}_1 is a subset of but not equal to, \mathcal{S}_2 ”, $\mathcal{S}_1 \subseteq \mathcal{S}_2$ denotes “ \mathcal{S}_1 is a subset of, or equal to \mathcal{S}_2 ”, $\mathcal{S}_1 \cup \mathcal{S}_2$ denotes their *union*, $\mathcal{S}_1 \cap \mathcal{S}_2$ denotes their *intersection*, $\mathcal{S}_1 \setminus \mathcal{S}_2$ denotes their *set difference*;
- For a set \mathcal{S} , \mathcal{S}^n denotes the *Cartesian product* $\mathcal{S} \times \mathcal{S} \times \dots \times \mathcal{S}$, where \mathcal{S} appears n times and $n \in \mathbb{Z}_{\geq 1}$;
- The notation $\mathcal{S}^{\mathcal{P}}$ is a shorthand notation to denote the set of all maps from \mathcal{P} to \mathcal{S} ;
- For a set $\mathcal{S} \subseteq \mathbb{R}^n$, $\text{int}(\mathcal{S})$ denotes the *interior* of \mathcal{S} , $\text{cl}(\mathcal{S})$ denotes the *closure* of \mathcal{S} , $\text{card}(\mathcal{S})$ denotes the number of elements of \mathcal{S} and $\text{Co}(\mathcal{S})$ denotes the *convex hull* of \mathcal{S} ;
- A *polyhedron* (or a polyhedral set) in \mathbb{R}^n is a set obtained as the intersection of a finite number of open and/or closed half-spaces.
- Given $(n+1)$ *affinely independent* points $\{s^0, s^1, \dots, s^n\}$ of \mathbb{R}^n , i.e. $[1 \ s^0]^\top, \dots, [1 \ s^n]^\top$ are linear independent in \mathbb{R}^{n+1} , a *simplex* \mathbb{S} is defined as

$$\mathbb{S} \triangleq \text{Co} \{s^0, \dots, s^n\} \triangleq \left\{ \xi \in \mathbb{R}^n \mid \xi = \sum_{i=0}^n \mu_i s^i, \sum_{i=0}^n \mu_i = 1, \mu_i \in \mathbb{R}_{\geq 0}, \text{ for } i = 0, 1, \dots, n \right\},$$

where $\text{Co}\{\cdot\}$ denotes the *convex hull*.

- For two arbitrary sets $\mathcal{S}_1 \subseteq \mathbb{R}^n$ and $\mathcal{S}_2 \subseteq \mathbb{R}^n$,

$$\mathcal{S}_1 \sim \mathcal{S}_2 \triangleq \left\{ x \in \mathbb{R}^n \mid x + \mathcal{S}_2 \subseteq \mathcal{S}_1 \right\}$$

denotes their *Pontryagin difference* and

$$\mathcal{S}_1 \oplus \mathcal{S}_2 \triangleq \left\{ x + y \mid x \in \mathcal{S}_1, y \in \mathcal{S}_2 \right\}$$

denotes their *Minkowski sum*.

- A closed hyperball of dimension $n \in \mathbb{R}_{\geq 1}$ with center $c \in \mathbb{R}^n$ and radius $r \in \mathbb{R}_{>0}$ is defined by

$$\mathcal{B}_r(c) \triangleq \left\{ \xi \in \mathbb{R}^n \mid \|\xi - c\|_p \leq r \right\}.$$

- A *singleton set*, i.e. a set \mathcal{S} having exactly one element s , is denoted by $\{s\}$.

Vectors, matrices and norms

- For any $x \in \mathbb{R}^n$, x_i with $i \in \{1, 2, \dots, n\}$ stands for the i^{th} component of x ;
- For a real number $a \in \mathbb{R}$, $|a|$ denotes its absolute value;
- The Hölder p -norm of a vector $x \in \mathbb{R}^n$ is defined as:

$$|x|_p \triangleq \begin{cases} (|x_1|^p + \dots + |x_n|^p)^{\frac{1}{p}}, & p \in \mathbb{Z}_{[1, \infty)} \\ \max_i |x_i|, & p = \infty, \end{cases}$$

where $|x|_2$ is also known as the Euclidean norm and $|x|_\infty$ is also called the infinity norm;

- For any matrix A the notation A_{ij} is used to denote the ij -th entry of A ;
- For any matrix $A \in \mathbb{R}^{n \times m}$ and $p \in \mathbb{Z}_{\geq 1}$ or $p = \infty$

$$|A|_p \triangleq \sup_{x \neq 0} \frac{|Ax|_p}{|x|_p},$$

denotes its induced matrix norm. For $p = 2$ the quantity $\sup_{x \neq 0} |Ax|_p / |x|_p$ is equal to the *maximal singular value* of A , which is denoted by $\bar{\lambda}(A)$. Furthermore,

$$|A|_\infty = \max_{1 \leq i \leq m} \sum_{j=1}^n |A_{ij}|;$$

- In the sequel of the thesis one uses for any $x \in \mathbb{R}^n$ $|x|$ as the shorthand notation for an arbitrary norm on \mathbb{R}^n ;
- A shorthand notation for an $n \times n$ identity matrix, i.e. $I \in \mathbb{R}^{n \times n}$, is denoted by I_n ;
- For any matrix $A \in \mathbb{R}^{n \times m}$, $\text{di}([A]_N)$ denotes a block diagonal matrix of appropriate dimension with the matrices A, \dots, A appearing $N \in \mathbb{Z}_{\geq 1}$ times on the main diagonal, i.e.

$$\text{di}([A]_N) \triangleq \underbrace{\begin{bmatrix} A & 0 & \dots & 0 \\ 0 & \ddots & \ddots & \vdots \\ \vdots & \ddots & \ddots & 0 \\ 0 & \dots & 0 & A \end{bmatrix}}_{N \text{ times}};$$

- For a matrix $A \in \mathbb{R}^{m \times n}$, A^\top denotes its transpose;

- For a matrix $A \in \mathbb{R}^{n \times n}$, A^{-1} denotes its inverse (if it exists);
- For a matrix $A \in \mathbb{R}^{n \times n}$, $A > 0$ means “ A is *positive definite*”, i.e. for all $x \in \mathbb{R}^n \setminus \{0\}$ it holds that $x^\top Ax > 0$, and $A = A^\top$;
- For a matrix $A \in \mathbb{R}^{m \times n}$ with full-column rank, $A^{-L} \triangleq (A^\top A)^{-1} A^\top$ denotes the Moore-Penrose inverse of A , which satisfies $A^{-L} A = I_n$;
- A pair of matrices $(C, A) \in \mathbb{R}^{p \times n} \times \mathbb{R}^{n \times n}$ is called an *observable pair* if

$$\text{rank} \begin{bmatrix} C \\ CA \\ \vdots \\ CA^{n-1} \end{bmatrix} = n;$$

- A matrix $A \in \mathbb{R}^{n \times n}$ is called *Schur* if all its eigenvalues are within the unit disk.

Functions and function classes

- A function $\gamma: \mathbb{R}_+ \rightarrow \mathbb{R}_+$ is a \mathcal{K} -function if it is continuous, strictly increasing and $\gamma(0) = 0$;
- A function $\gamma: \mathbb{R}_+ \rightarrow \mathbb{R}_+$ is a \mathcal{K}_∞ -function if it is a \mathcal{K} -function and in addition it is radially unbounded, i.e. $\gamma(s) \rightarrow \infty$ as $s \rightarrow \infty$;

Remark 2.1.1 If γ is of class \mathcal{K}_∞ then the inverse function γ^{-1} is well defined and is again of class \mathcal{K}_∞ .

- A function $\beta: \mathbb{R}_+ \times \mathbb{R}_+ \rightarrow \mathbb{R}_+$ is a \mathcal{KL} -function if, for each fixed $k \in \mathbb{R}_+$, the function $\beta(\cdot, k)$ is a \mathcal{K} -function, and for each fixed $s \in \mathbb{R}_+$, the function $\beta(s, \cdot)$ is non-increasing and $\beta(s, k) \rightarrow 0$ as $k \rightarrow \infty$;
- Composition of two functions $f: \mathbb{R}^n \rightarrow \mathbb{R}^m$ and $g: \mathbb{R}^v \rightarrow \mathbb{R}^n$ is denoted by $f \circ g$;
- For a function $f: \mathbb{R} \rightarrow \mathbb{R}$, the *right limit* of $f(x)$ as x approaches a is denoted by

$$f(a^+) \triangleq \lim_{x \rightarrow a^+} f(x).$$

In words: $f(a^+)$ is the value the function $f(x)$ approaches, if any, as x values larger than a get close to a ;

- For a function $f : \mathbb{R} \rightarrow \mathbb{R}$, the *left limit* of $f(x)$ as x approaches a is denoted by

$$f(a^-) \triangleq \lim_{x \rightarrow a^-} f(x).$$

In words: $f(a^-)$ is the value the function $f(x)$ approaches, if any, as x values smaller than a get close to a ;

- A function $f : \mathbb{R}^n \rightarrow \mathbb{R}^n$ is called *homogeneous* if

$$\forall \xi \in \mathbb{R}^n, \quad \forall h \in \mathbb{R}, \quad f(\xi + h) = f(\xi) + h;$$

- The space of continuously differentiable functions is denoted by C^1 ;
- A function $\phi : \mathbb{Z}_+ \rightarrow \mathbb{R}^n$, i.e. $\phi(k)$, is for shorthand notational purposes also denoted as ϕ_k ;
- The notation $\overline{\lim}_{k \rightarrow \infty} \phi_k$ is a shorthand notation for $\limsup_{k \rightarrow \infty} \phi_k$;
- For a function $\phi : \mathbb{Z}_+ \rightarrow \mathbb{R}^n$, $\|\phi\|$ is defined as

$$\|\phi\| \triangleq \sup_{k \in \mathbb{Z}_+} |\phi_k| \quad (\text{if it exists});$$

- For any $k \in \mathbb{Z}_+$ and any function $\phi : \mathbb{Z}_+ \rightarrow \mathbb{R}^n$, $\phi_{[k]}$ denotes the *truncation* of ϕ at k , i.e., $\phi_{[k]}(j) = \phi(j)$ if $j \in \mathbb{Z}_{[0,k]}$, and $\phi_{[k]}(j) = 0$ if $j \in \mathbb{Z}_{>k}$.
- For any $k \in \mathbb{Z}_+$ and any function $\phi : \mathbb{Z}_+ \rightarrow \mathbb{R}^n$, $\phi_{[k)}$ denotes the *pre-truncation* of ϕ at k , i.e., $\phi_{[k)}(j) = \phi(j)$ if $j \in \mathbb{Z}_{\geq k}$, and $\phi_{[k)}(j) = 0$ if $j \in \mathbb{Z}_{[0,k)}$.
- A function $q : \mathbb{X} \times \mathbb{S} \rightarrow \mathbb{R}^n$ with $\mathbb{X} \subseteq \mathbb{R}^{n_x}$ and $\mathbb{S} \subseteq \mathbb{R}^{n_s}$ is *Lipschitz continuous* with respect to x in the domain $\mathbb{X} \times \mathbb{S}$, if there exists a constant L_q such that for all $x^1, x^2 \in \mathbb{X}$ and for all $s \in \mathbb{S}$,

$$|q(x^1, s) - q(x^2, s)| \leq L_q |x^1 - x^2|. \quad (2.1)$$

The constant L_q is called the *Lipschitz constant* of q with respect to x .

- By the notation $\mathcal{F} : \mathbb{X} \leftrightarrow \mathbb{Y}$ for $\mathbb{X} \subseteq \mathbb{R}^{n_x}$ and $\mathbb{Y} \subseteq \mathbb{R}^{n_y}$, it is meant that \mathcal{F} is a set-valued function from \mathbb{X} to \mathbb{Y} , i.e. $\mathcal{F}(x) \subseteq \mathbb{Y}$ for each $x \in \mathbb{X}$.

Max-plus algebra

Define $\varepsilon \triangleq -\infty$ and denote $\mathbb{R}_\varepsilon \triangleq \mathbb{R} \cup \{\varepsilon\}$. For elements $x, y \in \mathbb{R}_\varepsilon$, one can define the operations max-plus addition, i.e. \oplus , and max-plus multiplication, i.e. \otimes as

$$x \oplus y \triangleq \max\{x, y\} \quad \text{and} \quad x \otimes y \triangleq x + y.$$

The set \mathbb{R}_ε together with the operations \oplus and \otimes is called *max-plus algebra* and is denoted by $\mathcal{R}_\varepsilon = (\mathbb{R}_\varepsilon, \oplus, \otimes, \varepsilon, 0)$. It can be shown that the max-plus algebra $\mathcal{R}_\varepsilon = (\mathbb{R}_\varepsilon, \oplus, \otimes, \varepsilon, 0)$ is an algebraic structure called *semiring*. That is, the sum \oplus is *associative* ($\forall a, b, c \in \mathbb{R}_\varepsilon, (a \oplus b) \oplus c = a \oplus (b \oplus c)$), *commutative* ($\forall a, b \in \mathbb{R}_\varepsilon, a \oplus b = b \oplus a$), *idempotent* ($\forall a \in \mathbb{R}_\varepsilon, a \oplus a = a$) and admits a *neutral* element ε ($\forall a \in \mathbb{R}_\varepsilon, a \oplus \varepsilon = a$). Furthermore, the product \otimes is associative, distributes over the sum ($\forall a, b, c \in \mathcal{R}_\varepsilon, (a \oplus b) \otimes c = (a \otimes c) \oplus (b \otimes c)$, $c \otimes (a \oplus b) = (c \otimes a) \oplus (c \otimes b)$), admits a neutral element 0 and ε is absorbing for the product ($\forall a \in \mathbb{R}_\varepsilon, a \otimes \varepsilon = \varepsilon$). The main reason to employ, in the max-plus algebra, the symbols \oplus and \otimes for max and +, from the ‘‘conventional’’ algebra, respectively, is the analogy that then arises with the conventional algebra, like eigenvectors and eigenvalues, etc.

For any $x \in \mathbb{R}_\varepsilon$ define

$$x^{\otimes k} \triangleq \underbrace{x \otimes x \otimes \dots \otimes x}_{k \text{ times}}, \quad \forall k \in \mathbb{Z}_{\geq 1}, \quad x^{\otimes 0} \triangleq 0.$$

Note that $x^{\otimes k}$ corresponds to kx in conventional algebra.

The set of $m \times n$ matrices with entries in \mathbb{R}_ε is denoted by $\mathbb{R}_\varepsilon^{m \times n}$. For matrices $A, B \in \mathbb{R}_\varepsilon^{m \times n}$ and $C \in \mathbb{R}_\varepsilon^{n \times p}$ one can extend the max-plus operations in the conventional manner.

$$(A \oplus B)_{ij} \triangleq A_{ij} \oplus B_{ij} = \max\{A_{ij}, B_{ij}\}, \quad \forall i \in \mathbb{Z}_{[1, m]}, j \in \mathbb{Z}_{[1, n]},$$

$$(A \otimes C)_{i\ell} \triangleq \bigoplus_{k=1}^n A_{ik} \otimes C_{k\ell} = \max_{k \in \mathbb{Z}_{[1, n]}} \{A_{ik} + C_{k\ell}\}, \quad \forall i \in \mathbb{Z}_{[1, m]}, \ell \in \mathbb{Z}_{[1, p]}.$$

The matrix $E \in \mathbb{R}_\varepsilon^{n \times n}$ is the identity matrix in max-plus algebra, i.e. $E_{ij} \triangleq 0$, for all $i \in \mathbb{Z}_{[1, n]}$ and $E_{ij} \triangleq \varepsilon$, for all $i \neq j$ and the ‘‘zero’’ matrix is denoted as \mathcal{E} where $\mathcal{E}_{ij} \triangleq \varepsilon$.

For any matrix $A \in \mathbb{R}_\varepsilon^{n \times n}$, the k^{th} max-plus power of A is denoted with

$$A^{\otimes k} \triangleq \underbrace{A \otimes A \otimes \dots \otimes A}_{k \text{ times}}, \quad \forall k \in \mathbb{Z}_{\geq 1}, \quad A^{\otimes 0} \triangleq E.$$

Moreover, define A^* , whenever it exists, by

$$A^* \triangleq \lim_{k \rightarrow \infty} E \oplus A \oplus \dots \oplus A^{\otimes k}. \quad (2.2)$$

The star operator as defined in (2.2) is also known as the *Kleene star* operator. Some properties of the Kleene star operator, if it exists, are: $\forall A, B \in \mathbb{R}_\varepsilon^{n \times n}$

$$(A^*)^* = A^*, \quad (2.3a)$$

$$A(BA)^* = (AB)^*A, \quad (2.3b)$$

$$(A \oplus B)^* = (A^*B)^*A^* = B^*(AB^*)^* = (A \oplus B)^*A^* = B^*(A \oplus B)^*, \quad (2.3c)$$

$$A^*A^* = A^*. \quad (2.3d)$$

Note that in above relations the operation \otimes is omitted for notational simplicity purposes.

The following statement is proven in [31].

Lemma 2.1.2 *Suppose that $A \in \mathbb{R}_\varepsilon^{n \times n}$ such that $A_{ij} < 0$ for all $i, j \in \mathbb{Z}_{[1,n]}$. Then the following relations hold:*

i)

$$\lim_{k \rightarrow \infty} A^{\otimes k} = \mathcal{E};$$

ii) *The matrix A^* defined in (2.2) exists and is given by*

$$A^* = E \oplus A \oplus \dots \oplus A^{\otimes n-1}.$$

A matrix $P \in \mathbb{R}_\varepsilon^{n \times n}$ is invertible in the max-plus algebraic sense if there exists a matrix $P^{\otimes -1} \in \mathbb{R}_\varepsilon^{n \times n}$ such that $P^{\otimes -1} \otimes P = P \otimes P^{\otimes -1} = E$.

Definition 2.1.3 Let $A \in \mathbb{R}_\varepsilon^{n \times n}$. Then, $\lambda \in \mathbb{R}_\varepsilon$ is a *max-plus eigenvalue* and $\eta \in \mathbb{R}_\varepsilon$ (where η has at least one finite entry) is a *max-plus eigenvector* if

$$A \otimes \eta = \lambda \otimes \eta.$$

Note that a square matrix might have more than one max-plus eigenvalue. The largest max-plus eigenvalue of a square matrix is denoted as λ^* . A matrix $A \in \mathbb{R}_\varepsilon^{n \times m}$ is *row-finite* if for any row $i \in \mathbb{Z}_{[1,n]}$,

$$\max_{j \in \mathbb{Z}_{[1,m]}} A_{ij} > \varepsilon.$$

Matrix $A \in \mathbb{R}_\varepsilon^{n \times m}$ is *column-finite* if for any column $j \in \mathbb{Z}_{[1,m]}$

$$\max_{i \in \mathbb{Z}_{[1,n]}} A_{ij} > \varepsilon.$$

The following statement is proven in [31].

Lemma 2.1.4 *Let $A \in \mathbb{R}_\varepsilon^{m \times n}$ be a matrix which is row-finite, then*

$$|(A \otimes x) - (A \otimes y)|_\infty \leq |x - y|_\infty, \quad \forall x, y \in \mathbb{R}^m.$$

Define the notation

$$x \oplus' \triangleq \min\{x, y\}, \quad \text{and} \quad x \otimes' y \triangleq x + y, \quad (2.4)$$

where the operations \otimes and \otimes' differ only in that $(-\infty) \otimes (+\infty) \triangleq -\infty$, while $(-\infty) \otimes' (+\infty) \triangleq +\infty$. The matrix multiplication and addition for (\oplus', \otimes') are defined similarly as to the case that one defined for (\oplus, \otimes) .

Some more basic max-plus algebraic results from [56, 29, 31] are

Lemma 2.1.5 *Suppose $A \in \mathbb{R}_\varepsilon^{n \times n}$ and $b \in \mathbb{R}_\varepsilon^m$. Then, the inequality*

$$A \otimes x \leq b$$

has the largest solution given by

$$\check{x} = (-A^\top) \otimes' b = -(A^\top \otimes (-b)).$$

By largest solution it is meant that for all x satisfying $A \otimes x \leq b$ one has that $x \leq \check{x}$.

Lemma 2.1.6 *Suppose $A \in \mathbb{R}_\varepsilon^{n \times n}$ and $b \in \mathbb{R}_\varepsilon^n$. If $A_{ij} \leq 0$ for all $i, j \in \mathbb{Z}_{[1, n]}$, then the equation*

$$x = A \otimes x \oplus b$$

has a solution

$$x = A^* \otimes b. \quad (2.5)$$

Furthermore, if $A_{ij} < 0$ for all $i, j \in \mathbb{Z}_{[1, n]}$, then the solution in (2.5) is unique

Lemma 2.1.7 *Suppose $A \in \mathbb{R}_\varepsilon^{n \times n}$ and $b \in \mathbb{R}_\varepsilon^n$. If A^* exists, then the “least solution” of the equation*

$$x = A \otimes x \oplus b \quad (2.6)$$

is given by

$$x = A^* \otimes b. \quad (2.7)$$

With the “least solution” is meant that for any other possible solution of (2.6), denoted by \tilde{x} , there holds $\tilde{x} \geq A^ \otimes b$.*

Residuation theory

Residuation allows one to define a (pseudo)-inverse operation in the max-plus algebra to solve an equation of for example type $a \otimes x = b$ with $a, b \in \mathbb{R}_\varepsilon$. In the sequel one will, for notational simplicity purposes, omitted \otimes . In the max-plus algebra, the left and right quotients are defined as follows

$$a \setminus b \triangleq \max \{x \mid ax \leq b\} \quad (2.8)$$

$$a / b \triangleq \max \{x \mid xb \leq a\} \quad (2.9)$$

$$a \setminus b / c \triangleq \max \{x \mid axc \leq b\} \quad (2.10)$$

Some examples of residuation in max-plus algebra are

$$\begin{aligned} a \setminus b &= b - a && \text{if } a \text{ and } b \text{ are finite,} \\ a \setminus (+\infty) &= (+\infty) && \text{for all } a, \\ a \setminus \varepsilon &= \varepsilon && \text{for all } a \text{ finite,} \\ \varepsilon \setminus a &= +\infty && \text{for all } a, \\ (+\infty) \setminus a &= \varepsilon && \text{if } a \neq +\infty. \end{aligned} \quad (2.11)$$

The left and right quotients defined for scalars in the max-plus algebra by (2.8), (2.9) and (2.10) can also be extended to matrices. Consider the following linear equations in $X \in \mathbb{R}_\varepsilon^{n \times m}$

$$AX = B, \quad XC = D, \quad AXC = F$$

where X, A, B, C, D and F are matrices in $\mathbb{R}_\varepsilon^{\bullet \times \bullet}$, where \bullet should be read as ‘‘appropriate dimensions’’. The left and right quotients for matrices are then defined as

$$A \setminus B \triangleq \bigvee \{X \mid AX \leq B\}, \quad (2.12a)$$

$$D / C \triangleq \bigvee \{X \mid XC \leq D\}, \quad (2.12b)$$

$$A \setminus F / C \triangleq \bigvee \{X \mid AXC \leq F\}, \quad (2.12c)$$

where \bigvee should be read as the ‘‘greatest’’. The following relations relate the residuation of matrices to scalars

$$\begin{aligned} (A \setminus B)_{ij} &\triangleq \min_k \{A_{ki} \setminus B_{kj}\}, \\ (D / C)_{ij} &\triangleq \min_\ell \{A_{i\ell} / C_{j\ell}\}, \\ (A \setminus F / C)_{ij} &\triangleq \min_{k\ell} \{A_{ki} \setminus F_{k\ell} / C_{j\ell}\}. \end{aligned}$$

Assume one has the following matrices $A \in \mathbb{R}_\varepsilon^{p \times n}$, $B \in \mathbb{R}_\varepsilon^{n \times p}$, $M \in \mathbb{R}_\varepsilon^{p \times p}$ and $N \in \mathbb{R}_\varepsilon^{n \times n}$. Then some properties of matrix residuation are

$$\begin{aligned}
 A \setminus A &= (A \setminus A)^* \\
 B / B &= (B / B)^* \\
 A \setminus (M^* A) &= (M^* A) \setminus (M^* A) = (A \setminus (M^* A))^* \\
 (AN^*) / A &= (AN^*) / (AN^*) = ((AN^*) / A)^*
 \end{aligned} \tag{2.13}$$

2.2 Lyapunov stability

The Lyapunov stability property of a continuous-time nonlinear systems, introduced in the work [38], is a well known system property studied in control systems theory. Practically, the goal of any controller design methodology is to obtain a closed-loop system which is at least Lyapunov stable. Examples of references where extensions of Lyapunov stability to discrete-time nonlinear systems have been considered are [57] and [58], whose work is summarized in [39]. Lyapunov stability for discrete-time systems became more important in control applications when digital computers came into the picture. Furthermore, an interesting property that is encountered in discrete-time, is that the candidate Lyapunov function, as in contrast to continuous-time, and the system dynamics do not necessarily have to be continuous. Only continuity at the equilibrium point is required. This is pointed-out and formally proven in [25]. This property is very interesting for hybrid systems, as in this case the system dynamics can be discontinuous. In this section the Lyapunov stability notion is formulated for the class of nonlinear difference inclusions that are allowed to be discontinuous.

Consider an autonomous system described by the following discrete-time nonlinear difference inclusion

$$x_{k+1} \in \mathcal{F}(x_k), \quad k \in \mathbb{Z}_+, \quad (2.14)$$

where $x_k \in \mathbb{R}^n$ is the state at discrete time $k \in \mathbb{Z}_+$, $\mathcal{F} : \mathbb{R}^n \rightrightarrows \mathbb{R}^n$ is a set-valued mapping that is allowed to be discontinuous and $\mathcal{F}(\xi) \neq \emptyset$ for all $\xi \in \mathbb{R}^n$. The latter condition guarantees that for each initial state x_0 at time $k = 0$ there exists a solution, not necessarily unique, to system (2.14). The set of corresponding solutions of the difference inclusion (2.14) is denoted by $\mathcal{S}_{\mathcal{F}}(x_0)$. Furthermore, a point $x_{eq} \in \mathbb{R}^n$ is an equilibrium point of system (2.14) if $\mathcal{F}(x_{eq}) = \{x_{eq}\}$.

Definition 2.2.1 Let $x_{eq} \in \mathbb{R}^n$ be an equilibrium point of system (2.14) and let $\mathcal{X} \subseteq \mathbb{R}^n$ be a set with $x_{eq} \in \text{int}(\mathcal{X})$. Then, the equilibrium point x_{eq} is

i) (*Lyapunov*) *stable* with respect to initial states x_0 in \mathcal{X} if for any $\varepsilon \in \mathbb{R}_{>0}$ there exists a $\delta = \delta(\varepsilon) \in \mathbb{R}_{>0}$ such that for each $x_0 \in \mathcal{X}$ all solutions $x \in \mathcal{S}_{\mathcal{F}}(x_0)$ satisfy the following implication

$$|x_0 - x_{eq}| \leq \delta \quad \Rightarrow \quad |x_k - x_{eq}| \leq \varepsilon, \quad \forall k \in \mathbb{Z}_+.$$

Or equivalently, see [59]:

(*Lyapunov*) *stable* with respect to initial states x_0 in \mathcal{X} if there exists a \mathcal{K} -function φ such that for each $x_0 \in \mathcal{X}$ all solutions $x \in \mathcal{S}_{\mathcal{F}}(x_0)$ satisfy

$$|x_k - x_{eq}| \leq \varphi(|x_0 - x_{eq}|), \quad \forall k \in \mathbb{Z}_+. \quad (2.15)$$

ii) *Attractive* with respect to initial states in \mathcal{X} if for each $x_0 \in \mathcal{X}$ all solutions $x \in \mathcal{S}_{\mathcal{F}}(x_0)$ satisfy

$$\overline{\lim}_{k \rightarrow \infty} |x_k - x_{eq}| = 0.$$

iii) *Asymptotically stable* with respect to initial states x_0 in \mathcal{X} if it is both (*Lyapunov stable* and *attractive*) for initial states x_0 in \mathcal{X} , respectively.

iv) *Exponentially stable* with respect to initial states x_0 in \mathcal{X} if there exists $K \in \mathbb{R}_{>0}$ and $\rho \in \mathbb{R}_{[0,1)}$ such that for each $x_0 \in \mathcal{X}$ all solutions $x \in \mathcal{S}_{\mathcal{F}}(x_0)$ satisfy

$$|x_k - x_{eq}| \leq K\rho^k |x_0 - x_{eq}|, \quad \forall k \in \mathbb{Z}_+.$$

Definition 2.2.2 A set $\mathcal{P} \subseteq \mathbb{R}^n$ is called *Positively Invariant* (PI) for system (2.14) if for all $\xi \in \mathcal{P}$ it holds that $\mathcal{F}(\xi) \subseteq \mathcal{P}$.

In the sequel sufficient conditions for the given stability properties in Definition 2.2.1 of an equilibrium point of the autonomous system, described by discrete-time nonlinear difference inclusion in (2.14), is formulated.

Theorem 2.2.3 Let $\mathcal{X} \subseteq \mathbb{R}^n$ be a bounded PI set for system (2.14) with $x_{eq} \in \text{int}(\mathcal{X})$ and let α_1, α_2 and α_3 be class \mathcal{K} -functions. Suppose there exists a function $V : \mathcal{X} \rightarrow \mathbb{R}_+$ with $V(x_{eq}) = 0$ such that for all $\xi \in \mathcal{X}$ the following inequalities hold

$$\alpha_1(|\xi - x_{eq}|) \leq V(\xi) \leq \alpha_2(|\xi - x_{eq}|), \quad (2.16a)$$

$$\sup_{\phi \in \mathcal{F}(\xi)} V(\phi) \leq V(\xi) - \alpha_3(|\xi - x_{eq}|). \quad (2.16b)$$

Then the following results hold:

i) The equilibrium point x_{eq} of system (2.14) is asymptotically stable with respect to initial states x_0 in \mathcal{X} .

ii) If the inequalities in (2.16) hold with $\alpha_1(s) \triangleq as^\lambda$, $\alpha_2(s) \triangleq bs^\lambda$ and $\alpha_3(s) \triangleq cs^\lambda$ for some constants $a, b, c, \lambda \in \mathbb{R}_{>0}$, then the equilibrium point x_{eq} of system (2.14) is exponentially stable with respect to initial states x_0 in \mathcal{X} .

Proof:

i) (*Lyapunov stability*): Let x_k represent a solution of (2.14) a time $k \in \mathbb{Z}_+$ obtained from the initial condition x_0 at time $k = 0$. Take a $\vartheta \in \mathbb{R}_{>0}$ such that the ball $\mathcal{B}_\vartheta(x_{eq}) \triangleq \{\xi \in \mathbb{R}^n \mid |\xi - x_{eq}| \leq \vartheta\}$ satisfies $\mathcal{B}_\vartheta(x_{eq}) \subseteq \mathcal{X}$. Since $\alpha_1, \alpha_2 \in \mathcal{K}$ one can choose for any $\varepsilon \in \mathbb{R}_{(0,\vartheta]}$ a $\delta \in \mathbb{R}_{(0,\varepsilon)}$ such that $\alpha_2(\delta) < \alpha_1(\varepsilon)$. Due to *positive invariance*

of \mathcal{X} , from (2.16a) and (2.16b) it then follows that for any $x_0 \in \mathcal{B}_\delta(x_{eq}) \subseteq \mathcal{X}$ all solutions $x \in \mathcal{S}_{\mathcal{F}}(x_0)$ satisfy

$$\dots \leq V(x_{k+1}) \leq V(x_k) \leq \dots \leq V(x_0) \leq \alpha_2(|x_0 - x_{eq}|) \leq \alpha_2(\delta) \leq \alpha_1(\varepsilon). \quad (2.17)$$

Since that, due to (2.16a), one has that $V(\xi) \geq \alpha_1(\varepsilon)$ for all $\xi \in \mathcal{X} \setminus \mathcal{B}_\varepsilon(x_{eq})$ it follows that for all $x_0 \in \mathcal{B}_\delta(x_{eq})$ all solutions $x \in \mathcal{S}_{\mathcal{F}}(x_0)$ satisfy $x_k \in \mathcal{B}_\varepsilon(x_{eq})$ for all $k \in \mathbb{Z}_+$. Hence, the equilibrium point x_{eq} of (2.14) is (Lyapunov) *stable*.

Attractivity: Since $\Delta(x_k) \triangleq V(x_{k+1}) - V(x_k) \leq 0$ and $V(\cdot)$ is lower bounded by zero, it follows that $\overline{\lim}_{k \rightarrow \infty} V(x_k) = V_L \geq 0$ exists. Then,

$$\overline{\lim}_{k \rightarrow \infty} \Delta V(x_k) = V_L - V_L = 0.$$

Since $0 \leq \alpha_3(|x_k - x_{eq}|) \leq \Delta V(x_k)$, it follows that

$$\overline{\lim}_{k \rightarrow \infty} \alpha_3(|x_k - x_{eq}|) = 0. \quad (2.18)$$

Assume by contradiction that for a solution x $|x_k - x_{eq}| \not\rightarrow 0$ for $k \rightarrow \infty$. Then there would exist a subsequence q , i.e. $q_\ell = x_{k+\ell}$ for $\ell \in \mathbb{Z}_+$ and some $k \in \mathbb{Z}_+$ such that $|q_\ell - x_{eq}| > \mu > 0$ for all $\ell \in \mathbb{Z}_+$, which by monotonicity and positivity of α_3 implies that $\alpha_3(|q_\ell - x_{eq}|) \leq \alpha_3(\mu) > 0$ for all $\ell \in \mathbb{Z}_+$. Hence, one reached a contradiction of convergence of $\alpha_3(|x_k - x_{eq}|)$ to zero as in (2.18). Hence, for each $x_0 \in \mathcal{X}$ all solutions $x \in \mathcal{S}_{\mathcal{F}}(x_0)$ satisfy

$$\overline{\lim}_{k \rightarrow \infty} |x_k - x_{eq}| = 0,$$

which implies that x_{eq} is *attractive* with respect to initial states in \mathcal{X} and thus, the equilibrium point x_{eq} of system (2.14) is *asymptotic stable* with respect to initial states in \mathcal{X} .

ii) Exponentially stability: Due to *positive invariance* of \mathcal{X} , from (2.16a) and (2.16b) it follows that for each $x_0 \in \mathcal{X}$ all solutions $x \in \mathcal{S}_{\mathcal{F}}(x_0)$ satisfy $V(x_k) \leq \alpha_2(|x_k - x_{eq}|)$ and $V(x_{k+1}) - V(x_k) \leq -\alpha_3(|x_k - x_{eq}|)$ for all $k \in \mathbb{Z}_+$. Then, one has that for all $k \in \mathbb{Z}_+$

$$V(x_{k+1}) - V(x_k) \leq -c|x_k - x_{eq}|^\lambda = -\frac{c}{b}\alpha_2(|x_k - x_{eq}|) \leq -\frac{c}{b}V(x_k).$$

This implies that for all $x_0 \in \mathcal{X}$

$$V(x_k) \leq \left(1 - \frac{c}{b}\right)^k V(x_0), \quad \forall k \in \mathbb{Z}_+.$$

To show that $\left(1 - \frac{c}{b}\right) \in \mathbb{R}_{[0,1]}$ the inequalities in (2.16) are employed, which yields

$$\begin{aligned} 0 \leq V(x_{k+1}) &\leq V(x_k) - c|x_k - x_{eq}|^\lambda \leq \\ &\leq \alpha_2(|x_k - x_{eq}|) - c|x_k - x_{eq}|^\lambda = (b - c)|x_k - x_{eq}|^\lambda. \end{aligned}$$

Hence, it follows that $c \in \mathbb{R}_{(0,b]}$. Then, one has that $\check{\rho} \triangleq (1 - \frac{c}{b}) \in \mathbb{R}_{(0,1)}$. From (2.16a) it follows that for all $x_0 \in \mathcal{X}$

$$a|x_k - x_{eq}|^\lambda \leq V(x_k) \leq \check{\rho}^k V(x_0) \leq \check{\rho}^k b|x_0 - x_{eq}|^\lambda, \quad \forall k \in \mathbb{Z}_+.$$

Hence, for all $x_0 \in \mathcal{X}$

$$|x_k - x_{eq}| \leq K\rho^k|x_0 - x_{eq}|, \quad \forall k \in \mathbb{Z}_+,$$

with

$$K \triangleq \left(\frac{b}{a}\right)^{\frac{1}{\lambda}} \in \mathbb{R}_{>0} \quad \text{and} \quad \rho \triangleq \check{\rho}^{\frac{1}{\lambda}} \in \mathbb{R}_{(0,1)}.$$

This means that the equilibrium point x_{eq} is *exponentially stable* with respect to initial states x_0 in \mathcal{X} . ■

Definition 2.2.4 A function $V(\cdot)$ that satisfies the hypothesis of Theorem 2.2.3 is called a *Lyapunov function*.

Another result that will be employed later in the thesis is the following converse Lyapunov statement, which is obtained in [60].

Theorem 2.2.5 Suppose $\mathcal{F}(x_k)$ in (2.14) is defined as

$$\mathcal{F}(x_k) = \{\Gamma(x_k)\}, \tag{2.19}$$

with $\Gamma : \mathbb{R}^n \rightarrow \mathbb{R}^n$ is Lipschitz continuous in the domain \mathbb{R}^n with Lipschitz constant L_Γ . Let x_{eq} be an equilibrium point of (2.14), i.e. $\Gamma(x_{eq}) = x_{eq}$, which is exponentially stable with respect to initial states x_0 in $\mathcal{X} = \mathbb{R}^n$. Then, there exists a Lipschitz continuous Lyapunov function $V(\cdot)$ and constants $a, b, c \in \mathbb{R}_{>0}$ and $\lambda \in \mathbb{R}_{\geq 1}$, such that for all $\xi \in \mathcal{X} = \mathbb{R}^n$

$$a|\xi - x_{eq}|^\lambda \leq V(\xi) \leq b|\xi - x_{eq}|^\lambda, \tag{2.20a}$$

$$V(\Gamma(\xi)) \leq V(\xi) - c|\xi - x_{eq}|^\lambda. \tag{2.20b}$$

Proof: Let x_k represent the solution of (2.14) at time k corresponding to initial state x_0 at time $k = 0$. As the system is *exponentially stable* with respect to initial states x_0 in \mathbb{R}^n , there exist constants $K \in \mathbb{R}_{>0}$ and $\rho \in \mathbb{R}_{(0,1)}$, such that

$$|x_{k+j} - x_{eq}| \leq K\rho^j|x_k - x_{eq}|, \quad \text{for all } x_k \in \mathbb{R}^n \quad \text{and } j, k \in \mathbb{Z}_+. \tag{2.21}$$

Choose N such that $K\rho^{N+1} < 1$, which is possible since $\rho < 1$. In the sequel it will be proven that the candidate Lyapunov function

$$V(x_k) = \sum_{j=k}^{k+N} |x_j - x_{eq}| \quad (2.22)$$

satisfies inequalities (2.20a) and (2.20b). The choice of the candidate Lyapunov function (2.22) immediately leads to

$$V(x_k) \leq K_1 |x_k - x_{eq}|, \quad \forall k \in \mathbb{Z}_+, \quad (2.23)$$

with $K_1 \triangleq K(1 + \rho + \rho^2 + \dots + \rho^N)$. Also

$$V(x_k) \geq |x_k - x_{eq}| \quad \forall k \in \mathbb{Z}_+. \quad (2.24)$$

Inequality (2.23) and (2.24) proves that (2.20a) is satisfied for the candidate Lyapunov function (2.22) for constants $a = 1$, $b = K_1$ and $\lambda = 1$. Next, for all $k \in \mathbb{Z}_+$ there holds

$$\begin{aligned} V(\Gamma(x_k)) - V(x_k) &= V(x_{k+1}) - V(x_k) = |x_{k+N+1} - x_{eq}| - |x_k - x_{eq}| \\ &\leq -K_2 |x_k - x_{eq}|, \end{aligned} \quad (2.25)$$

in which $K_2 \triangleq (1 - K\rho^{N+1}) \in \mathbb{R}_{>0}$ due to the fact that N is chosen such that $K\rho^{N+1} < 1$. Inequality in (2.25) proves that (2.20b) is satisfied for the candidate Lyapunov function (2.22) for $c = K_2$. Hence $V(\cdot)$ in (2.22) is a Lyapunov function.

To complete the proof, one has to show that the Lyapunov function in (2.22) is Lipschitz continuous in \mathbb{R}^n . Define

$$\Gamma^{(j)} \triangleq \underbrace{\Gamma \circ \Gamma \circ \dots \circ \Gamma}_{j \text{ times}}. \quad (2.26)$$

Utilizing the Lipschitz property of Γ , one has that for all $\xi_1, \xi_2 \in \mathbb{R}^n$ and $j \in \mathbb{Z}_{[1,N]}$ there holds

$$|\Gamma^{(j)}(\xi_1)| \leq L_\Gamma^j |\xi_1|, \quad \text{and} \quad |\Gamma^{(j)}(\xi_2)| \leq L_\Gamma^j |\xi_2|. \quad (2.27)$$

This leads to

$$\begin{aligned} V(\xi_1) - V(\xi_2) &= (|\xi_1 - x_{eq}| - |\xi_2 - x_{eq}|) + (|\Gamma(\xi_1) - x_{eq}| - |\Gamma(\xi_2) - x_{eq}|) + \dots + \\ &\quad (|\Gamma^{(N)}(\xi_1) - x_{eq}| - |\Gamma^{(N)}(\xi_2) - x_{eq}|) \\ &\leq |\xi_1 - \xi_2| + |\Gamma(\xi_1) - \Gamma(\xi_2)| + \dots + |\Gamma^{(N)}(\xi_1) - \Gamma^{(N)}(\xi_2)| \\ &\leq L_V |\xi_1 - \xi_2|, \end{aligned} \quad (2.28)$$

with the Lipschitz constant L_V defined as

$$L_V = 1 + L_\Gamma + \dots + L_\Gamma^N. \quad (2.29)$$

■

2.3 Input-to-state stability

For continuous-time nonlinear systems affected by *external disturbances*, the input-to-state stability (ISS) framework has been introduced in [40, 61, 62, 63, 64]. This framework generalizes the Lyapunov stability concept to systems affected by external disturbances, like measurement noise, uncertainty in models modeled by for example an external disturbance. Extensions of the input-to-state stability framework to discrete-time nonlinear systems has been developed recently in [41, 65, 66]. Similarly to the Lyapunov stability property, sufficient conditions for input-to-state stability can be derived in terms of a so-called candidate ISS Lyapunov function which must enjoy certain properties. In this chapter a particular case of the more general sufficient conditions of [41] is considered to establish explicit bounds on the evolution of the perturbed system's state. Furthermore, it will be shown that continuity at the equilibrium point alone, rather than continuity on a neighborhood of the equilibrium is sufficient for input-to-state stability for discrete-time systems. This has been pointed out in [25]. In this section the input-to-state stability notion, and a related notion known as input-to-output stability, is formulated for the class of nonlinear difference inclusions that are allowed to be discontinuous.

Consider a non-autonomous system described by the discrete-time nonlinear difference inclusion

$$x_{k+1} \in \mathcal{F}(x_k, v_k), \quad k \in \mathbb{Z}_+, \quad (2.30a)$$

$$y_k \in \mathcal{G}(x_k, v_k), \quad k \in \mathbb{Z}_+, \quad (2.30b)$$

where $x_k \in \mathcal{X} \subseteq \mathbb{R}^n$ is the state, $v_k \in \mathbb{V} \subseteq \mathbb{R}^{n_v}$ a disturbance and $y_k \in \mathbb{R}^{n_y}$ the output at discrete-time $k \in \mathbb{Z}_+$, respectively. The set \mathbb{V} is assumed to be a known set with $0 \in \mathbb{V}$. Furthermore, $\mathcal{F} : \mathcal{X} \times \mathbb{V} \rightrightarrows \mathcal{X}$ and $\mathcal{G} : \mathcal{X} \times \mathbb{V} \rightrightarrows \mathbb{R}^{n_y}$ are set-valued mappings with $\mathcal{F}(\xi, v) \neq \emptyset$ and $\mathcal{G}(\xi, v) \neq \emptyset$ for all $\xi \in \mathcal{X}$ and all $v \in \mathbb{V}$. Hence, for all $\xi \in \mathcal{X}$ and all $v \in \mathbb{V}$ one has that $\emptyset = \mathcal{F}(\xi, v) \subseteq \mathcal{X}$ which guarantees that for each initial state $x_0 \in \mathcal{X}$ at time $k = 0$ and disturbance function $v : \mathbb{Z}_+ \rightarrow \mathbb{V}$ there exists a global solution, not necessarily unique, to system (2.30). The set of corresponding solutions of the state and output of difference inclusion (2.30) is denoted by $\mathcal{S}_{\mathcal{F}}(x_0, v)$ and $\mathcal{S}_{\mathcal{F}\mathcal{G}}(x_0, v)$, respectively. A point $x_{eq} \in \mathcal{X}$ is an equilibrium point of system (2.30) if $\mathcal{F}(x_{eq}, 0) = \{x_{eq}\}$ and $\mathcal{G}(x_{eq}, 0) = \{y_{eq}\}$ for some $y_{eq} \in \mathbb{R}^{n_y}$. The condition $\mathcal{F}(\xi, v) \subseteq \mathcal{X}$ for all $\xi \in \mathcal{X}$ and all $v \in \mathbb{V}$ is related to robust positive invariance.

Definition 2.3.1 Given a disturbance set \mathbb{V} , a set $\mathcal{P} \in \mathbb{R}^n$ is called *Robust Positively Invariant* (RPI) for system (2.30) if for all $\xi \in \mathcal{P}$ it holds that $\mathcal{F}(\xi, v) \subseteq \mathcal{P}$ for all $v \in \mathbb{V}$.

Definition 2.3.2 For given sets $\widehat{\mathcal{X}} \subseteq \mathcal{X}$ and $\mathbb{V} \subseteq \mathbb{R}^{n_v}$, with $x_{eq} \in \text{int}(\widehat{\mathcal{X}})$, the equilibrium point x_{eq} is called

i) *Input-to-State Stable (ISS)* with respect to disturbances $v: \mathbb{Z}_+ \rightarrow \mathbb{V}$ and initial states x_0 in $\widehat{\mathcal{X}}$, if there exist a \mathcal{KL} -function β_x and a \mathcal{K} -function γ_x^v such that for each function $v: \mathbb{Z}_+ \rightarrow \mathbb{V}$ and each $x_0 \in \widehat{\mathcal{X}}$ all solutions $x \in \mathcal{S}_{\mathcal{F}}(x_0, v)$ satisfy

$$|x_k - x_{eq}| \leq \beta_x(|x_0 - x_{eq}|, k) + \gamma_x^v(\|v\|), \quad \forall k \in \mathbb{Z}_+. \quad (2.31)$$

ii) *Input-to-Output Stable (IOS)* with respect to disturbances $v: \mathbb{Z}_+ \rightarrow \mathbb{V}$ and initial states x_0 in $\widehat{\mathcal{X}}$, if there exist a \mathcal{KL} -function β_y and a \mathcal{K} -function γ_y^v such that for each function $v: \mathbb{Z}_+ \rightarrow \mathbb{V}$ and each $x_0 \in \widehat{\mathcal{X}}$ all solutions $y \in \mathcal{S}_{\mathcal{F}q}(x_0, v)$ satisfy

$$|y_k - y_{eq}| \leq \beta_y(|x_0 - x_{eq}|, k) + \gamma_y^v(\|v\|), \quad \forall k \in \mathbb{Z}_+. \quad (2.32)$$

In the remainder of the thesis γ_x^v and γ_y^v in (2.31) and (2.32) are referred to as the ISS- and IOS-gain of the system, respectively. To differentiate between various \mathcal{KL} - and \mathcal{K} -functions, we will adopt the convention to use sub- and superscripts to indicate between which variables the functions apply, e.g. γ_x^v indicates that it is an ISS-gain function from v to x .

Note that by causality of (2.30), the same definition of ISS would result if one would replace (2.31) by

$$|x_k - x_{eq}| \leq \beta_x(|x_0 - x_{eq}|, k) + \gamma_x^v(\|v_{[k-1]}\|), \quad \forall k \in \mathbb{Z}_+. \quad (2.33)$$

Remark 2.3.3 Note that in case the external disturbances $v: \mathbb{Z}_+ \rightarrow \mathbb{V}$ in (2.30) converges to zero, i.e. $v_k \rightarrow 0$ for (at least) $k \rightarrow \infty$, the input-to-state stability property of the equilibrium point $x_{eq} = 0$ for system (2.30) implies asymptotic stability of equilibrium point $x_{eq} = 0$.

Next, sufficient conditions for the input-to-state stability in Definition 2.3.2 of an equilibrium point of the non-autonomous system, described by discrete-time nonlinear difference inclusion in (2.30), is given.

Theorem 2.3.4 Let $\mathbb{V} \subseteq \mathbb{R}^{n_v}$. Moreover, let $\widehat{\mathcal{X}} \subseteq \mathcal{X}$ with $x_{eq} \in \text{int}(\widehat{\mathcal{X}})$ be an RPI set for system (2.30) perturbed by disturbance $v: \mathbb{Z}_+ \rightarrow \mathbb{V}$. Suppose $\alpha_1 \triangleq as^\lambda$, $\alpha_2 \triangleq bs^\lambda \in \mathcal{K}_\infty$ and $\alpha_3 \triangleq cs^\lambda \in \mathcal{K}$ for some constants $a, b, c, \lambda \in \mathbb{R}_{>0}$. Let $\sigma \in \mathcal{K}$ and suppose there exists a function $V: \widehat{\mathcal{X}} \rightarrow \mathbb{R}_+$ with $V(x_{eq}) = 0$ such that for all $\xi \in \widehat{\mathcal{X}}$ and all $v \in \mathbb{V}$ the following inequalities hold

$$\alpha_1(|\xi - x_{eq}|) \leq V(\xi) \leq \alpha_2(|\xi - x_{eq}|), \quad (2.34a)$$

$$\sup_{\phi \in \mathcal{F}(\xi, v)} V(\phi) \leq V(\xi) - \alpha_3(|\xi - x_{eq}|) + \sigma(|v|). \quad (2.34b)$$

Then, equilibrium point x_{eq} of system (2.30) is input-to-state stable with respect to disturbances $v: \mathbb{Z}_+ \rightarrow \mathbb{V}$ and initial states x_0 in $\widehat{\mathcal{X}}$. Furthermore, the ISS property of Definition 2.3.2 holds with

$$\beta_x(|\xi_0|, k) \triangleq \alpha_1^{-1}(2\rho^k \alpha_2(|\xi_0|)), \quad \gamma_x^v(\|v\|) \triangleq \alpha_1^{-1}(2\sigma(\|v\|) \frac{1}{1-\rho}), \quad (2.35)$$

where $\rho \triangleq (1 - \frac{c}{b}) \in \mathbb{R}_{(0,1)}$.

Proof: From the hypothesis one has that inequality (2.34a) holds for all $\xi \in \widehat{\mathcal{X}}$. Due to the fact that $V(\xi) \leq \alpha_2(|\xi - x_{eq}|)$ for all $\xi \in \widehat{\mathcal{X}}$ implies that

$$\frac{V(\xi)}{\alpha_2(|\xi - x_{eq}|)} \leq 1 \quad \text{for all } \xi \in \widehat{\mathcal{X}} \setminus \{x_{eq}\},$$

one obtains that

$$V(\xi) - \alpha_3(|\xi - x_{eq}|) \leq \left(1 - \frac{\alpha_3(|\xi - x_{eq}|)}{\alpha_2(|\xi - x_{eq}|)}\right) V(\xi) = \rho V(\xi), \quad \forall \xi \in \widehat{\mathcal{X}} \setminus \{x_{eq}\}, \quad (2.36)$$

where $\rho \triangleq 1 - \frac{c}{b}$. Next it will be shown that $\rho \in \mathbb{R}_{(0,1)}$. Since inequalities (2.34a) and (2.34b) hold for $v = 0$ it follows that for all $\xi \in \widehat{\mathcal{X}}$

$$0 \leq \sup_{\phi \in \mathcal{F}(\xi, 0)} V(\phi) \leq V(\xi) - c|\xi - x_{eq}| \leq (b-c)|\xi - x_{eq}|^\lambda.$$

Hence, $c \in \mathbb{R}_{(0,b]}$ and therefore $\rho \in \mathbb{R}_{(0,1)}$. Since $V(x_{eq}) - \alpha_3(|x_{eq} - x_{eq}|) = \rho V(x_{eq}) = 0$, one obtains, by utilizing (2.36), that $V(\xi) - \alpha_3(|\xi - x_{eq}|) \leq \rho V(\xi)$ for all $\xi \in \widehat{\mathcal{X}}$. Then,

$$V(x_{k+1}) \leq \sup_{\phi \in \mathcal{F}(x_k, v_k)} V(\phi) \leq \rho V(x_k) + \sigma(|v_k|), \quad \forall x_k \in \widehat{\mathcal{X}}, v_k \in \mathbb{V}, k \in \mathbb{Z}_+.$$

Due to *robust positive invariance* of $\widehat{\mathcal{X}}$ one can employ the above inequality repetitively, which yields

$$V(x_{k+1}) \leq \rho^{k+1} V(x_0) + \rho^k \sigma(|v_0|) + \rho^{k-1} \sigma(|v_1|) + \dots + \sigma(|v_k|),$$

for all $x_0 \in \widehat{\mathcal{X}}, v_k \in \mathbb{V}, k \in \mathbb{Z}_+$. Then, it follows that

$$\begin{aligned} \alpha_1(|x_{k+1} - x_{eq}|) &\leq V(x_{k+1}) \leq \rho^{k+1} \alpha_2(|x_0 - x_{eq}|) + \sum_{i=0}^k \rho^i \sigma(|v_{k-i}|) \\ &\leq \rho^{k+1} \alpha_2(|x_0 - x_{eq}|) + \sigma(\|v_{[k]}\|) \frac{1}{1-\rho}, \end{aligned}$$

for all $x_0 \in \widehat{\mathcal{X}}$, $v_{\langle k \rangle} \in \mathbb{V}^{k+1}$, $k \in \mathbb{Z}_+$. Taking into consideration that $\alpha_1 \in \mathcal{K}_\infty$ implies that α_1^{-1} is well-defined and is also of class \mathcal{K}_∞ and that $\sigma \in \mathcal{K}$ one obtains

$$\begin{aligned} |x_{k+1} - x_{eq}| &\leq \alpha_1^{-1} \left(\rho^{k+1} \alpha_2(|x_0 - x_{eq}|) + \sigma(\|v_{\langle k \rangle}\|) \frac{1}{1-\rho} \right) \\ &\leq \alpha_1^{-1} \left(2 \max \left(\rho^{k+1} \alpha_2(|x_0 - x_{eq}|), \sigma(\|v_{\langle k \rangle}\|) \frac{1}{1-\rho} \right) \right) \\ &\leq \alpha_1^{-1} \left(2\rho^{k+1} \alpha_2(|x_0 - x_{eq}|) \right) + \alpha_1^{-1} \left(2\sigma(\|v_{\langle k \rangle}\|) \frac{1}{1-\rho} \right), \end{aligned}$$

for all $x_0 \in \widehat{\mathcal{X}}$, $v_{\langle k \rangle} \in \mathbb{V}^{k+1}$, $k \in \mathbb{Z}_+$. In the sequel two situations are considered, namely $\rho = 0$ and $\rho \in \mathbb{R}_{(0,1)}$.

If $\rho = 0$ there holds

$$\begin{aligned} |x_k - x_{eq}| &\leq \alpha_1^{-1}(\sigma(\|v_{\langle k-1 \rangle}\|)) \leq \beta_x(|x_0 - x_{eq}|, k) + \alpha_1^{-1}(\sigma(\|v_{\langle k-1 \rangle}\|)) \\ &\leq \beta_x(|x_0 - x_{eq}|, k) + \alpha_1^{-1}(2\sigma(\|v_{\langle k-1 \rangle}\|)), \end{aligned}$$

for any $\beta_x \in \mathcal{KL}$, $k \in \mathbb{Z}_{\geq 1}$. By causality of the system (2.30a) one obtains

$$|x_k - x_{eq}| \leq \beta_x(|x_0 - x_{eq}|, k) + \alpha_1^{-1}(2\sigma(\|v\|)),$$

for any $\beta_x \in \mathcal{KL}$, $k \in \mathbb{Z}_+$.

For $\rho \in \mathbb{R}_{(0,1)}$, let $\beta_x(|x_0 - x_{eq}|, k) \triangleq \alpha_1^{-1}(2\rho^k \alpha_2(s))$. For a fixed $k \in \mathbb{Z}_+$, one has that $\beta_x(\cdot, k) \in \mathcal{K}$ due to $\alpha_2 \in \mathcal{K}_\infty$ and $\alpha_1^{-1} \in \mathcal{K}_\infty$ and $\rho \in \mathbb{R}_{(0,1)}$. For a fixed s , it follows that $\beta_x(s, \cdot)$ is non-increasing and $\lim_{k \rightarrow \infty} \beta_x(s, k) = 0$, due to $\rho \in \mathbb{R}_{(0,1)}$ and $\alpha_1^{-1} \in \mathcal{K}_\infty$. Therefore, it follows that $\beta_x \in \mathcal{KL}$.

Now let $\gamma_x^\nu(s) \triangleq \alpha_1^{-1}(2\sigma(s) \frac{1}{1-\rho})$. Since $\frac{1}{1-\rho} \in \mathbb{R}_{>0}$, it follows that $\gamma_x^\nu \in \mathcal{K}$ due to $\alpha_1^{-1} \in \mathcal{K}_\infty$ and $\sigma \in \mathcal{K}$. Hence, the equilibrium x_{eq} of system (2.30) is *input-to-state stable* with respect to disturbances $v: \mathbb{Z}_+ \rightarrow \mathbb{V}$ and initial states x_0 in \mathcal{X} in the sense of Definition 2.3.2, with β_x and γ_x^ν as given in (2.35). ■

Definition 2.3.5 A function $V: \widehat{\mathcal{X}} \rightarrow \mathbb{R}_+$ that satisfies the hypothesis of Theorem 2.3.4 is called an *ISS Lyapunov function*.

*Everything is vague to a degree
you do not realize till you have
tried to make it precise.*

Bertrand Russell

3

Nonlinear model predictive control: sub-optimality and robustness

One of the most studied properties of nonlinear model predictive control is the stability of the resulting closed-loop system. Perhaps the most embraced stabilization method is the so-called terminal cost and constraint set approach, see, for example, the survey [9] for an overview. This method uses the value function of the model predictive control cost functional as a candidate Lyapunov function for the closed-loop system and achieves stability via a particular terminal cost and an additional constraint on the terminal state, i.e. the predicted state at the end of the prediction horizon. Its advantage consists in the fact that initial feasibility of the optimization problem, which has to be solved at every sample instant in the nonlinear model predictive control strategy, implies *recursive feasibility* and, the finite horizon model predictive control cost can be a good approximation of the infinite horizon model predictive control costs. However, these properties are only guaranteed under the standing assumptions that a *global optimum* of the model predictive control optimization problem is attained at each sampling instant. Clearly, when dealing with nonlinear prediction models and hard constraints, it is difficult if not impossible to guarantee that this assumption holds in practice, where numerical solvers usually provide (in the limited computational time available) a feasible, sub-optimal control sequence as solution to the nonlinear model predictive control optimization problem. Such a sub-optimal control sequence needs to have certain properties to still guarantee stability of the to-be-controlled system in closed-loop with the model predictive controller. Therefore, in practice, there is a need for sub-optimal nonlinear model predictive control algorithms based on simpler optimization problems, which can be solved faster, and can still a priori guarantee stability.

An important result regarding sub-optimal nonlinear model predictive control was presented in [67], where it is shown that *feasibility* of the nonlinear model predictive

control optimization problem rather than optimality is sufficient for stability. To be precise, in [67], stability is achieved without requiring optimality via an additional constraint which forces the model predictive control value function to decrease at each sampling-instant. However, when nonlinear prediction models are employed, this constraint becomes highly nonlinear and difficult to implement from a computational point of view, as the model predictive control value function depends on the whole sequence of predicted future controls. Recursive feasibility is guaranteed for the nominal case in [67] by adding a terminal equality or inequality constraint. Regarding the model predictive control algorithms of [67], two issues remain to be investigated: how to guarantee robust stability for the closed-loop system and how to decrease the computational burden, so that implementation becomes possible for relatively fast systems, e.g. motion systems, or relatively complex systems such as for example manufacturing systems.

In this chapter a new method for the design of an input-to-state stabilizing sub-optimal model predictive control algorithm, which is computationally friendly, is proposed. This is achieved via new, simpler stabilizing constraints, that can be implemented as a finite number of linear inequalities. The proposed control design resorts to a (infinity) norm based *artificial* ISS Lyapunov function. The proposed input-to-state stabilizing model predictive control algorithm belongs to the category of *inherently* robust¹ model predictive controllers, as opposed to min-max model predictive control [9]. That is, the knowledge about disturbances is not taken into account when computing the model predictive control law. However, in the case of disturbances that take values in a bounded, polyhedral set, it is shown how the model predictive control scheme based on the proposed artificial ISS Lyapunov function can be modified to incorporate feedback to disturbances. This is achieved via additional constraints that allow for online optimization of the ISS-gain of the to-be-controlled system in closed-loop with the model predictive controller. The modified model predictive control algorithm results in better performance in the presence of disturbances, while the feedback input-to-state constraints can still be specified as a finite number of linear inequalities.

The chapter is organized as follows. First, a discrete-time nonlinear model predictive control formulation and terminologies are introduced in Section 3.1. In Section 3.2 the proposed computational friendly nonlinear (hybrid) model predictive controller is presented. In Section 3.3 the model predictive controller scheme presented in Section 3.2 is adopted such that the scheme can give feedback to disturbances which results in disturbance rejection properties of the closed-loop system. In Section 3.4 it is illustrated how the proposed nonlinear model predictive control scheme can be

¹By the *inherently* robustness property it is meant that a stabilizing controller has some robustness in the presence of arbitrarily small disturbances induced by for example model mismatch, etc.

employed to control a complex manufacturing system network in a decentralized way. In Section 3.5 a summary of the achievement obtained in the chapter are summarized.

3.1 A discrete-time MPC formulation

Consider the following nominal and perturbed discrete-time nonlinear systems

$$x_{k+1} = \bar{f}(x_k, u_k), \quad k \in \mathbb{Z}_+, \quad (3.1a)$$

$$\tilde{x}_{k+1} = f(\tilde{x}_k, u_k) + w_k, \quad k \in \mathbb{Z}_+, \quad (3.1b)$$

where $x_k, \tilde{x}_k \in \mathbb{R}^n$ and $u_k \in \mathbb{R}^m$ are the state and the control at discrete-time $k \in \mathbb{Z}_+$, respectively. Furthermore, $\bar{f} : \mathbb{R}^n \times \mathbb{R}^m \rightarrow \mathbb{R}^n$ and $f : \mathbb{R}^n \times \mathbb{R}^m \rightarrow \mathbb{R}^n$ are a possibly discontinuous nonlinear functions with $\bar{f}(0, 0) = 0$ and $f(0, 0) = 0$, i.e. $x_{eq} = 0$ is an equilibrium point for both (3.1a) and (3.1b) for $w = 0$ and $u = 0$. The vector $w_k \in \mathbb{W} \subseteq \mathbb{R}^n$ denotes an unknown additive disturbance and \mathbb{W} is assumed to be a known set. The nominal discrete-time nonlinear system (3.1a) will be used in a nonlinear model predictive control scheme to make an $N \in \mathbb{Z}_{\geq 1}$ time steps ahead prediction of the system's behavior. The system given by (3.1b) represents a perturbed discrete-time system to which the nonlinear model predictive controller based on the nominal model (3.1a) will be applied. Throughout the chapter it is assumed that the state and the controls are constrained for both systems (3.1a) and (3.1b) to some *compact* sets \mathbb{X} and \mathbb{U} , respectively, i.e.

$$u_k \in \mathbb{U} \subseteq \mathbb{R}^m, \quad x_k, \tilde{x}_k \in \mathbb{X} \subseteq \mathbb{R}^n, \quad \forall k \in \mathbb{Z}_+.$$

Furthermore, \mathbb{U} and \mathbb{X} are assumed to have zero in their interior, i.e. $0 \in \text{int}(\mathbb{U})$ and $0 \in \text{int}(\mathbb{X})$, respectively.

For a fixed $N \in \mathbb{Z}_{\geq 1}$, let

$$\mathbf{x}_k^{[1, N]}(\tilde{x}_k, \mathbf{u}_k^{[0, N-1]}) \triangleq [x_{k+1|k}^\top, \dots, x_{k+N|k}^\top]^\top$$

denote the state sequence generated by the nominal system (3.1a) from initial state $x_{k|k} \triangleq \tilde{x}_k$ at time $k \in \mathbb{Z}_+$ and by applying the control sequence

$$\mathbf{u}_k^{[0, N-1]} \triangleq [u_{k|k}^\top, \dots, u_{k+N-1|k}^\top]^\top \in \mathbb{U}^N.$$

The class of *admissible control sequences* defined with respect to the state $\tilde{x}_k \in \mathbb{X}$ is

$$\mathcal{N}_N(\tilde{x}_k) \triangleq \left\{ \mathbf{u}_k^{[0, N-1]} \in \mathbb{U}^N \mid \mathbf{x}_k^{[1, N]}(\tilde{x}_k, \mathbf{u}_k^{[0, N-1]}) \in \mathbb{X}^N \right\}.$$

Let $N \in \mathbb{Z}_{\geq 1}$ be given and let $F : \mathbb{R}^n \rightarrow \mathbb{R}_+$ with $F(0) = 0$ and $L : \mathbb{R}^n \times \mathbb{R}^m \rightarrow \mathbb{R}_+$ with $L(0, 0) = 0$ be continuous bounded mappings. At time $k \in \mathbb{Z}_+$, let $\tilde{x}_k \in \mathbb{X}$ be given.

The basic model predictive control scenario consists in minimizing, via optimization, at each time $k \in \mathbb{Z}_+$ a finite horizon cost function of the form

$$J(\tilde{x}_k, \mathbf{u}_k^{[0,N-1]}) \triangleq F(x_{k+N|k}) + \sum_{i=0}^{N-1} L(x_{k+i|k}, \mathbf{u}_{k+i|k}), \quad (3.2)$$

with prediction model (3.1a), over all sequences $\mathbf{u}_k^{[0,N-1]}$ in $\mathcal{U}_N(\tilde{x}_k)$. In the nonlinear model predictive control literature F , L and N are called the terminal cost, the stage cost and the prediction horizon, respectively. A state $\tilde{x}_k \in \mathbb{X}$ is called *feasible* if $\mathcal{U}_N(\tilde{x}_k) \neq \emptyset$. Let $\mathcal{X}_f(N) \subseteq \mathbb{X}$ denote the set of *feasible initial states* with respect to the mentioned optimization problem. Then $V_{\text{MPC}} : \mathcal{X}_f(N) \rightarrow \mathbb{R}_+$,

$$V_{\text{MPC}}(\tilde{x}_k) \triangleq \inf_{\mathbf{u}_k^{[0,N-1]} \in \mathcal{U}_N(\tilde{x}_k)} J(\tilde{x}_k, \mathbf{u}_k^{[0,N-1]}) \quad (3.3)$$

is the nonlinear model predictive control value function corresponding to the cost (3.2). If there exists an optimal sequence of controls

$$\mathbf{u}_k^{[0,N-1]*} \triangleq \left[\mathbf{u}_{k|k}^{*\top}, \mathbf{u}_{k+1|k}^{*\top}, \dots, \mathbf{u}_{k+N-1|k}^{*\top} \right]^\top$$

that minimizes (3.3), the infimum in (3.3) is a minimum and

$$V_{\text{MPC}}(\tilde{x}_k) = J(\tilde{x}_k, \mathbf{u}_k^{[0,N-1]*}). \quad (3.4)$$

In [68] one can find sufficient conditions for the existence of such an optimal sequence of controls. In case of an *unique* global optimum, the *optimal* model predictive control law is denoted by a map $\kappa^{\text{MPC}*} : \mathcal{X}_f(N) \rightarrow \mathbb{U}$, i.e.

$$u_k \triangleq u_{k|k}^* = \kappa^{\text{MPC}*}(\tilde{x}_k), \quad k \in \mathbb{Z}_+.$$

Stability, or stronger input-to-state stability, of the resulting model predictive control closed-loop system, i.e.

$$\tilde{x}_{k+1} = f(\tilde{x}_k, \kappa^{\text{MPC}*}(\tilde{x}_k)) + w_k, \quad w_k \in \mathbb{W} \subseteq \mathbb{R}^n, \quad k \in \mathbb{Z}_+, \quad (3.5)$$

is usually guaranteed by adding a particular constraint on the so-called *terminal state*, i.e. $x_{N|k}$, see, for example [9], [46] and [47]. Recall from the introduction of this chapter, that in practice numerical solvers usually provide a feasible, *sub-optimal* sequence

$$\bar{\mathbf{u}}_k^{[0,N-1]} \triangleq \left[\bar{\mathbf{u}}_{k|k}^\top, \bar{\mathbf{u}}_{k+1|k}^\top, \dots, \bar{\mathbf{u}}_{k+N-1|k}^\top \right]^\top,$$

with resulting value function

$$\bar{V}_{\text{MPC}}(\tilde{x}_k) \triangleq J(\tilde{x}_k, \bar{\mathbf{u}}_k^{[0,N-1]}).$$

Sub-optimality, but also the existence of a non-unique global optimum, induces possibly non-uniqueness of solutions to the optimization problem and therefore in that case the model predictive control law is denoted by a set-valued map $\kappa^{\text{MPC}} : \mathcal{X}_f(N) \leftrightarrow \mathbb{U}$ that is allowed to be discontinuous, i.e.

$$u_k \triangleq \bar{u}_{k|k} \in \kappa^{\text{MPC}}(\tilde{x}_k), \quad k \in \mathbb{Z}_+. \quad (3.6)$$

The *sub-optimal* model predictive control law (3.6), can be substituted in (3.1b) and yields closed-loop system

$$\tilde{x}_{k+1} \in f(\tilde{x}_k, \kappa^{\text{MPC}}(\tilde{x}_k)) + w_k \triangleq \mathcal{F}_w(\tilde{x}_k, w_k), \quad w_k \in \mathbb{W} \subseteq \mathbb{R}^n, \quad k \in \mathbb{Z}_+. \quad (3.7)$$

In the remainder of this chapter sub-optimal model predictive control is considered. In case of *sub-optimality*, stability of the model predictive control closed-loop system may be unclear, or may even be lost. Recall that one of the purposes of this chapter is to present a model predictive control design methodology which can, irrespective whether or not an optimal solution to the model predictive control optimization problem is found, a priori guarantee input-to-state stability.

A well known property, which is often employed to prove stability of model predictive control schemes, see for example [67], is *regularity* of the controller.

Definition 3.1.1 Let $N \in \mathbb{Z}_{\geq 1}$ be the prediction horizon of the model predictive controller. Then a model predictive controller is called *regular* over a certain horizon $N_r \in \mathbb{Z}_{[1, N]}$ if the *predicted* future controls, predicted by the model predictive controller over a horizon N_r , satisfy the following relation

$$\begin{aligned} |u_{k|k}|_p &\leq \theta_1 |x_{k|k}|_p, \\ |u_{k+i|k}|_p &\leq \theta_2 |x_{k|k}|_p, \quad \text{for } i = 1, \dots, N_r, \end{aligned} \quad (3.8)$$

with $\theta_1, \theta_2 \in \mathbb{R}_{>0}$.

3.2 Input-to-state stable nonlinear MPC

In the robust model predictive control literature there are several ways for designing robust model predictive controllers for perturbed nonlinear systems. One way is to rely on the inherent robustness properties of nominally stabilizing nonlinear model predictive controllers, e.g. which is done in [60, 69], however their results rely on the very strict assumption that the nonlinear model predictive control law is *Lipschitz* continuous. Another approach is to incorporate knowledge about the disturbances in the model predictive control problem formulation via open-loop worst case scenarios. This includes model predictive control algorithms based on open-loop min-max

optimization problems, e.g. see the survey [9]. To incorporate feedback to the disturbances, the closed-loop or feedback min-max model predictive control problem set-up has been introduced in [70] and further developed in [45, 71, 72]. The main drawback of min-max based model predictive control algorithms is the large online computational burden. Yet another approach to incorporate the robustness issue in the model predictive controller design is to synthesize model predictive controllers that, based on a nominal model of the system, render the closed-loop system input-to-state-stable. The input-to-state stability framework related to nonlinear model predictive control has been introduced first in [46]. One year later the input-to-state stability framework related to model predictive control for *linear* systems has been considered in [73]. In [46] a nonlinear model predictive control scheme is proposed to render closed-loop system (3.7) input-to-state stable with respect to *additive disturbances* w_k . A tightened constraint set approach is employed in [46] in order to ensure *recursive feasibility*. Furthermore, the input-to-state stability property of the closed-loop system is obtained using the so-called terminal cost and constraint set approach². This method uses the value function, i.e. (3.4), of the model predictive control cost as a candidate ISS Lyapunov function. However, as in the case of stabilizing model predictive control mentioned in the introductory part of this chapter, the terminal cost and constraint set approach to render the closed-loop system (3.7) input-to-state stable only works under the standing assumption that a *global* optimum of the model predictive control optimization problem is attained at each sampling instant. For the model predictive control approach that will be proposed in the sequel a *sub-optimal* or feasible solution to model predictive control optimization problem, instead of a global optimum, is sufficient to show input-to-state stability of the closed-loop system. Compared to the sub-optimal model predictive control scheme of [67], the proposed model predictive control scheme cannot guarantee that initial feasibility implies feasibility for all following sample instants, i.e. recursive feasibility. However, note that in this chapter systems perturbed by additive disturbances are considered. In this case, recursive feasibility is also not guaranteed for the algorithms of [67].

The material in this chapter is based on the work in [43, 44], however in this chapter a generalization of the model predictive controller design approach in [43, 44] is obtained. Furthermore, a proposal to reduce conservatism of the proposed model predictive control design approach is given. The model predictive controller design approach proposed in this chapter is based on the idea to resort to an *artificial* ISS Lyapunov function based approach. The artificial Lyapunov function based approach in model predictive control has been treated in, for example, [74] and [75] for control and state constrained linear discrete-time systems and for unconstrained nonlinear

²The so-called terminal cost and constraint set approach is also an embraced method for synthesizing stabilizing model predictive control schemes, see for example [9].

continuous-time systems, respectively. In [75] the so called artificial Lyapunov based approach is mentioned as the CLF (Control Lyapunov Function, see e.g. [76]) based approach. Furthermore, in [77] the approach is called the auxiliary Lyapunov-based approach. One of the key elements of the *artificial* Lyapunov approach is that one “artificially” imposes that a certain function is a Lyapunov function for the closed-loop system by introducing additional constraints to the model predictive control optimization problem. Opposed to the existing approaches in this section there are constraints impose to a model predictive controller such that a certain function is an ISS Lyapunov function instead of just a Lyapunov function. This consequentially guarantees robustness, i.e. input-to-state stability, of the closed-loop system with respect to additive disturbances.

Consider a candidate ISS Lyapunov function that satisfies the following assumption.

Assumption 3.2.1 Let $\mathbb{W} \subseteq \mathbb{R}^n$ with $0 \in \mathbb{W}$. Suppose $\alpha_1 \triangleq as^\lambda$ and $\alpha_2 \triangleq bs^\lambda \in \mathcal{K}_\infty$ for some constants $a, b, \lambda \in \mathbb{R}_{>0}$. Let $\alpha_V \in \mathcal{K}$ and $V : \mathbb{X} \rightarrow \mathbb{R}_+$ with $V(0) = 0$ be such that for all $\tilde{\xi} \in \mathbb{R}^n$ and $\omega \in \mathbb{W}$ the following inequalities and equality holds

$$\alpha_1(|\tilde{\xi}|) \leq V(\tilde{\xi}) \leq \alpha_2(|\tilde{\xi}|), \quad (3.9a)$$

$$V(\tilde{\xi} + \omega) \leq V(\tilde{\xi}) + V(\omega), \quad (3.9b)$$

$$\alpha_V(\tilde{\xi}) = \alpha_V(-\tilde{\xi}). \quad (3.9c)$$

Consider the following algorithm.

Algorithm 3.2.2

Step 1)

Given the state \tilde{x}_k at time $k \in \mathbb{Z}_+$, let $x_{k|k} \triangleq \tilde{x}_k$ and find a control sequence $\mathbf{u}_k^{[0, N-1]} \triangleq [u_{k|k}^\top, \dots, u_{k+N-1|k}^\top]^\top$ that satisfies

$$V(f(x_{k|k}, u_{k|k})) - V(x_{k|k}) \leq -\alpha_V(x_{k|k}), \quad (3.10a)$$

$$\mathbf{u}_k^{[0, N-1]} \in \mathcal{U}_N(\tilde{x}_k) \quad (3.10b)$$

and optionally also minimizes the cost $J(\tilde{x}_k, \mathbf{u}_k^{[0, N-1]})$ in (3.2).

Step 2)

Let

$$\kappa^{\text{MPC}}(\tilde{x}_k) \triangleq \left\{ u_{k|k} \in \mathbb{U} \mid \mathbf{u}_k^{[0, N-1]} \text{ satisfies (3.10)} \right\}.$$

Furthermore, let $\bar{\mathbf{u}}_k^{[0, N-1]} \triangleq [\bar{u}_{k|k}^\top, \dots, \bar{u}_{k+N-1|k}^\top]^\top$ with $\bar{u}_{k|k} \in \kappa^{\text{MPC}}(\tilde{x}_k)$ denote a feasible sequence of controls with respect to the optimization problem formulated at Step 1. Apply an input

$$u_k = \bar{u}_{k|k} \in \kappa^{\text{MPC}}(\tilde{x}_k)$$

to the perturbed system (3.1b), increment k by one and go to Step 1.

The following result can be obtained for nonlinear system (3.1b) in closed-loop with Algorithm 3.2.2 forming system (3.7).

Theorem 3.2.3 *Suppose Assumption 3.2.1 holds. Let $\mathcal{X}_f(N)$ be the set of states $\tilde{x}_k \in \mathbb{X}$ for which the optimization problem in Step 1 of Algorithm 3.2.2 is feasible and let $\tilde{\mathcal{X}}_f(N) \subseteq \mathcal{X}_f(N)$ be an RPI set with $0 \in \text{int}(\tilde{\mathcal{X}}_f(N))$ for closed-loop system (3.7) perturbed by additive disturbances $w : \mathbb{Z}_+ \rightarrow \mathbb{W}$. Then, equilibrium point $\tilde{x}_{eq} = 0$ of closed-loop system (3.7) is **input-to-state stable** with respect to disturbances $w : \mathbb{Z}_+ \rightarrow \mathbb{W}$ and initial states \tilde{x}_0 in $\tilde{\mathcal{X}}_f(N)$.*

Proof: The proof consists of showing that the ISS Lyapunov candidate in Assumption 3.2.1 is actually an ISS Lyapunov function for system (3.7). Note that inequality (3.9a) holds for all $\tilde{\xi} \in \mathbb{X}$. Hence, $V(\cdot)$ satisfies condition (2.34a) of Theorem 2.3.4. From constraint (3.10a) and using properties (3.9a), (3.9b) and (3.9c) from Assumption 3.2.1, one has that for all $\tilde{\xi} \in \tilde{\mathcal{X}}_f(N) \subseteq \mathbb{X}$, $\omega \in \mathbb{W}$ and any feasible $\bar{\mathbf{u}}_k^{[0, N-1]}$, or for any $\mu \in \kappa^{\text{MPC}}(\tilde{\xi})$:

$$\begin{aligned} V(f(\tilde{\xi}, \mu) + \omega) - V(\tilde{\xi}) &\leq V(f(\tilde{\xi}, \mu)) + V(\omega) - V(\tilde{\xi}) \\ &\leq -\alpha_V(\tilde{\xi}) + V(\omega) \\ &\leq -\alpha_3(|\tilde{\xi}|) + \sigma(|\omega|), \end{aligned} \tag{3.11}$$

where $\alpha_3(s) \triangleq \alpha_{Q_V}(s)$ where $\alpha_{Q_V}(s) \in \mathcal{K}$ is such that $\alpha_V(\tilde{\xi}) \geq \alpha_{Q_V}(|\tilde{\xi}|)$ for all $\tilde{\xi} \in \mathbb{R}^n$ and $\sigma(s) \triangleq \alpha_2(s)$. Since the last inequality in (3.11) holds for any $\mu \in \kappa^{\text{MPC}}(\tilde{\xi})$ one has that

$$\sup_{\phi \in \mathcal{F}_w(\tilde{\xi}, \omega)} V(\phi) \leq V(\tilde{\xi}) - \alpha_3(|\tilde{\xi}|) + \sigma(|\omega|)$$

for all $\tilde{\xi} \in \tilde{\mathcal{X}}_f(N)$, $\omega \in \mathbb{W}$. Hence, the statement of Theorem 3.2.3 then follows from Theorem 2.3.4. \blacksquare

Remark 3.2.4 Note if there are no additive disturbances present, i.e. $w = 0$, and V is a Lyapunov function under the *optimal* control, i.e. the optimal control obtained

under infinite horizon ($N = \infty$) model predictive control (without constrained (3.10a)), then Algorithm 3.2.2 can recover (for $N = \infty$) the performance of the optimal infinite horizon model predictive controller.

Remark 3.2.5 In Step 1 of Algorithm 3.2.2, one has to search for a feasible sequence of inputs, which is sufficient for guaranteeing input-to-state stability of the closed-loop system, as stated in Theorem 3.2.3. In other words, recursive feasibility implies input-to-state stability of the closed-loop system with respect to additive disturbances.

Selecting a function V in Algorithm 3.2.2 that satisfies Assumption 3.2.1 is critical, since it has a direct influence on the feasibility and performance of Algorithm 3.2.2. Furthermore, the structure of V also has a direct influence on the computational complexity of the optimization problem that is involved in Algorithm 3.2.2. A proposal to properly compute a V is explained next.

Let $Q_V \in \mathbb{R}^{q_v \times n}$ and $P_V \in \mathbb{R}^{p_v \times n}$ denote matrices with full-column rank. Suppose the function $\alpha_V(\cdot)$ in Assumption 3.2.1 is given by

$$\alpha_V(\tilde{x}_k) \triangleq |Q_V \tilde{x}_k|, \quad (3.12)$$

and $V(\cdot)$

$$V(\tilde{x}_k) \triangleq |P_V \tilde{x}_k|. \quad (3.13)$$

A direct consequence of the result in (3.2.3) is the following

Corollary 3.2.6 *Suppose $\alpha_V(\cdot)$ and $V(\cdot)$ are of the form as given in (3.12) and (3.13). Let $\mathcal{X}_f(N)$ be the set of states $\tilde{x}_k \in \mathbb{X}$ for which the optimization problem in Step 1 of Algorithm 3.2.2 is feasible and let $\tilde{\mathcal{X}}_f(N) \subseteq \mathcal{X}_f(N)$ be an RPI set with $0 \in \text{int}(\tilde{\mathcal{X}}_f(N))$ for closed-loop system (3.7) perturbed by additive disturbances $w : \mathbb{Z}_+ \rightarrow \mathbb{W}$. Then, equilibrium point $\tilde{x}_{eq} = 0$ of closed-loop system (3.7) is **input-to-state stable** with respect to disturbances $w : \mathbb{Z}_+ \rightarrow \mathbb{W}$ and initial states \tilde{x}_0 in $\tilde{\mathcal{X}}_f(N)$.*

Proof: Due to the fact that P_V has full-column rank, there exist $c_2 \geq c_1 > 0$ such that $c_1 |\tilde{\xi}|_p \leq |P_V \tilde{\xi}| \leq c_2 |\tilde{\xi}|$ for all $\tilde{\xi} \in \mathbb{R}^n$. Hence, $V(\cdot)$ satisfies condition (3.9a) in Assumption 3.2.1 for $\alpha_1(|\tilde{\xi}|) \triangleq c_1 |\tilde{\xi}|$ and $\alpha_2(|\tilde{\xi}|) \triangleq c_2 |\tilde{\xi}|$. Note by definition $V(\cdot)$ and $\alpha_V(\cdot)$ in (3.13) and (3.12) satisfy condition (3.9b) and (3.9c), respectively. The result in Corollary 3.2.6 then follows from the result in Theorem 3.2.3 with $\alpha_3 \triangleq \zeta_{Q_V} s$ ($\zeta_{Q_V} \in \mathbb{R}_{>0}$ is such that $|Q_V \tilde{\xi}| \geq \zeta_{Q_V} |\tilde{\xi}|$) and $\sigma(s) \triangleq c_2 s$. ■

With the result from Corollary 3.2.6 a constructive method for computing an ISS Lyapunov function $V(\cdot)$ of the particular form given in (3.13) *off-line* is presented. Let

$$x_{k+1} = Ax_k + Bu_k, \quad k \in \mathbb{Z}_+, \quad (3.14)$$

with $A \in \mathbb{R}^{n \times n}$, $B \in \mathbb{R}^{n \times m}$, be a linear *approximation* of (3.1b) around $(0, 0, 0)$, i.e. $A0 + B0 = f(0, 0)$ and in a neighborhood $\mathcal{N} \subset \mathbb{X}$ around $x = 0$ one has

$$Ax_k + Bu_k \approx f(x_k, u_k), \quad (3.15)$$

for all $x_k \in \mathcal{N}$ and $u_k \in \mathbb{U}$. In order to compute the matrices Q_V and P_V the following linear state-feedback $u_k = Kx_k$, $K \in \mathbb{R}^{m \times n}$, $k \in \mathbb{Z}_+$, is introduced. Then, the following result can be employed to find a matrix P_V , which then defines an ISS Lyapunov function of the form in (3.13) for the closed-loop system (3.7), with κ^{MPC} , derived from Algorithm 3.2.2.

Lemma 3.2.7 *Suppose that the matrices P_V , Q_V and K satisfy*

$$1 - |P_V(A + BK)P_V^{-L}| - |Q_V P_V^{-L}| \geq 0, \quad (3.16a)$$

$$P_V^\top P_V > 0, \quad (3.16b)$$

$$Q_V^\top Q_V > 0, \quad (3.16c)$$

where $P_V^{-L} \triangleq (P_V^\top P_V)^{-1} P_V^\top$ is a left Moore-Penrose inverse of P_V . Then, it holds that $|P_V(A + BK)\xi| - |P_V\xi| \leq -|Q_V\xi|$ for all ξ . Hence, the function $V(\tilde{x}_k) = |P_V\tilde{x}_k|$ is an ISS Lyapunov function for the closed-loop system $\tilde{x}_{k+1} = (A + BK)\tilde{x}_k + w_k$.

Proof: Inequalities (3.16b), (3.16c) guarantee that $\text{rank}(P_V) = \text{rank}(Q_V) = n$. Multiplication of (3.16a) with $|P_V\xi|$ yields

$$\begin{aligned} 0 &\leq |P_V\xi| - |P_V(A + BK)P_V^{-L}||P_V\xi| - |Q_V P_V^{-L}||P_V\xi|, \quad \forall \xi \\ &\leq |P_V\xi| - |P_V(A + BK)P_V^{-L}P_V\xi| - |Q_V P_V^{-L}P_V\xi|, \quad \forall \xi \quad \Rightarrow \\ &\Rightarrow |P_V\xi| - |P_V(A + BK)\xi| \leq -|Q_V\xi|, \quad \forall \xi. \end{aligned}$$

■

Numerically the matrices P_V , Q_V and K in (3.16) can be obtained by constructing, for example, a zero cost optimization problem, which can be solved with for example *fmincon* of Matlab or other nonlinear optimization tools. The nonlinear nature of the obtained optimization problem is not critical, since it is solved *off-line*.

Remark 3.2.8 The hypothesis of Theorem 3.2.3 and Corollary 3.2.6 assume robust feasibility of the problem in Step 1 of Algorithm 3.2.2, which cannot be guaranteed a priori in general. In practice, the constraint $x_{k+1|k} \in \mathbb{X} \sim \mathbb{W}$ can be added to the optimization problem to ensure that the closed-loop system's state, i.e. $\tilde{x}_{k+1} = x_{k+1|k} + w_k$, $k \in \mathbb{Z}_+$, does not violate the state constraints at time $k + 1$ for any disturbance in \mathbb{W} .

Computational aspects

In this subsection it is shown that the norm based artificial ISS Lyapunov function defined in (3.13) has some nice advantages when it comes to computational issues of the proposed model predictive controller defined in Algorithm 3.2.2. The standing assumption throughout this section is that every vector norm $|\cdot|$ is an *infinity* norm $|\cdot|_{p=\infty}$. Note that this assumption can be made without loss of generality of the results presented so far in this chapter.

Corollary 3.2.9 *Suppose $\alpha_V(\cdot)$ and $V(\cdot)$ in Assumption 3.2.1 are of the form as given in (3.12) and (3.13). Consider infinity norms ($p = \infty$) and assume the sets \mathbb{X} , \mathbb{U} (and \mathbb{W}) are polyhedral. Furthermore, let the functions $F(x)$ and $L(x, u)$, defining the model predictive control cost (3.2), be defined as*

$$F(x) \triangleq |Px|_\infty \quad \text{and} \quad L(x, u) \triangleq |Qx|_\infty + |R_u u|_\infty,$$

where $P \in \mathbb{R}^{n_p \times n}$, $Q \in \mathbb{R}^{n_q \times n}$ and $R_u \in \mathbb{R}^{r_u \times m}$ are assumed to be known matrices that have full-column rank, i.e. $F(x)$ and $L(x, u)$ are therefore bounded mappings on the domains \mathbb{X} and $\mathbb{X} \times \mathbb{U}$, respectively. Then,

i) if the system (3.1b) and the prediction model (3.1a) are affine with respect to the control u , i.e.

$$x_{k+i+1|k} = \bar{f}(x_{k+i|k}, u_{k+i|k}) = \bar{f}^1(x_{k+i|k}) + \bar{f}^2(x_{k+i|k})u_{k+i|k}, \quad i = 0, \dots, N-1, \quad (3.17)$$

and

$$f(\tilde{x}_k, u_k) = f^1(\tilde{x}_k) + f^2(\tilde{x}_k)u_k, \quad k \in \mathbb{Z}_+ \quad (3.18)$$

with $f^1: \mathbb{R}^n \rightarrow \mathbb{R}^n$, $f^2: \mathbb{R}^n \rightarrow \mathbb{R}^{n \times m}$, $\bar{f}^1: \mathbb{R}^n \rightarrow \mathbb{R}^n$ and $\bar{f}^2: \mathbb{R}^n \rightarrow \mathbb{R}^{n \times m}$ possibly discontinuous mappings then, for $N = 1$, the optimization problem that has to be solved at Step 1 of Algorithm 3.2.2 can be formulated as a **linear program**;

ii) if the system (3.1b) is affine with respect to the control u , i.e. as in (3.18), and if prediction model (3.1a) is a well-posed piecewise affine system³ (e.g. a well-posed piecewise affine approximation of (3.18)), i.e.

$$\bar{f}^1(x_{k+i|k}) = A^j x_{k+i|k} + b^j, \quad \bar{f}^2(x_{k+i|k}) = B^j, \quad \text{when } x_{k+i|k} \in \Omega_j, \quad (3.19)$$

where $A^j \in \mathbb{R}^{n \times n}$, $B^j \in \mathbb{R}^{n \times m}$, $b^j \in \mathbb{R}^n$, $j \in \mathcal{S}$ with $\mathcal{S} \triangleq \mathbb{Z}_{[1,s]}$, for some $s \in \mathbb{Z}_{>1}$, is a finite set of indices, then, for $N \in \mathbb{Z}_{>1}$, the optimization problem that has to be solved at Step 1 of Algorithm 3.2.2 can be formulated as a **mixed integer linear program**;

³A piecewise affine system $x_{k+1} = A^j x_k + B^j u_k + b^j$ for $x_k \in \Omega_j$ is called well-posed if for specified x_k and u_k , x_{k+1} is uniquely defined.

- iii) if the system (3.1b) is affine with respect to the control u , i.e. as in (3.18), and if prediction model (3.1a) in Algorithm 3.2.2 is replaced by a linearization of (3.1b) (if it exists) around the state \tilde{x}_k at time $k \in \mathbb{Z}_+$ and the zero control or u_{k-1} , i.e.

$$x_{k+i+1|k} = \mathcal{A}(\tilde{x}_k)x_{k+i|k} + \bar{f}^2(\tilde{x}_k)u_{k+i|k}, \quad i = 0, \dots, N-1, \quad (3.20)$$

where $\mathcal{A}(\tilde{x}_k) \triangleq \frac{\partial(f^1(\tilde{x})+f^2(\tilde{x})u)}{\partial \tilde{x}} \Big|_{\tilde{x}=\tilde{x}_k, u=0 \text{ or } u=u_{k-1}}$, then, for $N \in \mathbb{Z}_{>1}$, the optimization problem that has to be solved at Step 1 of Algorithm 3.2.2 can be formulated as a **linear program**;

- iv) if the system (3.18) and the prediction model (3.17) are linear with respect to the control, i.e. $f^2(\tilde{x}_k) = B \in \mathbb{R}^{n \times m}$ and $\bar{f}^2(\tilde{x}_k|k) = \bar{B} \in \mathbb{R}^{n \times m}$, then, for $N = 1$, the optimization problem that has to be solved at Step 1 of Algorithm 3.2.2 can be formulated as solving a **multi-parametric linear program**. Furthermore, the model predictive control law $u_k = \kappa^{\text{MPC}}(\tilde{x}_k)$ can be obtained explicitly and is of the form

$$u_k = K^j \begin{bmatrix} \bar{f}^1(\tilde{x}_k) \\ f^1(\tilde{x}_k) \\ \tilde{x}_k \\ |P_V \tilde{x}_k|_\infty - |Q_V \tilde{x}_k|_\infty \end{bmatrix} + q^j, \quad \text{if } C^j \begin{bmatrix} \bar{f}^1(\tilde{x}_k) \\ f^1(\tilde{x}_k) \\ \tilde{x}_k \\ |P_V \tilde{x}_k|_\infty - |Q_V \tilde{x}_k|_\infty \end{bmatrix} \leq c^j, \quad (3.21)$$

$j \in \mathcal{S}^K$ where $\mathcal{S}^K \triangleq \mathbb{Z}_{[1,s]}$, for some $s \in \mathbb{Z}_{>0}$. The index set \mathcal{S}^K and matrices $K^j \in \mathbb{R}^{m \times (3n+1)}$, $q^j \in \mathbb{R}^m$, $C^j \in \mathbb{R}^{n_c \times (3n+1)}$ and $c^j \in \mathbb{R}^{n_c}$ result from the to be solved multi-parametric linear program;

- v) if the system (3.18) and the prediction model (3.17) are linear with respect to the control, i.e. $f^2(\tilde{x}_k) = \bar{f}^2(x_{k|k}) = B \in \mathbb{R}^{n \times m}$, and if

$$\bar{f}^1(x_{k+i|k}) = Ax_{k+i|k},$$

where $A \triangleq \frac{\partial f^1(\tilde{x})}{\partial \tilde{x}} \Big|_{\tilde{x}=0}$ (if it exists), then, for $N \in \mathbb{Z}_{>1}$, the optimization problem that has to be solved at Step 1 of Algorithm 3.2.2 can be formulated as solving a **multi-parametric linear program**. Furthermore, the model predictive control law $u_k = \kappa^{\text{MPC}}(\tilde{x}_k)$ can be obtained explicitly and is of the form

$$u_k = K^j \begin{bmatrix} f^1(\tilde{x}_k) \\ \tilde{x}_k \\ |P_V \tilde{x}_k|_\infty - |Q_V \tilde{x}_k|_\infty \end{bmatrix} + q^j, \quad \text{if } C^j \begin{bmatrix} f^1(\tilde{x}_k) \\ \tilde{x}_k \\ |P_V \tilde{x}_k|_\infty - |Q_V \tilde{x}_k|_\infty \end{bmatrix} \leq c^j, \quad (3.22)$$

$j \in \mathcal{S}^K$ where $\mathcal{S}^K \triangleq \mathbb{Z}_{[1,s]}$, for some $s \in \mathbb{Z}_{>0}$. The index set \mathcal{S}^K and matrices $K^j \in \mathbb{R}^{m \times (2n+1)}$, $q^j \in \mathbb{R}^m$, $C^j \in \mathbb{R}^{n_c \times (2n+1)}$ and $c^j \in \mathbb{R}^{n_c}$ result from the to be solved multi-parametric linear program;

Proof: For the system dynamics of the form (3.18), the function V in (3.10a) defined as in (3.13) and considering infinity norms ($p = \infty$), one can rewrite inequality (3.10a), for any fixed $x_{k|k}$, as a set of linear constraints with respect to $u_{k|k}$. Indeed, inequality (3.10a) can be written as

$$|P_V(f^1(x_{k|k}) + f^2(x_{k|k})u_{k|k})|_\infty \leq \vartheta(x_{k|k}), \quad (3.23)$$

where

$$\vartheta(x_{k|k}) \triangleq |P_V x_{k|k}|_\infty - |Q_V x_{k|k}|_\infty.$$

By definition of $|\cdot|_\infty$ inequality (3.23) can be equivalently expressed as

$$-\mathbf{1}^{p_v} \vartheta(x_{k|k}) \leq \pm P_V(f^1(x_{k|k}) + f^2(x_{k|k})u_{k|k}),$$

or

$$\begin{bmatrix} P_V f^2(x_{k|k}) \\ -P_V f^2(x_{k|k}) \end{bmatrix} u_{k|k} \leq \begin{bmatrix} -P_V \\ P_V \end{bmatrix} f^1(x_{k|k}) + \begin{bmatrix} \mathbf{1}^{p_v} \\ \mathbf{1}^{p_v} \end{bmatrix} \vartheta(x_{k|k}), \quad (3.24)$$

where $\mathbf{1}^{p_v}$ is a shorthand notation for $\mathbf{1}^{p_v} = [1, \dots, 1]^\top \in \mathbb{R}^{p_v}$. Hence, inequality (3.24) is, for any fixed $x_{k|k}$, linear with respect to $u_{k|k}$.

According to the hypothesis in Corollary 3.2.9 the constraint sets \mathbb{X} and \mathbb{U} are polyhedral, i.e.

$$\mathbb{X} \triangleq \{\xi \in \mathbb{R}^n \mid A_X \xi \leq b_X\},$$

$$\mathbb{U} \triangleq \{\mu \in \mathbb{R}^m \mid A_U \mu \leq b_U\},$$

with real valued matrices A_X , b_X , A_U and b_U having appropriate dimensions. Therefore one has that

$$\begin{aligned} A_X x_{k+i|k} &\leq b_X, \quad i = 0, \dots, N-1, \\ A_U u_{k+i|k} &\leq b_U, \quad i = 0, \dots, N-1. \end{aligned} \quad (3.25)$$

Note that for the prediction model as defined in (3.17) and for $F = |P x_{k+N|k}|_\infty$ and $L = |Q x_{k+i|k}|_\infty + |R u_{k+i|k}|_\infty$ with $i = 0, \dots, N-1$, as defined in the Corollary 3.2.9, Step 1 in Algorithm 3.2.2 can be formulated as solving the following optimization problem

$$\min_{\mathbf{u}_k^{[0,N-1]}, \varepsilon_{Q,i}, \varepsilon_{R,u,i}} \left\{ \varepsilon + \sum_{i=0}^{N-1} \varepsilon_{Q,i} + \sum_{i=0}^{N-1} \varepsilon_{R,u,i} \right\}, \quad (3.26)$$

subject to:

$$-\mathbf{1}^{np} \boldsymbol{\varepsilon} \leq -P x_{k+N|k}, \quad \boldsymbol{\varepsilon} \geq 0, \quad (3.27a)$$

$$-\mathbf{1}^{np} \boldsymbol{\varepsilon} \leq P x_{k+N|k}, \quad (3.27b)$$

$$-\mathbf{1}^{nq} \boldsymbol{\varepsilon}_{Q,i} \leq -Q x_{k+i|k}, \quad \boldsymbol{\varepsilon}_{Q,i} \geq 0, \quad i = 0, \dots, N-1, \quad (3.27c)$$

$$-\mathbf{1}^{nq} \boldsymbol{\varepsilon}_{Q,i} \leq Q x_{k+i|k}, \quad i = 0, \dots, N-1, \quad (3.27d)$$

$$-\mathbf{1}^{ru} \boldsymbol{\varepsilon}_{R_u,i} \leq -R_u u_{k+i|k}, \quad \boldsymbol{\varepsilon}_{R_u,i} \geq 0, \quad i = 0, \dots, N-1, \quad (3.27e)$$

$$-\mathbf{1}^{ru} \boldsymbol{\varepsilon}_{R_u,i} \leq R_u u_{k+i|k}, \quad i = 0, \dots, N-1, \quad (3.27f)$$

$$x_{k+i+1|k} = \bar{f}^1(x_{k+i|k}) + \bar{f}^2(x_{k+i|k}) u_{k+i|k}, \quad i = 0, \dots, N-1, \quad (3.27g)$$

$$\text{inequality (3.25) and (3.24).} \quad (3.27h)$$

For $N = 1$ one can, by substitution of (3.27g) in (3.27a) and (3.27b), rewrite optimization problem defined by (3.26) and (3.27) in the following form

$$\min_{u_{k|k}, \boldsymbol{\varepsilon}_{Q,0}, \boldsymbol{\varepsilon}, \boldsymbol{\varepsilon}_{R_u,0}} \left\{ \boldsymbol{\varepsilon} + \boldsymbol{\varepsilon}_{Q,0} + \boldsymbol{\varepsilon}_{R_u,0} \right\}, \quad (3.28)$$

subject to:

$$A_{LP1}(x_{k|k}) \begin{bmatrix} u_{k|k} & \boldsymbol{\varepsilon}_{Q,0} & \boldsymbol{\varepsilon} & \boldsymbol{\varepsilon}_{R_u,0} \end{bmatrix}^\top \leq b_{LP1}(x_{k|k}), \quad (3.29)$$

where

$$A_{LP1}(x_{k|k}) = \begin{bmatrix} 0 & -\mathbf{1}^{nq} & 0 & 0 \\ 0 & -\mathbf{1}^{nq} & 0 & 0 \\ P\bar{f}^2(x_{k|k}) & 0 & -\mathbf{1}^n & 0 \\ -P\bar{f}^2(x_{k|k}) & 0 & -\mathbf{1}^n & 0 \\ R_u & 0 & 0 & -\mathbf{1}^{ru} \\ -R_u & 0 & 0 & -\mathbf{1}^{ru} \\ 0 & -1 & 0 & 0 \\ 0 & 0 & -1 & 0 \\ 0 & 0 & 0 & -1 \\ P_V f^2(x_{k|k}) & 0 & 0 & 0 \\ -P_V f^2(x_{k|k}) & 0 & 0 & 0 \\ A_X \bar{f}^2(x_{k|k}) & 0 & 0 & 0 \\ A_U & 0 & 0 & 0 \end{bmatrix}, \quad b_{LP1}(x_{k|k}) = \begin{bmatrix} -Q x_{k|k} \\ Q x_{k|k} \\ -P \bar{f}^1(x_{k|k}) \\ P \bar{f}^1(x_{k|k}) \\ 0 \\ 0 \\ 0 \\ 0 \\ 0 \\ -P_V f^1(x_{k|k}) + \mathbf{1}^{pv} \vartheta(x_{k|k}) \\ P_V f^1(x_{k|k}) + \mathbf{1}^{pv} \vartheta(x_{k|k}) \\ b_X - A_X \bar{f}^1(x_{k|k}) \\ b_U \end{bmatrix},$$

which can, for all fixed $x_{k|k}$, be recognized as a *linear programming* problem. This proves item i) from Corollary 3.2.9.

In case the prediction model (3.27g) is replaced by a linearization of (3.27g) around the (measured) state $x_{k|k} \triangleq \tilde{x}_k$, i.e. (3.20), one can, for $N \in \mathbb{Z}_{>1}$, rewrite the

optimization problem defined by (3.26) and (3.27) in the following form

$$\mathbf{u}_k^{[0,N-1]} \min_{\varepsilon, \mathcal{E}_{Q,i}, \varepsilon, \mathcal{E}_{R_u,i}} \left\{ \varepsilon + \sum_{i=0}^{N-1} \mathcal{E}_{Q,i} + \sum_{i=0}^{N-1} \mathcal{E}_{R_u,i} \right\}, \quad (3.30)$$

subject to:

$$A_{LPN}(x_{k|k}) \begin{bmatrix} \mathbf{u}_k^{[0,N-1]\top} \\ [\varepsilon_{Q,0}, \dots, \varepsilon_{Q,N-1}, \varepsilon]^\top \\ [\varepsilon_{R_u,0}, \dots, \varepsilon_{R_u,N-1}]^\top \end{bmatrix} \leq b_{LPN}(x_{k|k}), \quad (3.31)$$

where

$$\overbrace{A_{LPN}(x_{k|k})}^{\triangleq} = \begin{bmatrix} \pm \begin{bmatrix} 0 \\ \tilde{Q}H(x_{k|k}) \\ \pm \text{di}([R_u]_N) \\ 0 \\ 0 \\ P_V f^2(x_{k|k}) \tilde{I}_m \\ -P_V f^2(x_{k|k}) \tilde{I}_m \\ \text{di}([A_X]_N)H(x_{k|k}) \\ \text{di}([A_U]_N) \end{bmatrix} & \begin{bmatrix} \text{di}([-1^{n_q}]_N) & 0 \\ 0 & -1^{n_p} \end{bmatrix} & 0 \\ & 0 & \text{di}([-1^{r_u}]_N) \\ & -I_{(N+1)} & 0 \\ & 0 & -I_N \\ & 0 & 0 \\ & 0 & 0 \\ & 0 & 0 \\ & 0 & 0 \\ & 0 & 0 \end{bmatrix}, \quad \overbrace{b_{LPN}(x_{k|k})}^{\triangleq} = \begin{bmatrix} \pm \begin{bmatrix} -Qx_{k|k} \\ -\tilde{Q}\Phi(x_{k|k})x_{k|k} \\ 0 \\ 0 \\ 0 \\ -P_V f^1(x_{k|k}) + \mathbf{1}^{p_v} \vartheta(x_{k|k}) \\ P_V f^1(x_{k|k}) + \mathbf{1}^{p_v} \vartheta(x_{k|k}) \\ \tilde{b}_X - \text{di}([A_X]_N)\Phi(x_{k|k})x_{k|k} \\ \tilde{b}_U \end{bmatrix} \end{bmatrix},$$

with

$$\Phi(x_{k|k}) \triangleq \begin{bmatrix} \mathcal{A}(x_{k|k}) \\ \mathcal{A}^2(x_{k|k}) \\ \vdots \\ \mathcal{A}^N(x_{k|k}) \end{bmatrix}, \quad H(x_{k|k}) \triangleq \begin{bmatrix} \tilde{f}^2(x_{k|k}) & 0 & \dots & 0 \\ \mathcal{A}(x_{k|k})\tilde{f}^2(x_{k|k}) & \ddots & \ddots & \vdots \\ \vdots & \ddots & \ddots & 0 \\ \mathcal{A}(x_{k|k})^{N-1}\tilde{f}^2(x_{k|k}) & \dots & \mathcal{A}(x_{k|k})\tilde{f}^2(x_{k|k}) & \tilde{f}^2(x_{k|k}) \end{bmatrix},$$

$$\tilde{Q} \triangleq \begin{bmatrix} \text{di}([Q]_{\bar{N}}) & 0 \\ 0 & P \end{bmatrix}, \quad \tilde{b}_X \triangleq \begin{bmatrix} b_X \\ \vdots \\ b_X \end{bmatrix}, \quad \tilde{b}_U \triangleq \begin{bmatrix} b_U \\ \vdots \\ b_U \end{bmatrix}, \quad \tilde{I}_m \triangleq [I_m \ 0 \ \dots \ 0] \quad \text{and} \quad \bar{N} \triangleq N-1.$$

Note that optimization problem defined by (3.30) and (3.29) is a *linear programming* problem for all fixed $x_{k|k}$. Hence, item iii) from Corollary 3.2.9 is proven.

Since the prediction model (3.1a), i.e. (3.27g), in item ii) of Corollary 3.2.9 is assumed to be a well-posed piecewise affine system and the input and state constraint sets \mathbb{U} and \mathbb{X} are assumed to be compact, one can equivalently rewrite the piecewise affine prediction model into a mixed logical dynamical (MLD) form, i.e.

$$x_{k+i+1|k} = Mx_{k+i|k} + G^u u_{k+i|k} + G^d \delta_{k+i|k} + G^z z_{k+i|k}, \quad i = 0, \dots, N-1, \quad (3.32a)$$

$$E^x x_{k+i|k} + E^u u_{k+i|k} + E^d \delta_{k+i|k} + E^z z_{k+i|k} \leq g, \quad i = 0, \dots, N-1, \quad (3.32b)$$

where $\delta_{k+i|k} \in \{0, 1\}^{n_\delta}$ and $z_{k+i|k} \in \mathbb{R}^{n_z}$ are binary and real valued auxiliary variables, respectively. This statement follows directly from proposition 4 in [78], which is

proven in [79]. Note that as mixed logical dynamical models only allow for non-strict inequalities in (3.32b), rewriting a discontinuous piecewise affine system as a mixed logical dynamical system strict inequalities like $x_{k+i|k} < 0$ must be approximated by $x_{k+i|k} \leq -\varsigma$ for some $\varsigma > 0$ (typically the machine (computer) precision), with the assumption that $-\varsigma < x_{k+i|k} < 0$ cannot occur due to the finite number of bits used for representing real numbers. Note that no problem exists when the piecewise affine model is continuous, where the strict inequality can in this case be equivalently rewritten as non-strict, i.e. $\varsigma = 0$. See [24] for more details. Define

$$\mathbf{d}_k^{[0,N-1]} \triangleq \left[\delta_{k|k}^\top, \delta_{k+1|k}^\top, \dots, \delta_{k+N-1|k}^\top \right]^\top,$$

and

$$\mathbf{z}_k^{[0,N-1]} \triangleq \left[z_{k|k}^\top, z_{k+1|k}^\top, \dots, z_{k+N-1|k}^\top \right]^\top.$$

Replacing equality (3.27g) by equality (3.32a) and add inequality (3.32b) to the optimization problem defined by (3.26), (3.27a), (3.27b), (3.27c), (3.27d), (3.27e), (3.27f), (3.32a) and (3.27h) yields the following optimization problem.

$$\min_{\mathbf{u}_k^{[0,N-1]}, \boldsymbol{\varepsilon}_{Q,i}, \boldsymbol{\varepsilon}, \boldsymbol{\varepsilon}_{R_u,i}, \mathbf{d}_k^{[0,N-1]}, \mathbf{z}_k^{[0,N-1]}} \left\{ \boldsymbol{\varepsilon} + \sum_{i=0}^{N-1} \boldsymbol{\varepsilon}_{Q,i} + \sum_{i=0}^{N-1} \boldsymbol{\varepsilon}_{R_u,i} \right\}, \quad (3.33)$$

subject to:

$$A_{MILPN}(x_{k|k}) \begin{bmatrix} \mathbf{u}_k^{[0,N-1]\top} & [\boldsymbol{\varepsilon}_{Q,0}, \dots, \boldsymbol{\varepsilon}_{Q,N-1}, \boldsymbol{\varepsilon}]^\top \\ [\boldsymbol{\varepsilon}_{R_u,0}, \dots, \boldsymbol{\varepsilon}_{R_u,N-1}]^\top & \mathbf{d}_k^{[0,N-1]\top} & \mathbf{z}_k^{[0,N-1]\top} \end{bmatrix}^\top \leq b_{MILPN}(x_{k|k}), \quad (3.34)$$

where

$$A_{MILPN}(x_{k|k}) \triangleq \begin{bmatrix} \pm \begin{bmatrix} 0 \\ \tilde{Q}H^u \end{bmatrix} & \begin{bmatrix} \text{di}([-1^u]_N) & 0 \\ 0 & -\mathbf{1}^{np} \end{bmatrix} & 0 & \pm \begin{bmatrix} 0 \\ \tilde{Q}H^d \end{bmatrix} & \pm \begin{bmatrix} 0 \\ \tilde{Q}H^z \end{bmatrix} \\ \pm \text{di}([R_u]_N) & 0 & \text{di}([-1^u]_N) & 0 & 0 \\ 0 & -I_{(N+1)} & 0 & 0 & 0 \\ 0 & 0 & -I_N & 0 & 0 \\ P_V f^2(x_{k|k}) \tilde{I}_m & 0 & 0 & 0 & 0 \\ -P_V f^2(x_{k|k}) \tilde{I}_m & 0 & 0 & 0 & 0 \\ \text{di}([A_X]_N) H^u & 0 & 0 & \text{di}([A_X]_N) H^d & \text{di}([A_X]_N) H^z \\ \text{di}([A_U]_N) & 0 & 0 & 0 & 0 \\ \text{di}([E^u]_N) + \text{di}([E]_N) \overline{H}^u & 0 & 0 & \text{di}([E^d]_N) + \text{di}([E]_N) \overline{H}^d & \text{di}([E^z]_N) + \text{di}([E]_N) \overline{H}^z \end{bmatrix}$$

$$\begin{aligned}
 & \underbrace{b_{\text{MILPN}}(x_{k|k}) \triangleq}_{\substack{\pm \begin{bmatrix} -Qx_{k|k} \\ -\tilde{Q}\Phi_M x_{k|k} \\ 0 \\ 0 \\ 0 \\ -P_V f^1(x_{k|k}) + \mathbf{1}^{p_V} \vartheta(x_{k|k}) \\ P_V f^1(x_{k|k}) + \mathbf{1}^{p_V} \vartheta(x_{k|k}) \\ \tilde{b}_X - \text{di}([A_X]_N)\Phi_M x_{k|k} \\ \tilde{b}_U \\ \tilde{g} - \text{di}([E]_N)\overline{\Phi}_M x_{k|k} \end{bmatrix}}} \\
 & \quad , \quad \text{with } \overline{H}^e \triangleq \begin{bmatrix} 0 & \dots & \dots & \dots & 0 \\ G^e & \ddots & & & \vdots \\ MG^e & \ddots & \ddots & & \vdots \\ \vdots & \ddots & \ddots & \ddots & \vdots \\ M^{N-2}G^e & \dots & MG^e & G^e & 0 \end{bmatrix} \quad e \in \{u, d, z\}, \\
 & H^e \triangleq \begin{bmatrix} G^e & 0 & \dots & 0 \\ MG^e & \ddots & \ddots & \vdots \\ \vdots & \ddots & \ddots & 0 \\ M^{N-1}G^e & \dots & MG^e & G^e \end{bmatrix} \quad e \in \{u, d, z\}, \quad \Phi_M \triangleq \begin{bmatrix} M \\ M^2 \\ \vdots \\ M^N \end{bmatrix}, \quad \overline{\Phi}_M \triangleq \begin{bmatrix} I_n \\ M \\ M^2 \\ \vdots \\ M^{N-1} \end{bmatrix}, \quad \text{and } \tilde{g} \triangleq \begin{bmatrix} g \\ \vdots \\ g \end{bmatrix}.
 \end{aligned}$$

Note that optimization problem defined by (3.33) and (3.34) is, for all fixed $x_{k|k}$, a *mixed integer linear programming* problem. Hence, this concludes the proof of item ii) from Corollary 3.2.9.

If $f^2(x_{k|k}) = B$ holds, then, the optimization problem defined by (3.28) and (3.29) can be rewritten as

$$\min_{u_{k|k}, \varepsilon_{Q,0}, \varepsilon, \varepsilon_{R_u,0}} \left\{ \varepsilon + \varepsilon_{Q,0} + \varepsilon_{R_u,0} \right\}, \quad (3.35)$$

subject to:

$$A_{\text{mpLPI}} \begin{bmatrix} u_{k|k}^\top & \varepsilon_{Q,0} & \varepsilon & \varepsilon_{R_u,0} \end{bmatrix}^\top \leq b_{\text{mpLPI}} + W_{\text{mpLPI}} \theta_k, \quad (3.36)$$

with $\theta_k \triangleq [\theta^1 \top \theta^2 \top x_{k|k}^\top \theta^4 \top]^\top \in \mathbb{R}^{3n+1} \subseteq \mathbb{O}_1 \times \mathbb{O}_2 \times \mathbb{X} \times \mathbb{O}_4$, where

$$\mathbb{O}_1 \triangleq \left\{ \zeta \in \mathbb{R}^n \mid \zeta = \overline{f}^1(\xi), \quad \xi \in \mathbb{X} \right\}, \quad (3.37a)$$

$$\mathbb{O}_2 \triangleq \left\{ \zeta \in \mathbb{R}^n \mid \zeta = f^1(\xi), \quad \xi \in \mathbb{X} \right\}, \quad (3.37b)$$

$$\mathbb{O}_4 \triangleq \left\{ \zeta \in \mathbb{R} \mid \zeta = \vartheta(\xi), \quad \xi \in \mathbb{X} \right\}, \quad (3.37c)$$

$$A_{\text{mpLP1}} \triangleq \begin{bmatrix} 0 & -\mathbf{1}^{n_q} & 0 & 0 \\ 0 & -\mathbf{1}^{n_q} & 0 & 0 \\ P\bar{B} & 0 & -\mathbf{1}^n & 0 \\ -P\bar{B} & 0 & -\mathbf{1}^n & 0 \\ R_u & 0 & 0 & -\mathbf{1}^{r_u} \\ -R_u & 0 & 0 & -\mathbf{1}^{r_u} \\ 0 & -1 & 0 & 0 \\ 0 & 0 & -1 & 0 \\ 0 & 0 & 0 & -1 \\ P_V B & 0 & 0 & 0 \\ -P_V B & 0 & 0 & 0 \\ A_X \bar{B} & 0 & 0 & 0 \\ A_U & 0 & 0 & 0 \end{bmatrix}, b_{\text{mpLP1}} \triangleq \begin{bmatrix} 0 \\ 0 \\ 0 \\ 0 \\ 0 \\ 0 \\ 0 \\ 0 \\ 0 \\ 0 \\ 0 \\ b_X \\ b_U \end{bmatrix}, W_{\text{mpLP1}} \triangleq \begin{bmatrix} 0 & 0 & -Q & 0 \\ 0 & 0 & Q & 0 \\ -P & 0 & 0 & 0 \\ P & 0 & 0 & 0 \\ 0 & 0 & 0 & 0 \\ 0 & 0 & 0 & 0 \\ 0 & 0 & 0 & 0 \\ 0 & 0 & 0 & 0 \\ 0 & 0 & 0 & 0 \\ 0 & -P_V & 0 & \mathbf{1}^{p_v} \\ 0 & P_V & 0 & \mathbf{1}^{p_v} \\ -A_X & 0 & 0 & 0 \\ 0 & 0 & 0 & 0 \end{bmatrix}.$$

Note that problem defined by (3.35) and (3.36) is a *multi-parametric linear programming problem*. If problem defined by (3.35) and (3.36) is solvable on the domain $\mathbb{O}_1 \times \mathbb{O}_2 \times \mathbb{X} \times \mathbb{O}_4$, then it is well known that the solution, i.e. $\left[u_{k|k}^* \ \varepsilon_{Q,0}^* \ \varepsilon^* \ \varepsilon_{R_u,0}^* \right]^\top$ is a piecewise affine function of the parameters in θ_k . Hence, the control $u_k \triangleq u_{k|k}^*$ is solved explicitly and is given by

$$u_k = K^j \theta_k + q^j, \quad \text{if } C^j \theta_k \leq c^j, \quad j \in \mathcal{S}^K, \quad (3.38)$$

where $\mathcal{S}^K \triangleq \mathbb{Z}_{[1,s]}$, for some $s \in \mathbb{Z}_{>0}$ and matrices $K^j \in \mathbb{R}^{m \times (3n+1)}$, $q^j \in \mathbb{R}^m$, $C^j \in \mathbb{R}^{n_c \times (3n+1)}$ and $c^j \in \mathbb{R}^{n_c}$ follow by solving the multi-parametric linear programming problem defined by (3.35) and (3.36). Note that the parameters in θ_k are related to $x_{k|k} = \tilde{x}_k$ as follows

$$\theta_k \triangleq \begin{bmatrix} \bar{f}^1(\tilde{x}_k) \\ f^1(\tilde{x}_k) \\ \tilde{x}_k \\ |P_V \tilde{x}_k|_\infty - |Q_V \tilde{x}_k|_\infty \end{bmatrix}. \quad (3.39)$$

Substitution of (3.39) in (3.38) yields (3.21) and concludes the proof of item iv) from Corollary 3.2.9.

If $f^2(\tilde{x}) = \bar{f}^2(x_{k|k}) = B \in \mathbb{R}^{n \times m}$, then, the optimization problem defined by (3.30) and (3.31) can be rewritten as

$$\min_{\mathbf{u}_k^{[0,N-1]}, \varepsilon_{Q,i}, \varepsilon, \varepsilon_{R_u,i}} \left\{ \varepsilon + \sum_{i=0}^{N-1} \varepsilon_{Q,i} + \sum_{i=0}^{N-1} \varepsilon_{R_u,i} \right\}, \quad (3.40)$$

subject to:

$$A_{\text{mpLPN}}(x_{k|k}) \left[\mathbf{u}_k^{[0,N-1]\top} \quad [\varepsilon_{Q,0}, \dots, \varepsilon_{Q,N-1}, \varepsilon]^\top \quad [\varepsilon_{R_u,0}, \dots, \varepsilon_{R_u,N-1}]^\top \right]^\top \leq b_{\text{mpLPN}} + W_{\text{mpLPN}} \theta_k, \quad (3.41)$$

with $\theta_k \triangleq [\theta^{2\top} \ x_{k|k} \ \theta^{4\top}]^\top \in \mathbb{R}^{(2n+1)} \subseteq \mathbb{O}_2 \times \mathbb{X} \times \mathbb{O}_4$, where \mathbb{O}_2 and \mathbb{O}_4 are defined as in (3.37b) and (3.37c), respectively. Furthermore, A_{mpLPN} is obtained by substitution of $\bar{f}^2(x_{k|k})$, $f^2(x_{k|k})$

and $\mathcal{A}(x_{k|k})$ in A_{LPN} , $\Phi(x_{k|k})$ and $H(x_{k|k})$ by matrices B , B and A , respectively. The matrices b_{mpLPN} and W_{mpLPN} in (3.41) are defined as

$$b_{mpLPN} \triangleq \begin{bmatrix} 0 \\ 0 \\ 0 \\ 0 \\ 0 \\ 0 \\ 0 \\ 0 \\ 0 \\ \tilde{b}_X \\ \tilde{b}_U \end{bmatrix}, \quad W_{mpLPN} \triangleq \begin{bmatrix} 0 & -Q & 0 \\ 0 & -\tilde{Q}\Phi & 0 \\ 0 & \tilde{Q} & 0 \\ 0 & \tilde{Q}\Phi & 0 \\ 0 & 0 & 0 \\ 0 & 0 & 0 \\ 0 & 0 & 0 \\ -P_V & 0 & \mathbf{1}^{p_v} \\ P_V & 0 & \mathbf{1}^{p_v} \\ 0 & -\text{di}([A_X]_N)\Phi & 0 \\ 0 & 0 & 0 \end{bmatrix}.$$

Note that problem defined by (3.40) and (3.41) is a *multi-parametric linear programming problem*. If problem defined by (3.40) and (3.41) is solvable on the domain $\mathbb{O}_2 \times \mathbb{X} \times \mathbb{O}_4$, then it is well known that the solution, i.e.

$$\begin{bmatrix} \mathbf{u}_k^{[0,N-1]*\top} \\ \left[\boldsymbol{\varepsilon}_{Q,0}^*, \dots, \boldsymbol{\varepsilon}_{Q,N-1}^*, \boldsymbol{\varepsilon}^* \right]^\top \\ \left[\boldsymbol{\varepsilon}_{R_u,0}^*, \dots, \boldsymbol{\varepsilon}_{R_u,N-1}^* \right]^\top \end{bmatrix}^\top$$

is a piecewise affine function of the parameters in θ_k . Hence, the control $u_k \triangleq u_{k|k}^*$ is solved explicitly and is given by

$$u_k = K^j \theta_k + q^j, \quad \text{if } C^j \theta_k \leq c^j, \quad j \in \mathcal{S}^K, \quad (3.42)$$

where $\mathcal{S}^K \triangleq \mathbb{Z}_{[1,s]}$, for some $s \in \mathbb{Z}_{>0}$ and matrices $K^j \in \mathbb{R}^{m \times (2n+1)}$, $q^j \in \mathbb{R}^m$, $C^j \in \mathbb{R}^{n_c \times (2n+1)}$ and $c^j \in \mathbb{R}^{n_c}$ follow by solving the multi-parametric linear programming problem defined by (3.40) and (3.41). Note that the parameters in θ_k are related to $x_{k|k} = \tilde{x}_k$ as follows

$$\theta_k \triangleq \begin{bmatrix} f^1(\tilde{x}_k) \\ \tilde{x}_k \\ |P_V \tilde{x}_k|_\infty - |Q_V \tilde{x}_k|_\infty \end{bmatrix}. \quad (3.43)$$

Substitution of (3.43) in (3.42) yields (3.22) and concludes the proof of item v) from Corollary 3.2.9. ■

Reducing conservatism

The proposed model predictive control scheme given in Algorithm 3.2.2 with $V(\cdot)$ defined as in is based on a *common* ISS Lyapunov function of the form given in (3.13). The common ISS Lyapunov function is computed based on a linear *approximation* of the system dynamics (3.1b). Due to the fact that a *common* ISS Lyapunov approach based on a linear *approximation* of the system dynamics (3.1b) is employed, constraint

(3.10a) in combination with (3.13) might be conservative. That is, the input-to-state stabilizing constraint in (3.10a) in combination with (3.13) might, due to conservativeness induced by the common ISS Lyapunov (3.13) function approach, deteriorate performance of the model predictive control algorithm. In this section an altered version of Algorithm 3.2.2 is presented, for a slightly stricter class of systems, in which conservativeness of constraint (3.10a) can be reduced. The subclass of systems in (3.1b) that is considered is defined as

$$\tilde{x}_{k+1} = f(\tilde{x}_k, u_k) + w_k \triangleq g^j(\tilde{x}_k, u_k) + w_k \quad \text{when } \tilde{x}_k \in \Omega_j, \quad k \in \mathbb{Z}_+ \quad (3.44)$$

where $j \in \mathcal{S}$ with $\mathcal{S} \triangleq \mathbb{Z}_{[1,s]}$, for some $s \in \mathbb{Z}_{>1}$, is a *finite set* of indices. An index $j \in \mathcal{S}$ is referred to as a *mode* of system (3.44). The collection $\{\Omega_j \mid j \in \mathcal{S}\}$ defines a partition of \mathbb{X} , that is

$$\cup_{j \in \mathcal{S}} \Omega_j = \mathbb{X} \quad \text{and} \quad \text{int}(\Omega_i) \cap \text{int}(\Omega_j) = \emptyset \quad \text{for } i \neq j.$$

Each set Ω_j is assumed to be a *polyhedron* which is not necessarily closed. Let $\mathcal{S}_0 \triangleq \{j \in \mathcal{S} \mid 0 \in \text{cl}(\Omega_j)\}$ and $\mathcal{S}_1 \triangleq \{j \in \mathcal{S} \mid 0 \notin \text{cl}(\Omega_j)\}$, so that $\mathcal{S} = \mathcal{S}_0 \cup \mathcal{S}_1$. Furthermore, $g^j : \mathbb{R}^n \times \mathbb{R}^m \rightarrow \mathbb{R}^n$ is allowed to a *discontinuous* map. It is assumed that $x_{eq} = 0$ is an equilibrium point for (3.44) with $u = 0$ and $w = 0$. Therefore, it is required that $g_j(0, 0) = 0$ for all $j \in \mathcal{S}_0$. Let

$$\mathcal{Q}_{ji} \triangleq \left\{ \xi \in \Omega_j \mid \exists \mu \in \mathbb{U} : g^j(\xi, \mu) \in \Omega_i \sim \mathbb{W} \right\}, \quad [j \ i]^\top \in \mathcal{S} \times \mathcal{S} \quad (3.45)$$

and let

$$\mathcal{S}_{tr} \triangleq \left\{ [j \ i]^\top \in \mathcal{S} \times \mathcal{S} \mid \mathcal{Q}_{ji} \neq \emptyset \right\}.$$

Furthermore, let

$$\mathcal{S}_{tr}^j \triangleq \left\{ i \in \mathcal{S} \mid [j \ i]^\top \in \mathcal{S}_{tr} \right\}.$$

Note that the set of pairs of indices \mathcal{S}_{tr} defines all *mode* transitions that can occur in system (3.44), i.e. if $[j \ i]^\top \in \mathcal{S}_{tr}$ then a transition from Ω_j to Ω_i can occur. For a given *mode* j the set of indices \mathcal{S}_{tr}^j defines to which *modes* $i \in \mathcal{S}$ a transition can occur, i.e. given a mode $j \in \mathcal{S}$ transition from Ω_j to Ω_i with $i \in \mathcal{S}_{tr}^j$ can occur. Once \mathcal{Q}_{ji} is computed \mathcal{S}_{tr} and \mathcal{S}_{tr}^j are easy to determine. For a fixed j , \mathcal{Q}_{ji} in (3.52) is also known in literature as the *one-step reachable set* under the disturbances $w : \mathbb{Z}_+ \rightarrow \mathbb{W}$, e.g. see [80].

Remark 3.2.10 In case $g_j(\tilde{x}_k, u_k)$ in (3.44) is piecewise affine (PWA), i.e.

$$g^j(\tilde{x}_k, u_k) = A^j \tilde{x}_k + B^j u_k + b^j, \quad \text{when } \tilde{x}_k \in \Omega_j,$$

where $A^j \in \mathbb{R}^{n \times n}$, $B^j \in \mathbb{R}^{n \times m}$, $b^j \in \mathbb{R}^n$, $j \in \mathcal{S}$, $b^j = 0$ for $j \in \mathcal{S}_0$ and \mathbb{W} , defined in Section 3.1, is assumed to be polyhedron then the set of pairs of indices \mathcal{S}_{tr} can be easily determined by solving s^2 linear programs.

In the sequel an altered version of Algorithm 3.2.2, with potentially less conservatism, for the afore specified system class, i.e. (3.44), is presented. Consider a candidate ISS Lyapunov function of the form

$$V(\tilde{x}_k) \triangleq |P_V^j \tilde{x}_k|, \quad \tilde{x}_k \in \Omega_j, \quad j \in \mathcal{S}. \quad (3.46)$$

where $P_V^j \in \mathbb{R}^{p_{v_j} \times n}$ with $j \in \mathcal{S}$ are full-column rank matrices. Let $Q_V^j \in \mathbb{R}^{q_{v_j} \times n}$ with $j \in \mathcal{S}$ denote a known matrix with full-column rank.

Algorithm 3.2.11

Step 1)

Given the state \tilde{x}_k at time $k \in \mathbb{Z}_+$, find the index $j \in \mathcal{S}$ for which holds $\tilde{x}_k \in \Omega_j$ and let $x_{k|k} \triangleq \tilde{x}_k$.

Step 2)

i) For given $x_{k|k}$ and j compute the one-step reachable set, i.e.

$$\mathcal{X}_j(x_{k|k}) \triangleq \left\{ \tilde{\xi} \in \mathbb{X} \mid \tilde{\xi} = g^j(x_{k|k}, \mu) + \omega, \mu \in \mathbb{U}, \omega \in \mathbb{W} \right\}. \quad (3.47)$$

ii) If $\mathcal{X}_j(x_{k|k}) \cap \Omega_i \neq \emptyset$ for $i \in \mathcal{S}$, then add the index i to a set of indices $\mathcal{S}_{tr,k}^j$.

Step 3)

find a control sequence $\mathbf{u}_k^{[0,N-1]} \triangleq [u_{k|k}^\top, \dots, u_{k+N-1|k}^\top]^\top$ that satisfies

$$\max_{i \in \mathcal{S}_{tr,k}^j} (|P_V^i|) |g^i(x_{k|k}, u_{k|k})| - |P_V^j x_{k|k}| \leq -|Q_V^j x_{k|k}|, \quad (3.48a)$$

$$\mathbf{u}_k^{[0,N-1]} \in \mathcal{U}_N(\tilde{x}_k) \quad (3.48b)$$

and optionally also minimizes the cost $J(\tilde{x}_k, \mathbf{u}_k^{[0,N-1]})$ in (3.2).

Step 4)

Let

$$\kappa^{\text{MPC}}(\tilde{x}_k) \triangleq \left\{ u_{k|k} \in \mathbb{U} \mid \mathbf{u}_k^{[0,N-1]} \text{ satisfies (3.48)} \right\}.$$

Furthermore let $\bar{\mathbf{u}}_k^{[0,N-1]} \triangleq [\bar{u}_{k|k}^\top, \dots, \bar{u}_{k+N-1|k}^\top]^\top$ with $\bar{u}_{k|k} \in \kappa^{\text{MPC}}(\tilde{x}_k)$ denote a feasible sequence of controls with respect to the optimization problem formulated at Step 1. Apply a control

$$u_k = \bar{u}_{k|k} \in \kappa^{\text{MPC}}(\tilde{x}_k)$$

to the perturbed system (3.1b), increment k by one and go to Step 1.

The following result can be obtained for nonlinear system (3.44) in closed-loop with Algorithm 3.2.11 forming system (3.7).

Theorem 3.2.12 *Let $\mathcal{X}_f(N)$ be the set of states $\tilde{x}_k \in \mathbb{X}$ for which the optimization problem in Step 1 of Algorithm 3.2.11 is feasible and let $\widetilde{\mathcal{X}}_f(N) \subseteq \mathcal{X}_f(N)$ be an RPI set with $0 \in \text{int}(\widetilde{\mathcal{X}}_f(N))$ for closed-loop system (3.7) perturbed by additive disturbances $w : \mathbb{Z}_+ \rightarrow \mathbb{W}$. Then, equilibrium point $\tilde{x}_{eq} = 0$ of closed-loop system (3.7) is **input-to-state stable** with respect to disturbances $w : \mathbb{Z}_+ \rightarrow \mathbb{W}$ and initial states \tilde{x}_0 in $\widetilde{\mathcal{X}}_f(N)$.*

Proof: The proof consists in showing that the ISS Lyapunov candidate in (3.46) is actually an ISS Lyapunov function for system (3.7). Since P_V^j has full-column rank for all $j \in \mathcal{S}$, there exist $c_2 \geq c_1 > 0$ such that $c_1 |\tilde{\xi}| \geq |P_V^j \tilde{\xi}| \geq c_2 |\tilde{\xi}|$ for all $\tilde{\xi}$ and $j \in \mathcal{S}$. Hence, $V(\cdot)$ in (3.46) satisfies condition (2.34a) from Theorem 2.3.4 for $c_2 \geq \max_{j \in \mathcal{S}} |P_V^j|$. From constraint (3.48a) and using the triangle inequality, one has that for all $\tilde{\xi} \in \widetilde{\mathcal{X}}_f(N)$, $\omega \in \mathbb{W}$ and any feasible $\bar{\mathbf{u}}_k^{[0, N-1]}$, or for any $\mu \in \kappa^{\text{MPC}}(\tilde{\xi})$:

$$\begin{aligned}
 V(f(\tilde{\xi}, \mu) + \omega) - V(\tilde{\xi}) &= \\
 &= |P_V^j(g^j(\tilde{\xi}, \mu) + \omega)| - |P_V^j \tilde{\xi}|, & \text{when } \tilde{\xi} \in \Omega_j, g^j(\tilde{\xi}, \mu) + \omega \in \Omega_i \\
 &\leq |P_V^j| |g^j(\tilde{\xi}, \mu) + \omega| - |P_V^j \tilde{\xi}|, & \text{when } \tilde{\xi} \in \Omega_j, g^j(\tilde{\xi}, \mu) + \omega \in \Omega_i \\
 &\leq |P_V^j| |g^j(\tilde{\xi}, \mu)| + |P_V^j| |\omega| - |P_V^j \tilde{\xi}|, & \text{when } \tilde{\xi} \in \Omega_j, g^j(\tilde{\xi}, \mu) \in \Omega_i \sim \mathbb{W} \quad (3.49) \\
 &\leq \max_{i \in \mathcal{S}_{tr,k}^j} (|P_V^i|) |g^j(\tilde{\xi}, \mu)| + \max_{i \in \mathcal{S}_{tr,k}^j} (|P_V^i|) |\omega| - |P_V^j \tilde{\xi}|, & \text{when } \tilde{\xi} \in \Omega_j \\
 &\leq -|Q_V^j \tilde{\xi}| + \max_{i \in \mathcal{S}_{tr,k}^j} (|P_V^i|) |\omega|,
 \end{aligned}$$

where $\alpha_3(s) \triangleq \varsigma_{Q_V^j} s$ ($\varsigma_{Q_V^j} \in \mathbb{R}_{>0}$ is such that $|Q_V^j \tilde{\xi}| \geq \varsigma_{Q_V^j} |\tilde{\xi}|$ for all $\tilde{\xi}$) and $\sigma(s) \triangleq \max_{i \in \mathcal{S}_{tr,k}^j} (|P_V^i|) s$. Since the last inequality in (3.49) holds for any $\mu \in \kappa^{\text{MPC}}(\tilde{\xi})$ one has that

$$\sup_{\phi \in \mathcal{F}_w(\tilde{\xi}, \omega)} V(\phi) \leq V(\tilde{\xi}) - \alpha_3(|\tilde{\xi}|) + \sigma(|\omega|)$$

for all $\tilde{\xi} \in \widetilde{\mathcal{X}}_f(N)$, $\omega \in \mathbb{W}$. Hence, the statement of Theorem 3.2.12 then follows from Theorem 2.3.4. \blacksquare

Remark 3.2.13 Note that if g^j in (3.44) is affine with respect to the control u , i.e.

$$g^j(\tilde{x}_k, u_k) = g_1^j(\tilde{x}_k) + g_2^j(\tilde{x}_k) u_k, \quad \text{for } j \in \mathcal{S}$$

with $g_1^j : \mathbb{R}^n \rightarrow \mathbb{R}^n$, $g_2^j : \mathbb{R}^n \rightarrow \mathbb{R}^{n \times m}$ possibly discontinuous mappings and the sets \mathbb{U} and \mathbb{W} are polyhedral, then the problem that has to be solved at step 2 of Algorithm 3.2.11 involves solving $\text{card}(\mathcal{S})$ *linear programming* problems. Furthermore, if in addition infinity norms are considered ($p = \infty$) the constraint (3.48a) can be written as a finite number of *linear inequality constraints*. Note that therefore, for the optimization problem that has to be solved at step 3 of Algorithm 3.2.11, Corollary 3.2.9 of Section 3.2 applies (with step 1 in Corollary 3.2.9 replaced by step 3).

Remark 3.2.14 A possibility to reduce the *on-line* computational burden is to remove step 2 from Algorithm 3.2.11 and replace $\mathcal{S}_{tr,k}$ in (3.48a) by \mathcal{S}_{tr} . Then, instead of computing $\mathcal{S}_{tr,k}$ on-line one computes \mathcal{S}_{tr} *off-line*. But since $\mathcal{S}_{tr,k} \subseteq \mathcal{S}_{tr}$, the off-line computation might lead to more conservativeness compared to online performing step 2 in Algorithm 3.2.11.

Next, a method for computing the ISS Lyapunov function (3.46) *off-line* is presented. Let

$$x_{k+1} = A^j x_k + B^j u_k + b^j, \quad \text{when } x_k \in \Omega_j, \quad k \in \mathbb{Z}_+, \quad (3.50)$$

with $A^j \in \mathbb{R}^{n \times n}$, $B^j \in \mathbb{R}^{n \times m}$, $b^j \in \mathbb{R}^n$, $j \in \mathcal{S}$, $b^j = 0$ for $j \in \mathcal{S}_0$, be a piecewise affine (PWA) *approximation* of (3.44) around $(0, 0, 0)$, i.e. $A^j 0 + B^j 0 + b^j = f(0, 0) = g^j(0, 0)$, for $j \in \mathcal{S}_0$ and

$$A^j x_k + B^j u_k + b^j \approx f(x_k, u_k) = g^j(x_k, u_k), \quad \text{when } x_k \in \Omega_j, \quad (3.51)$$

for all $x_k \in \mathbb{X}_T \subseteq \mathbb{X}$, with $0 \in \text{int}(\mathbb{X}_T)$, and $u_k \in \mathbb{U}$. Let

$$\mathcal{Q}_{ji}^{PWA} \triangleq \left\{ \xi \in \Omega_j \mid \exists \mu \in \mathbb{U} : A^j \xi + B^j \mu + b^j \in \Omega_i \sim \mathbb{W} \right\}, \quad [j \ i]^\top \in \mathcal{S} \times \mathcal{S} \quad (3.52)$$

and let

$$\mathcal{S}_{tr}^{PWA} \triangleq \left\{ [j \ i]^\top \in \mathcal{S} \times \mathcal{S} \mid \mathcal{Q}_{ji}^{PWA} \neq \emptyset \right\}. \quad (3.53)$$

In order to compute the matrices Q_V^j and P_V^j the following linear state-feedback $u_k = K^j x_k$, $K^j \in \mathbb{R}^{m \times n}$, $k \in \mathbb{Z}_+$, is introduced. Then, the following result can be employed to find a matrix P_V^j , which then defines an ISS Lyapunov function of the form in (3.46) for closed-loop system (3.7), with κ^{MPC} , representing Algorithm 3.2.11.

Lemma 3.2.15 *Suppose that the following matrices P_V^j , Q_V^j , K^j and scalars $\tau_{ji} \in \mathbb{R}_{(0,1)}$ satisfy*

$$|P_V^j (A^j + B^j K^j) (P_V^j)^{-L}| + |Q_V^j (P_V^j)^{-L}| \leq 1 - \tau_{ji}, \quad [j \ i]^\top \in \mathcal{S}_{tr}^{PWA}, \quad (3.54a)$$

$$|P_V^j (b^j)| \leq \tau_{ji} |P_V^j \xi|, \quad \forall \xi \in \mathbb{X}_T \cap \Omega_j, \quad [j \ i]^\top \in \mathcal{S}_{tr}^{PWA}, \quad (3.54b)$$

$$(P_V^j)^\top P_V^j > 0, \quad \forall j \in \mathcal{S}, \quad (3.54c)$$

$$(Q_V^j)^\top Q_V^j > 0, \quad \forall j \in \mathcal{S}. \quad (3.54d)$$

Then, for all $\xi \in \mathbb{X}_T$ it holds that

$$|P_V^j((A^j + B^j K^j)\xi + b^j)| - |P_V^j \xi| \leq -|Q_V^j \xi|. \quad (3.55)$$

Hence, the function $V(\cdot)$ in (3.46) is a Lyapunov function for closed-loop system $x_{k+1} = (A^j + B^j K^j)x_k + b^j$ when $x_k \in \Omega_j$, $j \in \mathcal{S}$.

Proof: Inequalities (3.54c) and (3.54d) guarantee that $\text{rank}(P_V^j) = \text{rank}(Q_V^j) = n$ for all $j \in \mathcal{S}$. Furthermore, since $\{P_V^j, K^j, Q_V^j, \tau_{ji} \mid [j \ i]^\top \in \mathcal{S}_{ir}^{PWA}\}$ satisfy (3.54a) it follows that

$$|P_V^j(A^j + B^j K^j)(P_V^j)^{-L}| + |Q_V^j(P_V^j)^{-L}| + \tau_{ji} - 1 \leq 0, \quad [j \ i]^\top \in \mathcal{S}_{ir}^{PWA} \quad (3.56)$$

Multiplying (3.56) with $|P_V^j \xi|$ yields that for $[j \ i]^\top \in \mathcal{S}_{ir}^{PWA}$

$$\begin{aligned} 0 &\geq |P_V^j(A^j + B^j K^j)(P_V^j)^{-L}| |P_V^j \xi| + |Q_V^j(P_V^j)^{-L}| |P_V^j \xi| + \tau_{ji} |P_V^j \xi| - |P_V^j \xi|, & \forall \xi \\ &\geq |P_V^j(A^j + B^j K^j)(P_V^j)^{-L} P_V^j \tilde{\xi}| + |Q_V^j(P_V^j)^{-L} P_V^j \xi| + |P_V^j b^j| - |P_V^j \xi|, & \forall \xi \in \mathbb{X}_T \\ &\geq |P_V^j((A^j + B^j K^j)\xi + b^j)| - |P_V^j \xi| + |Q_V^j \xi|, & \forall \xi \in \mathbb{X}_T. \end{aligned}$$

Hence, (3.55) follows. \blacksquare

3.3 Feedback to disturbances

The input-to-state stable sub-optimal model predictive scheme that is presented in the previous sections can be categorized as belonging to the inherently robust model predictive control framework, as opposed to the min-max model predictive control framework [9]. By this, one means that knowledge about disturbances is not incorporated in the computation of the control u . For example, in the case of Algorithm 3.2.2 for V and α_V as given in (3.13) and (3.12), respectively, the ISS-gain γ_x^M of the closed-loop system (3.7) will depend on $\sigma(\cdot)$, i.e. the constant c_2 (see the proof of Corollary 3.2.6), via the relation (2.35). As the constant c_2 can be taken equal to $|P_V|$ (due to $|P_V \xi| \leq |P_V| |\xi|$ for all $\xi \in \mathbb{R}^n$), one could minimize $|P_V|$ off-line, when computing the matrix P_V . However, this might lead to an increase in the conservativeness of the input-to-state stabilizability constraint (3.10a). Furthermore, when it is known that the disturbances take value at all times in a polyhedral set \mathbb{W} , it would be desirable to use this knowledge to minimize the ISS-gain γ_x^M by minimizing $\sigma(\cdot)$ on-line and therefore, introduce feedback to disturbances. This yields better performance, i.e. suppression of the effect of additive disturbances on the evolution of the state trajectory.

An obvious solution for achieving the afore mentioned goal is to consider a specific type of \mathcal{K} -function for example, $\sigma(s) \triangleq \phi_k s$ with $\phi_k \in \mathbb{R}_{>0}$ for all $k \in \mathbb{Z}_+$, and

the following constraint added to Algorithm 3.2.2

$$|P_V(f(x_{k|k}, u_{k|k}) + w_k)| - |P_V x_{k|k}| + |Q_V x_{k|k}| - \varphi_k |w_k| \leq 0, \quad \forall w_k \in \mathbb{W}. \quad (3.57)$$

Then, at every time instant $k \in \mathbb{Z}_+$ one can minimize gain φ_k in (3.57) in order to obtain a minimal ISS-gain γ_x^w . Unfortunately, the above constraint cannot be specified as a finite number of (linear) inequalities. Furthermore, the left-hand term in (3.57) contains the difference of two convex functions of w , i.e. $|P_V(f(x_{k|k}, u_{k|k}) + w_k)|$ and $\varphi_k |w_k|$, which is in general not convex.

To incorporate feedback to disturbances and still preserve the computational advantages of Algorithm 3.2.2, the following modification to Algorithm 3.2.2 is proposed. Let ϖ^e , with $e \in \mathbb{Z}_{[1,E]}$, be the vertices of \mathbb{W} and let $\lambda_k^e \in \mathbb{R}_{\geq 0}$, $k \in \mathbb{Z}_+$, be optimization variables associated with each vertex ϖ^e . Add the following constraints to the optimization problem in Step 1 of Algorithm 3.2.2

$$|P_V(f(x_{k|k}, u_{k|k}) + \varpi^e)| - |P_V x_{k|k}| + |Q_V x_{k|k}| - \lambda_k^e \leq 0, \quad e = 1, \dots, E, \quad (3.58)$$

where one aims at obtaining “small” values for λ_k^e . Before formally stating the resulting sub-optimal model predictive control algorithm with constraint (3.58), it will be made precise how the variables λ_k^e are related to the gain φ_k in (3.57).

Since \mathbb{W} is a polyhedron, it can be written as a finite union of simplices $\mathbb{S}_1, \dots, \mathbb{S}_M$ for some $M \in \mathbb{Z}_{\geq 1}$, i.e.

$$\mathbb{W} = \bigcup_{i=1}^M \mathbb{S}_i, \quad (3.59)$$

with each simplex \mathbb{S}_i equal to the convex hull of a subset of vertices of \mathbb{W} and the origin, i.e. $w = 0$. More precisely,

$$\mathbb{S}_i = \text{Co} \left\{ 0, \varpi^{e_{i,1}}, \dots, \varpi^{e_{i,n}} \right\} \quad (3.60)$$

with n the dimension of the disturbance set \mathbb{W} and $\{\varpi^{e_{i,1}}, \dots, \varpi^{e_{i,n}}\} \subseteq \{\varpi^1, \dots, \varpi^E\}$ (i.e. $\{e_{i,1}, \dots, e_{i,n}\} \subseteq \{1, \dots, E\}$) with vectors $\varpi^{e_{i,1}}, \dots, \varpi^{e_{i,n}}$ linearly independent.

Example 3.3.1 In Figure 3.1 a simple graphical representation of a given disturbance set \mathbb{W} is given. The set can be divided in, for example, $M = 5$ simplices, i.e. $\mathbb{S}_1, \dots, \mathbb{S}_5$ which are all five equal to the convex hull of a subset of vertices of \mathbb{W} . Take for example the simplex \mathbb{S}_3 from the set \mathbb{W} in Figure 3.1. The simplex \mathbb{S}_3 is spanned by $w = 0, \varpi^{e_{3,1}}, \varpi^{e_{3,2}}$, with $e_{3,1} = 2$ and $e_{3,2} = 3$.

For each simplex \mathbb{S}_i one can define the matrix $W_i \triangleq [\varpi^{e_{i,1}} \dots \varpi^{e_{i,n}}] \in \mathbb{R}^{n \times n}$, which is invertible.

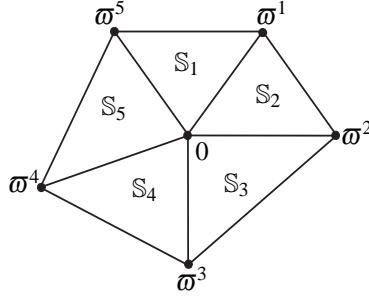

Figure 3.1: A 2-D example of the disturbance set \mathbb{W} with vertices $\bar{w}^1, \dots, \bar{w}^5$ ($E=5$).

Lemma 3.3.2 *If for $k \in \mathbb{Z}_+$ and the measured state $\tilde{x}_k = x_{k|k}$ there exist $u_{k|k}$ and λ_k^e , $e \in \mathbb{Z}_{[1,E]}$, such that (3.58) holds, then (3.57) holds with*

$$\varphi_k \triangleq \max_{i \in \mathbb{R}_{[1,M]}} |\bar{\lambda}_k^i W_i^{-1}|, \quad (3.61)$$

where $\bar{\lambda}_k^i \triangleq [\lambda_k^{e_{i,1}} \dots \lambda_k^{e_{i,n}}] \in \mathbb{R}^{1 \times n}$ and $|\cdot|$ is the corresponding induced matrix norm.

Proof: Let $x_{k|k}$ be given and suppose (3.58) holds for λ_k^e , $e \in \mathbb{Z}_{[1,E]}$. Let $w_k \in \mathbb{W} = \bigcup_{i=1}^M \mathbb{S}_i$. Hence, there exists an $i \in \mathbb{Z}_{[1,M]}$ such that $w_k \in \mathbb{S}_i = \text{Co}\{0, \bar{w}^{e_{i,1}}, \dots, \bar{w}^{e_{i,n}}\}$, which means that there exist nonnegative reals μ_1, \dots, μ_n with

$$\sum_{j=1}^n \mu_j \leq 1 \quad \text{and} \quad w_k = \sum_{j=1}^n \mu_j \bar{w}^{e_{i,j}}.$$

In matrix notation one has that

$$w_k = W_i \begin{bmatrix} \mu_1 \\ \vdots \\ \mu_n \end{bmatrix} \quad \Leftrightarrow \quad \begin{bmatrix} \mu_1 \\ \vdots \\ \mu_n \end{bmatrix} = W_i^{-1} w_k. \quad (3.62)$$

Multiplying each inequality in (3.58) corresponding to the index $e_{i,j}$ with $\mu_j \in \mathbb{R}_{>0}$, summing up, employing the fact that $\sum_{j=1}^n \mu_j \leq 1$ yields

$$|P_V(f(x_{k|k}, u_{k|k}) + w_k)| - |P_V x_{k|k}| + |Q_V x_{k|k}| - \sum_{j=1}^n \mu_j \lambda_k^{e_{i,j}} \leq 0, \quad (3.63)$$

or equivalently,

$$|P_V(f(x_{k|k}, u_{k|k}) + w_k)| - |P_V x_{k|k}| + |Q_V x_{k|k}| - \bar{\lambda}_k^i \begin{bmatrix} \mu_1 \\ \vdots \\ \mu_n \end{bmatrix} \leq 0. \quad (3.64)$$

Furthermore, employing (3.62), $\mu_j \in \mathbb{R}_{>0}$ and $\lambda_k^{e_i,j} \in \mathbb{R}_{\geq 0}$, one obtains (3.57) for the indicated φ_k in (3.61). \blacksquare

Note that, according to Theorem 2.3.4, if $\varphi_k \leq \varphi^*$ such that for all $k \in \mathbb{Z}_{\geq k^*}$ for some $k^* \in \mathbb{Z}_+$ and $\varphi^* \in \mathbb{R}_{\geq 0}$, an ISS-gain is guaranteed via expression (2.35). Since φ_k is coupled to λ_k^e , $e \in \mathbb{Z}_{[1,E]}$, via (3.61), small λ_k^e , $e \in \mathbb{Z}_{[1,E]}$, will result in a small ISS-gain of the closed-loop system (3.7). Hence, optimized robustness of the closed-loop system to additive disturbances $w : \mathbb{Z}_+ \rightarrow \mathbb{W}$ is obtained.

Algorithm 3.2.2 as it is, is beneficial as it focusses on performance and it also provides guaranteed input-to-state stability with a possibly *large* ISS-gain. This gain is ensured via constraint (3.10a), which yields a *fixed* φ_k so to speak (i.e. independent of $x_{k|k}$ and equal to $|P_V|$). In the new model predictive control scheme, presented in the sequel, one aims at performing a *trade-off* between robustness (suppressing disturbances adequately) via a small φ_k on one hand and performance on the other. This will be done by adding constraint (3.58) to Algorithm 3.2.2 and minimizing a weighted sum of the performance costs and disturbance attenuation. On-line improvement of robustness, i.e. a reduction of the effect of additive disturbances on the evolution of the state trajectory, is then guaranteed.

Define

$$\Lambda_k \triangleq \left[\lambda_k^1 \quad \dots \quad \lambda_k^E \right]^\top \quad (3.65)$$

and let R_λ be a known real-valued full-column rank matrix of appropriate dimensions. Note that relation (3.61) can provide an indication for how to choose R_λ . Consider the following cost

$$J(\tilde{x}_k, \mathbf{u}_k^{[0,N-1]}, \Lambda_k) \triangleq |R_\lambda \Lambda_k| + |P x_{k+N|k}| + \sum_{i=0}^{N-1} \left(|Q x_{k+i|k}| + |R_u u_{k+i|k}| \right). \quad (3.66)$$

The input-to-state stabilizing sub-optimal model predictive control algorithm, which provides feedback to additive disturbances, is then formulated as

Algorithm 3.3.3

Step 1)

Given the state \tilde{x}_k at time $k \in \mathbb{Z}_+$, let $x_{k|k} \triangleq \tilde{x}_k$ and find a control sequence $\mathbf{u}_k^{[0,N-1]} \triangleq [u_{k|k}^\top, \dots, u_{k+N-1|k}^\top]^\top$ and a vector Λ_k that minimize the cost (3.66) and satisfy

$$|P_V(f(x_{k|k}, u_{k|k}))| - |P_V x_{k|k}| \leq -|Q_V x_{k|k}|, \quad (3.67a)$$

$$|P_V(f(x_{k|k}, u_{k|k}) + \varpi^e)| - |P_V x_{k|k}| + |Q_V x_{k|k}| - \lambda_k^e \leq 0, \quad e \in \mathbb{Z}_{[1,E]}, \quad (3.67b)$$

$$\lambda_k^e \geq 0, \quad e \in \mathbb{Z}_{[1,E]}, \quad (3.67c)$$

$$\mathbf{u}_k^{[0,N-1]} \in \mathcal{U}_N(\tilde{x}_k). \quad (3.67d)$$

Step 2)

Let

$$\kappa^{\text{MPC}}(\tilde{x}_k) \triangleq \left\{ u_{k|k} \in \mathbb{U} \mid \mathbf{u}_k^{[0, N-1]} \text{ satisfies (3.67)} \right\}.$$

Furthermore, let $\bar{\mathbf{u}}_k^{[0, N-1]} \triangleq [\bar{u}_{k|k}^\top, \dots, \bar{u}_{k+N-1|k}^\top]^\top$ with $\bar{u}_{k|k} \in \kappa^{\text{MPC}}(\tilde{x}_k)$ denote a feasible sequence of controls with respect to the optimization problem formulated at Step 1. Apply a control

$$u_k = \bar{u}_{k|k} \in \kappa^{\text{MPC}}(\tilde{x}_k)$$

to the perturbed system (3.1b), increment k by one and go to Step 1.

Besides enhancing robustness, the constraint (3.67b) also ensures that Algorithm 3.3.3 recovers performance if the state of the closed-loop system (3.7) approaches $\tilde{x}_{eq} = 0$ ε -close, i.e. $|\tilde{x}_k| \leq \varepsilon$. If $|\tilde{x}_k| \leq \varepsilon$ one can consider that $x_{k|k} \approx 0$. Then, Algorithm 3.3.3 will produce a control $u_{k|k} \approx 0$ and constraint (3.67b) yields $|P_V \bar{w}^e| - \lambda_k^e \leq 0$, $e \in \mathbb{Z}_{[1, E]}$. Therefore, Algorithm 3.3.3 cannot minimize each variable λ_k^e below the corresponding value $|P_V \bar{w}^e|$, $e \in \mathbb{Z}_{[1, E]}$ leaving more “freedom” in constraint (3.67b) which the controller might use to generate performance. This property is desirable, since it is known from min-max model predictive control [9] that considering a *worst-case* disturbance scenario in model predictive control algorithms leads to poor performance when the disturbance is small or possibly vanishes.

In other words, the constraint (3.67b) automatically switches off the feedback to disturbances when the closed-loop state approaches the equilibrium $\tilde{x}_{eq} = 0$ ε -close and therefore, the scheme performs as if there are no or a negligible effects of additive disturbances. For the scenario ε -close to $\tilde{x}_{eq} = 0$ one, in principle, obtains Algorithm 3.2.2. Whenever the state is not ε -close to $\tilde{x}_{eq} = 0$, which is the case during transient (possibly caused by disturbances), the constraint (3.67b) automatically incorporates feedback to disturbances. That is, λ_k^e , $e \in \mathbb{Z}_{[1, E]}$ can be minimized below $|P_V \bar{w}^e|$ which results in less freedom in constraint (3.67b), but a smaller gain φ_k (and coupled to it a smaller ISS-gain) which results in better suppression of additive disturbances $w : \mathbb{Z}_+ \rightarrow \mathbb{W}$.

Remark 3.3.4 Note that in case the to-be-controlled system (3.1b) is affine in the control variable, i.e. (3.18) and infinity norms are considered ($p = \infty$), the additional input-to-state constraints (3.67b) can as constraint (3.67a) in the previously presented control algorithms be specified via a finite number of linear inequalities in the variables $u_{k|k}, \lambda_k^1, \dots, \lambda_k^E$ and therefore Corollary 3.2.9 holds also for Algorithm 3.3.3.

Remark 3.3.5 In order to possibly reduce conservativeness of constraints (3.67a) and (3.67b), the approach in Section 3.2 as it is employed to Algorithm 3.2.2 to reduce

conservativeness of constraint (3.10a) can straightforwardly also be employed to Algorithm 3.3.3 to relax constraints (3.67a) and (3.67b).

3.4 Decentralized manufacturing control

In this section it is illustrated how the presented control theory presented in this chapter can be employed to control a manufacturing system in a decentralized manner. That is, the overall manufacturing system under control is sub-divided into simpler subsystems. For each subsystem a (local) controller is designed according to the theory presented in this chapter with the goal to reach an overall control goal when all the controllers are implemented on the total manufacturing system.

Since the analysis and design of large-scale manufacturing systems are in general difficult, it is desirable to adopt a relatively simple and tractable model to capture the key performance-related issues, such machine capacity constraints buffer size limitations, *blocking* behavior, etc. In this section one takes up the challenge of applying the theory addressed in this chapter to a network manufacturing systems, in order to specifically address the nonlinearities, possibly discontinuous, that are typically present in manufacturing system dynamics as one will encounter later in this section. Furthermore, the possibility of taking into account machine capacity constraints a buffer size limitations makes the presented MPC algorithm in this chapter an attractive control strategy to tackle a manufacturing systems control problem.

Modeling for control purposes

Consider the queuing system (manufacturing system) as depicted in Figure 3.2. Here

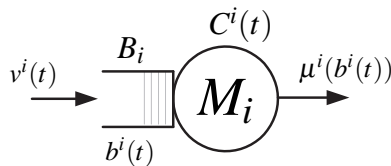

Figure 3.2: An example of a simple queuing system.

M_i is a processing unit (machine) on which for example products are being processed. In front of the machine one has a first in first out buffer system denoted by B_i . The buffer system collects incoming products entering the system over time with a certain average arrival rate [products/time unit] $v^i : \mathbb{R}_+ \rightarrow \mathbb{R}_+$. The machine M_i processes over time with a certain (*to-be-assigned*) average production rate or production capacity

[products/time unit] $C^i : \mathbb{R}_+ \rightarrow \mathbb{R}_{[0, C_{up}^i]}$, where C_{up}^i is the maximal possible capacity that can be assigned to the machine M_i . The average amount of products that are present in the buffer over time is denoted by $b^i : \mathbb{R}_+ \rightarrow \mathbb{R}_{[0, b_{up}^i]}$ where $b_{up}^i \in \mathbb{Z}_{>0}$ is the maximal allowable products that can be stored in the buffer B_i . It is verified in [81] through simulations, and under the condition that the arrival and processing rate are Poisson, that

$$\mu^i(b^i(t)) = \left(\frac{b^i(t)}{1 + b^i(t)} \right) C^i(t), \quad (3.68)$$

see Figure 3.2, is a valid choice for modeling the average departure rate (i.e. [products/time unit]) for a wide range of communication networks and queuing systems, e.g. the system depicted in Figure 3.2. Based on relation (3.68) and applying the law of mass conservation one can obtain the following basic dynamic model for the queuing system depicted in Figure 3.2

$$\begin{aligned} \frac{d}{dt} b^i(t) &= v^i(t) - \mu^i(b^i(t)), \quad t \in \mathbb{R}_+ \\ b^i(t) &\in \mathbb{R}_{[0, b_{up}^i]}, \\ C^i(t) &\in \mathbb{R}_{[0, C_{up}^i]}. \end{aligned} \quad (3.69)$$

This model has been introduced in [82]. Recently, the authors of [81], [83] and [84] have been considering this model for the purpose of network performance evaluation and control under *non-stationary* conditions. Furthermore, in [85] a model of the form as in (3.69) followed from PDE-based modeling of manufacturing systems. From (3.69), it follows that in the special case of a *constant* average arrival and production rates, i.e. $v^i(t) = v_{ss}^i$ and $C^i(t) = C_{ss}^i$ for all times $t \in \mathbb{R}_+$, respectively, that the corresponding *steady state* average amount of products, i.e. b_{ss}^i , is given by

$$b_{ss}^i = \frac{v_{ss}^i}{C_{ss}^i - v_{ss}^i}. \quad (3.70)$$

Note that (3.70) is the classical formula of queuing theory for first in first out queuing systems as depicted in Figure 3.2, see e.g. [86].

To apply the control strategy explained in this chapter a discrete-time version of (3.69) is obtained employing Euler's discretization scheme with sample time $T = 1$ and ZOH, i.e.

$$b_{k+1}^i = b_k^i + v_k^i - \mu^i(b_k^i), \quad k \in \mathbb{Z}_+, \quad (3.71)$$

with

$$\mu^i(b_k^i) = \left(\frac{b_k^i}{1 + b_k^i} \right) C_k^i \quad (3.72)$$

and constraints

$$b_k^i \in \mathbb{R}_{[0, b_{up}^i]}, \quad C_k^i \in \mathbb{R}_{[0, C_{up}^i]}. \quad (3.73)$$

Based on the basic queuing model (3.71) one can model more complex manufacturing systems. Consider for example the manufacturing system in Figure 3.3. The system

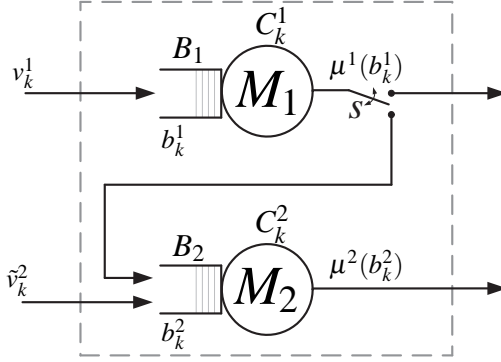

Figure 3.3: An example of a manufacturing system based on an interconnection of two simple queuing systems.

in Figure 3.3 consists of two basic manufacturing systems as depicted in Figure 3.2. The two systems are decoupled if the average buffer contents of B_2 , i.e. b_k^2 is above a certain value $\bar{b}^2 \in \mathbb{Z}_{>0}$. However, if the buffer contents of B_2 is equal or smaller than the certain level $\bar{b}^2 \in \mathbb{Z}_{>0}$, there will be a coupling, i.e. products from machine M_1 with the average departure rate $\mu^1(b_k^1)$ will enter buffer B_2 with average arrival rate $\mu^1(b_k^1)$. The system dynamics can be described by

$$\begin{bmatrix} b_{k+1}^1 \\ b_{k+1}^2 \end{bmatrix} = \begin{cases} \begin{bmatrix} b_k^1 + v_k^1 - \mu^1(b_k^1) \\ b_k^2 + v_k^2 - \mu^2(b_k^2) \end{bmatrix}, & \text{with } v_k^2 = \tilde{v}_k^2 + \mu^1(b_k^1), \text{ if } b_k^2 \leq \bar{b}^2, \\ \begin{bmatrix} b_k^1 + v_k^1 - \mu^1(b_k^1) \\ b_k^2 + v_k^2 - \mu^2(b_k^2) \end{bmatrix}, & \text{with } v_k^2 = \tilde{v}_k^2, \text{ otherwise.} \end{cases} \quad (3.74)$$

Suppose the system, as depicted in Figure 3.3, is a so called *node* of many nodes in a manufacturing system network. Then, assume that each node in the network can be described based on basic interconnections of the simple queuing model description in (3.69), resulting in for example a system of the form in (3.74). Each node in the network is possibly connected to other nodes in the network, i.e. incoming product streams as for example arrival rates v_k^1 and \tilde{v}_k^2 of the node in Figure 3.3 are fractions of departure rates of other nodes in the network (or from the node itself), which might be *time delayed* due to, for example, transportation times of products from one node to another. See Figure 3.4 for an example of such a network. Let N_o be the total

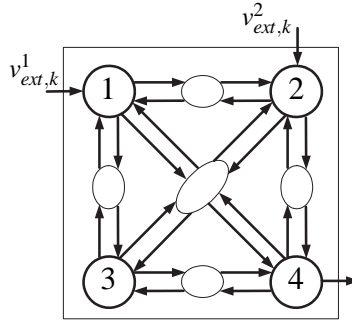

Figure 3.4: An example of a manufacturing system network consisting four-nodes and two external sources of inflow of products at nodes 1 and 2 with average arrival rates $v_{ext,k}^1$ and $v_{ext,k}^2$, respectively.

number of nodes in the network and let $z_k^\ell \in \mathbb{R}^{n_\ell}$ and $u_k^\ell \in \mathbb{R}^{m_\ell}$ with $\ell \in \mathbb{Z}_{[1, N_o]}$ for some $N_o \in \mathbb{Z}_{\geq 1}$ be the state and control of each node in the network at discrete-time $k \in \mathbb{Z}_+$, respectively. Furthermore, let $v_{ext,k}^\ell \in \mathbb{R}^{n_\ell^v}$ be average arrival rates of products from some external source entering node ℓ at discrete time $k \in \mathbb{Z}_+$. The control u_k^ℓ of each node in the network contains all C_k^i of the basic queuing systems, contained in each node. Consider a node, i.e. node 1, e.g. represented by (3.74). Note that then $z_k^1 \triangleq [b_k^1 \ b_k^2]^\top$ and $u_k^1 \triangleq [C_k^1 \ C_k^2]$ are the state and the control of that particular node at discrete-time $k \in \mathbb{Z}_+$. Then v_k^1 and \tilde{v}_k^2 possibly depend on states $z_k^\ell \in \mathbb{R}^{n_\ell}$, which are possibly time delayed, and the external average arrival rates $v_{ext,k}^\ell$, i.e.

$$\begin{bmatrix} v_k^1 \\ \tilde{v}_k^2 \end{bmatrix} = h_v^1(k, v_{ext,k}^1, z_{k-\delta_{11}}^1, \dots, z_{k-\delta_{N_o 1}}^{N_o}), \quad (3.75)$$

where $\delta_{j\ell} \in \mathbb{Z}_+$ with $j, \ell \in \mathbb{Z}_{[1, N_o]}$ represent the time delay caused by for example transportation time of products between nodes ℓ, j . Substituting expression in (3.75) in (3.74) forms the description of the dynamics of node 1 which possibly depends on states of other nodes in the system and external arrival rates. Then, for all nodes one can derive comparable descriptions of the node dynamics forming the total description of the dynamics of the network i.e.,

$$\begin{bmatrix} z_{k+1}^1 \\ \vdots \\ z_{k+1}^{N_o} \end{bmatrix} = \begin{bmatrix} h^1(z_k^1, u_k^1) + h_v^1(k, v_{ext,k}^1, z_{k-\delta_{11}}^1, \dots, z_{k-\delta_{N_o 1}}^{N_o}) \\ \vdots \\ h^{N_o}(z_k^{N_o}, u_k^{N_o}) + h_v^{N_o}(k, v_{ext,k}^{N_o}, z_{k-\delta_{1N_o}}^1, \dots, z_{k-\delta_{N_o N_o}}^{N_o}) \end{bmatrix}, \quad k \in \mathbb{Z}_+. \quad (3.76)$$

Control problem

Let $z_{ref}^\ell \in \mathbb{R}^{n_\ell}$ denote pre-specified buffer levels in all nodes of the system, i.e. the buffers levels of buffers B_i in the network. Suppose that the state, i.e. $z_k^\ell \in \mathbb{R}^{n_\ell}$ with $\ell \in \mathbb{Z}_{[1, N_o]}$ at discrete time $k \in \mathbb{Z}_+$ is available for feedback. Then, the control goal is to assign production rates C_k^i to each machine in the network such that z_k^ℓ goes to z_{ref}^ℓ as fast as possible but taking into consideration that assigning a high average production rate, i.e. C_k^i , to the machines in the network is costly and has to be taken into consideration, e.g. penalized, in the controller design.

To solve the afore mentioned control goal a *decentralized* control approach is followed. That is, for each node an individual (i.e. local) control problem is formulated and a controller is designed to reach the afore mentioned overall (global) control goal. As to formulate a local control problem a single node is considered, e.g. node 1, and is isolated from all the other nodes by considering only the description of that single node, e.g. (3.74), and considering the arrival rates, e.g. v_k^1 and \tilde{v}_k^2 , as *additive disturbances* w_k^ℓ , e.g.

$$w_k^1 \triangleq \begin{bmatrix} v_k^1 \\ \tilde{v}_k^2 \end{bmatrix} = h_v^1(k, v_{ext,k}^1, z_{k-\delta_{\ell 1}}^1, \dots, z_{k-\delta_{N_o 1}}^{N_o}). \quad (3.77)$$

Assume that the arrival rates at each note are upper-bounded by some known bound. Then one has that $w^\ell \in \mathbb{W}^\ell$, where \mathbb{W}^ℓ is some known compact set, e.g.

$$w_k^1 \in \mathbb{W}^1 \triangleq \mathbb{R}_{[0, C_{up}^1]} \times \mathbb{R}_{[0, C_{up}^2]}. \quad (3.78)$$

Remark 3.4.1 Note that assuming there is an upper-bound for the arrival rates in the network is a mild assumption due to the fact $C_k^i \in \mathbb{R}_{[0, C_{up}^i]}$ are finite for all $k \in \mathbb{Z}_+$ and due to the fact that relation (3.72) has the following nice property

$$0 \leq \mu^i(\xi) < C_{up}^i, \quad \forall \xi \in \mathbb{R}_+.$$

The following local control problem is now considered.

Problem 3.4.2 For some $\ell \in \mathbb{Z}_{[1, N_o]}$, let $z_{ref}^\ell \in \mathbb{R}^{n_\ell}$ and z_k^ℓ be given at discrete-time $k \in \mathbb{Z}_+$. Design a controller that based on the state in node ℓ , i.e. z_k^ℓ , assigns C_k^i to the each machine in node ℓ such that

1. z_k^ℓ goes to z_{ref}^ℓ as fast as possible while penalizing that high average production rates C_k^i are assigned to the machines in the network
2. Additive disturbances $w^\ell : \mathbb{Z}_+ \rightarrow \mathbb{W}^\ell$ are rejected.

A good disturbance rejection property of the local controllers, i.e. item 2 in Problem 3.4.2, will guarantee that the local controllers designed for performance based on local models (which lack detailed description of the influence of other nodes in the system), e.g. item 1 in Problem 3.4.2, will perform well if the effects of the unmodeled node interactions are present. This will guarantee good performance of the afore formulated overall network control goal.

The main advantage of this decentralized control approach is that a lot of complexity in modeling, i.e. determining accurate descriptions the functions f_v^ℓ , which in practice might contain a lot of uncertain and time varying parameters like uncertain transportation delays between nodes, is avoided. Also from a controller design point of view this complexity reduction is beneficial especially if one considers large networks.

Controller design

To solve Problem 3.4.2 a model predictive control strategy with feedback to disturbances presented in this chapter will be employed. The controller design will be spelled-out for node 1 in the previously explained manufacturing system network. Consider the description of the system dynamics of node 1, i.e. (3.74) with additive disturbance w_k^1 as defined in (3.77) and the control $u_k^1 \triangleq [C_k^1 \ C_k^2]^\top$. Suppose that the buffer reference level is given by

$$z_{ref}^1 \triangleq \begin{bmatrix} b_{ref}^1 \\ b_{ref}^2 = \bar{b}^2 - 1 \end{bmatrix}, \quad \forall k \in \mathbb{Z}_+. \quad (3.79)$$

Note that for $w_k^1 = 0$ and $u_k^1 = 0$ system (3.74) has the following (infinite) equilibria

$$z_{eq}^1 \triangleq \begin{bmatrix} b_{eq}^1 \\ b_{eq}^2 \end{bmatrix} \in \mathbb{R}_+^2.$$

The controller design methodology of this chapter can render 0 as equilibrium point of the closed-loop system input-to-state stable, however in this example one aims at rendering equilibrium point z_{ref}^1 input-to-state stable, with z_{ref}^1 defined in (3.79), therefore the controller design will be based on the system dynamics obtained after performing the following coordinate transformation on the state of (3.74), i.e.

$$\tilde{x}_k^1 \triangleq z_k^1 - z_{ref}^1, \quad \forall k \in \mathbb{Z}_+. \quad (3.80)$$

This yield the following transformed system dynamics for node 1.

$$\tilde{x}_{k+1}^1 = f^1(\tilde{x}_k^1, u_k^1) + w_k^1 = g_1(\tilde{x}_k^1) + g_2^j(\tilde{x}_k^1)u_k^1 + w_k^1 \quad \text{when} \quad \tilde{x}_k^1 \in \Omega_j, \quad j \in \{1, 2\} \quad (3.81)$$

where $g_1(\tilde{x}_k) \triangleq \tilde{x}_k^1$,

$$g_2^1(\tilde{x}_k^1) \triangleq \begin{bmatrix} -\frac{\tilde{x}_{1,k}^1 + b_{ref}^1}{1 + \tilde{x}_{1,k}^1 + b_{ref}^1} & 0 \\ \frac{\tilde{x}_{1,k}^1 + b_{ref}^1}{1 + \tilde{x}_{1,k}^1 + b_{ref}^1} & -\frac{\tilde{x}_{2,k}^1 + b_{ref}^2}{1 + \tilde{x}_{2,k}^1 + b_{ref}^2} \end{bmatrix}, \quad g_2^2(\tilde{x}_k^1) \triangleq \begin{bmatrix} -\frac{\tilde{x}_{1,k}^1 + b_{ref}^1}{1 + \tilde{x}_{1,k}^1 + b_{ref}^1} & 0 \\ 0 & -\frac{\tilde{x}_{2,k}^1 + b_{ref}^2}{1 + \tilde{x}_{2,k}^1 + b_{ref}^2} \end{bmatrix},$$

$$\Omega_1^1 \triangleq \left\{ \tilde{\xi} \in \mathbb{R}^2 \mid H_{\Omega_1}^1 \tilde{\xi} \leq 1 \right\}, \quad \Omega_2^1 \triangleq \left\{ \tilde{\xi} \in \mathbb{R}^2 \mid H_{\Omega_2}^1 \tilde{\xi} > 1 \right\},$$

with $H_{\Omega_1}^1 \triangleq [0 \ 1]$ and $H_{\Omega_2}^1 \triangleq [0 \ 1]$. Furthermore, \tilde{x}_k^1 , u_k^1 and w_k^1 are constrained in the sets \mathbb{X}^1 , \mathbb{U}^1 and \mathbb{W}^1 for all $k \in \mathbb{Z}_+$, respectively, i.e.

$$\mathbb{X}^1 \triangleq \left\{ \tilde{\xi} \in \mathbb{R}^2 \mid A_X^1 \tilde{\xi} \leq b_X^1 \right\}, \quad \mathbb{U}^1 \triangleq \left\{ \mu \in \mathbb{R}^2 \mid A_U^1 \mu \leq b_U^1 \right\},$$

$$\mathbb{W}^1 \triangleq \left\{ \omega \in \mathbb{R}^2 \mid A_W^1 \omega \leq b_W^1 \right\},$$

where

$$A_X^1 \triangleq \begin{bmatrix} -1 & 0 \\ 0 & -1 \\ 1 & 0 \\ 0 & 1 \end{bmatrix}, \quad b_X^1 \triangleq \begin{bmatrix} -b_{ref}^1 \\ -b_{ref}^2 \\ b_{up}^1 - b_{ref}^1 \\ b_{up}^2 - b_{ref}^2 \end{bmatrix}, \quad A_U^1 \triangleq \begin{bmatrix} -1 & 0 \\ 0 & -1 \\ 1 & 0 \\ 0 & 1 \end{bmatrix},$$

$$b_U^1 \triangleq \begin{bmatrix} 0 \\ 0 \\ C_{up}^1 \\ C_{up}^2 \end{bmatrix}, \quad A_W^1 \triangleq \begin{bmatrix} -1 & 0 \\ 0 & -1 \\ 1 & 0 \\ 0 & 1 \end{bmatrix}, \quad b_W^1 \triangleq \begin{bmatrix} 0 \\ 0 \\ C_{up}^1 \\ C_{up}^2 \end{bmatrix}.$$

For $w^1 = 0$ and $u^1 = 0$ equilibrium $\tilde{x}_{eq}^1 = 0$ of the transformed system (3.81) then corresponds to the equilibrium $z_{eq}^1 = z_{ref}^1$ of the system in original coordinates, i.e. (3.74).

Note that the second component of f^1 is discontinuous along $x_2^1 = 0$. Based on a piecewise linear approximation of (3.81) for $w^1 = 0$, i.e.

$$f^1(x_k^1, u_k^1) = g_1(x_k^1) + g_2^j(x_k^1)u_k^1 \approx Ax_k^1 + B^j u_k^1, \quad \text{when } x_k^1 \in \Omega_j^1, \quad j \in \{1, 2\}, \quad (3.82)$$

where

$$\begin{aligned}
 A &\triangleq \left. \frac{\partial(g_1(x) + g^j(x)u)}{\partial x} \right|_{x=0, u=0} = \begin{bmatrix} 1 & 0 \\ 0 & 1 \end{bmatrix}, \\
 B^1 &\triangleq \left. \frac{\partial(g_1(x) + g_2^2(x)u)}{\partial x} \right|_{x=0, u=0} = \begin{bmatrix} -\frac{b_{ref}^1}{1+b_{ref}^1} & 0 \\ \frac{b_{ref}^1}{1+b_{ref}^1} & -\frac{b_{ref}^2}{1+b_{ref}^2} \end{bmatrix}, \\
 B^2 &\triangleq \left. \frac{\partial(g_1(x) + g_2^1(x)u)}{\partial x} \right|_{x=0, u=0} = \begin{bmatrix} -\frac{b_{ref}^1}{1+b_{ref}^1} & 0 \\ 0 & -\frac{b_{ref}^2}{1+b_{ref}^2} \end{bmatrix},
 \end{aligned}$$

As an illustration, in Figure 3.5 for some fixed control $u_k^1 \in \mathbb{U}^1$ both the function $f^1(x_k^1, u_k^1)$ and its piecewise linear approximation, i.e. (3.82), are plotted for system parameters

$$\begin{aligned}
 \bar{b}^2 &= 7 \text{ [products]}, \\
 b_{ref}^1 &= b_{ref}^2 = 6 \text{ [products]}, \\
 C_{up}^1 &= C_{up}^2 = 5 \text{ [products/time unit]}, \\
 b_{up}^1 &= 30 \text{ [products]}, \\
 b_{up}^2 &= 25 \text{ [products]}.
 \end{aligned} \tag{3.83}$$

Based on this piecewise linear approximation the following matrices

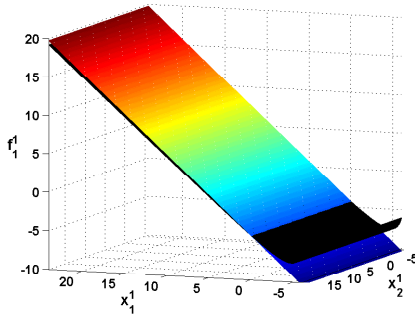

(a) Plot of $f_1^1(x_k^1, u_k^1)$ and its piecewise linear approximation as function of x_k^1 on the domain \mathbb{X}^1 for $u_k^1 = [5 \ 1]^\top$.

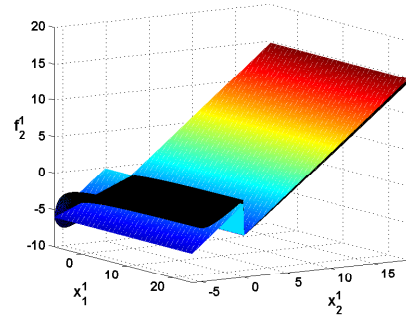

(b) Plot of $f_2^1(x_k^1, u_k^1)$ and its piecewise linear approximation as function of x_k^1 on the domain \mathbb{X}^1 for $u_k^1 = [5 \ 5]^\top$.

Figure 3.5:

$$\begin{aligned}
 P_V^1 &= \begin{bmatrix} 1.0443 & 0.0447 \\ -0.0073 & 0.9572 \end{bmatrix}, & P_V^2 &= \begin{bmatrix} 0.9805 & -0.0242 \\ -0.0343 & 0.9619 \end{bmatrix}, \\
 Q_V^1 &= \begin{bmatrix} 0.0475 & 0.0070 \\ 0.0090 & 0.0431 \end{bmatrix}, & Q_V^2 &= \begin{bmatrix} 0.1836 & 0.0836 \\ 0.2746 & 0.3791 \end{bmatrix}, \\
 K^1 &= \begin{bmatrix} 0.9867 & -0.0150 \\ 0.0128 & 1.0144 \end{bmatrix}, & \text{and } K^2 &= \begin{bmatrix} 0.9482 & 0.0202 \\ 0.0641 & 1.0108 \end{bmatrix}
 \end{aligned}$$

are obtained following the procedure in Section 3.2. The matrices P_V^1 , P_V^2 , Q_V^1 , Q_V^2 , K^1 and K^2 satisfy the inequalities (3.54) of Lemma 3.2.15 for $\mathcal{S}_{tr}^{PWA} = \{[1 \ 1]^\top, [1 \ 2]^\top, [2 \ 1]^\top, [2 \ 2]^\top\}$, i.e. see (3.53), and $\tau_{ji} = 0$ for all $[j \ i] \in \mathcal{S}_{tr}^{PWA}$.

Note that the disturbance set \mathbb{W}^1 , defined in (3.78), can be written as $\mathbb{W}^1 = \mathbb{S}_1 \cup \mathbb{S}_2$, i.e. $M = 2$ with

$$\mathbb{S}_1 = \text{Co} \{0, \varpi^1, \varpi^2\}, \quad \mathbb{S}_2 = \text{Co} \{0, \varpi^2, \varpi^3\},$$

with

$$\varpi^1 \triangleq \begin{bmatrix} C_{up}^1 \\ 0 \end{bmatrix}, \quad \varpi^2 \triangleq \begin{bmatrix} C_{up}^1 \\ C_{up}^2 \end{bmatrix}, \quad \varpi^3 \triangleq \begin{bmatrix} 0 \\ C_{up}^2 \end{bmatrix}. \quad (3.84)$$

Now a model predictive control scheme is employed based on Algorithm 3.2.11. In order to give Algorithm 3.2.11 feedback to disturbances step 3 in Algorithm 3.2.11 is replaced by step 1 of Algorithm 3.3.3 with inequalities in (3.67a) and (3.67b) replaced by

$$\max_{i \in \mathcal{S}_{tr,k}^j} (|P_V^i|_p) |g^j(x_{k|k}, u_{k|k})|_p - |P_V^j x_{k|k}|_p \leq -|Q_V^j x_{k|k}|_p, \quad (3.85a)$$

$$\max_{i \in \mathcal{S}_{tr,k}^j} (|P_V^i|_p) |g^j(x_{k|k}, u_{k|k}) + \varpi^e|_p - |P_V^j x_{k|k}|_p + |Q_V^j x_{k|k}|_p - \lambda^e, \quad e \in \mathbb{Z}_{[1,3]}. \quad (3.85b)$$

To simultaneously achieve item 1 and 2 in Problem 3.4.2 the following model predictive control costs are minimized

$$J^1(\tilde{x}_k^1, \mathbf{u}_k^{[0, N-1]}, \Lambda_k^1) \triangleq |R_\lambda^1 \Lambda_k^1|_\infty + |P^1 x_{k+N|k}|_\infty + \sum_{i=0}^{N-1} (|Q^1 x_{k+i|k}|_\infty + |R_u^1 u_{k+i|k}|_\infty) \quad (3.86)$$

with

$$\Lambda_k^1 \triangleq \begin{bmatrix} \lambda_k^1 \\ \vdots \\ \lambda_k^3 \end{bmatrix}, \quad R_\lambda^1 \triangleq \begin{bmatrix} 1 & 0 & 0 \\ 0 & 1 & 0 \\ 0 & 0 & 1 \end{bmatrix}, \quad P^1 \triangleq Q^1 \triangleq R_u^1 \triangleq \begin{bmatrix} 1 & 0 \\ 0 & 1 \end{bmatrix}.$$

To obtain a computationally cheap model predictive control scheme let $p = \infty$ and $N = 1$, i.e see Corollary 3.2.9. The particular linear programming problem that follows, to solve step 1 of Algorithm 3.3.3 with costs (3.86) and with inequalities in (3.67a) and (3.67b) replaced by (3.85a) and (3.85a), respectively, is then given by

$$\min_{\Lambda_k^1, u_{k|k}, \varepsilon_Q^1, \varepsilon_P^1, \varepsilon_{R_u}^1, \varepsilon_{R_\lambda}^1} \left\{ \varepsilon_Q^1 + \varepsilon_P^1 + \varepsilon_{R_u}^1 + \varepsilon_{R_\lambda}^1 \right\}$$

subject to:

$$A_{LP}^1 \left[\Lambda_k^{1\top} \quad u_{k|k}^\top \quad \varepsilon_Q^1 \quad \varepsilon_P^1 \quad \varepsilon_{R_u}^1 \quad \varepsilon_{R_\lambda}^1 \right]^\top \leq b_{LP}^1$$

where

$$\begin{array}{c} \underbrace{A_{LP}^1(x_{k|k}, j)}_{\|\triangleright} \\ \left[\begin{array}{cccccc} -I_{r_\lambda} & 0 & 0 & 0 & 0 & 0 \\ R_\lambda^1 & 0 & 0 & 0 & 0 & -\mathbf{1}^{r_\lambda} \\ -R_\lambda^1 & 0 & 0 & 0 & 0 & -\mathbf{1}^{r_\lambda} \\ 0 & 0 & -\mathbf{1}^{nq} & 0 & 0 & 0 \\ 0 & 0 & -\mathbf{1}^{nq} & 0 & 0 & 0 \\ 0 & P^1 g_2^j(x_{k|k}) & 0 & -\mathbf{1}^{np} & 0 & 0 \\ 0 & -P^1 g_2^j(x_{k|k}) & 0 & -\mathbf{1}^{np} & 0 & 0 \\ 0 & R_u^1 & 0 & 0 & -\mathbf{1}^{ru} & 0 \\ 0 & -R_u^1 & 0 & 0 & -\mathbf{1}^{ru} & 0 \\ 0 & 0 & -1 & 0 & 0 & 0 \\ 0 & 0 & 0 & -1 & 0 & 0 \\ 0 & 0 & 0 & 0 & -1 & 0 \\ 0 & 0 & 0 & 0 & 0 & -1 \\ 0 & g_2^j(x_{k|k}) & 0 & 0 & 0 & 0 \\ 0 & -g_2^j(x_{k|k}) & 0 & 0 & 0 & 0 \\ M_{P_V}^1 & g_2^j(x_{k|k}) & 0 & 0 & 0 & 0 \\ M_{P_V}^1 & -g_2^j(x_{k|k}) & 0 & 0 & 0 & 0 \\ M_{P_V}^2 & g_2^j(x_{k|k}) & 0 & 0 & 0 & 0 \\ M_{P_V}^2 & -g_2^j(x_{k|k}) & 0 & 0 & 0 & 0 \\ M_{P_V}^3 & g_2^j(x_{k|k}) & 0 & 0 & 0 & 0 \\ M_{P_V}^3 & -g_2^j(x_{k|k}) & 0 & 0 & 0 & 0 \\ 0 & A_X^1 g_2^j(x_{k|k}) & 0 & 0 & 0 & 0 \\ 0 & A_U^1 & 0 & 0 & 0 & 0 \end{array} \right] \end{array}, \quad \begin{array}{c} \underbrace{b_{LP}^1(x_{k|k}, j)}_{\|\triangleright} \\ \left[\begin{array}{c} 0 \\ 0 \\ 0 \\ -Q^1 x_{k|k} \\ Q^1 x_{k|k} \\ -P^1 g_1(x_{k|k}) \\ P^1 g_1(x_{k|k}) \\ 0 \\ 0 \\ 0 \\ 0 \\ 0 \\ 0 \\ 0 \\ -g_1^j(x_{k|k}) + \mathbf{1}^n \vartheta^j(x_{k|k}) \\ g_1^j(x_{k|k}) + \mathbf{1}^n \vartheta^j(x_{k|k}) \\ -g_1^j(x_{k|k}) + \mathbf{1}^n \vartheta^j(x_{k|k}) - \bar{\omega}^1 \\ g_1^j(x_{k|k}) + \mathbf{1}^n \vartheta^j(x_{k|k}) + \bar{\omega}^1 \\ -g_1^j(x_{k|k}) + \mathbf{1}^n \vartheta^j(x_{k|k}) - \bar{\omega}^2 \\ g_1^j(x_{k|k}) + \mathbf{1}^n \vartheta^j(x_{k|k}) + \bar{\omega}^2 \\ -g_1^j(x_{k|k}) + \mathbf{1}^n \vartheta^j(x_{k|k}) - \bar{\omega}^3 \\ g_1^j(x_{k|k}) + \mathbf{1}^n \vartheta^j(x_{k|k}) + \bar{\omega}^3 \\ b_X^1 - A_X^1 g_1^j(x_{k|k}) \\ b_U^1 \end{array} \right] \end{array},$$

with

$$\rho_V^j \triangleq \left(\max_{i \in \mathcal{S}_{ir,k}^j} |P_V^i| \right)^{-1}, \quad M_{P_V}^1 \triangleq \left[-\mathbf{1}^n \rho_V^j \quad 0 \quad 0 \right], \quad M_{P_V}^2 \triangleq \left[0 \quad -\mathbf{1}^n \rho_V^j \quad 0 \right],$$

$$M_{P_V}^3 \triangleq \left[0 \quad 0 \quad -\mathbf{1}^n \rho_V^j \right], \quad \vartheta^j(x_{k|k}) \triangleq \rho_V^j \left(|P_V^j x_{k|k}|_\infty - |Q_V^j x_{k|k}|_\infty \right), \quad r_\lambda \triangleq 3.$$

The set $\mathcal{S}_{tr,k}^j$ in the model predictive control scheme is solved as indicated in Step 2 of Algorithm 3.2.11 and involves, for this example, verifying whether for given $x_{k|k}$ and j the outcome of the following two tests is true or false.

test 1) Solve the following linear program

$$\min_{\tilde{\xi}, \mu, \omega} \quad (3.87)$$

subject to:

$$\begin{aligned} A_{reach}^{11} \begin{bmatrix} \tilde{\xi} & \mu & \omega \end{bmatrix}^\top &\leq b_{reach}^1 \\ B_{reach}^1(x_{k|k}, j) \begin{bmatrix} \tilde{\xi} & \mu & \omega \end{bmatrix}^\top &= g_1(x_{k|k}) \end{aligned},$$

where

$$A_{reach}^{11} \triangleq \begin{bmatrix} A_X^1 & 0 & 0 \\ 0 & A_U^1 & 0 \\ 0 & 0 & A_W^1 \\ H_{\Omega_1}^1 & 0 & 0 \end{bmatrix}, \quad b_{reach}^1 \triangleq \begin{bmatrix} b_X^1 \\ b_U^1 \\ b_W^1 \\ 0 \end{bmatrix}, \quad B_{reach}^1(x_{k|k}, j) \triangleq \begin{bmatrix} I_n \\ g_2^j(x_{k|k}) \\ -I_n \end{bmatrix}^\top.$$

If the linear programming problem (3.87) is feasible then the outcome of test 2 is *true* and *false* otherwise.

test 2) Solve the following linear program

$$\min_{\tilde{\xi}, \mu, \omega} \quad (3.88)$$

subject to:

$$\begin{aligned} A_{reach}^{12} \begin{bmatrix} \tilde{\xi} & \mu & \omega \end{bmatrix}^\top &\leq b_{reach}^1 \\ B_{reach}^1(x_{k|k}, j) \begin{bmatrix} \tilde{\xi} & \mu & \omega \end{bmatrix}^\top &= g_1(x_{k|k}), \end{aligned}$$

where

$$A_{reach}^{12} \triangleq \begin{bmatrix} A_X^1 & 0 & 0 \\ 0 & A_U^1 & 0 \\ 0 & 0 & A_W^1 \\ -H_{\Omega_2}^1 & 0 & 0 \end{bmatrix}.$$

If the linear programming problem (3.88) is feasible then let $\tilde{\xi}^*$, μ^* and ω^* denote its corresponding solution. Then if

$$A_{reach}^{12} \begin{bmatrix} \tilde{\xi}^* & \mu^* & \omega^* \end{bmatrix}^\top \neq b_{reach}^1, \quad (3.89)$$

the outcome of test 2 is *true* and *false* otherwise.

Then,

$$\mathcal{S}_{tr,k}^i = \begin{cases} \{1, 2\} & \text{if test 1 is true \& test 2 is true,} \\ \{1\} & \text{if test 1 is true \& test 2 is false,} \\ \{2\} & \text{if test 1 is false \& test 2 is true.} \end{cases}$$

Simulation result

System (3.74) with the system parameters given in (3.83) is considered. For system (3.74) in closed-loop with the designed model predictive controller with feedback to disturbance, a simulation is performed. The result of the simulation is shown in Figure 3.6, 3.7 and 3.8. Note that, although the controller design is performed for the transformed system (3.81), the simulation results are presented in the original coordinates b_k^1 and b_k^2 corresponding to system (3.74), which represent the buffer contents of buffer B_1 and B_2 , respectively. The simulation result of the controller with feedback to disturbance is compared to the response of the system (3.74) in closed-loop with Algorithm 3.2.11, i.e. no feedback to disturbance, with MPC cost as in (3.86) with $R_\lambda^1 = 0$. The closed-loop systems with feedback to disturbance, is perturbed with the disturbance signal w_k^1 taking values in \mathbb{W}^1 . In order to indicate the input-to-state stability property of the closed-loop system, i.e. convergence to the equilibrium if the external disturbance vanishes, the disturbance is taken identically 0 starting from time step $k = 150$. The same scenario is applied to the closed-loop system without feedback to disturbance. However, to the system without feedback to disturbance, a disturbance with a lower amplitude is employed due to feasibility problems. Note that due to the fact that the excitation level of the closed-loop without feedback to disturbance is milder, the influence on the evolution of the state, i.e. buffer levels, is significantly larger. Hence, when employing the controller with feedback to disturbances to control one node in a manufacturing network, given by (3.76), it will still perform well to establish the afore formulated overall control goal, while the performance of the controller without feedback to disturbances will be deteriorated due to the persistent disturbance w^1 that will be present. The persistent disturbance w^i , $i = 1, \dots, N_o$ are present due to the fact that the terms h_v^i , $i = 1, \dots, N_o$, in (3.76), which represent node interactions that are hard to model in practice, are neglected in the (local) controller design for the nodes in the overall manufacturing system.

This example illustrates an approach how one can divide a complex manufacturing network into nodes of less complexity and design a controller for each node individually and taking node interaction, which is hard to model in the case of manufacturing systems, into consideration via a additive disturbances. Subsequential the individual controller is designed such that an individual performance requirement is met and the un-modeled node interaction, modeled via additive disturbance, is rejected. This

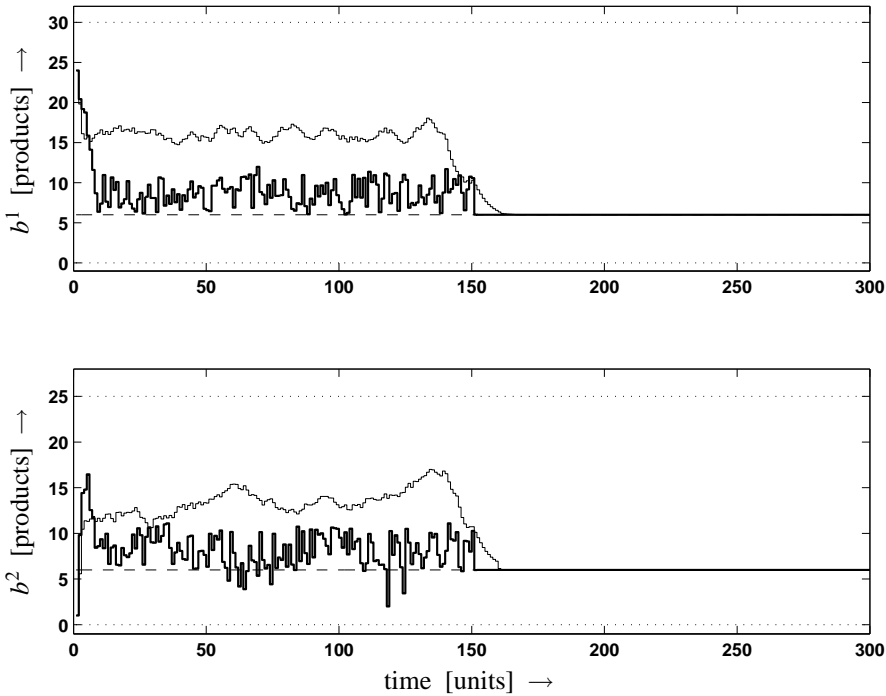

Figure 3.6: The system response for system with feedback to disturbances (tick line) and without (thin line). Constraints and desired reference buffer level (z_{ref}^1) is indicated with dotted and dashed lines, respectively.

will then guarantee overall performance of the controlled network. A besides the tremendous complexity reduction of the controller design for manufacturing systems the benefit of this decentralized control approach is that the computations involved for each controller can be performed in *parallel* such that computational time is reduced compared to solving the control problem as one (untractable) control problem.

3.5 Summary

An approach to design a computationally friendly sub-optimal nonlinear (hybrid) model predictive control algorithm with an a priori input-to-state stability guarantee of the closed-loop system, i.e. the to-be-controlled system in closed-loop with the nonlinear model predictive control algorithm, with respect to additive disturbances is presented. For the nonlinear model predictive controller, the input-to-state stabiliza-

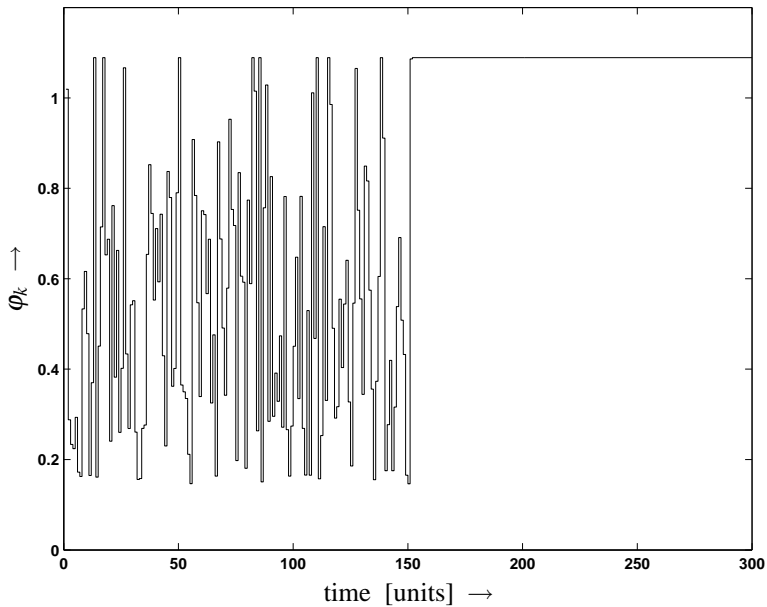

Figure 3.7: Plot of φ_k as function of time. The variable φ_k , see (3.57), can be taken a measure of how well the additive disturbance w_k^1 is suppressed ($\varphi_k = 0$ means all disturbance is rejected, i.e. the additive disturbance w_k^1 has no influence on the evolution of the state or buffer levels)

tion constraints can be written as a finite number of linear inequalities. To enhance robust performance, the model predictive control scheme is modified to allow for on-line optimization of the ISS-gain of the resulting closed-loop system. This induces feedback to (additive) disturbances and results in improved performance. It is illustrated how the proposed model predictive control scheme can be employed to solve large scale manufacturing control problems, that possibly exhibit discontinuous hybrid behaviors, in an efficient decentralized manner.

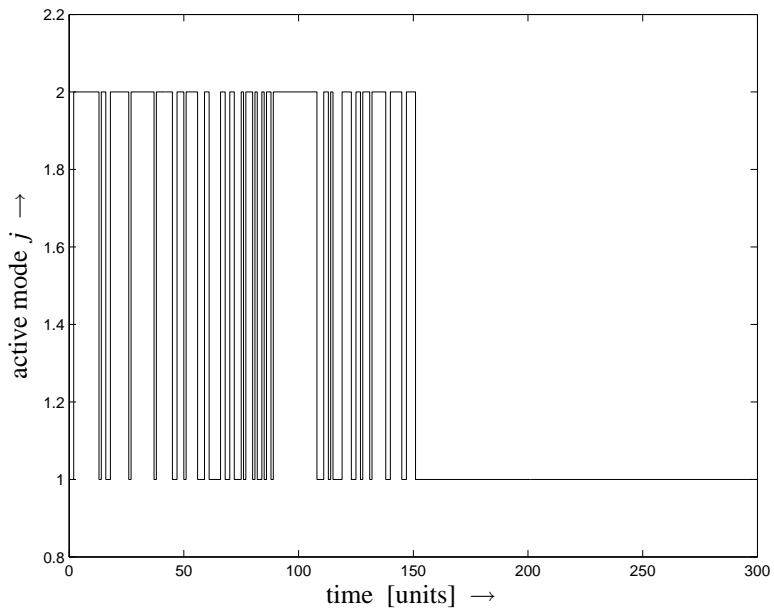

Figure 3.8: Active mode $j \in \{1, 2\}$ as function of time

Science has proof without any certainty. Creationists have certainty without any proof

Ashley Montague

4

Robustness results for constrained nonlinear closed-loop systems

In this chapter a result is presented that can be employed to infer robustness of a state feedback control law, in closed-loop with a *constrained* discrete-time nonlinear control system, to *state measurement errors* from robustness to *additive disturbances*. The result allows for possible discontinuity and set-valuedness of the state feedback control law. In particular, this enables the employment of the main result to obtain model predictive controllers that are robust to *state measurement errors* from available model predictive controllers in the literature, which are robust to *additive disturbances*.

In practice state variables of a control system are always corrupted by *state measurement errors*. *State measurement errors* can be caused by measurement noise present in sensor read-outs or by state estimation errors caused by the usage of observers. It is therefore important that state feedback controllers are designed such that they are robust to state measurement errors. In this chapter the notion of input-to-state stability is used to study robustness of *discrete-time* nonlinear systems subject to state measurement errors. Only few results on input-to-state stability with respect to state measurement errors are available in literature, especially if constraints on the state and the control have to be taken into account. In [87] an input-to-state stability result is given for *smooth* state feedback control laws perturbed by state measurement errors in closed-loop with a *continuous-time* nonlinear control system. For *discrete-time* nonlinear systems, robustness results to *state measurement errors* were obtained in [69, 88]. The result in [69] holds under the assumption that the state feedback control law is Lipschitz continuous. Although in [88] no Lipschitz continuity of the state feedback control law is required, constraints on the state and the control of the system dynamics are not incorporated. Furthermore, the result in [88] requires continuity of the system dynamics with respect to the state and the control.

The aim of this chapter is to extend the above mentioned work to the case of nonlinear control systems with *constraints* on the *state* and the *control* and possible discontinuous and/or set-valued state feedback control laws to include especially those generated via model predictive control. Indeed, to exploit one of the assets of model predictive control in being one of the few control strategies to deal in a systematic way with constraints, an extension of [69, 88] towards *constrained* systems is needed and important. Moreover, recall that one has to include set-valuedness as it can occur in model predictive control that due to non-uniqueness of the (sub)optimal control sequence of the model predictive control optimization problem, see Section 3.1. Also discontinuity has to be accounted for, as it is known that model predictive controllers can generate discontinuous feedbacks. Another important reason for allowing for discontinuous feedbacks is the existence of nonlinear systems that can be stabilized by discontinuous feedbacks, but not by continuous ones.

The main result of this chapter shows how one can infer input-to-state stability with respect to *state measurement errors* for a state feedback in closed-loop with a constrained discrete-time nonlinear system from input-to-state stability with respect to *additive disturbances*. To stress the value of this transformation result, synthesis methodologies that result in closed-loop systems that are input-to-state stable with respect to measurement errors, especially in the field of model predictive control for state and control constrained nonlinear systems, are rare, while there are relatively many input-to-state stability results in the model predictive control literature on *additive disturbances*, see e.g. [44, 45, 46, 47] and Chapter 3 of this thesis. Also in [42] the authors study robustness of constrained MPC to additive disturbances (in a weaker sense than ISS) and, moreover, they mention the problem of state measurement errors. In this chapter the focus is on the latter, i.e. measurement errors, and the main result provides a direct and simple method to transform a broad range of existing *constrained* model predictive control results, e.g. [44, 45, 46, 47], that generate input-to-state stable closed-loop systems with respect to *additive disturbances* into closed-loop systems that are also input-to-state stable with respect to *state measurement errors*. Furthermore, under some additional assumptions the transformation result can also be employed to draw conclusions about input-to-state stability of closed-loop systems perturbed by *state measurement errors* and *actuator noise* simultaneously.

This chapter is organized as follows. First the robustness issue with respect to state measurement errors is considered in Section 4.1. In Section 4.2 the robustness issue with respect to state measurement errors *and* actuator noise is considered. In Section 4.3 it is explained how the results obtained in this chapter can be employed in the context of manufacturing system control to tread the issue pointed-out in the end of Section 1.5. Conclusions are summarized in Section 4.4.

4.1 Robustness to measurement errors

Consider the constrained closed-loop system

$$x_{k+1} = f(x_k, u_k) \quad \text{with} \quad u_k \in \kappa(x_k), \quad k \in \mathbb{Z}_+, \quad (4.1)$$

where $x_k \in \mathbb{X} \subseteq \mathbb{R}^n$ and $u_k \in \mathbb{U} \subseteq \mathbb{R}^m$ are the state and the control input, respectively, at discrete-time $k \in \mathbb{Z}_+$. The sets \mathbb{X} and \mathbb{U} are known sets with 0 in their interior and represent the state and input constraints, respectively. The function $\kappa : \widetilde{\mathcal{X}} \rightarrow \mathbb{U}$ is a set-valued state feedback law defined on $\widetilde{\mathcal{X}} \subseteq \mathbb{X}$ that is allowed to be discontinuous. Finally, the function $f : \mathbb{X} \times \mathbb{U} \rightarrow \mathbb{X}$ satisfies $f(0, 0) = 0$ and the following assumption.

Assumption 4.1.1 The function $f : \mathbb{X} \times \mathbb{U} \rightarrow \mathbb{X}$ is uniformly continuous in x in the sense that there exists a \mathcal{H} -function $\widetilde{\eta}_f$ such that

$$|f(\xi^1, \mu) - f(\xi^2, \mu)| \leq \widetilde{\eta}_f(|\xi^1 - \xi^2|)$$

for all $\xi^1, \xi^2 \in \mathbb{X}$ and all $\mu \in \mathbb{U}$.

Note that all functions f that are Lipschitz continuous in x with Lipschitz constant L_f , satisfy Assumption 4.1.1 with $\widetilde{\eta}(s) = L_f s$. Consider the following perturbed versions of the closed-loop system (4.1).

$$\widetilde{x}_{k+1} \in f(\widetilde{x}_k, \kappa(\widetilde{x}_k)) + w_k \triangleq \mathcal{F}_w(\widetilde{x}_k, w_k), \quad k \in \mathbb{Z}_+, \quad (4.2a)$$

$$x_{k+1} \in f(x_k, \kappa(x_k + e_k)) + d_k \triangleq \mathcal{F}_{e,d}(x_k, e_k, d_k), \quad k \in \mathbb{Z}_+, \quad (4.2b)$$

where \widetilde{x}_k, x_k are the state variables, $w_k \in \mathbb{W} \subseteq \mathbb{R}^n$, $d_k \in \mathbb{D} \subseteq \mathbb{R}^n$ the *additive disturbances* and $e_k \in \mathbb{E} \subseteq \mathbb{R}^n$ the *state measurement error* at discrete-time $k \in \mathbb{Z}_+$, respectively.

Assumption 4.1.2 Let

$$\mathbb{W} \triangleq \left\{ \omega \in \mathbb{R}^n \mid |\omega| \leq \lambda \right\}, \quad \text{for some } \lambda \in \mathbb{R}_{>0}. \quad (4.3)$$

Suppose that system (4.2a) is ISS in $\widetilde{\mathcal{X}} \subseteq \mathbb{X}$ with additive disturbances in \mathbb{W} with $0 \in \text{int}(\widetilde{\mathcal{X}})$, i.e. there exist a \mathcal{KL} -function $\beta_{\widetilde{x}}$ and a \mathcal{H} -function $\gamma_{\widetilde{x}}^w$ such that for all $\widetilde{x}_0 \in \widetilde{\mathcal{X}}$ and $w : \mathbb{Z}_+ \rightarrow \mathbb{W}$ all solutions $\widetilde{x} \in \mathcal{S}_{\mathcal{F}_w}(\widetilde{x}_0, w)$ satisfy

$$|\widetilde{x}_k| \leq \beta_{\widetilde{x}}(|\widetilde{x}_0|, k) + \gamma_{\widetilde{x}}^w(\|w\|), \quad \forall k \in \mathbb{Z}_+. \quad (4.4)$$

Furthermore, assume that $\widetilde{\mathcal{X}}$ is RPI for system (4.2a) with *additive disturbances* in \mathbb{W} .

Theorem 4.1.3 Suppose that Assumptions 4.1.1 and 4.1.2 hold and define the \mathcal{K}_∞ -function $\eta_f(s) = \tilde{\eta}_f(s) + s$ for $s \in \mathbb{R}_{\geq 0}$. Let $\lambda_e \in \mathbb{R}_{\geq 0}$ and $\lambda_d \in \mathbb{R}_{\geq 0}$ be such that $\lambda_e + \lambda_d \leq \lambda$ and define

$$\begin{aligned}\mathbb{E} &\triangleq \left\{ \varepsilon \in \mathbb{R}^n \mid |\varepsilon| \leq \eta_f^{-1}(\lambda_e) \right\}, \\ \mathbb{D} &\triangleq \left\{ \delta \in \mathbb{R}^n \mid |\delta| \leq \lambda_d \right\},\end{aligned}$$

and $\mathcal{X} \triangleq \tilde{\mathcal{X}} \sim \mathbb{E}$. Suppose that $0 \in \text{int}(\mathcal{X})$. Then, the following statements hold.

i) The set $\mathcal{X} \subseteq \mathbb{X}$ is an RPI set for closed-loop system (4.2b) with state measurement errors $e : \mathbb{Z}_+ \rightarrow \mathbb{E}$ and additive disturbances $d : \mathbb{Z}_+ \rightarrow \mathbb{D}$;

ii) The state and input constraints are satisfied for all trajectories of (4.2b) with initial states x_0 in \mathcal{X} , measurement errors in \mathbb{E} and additive disturbances in \mathbb{D} , i.e. for all $x \in \mathcal{S}_{\mathcal{F}_{e,d}}(x_0, e, d)$ with $x_0 \in \mathcal{X}$, $e : \mathbb{Z}_+ \rightarrow \mathbb{E}$ and $d : \mathbb{Z}_+ \rightarrow \mathbb{D}$ it holds that $x_k \in \mathbb{X}$ and $\kappa(x_k + e_k) \subseteq \mathbb{U}$ for all $k \in \mathbb{Z}_+$;

iii) The equilibrium point $x_{eq} = 0$ of closed-loop system (4.2b) is **input-to-state stable** in \mathcal{X} with respect to **state measurement errors** in \mathbb{E} and **additive disturbances** in \mathbb{D} . In particular, one has that for all $x_0 \in \mathcal{X}$, $e : \mathbb{Z}_+ \rightarrow \mathbb{E}$ and $d : \mathbb{Z}_+ \rightarrow \mathbb{D}$ all solutions $x \in \mathcal{S}_{\mathcal{F}_{e,d}}(x_0, e, d)$ satisfy

$$|x_k| \leq \beta_x(|x_0|, k) + \gamma_x^e(\|e\|) + \gamma_x^d(\|d\|), \quad \forall k \in \mathbb{Z}_+, \quad (4.5)$$

with $\beta_x(|x_0|, k) \triangleq \beta_{\tilde{x}}(2|x_0|, k)$, $\gamma_x^d(\|d\|) \triangleq \gamma_{\tilde{x}}^w(2\|d\|)$ and

$$\gamma_x^e(\|e\|) \triangleq \beta_{\tilde{x}}(2\|e\|, 0) + \gamma_{\tilde{x}}^w(2\eta_f(\|e\|)) + \|e\|.$$

Proof:

i) Let $\xi \in \mathcal{X}$, $\varepsilon \in \mathbb{E}$ and $\delta \in \mathbb{D}$. It will be shown that for all $\bar{\varepsilon} \in \mathbb{E}$,

$$[f(\xi, \kappa(\xi + \varepsilon)) + \delta] + \bar{\varepsilon} \subseteq \tilde{\mathcal{X}} \quad (4.6)$$

as this would prove that \mathcal{X} is RPI for (4.2b) according to Definition 2.3.1. One proceeds by observing that

$$f(\xi, \mu) + \delta + \bar{\varepsilon} = f(\tilde{\xi}, \mu) + \omega, \quad \forall \mu \in \kappa(\tilde{\xi}) \subseteq \mathbb{U} \quad (4.7)$$

with $\tilde{\xi} \triangleq \xi + \varepsilon$ and $\omega \triangleq f(\xi, \mu) - f(\tilde{\xi}, \mu) + \delta + \bar{\varepsilon}$. Using Assumption 4.1.1 yields $|f(\tilde{\xi} - \varepsilon, \mu) - f(\tilde{\xi}, \mu)| \leq \tilde{\eta}_f(|\varepsilon|)$. Therefore, it holds that for all $\varepsilon, \bar{\varepsilon} \in \mathbb{E}$, $\delta \in \mathbb{D}$ and $\tilde{\xi} \in \tilde{\mathcal{X}}$

$$\begin{aligned}|\omega| &= |f(\tilde{\xi} - \varepsilon, \mu) - f(\tilde{\xi}, \mu) + \delta + \bar{\varepsilon}| \leq \tilde{\eta}_f(|\varepsilon|) + |\delta| + |\bar{\varepsilon}|, \quad \forall \mu \in \kappa(\tilde{\xi}) \subseteq \mathbb{U} \\ &\leq \tilde{\eta}_f \circ \eta_f^{-1}(\lambda_e) + \lambda_d + \eta_f^{-1}(\lambda_e) = \lambda_e + \lambda_d \leq \lambda,\end{aligned} \quad (4.8)$$

which shows that $\omega \in \mathbb{W}$. Employing Assumption 4.1.2, i.e. $\tilde{\mathcal{X}}$ is RPI for system (4.2a) with additive disturbances in \mathbb{W} , (4.7) yields that for all $\xi \in \mathcal{X}$, $\varepsilon, \bar{\varepsilon} \in \mathbb{E}$ and $\delta \in \mathbb{D}$,

$$f(\xi, \mu) + \delta + \bar{\varepsilon} \subseteq \tilde{\mathcal{X}}, \quad \forall \mu \in \kappa(\xi + \varepsilon) \subseteq \mathbb{U},$$

which is equivalent to (4.6).

ii) Due to i), it holds that for any $x_0 \in \mathcal{X}$ and any $e : \mathbb{Z}_+ \rightarrow \mathbb{E}$, $d : \mathbb{Z}_+ \rightarrow \mathbb{D}$ all trajectories $x \in \mathcal{S}_{\mathcal{F}_{e,d}}(x_0, e, d)$ satisfy $x_k \in \mathcal{X} \subseteq \mathbb{X}$, $x_k + e_k \in \tilde{\mathcal{X}} \subseteq \mathbb{X}$ for all $k \in \mathbb{Z}_+$ and thus $u_k \in \kappa(x_k + e_k) \subseteq \mathbb{U}$ for all $k \in \mathbb{Z}_+$.

iii) Let x_0 in \mathcal{X} , $e : \mathbb{Z}_+ \rightarrow \mathbb{E}$, $d : \mathbb{Z}_+ \rightarrow \mathbb{D}$ and $x \in \mathcal{S}_{\mathcal{F}_{e,d}}(x_0, e, d)$. Perform the following coordinate change on (4.2b)

$$x_k = \tilde{x}_k - e_k, \quad \forall k \in \mathbb{Z}_+, \quad (4.9)$$

which gives

$$\tilde{x}_{k+1} \in f(\tilde{x}_k - e_k, \kappa(\tilde{x}_k)) + d_k + e_{k+1}, \quad k \in \mathbb{Z}_+, \quad (4.10)$$

or

$$\tilde{x}_{k+1} \in f(\tilde{x}_k, \kappa(\tilde{x}_k)) + w_k, \quad k \in \mathbb{Z}_+, \quad (4.11)$$

where

$$w_k \triangleq f(\tilde{x}_k - e_k, u_k) - f(\tilde{x}_k, u_k) + d_k + e_{k+1}, \quad (4.12)$$

for some $u_k \in \kappa(\tilde{x}_k) \subseteq \mathbb{U}$, $e_k, e_{k+1} \in \mathbb{E}$, $d_k \in \mathbb{D}$, $\tilde{x}_k \in \tilde{\mathcal{X}}$. Hence,

$$w_k \in \overline{\mathbb{W}} \triangleq \left\{ f(\tilde{\xi} - \varepsilon, \mu) - f(\tilde{\xi}, \mu) + \delta + \bar{\varepsilon} \mid \mu \in \kappa(\tilde{\xi}) \subseteq \mathbb{U}, \varepsilon, \bar{\varepsilon} \in \mathbb{E}, \delta \in \mathbb{D}, \tilde{\xi} \in \tilde{\mathcal{X}} \right\}.$$

The claim is that $\overline{\mathbb{W}} \subseteq \mathbb{W}$. Indeed, if $\omega \in \overline{\mathbb{W}}$, then one can use Assumption 4.1.1 to obtain that for all $\varepsilon, \bar{\varepsilon} \in \mathbb{E}$, $\delta \in \mathbb{D}$ and $\tilde{\xi} \in \tilde{\mathcal{X}}$ (4.8) holds, which implies that $\overline{\mathbb{W}} \subseteq \mathbb{W}$ and therefore $w_k \in \mathbb{W}$ for all $k \in \mathbb{Z}_+$. Due to the fact that $w_k \in \mathbb{W}$ for all $k \in \mathbb{Z}_+$ and $x_k + e_k \in \tilde{\mathcal{X}}$ for all $k \in \mathbb{Z}_+$ (as shown in item ii) of the proof) one obtains that $\tilde{x}_k \in \tilde{\mathcal{X}}$ for all $k \in \mathbb{Z}_+$. As a consequence, one can apply (4.4) of Assumption 4.1.2 to (4.11). Via (4.12) and using Assumption 4.1.1 in a similar manner as in (4.8), one obtains that for all $u_k \in \kappa(\tilde{x}_k) \subseteq \mathbb{U}$, $e_k, e_{k+1} \in \mathbb{E}$, $d_k \in \mathbb{D}$, $\tilde{x}_k \in \tilde{\mathcal{X}}$ and $k \in \mathbb{Z}_+$

$$\begin{aligned} |w_k| &\leq |f(\tilde{x}_k - e_k, u_k) - f(\tilde{x}_k, u_k) + d_k + e_{k+1}| \\ &\leq |f(\tilde{x}_k - e_k, u_k) - f(\tilde{x}_k, u_k)| + \|d\| + \|e\| \\ &\leq \tilde{\eta}_f(\|e\|) + \|e\| + \|d\| = \eta_f(\|e\|) + \|d\|. \end{aligned} \quad (4.13)$$

Substituting the last inequality of (4.13) into (4.4) gives

$$|\tilde{x}_k| \leq \beta_{\tilde{x}}(|\tilde{x}_0|, k) + \gamma_{\tilde{x}}^w(\eta_f(\|e\|) + \|d\|). \quad (4.14)$$

Applying (4.9) and property (4.14) yields

$$\begin{aligned}
 |x_k| &= |\tilde{x}_k - e_k| \leq |\tilde{x}_k| + |e_k| \leq \\
 &\leq \beta_{\tilde{x}}(|x_0 + e_0|, k) + \gamma_{\tilde{x}}^v(\eta_f(\|e\|) + \|d\|) + |e_k| \\
 &\leq \beta_{\tilde{x}}(|x_0| + |e_0|, k) + \gamma_{\tilde{x}}^v(2\eta_f(\|e\|)) + \gamma_{\tilde{x}}^v(2\|d\|) + \|e\| \\
 &\leq \beta_{\tilde{x}}(2|x_0|, k) + \beta_{\tilde{x}}(2|e_0|, k) + \gamma_{\tilde{x}}^v(2\eta_f(\|e\|)) + \gamma_{\tilde{x}}^v(2\|d\|) + \|e\| \\
 &\leq \beta_{\tilde{x}}(2|x_0|, k) + \beta_{\tilde{x}}(2\|e\|, 0) + \gamma_{\tilde{x}}^v(2\eta_f(\|e\|)) + \gamma_{\tilde{x}}^v(2\|d\|) + \|e\| \\
 &= \beta_x(|x_0|, k) + \gamma_x^e(\|e\|) + \gamma_x^d(\|d\|).
 \end{aligned}$$

■

As a corollary, one can obtain a similar result for

$$x_{k+1} \in f(x_k, \kappa(x_k + e_k)) \triangleq \mathcal{F}_e(x_k, e_k), \quad (4.15)$$

which is a special case of (4.2b), where one only considers measurement errors $e_k \in \mathbb{E}$ and no additive disturbances d_k . For illustration purposes, the corollary below considers the case where f is Lipschitz continuous in x .

Corollary 4.1.4 *Suppose that Assumption 4.1.2 holds and that f is Lipschitz continuous in x , i.e. Assumption 4.1.1 holds with $\tilde{\eta}_f(s) = L_f s$, $s \in \mathbb{R}_{\geq 0}$. Let*

$$\mathbb{E} \triangleq \left\{ \varepsilon \in \mathbb{R}^n \mid |\varepsilon| \leq \frac{\lambda}{(L_f + 1)} \right\}, \quad (4.16)$$

$\mathcal{X} \triangleq \tilde{\mathcal{X}} \sim \mathbb{E}$ and suppose $0 \in \text{int}(\mathcal{X})$. Then, the following statements hold.

- i) The set $\mathcal{X} \subseteq \mathbb{X}$ is an RPI set for closed-loop system (4.15) perturbed by state measurement errors in \mathbb{E} ;
- ii) The state and input constraints are satisfied for all trajectories of (4.15) with initial states x_0 in \mathcal{X} and measurement errors in \mathbb{E} , i.e. for all $x \in \mathcal{S}_{\mathcal{F}_e}(x_0, e)$ with $x_0 \in \mathcal{X}$ and $e : \mathbb{Z}_+ \rightarrow \mathbb{E}$ it holds that $x_k \in \mathbb{X}$ and $\kappa(x_k + e_k) \subseteq \mathbb{U}$ for all $k \in \mathbb{Z}_+$;
- iii) The equilibrium point $x_{eq} = 0$ of closed-loop closed-loop system (4.15) is **input-to-state stable** in \mathcal{X} with respect to **state measurement errors** in \mathbb{E} . In particular, one has that for all $x_0 \in \mathcal{X}$ and $e : \mathbb{Z}_+ \rightarrow \mathbb{E}$ all solutions $x \in \mathcal{S}_{\mathcal{F}_e}(x_0, e)$ satisfy

$$|x_k| \leq \beta_x(|x_0|, k) + \gamma_x^e(\|e\|), \quad \forall k \in \mathbb{Z}_+, \quad (4.17)$$

with $\beta_x(|x_0|, k) \triangleq \beta_{\tilde{x}}(2|x_0|, k)$ and

$$\gamma_x^e(\|e\|) \triangleq \beta_{\tilde{x}}(2\|e\|, 0) + \gamma_{\tilde{x}}^v((L_f + 1)\|e\|) + \|e\|.$$

Remark 4.1.5 Corollary 4.1.4 also applies in the unconstrained case, i.e. when $\mathbb{X} = \mathbb{R}^n$ and $\mathbb{U} = \mathbb{R}^m$, with the unbounded disturbance sets $\mathbb{W} = \mathbb{E} = \mathbb{R}^n$ ($\lambda = \infty$). In this case, the above result applies for $\tilde{\mathcal{X}} = \mathcal{X} = \mathbb{R}^n$ and yields a global input-to-state stability result with respect to measurement noise. A similar remark can be made for Theorem 4.1.3.

The derived results can be applied in the domain of model predictive control. In [43, 45, 46, 47] model predictive control laws are proposed that result in closed-loop systems that are input-to-state stable with respect to additive disturbances. In the setting of this chapter, \mathbb{X} are the state and \mathbb{U} are the input constraints and $\tilde{\mathcal{X}}$ is the feasible set for the model predictive control optimization problem. Applying Corollary 4.1.4 would yield directly a MPC state feedback law that is input-to-state stable in \mathcal{X} with respect to measurement errors in \mathbb{E} , where the relation between \mathbb{W} and \mathbb{E} is given in (4.16).

The result of Corollary 4.1.4 is also relevant for “certainty equivalence control,” where one designs *output* feedback controllers that generate the control via a state feedback law using an estimate of the state, which is obtained, for instance, from an observer. For linear systems, the separation principle gives a formal justification of this approach in the absence of constraints. Such a principle does not hold generally, when nonlinear systems and/or constraints are considered. In [89] one considers for instance the constrained *linear* case using a particular model predictive controller, while for *unconstrained* nonlinear discrete-time systems interesting results are available in e.g. [88, 90]. In the constrained linear and nonlinear case, Corollary 4.1.4 might be useful as it yields state feedbacks that are input-to-state stable with respect to measurement errors. If observers are available that yield globally asymptotically stable (GAS) estimation error dynamics (or satisfy other ISS properties), one might apply the well-known small gain results (see e.g. [41]) to prove that the closed-loop system is GAS see e.g. Chapter 5. For the constrained case, it might be necessary to run the observer a sufficiently large period of time to ensure that the estimation error is contained in \mathbb{E} , before switching on the state feedback controller using the estimated state. In the unconstrained case with $\mathbb{E} = \mathbb{R}^n$ as discussed in Remark 4.1.5, this is not necessary.

4.2 Robustness to measurement errors and actuator noise

Consider now the following perturbed versions of the constrained closed-loop systems (4.1)

$$\tilde{x}_{k+1} \in f(\tilde{x}_k, \kappa(\tilde{x}_k)) + w_k \triangleq \mathcal{F}_w(\tilde{x}_k, w_k), \quad k \in \mathbb{Z}_+, \quad (4.18a)$$

$$x_{k+1} \in f(x_k, \kappa(x_k + e_k) + e_{u,k}) + d_k \triangleq \mathcal{F}_{e,e_u,d}(x_k, e_k, e_{u,k}, d_k), \quad k \in \mathbb{Z}_+, \quad (4.18b)$$

where \tilde{x}_k, x_k are the state variables, $w_k \in \mathbb{W} \subseteq \mathbb{R}^n$, $d_k \in \mathbb{D} \subseteq \mathbb{R}^n$ the *additive disturbances*, $e_k \in \mathbb{E} \subseteq \mathbb{R}^n$ and $e_{u,k} \in \mathbb{E} \subseteq \mathbb{R}^m$ the *state measurement error* and *actuator noise* at discrete-time $k \in \mathbb{Z}_+$, respectively. Recall that $\kappa : \tilde{\mathcal{X}} \hookrightarrow \mathbb{U}$ is a set-valued state feedback law defined on $\tilde{\mathcal{X}} \subseteq \mathbb{X}$ that is allowed to be discontinuous. As such, the systems above are perturbed versions of closed-loop system (4.1), where (4.18b) is affected simultaneously by state measurement errors, actuator noise and additive disturbances, and (4.18a) only by additive disturbances.

In this section it will be shown, that by tightening up Assumptions 4.1.1 and 4.1.2, one can obtain a similar result for closed-loop system (4.18b) as is obtained in the previous section for closed-loop system (4.2b) based on properties of closed-loop system (4.18a)

Assumption 4.2.1 The function $f : \mathbb{X} \times \mathbb{U} \rightarrow \mathbb{X}$ is uniformly continuous in x and u in the sense that there exist \mathcal{K} -functions $\tilde{\eta}_{fx}$ and $\tilde{\eta}_{fu}$ such that

$$|f(\xi^1, \mu^1) - f(\xi^2, \mu^2)| \leq \tilde{\eta}_{fx}(|\xi^1 - \xi^2|) + \tilde{\eta}_{fu}(|\mu^1 - \mu^2|)$$

for all $\xi^1, \xi^2 \in \mathbb{X}$ and all $\mu^1, \mu^2 \in \mathbb{U}$.

Note that all functions f that are Lipschitz continuous in x and u with Lipschitz constants L_{fx} and L_{fu} , satisfy Assumption 4.1.1 with $\tilde{\eta}_{fx}(s) = L_{fx}s$ and $\tilde{\eta}_{fu}(s) = L_{fu}s$.

Assumption 4.2.2 Let

$$\mathbb{W} \triangleq \left\{ \omega \in \mathbb{R}^n \mid |\omega| \leq \lambda \right\}, \quad \text{for some } \lambda \in \mathbb{R}_{>0},$$

and

$$\mathbb{E}_u \triangleq \left\{ \varepsilon_u \in \mathbb{R}^m \mid |\varepsilon_u| \leq \lambda_u \right\}, \quad \text{for some } \lambda_u \in \mathbb{R}_{>0}.$$

Suppose that $x_{eq} = 0$ is an input-to-state stable equilibrium point of system (4.2) with respect to *additive disturbances* $w : \mathbb{Z}_+ \rightarrow \mathbb{W}$ and initial states \tilde{x}_0 in $\tilde{\mathcal{X}} \subseteq \mathbb{X}$ with $0 \in \text{int}(\tilde{\mathcal{X}})$, i.e. there exist a \mathcal{KL} -function $\beta_{\tilde{x}}$ and a \mathcal{K} -function $\gamma_{\tilde{x}}^w$ such that for all $\tilde{x}_0 \in \tilde{\mathcal{X}}$ and $w : \mathbb{Z}_+ \rightarrow \mathbb{W}$ all solutions $\tilde{x} \in \mathcal{S}_{\mathcal{F}_w}(\tilde{x}_0, w)$ satisfy

$$|\tilde{x}_k| \leq \beta_{\tilde{x}}(|\tilde{x}_0|, k) + \gamma_{\tilde{x}}^w(\|w\|), \quad \forall k \in \mathbb{Z}_+. \quad (4.19)$$

Furthermore, assume that $\tilde{\mathcal{X}}$ is RPI for system (4.2) perturbed by *additive disturbances* $w : \mathbb{Z}_+ \rightarrow \mathbb{W}$ and that

$$\kappa(\tilde{x}_k) \subseteq \mathbb{U} \sim \mathbb{E}_u, \quad \forall k \in \mathbb{Z}_+, \quad (4.20)$$

with $0 \in \text{int}(\mathbb{U} \sim \mathbb{E}_u)$.

Remark 4.2.3 Note that in case that a model predictive control algorithm is applied, i.e. $\kappa(\cdot) = \kappa^{\text{MPC}}(\cdot)$, then (4.20) in Assumption 4.2.2 can be realized by simply adding the constraint

$$u_{k|k} \in \mathbb{U} \sim \mathbb{E}_u \quad (4.21)$$

to the model predictive control optimization problem, e.g. add (4.21) to Algorithm 3.2.2.

Now the following result can be obtained.

Theorem 4.2.4 *Suppose Assumptions 4.2.1 and 4.2.2 hold and define the \mathcal{K}_∞ -function $\eta_{f_x}(s) = \tilde{\eta}_{f_x}(s) + s$ for $s \in \mathbb{R}_{\geq 0}$. Let $\lambda_e \in \mathbb{R}_{\geq 0}$ and $\lambda_d \in \mathbb{R}_{\geq 0}$ be such that $\lambda_e + \lambda_d + \tilde{\eta}_{f_u}(\lambda_u) \leq \lambda$ and define*

$$\begin{aligned} \mathbb{E} &\triangleq \left\{ \varepsilon \in \mathbb{R}^n \mid |\varepsilon| \leq \eta_{f_x}^{-1}(\lambda_e) \right\}, \\ \mathbb{D} &\triangleq \left\{ \delta \in \mathbb{R}^n \mid |\delta| \leq \lambda_d \right\}, \end{aligned}$$

and $\mathcal{X} \triangleq \tilde{\mathcal{X}} \sim \mathbb{E}$. Suppose that $0 \in \text{int}(\mathcal{X})$. Then, the following statements hold.

i) *The set $\mathcal{X} \subset \mathbb{X}$ is an RPI set for the closed-loop system (4.18b) perturbed by state measurement errors $e : \mathbb{Z}_+ \rightarrow \mathbb{E}$, actuator noise $e_u : \mathbb{Z}_+ \rightarrow \mathbb{E}_u$ and additive disturbances $d : \mathbb{Z}_+ \rightarrow \mathbb{D}$;*

ii) *The state and control constraints are satisfied for all trajectories of (4.2b) with initial states x_0 in \mathcal{X} , measurement errors $e : \mathbb{Z}_+ \rightarrow \mathbb{E}$, actuator noise $e_u : \mathbb{Z}_+ \rightarrow \mathbb{E}_u$ and additive disturbances $d : \mathbb{Z}_+ \rightarrow \mathbb{D}$, i.e. for all $x \in \mathcal{S}_{\mathcal{F}_{e,e_u,d}}(x_0, e, e_u, d)$ with $x_0 \in \mathcal{X}$, $e : \mathbb{Z}_+ \rightarrow \mathbb{E}$, $e_u : \mathbb{Z}_+ \rightarrow \mathbb{E}_u$ and $d : \mathbb{Z}_+ \rightarrow \mathbb{D}$ it holds that $x_k \in \mathbb{X}$ and $u_k \in \kappa(x_k + e_k) + e_{u,k} \subseteq \mathbb{U}$ for all $k \in \mathbb{Z}_+$;*

iii) *The equilibrium point $x_{eq} = 0$ of system (4.18b) is **input-to-state stable** with respect to **state measurement errors** $e : \mathbb{Z}_+ \rightarrow \mathbb{E}$, **actuator noise** $e_u : \mathbb{Z}_+ \rightarrow \mathbb{E}_u$ and **additive disturbances** $d : \mathbb{Z}_+ \rightarrow \mathbb{D}$ for initial states x_0 in \mathcal{X} . In particular, one has that for all $x_0 \in \mathcal{X}$, $e : \mathbb{Z}_+ \rightarrow \mathbb{E}$, $e_u : \mathbb{Z}_+ \rightarrow \mathbb{E}_u$ and $d : \mathbb{Z}_+ \rightarrow \mathbb{D}$ all solutions $x \in \mathcal{S}_{\mathcal{F}_{e,e_u,d}}(x_0, e, e_u, d)$ satisfy*

$$|x_k| \leq \beta_x(|x_0|, k) + \gamma_x^e(\|e\|) + \gamma_x^{e_u}\|e_u\| + \gamma_x^d\|d\|, \quad \forall k \in \mathbb{Z}_+, \quad (4.22)$$

with $\beta_x(|x_0|, k) \triangleq \beta_{\tilde{x}}(2|x_0|, k)$, $\gamma_x^{e_u}(\|e_u\|) \triangleq \gamma_{\tilde{x}}^v(3\tilde{\eta}_{f_u}(\|e_u\|))$, $\gamma_x^d(\|d\|) \triangleq \gamma_{\tilde{x}}^w(3\|d\|)$ and

$$\gamma_x^e(\|e\|) \triangleq \beta_{\tilde{x}}(2\|e\|, 0) + \gamma_{\tilde{x}}^w(3\eta_{f_x}(\|e\|)) + \|e\|.$$

Proof:

i) Let $\xi \in \mathcal{X}$, $\varepsilon \in \mathbb{E}$, $\varepsilon_u \in \mathbb{E}_u$ and $\delta \in \mathbb{D}$. It will be shown that for all $\bar{\varepsilon} \in \mathbb{E}$,

$$[f(\xi, \kappa(\xi + \varepsilon) + \varepsilon_u) + \delta] + \bar{\varepsilon} \subseteq \widetilde{\mathcal{X}} \quad (4.23)$$

as this would prove that \mathcal{X} is RPI for (4.18b) according to Definition 2.3.1. One proceeds by observing that

$$f(\xi, \mu + \varepsilon_u) + \delta + \bar{\varepsilon} = f(\tilde{\xi}, \mu) + \omega, \quad \forall \mu \in \kappa(\tilde{\xi}) \subseteq \mathbb{U} \sim \mathbb{E}_u \quad (4.24)$$

with $\tilde{\xi} \triangleq \xi + \varepsilon$ and $\omega \triangleq f(\xi, \mu + \varepsilon_u) - f(\tilde{\xi}, \mu) + \delta + \bar{\varepsilon}$. Using Assumption 4.2.1 yields $|f(\xi - \varepsilon, \mu + \varepsilon_u) - f(\tilde{\xi}, \mu)| \leq \tilde{\eta}_{f_x}(|\varepsilon|) + \tilde{\eta}_{f_u}(|\varepsilon_u|)$. Therefore, it holds that for all $\varepsilon, \bar{\varepsilon} \in \mathbb{E}$, $\varepsilon_u \in \mathbb{E}_u$, $\delta \in \mathbb{D}$ and $\tilde{\xi} \in \widetilde{\mathcal{X}}$

$$\begin{aligned} |\omega| &= |f(\tilde{\xi} - \varepsilon, \mu + \varepsilon_u) - f(\tilde{\xi}, \mu) + \delta + \bar{\varepsilon}|, \quad \forall \mu \in \kappa(\tilde{\xi}) \subseteq \mathbb{U} \sim \mathbb{E}_u \\ &\leq \tilde{\eta}_{f_x}(|\varepsilon|) + \tilde{\eta}_{f_u}(|\varepsilon_u|) + |\delta| + |\bar{\varepsilon}| \\ &\leq \tilde{\eta}_{f_x} \circ \eta_{f_x}^{-1}(\lambda_e) + \tilde{\eta}_{f_u}(\lambda_u) + \lambda_d + \eta_{f_x}^{-1}(\lambda_e) = \lambda_e + \lambda_d + \eta_{f_u}(\lambda_u), \end{aligned} \quad (4.25)$$

which shows that $\omega \in \mathbb{W}$. Employing Assumption 4.2.2, i.e. $\widetilde{\mathcal{X}}$ is RPI for system (4.18a) under additive disturbances $w : \mathbb{Z}_+ \rightarrow \mathbb{W}$, (4.24) yields that for all $\xi \in \mathcal{X}$, $\bar{\varepsilon} \in \mathbb{E}$, $\varepsilon_u \in \mathbb{E}_u$ and, $\delta \in \mathbb{D}$

$$f(\xi, \mu + \varepsilon_u) + \delta + \bar{\varepsilon} \subseteq \widetilde{\mathcal{X}}, \quad \forall \mu \in \kappa(\xi + \varepsilon) \subseteq \mathbb{U} \sim \mathbb{E}_u,$$

which is equivalent to (4.23).

ii) Due to i), it holds that for any $x_0 \in \mathcal{X}$ and any $e : \mathbb{Z}_+ \rightarrow \mathbb{E}$, $e_u : \mathbb{Z}_+ \rightarrow \mathbb{E}_u$ and $d : \mathbb{Z}_+ \rightarrow \mathbb{D}$ all trajectories $x \in \mathcal{S}_{\mathcal{F}_{e, e_u, d}}(x_0, e, e_u, d)$ satisfy $x_k \in \mathcal{X} \subseteq \mathbb{X}$, $x_k + e_k \in \widetilde{\mathcal{X}} \subseteq \mathbb{X}$ for all $k \in \mathbb{Z}_+$ and thus, due to (4.20), $u_k \in \kappa(x_k + e_k) + e_{u,k} \subseteq \mathbb{U}$ for all $k \in \mathbb{Z}_+$.

iii) Let $x_0 \in \mathcal{X}$, $e : \mathbb{Z}_+ \rightarrow \mathbb{E}$, $e_u : \mathbb{Z}_+ \rightarrow \mathbb{E}_u$, $d : \mathbb{Z}_+ \rightarrow \mathbb{D}$ and $x \in \mathcal{S}_{\mathcal{F}_{e, e_u, d}}(x_0, e, e_u, d)$. Perform the following coordinate change on (4.18b)

$$x_k = \tilde{x}_k - e_k, \quad \forall k \in \mathbb{Z}_+, \quad (4.26)$$

which gives

$$\tilde{x}_{k+1} \in f(\tilde{x}_k - e_k, \kappa(\tilde{x}_k) + e_{u,k}) + d_k + e_{k+1}, \quad k \in \mathbb{Z}_+,$$

or

$$\tilde{x}_{k+1} \in f(\tilde{x}_k, \kappa(\tilde{x}_k)) + w_k, \quad k \in \mathbb{Z}_+, \quad (4.27)$$

where

$$w_k \triangleq f(\tilde{x}_k - e_k, u_k) - f(\tilde{x}_k, u_k - e_{u,k}) + d_k + e_{k+1}, \quad (4.28)$$

for some $e_{u,k} \in \mathbb{E}_u$, $u_k \in \kappa(\tilde{x}_k) + e_{u,k} \subseteq \mathbb{U}$, $e_k, e_{k+1} \in \mathbb{E}$, $d_k \in \mathbb{D}$ and $\tilde{x}_k \in \tilde{\mathcal{X}}$. Hence,

$$w_k \in \overline{\mathbb{W}} \triangleq \left\{ f(\tilde{\xi} - \varepsilon, \mu + \varepsilon_u) - f(\tilde{\xi}, \mu) + \delta + \bar{\varepsilon} \mid \mu \in \kappa(\tilde{\xi}) \subseteq \mathbb{U} \sim \mathbb{E}_u, \varepsilon, \bar{\varepsilon} \in \mathbb{E}, \delta \in \mathbb{D}, \tilde{\xi} \in \tilde{\mathcal{X}} \right\}.$$

The claim is that $\overline{\mathbb{W}} \subseteq \mathbb{W}$. Indeed, if $\omega \in \overline{\mathbb{W}}$, then one can use Assumption 4.2.1 to obtain that for all $\varepsilon, \bar{\varepsilon} \in \mathbb{E}$, $\varepsilon_u \in \mathbb{E}_u$, $\delta \in \mathbb{D}$ and $\tilde{\xi} \in \tilde{\mathcal{X}}$ (4.25) holds, which implies that $\overline{\mathbb{W}} \subseteq \mathbb{W}$ and therefore $w_k \in \mathbb{W}$ for all $k \in \mathbb{Z}_+$. Due to the fact that $w_k \in \mathbb{W}$ for all $k \in \mathbb{Z}_+$ and $x_k + e_k \in \tilde{\mathcal{X}}$ for all $k \in \mathbb{Z}_+$ (as shown in item ii) of the proof) one obtains that $\tilde{x}_k \in \tilde{\mathcal{X}}$ for all $k \in \mathbb{Z}_+$. As a consequence, one can apply (4.19) of Assumption 4.2.2 to (4.27). Via (4.28) and employing Assumption 4.2.1 in a similar manner as in (4.25), one obtains that for all $u_k \in \kappa(\tilde{x}_k) \subseteq \mathbb{U} \sim \mathbb{E}_u$, $e_k, e_{k+1} \in \mathbb{E}$, $e_{u,k} \in \mathbb{E}_u$, $d_k \in \mathbb{D}$, $\tilde{x}_k \in \tilde{\mathcal{X}}$ and $k \in \mathbb{Z}_+$

$$\begin{aligned} |w_k| &\leq |f(\tilde{x}_k - e_k, u_k) - f(\tilde{x}_k, u_k - e_{u,k}) + d_k + e_{k+1}| \\ &\leq |f(\tilde{x}_k - e_k, u_k) - f(\tilde{x}_k, u_k - e_{u,k})| + \|d\| + \|e\| \\ &\leq \tilde{\eta}_{fx}(\|e\|) + \tilde{\eta}_{fu}(\|e_u\|) + \|d\| + \|e\| = \eta_{fx}(\|e\|) + \tilde{\eta}_{fu}(\|e_u\|) + \|d\|. \end{aligned} \quad (4.29)$$

Substituting the last inequality in (4.19) yields for all $k \in \mathbb{Z}_+$

$$|\tilde{x}_k| \leq \beta_{\tilde{x}}(|\tilde{x}_0|, k) + \gamma_{\tilde{x}}^w(\eta_{fx}(\|e\|) + \tilde{\eta}_{fu}(\|e_u\|) + \|d\|) \quad (4.30)$$

Applying (4.26) and property (4.30) yields

$$\begin{aligned} |x_k| &= |\tilde{x}_k - e_k| \leq |\tilde{x}_k| + |e_k| \leq \\ &\leq \beta_{\tilde{x}}(|x_0 + e_0|, k) + \gamma_{\tilde{x}}^w(\eta_{fx}(\|e\|) + \tilde{\eta}_{fu}(\|e_u\|) + \|d\|) \\ &\leq \beta_{\tilde{x}}(|x_0| + |e_0|, k) + \gamma_{\tilde{x}}^w(3\eta_{fx}(\|e\|)) + \gamma_{\tilde{x}}^w(3\tilde{\eta}_{fu}(\|e_u\|)) + \gamma_{\tilde{x}}^w(3\|d\|) + \|e\| \\ &\leq \beta_{\tilde{x}}(2|x_0|, k) + \beta_{\tilde{x}}(2|e_0|, k) + \gamma_{\tilde{x}}^w(3\eta_{fx}(\|e\|)) + \gamma_{\tilde{x}}^w(3\tilde{\eta}_{fu}(\|e_u\|)) + \gamma_{\tilde{x}}^w(3\|d\|) + \|e\| \\ &\leq \beta_{\tilde{x}}(2|x_0|, k) + \beta_{\tilde{x}}(2\|e\|, 0) + \gamma_{\tilde{x}}^w(3\eta_{fx}(\|e\|)) + \gamma_{\tilde{x}}^w(3\tilde{\eta}_{fu}(\|e_u\|)) + \gamma_{\tilde{x}}^w(3\|d\|) + \|e\| \\ &= \beta_x(|x_0|, k) + \gamma_x^e(\|e\|) + \gamma_x^u\|e_u\| + \gamma_x^d\|d\|. \end{aligned}$$

■

Similarly as is done in Section 4.1, one can obtain a similar result for

$$x_{k+1} \in f(x_k, \kappa(x_k + e_k) + e_{u,k}) \triangleq \mathcal{F}_e(x_k, e_k, e_{u,k}), \quad (4.31)$$

which is a special case of (4.18b), where one only considers measurement errors $e_k \in \mathbb{E}$ and actuator noise $e_u \in \mathbb{E}_u$ and no additive disturbances d_k . For illustration purposes, the corollary below considers the case where f is Lipschitz continuous in x and u . For the ease of exposition it is assumed that $\gamma_{\tilde{x}}^w(\cdot)$ in Assumption 4.2.2 is linear with respect to its argument

Corollary 4.2.5 *Suppose Assumption 4.2.2 holds and that f is Lipschitz continuous in x and u , i.e. Assumption 4.2.1 holds with $\tilde{\eta}_{f_x}(s) = L_{f_x}s$, $\tilde{\eta}_{f_u}(s) = L_{f_u}s$, $s \in \mathbb{R}_{\geq 0}$. Let*

$$\mathbb{E} \triangleq \left\{ \varepsilon \in \mathbb{R}^n \mid |\varepsilon| \leq \frac{\lambda - L_{f_u}\lambda_u}{(L_{f_x} + 1)} \right\},$$

$\mathcal{X} \triangleq \tilde{\mathcal{X}} \sim \mathbb{E}$ and suppose $0 \in \text{int}(\mathcal{X})$. Then, the following statements hold.

i) *The set $\mathcal{X} \subset \mathbb{X}$ is an RPI set for the closed-loop system (4.31) perturbed by state measurement errors $e : \mathbb{Z}_+ \rightarrow \mathbb{E}$ and actuator noise $e_u : \mathbb{Z}_+ \rightarrow \mathbb{E}_u$;*

ii) *The state and control constraints are satisfied for all trajectories of (4.31) with initial states x_0 in \mathcal{X} , measurement errors $e : \mathbb{Z}_+ \rightarrow \mathbb{E}$ and actuator noise $e_u : \mathbb{Z}_+ \rightarrow \mathbb{E}_u$, i.e. for all $x \in \mathcal{S}_{\mathcal{F}_{e,e_u}}(x_0, e, e_u)$ with $x_0 \in \mathcal{X}$ and $e : \mathbb{Z}_+ \rightarrow \mathbb{E}$, $e_u : \mathbb{Z}_+ \rightarrow \mathbb{E}_u$ it holds that $x_k \in \mathbb{X}$ and $u_k \in \kappa(x_k + e_k) + e_{u,k} \subseteq \mathbb{U}$ for all $k \in \mathbb{Z}_+$;*

iii) *The equilibrium point $x_{eq} = 0$ of system (4.31) is input-to-state stable with respect to state measurement errors $e : \mathbb{Z}_+ \rightarrow \mathbb{E}$, actuator noise $e_u : \mathbb{Z}_+ \rightarrow \mathbb{E}_u$ and initial states x_0 in \mathcal{X} . In particular, one has that for all $x_0 \in \mathcal{X}$, $e : \mathbb{Z}_+ \rightarrow \mathbb{E}$ and $e_u : \mathbb{Z}_+ \rightarrow \mathbb{E}_u$ all solutions $x \in \mathcal{S}_{\mathcal{F}_{e,e_u}}(x_0, e, e_u)$ satisfy*

$$|x_k| \leq \beta_x(|x_0|, k) + \gamma_x^e(\|e\|) + \gamma_x^{e_u}\|e_u\|, \quad \forall k \in \mathbb{Z}_+, \quad (4.32)$$

with $\beta_x(|x_0|, k) \triangleq \beta_{\bar{x}}(2|x_0|, k)$ and

$$\gamma_x^e(\|e\|) \triangleq \beta_{\bar{x}}(2\|e\|, 0) + \gamma_{\bar{x}}^w(L_{f_x} + 2)\|e\|, \quad \gamma_x^{e_u}\|e_u\| \triangleq \gamma_{\bar{x}}^w L_{f_u}\|e_u\|.$$

Remark 4.2.6 Corollary 4.2.5 also applies in the unconstrained case, i.e. when $\mathbb{X} = \mathbb{R}^n$ and $\mathbb{U} = \mathbb{R}^m$, with the unbounded disturbance sets $\mathbb{W} = \mathbb{E} = \mathbb{E}_u = \mathbb{R}^n$ ($\lambda = \lambda_u = \infty$). In this case, the above result applies for $\tilde{\mathcal{X}} = \mathcal{X} = \mathbb{R}^n$ and yields a global input-to-state stability result with respect to measurement noise and actuator noise. A similar remark can be made for Theorem 4.2.4.

4.3 Robustness in manufacturing system control

As is explained in Section 1.5, if controller synthesis for a discrete event manufacturing systems is performed based on the framework as depicted in Figure 1.4, it is not sufficient to design a model predictive controller that can guarantee (asymptotic) stability of the model predictive controller in closed-loop with the (piecewise) continuous (or discrete) time (partial) differential (or difference) equations (on which the controller synthesis is based on) to guarantee (asymptotic) stability of the model predictive controller in closed-loop with the discrete event manufacturing system. This

issue will be elaborated on in the sequel. Assume one has, somehow, obtained a (piecewise) continuous (or discrete) time (partial) differential (or difference) equation that describes the discrete event manufacturing system under consideration well. That is, the behavior of the discrete event manufacturing system can be described (or substituted) by a continuous (piecewise) continuous (or discrete) time (partial) differential (or difference) equation with an *injector* and *quantizer* at the input and output as depicted in Figure 4.1, respectively.

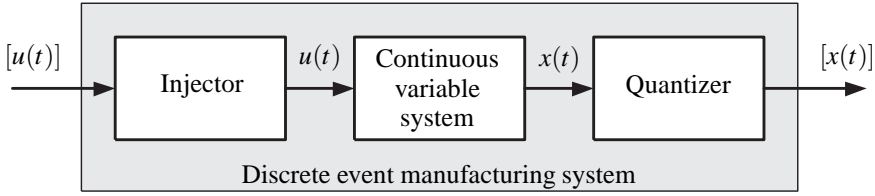

Figure 4.1: Discrete event manufacturing system represented by a composition of injector, continuous variable system and quantizer.

Through the *injector* a discrete¹ (control) signal, denoted in Figure 4.1 as $[u(t)]$, is transformed into a real-valued signal $u(t)$ that is (piecewise) continuous in time. The continuous signal $u(t)$ drives the continuous variable model which generates a (piecewise) continuous output $x(t)$. The signal $x(t)$ is then quantized by a *quantizer*, which results in a discrete output signal $[x(t)]$ representing the output of the discrete event manufacturing system. From discrete control $[u(t)]$ to discrete output $[x(t)]$ the system depicted in Figure 4.1 can be seen as a discrete event manufacturing system.

Mathematically, a *quantizer* in the context as just pointed out can be described by a piecewise constant function $q: \mathcal{D} \subset \mathbb{R}_+^n \rightarrow \mathcal{Q}_x$, where \mathcal{Q}_x is a finite subset of \mathbb{Z}_+ with a fixed number of elements S . We denote the elements of \mathcal{Q}_x by q_x^1, \dots, q_x^S and refer to them as quantization points. The sets $\mathcal{W}_x^i \triangleq \{x \in \mathcal{D} \mid q_x(x) = q_x^i\}$, $i \in \{1, \dots, S\}$ associated with fixed values of the quantizer form a partition of the domain \mathcal{D} and are called quantization regions. The signal $[x]$ is then obtained from signal x as follows

$$[x] = q_x(x) = q_x^i \quad \Leftrightarrow \quad x \in \mathcal{W}_x^i. \quad (4.33)$$

Note a change of the *quantized* signal $x(t)$, i.e. $[x(t)]$, represents then an *event*. An *injector* simply associates at each time t a unique element out of the finite discrete set $\mathcal{U} = \{u^1, u^2, \dots, u^M\}$ to a signal $u(t)$, i.e. $u(t) = u^i$ if $[u(t)] = i$.

¹Here the attribute “discrete” concerns both the signal values and the time

The continuous variable system, as depicted in Figure 4.1, can for example be a system of the form

$$\frac{d}{dt}x(t) = f(x(t), u(t)), \quad x_0 = x(t=0), \quad t \in \mathbb{R}_+ \quad (4.34)$$

where $x \in \mathbb{X} \subseteq \mathbb{R}^n$ is the state and $u(t) \in \mathbb{U} \subseteq \mathbb{R}^m$ the control. Furthermore, \mathbb{X} and \mathbb{U} denote potential state and control constraint sets. Based on (4.34) a controller synthesis can be performed which then results in the following closed-loop system depicted in Figure 4.2.

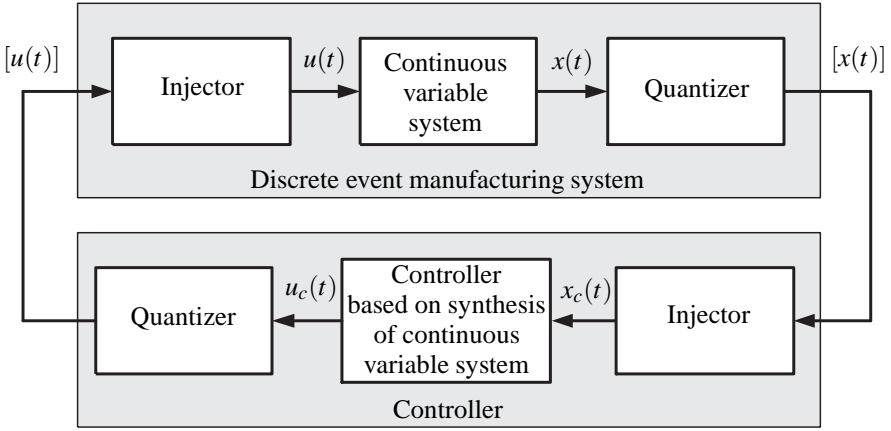

Figure 4.2: Discrete event manufacturing in closed-loop with the controller.

Suppose that, for ease of exposition, the controller in Figure 4.2 is some static feedback law, i.e.

$$u_c(t) = \kappa(x_c(t)). \quad (4.35)$$

Note that due to the presence of state and control quantization one has that

$$x_c(t) = q_x(x(t)) = x(t) + e_x(t), \quad (4.36a)$$

$$u(t) = q_u(u_c(t)) = u_c(t) + e_u(t), \quad (4.36b)$$

i.e.

$$e_x(t) \triangleq q_x(x(t)) - x(t), \quad e_u(t) \triangleq q_u(u_c(t)) - u_c(t).$$

Subsequential substitution of (4.36a) in (4.35) in (4.36b) in (4.34) yields the following closed-loop system description for the closed-loop system depicted in Figure 4.2

$$\frac{d}{dt}x(t) = f(x(t), \kappa(x(t) + e_x(t)) + e_u(t)), \quad (4.37)$$

where $e_x(t)$ and $e_u(t)$ can, from a system theoretical point of view, be seen as disturbance signals. Namely *measurement errors* and *actuator noise*, respectively. For a successful controller design for discrete event manufacturing systems, using the framework as depicted in Figure 1.4, one has to deal with “fictive” *disturbance signals* $e_x(t)$ and $e_u(t)$ entering the closed-loop dynamics given in (4.37) even though, a perfect continuous time model is available for controller synthesis. Note that in the previous sections it is indicated, in the discrete-time framework, how one can take into consideration disturbances as measurement errors and actuator noise in the controller design. It are these results that will be employed to design a model predictive controller that can cope with the “fictive” disturbance signals $e_x(t)$ and $e_u(t)$ or $e_{x,k}$ and $e_{u,k}$ in discrete-time, respectively. This is important since it is well known in literature that nonlinear model predictive controllers that are designed just to render the *nominal* closed-loop system, i.e. $e_x = 0$ and $e_u = 0$, (asymptotically) stable, do not necessarily possess robustness properties, see [91, 92]. Concretely this means that a nonlinear model predictive controller, designed for *nominal* asymptotic stability, might be unstable in the presence of arbitrary small disturbances $e_{x,k}$ and/or $e_{u,k}$ as is the case in manufacturing system control employing the framework as indicated in this section.

Since, model predictive control is usually formulated in discrete-time, see also Section 3.1, the manufacturing control problem is considered in the discrete-time modeling framework. That is, the model predictive controller design under investigation is how to obtain robustness (input-to-state-stability) of the following closed-loop system

$$x_{k+1} \in f(x_k, \kappa^{\text{MPC}}(x_k + e_{x,k}) + e_{u,k}), \quad e_{x,k} \in \mathbb{E}_x, \quad e_{u,k} \in \mathbb{E}_u, \quad k \in \mathbb{Z}_+, \quad (4.38)$$

with respect to *state measurement errors* $e_{x,k}$ and *actuator noise* $e_{u,k}$ in some sets $\mathbb{E}_x \subseteq \mathbb{R}^n$ and $\mathbb{E}_u \subseteq \mathbb{R}^m$, respectively.

A simple manufacturing example

In Figure 4.3, a schematic representation of a fluid model of a manufacturing line is presented. The line consists of a series connection of two workstations. Each workstation consists of a machine and a buffer. In Figure 4.3, the machines and buffers are denoted by M_1, M_2 and B_1, B_2 , respectively. The functions $b_1(t), b_2(t)$ and $b_3(t)$ represent the amount of fluid over time that is present in buffers B_1, B_2 and B_3 , respectively.

$\Phi^{\text{in}}(t)$ denotes the input of the manufacturing system representing a certain fluid flow. In the manufacturing context the fluid levels $b_1(t), b_2(t)$, and $b_3(t)$ can be thought of as a certain amount of products in buffers and $\Phi^{\text{in}}(t)$ can be thought of as the rate at which products enter the manufacturing system. The mean rate at which machines process products is denoted by μ . In [85] the following differential equation

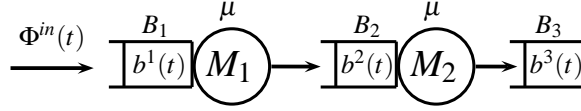

Figure 4.3: Fluid model of a manufacturing system.

is proposed to describe the dynamical behavior of the manufacturing line as is shown in Figure 4.3.

$$\begin{aligned}
 \frac{d}{dt}b^1(t) &= \Phi^{in}(t) - \frac{\mu b^1(t)}{1+b^1(t)} \\
 \frac{d}{dt}b^2(t) &= \frac{\mu b^1(t)}{1+b^1(t)} - \frac{\mu b^2(t)}{1+b^2(t)}, \quad \text{with} \quad \begin{aligned} b^1(t=0) &= b_0^1 \\ b^2(t=0) &= b_0^2 \\ b^3(t=0) &= b_0^3 \end{aligned} \\
 \frac{d}{dt}b^3(t) &= \frac{\mu b^2(t)}{1+b^2(t)}
 \end{aligned} \tag{4.39}$$

with

$$b^1(t) \in [0, b_{up}^1], \quad b^2(t) \in [0, b_{up}^2], \quad b^3(t) \in [0, \infty), \quad \Phi^{in}(t) \in [0, \Phi_{up}^{in}], \quad \forall t \in \mathbb{R}_+, \tag{4.40}$$

here $b^1(t)$, $b^2(t)$ and $b^3(t)$ represent the state and $\Phi^{in}(t)$ the control of the system. Buffers B_1 and B_2 can only contain a finite amount of products. The total amount of products each buffer B_1 and B_2 can store, is denoted by b_{up}^1 and b_{up}^2 , respectively. Furthermore, limitations of the product in flow rate $\Phi^{in}(t)$ is taken into consideration by constraints (4.40). The rate at which products can enter the manufacturing system is limited by Φ_{up}^{in} . It is assumed that Φ_{up}^{in} is larger than the total capacity denoted by the production rate of the manufacturing. The total capacity of the manufacturing system is for this example presented by μ . For more details on the derivation of (4.39) we refer the reader to [85].

Control problem

Problem 4.3.1 Let $b_{ref}^3(t)$ be a certain reference trajectory representing a desired fluid level of buffer B_3 over time. Assume $b_{ref}^3(t)$ satisfies the following differential equation

$$\frac{d}{dt}b_{ref}^3(t) = C, \quad \text{with} \quad b_{ref}^3(t=0) = b_{ref,0}^3 \geq 0, \tag{4.41}$$

where C is some constant such that $0 \leq C < \mu^2$. Then, the control problem can be formulated as to let $b^3(t)$, which satisfies (4.39), track (as fast as possible) the desired trajectory $b_{ref}^3(t)$ satisfying (4.41), i.e. $b^3(t) - b_{ref}^3(t) \rightarrow 0$ for $t \rightarrow \infty$. Furthermore, the fluid levels (amount of products) in buffers B_1 and B_2 should be kept as low as possible for all times $t \in \mathbb{R}_+$.

Controller design

To solve Problem 4.3.1 the control strategy described in Section 3.2 is applied. Before one can apply this control strategy to tackle Problem 4.3.1, we translate the control problem, as formulated in Problem 4.3.1, to a similar problem that can be solved by the proposed control strategy.

The MPC control strategy in Section 3.2 is defined in the discrete-time setting, therefore a time discretization of (4.39) is obtained using Euler's discretization scheme and ZOH assumption for $\Phi^{in}(t)$ with sampling time T . After discretization of (4.39) one obtains

$$\begin{aligned} b_{k+1}^1 &= b_k^1 + T\Phi_k^{in} - \frac{T\mu b_k^1}{1+b_k^1} \\ b_{k+1}^2 &= b_k^2 + \frac{T\mu b_k^1}{1+b_k^1} - \frac{T\mu b_k^2}{1+b_k^2}, \quad \text{with} \quad \begin{aligned} b_{k=0}^1 &= b_0^1 \\ b_{k=0}^2 &= b_0^2, \\ b_{k=0}^3 &= b_0^3 \end{aligned} \\ b_{k+1}^3 &= b_k^3 + \frac{T\mu b_k^2}{1+b_k^2} \end{aligned} \quad (4.42)$$

and the constraints read for all $k \in \mathbb{Z}_+$ as

$$b_k^1 \in [0, b_{up}^1], \quad b_k^2 \in [0, b_{up}^2], \quad b_k^3 \in [0, \infty), \quad \Phi_k^{in} \in [0, \Phi_{up}^{in}].$$

The same approach is employed to the reference model in (4.41), i.e.

$$b_{ref,k+1}^3 = b_{ref,k}^3 + TC, \quad \text{with} \quad b_{ref,k=0}^3 = b_{ref,0}^3 \geq 0. \quad (4.43)$$

The following change of coordinates is performed

$$\begin{bmatrix} b_{e,k}^1 \\ b_{e,k}^2 \\ b_{e,k}^3 \end{bmatrix} \triangleq \begin{bmatrix} b_k^1 \\ b_k^2 \\ b_k^3 - b_{ref,k}^3 \end{bmatrix}.$$

²The constant C in the interval $0 \leq C < \mu$ physically means that the desired "slope" of the reference trajectory should be strictly less than the maximal capacity of the manufacturing system (characterized by μ for this example).

The system dynamics in the new coordinates then reads

$$\begin{aligned}
 b_{e,k+1}^1 &= b_{e,k}^1 + T\Phi_k^{in} - \frac{T\mu b_{e,k}^1}{1+b_{e,k}^1} \\
 b_{e,k+1}^2 &= b_{e,k}^2 + \frac{T\mu b_{e,k}^1}{1+b_{e,k}^1} - \frac{T\mu b_{e,k}^2}{1+b_{e,k}^2}, \quad \text{with} \quad \begin{aligned} b_{e,k=0}^1 &= b_0^1 \\ b_{e,k=0}^2 &= b_0^2, \\ b_{e,k=0}^3 &= b_0^3 - b_{ref,0}^3 \end{aligned} \\
 b_{e,k+1}^3 &= b_{e,k}^3 + \frac{T\mu b_{e,k}^2}{1+b_{e,k}^2} - TC
 \end{aligned} \tag{4.44}$$

and constraints read for all $k \in \mathbb{Z}_+$ as

$$b_{e,k}^1 \in [0, b_{up}^1], \quad b_{e,k}^2 \in [0, b_{up}^2], \quad b_{e,k}^3 \in [-b_{ref,k}^3, \infty), \quad \Phi_k^{in} \in [0, \Phi_{up}^{in}].$$

The equilibria or steady state solutions of (4.44) are given by

$$b_{ess}^1 = \frac{\Phi_{ss}^{in}}{\mu - \Phi_{ss}^{in}}, \quad b_{ess}^2 = \frac{\Phi_{ss}^{in}}{\mu - \Phi_{ss}^{in}}, \quad b_{ess}^3 \in [0, \infty), \quad \text{and} \quad \Phi_{ss}^{in} = C.$$

The goal $b_k^3 - b_{ref,k}^3 \rightarrow 0$ for $k \rightarrow \infty$ formulated in Problem 4.3.1 is met if (4.44) is asymptotically stabilized around the equilibrium $(b_{ess}^1, b_{ess}^2, 0)$. However, the proposed control strategy that one wants to employ deals with the stabilization problem of discrete-time nonlinear systems around the origin as equilibrium point (for 0-control). In order to obtain a system representation which has this property the following coordinate change is performed on (4.44)

$$x_k^1 = b_{e,k}^1 - b_{ess}^1, \quad x_k^2 = b_{e,k}^2 - b_{ess}^2, \quad x_k^3 = b_{e,k}^3, \quad u_k = \Phi_k^{in} - \Phi_{ss}^{in}.$$

The proposed coordinate change results in a system of the following form

$$x_{k+1} = f(x_k, u_k), \tag{4.45}$$

where

$$f(x_k, u_k) = \begin{bmatrix} x_k^1 + T(u_k + C) - \frac{T\mu(x_k^1 + \alpha)}{1+x_k^1 + \alpha} \\ x_k^2 + \frac{T\mu(x_k^1 + \alpha)}{1+x_k^1 + \alpha} - \frac{T\mu(x_k^2 + \alpha)}{1+x_k^2 + \alpha} \\ x_k^3 + \frac{T\mu(x_k^2 + \alpha)}{1+x_k^2 + \alpha} - TC \end{bmatrix}, \quad \text{with} \quad \alpha = \frac{C}{\mu - C}$$

and the to be respected constraints are then given by

$$\begin{aligned}
 x_k^1 &\in [-b_{ess}^1, b_{up}^1 - b_{ess}^1], \quad x_k^2 \in [-b_{ess}^2, b_{up}^2 - b_{ess}^2], \quad x_k^3 \in [-b_{ref,k}^3, \infty), \\
 u_k &\in [-\Phi_{ss}^{in}, \Phi_{up}^{in} - \Phi_{ss}^{in}].
 \end{aligned}$$

The obtained model in (4.45) now has the required property $f(0,0) = 0$. Two other requirements for the MPC control strategy proposed in Section 3.2 are:

1. Compactness of the state and input constraint sets,
2. moreover the origin $x = 0$ should be contained in the interior of in the state and the control constraint set.

Due to the first item, one has to add the assumption that x_k^3 is constraint by some upper bound $x_{up}^3 > 0$. The practical implication of this assumption is that the difference between the real amount of products produced and the desired amount of products to be produced is *finite* for all discrete time steps $k \in \mathbb{Z}_+$. Due to the second item, one needs $b_{up}^1 \geq b_{ess}^1$, $b_{up}^2 \geq b_{ess}^2$. The state and input constraints (4.3) then become for all $k \in \mathbb{Z}_+$

$$\begin{aligned} \mathbb{X} &\triangleq \left\{ \xi \in \mathbb{R}^3 \mid \xi_1 \in [-b_{ess}^1, b_{up}^1 - b_{ess}^1], \xi_2 \in [-b_{ess}^2, b_{up}^2 - b_{ess}^2], \xi_3 \in [-b_{ref,k}^3, x_{up}^3] \right\}, \\ \mathbb{U} &\triangleq \left\{ \mu \in \mathbb{R} \mid \mu \in [-\Phi_{ss}^{in}, \Phi_{up}^{in} - \Phi_{ss}^{in}] \right\}, \end{aligned} \quad (4.46)$$

with b_{up}^1, b_{up}^2 and x_{up}^3 such that $b_{up}^1 \geq b_{ess}^1$, $b_{up}^2 \geq b_{ess}^2$, $x_{up}^3 > 0$.

The control objective formulated in Problem 4.3.1 is now formulated as to stabilize (4.45) around the equilibrium (0,0,0) and simultaneously to respect constraints (4.46).

A numerical example is obtained for the following system parameters: $T = 0.5$ [time unit], $\mu = 6$ [products/time unit]. Furthermore, the desired production demand schedule corresponding to the reference trajectory defined in (4.43) is defined by a production rate of $C = 4$ [products/time unit] and $b_{ref,0}^3 = 175$ [products]. Based on a linearization of (4.45) around (0,0) matrices A and B are obtained (see (3.15)) such that by employing the result in Lemma 3.2.7 the following matrices Q_V , K and P_V

$$Q_V = \begin{bmatrix} 0.05 & 0 & 0 \\ 0 & 0.05 & 0 \\ 0 & 0 & 0.05 \end{bmatrix}, \quad K = \begin{bmatrix} -1.4872 & -0.5524 & -0.1936 \end{bmatrix},$$

$$P_V = \begin{bmatrix} -93.8703 & -402.2321 & -397.2042 \\ 80.5989 & 121.5665 & -319.6462 \\ -886.1620 & 14.8758 & -336.9837 \end{bmatrix},$$

can be found. Hence the obtained matrix P_V defines an ISS Lyapunov function, i.e. (3.13), for Algorithm 3.2.2 in closed-loop with (4.45). As to enforce the performance requirement, i.e. low fluid level in buffers and fast tracking behavior, as stated in Problem 4.3.1, the following functions characterizing the cost J for the MPC algorithm proposed in Section 3.2, i.e. Algorithm 3.2.2, are employed.

$$F = |Px_{k+N|k}|_\infty, \quad L = |Qx_{k+i|k}|_\infty + |Ru_{k+i|k}|_\infty, \quad (4.47)$$

where

$$P = \begin{bmatrix} 2 & 0 & 0 \\ 0 & 2 & 0 \\ 0 & 0 & 2 \end{bmatrix}, \quad Q = \begin{bmatrix} 1 & 0 & 0 \\ 0 & 1 & 0 \\ 0 & 0 & 1 \end{bmatrix}, \quad R = 0.001, \quad N = 11$$

For initial conditions $[b_0^1 \ b_0^2 \ b_0^3]^\top = [4 \ 28 \ 0]^\top$ a simulation result is shown in Figure 4.4 for the designed controller applied on the nominal model, i.e. (4.42). By verifying the

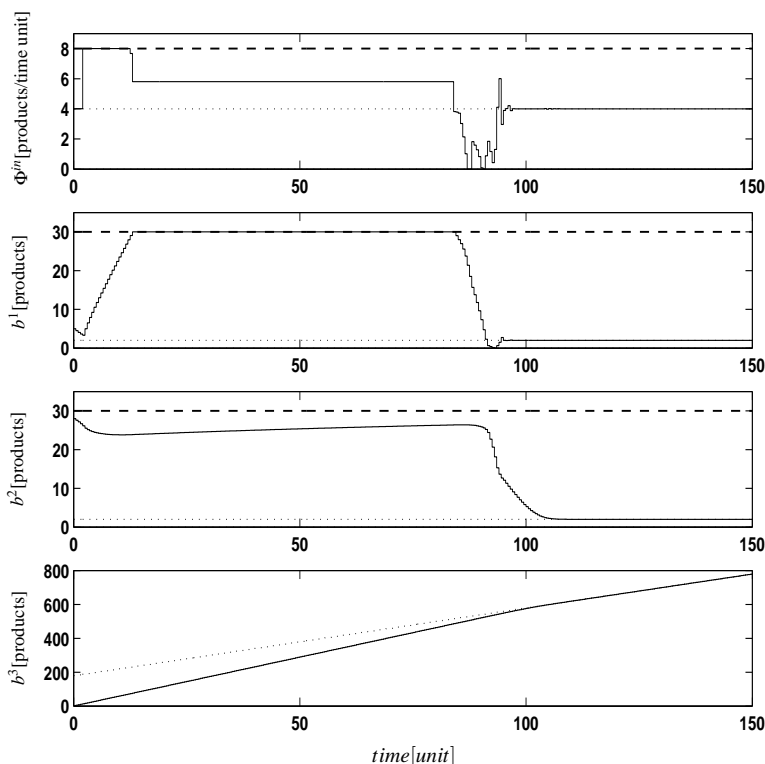

Figure 4.4: State and input trajectories are presented by the solid lines. The dashed and dotted lines represent the constraints and the desired steady state values.

sizes of the quantization regions³ one can quantify the sets \mathbb{E}_x and \mathbb{E}_u and employ Theorem 4.2.4 to conclude about the robustness property of the closed-loop system, i.e. (4.38) or (4.18b), which is needed to guarantee successful control of the discrete event manufacturing system following the framework as is indicated in Section 4.3.

Note that the considered manufacturing line in Figure 4.3 is just a simple example to illustrate the ideas in this chapter. A real life manufacturing line might consist

³Note that verifying the size of the quantization regions is still an open issue and remains a subject for future research.

of much more series connected workstations. More series connected work stations leads to expansion of the state dimension of the proposed model (4.39) which leads to a higher computational burden. However, since the control u appears linearly in the proposed model (4.39) the online computations can be performed more efficiently by relying for example on item (iii), (iv) or (v) in Corollary 3.2.9. Employing items (iii), (iv) or (v) in Corollary 3.2.9 leads to more efficient online computation and preservation of the ISS property of the model predictive control scheme in closed-loop with the system, however, performance of the model predictive control scheme might be reduced since the employed *prediction* model in case of items (iii) and (v) in Corollary 3.2.9 is based on a linear prediction models in stead of a nonlinear one.

As just illustrated the presented model predictive control approach can be employed to solve a tracking problem for a class of nonlinear manufacturing systems where the to-be-tracked reference trajectory is defined as in (4.43), which corresponds to a linear reference trajectory. Note that the in practice it might be desirable to track a larger class of reference trajectory. That is, the production demand schedule might in practice not be of the form as defined in (4.43) due more complex fluctuating customer demands. However, note that due to the fact that the system dynamics on which the controller design is based on, i.e. (4.45), only depends on the desired production capacity C and *not* on $b_{ref,k}^3$, one could design multiple controllers each corresponding to a certain desired production capacity C . Then, in case of fluctuating customer demands, which can be approximated arbitrarily well by a piecewise linear reference trajectory, one can switch between the controllers corresponding to the currently demanded desired production rate C . Hence, a nonlinear model predictive tracking controller for a class of nonlinear manufacturing systems that can enforce tracking with respect to piecewise linear reference trajectory is obtained.

4.4 Summary

The result in this chapter shows that state feedback laws that can render a closed-loop system input-to-state stable with respect to *additive disturbances* can also render the same closed-loop system input-to-state stable with respect to *state measurement errors* and *additive disturbances*. For the obtained result continuity of the system dynamics with respect to the *state* of the system is required, however, continuity with respect to the system's control variable is *not* required. Under the additional assumption of continuity of the system dynamics with respect to the control variable, also robustness with respect to actuator noise can be established. Hence, it has been shown that under mild conditions state feedback laws that can render a closed-loop system input-to-state stable with respect to *additive disturbances* can also render the same closed-loop system input-to-state stable with respect to *state measurement errors*, *additive*

disturbances and actuator noise.

Since the results hold for control and state constrained nonlinear discrete-time systems and it allows for possible discontinuity and set-valuedness of state feedback laws, makes the result in particularly interesting in the field of model predictive control. The result enables the employment of model predictive controllers, designed for rendering the closed-loop system input-to-state stable (ISS) with respect to additive disturbances, in a scenario where the closed-loop system has to be rendered input-to-state stable with respect to state measurement errors (and actuator noise). The fact that many results are available that render model predictive control closed-loop systems input-to-state stable with respect to additive disturbances and only few for measurement errors (and actuator noise), indicates the value of the result. Furthermore, in the context of synthesizing model predictive controllers based on fluid models of manufacturing systems it is indicated how the robustness results can be employed to cope with the compatibility issues between fluid models of manufacturing systems and the discrete-event nature of manufacturing systems.

A theory is something nobody believes, except the person who made it. An experiment is something everybody believes, except the person who made it.

Albert Einstein

5

Nonlinear model predictive control: output feedback

As is encountered in the previous chapter the proposed nonlinear model predictive control scheme, and many other schemes in literature, require knowledge of the full state of the to-be-controlled system for feedback. However, in practice it is rarely the case that the full state of the system is available. A possible solution to this problem is the usage of an observer. An observer can generate an estimate of the full state using knowledge of the output and input of the to-be-controlled system only. The obtained state estimate can then be employed as a substitute in a state feedback model predictive controller to generate the controls for the to-be-controlled system, see Figure 5.1. The certainty equivalence principle is a rigorous justification for such a substitution. If the to-be-controlled system is linear (and detectable and stabilizable) and no constraints have to be respected, one can separately design an observer with asymptotically stable estimation error dynamics and a linear state feedback controller that stabilizes the system such that the resulting certainty equivalent closed-loop system is guaranteed to be asymptotically stable. Due to the fact such a *separation principle* does not hold for nonlinear constrained systems, nominal stability results for nonlinear model predictive controller and observer estimation error dynamics usually do not guarantee closed-loop stability of an interconnected model predictive controller and observer combination. Moreover, the nominal stability result for nonlinear model predictive controllers is known to be non-robust. That is, nominal stabilizing property of the model predictive controller can be lost in the presence of arbitrary small disturbances, like for example *observation errors* (caused by an observer) in the state, see [92, 91]. One of the potential approaches to guarantee closed-loop stability in the presence of *observation errors* in the state, is to ensure that the model predictive controller is (inherently) robust to *observation errors*. In [60] asymptotic stability of state feedback

model predictive control is examined in face of asymptotically decaying disturbances. As is stated by the authors of [60], their results are also useful for the solution of the output feedback problem, although a formal proof is missing. A stability result on observer based nonlinear model predictive control, is reported in [69], under the standing assumption that the model predictive control value function and the resulting model predictive control law are Lipschitz continuous. The stability problem of observer based nonlinear model predictive control is revisited in [88], where only continuity of the model predictive control value function is assumed. In [88] robust global asymptotic stability is shown under the assumption that there are no state constraints present in the model predictive control problem. Other related results on observer based nonlinear model predictive control can be found in [93]. However, in [93] a continuous-time perspective is taken, while here the focus is on discrete-time nonlinear systems.

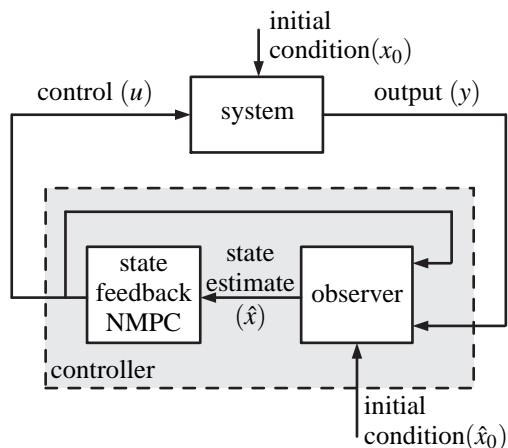

Figure 5.1: Basic structure of an observer-based output feedback Nonlinear Model Predictive Controller (NMPC).

In this chapter stability of an observer based nonlinear model predictive control scheme is investigated. The novelty of the proposed approach consists in the fact that a generically applicable observer design method is provided. As opposed to the nonlinear dead-beat observer presented in for example [88, 94] and Newton observers in [94], a feedback mechanism is incorporated in the state estimation procedure. The feedback mechanism is established since there is an output injected innovation term present in the observer structure as it is also the case in the classical Luenberger observer. Furthermore, the input-to-state stability framework, e.g. see [41, 63] and the

references therein, is employed to draw conclusions about the stability of the resulting closed-loop system. The extended observer design methodology from [95, 96] is considered. The extended observer design has the advantage that it works (locally) under a very mild condition on the system dynamics, which is strong local observability. However, the drawback is that future information of the controls applied to the system-to-be controlled are needed, which are normally not available and this therefore results in a causality problem. Since in the model predictive control framework *predicted* future controls are available, this framework might be suitable to be employed in combination with the proposed observer theory.

The chapter is organized as follows. First, the observer theory of [95, 96] is summarized in Section 5.1. In Section 5.2 it is shown how one can deal with the causality problem present in the proposed observer by employing the observer in a model predictive control environment. The definition of the stability analysis problem follows as a consequence of it. In Section 5.3 it is pointed out how to infer input-to-state stability (robustness) with respect to observation errors (introduced by an observer) from input-to-state stability with respect to additive disturbances. This result enables one to employ existing model predictive control scenarios, with an a priori input-to-state stability guarantee with respect to additive model uncertainty, like the one in Chapter 3, in an observer based model predictive control scenario. Next, in Section 5.4 one proves input-to-state stability of the error dynamics of the observer with respect to disturbances which are caused by imperfection of the *predicted* future controls injected to the observer, i.e. the predicted future control sequence does not coincide in general with the real control sequence applied to the system. In Section 5.5 the stability property of the closed-loop system, consisting of the model predictive controller interconnected with the observer and the system, is investigated. The input-to-state stability results obtained for the model predictive controller and the input-to-state stability result of the error dynamics of the observer, together with small gain arguments, are used to prove asymptotic stability of the proposed output based nonlinear model predictive closed-loop system, which is the main result of this chapter. In Section 5.6 the effectiveness of the scheme is illustrated on an example. Conclusions are summarized in Section 5.7.

5.1 Nonlinear observers

In this section the extended observer theory proposed in [95, 96] is summarized. For notational brevity we consider the theory for the single input single output case, although the theory applies in the multiple input/output case as well. Consider the fol-

lowing system

$$\begin{aligned} x_{k+1} &= f(x_k, u_k) \\ y_k &= g(x_k) \end{aligned}, \quad k \in \mathbb{Z}_+, \quad (5.1)$$

where $x_k \in \mathbb{R}^n$, $u_k \in \mathbb{R}$ and $y_k \in \mathbb{R}$ is the state, the control and the output at discrete-time $k \in \mathbb{Z}_+$, respectively. Furthermore, $f, g \in C^1$, $f: \mathbb{R}^n \times \mathbb{R}^m \rightarrow \mathbb{R}^n$ and $g: \mathbb{R}^n \rightarrow \mathbb{R}$ have the property that $f(0, 0) = 0$ and $g(0) = 0$. The observer problem for (5.1) deals with the question how to reconstruct the state trajectory $x(\cdot, x_0, u)$ on the basis of knowledge of the control and the output of the system. The observer design problem is a problem that is not yet fully solved for nonlinear systems of the form (5.1). A proposed observer candidate applicable for a broad class of discrete-time nonlinear systems is considered in this chapter. To be more precise, observer design for a class of systems that can be expressed in the so-called *Extended Nonlinear Observer Canonical Form* (ENOCF) is considered. Systems of the form (5.1) can be transformed, at least in a local sense, into the ENOCF provided system (5.1) is locally strongly observable [95, 97]. In Section 5.1 more details on this issue is given. Observers that are based on the ENOCF are called *extended* observers for shortness. One of the major characteristics that distinguishes *extended* observers from “conventional” observers, is that not only the output y_k and control u_k at the current time k are employed to obtain an estimate of the state x_k , but, also future controls and past outputs and controls are needed.

Observers in the ENOCF

A system representation in ENOCF, or the z -dynamics for brevity, reads as

$$\begin{aligned} z_{k+1} &= A_z z_k + f_z(\mathbf{y}_k^{[1-n,0]}, \mathbf{u}_k^{[1-n,0]}, \mathbf{u}_k^{[1,n]}) \\ y_k &= h_z(C_z z_k, \mathbf{u}_k^{[1-n,0]}) \end{aligned}, \quad k \in \mathbb{Z}_+, \quad (5.2)$$

with $C_z \triangleq \begin{bmatrix} 0 & \dots & 0 & 1 \end{bmatrix}$,

$$A_z \triangleq \begin{bmatrix} 0 & \dots & 0 & 0 \\ 1 & \dots & 0 & 0 \\ \vdots & \ddots & \vdots & \vdots \\ 0 & \dots & 1 & 0 \end{bmatrix}, \quad f_z(\mathbf{y}_k^{[1-n,0]}, \mathbf{u}_k^{[1-n,0]}, \mathbf{u}_k^{[1,n]}) \triangleq \begin{bmatrix} f_{z,0}(y_k, u_k, \mathbf{u}_k^{[1,n]}) \\ f_{z,1}(\mathbf{y}_k^{[-1,0]}, \mathbf{u}_k^{[-1,0]}, \mathbf{u}_k^{[1,n-1]}) \\ \vdots \\ f_{z,n-1}(\mathbf{y}_k^{[1-n,0]}, \mathbf{u}_k^{[1-n,0]}, u_{k+1}) \end{bmatrix},$$

where

$$\mathbf{y}_k^{[1-n,0]} \triangleq [y_{k-n+1} \dots y_k]^\top, \quad \mathbf{u}_k^{[1-n,0]} \triangleq [u_{k-n+1} \dots u_k]^\top, \quad \mathbf{u}_k^{[1,n]} \triangleq [u_{k+1} \dots u_{k+n}]^\top,$$

and $z_k \in \mathbb{R}^n$ represent the past output sequence, control sequence, future control sequence and state in z -coordinates at discrete time $k \in \mathbb{Z}_+$, respectively. Furthermore,

the pair (C_z, A_z) is an *observable pair* and $f_z : \mathbb{R}^n \times \mathbb{R}^n \times \mathbb{R}^n \rightarrow \mathbb{R}^n$, $h_z : \mathbb{R} \times \mathbb{R}^n \rightarrow \mathbb{R}$ are nonlinear functions, where h_z is, for a fixed control sequence, an *invertible* output function for the system in ENOCF. Except for the future control sequence, all other sequences are known at time k if control and output variables (measurements) are buffered. The dependence on the future control sequence corresponds (or can be compared to) the appearance of (also unknown) time derivatives of the control in the generalized continuous-time observer from [98]. Why a system representation in ENOCF is dependent on the future control sequence in the considered discrete-time context will become clear in Subsection 5.1, where details on the existence of a system representation in ENOCF are discussed. First the focus will be on the existence of observers for systems in ENOCF.

Observer candidates based on the system descriptions in ENOCF have been proposed in [95]. One of the observer candidates simply consists of a “copy” of the z -dynamics (5.2) added with an output injected term, also known as an *innovation* term, i.e.

$$\hat{z}_{k+1} = A_z \hat{z}_k + f_z(\mathbf{y}_k^{[1-n,0]}, \mathbf{u}_k^{[1-n,0]}, \mathbf{u}_k^{[1,n]}) + \kappa_o \underbrace{(h_{z, \mathbf{u}^{\text{fixed}}}^{-1}(\mathbf{y}_k, \mathbf{u}_k^{[1-n,0]}) - \hat{z}_{n,k})}_{z_{n,k}}, \quad k \in \mathbb{Z}_+ \quad (5.3)$$

with $\hat{z}_{n,k} = C_z \hat{z}_k$, and $h_{z, \mathbf{u}^{\text{fixed}}}^{-1}$ represents for a fixed input sequence $\mathbf{u}_k^{[1-n,0]}$ the inverse function of h_z in (5.2). One of the benefits of an observer in ENOCF, like the one in (5.3), is having an innovation term in the observer structure. The innovation term induces a feedback mechanism in the state estimation process. This feedback mechanism is beneficial to guarantee stability of the estimation process and to account for issues as model uncertainties, encountered in practice, by tuning the so called observer gain $\kappa_o \in \mathbb{R}^n$ appropriately. The observer gain can be used to assign a certain dynamic behavior of the observer z -error dynamics. The z -error dynamics is the dynamics which describes the evolution of the z -error defined at each time $k \in \mathbb{Z}_+$ as

$$e_{z,k} \triangleq z_k - \hat{z}_k.$$

Due to the fact that the state z_k of a system representation in ENOCF appears linearly in the system equations and all nonlinearity enters the state equations via the nonlinear function f_z , depending only on the control and output sequences of the system, a linear autonomous z -error dynamics is obtained. The z -error dynamics for (5.2) and (5.3) reads as

$$e_{z,k+1} = A_e e_{z,k}, \quad k \in \mathbb{Z}_+, \quad (5.4)$$

where

$$A_e \triangleq (A_z - \kappa_o C_z).$$

Note that the pair (C_z, A_z) is by definition an *observable pair*. From linear control theory it follows that this is sufficient for the existence of an observer gain κ_o to render A_e Schur. Hence it is thus always possible to design an observer for a system in ENOCF.

Existence of the ENOCF

Previously, it has been shown that if the dynamics of a system is given in the ENOCF (5.2), then it is always possible to design an observer for this system. However, the following question remains open: Which systems in the general form (5.1) can be transformed into the ENOCF (5.2)?

In order to answer this question, the notion of *strong local observability*, in e.g. [97], is recalled. For convenience first the *observability map* for non-autonomous discrete-time nonlinear systems is introduced, which has already been defined for discrete-time nonlinear autonomous systems in [99, 100].

Definition 5.1.1 The observability map ψ of the system given by (5.1) is defined as:

$$\psi(x_k, \mathbf{u}_k^{[0, n-2]}) \triangleq \begin{bmatrix} g(x_k) \\ g(f^1(x_k, u_k)) \\ \vdots \\ g(f^{n-1}(x_k, [u_k, \dots, u_{k+n-2}]^\top)) \end{bmatrix}, \quad (5.5)$$

where $f^i(x_k, [u_k, \dots, u_{k+i-1}]^\top) = f(f(\dots f(f(x_k, u_k), u_{k+1}), \dots), u_{k+i-1})$, with $i \geq 1$.

Next, *strong local observability* is introduced.

Definition 5.1.2

i) System (5.1) is *strongly locally observable*¹ at x_0 , if there exists an open neighborhood $\mathcal{N} \subset \mathbb{X}$ around x_0 such that for all states $\check{x}_0 \in \mathcal{N}$ and all admissible control sequences $\mathbf{u}_0^{[0, n-2]}$ resulting in the same output sequence as obtained by x_0 , i.e.

$$\psi(x_0, \mathbf{u}_0^{[0, n-2]}) = \psi(\check{x}_0, \mathbf{u}_0^{[0, n-2]}), \quad (5.6)$$

implies that $x_0 = \check{x}_0$.

ii) System (5.1) is *strongly locally observable on a domain* \mathbb{X} , if i) holds for all $x_0 \in \mathbb{X}$.

¹The word *locally* refers to the fact that two states must be distinguishable in a *neighborhood* \mathcal{N} around x_0 . The word *strongly* refers to the distinguishability of the states after observing the output trajectory for a finite number of time steps (n time steps, where n is dimension of the state x of the system).

A sufficient condition for system (5.1) to be *strongly locally observable* at x_0 is the following rank condition,

$$\text{rank} \left\{ \left. \frac{\partial \psi(x, \mathbf{u}_0^{[0, n-2]})}{\partial x} \right|_{x=x_0} \right\} = n, \quad \forall \mathbf{u}_0^{[0, n-2]} \in \mathbb{U}^{n-1}, \quad (5.7)$$

where $\mathbb{U}^{n-1} \subseteq \mathbb{R}^{n-1}$ and ψ is defined as in (5.5). Condition (5.7) is sufficient² for the existence of an invertible map of the observability map for fixed control sequences. This follows from the inverse function theorem in [101]. The inverse function of ψ for a fixed control sequence is denoted as $\psi_{\mathbf{u}_{\text{fixed}}}^{-1}$. Note that the existence of an invertible map $\psi_{\mathbf{u}_{\text{fixed}}}^{-1}$ around x_0 for all admissible control sequences is equivalent to *strong local observability* of (5.1) at x_0 . Thus, if the system (5.1) is *strongly locally observable*, then ψ in (5.5) acts for fixed controls, as a (locally) invertible map relating state x_k satisfying (5.1) to a state s_k satisfying another representation of system (5.1) having the form

$$s_{k+1} = \begin{bmatrix} s_{2,k} \\ \vdots \\ s_{n,k} \\ f_s(s_k, \mathbf{u}_k^{[0, n-1]}) \end{bmatrix}, \quad y_k = s_{1,k}, \quad (5.8)$$

where

$$\begin{aligned} s_k &\triangleq \psi(x_k, \mathbf{u}_k^{[0, n-2]}) \Leftrightarrow x_k = \psi_{\mathbf{u}_{\text{fixed}}}^{-1}(s_k, \mathbf{u}_k^{[0, n-2]}), \\ f_s(s_k, \mathbf{u}_k^{[0, n-1]}) &\triangleq g(f^n(\psi_{\mathbf{u}_{\text{fixed}}}^{-1}(s_k, \mathbf{u}_k^{[0, n-2]}), \mathbf{u}_k^{[0, n-1]})). \end{aligned}$$

Note that system (5.8) is obtained by defining

$$s_k \triangleq [y_k \quad \cdots \quad y_{k+n-1}]^\top.$$

By defining s_k in this manner *future* control sequence dependence, as has been encountered in the previous subsection, is introduced.

Next it will be shown that if the functions h_z and f_z satisfy the following relation

$$h_{z, \mathbf{u}_{\text{fixed}}}^{-1}(f_s(s_k, \mathbf{u}_k^{[0, n-1]}), \mathbf{u}_k^{[1, n]}) = \sum_{j=0}^{n-1} f_{z,j}(s_{1,k}, s_{2,k}, \dots, s_{j+1,k}, \mathbf{u}_k^{[0, n]}), \quad (5.9)$$

then there exists for fixed control and output sequences an invertible map $\Omega : \mathbb{R}^n \times \mathbb{R}^{n-1} \times \mathbb{R}^n \times \mathbb{R}^{n-1} \rightarrow \mathbb{R}^n$, i.e.

$$z_k = \Omega(s_k, \mathbf{y}_k^{[1-n, -1]}, \mathbf{u}_k^{[1-n, 0]}, \mathbf{u}_k^{[1, n-1]}), \quad (5.10)$$

²Note that the rank condition (5.7) is not necessary for invertibility. Take for example $\psi(x) = x^3$. The rank condition is obviously not satisfied at $x_0 = 0$. However, a global (non-smooth) inverse function clearly exists.

relating s_k satisfying (5.8) and z_k satisfying (5.2). Indeed, if one has (5.2) and (5.8) then by definition of s_k one must have that

$$\begin{aligned}
 s_{1,k} &= h_z(z_{n,k}, \mathbf{u}_k^{[1-n,0]}) \\
 s_{2,k} &= h_z(z_{n-1,k} + f_{z,n-1}(\mathbf{y}_k^{[1-n,-1]}, s_{1,k}, \mathbf{u}_k^{[1-n,1]}), \mathbf{u}_k^{[2-n,1]}) \\
 &\quad \vdots \\
 s_{n,k} &= h_z(z_{1,k} + \sum_{j=1}^{n-1} f_{z,j}(y_{k-1}, s_{1,k}, \dots, s_{j,k}, \mathbf{u}_k^{[-1,n-1]}), \mathbf{u}_k^{[0,n-1]})
 \end{aligned} \tag{5.11}$$

and

$$s_{n,k+1} = h_z\left(\sum_{j=0}^{n-1} f_{z,j}(y_k, s_{1,k+1}, \dots, s_{j,k+1}, \mathbf{u}_k^{[0,n]}), \mathbf{u}_k^{[1,n]}\right). \tag{5.12}$$

Employing (5.8) one must have that

$$f_s(s_k, \mathbf{u}_k^{[0,n-1]}) = h_z\left(\sum_{j=0}^{n-1} f_{z,j}(y_k, s_{1,k+1}, \dots, s_{j,k+1}, \mathbf{u}_k^{[0,n]}), \mathbf{u}_k^{[1,n]}\right). \tag{5.13}$$

Since h_z is, for fixed control sequences, an invertible function, relation (5.9) follows from expression (5.13). Hence, (5.9) is a necessary condition for the existence of an ENOCF in (5.2). Furthermore, if (5.13) (or (5.9)) is satisfied one can obtain Ω in (5.10) by solving (5.11) for z_k , i.e.

$$\begin{aligned}
 z_{1,k} &= h_{z, \mathbf{u} \text{ fixed}}^{-1}(s_{n,k}, \mathbf{u}_k^{[0,n-1]}) - \sum_{j=1}^{n-1} f_{z,j}(y_{k-1}, s_{1,k}, \dots, s_{j,k}, \mathbf{u}_k^{[-1,n-1]}) \\
 &\quad \vdots \\
 z_{n-2,k} &= h_{z, \mathbf{u} \text{ fixed}}^{-1}(s_{3,k}, \mathbf{u}_k^{[3-n,2]}) - f_{z,n-1}(\mathbf{y}_k^{[2-n,-1]}, s_{1,k}, s_{2,k}, \mathbf{u}_k^{[2-n,2]}) \\
 &\quad - f_{z,n-2}(\mathbf{y}_k^{[2-n,-1]}, s_{1,k}, \mathbf{u}_k^{[2-n,2]}) \\
 z_{n-1,k} &= h_{z, \mathbf{u} \text{ fixed}}^{-1}(s_{2,k}, \mathbf{u}_k^{[2-n,1]}) - f_{z,n-1}(\mathbf{y}_k^{[1-n,-1]}, s_{1,k}, \mathbf{u}_k^{[1-n,1]}) \\
 z_{n,k} &= h_{z, \mathbf{u} \text{ fixed}}^{-1}(s_{1,k}, \mathbf{u}_k^{[1-n,0]}).
 \end{aligned} \tag{5.14}$$

As a consequence, (5.9) is also a sufficient condition for the existence of an ENOCF, the reader is referred to [95] for the details. Since, there always exist functions h_z and f_z such that condition (5.9) is satisfied³ the composition Ξ of Ω and ψ ($\Xi \triangleq \Omega \circ \psi$)

$$z_k = \Xi(x_k, \mathbf{y}_k^{[1-n,-1]}, \mathbf{u}_k^{[1-n,0]}, \mathbf{u}_k^{[1,n-1]}), \tag{5.15}$$

³The left-hand side of (5.9) depends on the same arguments as its right-hand side, thus it is always possible to fulfil (5.9) by an appropriate choice of h_z and $f_{z,n-1}$.

acts, for fixed control and output sequences ($\Xi_{\text{uy fixed}}$), as a (local) invertible map defined around x_0 relating the state x_k from (5.1) and z_k from (5.2) if (5.1) is *strongly locally observable* at x_0 . One can summarize the previous discussion in the following result.

Theorem 5.1.3 *The system (5.1) is strongly locally observable at x_0 , if and only if there exist functions $f_z : \mathbb{R}^n \times \mathbb{R}^n \times \mathbb{R}^n \rightarrow \mathbb{R}^n$, $h_z : \mathbb{R} \times \mathbb{R}^n \rightarrow \mathbb{R}$ such that Ξ in (5.15) acts for fixed control and output sequences as an invertible map defined in an open neighborhood \mathcal{N} around x_0 relating state x_k satisfying (5.1) and a state z_k satisfying a system representation in ENOCF in particular (5.2).*

The interested reader can find a detailed proof in [95].

Remark 5.1.4 Notions of strong local observability on a domain \mathbb{X} , i.e. Definition 5.1.1 ii), extend the result in Theorem 5.1.3 from a result valid on a neighborhood \mathcal{N} around x_0 to a result valid for all x_0 in a domain \mathbb{X} .

Note that within relation (5.9) there are various possibilities to choose the functions f_z and h_z . This means that given system (5.1), there may exist multiple representations of this system in ENOCF. Without loss of generality and for ease of exposition, one may assume that h_z is a linear function in its arguments, i.e. let $h_s \in \mathbb{R}$, $h_u \in \mathbb{R}^{1 \times n}$ then h_z is defined as

$$h_z(z_{n,k}, \mathbf{u}_k^{[1-n,0]}) \triangleq h_s z_{n,k} + h_u \mathbf{u}_k^{[n-1,0]}. \quad (5.16)$$

Previously, it is shown that (5.3) is an observer for a system representation in ENOCF. Then, via the result established in this subsection one can conclude that under the condition that the system (5.1) is *locally strongly observable* the observer given by (5.3) is a (local) observer for (5.1). Via the coordinate transformation map (5.15) the estimated state in z -coordinates can be mapped to estimates of the state in x -coordinates. By continuity of the transformation map (5.15), it can be shown that asymptotic stability of the z -error dynamics (5.4) implies asymptotic stability of the estimation error dynamics in x -coordinates, which can be obtained by defining

$$e_{x,k} \triangleq x_k - \hat{x}_k, \quad k \in \mathbb{Z}_+,$$

as the estimation error in x -coordinates. Although the observer seems to be a global observer in the z -coordinates, the observer is, in general, only locally defined in x -coordinates. This follows from the fact that the equivalence relation between the z -dynamics and the x -dynamics denoted by (5.15) is not globally defined in general but only locally. Therefore, the observer candidate is in general only locally well-defined. However, if the transformation between the system representation (5.2) and (5.1) is defined globally also the observer candidate will be a global observer for (5.1).

5.2 Problem formulation

Consider the system dynamics given by (5.1). Throughout the chapter it is assumed that the state and the controls are constrained for system (5.1) to some *compact* sets \mathbb{X} and \mathbb{U} , respectively, i.e.

$$u_k \in \mathbb{U} \subseteq \mathbb{R}, \quad x_k \in \mathbb{X} \subseteq \mathbb{R}^n, \quad \forall k \in \mathbb{Z}_+. \quad (5.17)$$

The full state x_k is assumed not to be available for feedback, but only the output y_k is available for feedback. Instead, \hat{x}_k will be employed for feedback to a state feedback based model predictive controller. To obtain an estimate of the state x_k the observer theory described previously will be employed. However, the observer theory explained in Section 5.1 suffers from a causality problem. That is, at time step $k \in \mathbb{Z}_+$, when the model predictive controller needs an estimated state \hat{x}_k to compute a control u_k , the observer, i.e. (5.3), (5.15), needs *future* controls $\mathbf{u}_k^{[1,n]}$, that are not available at time k , in order to generate a state estimate \hat{x}_k . Furthermore, at time steps $k \in \mathbb{Z}_{[0,n-1]}$ also past controls and outputs in the sequences $\mathbf{u}_k^{[1-n,0]}$ and $\mathbf{y}_k^{[1-n,0]}$, respectively, are not fully known. The causality problem of the observer is dealt with by using the fact that in the model predictive control strategy *predicted* future information about the controls is available at each time step $k \in \mathbb{Z}_+$. That is, if the prediction horizon of the model predictive controller is sufficiently long ($N \in \mathbb{Z}_{>n}$), a part of the *predicted* future control sequence obtained by the model predictive controller at every time step $k \in \mathbb{Z}_+$, denoted by $\bar{\mathbf{u}}_k^{[1,n]}$, is employed as a guess for the unknown sequence $\mathbf{u}_k^{[1,n]}$. The problem of not fully knowing the past control and output sequences at time steps $k \in \mathbb{Z}_{[0,n-1]}$ is dealt with by replacing $\mathbf{u}_k^{[1-n,0]}$ and $\mathbf{y}_k^{[1-n,0]}$ in (5.3), (5.15) by vectors

$$\eta_k^y \in \mathbb{Y}^n \subseteq \mathbb{R}^n \quad \text{and} \quad \eta_k^u \in \mathbb{U}^n \subseteq \mathbb{R}^n,$$

respectively, where

$$\mathbb{Y} \triangleq \left\{ \zeta \in \mathbb{R} \mid \zeta = g(\xi), \xi \in \mathbb{X} \right\}.$$

The vectors η_k^y and η_k^u represent state vectors from buffer systems that buffer the output and the control, i.e. y_k and u_k , respectively. The buffer systems are defined as

$$\eta_{k+1}^y = A_b \eta_k^y + b_b y_k, \quad (5.18a)$$

$$\eta_{k+1}^u = A_b \eta_k^u + b_b u_k, \quad (5.18b)$$

where $A_b \triangleq A_z^\top$, $b_b \triangleq [0 \dots 0 \ 1]^\top$ and the output of the system, i.e. y_k , and the control u_k are inputs of the buffer systems. A precise setup of the resulting observer based model predictive control scheme is then described by

- **The system:**

$$\begin{aligned} x_{k+1} &= f(x_k, u_k), \\ y_k &= g(x_k), \end{aligned} \quad u_k \in \mathbb{U}, \quad x_k \in \mathbb{X}, \quad k \in \mathbb{Z}_+; \quad (5.19)$$

• **Observer:**

$$\hat{q}_{k+1} = \hat{f}(\hat{q}_k, y_k, u_k, \bar{\mathbf{u}}_k^{[1,n]}), \quad k \in \mathbb{Z}_+, \quad (5.20)$$

where $\hat{q}_k \triangleq \begin{bmatrix} \hat{z}_k & \eta_k^y & \eta_k^u \end{bmatrix}^\top$,

$$\hat{f}(\hat{q}_k, y_k, u_k, \bar{\mathbf{u}}_k^{[1,n]}) \triangleq \begin{bmatrix} A_z \hat{z}_k + f_z(\eta_k^y, \eta_k^u, \bar{\mathbf{u}}_k^{[1,n]}) + \kappa_o(h_s^{-1}(y_k - h_u \eta_k^u) - \hat{z}_{n,k}) \\ A_b \eta_k^y + b_b y_k \\ A_b \eta_k^u + b_b u_k \end{bmatrix}; \quad (5.21)$$

• **MPC controller:**

Algorithm 5.2.1

Step 1) Given \hat{q}_k at time $k \in \mathbb{Z}_+$ and $N \in \mathbb{Z}_{>n}$, let $x_{k|k} \triangleq \hat{x}_k$ and find (via optimization) a control sequence $\mathbf{u}_k^{[0,N-1]} \triangleq [u_{k|k}, \dots, u_{k+N-1|k}]^\top$ that satisfies

$$\hat{z}_k = \Xi(\hat{x}_k, \eta_k^y, \eta_k^u, [u_{k+1|k}, \dots, u_{k+n|k}]^\top), \quad (5.22a)$$

$$\mathbf{u}_k^{[0,N-1]} \in \mathcal{U}_N(\hat{x}_k), \quad (5.22b)$$

and optionally also minimize the model predictive control cost, e.g. $J(\hat{x}_k, \mathbf{u}_k^{[0,N-1]})$ in (3.2).

Step 2) Let

$$\tilde{\mathbf{K}}_u^{\text{MPC}}(\hat{q}_k) \triangleq \left\{ \left[u_{k+1|k} \quad \dots \quad u_{k+n|k} \right]^\top \in \mathbb{U}^n \mid \mathbf{u}_k^{[0,N-1]} \text{ satisfies (5.22)} \right\}$$

and

$$\tilde{\mathbf{K}}^{\text{MPC}}(\hat{q}_k) \triangleq \left\{ u_{k|k} \in \mathbb{U} \mid \mathbf{u}_k^{[0,N-1]} \text{ satisfies (5.22)} \right\}.$$

Furthermore, let $\bar{\mathbf{u}}_k^{[0,N-1]} \triangleq [\bar{u}_{k+1|k}, \dots, \bar{u}_{k+N-1|k}]^\top$ with

$$\bar{\mathbf{u}}_k^{[1,n]} \triangleq [\bar{u}_{k+1|k}, \dots, \bar{u}_{k+n|k}]^\top \in \tilde{\mathbf{K}}_u^{\text{MPC}}(\hat{q}_k), \quad (5.23a)$$

$$u_k \triangleq \bar{u}_{k|k} \in \tilde{\mathbf{K}}^{\text{MPC}}(\hat{q}_k), \quad (5.23b)$$

denote a *feasible* control sequence and control with respect to the optimization problem formulated at Step 1, respectively. Apply a control sequence $\bar{\mathbf{u}}_k^{[1,n]}$ and a control u_k satisfying (5.23a) and (5.23b), respectively, to the observer (5.20) and the system (5.19) and increment k by one and go to Step 1.

Note that the model predictive control law resulting from Algorithm 5.2.1 is denoted by (5.23) where $\tilde{\kappa}_u^{\text{MPC}} : \mathbb{Q} \hookrightarrow \mathbb{U}^n$ and $\tilde{\kappa}^{\text{MPC}} : \mathbb{Q} \hookrightarrow \mathbb{U}$ are set-valued mappings and $\mathbb{Q} \triangleq \mathbb{S}_z \times \mathbb{Y}^n \times \mathbb{U}^n$ with

$$\mathbb{S}_z \triangleq \left\{ \zeta \in \mathbb{R}^n \mid \zeta = \Xi(\xi, \zeta^n, \mu_p^n, \mu_f^n), \xi \in \mathbb{X}, \zeta^n \in \mathbb{Y}^n, \mu_p^n, \mu_f^n \in \mathbb{U}^n \right\}.$$

Remark 5.2.2 Under the assumption that \hat{x}_k is explicitly available for feedback to the model predictive controller (and thus conversion of \hat{q}_k via (5.22a) in Algorithm 5.2.1 would not be necessary), one could remove constraint (5.22a) from Algorithm 5.2.1. Then under the assumption that (5.19) is *strongly locally observable*, the solution of the newly obtained model predictive control algorithm (where \hat{x}_k is explicitly available) is similar to the solution to Algorithm 5.2.1. This is due to the fact that the value of \hat{x}_k is, for given \hat{z}_k and all fixed η_k^y, η_k^u and $\mathbf{u}_k^{[1,n]}$, uniquely defined via map Ξ .

The model predictive controller (5.23) (Algorithm 5.2.1) interconnected with the observer (5.20) and the system (5.19) forms the closed-loop dynamics

$$x_{k+1} \in f(x_k, \tilde{\kappa}^{\text{MPC}}(\hat{q}_k)), \quad (5.24a)$$

$$\hat{q}_{k+1} \in \hat{f}(\hat{q}_k, g(x_k), \tilde{\kappa}^{\text{MPC}}(\hat{q}_k), \tilde{\kappa}_u^{\text{MPC}}(\hat{q}_k)). \quad (5.24b)$$

In the remainder of the chapter a constructive design procedure for the model predictive controller and the observer is given such that the equilibrium point $[x_{eq} \hat{q}_{eq}]^\top = 0$ of the resulting closed-loop system (5.24) is rendered *asymptotically stable* with respect initial states $[x_0 \hat{q}_0]^\top$ in some subset of $\mathbb{X} \times \mathbb{Q}$. Hence, a stabilizing output based nonlinear model predictive control scheme is obtained. An outline of the followed approach is given next.

Outline of the approach

Taking into consideration Remark 5.2.2 system (5.24a) can be considered from the point of view that

$$x_{k+1} \in f(x_k, \underbrace{\kappa^{\text{MPC}}(x_k + e_{x,k})}_{\hat{x}_k}) \triangleq \mathcal{F}_{e_x}(x_k, e_{x,k}), \quad e_{x,k} \in \mathbb{E}_x, \quad (5.25)$$

where $\mathbb{E}_x \subseteq \mathbb{R}^n$ is a known compact set with $0 \in \text{int}(\mathbb{E}_x)$. The state *observation error* in system (5.25) is now considered as an “external” bounded disturbance signal, e.g. state measurement noise, exiting system (5.25). The model predictive controller design question can then be formulated as to synthesize a model predictive controller such that system (5.1) is robust to any observation error $e_x : \mathbb{R}_+ \rightarrow \mathbb{E}_x$. The notion of *input-to-state stability*, as introduced in Chapter 2, is used for this purpose. Once

$x_{eq} = 0$ is an input-to-state stable equilibrium point of system (5.25) with respect to the observation errors $e_x : \mathbb{R}_+ \rightarrow \mathbb{E}_x$ and initial states x_0 in some set, it is known that if the observation error vanishes, i.e. $e_{x,k} \rightarrow 0$ for $k \rightarrow \infty$, also $x_k \rightarrow 0$ for $k \rightarrow \infty$. This follows directly from the input-to-state stability property given in Definition 2.3.2. Hence, if $x_{eq} = 0$ is an input-to-stable equilibrium point of (5.25) then a sufficient condition which will lead to *asymptotic stability* of equilibrium point $x_{eq} = 0$ of (5.25), or similarly (5.24a), is that the observation error vanishes, i.e. $e_{x,k} \rightarrow 0$ for $k \rightarrow \infty$. Following this approach, one in fact decouples the observer design problem from the controller design problem and hence a *separation principle* holds true. An approach to synthesize a model predictive controller that renders equilibrium point $x_{eq} = 0$ of system (5.25) input-to-state stable with respect to e_x is given in the next section.

For the observer design one will consider the error dynamics, that $e_{x,k}$ satisfies for all $k \in \mathbb{Z}_+$ and is given by

$$e_{q,k+1} \in \mathcal{F}_{\mathbf{e}_u}(e_{q,k}, \mathbf{e}_{\mathbf{u},k}^{[1,n]}), \quad k \in \mathbb{Z}_+, \quad (5.26a)$$

$$e_{x,k} \in \mathcal{G}_{\mathbf{e}_u}(e_{q,k}, \mathbf{e}_{\mathbf{u},k}^{[1,n]}), \quad k \in \mathbb{Z}_+, \quad (5.26b)$$

where

$$\begin{aligned}
 \mathbf{e}_{\mathbf{u},k}^{[1,n]} &\triangleq \mathbf{u}_k^{[1,n]} - \bar{\mathbf{u}}_k^{[1,n]}, \\
 \mathcal{F}_{\mathbf{e}_u}(e_{q,k}, \mathbf{e}_{\mathbf{u},k}^{[1,n]}) &\triangleq \left\{ A_q e_{q,k} + B_q \Delta f_z(\zeta^n, e_{y,k}, \mu_p^n, e_{u,k}, \mu_f^n, \mathbf{e}_{\mathbf{u},k}^{[1,n]}) \mid \zeta^n \in \mathbb{Y}^n, \mu_p^n, \mu_f^n \in \mathbb{U}^n \right\}, \\
 \mathcal{G}_{\mathbf{e}_u}(e_{q,k}, \mathbf{e}_{\mathbf{u},k}^{[1,n]}) &\triangleq \left\{ \Delta \Xi(e_{z,k}, \zeta, \zeta^n, e_{y,k}, \mu_p^n, e_{u,k}, \mu_f^n, \mathbf{e}_{\mathbf{u},k}^{[1,n]}) \mid \zeta \in \mathbb{S}_z, \zeta^n \in \mathbb{Y}^n, \right. \\
 &\quad \left. \mu_p^n, \mu_f^n \in \mathbb{U}^n \right\},
 \end{aligned}$$

with,

$$A_q \triangleq \begin{bmatrix} A_e & 0 & -\kappa_o h_s^{-1} h_u \\ 0 & A_b & 0 \\ 0 & 0 & A_b \end{bmatrix}, \quad B_q \triangleq \begin{bmatrix} I_n \\ 0 \\ 0 \end{bmatrix}, \quad e_{q,k} \triangleq \begin{bmatrix} e_{z,k} \\ e_{y,k} \\ e_{u,k} \end{bmatrix} \triangleq \begin{bmatrix} z_k - \hat{z}_k \\ \mathbf{y}_k^{[1-n,0]} - \eta_k^y \\ \mathbf{u}_k^{[1-n,0]} - \eta_k^u \end{bmatrix},$$

$$\begin{aligned}
 \Delta f_z(\eta_k^y, e_{y,k}, \eta_k^u, e_{u,k}, \bar{\mathbf{u}}_k^{[1,n]}, \mathbf{e}_{\mathbf{u},k}^{[1,n]}) &\triangleq \\
 & f_z(\eta_k^y + e_{y,k}, \eta_k^u + e_{u,k}, \bar{\mathbf{u}}_k^{[1,n]} + \mathbf{e}_{\mathbf{u},k}^{[1,n]}) - f_z(\eta_k^y, \eta_k^u, \bar{\mathbf{u}}_k^{[1,n]}),
 \end{aligned}$$

$$\begin{aligned}
 \Delta \Xi(\hat{z}_k, e_{z,k}, \eta_k^y, e_{y,k}, \eta_k^u, e_{u,k}, \bar{\mathbf{u}}_k^{[1,n]}, \mathbf{e}_{\mathbf{u},k}^{[1,n]}) &\triangleq \\
 & \underbrace{\Xi_{\text{uy fixed}}^{-1}(\hat{z}_k + e_{z,k}, \eta_k^y + e_{y,k}, \eta_k^u + e_{u,k}, \bar{\mathbf{u}}_k^{[1,n]} + \mathbf{e}_{\mathbf{u},k}^{[1,n]})}_{x_k} - \underbrace{\Xi_{\text{uy fixed}}^{-1}(\hat{z}_k, \eta_k^y, \eta_k^u, \bar{\mathbf{u}}_k^{[1,n]})}_{\hat{x}_k}.
 \end{aligned}$$

The error dynamics defined by (5.26a) and defined by (5.26a) and (5.26b) is in the remainder of the chapter also referred to as the q -error and x -error dynamics, respectively. The error dynamics defined by (5.26a) and (5.26b) is a non-autonomous system

with the difference between the real future control sequence and *predicted* future control sequence, i.e. *future predicted control error sequence* $\mathbf{e}_{\mathbf{u},k}^{[1,n]}$, as input. Since the predicted future control sequence does in general not coincide with the real future control, the future predicted control error signal $\mathbf{e}_{\mathbf{u},k}^{[1,n]}$ is in general a non-zero input for system (5.26a), (5.26b). This makes, showing that $e_x \rightarrow 0$ for $k \rightarrow \infty$, a nontrivial task.

In Section 5.4 it will be proven that equilibrium point $e_{qeq} = 0$, with $\mathcal{G}_{\mathbf{e}_u}(e_{qeq}, 0) = \{0\}$, of the error dynamics given by (5.26a) and (5.26b) can be rendered input-to-state stable and input-to-output stable, respectively, with respect to future control prediction error $\mathbf{e}_{\mathbf{u},k}^{[1,n]}$. In Section 5.5 the closed-loop system as defined by (5.24) is considered from a cascade point of view of the input-to-state and input-to-output stable observer error dynamics (5.26a), (5.26b) and the input-to-state stable system (5.25), i.e.

$$\begin{bmatrix} x_{k+1} \\ e_{q,k+1} \end{bmatrix} \in \begin{bmatrix} f(x_k, \kappa^{\text{MPC}}(x_k + \mathcal{G}_{\mathbf{e}_u}(e_{q,k}, \mathbf{e}_{\mathbf{u},k}^{[1,n]}))) \\ \mathcal{F}_{\mathbf{e}_u}(e_{q,k}, \mathbf{e}_{\mathbf{u},k}^{[1,n]}) \end{bmatrix} \triangleq \begin{bmatrix} \mathcal{F}_{e_x}(x_k, \mathcal{G}_{\mathbf{e}_u}(e_{q,k}, \mathbf{e}_{\mathbf{u},k}^{[1,n]})) \\ \mathcal{F}_{\mathbf{e}_u}(e_{q,k}, \mathbf{e}_{\mathbf{u},k}^{[1,n]}) \end{bmatrix}, \quad k \in \mathbb{Z}_+. \quad (5.27)$$

By imposing *regularity*, i.e. see Definition 3.1.1, on the model predictive controller and employing a *small gain* argument, one can show that

$$\mathbf{e}_{\mathbf{u},k}^{[1,n]} \in \mathcal{F}_{e_q}(x_k, e_{q,k}), \quad k \in \mathbb{Z}_+, \quad (5.28)$$

where $\mathcal{F}_{e_q} : \widetilde{\mathcal{X}} \times \mathcal{E}_q \rightarrow \mathbb{U}^n \oplus \mathbb{U}^n$ is a set-valued mapping with $\mathcal{F}_{e_q}(0, 0) = \{0\}$, $\widetilde{\mathcal{X}} \subseteq \mathbb{X}$ and $\mathcal{E}_q \subseteq \mathbb{R}^{3n}$. Via interconnecting (5.27) and (5.28) it is then proven that equilibrium point $[x_{eq} \ e_{qeq}]^\top = 0$ of interconnection (5.27) and (5.28) is asymptotically stable with respect to initial states $[x_0 \ e_{q0}]^\top$ in some set. From this result asymptotic stability of the equilibrium point $[x_{eq} \ \hat{q}_{eq}]^\top = 0$ of the closed-loop system (5.24) with respect to initial states $[x_0 \ \hat{q}_0]^\top$ in some subset of $\mathbb{X} \times \mathbb{Q}$ follows.

5.3 Controller design

As explained in the previous section, one seeks for model predictive controller schemes that can render the equilibrium point $x_{eq} = 0$ of system (5.25) input-to-state stable with respect to *observation errors* e_x taking values in some set \mathbb{E}_x . To be more precise:

Assumption 5.3.1 Let \mathbb{E}_x be a given set with $0 \in \text{int}(\mathbb{E}_x)$. Suppose $\kappa^{\text{MPC}}(\cdot)$ is a model predictive controller with $N \in \mathbb{Z}_{>n}$ such that for the system (5.1) in closed-loop with the model predictive controller $\kappa^{\text{MPC}}(\cdot)$ the following holds: There exist a $\mathcal{H}\mathcal{L}$ -function β_x and a \mathcal{K} -function $\gamma_x^{\ell_x}$ such that for all initial states x_0 in an RPI set $\mathcal{X}^e(N)$ with $0 \in \text{int}(\mathcal{X}^e(N))$ of system (5.25) perturbed by observation errors $e_x : \mathbb{Z}_+ \rightarrow \mathbb{E}_x$ all solutions $x \in \mathcal{S}_{\mathcal{F}_{e_x}}(x_0, e_x)$ satisfy

$$|x_k| \leq \beta_x(|x_0|, k) + \gamma_x^{\ell_x}(\|e_x\|), \quad \forall k \in \mathbb{Z}_+. \quad (5.29)$$

Furthermore, let $\mathcal{X}^e(N)$ be such that

$$\mathcal{X}^e(N) \subseteq \mathbb{X} \sim \mathbb{E}_x. \quad (5.30)$$

In Chapter 3 one can find a method how to design a model predictive controller which can realize the property as formulated in Assumption 5.3.1. Recall, that in Chapter 3 it is pointed out, by the result of Corollary 4.1.4, how one can employ the relatively rich literature about nonlinear model predictive control synthesis methods, which can a priori guarantee that equilibrium point $\tilde{x}_{eq} = 0$ of system (3.7) is input-to-state stable with respect to *additive* disturbances, e.g. Algorithms 3.2.2, 3.3.3 and 3.2.11 spelled-out in Chapter 3, or [46], in the scenario where the equilibrium point $x_{eq} = 0$ of the closed-loop system (5.25) has to be rendered input-to-state stable with respect to *observation errors* or measurement noise as formulated in Assumption 5.3.1.

5.4 Observer design

In Section 5.2 the error dynamics (5.26a) and (5.26b) of the observer defined by (5.20) (and (5.22a)) has been derived. In this section, it is proved that the equilibrium point $e_{qeq} = 0$ of the error dynamics (5.26a) and (5.26b) can be rendered input-to-state and input-to-output stable with respect to $\mathbf{e}_{\mathbf{u},k}^{[1,n]}$ as input. Recall that $\mathbf{e}_{\mathbf{u},k}^{[1,n]}$ represents the error present in the *predicted* future control sequence $\bar{\mathbf{u}}_k^{[1,n]}$, which is obtained by the model predictive controller (5.23) and injected to the observer (5.20) at discrete time $k \in \mathbb{Z}_+$, i.e.

$$\mathbf{e}_{\mathbf{u},k}^{[1,n]} \triangleq \mathbf{u}_k^{[1,n]} - \bar{\mathbf{u}}_k^{[1,n]} \quad k \in \mathbb{Z}_+. \quad (5.31)$$

Due to (5.17) and the fact that Assumption 5.3.1 holds, one has that

$$\mathbf{u}_k^{[1,n]}, \bar{\mathbf{u}}_k^{[1,n]} \in \mathbb{U}^n, \quad \forall k \in \mathbb{Z}_+ \Rightarrow \mathbf{e}_{\mathbf{u},k}^{[1,n]} \in \mathbb{U}^n \oplus \mathbb{U}^n. \quad (5.32)$$

Then, let $\varepsilon_{\mathbf{e}_u} \in \mathbb{R}_{>0}$ be the smallest constant such that

$$\mathbb{U}^n \oplus \mathbb{U}^n \subseteq \mathbb{E}_{\varepsilon_{\mathbf{e}_u}}, \quad (5.33)$$

with

$$\mathbb{E}_{\varepsilon_{\mathbf{e}_u}} \triangleq \left\{ \varepsilon \in \mathbb{R}^n \mid |\varepsilon| \leq \varepsilon_{\mathbf{e}_u} \right\}. \quad (5.34)$$

Hence,

$$\mathbf{e}_{\mathbf{u},k}^{[1,n]} \in \mathbb{E}_{\varepsilon_{\mathbf{e}_u}}, \quad \forall k \in \mathbb{Z}_+.$$

Assumption 5.4.1 There exists constants L_{f_z} and L_{Ξ} such that for all $k \in \mathbb{Z}_+$

$$|\Delta f_z(\cdot, e_{y,k}, \cdot, e_{u,k}, \cdot, \mathbf{e}_{\mathbf{u},k}^{[1,n]})| \leq L_{f_z} \left(|e_{y,k}| + |e_{u,k}| + |\mathbf{e}_{\mathbf{u},k}^{[1,n]}| \right), \quad (5.35a)$$

$$|\Delta \Xi(\cdot, e_{z,k}, \cdot, e_{y,k}, \cdot, e_{u,k}, \cdot, \mathbf{e}_{\mathbf{u},k}^{[1,n]})| \leq L_{\Xi} \left(|e_{z,k}| + |e_{y,k}| + |e_{u,k}| + |\mathbf{e}_{\mathbf{u},k}^{[1,n]}| \right). \quad (5.35b)$$

The constants L_{f_z} and L_{Ξ} exist if the functions f_z and $\Xi_{\text{uy fixed}}^{-1}$ are Lipschitz continuous with respect to all their arguments in the domains $\mathbb{Y}^n \times \mathbb{U}^n \times \mathbb{U}^n$ and $\mathbb{S}_z \times \mathbb{Y}^n \times \mathbb{U}^n \times \mathbb{U}^n$, respectively.

Assumption 5.4.2 Let $\mathcal{X}^e(N) \subseteq \mathbb{X} \sim \mathbb{E}_x$ with

$$\mathbb{E}_x \triangleq \left\{ \varepsilon \in \mathbb{R}^n \mid |\varepsilon| \leq 3L_{\Xi} \left(\tilde{h}_q + 2\vartheta(L_{f_z}, \tilde{h}_e, \rho_e, n) \right) \varepsilon_{e_q} + \left(3 \left(\vartheta(L_{f_z}, \tilde{h}_e, \rho_e, n) + L_{f_z} \frac{\tilde{h}_e}{1 - \rho_e} \right) + 1 \right) L_{\Xi} \varepsilon_{\mathbf{e}_u} \right\}, \quad (5.36)$$

for some $\varepsilon_{e_q} \in \mathbb{R}_{>0}$ and with $\tilde{h}_e \in \mathbb{R}_{\geq 1}$, $\tilde{h}_q \in \mathbb{R}_{\geq 1}$, $\rho_e \in \mathbb{R}_{(0,1)}$ such that $|A_e^k| \leq \tilde{h}_e \rho_e^k$ and $|A_q^k| \leq \tilde{h}_q \rho_q^k$ holds for some $\rho_q \in \mathbb{R}_{(0,1)}$ and all $k \in \mathbb{Z}_+$ and where

$$\vartheta(L_{f_z}, \tilde{h}_e, \rho_e, n) \triangleq L_{f_z} \tilde{h}_e \left(\sum_{j=0}^{n-1} \rho_e^j \right). \quad (5.37)$$

Theorem 5.4.3 Let

$$\mathcal{E}_q \triangleq \left\{ \varepsilon \in \mathbb{R}^{3n} \mid |\varepsilon| \leq \varepsilon_{e_q} \right\}$$

and suppose there exists a constant $\varepsilon_{e_q} \in \mathbb{R}_{>0}$ such that Assumptions 5.4.1 and 5.4.2 hold and (5.1) is strongly locally observable on domain \mathbb{X} . Then the following statements hold.

i) The equilibrium point $e_{qeq} = 0$ of the q -error dynamics (5.26a) is **input-to-state stable** with respect to inputs $\mathbf{e}_u^{[1,n]} : \mathbb{Z}_+ \rightarrow \mathbb{E}_{\mathbf{e}_u}$ and initial error $e_{q,0}$ in \mathcal{E}_q , i.e. for all $e_{q,0} \in \mathcal{E}_q$ and $\mathbf{e}_u^{[1,n]} : \mathbb{Z}_+ \rightarrow \mathbb{E}_{\mathbf{e}_u}$ all solutions $e_q \in \mathcal{S}_{\mathcal{F}_{\mathbf{e}_u}}(e_{q,0}, \mathbf{e}_u^{[1,n]})$ satisfy

$$|e_{q,k}| \leq \beta_{e_q}(|e_{q,0}|, k) + \gamma_{e_q}^{\mathbf{e}_u} \|\mathbf{e}_u^{[1,n]}\|, \quad \forall k \in \mathbb{Z}_+, \quad (5.38)$$

where

$$\beta_{e_q}(|e_{q,0}|, k) \triangleq \left(\tilde{h}_q \rho_q^k + 2\vartheta(L_{f_z}, \tilde{h}_e, \rho_e, n) \rho_e^{\max(0, k+1-n)} \right) |e_{q,0}|, \\ \gamma_{e_q}^{\mathbf{e}_u} \triangleq \left(\vartheta(L_{f_z}, \tilde{h}_e, \rho_e, n) + L_{f_z} \frac{\tilde{h}_e}{1 - \rho_e} \right).$$

ii) The equilibrium point $e_{qeq} = 0$ of the x -error dynamics defined by (5.26a) and (5.26b) is **input-to-output stable** with respect to inputs $\mathbf{e}_u^{[1,n]} : \mathbb{Z}_+ \rightarrow \mathbb{E}_{\mathbf{e}_u}$ and initial error $e_{q,0}$ in \mathcal{E}_q , i.e. for all $e_{q,0} \in \mathcal{E}_q$ and $\mathbf{e}_u^{[1,n]} : \mathbb{Z}_+ \rightarrow \mathbb{E}_{\mathbf{e}_u}$ all solutions $e_x \in \mathcal{S}_{\mathcal{F}_{\mathbf{e}_u} \mathcal{G}_{\mathbf{e}_u}}(e_{q,0}, \mathbf{e}_u^{[1,n]})$ satisfy

$$|e_{x,k}| \leq \beta_{e_x}(|e_{q,0}|, k) + \gamma_{e_x}^{\mathbf{e}_u} \|\mathbf{e}_u^{[1,n]}\|, \quad \forall k \in \mathbb{Z}_+, \quad (5.39)$$

where $\beta_{e_x}(|e_{q,0}|, k) \triangleq 3L_{\Xi}\beta_{e_q}(|e_{q,0}|, k)$,

$$\gamma_{e_x}^{\mathbf{e}_u} \triangleq L_{\Xi}(3\gamma_{e_q}^{\mathbf{e}_u} + 1). \quad (5.40)$$

iii) For all $e_{q,0} \in \mathcal{E}_q$ and $\mathbf{e}_u^{[1,n]} : \mathbb{Z}_+ \rightarrow \mathbb{E}_{\mathbf{e}_u}$

$$e_{x,k} \in \mathbb{E}_x, \quad \forall k \in \mathbb{Z}_+. \quad (5.41)$$

Proof:

i) Due to the structure of A_b appearing in A_q in the function $\mathcal{F}_{\mathbf{e}_u}$ defining the q -error dynamics (5.26a), one can rewrite (5.26a) as follows

$$e_{q,k+1} = A_q e_{q,k} + B_q v_k, \quad k \in \mathbb{Z}_+, \quad (5.42)$$

where v_k is defined as

$$v_k \in \left\{ \Delta f_z(\zeta^n, e_{y,k}, \mu_p^n, e_{u,k}, \mu_f^n, \mathbf{e}_{u,k}^{[1,n]}) \mid \zeta^n \in \mathbb{Y}^n, \mu_p^n, \mu_f^n \in \mathbb{U}^n \right\}, \quad \forall k \in \mathbb{Z}_+. \quad (5.43)$$

Note that for all $k \in \mathbb{Z}_+$

$$|e_{y,k}| \leq |A_b^k| |e_{y,0}|, \quad \text{and} \quad |e_{u,k}| \leq |A_b^k| |e_{u,0}|, \quad (5.44)$$

with

$$|A_b^k| \triangleq \begin{cases} 1 & \text{for } k \in \mathbb{Z}_{[0,n-1]}, \\ 0 & \text{for } k \in \mathbb{Z}_{\geq n}. \end{cases} \quad (5.45)$$

Due to Lipschitz continuity of the function f_z , property (5.35a) holds. Then, taking into consideration (5.44) and (5.45) yields

$$|v_k| \leq \begin{cases} L_{f_z} (|e_{y,0}| + |e_{u,0}| + |\mathbf{e}_{u,k}^{[1,n]}|), & \text{for } k \in \mathbb{Z}_{[0,n-1]}, \\ L_{f_z} |\mathbf{e}_{u,k}^{[1,n]}|, & \text{for } k \in \mathbb{Z}_{\geq n}. \end{cases} \quad (5.46)$$

Using (5.42) and employing the diagonal structure of A_q yields

$$|e_{q,k+1}| \leq \begin{cases} |A_q^{k+1}| |e_{q,0}| + |B_q| \sum_{j=0}^k |A_e^{k-j}| |v_j|, & \text{for } k \in \mathbb{Z}_{[0,n-1]}, \\ |A_q^{k+1}| |e_{q,0}| + |B_q| \left(|A_e^{k+1-n}| \sum_{j=0}^{n-1} |A_e^{n-1-j}| |v_j| + \sum_{j=0}^{k-n} |A_e^{k-n-j}| |v_{j+n}| \right), & \text{for } k \in \mathbb{Z}_{\geq n}. \end{cases}$$

Employing (5.46), above inequality can for all $k \in \mathbb{Z}_+$ be written as

$$|e_{q,k+1}| \leq |A_q^{k+1}| |e_{q,0}| + \left(|A_e^{\max(0,k+1-n)}| L_{f_z} \sum_{j=0}^{n-1} |A_e^{n-1-j}| (|e_{y,0}| + |e_{u,0}| + |\mathbf{e}_{\mathbf{u},j}^{[1,n]}|) + L_{f_z} \sum_{j=0}^k |A_e^{k-j}| |\mathbf{e}_{\mathbf{u},j}^{[1,n]}| \right). \quad (5.47)$$

Since A_e and A_q are Schur, there exist constants $\tilde{h}_e \in \mathbb{R}_{\geq 1}$, $\tilde{h}_q \in \mathbb{R}_{\geq 1}$, $\rho_e \in \mathbb{R}_{(0,1)}$ and $\rho_q \in \mathbb{R}_{(0,1)}$ such that $|A_e^i| \leq \tilde{h}_e \rho_e^i$ and $|A_q^i| \leq \tilde{h}_q \rho_q^i$ hold for all $i \in \mathbb{Z}_+$, see e.g. [41], and thus (5.47) can be written as

$$|e_{q,k+1}| \leq \left(\tilde{h}_q \rho_q^k + 2L_{f_z} \tilde{h}_e \left(\sum_{j=0}^{n-1} \rho_e^j \right) \rho_e^{\max(0,k+1-n)} \right) |e_{q,0}| + \left(L_{f_z} \tilde{h}_e \left(\sum_{j=0}^{n-1} \rho_e^j \right) \rho_e^{\max(0,k+1-n)} + L_{f_z} \sum_{j=0}^{\infty} \tilde{h}_e \rho_e^j \right) \|\mathbf{e}_{\mathbf{u}}^{[1,n]}\|, \quad (5.48)$$

which yields that equilibrium point $e_{qe} = 0$ of system (5.26a) is input-to-state stable in the sense of Definition 2.3.2 with respect to inputs $\mathbf{e}_{\mathbf{u}}^{[1,n]}: \mathbb{Z}_+ \rightarrow \mathbb{E}_{\mathbf{u}}$ and initial error $e_{q,0} \in \mathcal{E}_q$, with $\mathcal{H}\mathcal{L}$ -function and \mathcal{K} -function as stated in Theorem 5.4.3.

iii) Continuing the proof by employing property (5.38), the fact that $\mathbf{e}_{\mathbf{u},k}^{[1,n]} \in \mathbb{E}_{\mathbf{u}}$ for all $k \in \mathbb{Z}_+$ and $e_{q,0} \in \mathcal{E}_q$ one has that

$$|e_{q,k}| \leq \beta_{e_q}(\varepsilon_{e_q}, 0) + \gamma_{e_q}^{\mathbf{e}_{\mathbf{u}}} \varepsilon_{\mathbf{u}} = \left(\tilde{h}_q + 2\vartheta(L_{f_z}, \tilde{h}_e, \rho_e, n) \right) \varepsilon_{e_q} + \left(\vartheta(L_{f_z}, \tilde{h}_e, \rho_e, n) + L_{f_z} \frac{\tilde{h}_e}{1 - \rho_e} \right) \varepsilon_{\mathbf{u}}. \quad (5.49)$$

Note that $x_k \in \mathcal{X}^e(N)$ for all $k \in \mathbb{Z}_+$ due to Assumption 5.3.1. Suppose that $e_{x,k} \in \mathbb{E}_x$ for all $k \in \mathbb{Z}_+$, then due to the fact that

$$\hat{x}_k \triangleq x_k - e_{x,k}, \quad k \in \mathbb{Z}_+,$$

one has that

$$\hat{x}_k \in \mathcal{X}^e(N) \oplus \mathbb{E}_x, \quad \forall k \in \mathbb{Z}_+. \quad (5.50)$$

From the hypothesis of Theorem 5.4.3, i.e. Assumption 5.4.2, there follows that

$$\mathcal{X}^e(N) \subseteq \mathbb{X} \sim \mathbb{E}_x \Rightarrow \mathcal{X}^e(N) \oplus \mathbb{E}_x \subseteq (\mathbb{X} \sim \mathbb{E}_x) \oplus \mathbb{E}_x \subseteq \mathbb{X},$$

which yields, via (5.50), that

$$\hat{x}_k \in \mathbb{X}, \quad \forall k \in \mathbb{Z}_+. \quad (5.51)$$

Hence, since (5.1) is strongly locally observable on domain \mathbb{X} , Ξ (and $\Delta\Xi$) will be well-defined for all \hat{x}_k, x_k in \mathbb{X} . Therefore (via Assumption 5.4.1) there exists a Lipschitz constant for $\Xi_{\text{yy fixed}}^{-1}$ with respect to all its arguments in the domain $\mathbb{S}_z \times \mathbb{Y}^n \times \mathbb{U}^n \times \mathbb{U}^n$ such that (5.35b) is satisfied, which yields that for all $k \in \mathbb{Z}_+$

$$|e_{x,k}| \leq 3L_\Xi |e_{q,k}| + L_\Xi \|\mathbf{e}_{\mathbf{u}}^{[1,n]}\| \leq 3L_\Xi |e_{q,k}| + L_\Xi \boldsymbol{\varepsilon}_{\mathbf{e}_{\mathbf{u}}}. \quad (5.52)$$

Substituting (5.49) in (5.52) yields that indeed

$$e_{x,k} \in \mathbb{E}_x \quad \forall k \in \mathbb{Z}_+. \quad (5.53)$$

This concludes the proof of statement iii) in Theorem 5.4.3.

ii) Substitution of (5.38) in (5.52) results in (5.39) with the $\mathcal{H}\mathcal{L}$ -function and the \mathcal{K} -function as stated in Theorem 5.4.3. ■

5.5 Interconnection results

So far, one has *separately* designed a model predictive controller which renders equilibrium point $x_{eq} = 0$ of (5.25) input-to-state stable with respect to *observation errors* $e_x : \mathbb{Z}_+ \rightarrow \mathbb{E}_x$ (that are present in \hat{x}), and an observer for which the equilibrium point $e_{qeq} = 0$ of its error dynamics, i.e. (5.26a) and (5.26b) is input-to-state and input-to-output stable with respect to the *prediction errors* $\mathbf{e}_{\mathbf{u}}^{[1,n]} : \mathbb{Z}_+ \rightarrow \mathbb{E}_{\mathbf{e}_{\mathbf{u}}}$ (that are present in $\bar{\mathbf{u}}^{[1,n]}$). In this section the focus is on the asymptotic stability issue of the closed-loop system given by (5.24). Based on analysis of the cascade given by (5.27), which consists of the input-to-state and input-to-output stable observer error dynamics given by (5.26a) and (5.26b), cascaded with the input-to-state stable system (5.25), an asymptotic stability result of closed-loop system (5.24) will be obtained.

The standing assumption for the main result in this section is

Assumption 5.5.1 The nonlinear model predictive controller admits, for $N_r = n$, the *regularity* property, in the sense of Definition 3.1.1 with respect to \hat{x}_k , i.e. $\exists \theta_1, \theta_2 \in \mathbb{R}_{>0}$ such that $|u_{k|k}| \leq \theta_1 |\hat{x}_k|$ and $|u_{k+i|k}| \leq \theta_2 |\hat{x}_k|$ for $i = 1, 2, \dots, n$.

Regularity can be imposed by simply including $|u_{k|k}| \leq \theta_1 |\hat{x}_k|$ and $|u_{k+i|k}| \leq \theta_2 |\hat{x}_k|$ for $i = 1, 2, \dots, n$ as additional constraints to the employed model predictive control scheme, e.g. Algorithm 3.2.2, for a priori fixed θ_1 and θ_2 . For ease of exposition, it is also assumed that the ISS-gain of the model predictive controller, i.e. $\gamma_x^{\ell_x}$ (see Assumption (5.3.1)), is linear in its argument.

Theorem 5.5.2 *Let*

$$\mathcal{E}_q \triangleq \left\{ \varepsilon \in \mathbb{R}^{3n} \mid |\varepsilon| \leq \varepsilon_{eq} \right\},$$

for some $\varepsilon_{eq} > 0$. Suppose Assumption 5.5.1 holds and Assumption 5.3.1 holds with \mathbb{E}_x as defined in (5.36). Furthermore, let (5.1) be strongly locally observable on the domain \mathbb{X} . Then, if

$$(\theta_1 + \theta_2)\gamma_{e_x}^{\mathbf{e}_u}(\gamma_x^{\ell_x} + 1) < 1, \quad (5.54)$$

and constraint (5.22a) is added to a model predictive control algorithm, forming e.g. Algorithm 5.2.1, the equilibrium point $[x_{eq} \hat{q}_{eq}]^\top = 0$ of the resulting closed-loop system (5.24) is **asymptotically stable** with respect to initial states $x_0 \in \mathcal{X}^e(N)$ and $\hat{q}_0 \in \mathbb{Q}$ such that $(q_0 - \hat{q}_0) \in \mathcal{E}_q$.

Before proving the statement of Theorem 5.5.2 a technical lemma will be formulated, which will be employed later in the proof of Theorem 5.5.2.

Lemma 5.5.3 *Suppose $N \in \mathbb{R}_{>n}$ and Assumption 5.5.1 holds. Then, the signal $\mathbf{e}_{\mathbf{u},k}^{[1,n]}$ satisfies*

$$\|\mathbf{e}_{\mathbf{u},k}^{[1,n]}\| \leq \gamma_{\mathbf{e}_u}^x \|x\| + \gamma_{\mathbf{e}_u}^{\ell_x} \|e_x\|, \quad \forall k \in \mathbb{Z}_+, \quad (5.55)$$

where the gains $\gamma_{\mathbf{e}_u}^x$ and $\gamma_{\mathbf{e}_u}^{\ell_x}$ are defined as $\gamma_{\mathbf{e}_u}^x = \gamma_{\mathbf{e}_u}^{\ell_x} \triangleq (\theta_1 + \theta_2)$.

Proof: Using *regularity* (Definition 3.1.1) and the triangle inequality, the induced norm of the difference between the predicted future controls and the real controls can be upper bounded for all $k \in \mathbb{Z}_+$ and $i = 1, \dots, n$, i.e.

$$|u_{k+i} - u_{k+i|k}| \leq |u_{k+i}| + |u_{k+i|k}| \leq \theta_1 |\hat{x}_{k+i}| + \theta_2 |\hat{x}_k|. \quad (5.56)$$

Since (5.56) holds for all $k \in \mathbb{Z}_+$ and $i = 1, \dots, n$ one has that

$$\|\mathbf{e}_{\mathbf{u}}^{[1,n]}\| \leq (\theta_1 + \theta_2) \|\hat{x}\| \leq (\theta_1 + \theta_2)(\|x\| + \|e_x\|) \quad (5.57)$$

which concludes the proof of the statement. ■

Regularity thus leads to property (5.55). Employing this property, the statement in Theorem 5.5.2 can be proved.

Proof: The proof is divided into four major parts. The first part consists of proving that the input-to-state and input-to-output stability properties of (sub)systems (5.25) and (5.26), are preserved when they are cascaded resulting into system (5.27). Secondly, it is proven that under condition (5.54) one has that for all $k \in \mathbb{Z}_+$ (5.28) holds with

$$\mathcal{F}_{e_q}(x_k, e_{q,k}) \triangleq \left\{ \delta \mathcal{X}(|x_k|, |e_{q,k}|) \mid \delta \in \mathbb{D} \right\}, \quad (5.58)$$

where $\mathbb{D} \triangleq \{d \in \mathbb{R}^n \mid |d| \leq 1\}$ and

$$\chi(|x_k|, |e_{q,k}|) \triangleq \gamma_{\mathbf{e}_u}^{\ell_x} \left(1 - \gamma_{\mathbf{e}_u}^{\ell_x} \gamma_{e_x}^{\mathbf{e}_u} (\gamma_x^{\ell_x} + 1) \right)^{-1} \left(\beta_x(|x_k|, 0) + (1 + \gamma_x^{\ell_x}) \beta_{e_x}(|e_{q,k}|, 0) \right).$$

Then, via interconnecting (5.27) and (5.28) it is proven that equilibrium point $[x_{eq} \ e_{qeq}]^\top = 0$ of interconnection (5.27), (5.58) is *stable* with respect to initial states $[x_0 \ e_{q,0}]^\top$ in $\mathcal{X}^e(N) \times \mathcal{E}_q$, i.e. it is shown that (2.15) in item i) of Definition 2.2.1 is satisfied. The next part of the proof consists of showing that equilibrium point $[x_{eq} \ e_{qeq}]^\top = 0$ of interconnection (5.27), (5.58) is *attractive*, i.e. item ii) in Definition 2.2.1 is satisfied for initial states $[x_0 \ e_{q,0}]^\top$ in $\mathcal{X}^e(N) \times \mathcal{E}_q$. Based on the asymptotic stability result of equilibrium point $[x_{eq} \ e_{qeq}]^\top = 0$ of interconnection (5.27), (5.58), asymptotic stability of the equilibrium point $[x_{eq} \ \hat{q}_{eq}]^\top = 0$ of closed-loop system consisting of (5.24a) and (5.24b) is concluded.

Part 1) Due to the hypothesis of Theorem 5.5.2, $\mathcal{X}^e(N)$ is RPI for system (5.25) perturbed by $e_x : \mathbb{Z}_+ \rightarrow \mathbb{E}_x$. This implies that Assumption 5.4.2 holds, hence the results of Theorem 5.4.3 hold. This then implies that for any initial error $e_{q,0}$ in the set \mathcal{E}_q the trajectory e_x , satisfying the dynamics of system (5.26) satisfies

$$e_k \in \mathbb{E}_x, \quad \forall k \in \mathbb{Z}_+,$$

which implies that the input-to-state property of system (5.25), as stated in the hypothesis of Theorem 5.5.2, is preserved for all $k \in \mathbb{Z}_+$ and initial conditions x_0 in $\mathcal{X}^e(N)$. Hence, properties (5.29) and (5.38), (5.39) of Assumption 5.3.1 and Theorem 5.4.3, respectively, hold for system (5.27) with $\mathbf{e}_u^{[1,n]} : \mathbb{Z}_+ \rightarrow \mathbb{E}_{\mathbf{e}_u}$ and initial states $[x_0 \ e_{q,0}]^\top \in \mathcal{X}^e(N) \times \mathcal{E}_q$.

Part 2) From (5.29), (5.38), (5.39) and (5.55), one can conclude that for any $k \geq \ell$

$$|x_k| \leq \beta_x(|x_\ell|, k - \ell) + \gamma_x^{\ell_x} (\|e_{x, [\ell]}\|), \quad (5.59a)$$

$$|e_{q,k}| \leq \beta_{e_q}(|e_{q,\ell}|, k - \ell) + \gamma_{e_q}^{\mathbf{e}_u} \|\mathbf{e}_{\mathbf{u}, [\ell]}^{[1,n]}\|, \quad (5.59b)$$

$$|e_{x,k}| \leq \beta_{e_x}(|e_{q,\ell}|, k - \ell) + \gamma_{e_x}^{\mathbf{e}_u} \|\mathbf{e}_{\mathbf{u}, [\ell]}^{[1,n]}\|, \quad (5.59c)$$

$$\|\mathbf{e}_{\mathbf{u}, k}^{[1,n]}\| \leq \gamma_{\mathbf{e}_u}^x \|x_{[\ell]}\| + \gamma_{\mathbf{e}_u}^{\ell_x} \|e_{x, [\ell]}\|. \quad (5.59d)$$

Employing relation (5.59a) and (5.59c) one has

$$|x_k| \leq \beta_x(|x_\ell|, k - \ell) + \gamma_x^{\ell_x} \left(\beta_{e_x}(|e_{q,\ell}|, k - \ell) + \gamma_{e_x}^{\mathbf{e}_u} \|\mathbf{e}_{\mathbf{u}, [\ell]}^{[1,n]}\| \right). \quad (5.60)$$

Then, using (5.59c), (5.59d) and (5.60) yields

$$\begin{aligned} \|\mathbf{e}_{\mathbf{u}, [\ell]}^{[1,n]}\| &\leq \gamma_{\mathbf{e}_u}^x \beta_x(|x_\ell|, k - \ell) + \gamma_{\mathbf{e}_u}^{\ell_x} \gamma_x^{\ell_x} \beta_{e_x}(|e_{q,\ell}|, k - \ell) \\ &\quad + \gamma_{\mathbf{e}_u}^x \gamma_x^{\ell_x} \gamma_{e_x}^{\mathbf{e}_u} \|\mathbf{e}_{\mathbf{u}, [\ell]}^{[1,n]}\| + \gamma_{\mathbf{e}_u}^{\ell_x} \beta_{e_x}(|e_{q,\ell}|, k - \ell) + \gamma_{\mathbf{e}_u}^{\ell_x} \gamma_{e_x}^{\mathbf{e}_u} \|\mathbf{e}_{\mathbf{u}, [\ell]}^{[1,n]}\|. \end{aligned} \quad (5.61)$$

Since $\gamma_{\mathbf{e}_u}^x = \gamma_{\mathbf{e}_u}^{\ell_x}$ and (5.54) holds, one has

$$\|\mathbf{e}_{\mathbf{u},[\ell]}^{[1,n]}\| \leq \gamma_{\mathbf{e}_u}^{\ell_x} \left(1 - \gamma_{\mathbf{e}_u}^{\ell_x} \gamma_{e_x}^{\mathbf{e}_u} (\gamma_x^{\ell_x} + 1)\right)^{-1} \left(\beta_x(|x_\ell|, k - \ell) + (1 + \gamma_x^{\ell_x}) \beta_{e_x}(|e_{q,\ell}|, k - \ell)\right). \quad (5.62)$$

Letting $\ell = k$, it holds that for all $k \in \mathbb{Z}_+$

$$\begin{aligned} |\mathbf{e}_{\mathbf{u},k}^{[1,n]}| &\leq \gamma_{\mathbf{e}_u}^{\ell_x} \left(1 - \gamma_{\mathbf{e}_u}^{\ell_x} \gamma_{e_x}^{\mathbf{e}_u} (\gamma_x^{\ell_x} + 1)\right)^{-1} \left(\beta_x(|x_k|, 0) + (1 + \gamma_x^{\ell_x}) \beta_{e_x}(|e_{q,k}|, 0)\right) \triangleq \\ &\triangleq \chi(|x_k|, |e_{q,k}|). \end{aligned} \quad (5.63)$$

Hence, the description of the signal $\mathbf{e}_{\mathbf{u},k}^{[1,n]}$, in its most general form that satisfies (5.63), is therefore given by (5.28), where \mathcal{F}_{e_q} is defined by (5.58).

Part 3) Letting $\ell = 0$ in (5.59b), (5.60) and (5.62) one can obtain

$$|e_{q,k}| \leq \beta_{e_q}(|e_{q,0}|, 0) + \gamma_{e_q}^{\mathbf{e}_u} \|\mathbf{e}_{\mathbf{u}}^{[1,n]}\|, \quad (5.64a)$$

$$|x_k| \leq \beta_x(|x_0|, 0) + \gamma_x^{\ell_x} \left(\beta_{e_x}(|e_{q,0}|, 0) + \gamma_{e_x}^{\mathbf{e}_u} \|\mathbf{e}_{\mathbf{u}}^{[1,n]}\|\right), \quad (5.64b)$$

$$\|\mathbf{e}_{\mathbf{u}}^{[1,n]}\| \leq \gamma_{\mathbf{e}_u}^{\ell_x} \left(1 - \gamma_{\mathbf{e}_u}^{\ell_x} \gamma_{e_x}^{\mathbf{e}_u} (\gamma_x^{\ell_x} + 1)\right)^{-1} \left(\beta_x(|x_0|, 0) + (1 + \gamma_x^{\ell_x}) \beta_{e_x}(|e_{q,0}|, 0)\right). \quad (5.64c)$$

Note that (5.64c) implies

$$\|\mathbf{e}_{\mathbf{u}}^{[1,n]}\| \leq \chi(|x_0|, |e_{q,0}|). \quad (5.65)$$

Furthermore, for all $k \in \mathbb{Z}_+$ one has that

$$|[x_k \ e_{q,k}]^\top| \leq |[x_k \ e_{q,k}]^\top|^2 \triangleq |x_k|^2 + |e_{q,k}|^2. \quad (5.66)$$

Employing (5.64a), (5.64b), (5.65) and (5.66) yields that for all $[x_0 \ e_{q,0}]^\top \in \mathcal{X}^e(N) \times \mathcal{E}_q$ all solutions of interconnection (5.27) and (5.28), satisfy

$$\begin{aligned} |[x_k \ e_{q,k}]^\top| &\leq \left(\beta_x(|x_0|, 0) + \gamma_x^{\ell_x} \left(\beta_{e_x}(|e_{q,0}|, 0) + \gamma_{e_x}^{\mathbf{e}_u} \chi(|x_0|, |e_{q,0}|)\right)\right)^2 + \\ &+ \left(\beta_{e_q}(|e_{q,0}|, 0) + \gamma_{e_q}^{\mathbf{e}_u} \chi(|e_{q,0}|, |x_0|)\right)^2 \leq \varphi(|[x_0 \ e_{q,0}]^\top|), \quad \forall k \in \mathbb{Z}_+, \end{aligned} \quad (5.67)$$

where $\varphi(s) = (\beta_{e_q}(s, 0) + \gamma_{e_q}^{\mathbf{e}_u} \chi(s, s))^2 + (\beta_x(s, 0) + \gamma_x^{\ell_x} (\beta_{e_x}(s, 0) + \gamma_{e_x}^{\mathbf{e}_u} \chi(s, s)))^2$. Note that the equilibrium points $\eta_{e_q}^y = 0$ and $\eta_{e_q}^u = 0$ of the buffer dynamics, i.e. (5.18a) and (5.18b), which the trajectory η^y and η^u satisfy, are trivially input-to-state stable with respect to $y: \mathbb{Z}_+ \rightarrow \mathbb{Y}$, $u: \mathbb{Z}_+ \rightarrow \mathbb{U}$ and the initial states $\eta_0^y \in \mathbb{Y}$ and $\eta_0^u \in \mathbb{U}$, respectively. Employing this fact and using (5.28), (5.35b), map Ξ in (5.22a) (with its Lipschitz continuity property) and the *regularity* property, i.e. Assumption 5.5.1, item i) in Definition 2.2.1, i.e. (2.15), for equilibrium point $[x_{eq} \ \hat{q}_{eq}]^\top = 0$ of closed-loop system (5.24) follows.

Part 4) Property (5.29), (5.39) and (5.55) of Assumption 5.3.1, Theorem 5.4.3 and Lemma 5.5.3, respectively, imply

$$\overline{\lim}_{k \rightarrow \infty} |x_k| \leq \gamma_x^{\ell_x} \left(\overline{\lim}_{k \rightarrow \infty} |e_{x,k}| \right), \quad (5.68a)$$

$$\overline{\lim}_{k \rightarrow \infty} |e_{x,k}| \leq \gamma_{e_x}^{\ell_u} \left(\overline{\lim}_{k \rightarrow \infty} |\mathbf{e}_{\mathbf{u},k}^{[1,n]}| \right), \quad (5.68b)$$

$$\overline{\lim}_{k \rightarrow \infty} |\mathbf{e}_{\mathbf{u},k}^{[1,n]}| \leq \gamma_{\mathbf{e}_u}^x \left(\overline{\lim}_{k \rightarrow \infty} |x_k| \right) + \gamma_{\mathbf{e}_u}^{\ell_x} \left(\overline{\lim}_{k \rightarrow \infty} |e_{x,k}| \right). \quad (5.68c)$$

Substitution of (5.68a) and (5.68b) in (5.68c) and subsequently substituting (5.68a) in the obtained expression and using the fact that $\gamma_{\mathbf{e}_u}^x = \gamma_{\mathbf{e}_u}^{\ell_x}$, yields

$$\overline{\lim}_{k \rightarrow \infty} |\mathbf{e}_{\mathbf{u},k}^{[1,n]}| \leq \gamma_{\mathbf{e}_u}^{\ell_x} \gamma_{e_x}^{\ell_u} (\gamma_x^{\ell_x} + 1) \left(\overline{\lim}_{k \rightarrow \infty} |\mathbf{e}_{\mathbf{u},k}^{[1,n]}| \right). \quad (5.69)$$

Due to the small gain property (5.54) in the hypothesis of Theorem 5.5.2 and the fact that $\overline{\lim}_{k \rightarrow \infty} |\mathbf{e}_{\mathbf{u},k}^{[1,n]}|$ is well-defined (due to compactness of $\mathbb{E}_{\mathbf{e}_u}$ one knows that $\overline{\lim}_{k \rightarrow \infty} |\mathbf{e}_{\mathbf{u},k}^{[1,n]}|$ is finite) one has that (5.69) is true only if

$$\overline{\lim}_{k \rightarrow \infty} |\mathbf{e}_{\mathbf{u},k}^{[1,n]}| = 0. \quad (5.70)$$

Then, (5.28), with \mathcal{F}_{e_q} defined as in (5.58), and (5.70) imply that for all initial states $[x_0 \ e_{q,0}]^\top \in \mathcal{X}^e(N) \times \mathcal{E}_q$ all solutions $[x \ e_q]^\top$ satisfy

$$\overline{\lim}_{k \rightarrow \infty} |[x_k \ e_{q,k}]^\top| = 0. \quad (5.71)$$

Employing the fact that the equilibrium points $\eta_{e_q}^y = 0$ and $\eta_{e_q}^u = 0$ of the buffer dynamics, i.e. (5.18a) and (5.18b), are input-to-state stable with respect to $y : \mathbb{Z}_+ \rightarrow \mathbb{Y}$, $u : \mathbb{Z}_+ \rightarrow \mathbb{U}$ and the initial states $\eta_0^y \in \mathbb{Y}$, $\eta_0^u \in \mathbb{U}$, respectively, and using (5.58), (5.35b), map Ξ in (5.22a) (with its Lipschitz continuity property) and the *regularity* property, i.e. Assumption 5.5.1, item ii) for closed-loop system (5.24) follows naturally for all initial states $x_0 \in \mathcal{X}^e(N)$ and $\hat{q}_0 \in \mathbb{Q}$ such that $(q_0 - \hat{q}_0) \in \mathcal{E}_q$. ■

Remark 5.5.4 Note that the small gain condition (5.54) can always be satisfied by choosing the regularity constant θ_1 , θ_2 small enough. However, in practice this might deteriorate the performance of the nonlinear model predictive controller. Also a nonlinear model predictive controller that renders the equilibrium point $x_{e_q} = 0$ of system (5.25) input-to-state stable might not exist, since imposing a tight regularity constraint might impose restrictions on the (constrained) stabilizability of the system. Ideally, one would therefore like to obtain small constants L_{f_z} and L_{Ξ} , respectively, as to allow

for a large θ_1, θ_2 and still satisfy (5.54). The constant L_{Ξ} can be reduced by choosing the function h_z appropriately (see (5.11)). However, this might, via (5.9) results in large L_{f_z} . A constructive way to reduce both L_{f_z} and L_{Ξ} is to reduce the Lipschitz constant of the system (5.1) (L_f) by employing for example pre-compensation. For details on this issue we refer the reader to [46] or [102].

5.6 Manufacturing example

Consider the manufacturing system as considered in Chapter 4, e.g. see Figure 4.3. In Chapter 4 it is assumed that the state, i.e. $[b_k^1 \ b_k^2 \ b_k^3]^\top$ or x_k of the system dynamics (4.42) or (4.45), is available for feedback. However, measuring all components of the state becomes impractical if the dimension of the state becomes larger when larger manufacturing lines are considered. In this section it is therefore assumed that knowledge of the state of the system is not available, but only the output of the manufacturing system is available for feedback, i.e.

$$y_k = g(x_k) = x_{3,k}. \quad (5.72)$$

Note that y_k corresponds, via a coordinate transformation (see Chapter 4), to the outflow of products of the manufacturing system, i.e. $b^3(t)$ in Figure 4.3. The output feedback nonlinear model predictive controller design approach proposed in this chapter is employed to design an output feedback controller for the manufacturing system.

Consider the description of the dynamics of the manufacturing system as given in (4.45) with its output equation as defined in (5.72). Note that for the considered system the observability map, as defined in Definition 5.1.1, reads

$$\Psi(x_k, \mathbf{u}_k^{[0,n-2]}) \triangleq \begin{bmatrix} x_{3,k} + \frac{T\mu(x_{2,k} + \alpha)}{(1+x_{2,k} + \alpha) - TC} \\ x_{3,k} + \frac{T\mu(x_{2,k} + \alpha)}{1+x_{2,k} + \alpha} - 2TC + \frac{T\mu \left(x_{2,k} + \frac{T\mu(x_{1,k} + \alpha)}{1+x_{1,k} + \alpha} - \frac{T\mu(x_{2,k} + \alpha)}{1+x_{2,k} + \alpha} + \alpha \right)}{1+x_{2,k} + \frac{T\mu(x_{1,k} + \alpha)}{1+x_{1,k} + \alpha} - \frac{T\mu(x_{2,k} + \alpha)}{1+x_{2,k} + \alpha} + \alpha} \end{bmatrix}. \quad (5.73)$$

Hence,

$$\det \left(\frac{\partial \Psi}{\partial x} \right) = \frac{-T^3 \mu^3}{a},$$

with

$$a \triangleq \left(1 + x_{1,k} + 2x_{2,k} + T\mu x_{1,k} - T\mu x_{2,k} + 2x_{2,k}x_{1,k}\alpha + \alpha^3 + 2x_{1,k}x_{2,k} + x_{2,k}^2 + x_{1,k}x_{2,k}^2 + x_{1,k}\alpha^2 + 2x_{1,k}\alpha + 4\alpha x_{2,k} + 3\alpha^2 + \alpha x_{2,k}^2 + 2x_{2,k}\alpha^2 + 3\alpha \right)^2$$

Note that

$$\det \left(\frac{\partial \Psi}{\partial x} \right) = \frac{-T^3 \mu^3}{a} \neq 0, \quad \forall x_k \in \mathbb{X}, \ u_k \in \mathbb{U},$$

with \mathbb{X} and \mathbb{U} as defined in (4.46). This implies that the system (4.45), (5.72) is strongly locally observable. In this case even global observability is obtained, which means that the system (4.45), (5.72) can be transformed globally into a system representation in ENOCF. Hence, Theorem 5.1.3 implies that an observer in ENOCF as given in (5.3) or (5.20) with Ξ as in (5.15) exists and is globally well defined. That is, the map Ξ in (5.15) acts for fixed control and output sequences as a globally well defined invertible map relating state x_k satisfying (5.1) and a state z_k satisfying a system representation in ENOCF in particular a system of the form as in (5.2). The following functions f_z and h_z , i.e.

$$h_z(z_{n,k}, \mathbf{u}_k^{[1-n,0]}) = z_{n,k},$$

$$f_z(\mathbf{y}_k^{[1-n,0]}, \mathbf{u}_k^{[1-n,0]}, \mathbf{u}_k^{[1,n]}) = \begin{bmatrix} 0 & 0 & f_{z,n-1}(\mathbf{y}_k^{[1-n,0]}, \mathbf{u}_k^{[1-n,0]}, u_{k+1}) \end{bmatrix}^\top,$$

where

$$f_{z,n-1}(\mathbf{y}_k^{[1-n,0]}, \mathbf{u}_k^{[1-n,0]}, u_{k+1}) = y_{k-1} - 4 + c_6 + \frac{3 \frac{3(y_{k-2} - y_{k-1})}{y_{k-1} - y_{k-2} - 1} + 3 \frac{3c_5 + 6}{3 - c_4} - 3(y_{k-1} - y_{k-2} + 2) + 3 \frac{3c_5 + 3/2u_{k-2} + 12 - 3 \frac{3c_5 + 6}{3 - c_4}}{5 - c_4 + 1/2u_{k-2} - \frac{3c_5 + 6}{3 - c_4}} - 3c_6 + 6}{3 - \frac{3(y_{k-1} - y_{k-2})}{y_{k-1} - y_{k-2} - 1} + \frac{3c_5 + 6}{3 - c_4} + y_{k-2} - y_{k-1} - 2 \frac{3c_5 + 3/2u_{k-2} + 12 - 3 \frac{3c_5 + 6}{3 - c_4}}{5 - c_4 + 1/2u_{k-2} - \frac{3c_5 + 6}{3 - c_4}} - c_6},$$

with

$$c_2 = (y_k - y_{k-1} - 1)y_{k-2}^2 + (1 + 2y_k - 2y_k y_{k-1} + 2y_{k-1}^2)y_{k-2} + 4y_k - 5y_{k-1} + y_{k-1}^2 - 1 - y_{k-1}^3 - 2y_k y_{k-1} + y_k y_{k-1}^2,$$

$$c_3 = 3(y_k - y_{k-1} - 1)y_{k-2}^2,$$

$$c_4 = \frac{((6y_{k-1} + 6 + 3y_k - 6y_k y_{k-1} + 3y_{k-1})y_{k-2} - 15y_{k-1} + 9y_k - 3y_{k-1}^3 + c_3 - 3y_k y_{k-1} + 3y_k y_{k-1}^2)}{c_2},$$

$$c_5 = \frac{((-6y_{k-1}^2 - 6 - 3y_k + 6y_k y_{k-1} - 3y_{k-1})y_{k-2} + 15y_{k-1} - 9y_k + 3y_{k-1}^3 - c_3 + 3y_k y_{k-1} - 3y_k y_{k-1}^2)}{c_2},$$

$$c_6 = \frac{3 \frac{3(y_{k-2} - y_{k-1})}{y_{k-1} - y_{k-2} - 1} + 3 \frac{3c_5 + 6}{3 - c_4} - 3(y_{k-1} - y_{k-2} + 2) + 6}{3 - \frac{3(y_{k-1} - y_{k-2})}{y_{k-1} - y_{k-2} - 1} + \frac{3c_5 + 6}{3 - c_4} - y_{k-2} + y_{k-1} + 2},$$

satisfy (5.9) and therefore define (globally) an observer of the form as in (5.20) with Ξ in (5.22a) defined as in (5.15). Note that in case of this example the resulting observer and the mapping Ξ is not a function of the future control variable ($\mathbf{u}_k^{[1,n]}$) of the system. Hence, $\mathbf{e}_{\mathbf{u},k}^{[1,n]} = 0$ for all $k \in \mathbb{Z}_+$ or $\gamma_{e_q}^{\mathbf{e}_u} = \gamma_{e_x}^{\mathbf{e}_u} = 0$. This implies that, for any model predictive controller satisfying Assumption 5.3.1, Theorem 5.5.2 applies for any gains $y_x^{e_x}, \theta_1, \theta_2 \in \mathbb{R}_{>0}$. Hence, the regularity property of the model predictive

controller defined in Definition 3.1.1 is not required in this case. A controller that satisfies Assumption 5.3.1 can be designed employing the design technique explained in Chapter 3 and employing the result obtained in Chapter 4, i.e. Corollary 4.1.4, as is also worked out in Section 4.3 for the considered manufacturing system. Employing this controller and injecting this controller with \hat{x}_k (i.e. \hat{z}_k translated to \hat{x} via Ξ), generated based on the designed observer in this section, instead of x_k will result in an asymptotically stable closed-loop system.

Note that in general, and in particular when the dimension of the considered system is relatively large, future control variables will appear in the observer defined by (5.20) and Ξ . In this case a small gain condition like the one given in Theorem 5.5.2 has to be satisfied to guarantee asymptotic stability of the equilibrium point $[x_{eq} \hat{q}_{eq}]^T$ of closed-loop system (5.24).

5.7 Summary

In this chapter an observer-based (output feedback) nonlinear predictive control approach for the class of strongly observable nonlinear discrete-time systems is proposed. It is proven that a separately designed controller and observer in closed-loop with the to-be-controlled system results in an asymptotically stable closed-loop system. Input-to-state stability notions for differential inclusions are employed to prove the results. Constructive procedures for both, the design of an input-to-state stable state feedback model predictive controller and a nonlinear observer, are indicated. All the results are valid despite the possibility of discontinuous and non-unique model predictive control laws. The effectiveness of the developed output based nonlinear model predictive control scheme is demonstrated via an illustrative manufacturing example.

*You see things; and you say,
"Why?" But I dream things that
never were; and I say, "Why not?"*

George Bernhard Shaw



Event driven manufacturing systems as time domain control systems

As explained in Chapter 1, manufacturing systems are often characterized as discrete event systems (DES). Their dynamical behaviors are driven only by occurrences of different type of events. See [26] for an overview of discrete event systems. One of the major difficulties of analyzing discrete event systems, from a control theory point of view, is the fact that generally speaking, those systems are hard to describe with the available time domain modeling frameworks present in the control systems literature. As explained in Chapter 1 and illustrated in Section 4.3, one of the approaches to overcome this problem is to synthesize controllers for DES manufacturing systems based on a *fluid model* of a manufacturing system, rather than the detailed description of a discrete event model. Based on this approach one can, for example, employ the controller design approach explained in the previous chapters. One of the consequences that this approach induces is that, for the controller synthesis, one has to design for robustness with respect to (fictive) disturbances even though no explicit disturbance signals are present in the original control problem formulation. This issue has been elaborated on in Section 4.3. An approach to avoid this problem is to base the controller synthesis directly on a discrete event model of the manufacturing system. However, as already has been pointed out, in the control systems literature there are no modeling frameworks available to which time domain control system theoretic notions, required for controller synthesis, can be employed to.

For some subclass of discrete event systems an algebra that allows, to some extend, for analytical study and a system theoretical-like controller design for discrete event (manufacturing) systems has been developed, see [29] for a survey. Based on this algebra some controller synthesis techniques have appeared, see for example [103, 104, 105]. However, in these papers modeling and controller synthesis is

performed in the so called *event domain*. In *event domain* based modeling the evolution of *time labels* associated to certain *events* is considered along a discrete *event axis*. Since all system theoretic notions and control objectives are time domain related, a compatibility and/or causality problem emerges.

In this chapter it is spelled out how a class of event driven manufacturing systems, modeled in an event domain setting, can be considered in the time domain context. The motivation of this issue is to apply conventional time domain control system theory notions as stability, robustness, controllability, observability and time domain based formulations of control objectives to event driven manufacturing systems modeled in an event domain setting. This result makes it possible to utilize event domain related mathematical tools to solve time domain related control problems.

6.1 Manufacturing systems in time domain

Mathematical models of (manufacturing) systems as we encounter them in practice may be expressed by ordinary or partial differential equations, and in the context of manufacturing systems they may involve formal (programming) languages, etc. It may seem hard to find a common denominator in all this. A perceptive observation, one which can be attributed to control theory, is to look at (manufacturing) systems, and subsystems, as *black boxes*. Thus, instead of trying to understand, in the tradition of physics, how a device or manufacturing system is “put together” and the detail of how all its components and subsystems work, we are told to concentrate on how it behaves, on the way in which it interacts with its environment. It is this black box point of view which will be formalized in its ultimate generality and is in control systems theory literature known as the so called *behavioral* approach to systems control theory, see [106] for a survey. In this approach one will back off from the usual input/output setting in which systems are seen as being influenced by inputs, acting as causes, and producing outputs through these inputs, the internal initial conditions, and the system dynamics. All variables will be considered a priori on an equal footing and the input/output as a special case which in many situations can actually be deduced from the original model.

The definition of a time domain dynamical system in the behavioral context is done at the set theoretic level. The strength of the behavioral approach comes from this formal setting and it helps in confronting a wider class of systems and coordinate free (model structure independent) definitions of control system theoretic notions. A discrete event manufacturing system in the *time domain* behavioral context can for example be defined as follows.

Definition 6.1.1 A discrete event manufacturing system in the *time domain* is defined

by the triple

$$\Sigma_{\mathcal{G}} = (\mathbb{T}, \mathbb{W}_{\mathcal{G}}, \mathfrak{B}_{\mathcal{G}}), \quad (6.1)$$

with $\mathbb{T} = \mathbb{R}$ the time axis, $\mathbb{W}_{\mathcal{G}} = \mathbb{Z}^n$ the signal space, and $\mathfrak{B}_{\mathcal{G}} \subseteq \mathbb{W}_{\mathcal{G}}^{\mathbb{T}}$, i.e.

$$\mathfrak{B}_{\mathcal{G}} \triangleq \left\{ w_{\mathcal{G}} : \mathbb{R} \rightarrow \mathbb{Z}^n \mid \begin{array}{l} \sigma^{\tau} w_{\mathcal{G}} \leq w_{\mathcal{G}}, \forall \tau \in \mathbb{T}_{>0} \\ \text{“Physical laws of the manufacturing system are satisfied”} \end{array} \right\},$$

the *behavior*. Here σ is a time shift operator, i.e. $\sigma^{\tau} w_{\mathcal{G}} \triangleq w_{\mathcal{G}}(t - \tau)$.

Definition 6.1.1 in words: Manufacturing system (6.1) is defined by \mathbb{T} representing time instances of interest, $\mathbb{W}_{\mathcal{G}}$ representing the space in which *event counters* take on their values and $\mathfrak{B}_{\mathcal{G}}$ as subset of $\mathbb{W}_{\mathcal{G}}^{\mathbb{T}}$ to which all allowable time trajectories of the system belong to. In the context of manufacturing systems the behaviors $\mathfrak{B}_{\mathcal{G}}$ that are considered are behaviors that at least guarantee that all signals $w_{\mathcal{G}}$ satisfying $\mathfrak{B}_{\mathcal{G}}$ have the property $w_{\mathcal{G}}(t - \tau) \leq w_{\mathcal{G}}(t)$, $\forall \tau \in \mathbb{T}_{>0}$ or $\sigma^{\tau} w_{\mathcal{G}} \leq w_{\mathcal{G}}$, $\forall \tau \in \mathbb{T}_{>0}$, i.e. signals $w_{\mathcal{G}}(t)$ are *non-decreasing*. Further restrictions on $\mathfrak{B}_{\mathcal{G}}$ formalize the laws of a specific manufacturing system. Allowing only *non-decreasing* signals in $\mathfrak{B}_{\mathcal{G}}$ is explained by the fact that $w_{\mathcal{G}}(t)$ represent counter functions which count how many times a particular event has taken place through time and cannot count backwards through time, i.e. once an event occurred for the k -th time at time $t = t^* \in \mathbb{T}$ the event cannot occur for the $k - 1$ -st time at time $t \in \mathbb{T}_{\geq t^*}$. Furthermore, throughout this chapter it is assumed that the considered manufacturing systems do not possess *Zeno* executions.

Definition 6.1.2 *Zeno* executions are trajectories which are characterized by an infinite number of events counted in a finite amount of elapsed time. Let t_k be the time instance at which $w_{\mathcal{F}_1}(t_k^-) < w_{\mathcal{F}_1}(t_k^+)$ then a *Zeno* trajectory $w_{\mathcal{F}_1}$ satisfies the following property

$$\sum_{k=0}^{\infty} t_{k+1} - t_k < \infty.$$

Example 6.1.3 Consider a manufacturing system, which consists of two processing units M_1 and M_2 with fixed processing times $d_1 \in \mathbb{R}_{>0}$ and $d_2 \in \mathbb{R}_{>d_1}$ respectively. Raw products are coming from two sources, knowing product stream A and B . In Figure 6.1 an iconic model of a simple manufacturing system is given. In which e_A , e_B , e_{M_1} and e_{M_2} are events defined as:

- $e_A \triangleq$ A raw product from product stream A arrives.
- $e_B \triangleq$ A raw product of product stream B arrives.
- $e_{M_1} \triangleq$ Machine M_1 starts processing.

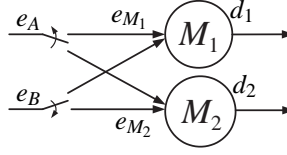

Figure 6.1: Considered manufacturing system ($d_1 < d_2$).

- $e_{M_2} \triangleq$ Machine M_2 starts processing.

It is given, that once a raw product arriving for the k -th time through one of the product streams it is followed by a raw product arriving for the k -th time through the other product stream. Since M_2 processes slower than M_1 , the following policy is applied: The first raw product arriving for the k -th time, either from A or B is processed on M_2 and the second raw product arriving for the k -th time, from A if B was first or from B if A was first, is processed on M_1 . Furthermore, the machines start processing as soon as a raw product is available for the machines and the previous processes on the machines have been finished. The considered manufacturing system can be modeled in the framework defined in Definition 6.1.1. Define functions $w_{\mathcal{F}_A} : \mathbb{R} \rightarrow \mathbb{Z}$, $w_{\mathcal{F}_B} : \mathbb{R} \rightarrow \mathbb{Z}$, $w_{\mathcal{F}_{M_1}} : \mathbb{R} \rightarrow \mathbb{Z}$ and $w_{\mathcal{F}_{M_2}} : \mathbb{R} \rightarrow \mathbb{Z}$. The functions are *counter* functions that count how many times the events e_A , e_B , e_{M_1} and e_{M_2} have occurred in time, respectively. The behavior $\mathfrak{B}_{\mathcal{F}}$ that defines the considered manufacturing system can then be defined as

$$\mathfrak{B}_{\mathcal{F}} = \left\{ w_{\mathcal{F}} = \begin{bmatrix} w_{\mathcal{F}_A} & w_{\mathcal{F}_B} & w_{\mathcal{F}_{M_1}} & w_{\mathcal{F}_{M_2}} \end{bmatrix}^{\top} : \mathbb{R} \rightarrow \mathbb{Z}^4 \mid \sigma^{\tau} w_{\mathcal{F}} \leq w_{\mathcal{F}}, \forall \tau \in \mathbb{T}_{>0}, \right. \\ \left. \begin{array}{l} w_{\mathcal{F}_A} + 1 \geq w_{\mathcal{F}_B}, \quad w_{\mathcal{F}_{M_1}} = \min(\sigma^{d_1} w_{\mathcal{F}_{M_1}} + 1, \min(w_{\mathcal{F}_B}, w_{\mathcal{F}_A})) \\ w_{\mathcal{F}_B} + 1 \geq w_{\mathcal{F}_A}, \quad w_{\mathcal{F}_{M_2}} = \min(\sigma^{d_2} w_{\mathcal{F}_{M_2}} + 1, \max(w_{\mathcal{F}_B}, w_{\mathcal{F}_A})) \end{array} \right\}. \quad (6.2)$$

Remark 6.1.4 In (6.2) the “physical laws” are described relating the defined signals in $w_{\mathcal{F}}$ via min and max relations and time shift operations σ however the “physical laws” defining the behavior $\mathfrak{B}_{\mathcal{F}}$ of the manufacturing system could also have been specified by a (computer) language, e.g. χ [27, 28].

A basic question that one could ask oneself, concerning for example the manufacturing system considered in Example 6.1.3, is whether the manufacturing system $\Sigma_{\mathcal{F}}$ is a *dynamic* or a *static* system. In the next definition it will be made precise when a system is a static or dynamical system.

Definition 6.1.5 [106] Let $\Sigma_{\mathcal{G}} = (\mathbb{T}, \mathbb{W}_{\mathcal{G}}, \mathfrak{B}_{\mathcal{G}})$ be a time invariant system. System $\Sigma_{\mathcal{G}}$ is said to be Δ -complete ($\Delta \in \mathbb{T}_{>0}$) if

$$\left\{ w_{\mathcal{G}} \in \mathfrak{B}_{\mathcal{G}} \right\} \Leftrightarrow \left\{ (\sigma^{-t} w_{\mathcal{G}})|_{\mathbb{T}_{[-\Delta,0]}} \in \mathfrak{B}_{\mathcal{G}}|_{\mathbb{T}_{[-\Delta,0]}}, \quad \forall t \in \mathbb{T} \right\};$$

if this holds for all $\Delta \in \mathbb{T}_{>0}$, system $\Sigma_{\mathcal{G}}$ is called a *dynamical* system; if it holds for $\Delta = 0$, system $\Sigma_{\mathcal{G}}$ is called *static*.

Δ -completeness is a system property which says that if a time domain trajectory $w_{\mathcal{G}}$ over an interval $\mathbb{T}_{[t-\Delta,t]}$ of the time axis belongs to the set of all allowable trajectories all defined only over an interval of $\mathbb{T}_{[t-\Delta,t]}$, i.e. $\mathfrak{B}_{\mathcal{G}}|_{\mathbb{T}_{[-\Delta,0]}} \subseteq \mathfrak{B}_{\mathcal{G}}$ for all time instances $t \in \mathbb{T}$, then the same trajectory $w_{\mathcal{G}}$ defined over the total (complete) domain of the time axis also belongs to the set of all allowable trajectories defined over the total domain \mathbb{T} , i.e. $\mathfrak{B}_{\mathcal{G}}$.

Clearly the manufacturing system considered in Example 6.1.3 is a dynamical system with $\Delta \geq d_2 \in \mathbb{R}_{>d_1}$. An important dynamical system related property, which will be used later in this chapter, is the so-called *memory span* of a dynamical system.

Definition 6.1.6 [106] Let $\Sigma_{\mathcal{G}} = (\mathbb{T}, \mathbb{W}_{\mathcal{G}}, \mathfrak{B}_{\mathcal{G}})$ be a dynamical system, then $\Sigma_{\mathcal{G}}$ is said to have *memory span* Δ ($\Delta \in \mathbb{T}_{>0}$) if $w_{\mathcal{G}}^1, w_{\mathcal{G}}^2 \in \mathfrak{B}_{\mathcal{G}}$, $w_{\mathcal{G}}^1 = w_{\mathcal{G}}^2$ for $t \in \mathbb{T}_{[t_1-\Delta,t_1]} \Rightarrow w_{\mathcal{G}}^1 \wedge w_{\mathcal{G}}^2 \in \mathfrak{B}_{\mathcal{G}}$. Where \wedge denotes concatenation (at time t_1), defined as

$$(w_{\mathcal{G}}^1 \wedge w_{\mathcal{G}}^2)(t) = \begin{cases} w_{\mathcal{G}}^1(t) & \text{for } t \in \mathbb{T}_{<t_1}, \\ w_{\mathcal{G}}^2(t) & \text{for } t \in \mathbb{T}_{\geq t_1}. \end{cases} \quad (6.3)$$

For a systems with memory span Δ one can decide to call signals on the domain $t \in \mathbb{T}_{<t_1-\Delta}$, the *past* and the signals on the domain $t \in \mathbb{T}_{\geq t_1}$ the *future*. Note that then given the system's trajectory for $t \in \mathbb{T}_{[t_1-\Delta,t_1]}$, with Δ the memory span of the system, the past and future are *independent* of each other. Hence, any allowable past can be concatenated with any allowable future.

6.2 Manufacturing systems in event domain

In the previous section discrete event manufacturing systems are considered from a time domain perspective. However, due to the *discrete* nature of manufacturing systems, i.e. the system is *event driven*, one can complementary to the time domain perspective, e.g. Definition 6.1.1, define a manufacturing system in the event domain, i.e.

Definition 6.2.1 A manufacturing system in the *event domain* is defined by the triple

$$\Sigma_{\mathcal{X}} = (\mathbb{K}, \mathbb{W}_{\mathcal{X}}, \mathfrak{B}_{\mathcal{X}}) \quad (6.4)$$

with $\mathbb{K} = \mathbb{Z}$ the *event axis*, $\mathbb{W}_{\mathcal{X}} = \mathbb{R}^n$ the signal space, and $\mathfrak{B}_{\mathcal{X}} \subseteq \mathbb{W}_{\mathcal{X}}^{\mathbb{K}}$, i.e.

$$\mathfrak{B}_{\mathcal{X}} \triangleq \left\{ w_{\mathcal{X}} : \mathbb{Z} \rightarrow \mathbb{R}^n \mid \begin{array}{l} \gamma w_{\mathcal{X}} \leq w_{\mathcal{X}}, \\ \text{“Physical laws of the manufacturing system are satisfied”} \end{array} \right\},$$

the *behavior*. Here, γ is an event shift operator, i.e. $\gamma w_{\mathcal{X}}(k) \triangleq w_{\mathcal{X}}(k-1)$.

Definition 6.2.1 in words: Manufacturing system (6.4) is defined by \mathbb{K} representing an event counter axis, $\mathbb{W}_{\mathcal{F}}$ representing the space in which event driven signals, containing *time instances*, take on their values and $\mathfrak{B}_{\mathcal{X}}$ as subset of $\mathbb{W}_{\mathcal{X}}$ to which all allowable event trajectories of the system belong to. In the context of manufacturing systems the behaviors $\mathfrak{B}_{\mathcal{X}}$ that are considered are behaviors that at least guarantee that all signals $w_{\mathcal{X}}(\cdot)$ satisfying $\mathfrak{B}_{\mathcal{X}}$ have the property $w_{\mathcal{X}}(k-1) \leq w_{\mathcal{X}}(k)$, $\forall k \in \mathbb{K}$ or $\gamma w_{\mathcal{X}} \leq w_{\mathcal{X}}$, i.e. signals $w_{\mathcal{X}}(k)$ are *non-decreasing*. Further restrictions on $\mathfrak{B}_{\mathcal{X}}$ formalize the laws of a specific manufacturing system. Allowing only *non-decreasing* signals in $\mathfrak{B}_{\mathcal{X}}$ is explained by the fact that the time instance an event occurred for the k -th time cannot be earlier than the time instance the same event occurred for the $k-1$ -st time.

Example 6.2.2 Consider again the manufacturing system in Example 6.1.3. The system can be modeled in the framework of (6.4). Define $w_{\mathcal{X}_A} : \mathbb{Z} \rightarrow \mathbb{R}$, $w_{\mathcal{X}_B} : \mathbb{Z} \rightarrow \mathbb{R}$, $w_{\mathcal{X}_{M_1}} : \mathbb{Z} \rightarrow \mathbb{R}$ and $w_{\mathcal{X}_{M_2}} : \mathbb{Z} \rightarrow \mathbb{R}$. $w_{\mathcal{X}_A}(k)$, $w_{\mathcal{X}_B}(k)$, $w_{\mathcal{X}_{M_1}}(k)$ and $w_{\mathcal{X}_{M_2}}(k)$ represent time instances at which the events e_A , e_B , e_{M_1} and e_{M_2} occurred for the k -th time, respectively. The behavior $\mathfrak{B}_{\mathcal{X}}$ that defines the considered manufacturing system can be defined as

$$\mathfrak{B}_{\mathcal{X}} = \left\{ w_{\mathcal{X}} = \begin{bmatrix} w_{\mathcal{X}_A} & w_{\mathcal{X}_B} & w_{\mathcal{X}_{M_1}} & w_{\mathcal{X}_{M_2}} \end{bmatrix}^{\top} : \mathbb{Z} \rightarrow \mathbb{R}^4 \mid \begin{array}{l} \gamma w_{\mathcal{X}} \leq w_{\mathcal{X}}, \\ \left. \begin{array}{l} \gamma w_{\mathcal{X}_A} \leq w_{\mathcal{X}_B}, \quad w_{\mathcal{X}_{M_1}} = \max(\gamma w_{\mathcal{X}_{M_1}} + d_1, \max(w_{\mathcal{X}_B}, w_{\mathcal{X}_A})) \\ \gamma w_{\mathcal{X}_B} \leq w_{\mathcal{X}_A}, \quad w_{\mathcal{X}_{M_2}} = \max(\gamma w_{\mathcal{X}_{M_2}} + d_2, \min(w_{\mathcal{X}_B}, w_{\mathcal{X}_A})) \end{array} \right\} \right\}. \quad (6.5)$$

□

A manufacturing system in (6.4) can have certain properties. A nice property (6.4) can have is for example *event shift invariance*.

Definition 6.2.3 A system $\Sigma_{\mathcal{X}} = (\mathbb{K}, \mathbb{W}_{\mathcal{X}}, \mathfrak{B}_{\mathcal{X}})$ is said to be *event shift invariant* if

$$w_{\mathcal{X}} \in \mathfrak{B}_{\mathcal{X}} \Rightarrow \gamma^c w_{\mathcal{X}} \in \mathfrak{B}_{\mathcal{X}}, \quad \forall c \in \mathbb{Z}. \quad (6.6)$$

Note that $\gamma^c w_{\mathcal{X}}(k)$ is a shorthand notation for $w_{\mathcal{X}}(k-c)$.

Definition 6.2.4 A system $\Sigma_{\mathcal{X}} = (\mathbb{K}, \mathbb{W}_{\mathcal{X}}, \mathfrak{B}_{\mathcal{X}})$ is said to be *L-complete* if for some $L \in \mathbb{Z}_+$

$$\left\{ w_{\mathcal{X}} \in \mathfrak{B}_{\mathcal{X}} \right\} \Leftrightarrow \left\{ (\gamma^{-k} w_{\mathcal{X}})|_{\mathbb{K}_{[-L,0]}} \in \mathfrak{B}_{\mathcal{X}}|_{\mathbb{K}_{[-L,0]}}, \quad \forall k \in \mathbb{K} \right\}. \quad (6.7)$$

One calls $\Sigma_{\mathcal{X}}$ static if $L = 0$, see Definition 6.1.5

L-completeness is a system property which says that if an event domain trajectory $w_{\mathcal{X}}$ over an interval $\mathbb{K}_{[k-L,k]}$ of the event axis belongs to the set of all allowable trajectories defined only over an interval of $\mathbb{K}_{[k-L,k]}$, i.e. $\mathfrak{B}_{\mathcal{X}}|_{\mathbb{K}_{[-L,0]}} \subseteq \mathfrak{B}_{\mathcal{X}}$, then the same trajectory $w_{\mathcal{X}}$ defined over the total (complete) domain of the event axis also belongs to the set of all allowable trajectories defined over the total domain, i.e. $\mathfrak{B}_{\mathcal{X}}$.

An interesting and very natural question is, whether, when one can describe a manufacturing system in (6.4) as a behavioral difference equation. That is, what properties of $\Sigma_{\mathcal{X}}$ allow the manufacturing system to be described by a behavior defined as

$$\mathfrak{B}_{\mathcal{X}} = \left\{ w_{\mathcal{X}} : \mathbb{Z} \rightarrow \mathbb{R}^n \mid \gamma w_{\mathcal{X}} \leq w_{\mathcal{X}}, \right. \\ \left. f_1(w_{\mathcal{X}}, \gamma w_{\mathcal{X}}, \dots, \gamma^{L-1} w_{\mathcal{X}}, \gamma^L w_{\mathcal{X}}) = f_2(w_{\mathcal{X}}, \gamma w_{\mathcal{X}}, \dots, \gamma^{L-1} w_{\mathcal{X}}, \gamma^L w_{\mathcal{X}}) \right\}, \quad (6.8)$$

where L is called the *event lag* of the system. In [106] a proposition is given that answers the question for discrete time dynamical systems. Since in the world of discrete time dynamical systems the time axis is of a discrete nature and in (6.4) the event axis \mathbb{K} is of a discrete nature, the proposition in [106] can trivially be employed in the case of manufacturing systems defined in Definition 6.2.1.

Proposition 6.2.5 Consider $\Sigma_{\mathcal{X}} = (\mathbb{K}, \mathbb{W}_{\mathcal{X}}, \mathfrak{B}_{\mathcal{X}})$ in (6.4). The following conditions are equivalent

- i) $\Sigma_{\mathcal{X}}$ is event shift invariant and *L-complete*;
- ii) $\Sigma_{\mathcal{X}}$ can be described by a behavioral difference equation with event lag L .

6.3 Interconnecting event and time domain

In this section the coupling between the modeling frameworks considered in Sections 6.1 and 6.2 is discussed. Assume one has a manufacturing system of which a description can be obtained in the form defined in Definition 6.1.1 and in Definition 6.2.1. A natural question that arises is whether or not the signals obeying the laws of (6.1) can somehow be related to the signals obeying (6.4) and vice versa. If there

exists a relation that links the signals of both domains in a unique manner, then we call the manufacturing system considered in either (6.1) or (6.4) *similar*, i.e.

Definition 6.3.1 Let $\Sigma_{\mathcal{X}} = (\mathbb{K}, \mathbb{W}_{\mathcal{X}}, \mathfrak{B}_{\mathcal{X}})$ and $\Sigma_{\mathcal{T}} = (\mathbb{T}, \mathbb{W}_{\mathcal{T}}, \mathfrak{B}_{\mathcal{T}})$ be a description for a timed manufacturing system, then $\Sigma_{\mathcal{X}}$ and $\Sigma_{\mathcal{T}}$ are *similar* if there exists a bijection $\pi : \mathbb{W}_{\mathcal{T}} \rightarrow \mathbb{W}_{\mathcal{X}}$ such that $w_{\mathcal{T}} \in \mathfrak{B}_{\mathcal{T}} \Leftrightarrow \pi(w_{\mathcal{T}}) \in \mathfrak{B}_{\mathcal{X}}$.

For π to be a bijection the following properties must hold, i.e. π must be

1. *injective* (one-to-one), that is, for every $w_{\mathcal{T}}^1, w_{\mathcal{T}}^2 \in \mathfrak{B}_{\mathcal{T}}$, $\pi(w_{\mathcal{T}}^1(t)) = \pi(w_{\mathcal{T}}^2(t)) \Rightarrow w_{\mathcal{T}}^1(t) = w_{\mathcal{T}}^2(t)$;
2. *surjective* (onto), that is, for every $w_{\mathcal{X}}(k) \in \mathfrak{B}_{\mathcal{X}}$, there exists $w_{\mathcal{T}}(t) \in \mathfrak{B}_{\mathcal{T}}$ such that $\pi(w_{\mathcal{T}}(t)) = w_{\mathcal{X}}(k)$.

A necessary condition for a map π to be injective, is that the system in time domain should *at least* be observed for a time span Δ . The time span Δ is a measure for the *memory span* of the system as defined in Definition 6.1.6. A system with memory span Δ must in general be observed for a time span Δ to be able to conclude whether or not two signals $w_{\mathcal{T}}^1 \in \mathfrak{B}_{\mathcal{T}}$, $w_{\mathcal{T}}^2 \in \mathfrak{B}_{\mathcal{T}}$ are equivalent, i.e. $w_{\mathcal{T}}^1 = w_{\mathcal{T}}^2$. Therefore, it is necessary to observe a signal at least for a time span Δ to obtain the injectivity property for a map π .

In the following result, a map π is proposed which maps a broad class of *time domain* descriptions for manufacturing systems, i.e. descriptions according to Definition 6.1.1, to *event domain* descriptions of manufacturing systems, i.e. descriptions according to Definition 6.2.1.

Theorem 6.3.2 Let $\Sigma_{\mathcal{X}} = (\mathbb{K}, \mathbb{W}_{\mathcal{X}}, \mathfrak{B}_{\mathcal{X}})$ and $\Sigma_{\mathcal{T}} = (\mathbb{T}, \mathbb{W}_{\mathcal{T}}, \mathfrak{B}_{\mathcal{T}})$ be a description of a timed manufacturing system according to Definitions 6.1.1, and 6.2.1. Furthermore, let the signals $w_{\mathcal{X}}$ and $w_{\mathcal{T}}$ correspond to the same physical events in the timed manufacturing system. Suppose $\Sigma_{\mathcal{X}} = (\mathbb{K}, \mathbb{W}_{\mathcal{X}}, \mathfrak{B}_{\mathcal{X}})$ is an even shift invariant description (Definition 6.2.3) which is *L*-complete (Definition 6.2.4). Then, if the timed manufacturing system is observed over a time span Δ in time and the function $w_{\mathcal{T}}(t)$ is right continuous¹, the map $\pi : \mathbb{W}_{\mathcal{T}} \rightarrow \mathbb{W}_{\mathcal{X}}$ defined as,

$$w_{\mathcal{X}_i}(k) = \pi_i(w_{\mathcal{T}_i}(t)) = \inf_{w_{\mathcal{T}_i}(t) \geq k, t \in \mathbb{R}} t, \quad i = \{1, \dots, n\}, \quad k \in \mathbb{Z}, \quad (6.9)$$

is a bijection such that $w_{\mathcal{T}} \in \mathfrak{B}_{\mathcal{T}} \Leftrightarrow \pi(w_{\mathcal{T}}) \in \mathfrak{B}_{\mathcal{X}}$, i.e. $\Sigma_{\mathcal{X}}$ and $\Sigma_{\mathcal{T}}$ are similar.

¹ $w_{\mathcal{T}}(a^+) = w_{\mathcal{T}}(a), \quad \forall a \in \mathbb{T}$.

Proof: First the "specific physics of a manufacturing system" for both event and time domain, see Definition 6.2.1 and Definition 6.1.1, respectively, is ignored. The following behaviors then follow

$$\mathfrak{B}_{\mathcal{X}}^* = \left\{ w_{\mathcal{X}} : \mathbb{Z} \rightarrow \mathbb{R}^n \mid \gamma w_{\mathcal{X}} \leq w_{\mathcal{X}} \right\} \quad (6.10)$$

and

$$\mathfrak{B}_{\mathcal{T}}^* = \left\{ w_{\mathcal{T}} : \mathbb{R} \rightarrow \mathbb{Z}^n \mid \sigma^\tau w_{\mathcal{T}} \leq w_{\mathcal{T}}, \forall \tau \in \mathbb{T}_{>0} \right\}. \quad (6.11)$$

Substituting (6.9) in the property, i.e. $\gamma w_{\mathcal{X}} \leq w_{\mathcal{X}}$, defined in the behavior given in (6.10) leads to the following inequality

$$\left(\inf_{w_{\mathcal{T}_1}(t) \geq (k-1), t \in \mathbb{R}} t \right) \leq \left(\inf_{w_{\mathcal{T}_1}(t) \geq k, t \in \mathbb{R}} t \right), \quad \forall k \in \mathbb{Z}. \quad (6.12)$$

Note that the inequality in (6.12) can only be satisfied for all $k \in \mathbb{Z}$ if the non-decreasing property, i.e. $\sigma^\tau w_{\mathcal{T}} \leq w_{\mathcal{T}} \forall \tau \in \mathbb{T}_{>0}$, in (6.11) is satisfied as well.

Let one now take the "specific physics of a manufacturing system", that has been ignored, into account. The systems behavior $\mathfrak{B}_{\mathcal{X}}$ under consideration is event shift invariant and L -complete. According to Proposition 6.2.5 this means that the systems behavior can be formulated as a difference equation with lag L in the domain defined in Definition 6.2.1. The behavioral difference equation in its general form is given in (6.8). Note that (6.9) implies

$$\begin{aligned} w_{\mathcal{X}} &= \pi(w_{\mathcal{T}}), \quad \gamma w_{\mathcal{X}} = \pi(w_{\mathcal{T}} + \mathbf{1}), \dots, \\ \gamma^{L-1} w_{\mathcal{X}} &= \pi(w_{\mathcal{T}} + (L-1)\mathbf{1}), \quad \gamma^L w_{\mathcal{X}} = \pi(w_{\mathcal{T}} + L\mathbf{1}), \end{aligned} \quad (6.13)$$

where $\mathbf{1} \triangleq [1, \dots, 1]^\top \in \mathbb{R}^n$. Using (6.8), the relations given in (6.13) and employing $\sigma^\tau w_{\mathcal{T}} \leq w_{\mathcal{T}} \forall \tau \in \mathbb{T}_{>0}$ the time domain behavior must consequentially be of the form

$$\mathfrak{B}_{\mathcal{T}} = \left\{ w_{\mathcal{T}} : \mathbb{R} \rightarrow \mathbb{Z}^n \mid \sigma^\tau w_{\mathcal{T}} \leq w_{\mathcal{T}}, \forall \tau \in \mathbb{T}_{>0}, \right. \\ \left. \begin{aligned} f_{\mathcal{T}_1}(w_{\mathcal{T}}, w_{\mathcal{T}} + \mathbf{1}, \dots, w_{\mathcal{T}} + (L-1)\mathbf{1}, w_{\mathcal{T}} + L\mathbf{1}) = \\ f_{\mathcal{T}_2}(w_{\mathcal{T}}, w_{\mathcal{T}} + \mathbf{1}, \dots, w_{\mathcal{T}} + (L-1)\mathbf{1}, w_{\mathcal{T}} + L\mathbf{1}) \end{aligned} \right\}. \quad (6.14)$$

The question however, is whether or not the arguments of $f_{\mathcal{T}_1}$ and $f_{\mathcal{T}_2}$ as they appear in (6.14) actually belong to $\mathfrak{B}_{\mathcal{T}}$. The answer is affirmative, because according to the hypothesis in Theorem 6.3.2 the signals $w_{\mathcal{X}}$ and $w_{\mathcal{T}}$ correspond to the same physical events in the system, i.e.

$$\gamma^c w_{\mathcal{X}} \in \mathfrak{B}_{\mathcal{X}} \Leftrightarrow w_{\mathcal{T}} + c\mathbf{1} \in \mathfrak{B}_{\mathcal{T}}, \quad \forall c \in \mathbb{Z}. \quad (6.15)$$

This means that the arguments of $f_{\mathcal{T}_1}$ and $f_{\mathcal{T}_2}$ as they appear in (6.14) belong to $\mathfrak{B}_{\mathcal{T}}$. ■

Example 6.3.3 Consider again the manufacturing system from Example 6.1.3 presented in Figure 6.1. Assume that the processing times are not constant this time. The processing times d_1 and d_2 vary within intervals $d_1 \in \mathbb{R}_{[5,9]}$ and $d_2 \in \mathbb{R}_{[4,5]}$ every time machines M_1 and M_2 process a product, respectively. The timed manufacturing system can be described in the *event domain*, i.e. Definition 6.2.1, with the behavior defined as

$$\mathfrak{B}_{\mathcal{H}} = \left\{ w_{\mathcal{H}} = \begin{bmatrix} w_{\mathcal{H}_A} & w_{\mathcal{H}_B} & w_{\mathcal{H}_{M_1}} & w_{\mathcal{H}_{M_2}} \end{bmatrix}^{\top} : \mathbb{Z} \rightarrow \mathbb{R}^4 \mid \begin{array}{l} \gamma w_{\mathcal{H}} \leq w_{\mathcal{H}}, \\ \gamma w_{\mathcal{H}_A} \leq w_{\mathcal{H}_B}, \quad d_1 \in \mathbb{R}_{[5,9]}, \quad w_{\mathcal{H}_{M_1}} = \max(\gamma w_{\mathcal{H}_{M_1}} + d_1, \max(w_{\mathcal{H}_B}, w_{\mathcal{H}_A})) \\ \gamma w_{\mathcal{H}_B} \leq w_{\mathcal{H}_A}, \quad d_2 \in \mathbb{R}_{[4,5]}, \quad w_{\mathcal{H}_{M_2}} = \max(\gamma w_{\mathcal{H}_{M_2}} + d_2, \min(w_{\mathcal{H}_B}, w_{\mathcal{H}_A})) \end{array} \right\}. \quad (6.16)$$

The system is event shift invariant, because for any signal $w_{\mathcal{H}}(\cdot) \in \mathfrak{B}_{\mathcal{H}}$ that is shifted some arbitrary event steps $\gamma^c w_{\mathcal{H}} \forall c \in \mathbb{Z}$, the following holds

$$\left\{ \begin{array}{l} \gamma^c w_{\mathcal{H}} : \mathbb{Z} \rightarrow \mathbb{R}^4 \mid \gamma^{(c+1)} w_{\mathcal{H}} \leq \gamma^c w_{\mathcal{H}}, \quad \gamma^{(c+1)} w_{\mathcal{H}_A} \leq \gamma^c w_{\mathcal{H}_B}, \quad \gamma^{(c+1)} w_{\mathcal{H}_B} \leq \gamma^c w_{\mathcal{H}_A} \\ d_1 \in \mathbb{R}_{[5,9]}, \quad \gamma^c w_{\mathcal{H}_{M_1}} = \max(\gamma^{(c+1)} w_{\mathcal{H}_{M_1}} + \gamma^c d_1, \max(\gamma^c w_{\mathcal{H}_B}, \gamma^c w_{\mathcal{H}_A})) \\ d_2 \in \mathbb{R}_{[4,5]}, \quad \gamma^c w_{\mathcal{H}_{M_2}} = \max(\gamma^{(c+1)} w_{\mathcal{H}_{M_2}} + \gamma^c d_2, \min(\gamma^c w_{\mathcal{H}_B}, \gamma^c w_{\mathcal{H}_A})) \end{array} \right\} = \mathfrak{B}_{\mathcal{H}}, \quad (6.17)$$

i.e. Definition 6.2.3 holds for the considered manufacturing system. Note that the lag L of the manufacturing system is equal to one. All signals belonging to $\mathfrak{B}_{\mathcal{H}}$, which are arbitrarily event shifted ($\gamma^c w_{\mathcal{H}} \forall c \in \mathbb{Z}$) and observed over an interval $\mathbb{K}_{[k,k+1]}$ of the event axis \mathbb{K} , also belong to the behavior $\mathfrak{B}_{\mathcal{H}}$ specified only on an interval $\mathbb{K}_{[k,k+1]}$ of the event axis. The system is thus L -complete, i.e. Definition 6.2.4 holds. The manufacturing system is event shift invariant and L -complete, and hence the proposed bijection π proposed in Theorem 6.3.2 can be applied to (6.16). This results in a behavior of the type considered in Definition 6.1.1, which for this example reads as

$$\mathfrak{B}_{\mathcal{T}} = \left\{ w_{\mathcal{T}} = \begin{bmatrix} w_{\mathcal{T}_A} & w_{\mathcal{T}_B} & w_{\mathcal{T}_{M_1}} & w_{\mathcal{T}_{M_2}} \end{bmatrix}^{\top} : \mathbb{R} \rightarrow \mathbb{Z}^4 \mid \begin{array}{l} \sigma^{\tau} w_{\mathcal{T}} \leq w_{\mathcal{T}}, \quad \forall \tau \in \mathbb{T}_{>0}, \\ w_{\mathcal{T}_A} + 1 \geq w_{\mathcal{T}_B}, \quad d_1 \in \mathbb{R}_{[5,9]}, \quad w_{\mathcal{T}_{M_1}} = f_{\mathcal{T}2_1}(w_{\mathcal{T}_{M_1}} + 1, w_{\mathcal{T}_B}, w_{\mathcal{T}_A}, d_1) \\ w_{\mathcal{T}_B} + 1 \geq w_{\mathcal{T}_A}, \quad d_2 \in \mathbb{R}_{[4,5]}, \quad w_{\mathcal{T}_{M_2}} = f_{\mathcal{T}2_2}(w_{\mathcal{T}_{M_2}} + 1, w_{\mathcal{T}_B}, w_{\mathcal{T}_A}, d_2) \end{array} \right\}. \quad (6.18)$$

An analytical expression for $f_{\mathcal{T}2_1}$ and $f_{\mathcal{T}2_2}$ cannot trivially be derived. However, if

one assumes d_1 and d_2 are fixed constant processing times (6.18) can be written as

$$\mathfrak{B}_{\mathcal{T}} = \left\{ w_{\mathcal{T}} = \begin{bmatrix} w_{\mathcal{T}_A} & w_{\mathcal{T}_B} & w_{\mathcal{T}_{M_1}} & w_{\mathcal{T}_{M_2}} \end{bmatrix}^{\top} : \mathbb{R} \rightarrow \mathbb{Z}^4 \mid \sigma^{\tau} w_{\mathcal{T}} \leq w_{\mathcal{T}}, \forall \tau \in \mathbb{T}_{>0}, \right. \\ \left. \begin{array}{l} w_{\mathcal{T}_A} + 1 \geq w_{\mathcal{T}_B}, \quad w_{\mathcal{T}_{M_1}} = \min(\sigma^{d_1}(w_{\mathcal{T}_{M_1}} + 1), \min(w_{\mathcal{T}_B}, w_{\mathcal{T}_A})) \\ w_{\mathcal{T}_B} + 1 \geq w_{\mathcal{T}_A}, \quad w_{\mathcal{T}_{M_2}} = \min(\sigma^{d_2}(w_{\mathcal{T}_{M_2}} + 1), \max(w_{\mathcal{T}_B}, w_{\mathcal{T}_A})) \end{array} \right\}. \quad (6.19)$$

And hence, this boils down to the derived time domain behavior in Example 6.1.3.

Control is about manipulating the behavior of the to-be-controlled system in such a way that it will behave through time as specified by time domain related design specifications. Therefore for successfully employing model based *time domain* control synthesis, knowledge of the explicit structure of a time domain model is usually required. However, one can conclude from Example 6.3.3 that although the analytical structure of a timed manufacturing system can be derived straightforwardly in the *event domain*, i.e. Definition 6.2.1, the analytical structure of the same manufacturing system in the *time domain* appears to be very hard or impossible to obtain, i.e. the explicit structure of $f_{\mathcal{T}_{2_1}}$ and $f_{\mathcal{T}_{2_2}}$ in (6.18) is hard or impossible to obtain.

If Theorem 6.3.2 applies and thus a bijective relation between the event domain and time domain is known, i.e. π in (6.9), it is not necessary to know the mathematical structure of a model of the manufacturing system in time domain explicitly to conclude about the behavior of the manufacturing system in the time domain. That is, the explicit knowledge of the (mathematical) structure of a model in the event domain is, under Theorem 6.3.2, sufficient to conclude about the time domain behavior of the considered manufacturing system.

6.4 Input/state models

In this section input/state models for time domain event driven manufacturing systems are introduced which one will employ in the next section in a model predictive control strategy to perform predictions of the future behavior of the system. In section 3.1 input/state models for a class of discrete-time nonlinear systems are also employed in the model predictive control strategy to make a prediction of the future behavior of the system. Input/state models have a few nice properties, that is

- The memory of a system is displayed through latent or auxiliary variables called *state variables*;
- The *cause/effect* structure is made explicit by a suitable partition of $w_{\mathcal{T}}$.

The above properties are convenient to predict the future behavior, i.e. the *effect*, of the system at the current time based on information from the past and the given future *cause*. Before the class of input/state models will be formally defined a few notions are introduced. First the notion of *input* will be introduced into the modeling framework presented in Section 6.1 in Definition 6.1.1.

Definition 6.4.1 [106] Consider the time domain dynamical system from Definition 6.1.1, i.e. $\Sigma_{\mathcal{G}} = (\mathbb{T}, \mathbb{W}_{\mathcal{G}}, \mathfrak{B}_{\mathcal{G}})$, with $\mathbb{W}_{\mathcal{G}} \triangleq \mathbb{W}_{\mathcal{G}_1} \times \mathbb{W}_{\mathcal{G}_2}$. Suppose $\Sigma_{\mathcal{G}}$ is complete (Definition 6.1.5). Then, signal $w_{\mathcal{G}_1}$ is said to be *free* if it is trim (i.e. $\forall w_{\mathcal{G}_1} \in \mathbb{W}_{\mathcal{G}_1}, \exists w_{\mathcal{G}_2} \in \mathfrak{B}_{\mathcal{G}}$ such that $w_{\mathcal{G}_1}(t_1) = w_{\mathcal{G}_2}(t_1)$) and memoryless.

Hence, *free* implies no local constraints (trim), no memory (memoryless) and no constraints at time $t = \pm\infty$ (complete).

Definition 6.4.2 [106] Consider the time domain dynamical system from Definition 6.1.1, i.e. $\Sigma_{\mathcal{G}} = (\mathbb{T}, \mathbb{W}_{\mathcal{G}}, \mathfrak{B}_{\mathcal{G}})$, with $\mathbb{W}_{\mathcal{G}} \triangleq \mathbb{W}_{\mathcal{G}_1} \times \mathbb{W}_{\mathcal{G}_2}$. It is said that $w_{\mathcal{G}_2}$ *processes* $w_{\mathcal{G}_1}$ if

$$\left\{ \left[w_{\mathcal{G}_1}^{\top} \ w_{\mathcal{G}_2}^{\top} \right]^{\top}, \left[w_{\mathcal{G}_1}^{\top} \ w_{\mathcal{G}_2}^{\top} \right]^{\top} \in \mathfrak{B}_{\mathcal{G}}, \ w_{\mathcal{G}_2}^1(t) = w_{\mathcal{G}_2}^2(t) \text{ for } t \in \mathbb{T}_{<t_1} \right\} \Rightarrow \left\{ w_{\mathcal{G}_2}^1 = w_{\mathcal{G}_2}^2 \right\}.$$

Processing means that $w_{\mathcal{G}_2}$ can be deduced from $w_{\mathcal{G}_1}$, the dynamical systems laws ($\mathfrak{B}_{\mathcal{G}}$), and the initial conditions (the past of $w_{\mathcal{G}_2}$). The notion of *input* can now be defined.

Definition 6.4.3 Consider the time domain dynamical system from Definition 6.1.1, i.e. $\Sigma_{\mathcal{G}} = (\mathbb{T}, \mathbb{W}_{\mathcal{G}}, \mathfrak{B}_{\mathcal{G}})$, with $\mathbb{W}_{\mathcal{G}} \triangleq \mathbb{W}_{\mathcal{G}_1} \times \mathbb{W}_{\mathcal{G}_2}$. If

1. $w_{\mathcal{G}_1}$ is *free* (Definition 6.4.1);
2. $w_{\mathcal{G}_2}$ *processes* $w_{\mathcal{G}_1}$ (Definition 6.4.2),

then the signal $w_{\mathcal{G}_1}$ is called an *input* of system $\Sigma_{\mathcal{G}}$.

The next notion that will be introduced is *nonanticipation*.

Definition 6.4.4 [106] Consider the time domain dynamical system from Definition 6.1.1, i.e. $\Sigma_{\mathcal{G}} = (\mathbb{T}, \mathbb{W}_{\mathcal{G}}, \mathfrak{B}_{\mathcal{G}})$, with $\mathbb{W}_{\mathcal{G}} \triangleq \mathbb{W}_{\mathcal{G}_1} \times \mathbb{W}_{\mathcal{G}_2}$. It will be said that

$w_{\mathcal{G}_2}$ does not anticipate $w_{\mathcal{G}_1}$ if

$$\left\{ \left[w_{\mathcal{G}_1}^{1\top} \ w_{\mathcal{G}_2}^{1\top} \right]^\top, \left[w_{\mathcal{G}_1}^{2\top} \ w_{\mathcal{G}_2}^{2\top} \right]^\top \in \mathfrak{B}_{\mathcal{G}}, \text{ and } w_{\mathcal{G}_1}^1(t) = w_{\mathcal{G}_1}^2(t) \text{ for } t \in \mathbb{T}_{\leq t_1} \right\} \Rightarrow \left\{ \exists w_{\mathcal{G}_2} \text{ such that } \left[w_{\mathcal{G}_1}^{2\top} \ w_{\mathcal{G}_2}^\top \right]^\top \in \mathfrak{B}_{\mathcal{G}} \text{ and } w_{\mathcal{G}_2} = w_{\mathcal{G}_2}^1 \text{ for } t \in \mathbb{T}_{\leq t_1} \right\}.$$

The definition of *nonanticipation* tells that the past of $w_{\mathcal{G}_2}$ does not contain information about the future of $w_{\mathcal{G}_1}$ other than the information already contained in the dynamical laws ($\mathfrak{B}_{\mathcal{G}}$). Let $\Sigma_{\mathcal{G}} = (\mathbb{T}, \mathbb{W}_{\mathcal{G}}, \mathfrak{B}_{\mathcal{G}})$, with $\mathbb{W}_{\mathcal{G}} \triangleq \mathbb{W}_{\mathcal{G}_1} \times \mathbb{W}_{\mathcal{G}_2}$ and $w_{\mathcal{G}_1}$ the *input* for $\Sigma_{\mathcal{G}}$. Then, if system $\Sigma_{\mathcal{G}}$ is *nonanticipating*, i.e. $w_{\mathcal{G}_2}$ does not anticipate $w_{\mathcal{G}_1}$, then it is possible to think of the input as the “*cause*” and $w_{\mathcal{G}_2}$ as the “*effect*”².

Next the notion of *state variables*, or the state for brevity, is introduced. Once the *state* of the system at the current time is known, the future behavior (together with a possible presence of an input or other external signals) is fixed and no additional information relevant for the future will be acquired by giving further details about past trajectories. A way of thinking about the state intuitively is that *the state should contain sufficient information about the past so as to determine (together with an input or external signal) the future behavior of the system*. In fact the state variables, specify the internal memory of a dynamical system.

Definition 6.4.5 [106] A time domain *state-space dynamical system* $\Sigma_{\mathcal{G}_s}$ is a quadruple

$$\Sigma_{\mathcal{G}_s}(\mathbb{T}, \mathbb{W}_{\mathcal{G}}, \mathbb{X}_{\mathcal{G}}, \mathfrak{B}_{\mathcal{G}_s}) \quad (6.20)$$

where $\mathbb{X}_{\mathcal{G}}$ is the state-space and $\mathfrak{B}_{\mathcal{G}_s}$ is called the *full behavior* of the system which satisfies *the axiom of state*. This axiom requires that

$$\left\{ \left[w_{\mathcal{G}}^{1\top} \ x_{\mathcal{G}}^{1\top} \right]^\top, \left[w_{\mathcal{G}}^{2\top} \ x_{\mathcal{G}}^{2\top} \right]^\top \in \mathfrak{B}_{\mathcal{G}_s}, t \in \mathbb{T}, \text{ and } x_{\mathcal{G}}^1(t) = x_{\mathcal{G}}^2(t) \right\} \Rightarrow \left\{ \left[w_{\mathcal{G}}^\top \ x_{\mathcal{G}}^\top \right]^\top \in \mathfrak{B}_{\mathcal{G}_s} \right\},$$

with $[w_{\mathcal{G}}^\top, x_{\mathcal{G}}^\top]^\top$ defined as

$$\left[w_{\mathcal{G}}(t')^\top \ x_{\mathcal{G}}(t')^\top \right]^\top = \begin{cases} \left[w_{\mathcal{G}}^{1\top}(t') \ x_{\mathcal{G}}^{1\top}(t') \right]^\top & \text{for } t' \in \mathbb{T}_{\leq t} \\ \left[w_{\mathcal{G}}^{2\top}(t') \ x_{\mathcal{G}}^{2\top}(t') \right]^\top & \text{for } t' \in \mathbb{T}_{> t}, \end{cases}$$

and $x_{\mathcal{G}}(t)$ represents the *state* of the system.

²Note that the system defined in Chapter 5 in (5.2) is an example of a system description which is *not nonanticipating*.

The axiom of state, as given in Definition 6.4.5, requires that any trajectory from $\mathfrak{B}_{\mathcal{G}_s}$ arriving in a particular state can be *concatenated* with any trajectory from $\mathfrak{B}_{\mathcal{G}_s}$ emanating from that same state.

The input/state model, which has the two properties stated in the beginning of this section and will be employed in the next section in a model predictive control formulation, can now be defined.

Definition 6.4.6 An input/state dynamical system is defined as a quadruple

$$\Sigma_{\mathcal{G}_1/\mathcal{S}}(\mathbb{T}, \mathbb{U}_{\mathcal{G}}, \mathbb{W}_{\mathcal{G}}, \mathbb{X}_{\mathcal{G}}, \mathfrak{B}_{\mathcal{G}_s}), \quad (6.21)$$

where $\mathfrak{B}_{\mathcal{G}_s} \subseteq (\mathbb{U}_{\mathcal{G}} \times \mathbb{W}_{\mathcal{G}}, \mathbb{X}_{\mathcal{G}})^{\top}$ is the full behavior and $\mathbb{U}_{\mathcal{G}}$ is the input space such that $u_{\mathcal{G}}$ is *free* in $(\mathbb{T}, \mathbb{W}_{\mathcal{G}} \times \mathbb{X}_{\mathcal{G}}, \mathfrak{B}_{\mathcal{G}_s})$ and $[w_{\mathcal{G}}^{\top}, x_{\mathcal{G}}^{\top}]^{\top}$ *processes* $u_{\mathcal{G}}$ in $(\mathbb{T}, \mathbb{W}_{\mathcal{G}} \times \mathbb{X}_{\mathcal{G}}, \mathfrak{B}_{\mathcal{G}_s})$. Furthermore, it is required that

1. $[w_{\mathcal{G}}^{\top} \ x_{\mathcal{G}}^{\top}]^{\top}$ *does not anticipate* $u_{\mathcal{G}}$ in $(\mathbb{T}, \mathbb{U}_{\mathcal{G}} \times \mathbb{W}_{\mathcal{G}} \times \mathbb{X}_{\mathcal{G}}, \mathfrak{B}_{\mathcal{G}_s})$;
2. $(\mathbb{T}, \mathbb{U}_{\mathcal{G}} \times \mathbb{W}_{\mathcal{G}}, \mathbb{X}_{\mathcal{G}}, \mathfrak{B}_{\mathcal{G}_s})$ is a *state-space dynamical system*.

An example of an input/state model (representation) is given in the sequel.

Theorem 6.4.7 Let Δ be the memory span of the following system

$$\Sigma_{\mathcal{G}}(\mathbb{T}, \mathbb{U}_{\mathcal{G}} \times \mathbb{W}_{\mathcal{G}}, \mathfrak{B}_{\mathcal{G}}), \quad (6.22)$$

with $u_{\mathcal{G}}$ the input and $w_{\mathcal{G}}$ does not anticipate $u_{\mathcal{G}}$. Furthermore, let

$$\mathbb{X}_{\mathcal{G}} \triangleq (\mathbb{T}_{[-\Delta, 0)} \rightarrow \mathbb{W}_{\mathcal{G}}).$$

Then, system representation (6.21) in Definition 6.4.6 with $\mathfrak{B}_{\mathcal{G}_s}$ defined as

$$\mathfrak{B}_{\mathcal{G}_s} = \left\{ \begin{aligned} & \left[u_{\mathcal{G}}^{\top} \ w_{\mathcal{G}}^{\top} \right]^{\top} : \mathbb{T} \rightarrow \mathbb{U}_{\mathcal{G}} \times \mathbb{W}_{\mathcal{G}}, \quad x_{\mathcal{G}} : \mathbb{T} \rightarrow \mathbb{X}_{\mathcal{G}} \mid \left[u_{\mathcal{G}}^{\top} \ w_{\mathcal{G}}^{\top} \right]^{\top} \in \mathfrak{B}_{\mathcal{G}}, \\ & x_{\mathcal{G}} = (\sigma^{-t} w_{\mathcal{G}}) \Big|_{\mathbb{T}_{[-\Delta, 0)}} \in \mathfrak{B}_{\mathcal{G}} \Big|_{\mathbb{T}_{[-\Delta, 0)}}, \quad \forall t \in \mathbb{T} \end{aligned} \right\}, \quad (6.23)$$

is an input/state representation for system (6.22).

Proof: It is trivial to show that if $w_{\mathcal{G}}$ does not anticipate $u_{\mathcal{G}}$ in $(\mathbb{T}, \mathbb{U}_{\mathcal{G}} \times \mathbb{W}_{\mathcal{G}}, \mathfrak{B}_{\mathcal{G}})$, that then also holds that $[w_{\mathcal{G}}^{\top}, x_{\mathcal{G}}^{\top}]^{\top}$ does not anticipate $u_{\mathcal{G}}$ in $(\mathbb{T}, \mathbb{U}_{\mathcal{G}} \times \mathbb{W}_{\mathcal{G}}, \mathfrak{B}_{\mathcal{G}_s})$ for $\mathfrak{B}_{\mathcal{G}_s}$ as given in (6.23) (i.e. item 1 in Definition 6.4.6 is thus satisfied). It remains then to be shown that $(\mathbb{T}, \mathbb{U}_{\mathcal{G}} \times \mathbb{W}_{\mathcal{G}}, \mathbb{X}_{\mathcal{G}}, \mathfrak{B}_{\mathcal{G}_s})$ is a *state-space dynamical*

system. That is, it has to be proven that $\mathfrak{B}_{\mathcal{F}_s}$ given in (6.23) satisfies the *axiom of state* given in Definition 6.4.5. Indeed, given a trajectory

$$\left[\left[u_{\mathcal{F}}^{1\top} \ w_{\mathcal{F}}^{1\top} \right]^\top \ x_{\mathcal{F}}^{1\top} \right]^\top \in \mathfrak{B}_{\mathcal{F}_s}$$

and another trajectory

$$\left[\left[u_{\mathcal{F}}^{2\top} \ w_{\mathcal{F}}^{2\top} \right]^\top \ x_{\mathcal{F}}^{2\top} \right]^\top \in \mathfrak{B}_{\mathcal{F}_s}$$

and the constraint

$$\left\{ x_{\mathcal{F}}^1(t) = x_{\mathcal{F}}^2(t) \right\} \Leftrightarrow \left\{ w_{\mathcal{F}}^{1\top}(t + \tau) = w_{\mathcal{F}}^{2\top}(t + \tau), \quad \tau \in \mathbb{T}_{[-\Delta, 0]} \right\} \in \mathfrak{B}_{\mathcal{F}}$$

then, it follows that

$$\left[u_{\mathcal{F}}^{1\top}(t') \ w_{\mathcal{F}}^{1\top}(t') \right]^\top = \left[u_{\mathcal{F}}^{1\top}(t') \ \underbrace{\left\{ w_{\mathcal{F}}^{1\top}(t + \tau), \ \tau \in \mathbb{T}_{[-\Delta, 0]} \right\}}_{x_{\mathcal{F}}^{1\top}(t)} \right]^\top, \quad \text{for } t' \in \mathbb{T}_{[t-\Delta, t]}.$$
(6.24)

Without loss of generality one can say that $u_{\mathcal{F}}^{1\top}(t') = u_{\mathcal{F}}^{2\top}(t')$ for $t' \in \mathbb{T}_{[t-\Delta, t]}$ (due to property of input) and therefore

$$\begin{aligned} & \left[u_{\mathcal{F}}^{1\top}(t') \ w_{\mathcal{F}}^{1\top}(t') \right]^\top = \\ & = \left[u_{\mathcal{F}}^{2\top}(t') \ w_{\mathcal{F}}^{2\top}(t') \right]^\top = \left[u_{\mathcal{F}}^{2\top}(t') \ \underbrace{\left\{ w_{\mathcal{F}}^{2\top}(t + \tau), \ \tau \in [-\Delta, 0] \right\}}_{x_{\mathcal{F}}^{2\top}(t)} \right]^\top, \quad \text{for } t' \in \mathbb{T}_{[t-\Delta, t]}. \end{aligned}$$
(6.25)

From expressions (6.24), (6.25) and Definition 6.1.6 it then follows that

$$\left[u_{\mathcal{F}}^{1\top} \ w_{\mathcal{F}}^{1\top} \right]^\top \wedge \left[u_{\mathcal{F}}^{2\top} \ w_{\mathcal{F}}^{2\top} \right]^\top = \left[u_{\mathcal{F}}^\top \ w_{\mathcal{F}}^\top \right]^\top \in \mathfrak{B}_{\mathcal{F}},$$
(6.26)

with

$$\left[u_{\mathcal{F}}^\top(t') \ w_{\mathcal{F}}^\top(t') \right]^\top = \begin{cases} \left[u_{\mathcal{F}}^{1\top}(t') \ w_{\mathcal{F}}^{1\top}(t') \right]^\top & \text{for } t' \in \mathbb{T}_{<t} \\ \left[u_{\mathcal{F}}^{2\top}(t') \ w_{\mathcal{F}}^{2\top}(t') \right]^\top & \text{for } t' \in \mathbb{T}_{\geq t}, \end{cases}$$
(6.27)

which in turn implies that

$$\left[\left[u_{\mathcal{F}}^\top \ w_{\mathcal{F}}^\top \right]^\top \ x_{\mathcal{F}}^\top \right]^\top \in \mathfrak{B}_{\mathcal{F}_s},$$

with

$$\left[\left[u_{\mathcal{F}}^\top(t') \ w_{\mathcal{F}}^\top(t') \right]^\top \ x_{\mathcal{F}}^\top(t') \right]^\top = \begin{cases} \left[\left[u_{\mathcal{F}}^{1\top}(t') \ w_{\mathcal{F}}^{1\top}(t') \right]^\top \ x_{\mathcal{F}}^{1\top}(t') \right]^\top & \text{for } t' \in \mathbb{T}_{<t} \\ \left[\left[u_{\mathcal{F}}^{2\top}(t') \ w_{\mathcal{F}}^{2\top}(t') \right]^\top \ x_{\mathcal{F}}^{2\top}(t') \right]^\top & \text{for } t' \in \mathbb{T}_{\geq t}. \end{cases}$$
(6.28)

Hence, $\mathfrak{B}_{\mathcal{F}_s}$ satisfies the axiom of state. ■

Example 6.4.8 Consider a simple example of a timed manufacturing system as depicted in Figure 6.2. The system consist of a processing unit and a buffer denoted by M_i and B_i , respectively. On the processing unit M_i products are processed with a fixed processing time $d_i \in \mathbb{R}_{>0}$. Raw products enter the system through the buffer system B_i , which has a total capacity of $N_i \in \mathbb{Z}_{\geq 1}$ products. Incoming products wait in the buffer until machine M_i is finished processing, a possibly present, preceding product being possessed on machine M_i . The buffer system is working according to a FIFO³ policy, that is, the first product which enters the buffer will also be the first one to leave the buffer system. Furthermore, machine M_i will start processing a product if, a possibly present, preceding product is finished and there is at least one product present in buffer B_i . The above description of the manufacturing system is formalized into

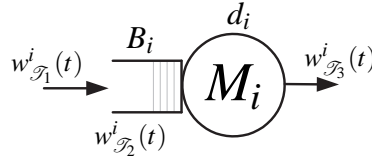

Figure 6.2: An example of a manufacturing system.

a model description in the time domain, i.e. Definition 6.1.1. Define $w_{\mathcal{F}_1}^i : \mathbb{R} \rightarrow \mathbb{Z}$, $w_{\mathcal{F}_2}^i : \mathbb{R} \rightarrow \mathbb{Z}$ and $w_{\mathcal{F}_3}^i : \mathbb{R} \rightarrow \mathbb{Z}$. Here $w_{\mathcal{F}_1}^i(t)$, $w_{\mathcal{F}_2}^i(t)$ and $w_{\mathcal{F}_3}^i(t)$ represent the number of times, a product is released from some external source, a product has entered buffer B_i , a product has left the manufacturing line at time $t \in \mathbb{R}$, respectively. The dynamics in time domain perspective can now be described as: The number of products that have entered the buffer at time t equals the minimum of the number of available products $w_{\mathcal{F}_1}^i$ and the number of products that have left the system $w_{\mathcal{F}_3}^i$ added with the total capacity of the system, i.e. $N_i + 1$. Furthermore, the number of products that have left the system $w_{\mathcal{F}_3}^i$ equals the minimum of products that has entered the buffer $w_{\mathcal{F}_1}^i$ and of the number of products that had left d_i time units ago. In terms of the behavior $\mathfrak{B}_{\mathcal{F}}$ in Definition 6.1.1 this yields for some fixed $N_i \in \mathbb{Z}_{\geq 1}$ and $d_i \in \mathbb{R}_{>0}$

$$\mathfrak{B}_{\mathcal{F}}^i = \left\{ w_{\mathcal{F}}^i \triangleq \begin{bmatrix} w_{\mathcal{F}_1}^i \\ w_{\mathcal{F}_2}^i \\ w_{\mathcal{F}_3}^i \end{bmatrix} : \mathbb{R} \rightarrow \mathbb{Z}^3 \left| \begin{array}{l} w_{\mathcal{F}_2}^i = \min(w_{\mathcal{F}_1}^i, w_{\mathcal{F}_3}^i + N_i + 1) \\ w_{\mathcal{F}_3}^i = \min(\sigma^{d_i} w_{\mathcal{F}_1}^i, \sigma^{d_i} w_{\mathcal{F}_3}^i + 1) \\ \sigma^{\tau} w_{\mathcal{F}}^i \geq w_{\mathcal{F}}^i, \tau \in \mathbb{T}_{>0} \end{array} \right. \right\}. \quad (6.29)$$

One can now easily obtain the description according to Definition 6.1.1 of a manufacturing system consisting of a series connection of $p \in \mathbb{Z}_{\geq 1}$ manufacturing systems as

³FIFO is an abbreviation for First In First Out.

presented in Fig. 6.2 forming a manufacturing line. The behavior defining a manufacturing line of a series connection of p manufacturing systems as presented in Fig. 6.2 is then defined for some fixed $N_i \in \mathbb{Z}_{\geq 1}$ and $d_i \in \mathbb{R}_{>0}$, $i = \{1, 2, \dots, p\}$ as

$$\mathfrak{B}_{\mathcal{F}}^p \triangleq \left\{ \begin{bmatrix} w_{\mathcal{F}}^1 \\ \vdots \\ w_{\mathcal{F}}^p \end{bmatrix} : \mathbb{T} \rightarrow \mathbb{Z}^{3p} \mid \bigcup_{i=1}^p \mathfrak{B}_{\mathcal{F}}^i, w_{\mathcal{F}_3}^i = w_{\mathcal{F}_1}^{i+1} = w_{\mathcal{F}_2}^{i+1}, i \in \mathbb{Z}_{[1, p-1]} \right\}. \quad (6.30)$$

Note that (6.30) reveals that $w_{\mathcal{F}_1}^1$ is an input of the manufacturing system and $[w_{\mathcal{F}_2}^1 \dots w_{\mathcal{F}_3}^p]^\top$ does not anticipate $w_{\mathcal{F}_1}^1$. Furthermore, the *memory span* of the manufacturing system is given by some $\Delta \in \mathbb{R}_{>0}$ for which holds

$$\Delta > \max_{i \in \mathbb{Z}_{[1, p]}} d_i, \quad (6.31)$$

this follows from the structure of $\mathfrak{B}_{\mathcal{F}}^p$. Hence, (6.21) in Definition 6.4.6 with the $\mathfrak{B}_{\mathcal{F}_s}$ as defined in (6.23) is a state-space description for the considered manufacturing line.

6.5 A time domain MPC setup

In this section a model predictive control (MPC) setup is formulated for the class of input/state systems defined in Section 6.4 in Definition 6.4.6. In contrast to the discrete-time MPC setup in Chapter 3 in this section a continuous-time MPC formulation is given.

Consider system (6.21). For a fixed $T_p \in \mathbb{R}_{>0}$, let

$$\mathbf{x}_{\mathcal{F}}^{T_p}(t, x_{\mathcal{F}}(t), \mathbf{u}_{\mathcal{F}}^{T_p}(t)) \triangleq x_{\mathcal{F}}(\tau), \quad \tau \in \mathbb{T}_{[t, t+T_p]}$$

and

$$\mathbf{w}_{\mathcal{F}}^{T_p}(t, x_{\mathcal{F}}(t), \mathbf{u}_{\mathcal{F}}^{T_p}(t)) \triangleq w_{\mathcal{F}}(\tau), \quad \tau \in \mathbb{T}_{[t, t+T_p]}$$

denote the state and signal trajectory, respectively, generated by system (6.21) from initial state $x_{\mathcal{F}}(t)$ at time $t \in \mathbb{T}$ and by applying the input trajectory

$$\mathbf{u}_{\mathcal{F}}^{T_p}(t) \triangleq \mathbf{u}_{\mathcal{F}}(\tau), \quad \tau \in \mathbb{T}_{[t, t+T_p]}.$$

The set of *admissible input functions* defined with respect to the state $x_{\mathcal{F}}(t)$ is then defined as

$$\mathcal{U}_{\mathcal{F}}^{T_p}(x_{\mathcal{F}}(t)) \triangleq \left\{ \mathbf{u}_{\mathcal{F}}^{T_p} : [0, T_p] \rightarrow \mathbb{U}_{\mathcal{F}} \mid \begin{bmatrix} \mathbf{u}_{\mathcal{F}}^{T_p} \\ \mathbf{w}_{\mathcal{F}}^{T_p}(\cdot, x_{\mathcal{F}}(t), \mathbf{u}_{\mathcal{F}}^{T_p}) \\ \mathbf{x}_{\mathcal{F}}^{T_p}(\cdot, x_{\mathcal{F}}(t), \mathbf{u}_{\mathcal{F}}^{T_p}) \end{bmatrix} \in \mathfrak{B}_{\mathcal{F}_s} \mid_{[0, T_p]} \right\}. \quad (6.32)$$

Let $L_{\mathcal{G}} : \mathbb{U}_{\mathcal{G}} \times \mathbb{W}_{\mathcal{G}} \rightarrow \mathbb{R}$. At time $t \in \mathbb{T}$, let $x_{\mathcal{G}}(t)$ be given. The basic continuous-time MPC scenario consists in minimizing (via optimization) at each ‘‘sampling’’ instance t a finite horizon cost function of the form

$$J_{\mathcal{G}}(x_{\mathcal{G}}(t), \mathbf{u}_{\mathcal{G}}^{T_p}(t)) \triangleq \int_t^{t+T_p} L_{\mathcal{G}}(u_{\mathcal{G}}(\tau), w_{\mathcal{G}}(\tau)) d\tau \quad (6.33)$$

with *prediction* model (6.21), over all $\mathbf{u}_{\mathcal{G}}^{T_p}(t) \in \mathcal{U}_{\mathcal{G}}^{T_p}(x_{\mathcal{G}}(t))$. An optimal, or from a practical point of view more likely a suboptimal, solution resulting from the optimization problem at time t is then denoted by $\bar{\mathbf{u}}_{\mathcal{G}}^{T_p}(t)$. In the model predictive control principle only the first part over a time duration between two sampling instances, denoted by δ , of the (sub)optimal input $\bar{\mathbf{u}}_{\mathcal{G}}^{T_p}(t)$ is injected to the system (6.21), i.e.

$$u_{\mathcal{G}}(\tau) = \bar{\mathbf{u}}_{\mathcal{G}}^{\delta}(t) \triangleq \bar{u}_{\mathcal{G}}(\tau), \quad \tau \in \mathbb{T}_{[t, t+\delta)}. \quad (6.34)$$

At the next sampling instance the optimization procedure is repeated based on the currently available knowledge of the state $x_{\mathcal{G}}(t)$. Due to this repetition procedure, which is the main feature from which MPC distinguishes itself from optimal control, one can think of the MPC controller as a feedback law of the form

$$\Sigma_{\mathcal{G}}^{\text{MPC}}(\mathbb{T}, \mathbb{U}_{\mathcal{G}}^{\delta}, \mathbb{X}_{\mathcal{G}}, \mathfrak{B}_{\mathcal{G}}^{\text{MPC}}), \quad (6.35)$$

where $\mathbb{U}_{\mathcal{G}}^{\delta} \triangleq (\mathbb{T}_{[0, \delta)} \rightarrow \mathbb{U}_{\mathcal{G}})$ and

$$\mathfrak{B}_{\mathcal{G}}^{\text{MPC}} \triangleq \left\{ \bar{\mathbf{u}}_{\mathcal{G}}^{\delta} : \mathbb{T} \rightarrow \mathbb{U}_{\mathcal{G}}^{\delta}, x_{\mathcal{G}} : \mathbb{T} \rightarrow \mathbb{X}_{\mathcal{G}} \mid \mathbf{u}_{\mathcal{G}}^{T_p}(t) \text{ satisfies } \mathcal{U}_{\mathcal{G}}^{T_p}(x_{\mathcal{G}}(t)) \text{ in (6.32)} \right. \\ \left. \text{and possibly also minimizes (6.33)} \right\}. \quad (6.36)$$

The system (6.21) in closed-loop with the MPC controller (6.35), i.e. the closed-loop system, is then given by

$$\Sigma_{\mathcal{G}}^{\text{CL}}(\mathbb{T}, \mathbb{U}_{\mathcal{G}}^{\delta} \times \mathbb{U}_{\mathcal{G}} \times \mathbb{X}_{\mathcal{G}} \times \mathbb{W}_{\mathcal{G}}, \mathfrak{B}_{\mathcal{G}}^{\text{CL}}), \quad (6.37)$$

where

$$\mathfrak{B}_{\mathcal{G}}^{\text{CL}} \triangleq \left\{ \left[\bar{\mathbf{u}}_{\mathcal{G}}^{\delta \top} \ u_{\mathcal{G}}^{\top} \ x_{\mathcal{G}}^{\top} \ w_{\mathcal{G}}^{\top} \right]^{\top} : \mathbb{T} \rightarrow \mathbb{U}_{\mathcal{G}}^{\delta} \times \mathbb{U}_{\mathcal{G}} \times \mathbb{X}_{\mathcal{G}} \times \mathbb{W}_{\mathcal{G}} \mid \left[\bar{\mathbf{u}}_{\mathcal{G}}^{\delta \top} \ x_{\mathcal{G}}^{\top} \right]^{\top} \in \mathfrak{B}_{\mathcal{G}}^{\text{MPC}} \right. \\ \left. (\sigma^{-t} u_{\mathcal{G}}) \Big|_{\mathbb{T}_{[0, \delta)}} = \bar{\mathbf{u}}_{\mathcal{G}}^{\delta}, \forall t \in \mathbb{T}, \left[u_{\mathcal{G}}^{\top} \ x_{\mathcal{G}}^{\top} \ w_{\mathcal{G}}^{\top} \right]^{\top} \in \mathfrak{B}_{\mathcal{G}^s} \right\}. \quad (6.38)$$

A tractable solution of the MPC setup for event driven manufacturing systems

As explained previously, the optimization problem involved in the MPC setup formulated in Section 6.5 is, in general, not solvable in a tractable manner. Recall that in case of discrete event manufacturing systems, as defined in Section 6.1 in Definition 6.1.1, the involved optimization problem results in an un-tractable *integer valued infinite dimensional* optimization problem.

In this section the un-tractable MPC problem formulated in Section 6.5 will be reformulated. That is, a slightly different state-space representation of the system, i.e. (6.22), will be employed. It will be shown that utilizing the result of Theorem 6.3.2 and employing the alternative state-space representation of the system, allows to solve the obtained MPC problem in a tractable way .

First the alternative state-space representation of system (6.22) will be introduced.

Corollary 6.5.1 *Let Δ be the memory span of the following system*

$$\Sigma_{\mathcal{G}}(\mathbb{T}, \mathbb{U}_{\mathcal{G}} \times \mathbb{W}_{\mathcal{G}}, \mathfrak{B}_{\mathcal{G}}), \quad (6.39)$$

with $u_{\mathcal{G}}$ the input and $w_{\mathcal{G}}$ does not anticipate $u_{\mathcal{G}}$. Furthermore, let

$$\mathbb{X}_{\mathcal{G}} \triangleq (\mathbb{T}_{[-\Delta, 0)} \rightarrow \mathbb{U}_{\mathcal{G}} \times \mathbb{W}_{\mathcal{G}}). \quad (6.40)$$

Then, system representation (6.21) in Definition 6.4.6 with $\mathfrak{B}_{\mathcal{G}_s}$ defined as

$$\mathfrak{B}_{\mathcal{G}_s} = \left\{ \begin{aligned} & \left[u_{\mathcal{G}}^{\top} \ w_{\mathcal{G}}^{\top} \right]^{\top} : \mathbb{T} \rightarrow \mathbb{U}_{\mathcal{G}} \times \mathbb{W}_{\mathcal{G}}, \quad \tilde{x}_{\mathcal{G}} : \mathbb{T} \rightarrow \mathbb{X}_{\mathcal{G}} \quad \left| \quad \left[u_{\mathcal{G}}^{\top} \ w_{\mathcal{G}}^{\top} \right]^{\top} \in \mathfrak{B}_{\mathcal{G}}, \right. \\ & \left. \tilde{x}_{\mathcal{G}} = \left(\sigma^{-t} \left[u_{\mathcal{G}}^{\top} \ w_{\mathcal{G}}^{\top} \right]^{\top} \right) \Big|_{\mathbb{T}_{[-\Delta, 0)}} \in \mathfrak{B}_{\mathcal{G}} \Big|_{\mathbb{T}_{[-\Delta, 0)}}, \quad \forall t \in \mathbb{T} \right\}, \end{aligned} \quad (6.41)$$

is an input/state representation for system (6.22).

Proof: The proof can be straightforwardly obtained following the procedure as employed in the proof of Theorem 6.4.7. ■

From now on the set of *admissible input functions* and the MPC costs are defined with respect to the augmented state $\tilde{x}_{\mathcal{G}}(t)$, i.e. $x_{\mathcal{G}}(t)$ in (6.32) and (6.33) is replaced by $\tilde{x}_{\mathcal{G}}(t)$. The MPC problem, as explained previously, can then be reformulated based on the augmented state model resulting in the following MPC algorithm.

Algorithm 6.5.2

Step 1)

Given the state $\tilde{x}_{\mathcal{G}}(t)$ at time $t \in \mathbb{T}$, find (via optimization) a control over a time horizon $\mathbb{T}_{[t, t+T_p]}$, i.e. $\mathbf{u}_{\mathcal{G}}^{T_p}(t)$, which satisfies

$$\mathbf{u}_{\mathcal{G}}^{T_p}(t) \in \mathcal{U}_{\mathcal{G}}^{T_p}(\tilde{x}_{\mathcal{G}}(t)) \quad (6.42)$$

and optionally also minimize the MPC cost $J_{\mathcal{G}}(\tilde{x}_{\mathcal{G}}(t), \mathbf{u}_{\mathcal{G}}^{T_p}(t))$.

Step 2)

Let $\bar{\mathbf{u}}_{\mathcal{G}}^{T_p}(t)$ be a feasible control over a time horizon $\mathbb{T}_{[t, t+T_p]}$ calculated at $t \in \mathbb{T}$ in Step 1. Over a time span of $\mathbb{T}_{[t, t+\delta]}$ feed to system (6.21), with $\mathfrak{B}_{\mathcal{G}_s}$ defined as in (6.23), the first piece of $\bar{\mathbf{u}}_{\mathcal{G}}^{T_p}(t)$, i.e.

$$u_{\mathcal{G}}(\tau) = \bar{\mathbf{u}}_{\mathcal{G}}^{\delta}(t) \triangleq \bar{u}_{\mathcal{G}}(\tau), \quad \tau \in \mathbb{T}_{[t, t+\delta]} \quad (6.43)$$

and go to step 1 if δ time has elapsed.

Algorithm 6.5.2 in closed-loop with the system is then represented by (6.38), in which $x_{\mathcal{G}}(t)$ in (6.38) is replaced by $\tilde{x}_{\mathcal{G}}(t)$ and $\mathbb{X}_{\mathcal{G}}$, $\mathfrak{B}_{\mathcal{G}_s}$ defined as in Corollary 6.5.1 by (6.40) and (6.41), respectively.

In the sequel it will be shown that if the result in Theorem 6.3.2 applies, then the optimization problem that has to be solved at step 1 of Algorithm 6.5.2 can be solved by a *real valued finite dimensional optimization problem*. Before this issue is treated, first some preliminary results will have to be introduced.

Corollary 6.5.3 *Consider a discrete event manufacturing system represented according to Definition 6.1.1, i.e.*

$$\Sigma_{\mathcal{G}}(\mathbb{T}, \mathbb{U}_{\mathcal{G}} \times \mathbb{W}_{\mathcal{G}}, \mathfrak{B}_{\mathcal{G}}), \quad (6.44)$$

where $\mathbb{T} = \mathbb{R}$ the time axis, $\mathbb{U}_{\mathcal{G}} = \mathbb{Z}^{n_u}$ the input space, $\mathbb{W}_{\mathcal{G}} = \mathbb{Z}^{n_w}$ the signal space and $\mathfrak{B}_{\mathcal{G}} \subseteq (\mathbb{U}_{\mathcal{G}} \times \mathbb{W}_{\mathcal{G}})^{\mathbb{T}}$ the behavior. Suppose $u_{\mathcal{G}}(t) \in \mathbb{U}_{\mathcal{G}}$ is the input and $w_{\mathcal{G}}$ does not anticipate $u_{\mathcal{G}}$. Furthermore, let

$$\Sigma_{\mathcal{H}}(\mathbb{K}, \mathbb{U}_{\mathcal{H}} \times \mathbb{W}_{\mathcal{H}}, \mathfrak{B}_{\mathcal{H}}), \quad (6.45)$$

with $\mathbb{K} = \mathbb{Z}$, $\mathbb{U}_{\mathcal{H}} = \mathbb{R}^{n_u}$, $\mathbb{W}_{\mathcal{H}} = \mathbb{R}^{n_w}$ and $\mathfrak{B}_{\mathcal{H}}$ having a special structure, i.e.

$$\mathfrak{B}_{\mathcal{H}} \triangleq \left\{ \left[\begin{array}{cc} u_{\mathcal{H}}^{\top} & w_{\mathcal{H}}^{\top} \end{array} \right]^{\top} : \mathbb{Z} \rightarrow \mathbb{R}^{n_u} \times \mathbb{R}^{n_w} \mid \gamma \left[\begin{array}{cc} u_{\mathcal{H}}^{\top} & w_{\mathcal{H}}^{\top} \end{array} \right]^{\top} \leq \left[\begin{array}{cc} u_{\mathcal{H}}^{\top} & w_{\mathcal{H}}^{\top} \end{array} \right]^{\top}, \right. \\ \left. f_1(u_{\mathcal{H}}, w_{\mathcal{H}}, \gamma w_{\mathcal{H}}, \dots, \gamma^{L-1} w_{\mathcal{H}}, \gamma^L w_{\mathcal{H}}) = \right. \\ \left. f_2(u_{\mathcal{H}}, w_{\mathcal{H}}, \gamma w_{\mathcal{H}}, \dots, \gamma^{L-1} w_{\mathcal{H}}, \gamma^L w_{\mathcal{H}}) \right\}, \quad (6.46)$$

be an event domain representation, i.e. according to Definition 6.2.1, of the considered manufacturing systems. Then, under the hypothesis in Theorem 6.3.2 we have that (6.44) and (6.45) are similar.

Proof: Taking into account Definition 6.4.4 in relation to (6.44), the statement in Corollary 6.5.3 is a direct consequence of the result in Theorem 6.3.2. ■

Lemma 6.5.4 Consider a discrete event manufacturing system represented by (6.44) and suppose the hypothesis in Corollary 6.5.3 holds. Let Δ be the memory span of (6.44) and take system representation (6.21), with $\mathfrak{B}_{\mathcal{F}_s}$ defined as in Corollary 6.5.1, i.e. (6.23), as a state-space description of system (6.44). Then, the following holds

$$\left\{ \begin{aligned} & \left[\begin{matrix} u_{\mathcal{F}}^{\top} & \tilde{x}_{\mathcal{F}}^{\top} & w_{\mathcal{F}}^{\top} \end{matrix} \right]^{\top} \in \mathfrak{B}_{\mathcal{F}_s}, \quad \left[\begin{matrix} (\pi(u_{\mathcal{F}}))^{\top} & w_{\mathcal{K}}^{\top} \end{matrix} \right]^{\top} \in \mathfrak{B}_{\mathcal{K}} \quad \text{and} \\ & w_{\mathcal{K}}(k) \Big|_{\mathbb{K}_{\left[\min_j(x_{\mathcal{F}_j}(t)(0^-)) - (L-1), \min_j(x_{\mathcal{F}_j}(t)(0^-)) \right]}} = \pi^x(x_{\mathcal{F}}(t)) \quad \text{for some } t \in \mathbb{T} \end{aligned} \right\} \Rightarrow \\ \left\{ \pi_i(w_{\mathcal{F}_i}(t')) = w_{\mathcal{K}_i}(k), \quad t' \in \mathbb{T}_{>t} \right\}, \quad (6.47)$$

where

$$\pi_i^x(x_{\mathcal{F}_i}(t)) \triangleq \inf \left\{ \tau \in \mathbb{T}_{[-\Delta, 0)} \mid x_{\mathcal{F}_i}(t)(\tau) \leq k, \right. \\ \left. k \in \mathbb{K}_{\left[\min_j(x_{\mathcal{F}_j}(t)(0^-)) - (L-1), \min_j(x_{\mathcal{F}_j}(t)(0^-)) \right]} \right\} + t, \quad (6.48)$$

with $i = \{1, 2, \dots, n_w\}$.

Proof: The statement in Lemma 6.5.4 follows from the results in Theorems 6.3.2, 6.4.7 and Corollary 6.5.3. ■

The implication in (6.47) in words: If the input trajectory $u_{\mathcal{F}}$ is known and at some time instance $t \in \mathbb{T}$ part of the state $\tilde{x}_{\mathcal{F}}(t)$ of the manufacturing, i.e. $x_{\mathcal{F}}(t)$, is given, then the future signal $w_{\mathcal{F}}(t) \ t \in \mathbb{T}_{>0}$ can be obtained taking a signal realization from the *event domain model*, i.e. $\left[(\pi(u_{\mathcal{F}}))^{\top} \ w_{\mathcal{K}}^{\top} \right]^{\top} \in \mathfrak{B}_{\mathcal{K}}$ initialized according to

$$w_{\mathcal{K}}(k) \Big|_{\mathbb{K}_{\left[\min_j(x_{\mathcal{F}_j}(t)(0^-)) - (L-1), \min_j(x_{\mathcal{F}_j}(t)(0^-)) \right]}} = \pi^x(x_{\mathcal{F}}(t)), \quad (6.49)$$

and subsequently employing the bijective map π defined in Theorem 6.9 to retrieve the future time domain signal $w_{\mathcal{F}}(t) \ t \in \mathbb{T}_{>0}$.

Remark 6.5.5 The term $\mathbb{K}_{\left[\min(x_{\mathcal{J}_j}(t)(0^-)) - (L-1), \min(x_{\mathcal{J}_j}(t)(0^-))\right]}$ in (6.49) guarantees that the event domain model is initialized with the latest L event lags at all times $t \in \mathbb{T}$, so that at all times $t \in \mathbb{T}$ the prediction of the systems future behavior is based on the most recent available knowledge present in the state of the system.

Lemma 6.5.6 Consider a discrete event manufacturing system represented by (6.44) and suppose the hypothesis in Corollary 6.5.3 holds. Let Δ be the memory span of (6.44) and take system representation (6.21), with $\mathfrak{B}_{\mathcal{F}_s}$ defined as in Corollary 6.5.1, i.e. (6.23), as a state-space description of system (6.44). Furthermore, let

$$\begin{aligned} \mathcal{U}_{\mathcal{X}}^{T_p}(\tilde{x}_{\mathcal{F}}(t), t) \triangleq & \left\{ u_{\mathcal{X}_i}(k) \Big|_{\mathbb{K}_{\left[u_{\mathcal{F}_i}(t^-)+1, k^*\right]}} \in \mathfrak{B}_{\mathcal{X}}, i = \{1, 2, \dots, n_u\}, \text{ for some } k^* \in \mathbb{K} \mid \right. \\ & w_{\mathcal{X}}(k) \Big|_{\mathbb{K}_{\left[\min(x_{\mathcal{J}_j}(t)(0^-)) - (L-1), \min(x_{\mathcal{J}_j}(t)(0^-))\right]}} = \pi^x(x_{\mathcal{F}}(t)), \\ & u_{\mathcal{X}_i}(k) \Big|_{\mathbb{K}_{\left[\min(x_{\mathcal{J}_j}(t)(0^-)) + 1, u_{\mathcal{F}_i}(t^-)\right]}} = \pi_i(u_{\mathcal{F}_i}(\tau)), \tau \in [t - \Delta, t), \\ & \left. u_{\mathcal{X}_i}(u_{\mathcal{F}_i}(t^-) + 1) \geq t, \min_j(u_{\mathcal{X}_j}(k^*)) > t + T_p, \left[u_{\mathcal{X}}^\top w_{\mathcal{X}}^\top \right]^\top \in \mathfrak{B}_{\mathcal{X}} \right\}. \end{aligned} \quad (6.50)$$

Then, the following holds

$$\mathbf{u}_{\mathcal{F}}^{T_p}(t) \in \mathcal{U}_{\mathcal{F}}^{T_p}(\tilde{x}_{\mathcal{F}}(t)) \Leftrightarrow \boldsymbol{\pi}^u(\mathbf{u}_{\mathcal{F}}^{T_p}(t)) \triangleq \mathbf{u}_{\mathcal{X}}^{T_p}(t) \in \mathcal{U}_{\mathcal{X}}^{T_p}(\tilde{x}_{\mathcal{F}}(t), t), \quad (6.51)$$

where

$$\boldsymbol{\pi}_i^u(\mathbf{u}_{\mathcal{F}_i}^{T_p}(t)) \triangleq \inf \left\{ \tau \in \mathbb{T}_{[0, T_p]} \mid \mathbf{u}_{\mathcal{F}_i}^{T_p}(t)(\tau) \leq k, k \in \mathbb{K}_{\left[u_{\mathcal{F}_i}^{T_p}(t)(0), k^*\right]} \right\} + t, i = \{1, 2, \dots, n_u\}. \quad (6.52)$$

Proof: Follows from Lemma 6.5.4. ■

The set $\mathcal{U}_{\mathcal{X}}^{T_p}(\tilde{x}_{\mathcal{F}}(t), t)$ in (6.50) denotes the class of *admissible input sequences* in event domain defined with respect to the augmented state $\tilde{x}_{\mathcal{F}}(t)$ and time t . The main result of the section can now be formulated.

Theorem 6.5.7 Consider a discrete event manufacturing system represented by (6.44) and suppose the hypothesis in Corollary 6.5.3 holds. Let Δ be the memory span of (6.44) and take system representation (6.21), with $\mathfrak{B}_{\mathcal{F}_s}$ defined as in Corollary 6.5.1,

i.e. (6.23), as a state-space description of system (6.44). Furthermore, let $J_{\mathcal{X}}(\tilde{x}_{\mathcal{F}}(t), \mathbf{u}_{\mathcal{X}}^{T_p}(t))$ be event domain costs such that

$$J_{\mathcal{X}}(\tilde{x}_{\mathcal{F}}(t), \mathbf{u}_{\mathcal{X}}^{T_p}(t)) = J_{\mathcal{F}}(\tilde{x}_{\mathcal{F}}(t), \mathbf{u}_{\mathcal{F}}^{T_p}(t)), \quad \forall \mathbf{u}_{\mathcal{X}}^{T_p}(t) = \pi^u(\mathbf{u}_{\mathcal{F}}^{T_p}(t)) \in \mathcal{U}_{\mathcal{X}}^{T_p}(\tilde{x}_{\mathcal{F}}(t), t). \quad (6.53)$$

Then, the following statements hold.

i) Step 1 in Algorithm 6.5.2 is solved by replacing Step 1 in Algorithm 6.5.2 by the following Steps.

Step 1a)

Given the state $\tilde{x}_{\mathcal{F}}(t)$ at time $t \in \mathbb{T}$, find via optimization an event domain control, i.e. $\mathbf{u}_{\mathcal{X}}^{T_p}$, which satisfies

$$\mathbf{u}_{\mathcal{X}}^{T_p}(t) \in \mathcal{U}_{\mathcal{X}}^{T_p}(\tilde{x}_{\mathcal{F}}(t), t) \quad (6.54)$$

and optionally also minimizes the event domain costs $J_{\mathcal{X}}(\tilde{x}_{\mathcal{F}}(t), \mathbf{u}_{\mathcal{X}}^{T_p}(t))$.

Step 1b)

Let $\bar{\mathbf{u}}_{\mathcal{X}}^{T_p}(t)$ be a feasible event domain control, then a feasible control over a time horizon $\mathbb{T}_{[t, t+T_p]}$, i.e. $\bar{\mathbf{u}}_{\mathcal{F}}^{T_p}(t)$, is given by

$$\bar{\mathbf{u}}_{\mathcal{F}}^{T_p}(t) \triangleq \pi^{u^{-1}}(\bar{\mathbf{u}}_{\mathcal{X}}^{T_p}(t)), \quad (6.55)$$

where $\pi^{u^{-1}}$ represents the dual relation of (6.52) defined as

$$\pi_i^{u^{-1}}(\bar{\mathbf{u}}_{\mathcal{X}_i}^{T_p}(t)) \triangleq \sup \left\{ k \in \mathbb{K} \mid \bar{\mathbf{u}}_{\mathcal{X}_i}^{T_p}(t)(k) \leq \tau, \quad \tau \in [t, t+T_p] \right\}, \quad (6.56)$$

with $i = \{1, 2, \dots, n_u\}$.

ii) The optimization problem involved in Step 1a is a real valued finite dimensional optimization problem.

Proof:

i) Follows from implications in (6.51) of Lemma 6.5.6.

ii) Real valued-ness follows due to the fact that the admissible inputs in the event domain are maps from $\mathbb{K} = \mathbb{Z}$ to $\mathbb{T} = \mathbb{R}$. Finite dimensional, i.e. finite amount of design variables in $\mathbf{u}_{\mathcal{X}}^{T_p}(t)$, follows due to the fact that the class of manufacturing systems considered do not possess *Zeno* executions, see Definition 6.1.2. So that k^* in (6.50) is finite. ■

Example 6.5.8 Consider a manufacturing line defined in Example 6.4.8 for $p = 2$, i.e. two manufacturing systems depicted in Figure 6.2 in series. Each buffer B_1 and B_2 has a finite capacity of two products, i.e. $N_1 = N_2 = 2$. Furthermore, each processing unit (or machine) M_1 and M_2 has a fixed processing time of $d_1 = 3$ and $d_2 = 4$ time units, respectively. The manufacturing system in the time domain is defined in Defini-

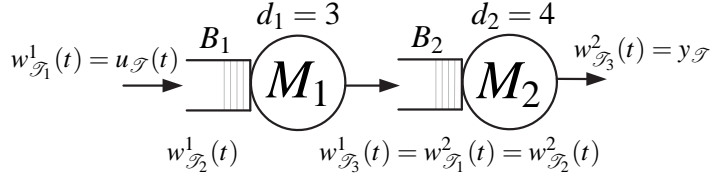

Figure 6.3: Manufacturing line.

tion 6.1.1 with the behavior of the manufacturing system following from the behavior of a manufacturing line given, in its general form, in Example 6.4.8 in (6.30). For the considered manufacturing line in this example, the behavior in (6.30) (with $p = 2$) reads

$$\mathfrak{B}_{\mathcal{F}}^2 = \left\{ w_{\mathcal{F}} \triangleq \begin{bmatrix} u_{\mathcal{F}} \\ w^1_{\mathcal{F}_2} \\ w^1_{\mathcal{F}_3} \\ w^2_{\mathcal{F}_1} \\ w^2_{\mathcal{F}_2} \\ y_{\mathcal{F}} \triangleq w^2_{\mathcal{F}_3} \end{bmatrix} : \mathbb{R} \rightarrow \mathbb{Z}^6 \left. \begin{array}{l} w^1_{\mathcal{F}_2} = \min(u_{\mathcal{F}}, w^1_{\mathcal{F}_3} + N_1 + 1) \\ w^2_{\mathcal{F}_2} = \min(\sigma^{d_1} w^1_{\mathcal{F}_2}, \sigma^{d_1} w^2_{\mathcal{F}_2} + 1, \\ \quad \quad \quad w^2_{\mathcal{F}_3} + N_2 + 1) \\ w^2_{\mathcal{F}_3} = \min(\sigma^{d_2} w^2_{\mathcal{F}_2}, \sigma^{d_2} w^2_{\mathcal{F}_3} + 1) \\ w^1_{\mathcal{F}_3} = w^2_{\mathcal{F}_1} = w^2_{\mathcal{F}_2}, \sigma^{\tau} w_{\mathcal{F}} \geq w_{\mathcal{F}}, \tau \in \mathbb{T}_{>0} \end{array} \right\}. \quad (6.57)$$

Problem 6.5.9 Given is a certain predetermined customer demand $r_{\mathcal{F}}(t)$ over a certain time horizon $t \in \mathbb{T}_{[t, t+T_p]}$. Furthermore, based on the customer demand a product release schedule $u^r_{\mathcal{F}}(t)$ over a time horizon $t \in \mathbb{T}_{[t, t+T_p]}$ is determined by the manufacturer in negotiation with its suppliers. It is assumed that both $r_{\mathcal{F}}(t)$ and $u^r_{\mathcal{F}}(t)$ belong to the system's behavior defined in (6.57). The goal is to bring the manufacturing system from any initial configuration, hidden in $\tilde{x}_{\mathcal{F}}(t)$, to the predetermined reference trajectories, i.e.

$$y_{\mathcal{F}}(t) \rightarrow r_{\mathcal{F}}(t) \quad \text{and} \quad u_{\mathcal{F}}(t) \rightarrow u^r_{\mathcal{F}}(t). \quad (6.58)$$

The MPC setup, i.e. Algorithm 6.5.2, is employed to solve problem 6.5.9. The aim is to minimize the following MPC costs in order to enforce property (6.58) for the closed-loop system, i.e. (6.38), in which $x_{\mathcal{F}}(t)$ in (6.38) is replaced by $\tilde{x}_{\mathcal{F}}(t)$ and

$\mathbb{X}_{\mathcal{F}}$, $\mathfrak{B}_{\mathcal{F}_s}$ defined as in Corollary 6.5.1 by (6.40) and (6.41), respectively.

$$J_{\mathcal{F}}(\tilde{x}_{\mathcal{F}}(t), \mathbf{u}_{\mathcal{F}}^{T_p}(t)) = \int_t^{t+T_p} \left\{ |y_{\mathcal{F}}(\tau) - r_{\mathcal{F}}(\tau)|_{\infty} + \lambda |u_{\mathcal{F}}(\tau) - u'_{\mathcal{F}}(\tau)|_{\infty} \right\} d\tau. \quad (6.59)$$

Note that the *memory span* of the system is given by some $\Delta \in \mathbb{R}_{>0}$ such that (6.31) holds, i.e.

$$\Delta > d_2 = 4.$$

A description of the manufacturing system according to Definition 6.2.1, i.e. a manufacturing system in *event domain*, is defined by the following behavior

$$\mathfrak{B}_{\mathcal{H}} \triangleq \left\{ w_{\mathcal{H}} \triangleq \begin{bmatrix} u_{\mathcal{H}} \\ w_{\mathcal{H}_2}^1 \\ w_{\mathcal{H}_3}^1 \\ w_{\mathcal{H}_1}^2 \\ w_{\mathcal{H}_2}^2 \\ y_{\mathcal{H}} \triangleq w_{\mathcal{H}_3}^2 \end{bmatrix} : \mathbb{Z} \rightarrow \mathbb{R}^6 \left. \begin{array}{l} w_{\mathcal{H}_2}^1 = \max(u_{\mathcal{H}}, \gamma^{N_1+1} w_{\mathcal{H}_3}^1) \\ w_{\mathcal{H}_2}^2 = \max(w_{\mathcal{H}_2}^1 + d_1, \gamma^{N_2+1} w_{\mathcal{H}_3}^2) \\ w_{\mathcal{H}_3}^2 = \max(w_{\mathcal{H}_2}^2 + d_2, \gamma w_{\mathcal{H}_3}^2 + d_2) \\ w_{\mathcal{H}_3}^1 = w_{\mathcal{H}_1}^2 = w_{\mathcal{H}_2}^2, \quad \gamma w_{\mathcal{H}} \leq w_{\mathcal{H}} \end{array} \right\}, \quad (6.60)$$

with *event lag* $L = N_2 + 1 = N_1 + 1 = 3$.

Suppose the hypothesis in Corollary 6.5.3 holds, then the *event domain cost* satisfying relation (6.53) for $J_{\mathcal{F}}$ defined in (6.59) is given by

$$J_{\mathcal{H}}(\tilde{x}_{\mathcal{F}}(t), \mathbf{u}_{\mathcal{H}}^{T_p}(t)) = \begin{cases} C_1 + \lambda C_3 & \text{if } \min_j (x_{\mathcal{F}_j}(t)(0^-)) < r_{\mathcal{F}}(t) \ \& \ u_{\mathcal{F}}(t^-) < u'_{\mathcal{F}}(t), \\ C_1 + \lambda C_4 & \text{if } \min_j (x_{\mathcal{F}_j}(t)(0^-)) < r_{\mathcal{F}}(t) \ \& \ u_{\mathcal{F}}(t^-) \geq u'_{\mathcal{F}}(t), \\ C_2 + \lambda C_3 & \text{if } \min_j (x_{\mathcal{F}_j}(t)(0^-)) \geq r_{\mathcal{F}}(t) \ \& \ u_{\mathcal{F}}(t^-) < u'_{\mathcal{F}}(t), \\ C_2 + \lambda C_4 & \text{if } \min_j (x_{\mathcal{F}_j}(t)(0^-)) \geq r_{\mathcal{F}}(t) \ \& \ u_{\mathcal{F}}(t^-) \geq u'_{\mathcal{F}}(t), \end{cases} \quad (6.61)$$

where

$$\begin{aligned} C_1 &= \sum_{k=k_{c_y}+1}^{k_{c_r}} \max(y_{\mathcal{H}}(k) - t, 0) + \\ &\quad \sum_{k=k_{c_r}+1}^{k_{p_r}} \max\left(\left(y_{\mathcal{H}}(k) - r_{\mathcal{H}}(k) - \max(y_{\mathcal{H}}(k) - (t + T_p), 0)\right), r_{\mathcal{H}}(k) - y_{\mathcal{H}}(k)\right) + \\ &\quad \sum_{k=k_{p_r}+1}^{k^*} \max(t + T_p - y_{\mathcal{H}}(k), 0), \\ C_2 &= \sum_{k=k_{c_y}+1}^{k_{p_r}} \max(y_{\mathcal{H}}(k) - r_{\mathcal{H}}(k), r_{\mathcal{H}}(k) - y_{\mathcal{H}}(k)) + \sum_{k=k_{p_r}+1}^{k^*} \max(t + T_p - y_{\mathcal{H}}(k), 0), \end{aligned}$$

$$\begin{aligned}
 C_3 &= \sum_{k=k_{c_u}+1}^{k_{c_{u^r}}} \max(u_{\mathcal{X}}(k) - t, 0) + \\
 &\quad \sum_{k=k_{c_{u^r}}+1}^{k_{p_{u^r}}} \max\left((u_{\mathcal{X}}(k) - u_{\mathcal{X}}^r(k) - \max(u_{\mathcal{X}}(k) - (t + T_p), 0)), u_{\mathcal{X}}^r(k) - u_{\mathcal{X}}(k)\right) + \\
 &\quad \sum_{k=k_{p_{u^r}}+1}^{k^*} \max(t + T_p - u_{\mathcal{X}}(k), 0), \\
 C_4 &= \sum_{k=k_{c_u}+1}^{k_{p_{u^r}}} \max(u_{\mathcal{X}}(k) - u_{\mathcal{X}}^r(k), u_{\mathcal{X}}^r(k) - u_{\mathcal{X}}(k)) + \sum_{k=k_{p_{u^r}}+1}^{k^*} \max(t + T_p - u_{\mathcal{X}}(k), 0),
 \end{aligned}$$

with $k_{c_y} \triangleq \min_j(x_{\mathcal{J}_j}(t)(0^-))$, $k_{c_u} \triangleq u_{\mathcal{J}}(t^-)$, $k_{c_{u^r}} \triangleq u_{\mathcal{J}}^r(t)$, $k_{c_r} \triangleq r_{\mathcal{J}}(t)$ and $k^* > k_{p_{u^r}}$. In Figure 6.4 a qualitative graphical illustration of the MPC costs, i.e. $J_{\mathcal{J}}$, $J_{\mathcal{X}}$, is given.

One can now apply Theorem 6.5.7 to solve Step 1 of Algorithm 6.5.2 in a tractable way. A response of the manufacturing system in closed-loop with Algorithm 6.5.2 for $\delta = 1$, $T_p = 50$ time units and $\lambda = 1$ is shown in Figure 6.5. After a disturbance, e.g.

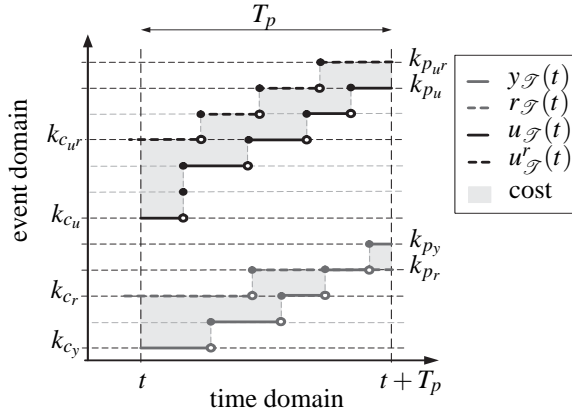

Figure 6.4: Qualitative representation of the costs in (6.59).

a machine failure or breakdown the manufacturing line runs behind schedule, i.e. the predetermined customer demand $r_{\mathcal{J}}(t)$ and product release schedule $u_{\mathcal{J}}^r(t)$ is not met. At time $t = 57$, for some initial configuration of the manufacturing system (i.e. the configuration of the manufacturing system just after the machine breakdown which is “hidden” in $\tilde{x}_{\mathcal{J}}(t)$ and is used for feedback to Algorithm 6.5.2), a recovery to the predetermined customer demand $r_{\mathcal{J}}(t)$ and product release schedule $u_{\mathcal{J}}^r(t)$ is obtained in an optimal sense due to the feedback mechanism of the applied MPC setup.

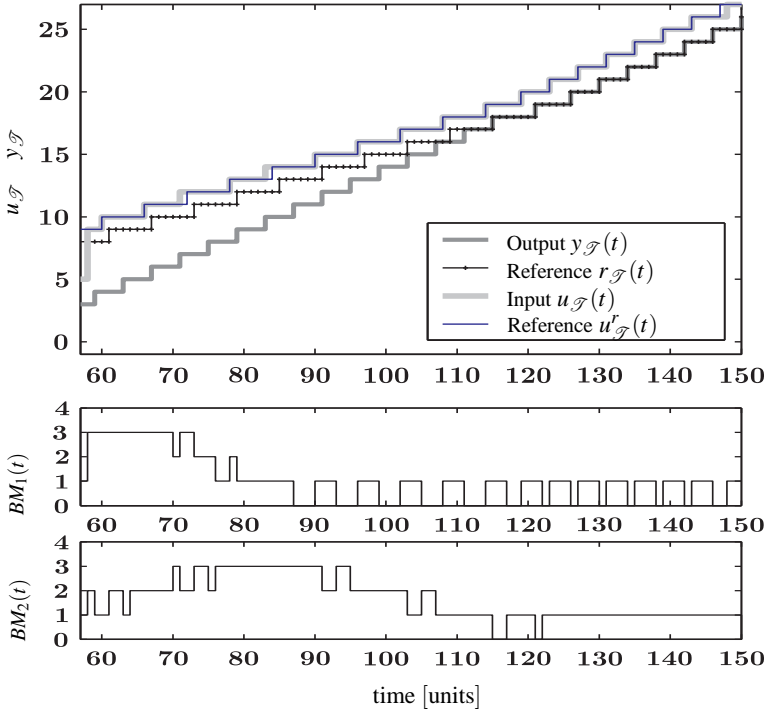

Figure 6.5: Above: The response of the signals $y_{\mathcal{F}}(t)$ and $u_{\mathcal{F}}(t)$ compared to $r_{\mathcal{F}}(t)$ and $u_{\mathcal{F}}^r(t)$ respectively. Below: Amount of products present in B_1, M_1 , i.e. $BM_1(t) \triangleq (w_{\mathcal{F}_2}^1(t) - w_{\mathcal{F}_2}^2(t))$ and B_2, M_2 i.e. $BM_2(t) \triangleq (w_{\mathcal{F}_3}^2(t) - w_{\mathcal{F}_3}^3(t))$ as function of time t , respectively.

The example as just illustrated shows how the model predictive control principle can be employed to control a class of discrete event manufacturing systems in a tractable way. For a subclass of the considered manufacturing systems and a class of cost functions, one can even reduce the computational complexity by employ the results and techniques pointed out in [107]. In contrast to the fluid model approach, followed in Chapters 3 and 4, the controller synthesis can be directly based on the discrete event model of the manufacturing system. This has a view advantages, i.e.

- One does not have to obtain a *fluid model* of the discrete event manufacturing system. This is beneficial, since in general it is hard to obtain a fluid model of a manufacturing system that exhibits all characteristics of the behavior of the manufacturing system over a broad operating range.
- In the controller synthesis one does not have to take into account fictive external

disturbances which are induced by the fact that the discrete event behavior of the manufacturing system is approximated by a fluid model approach, i.e. see Chapter 4.

- The delay in the system, which is a consequence of processing times of the processing units present in the manufacturing system, i.e. M_1 and M_2 in case of Example 6.5.8, is hard to take into account if the controller design is based on a *fluid model* of the manufacturing system⁴. However, in case of the approach followed in this chapter the delay can be easily dealt with.

A major open issue is how to formally define stability and subsequential to proof and derive conditions for stability of the discrete event manufacturing system in closed-loop with the model predictive control setup as sketched in this chapter.

6.6 Summary

In this chapter a time domain modeling framework for discrete-event manufacturing systems is given. It has been shown that the discrete-event property of manufacturing systems opens the opportunity to model manufacturing systems from another domain, namely, the *event domain*. It is shown that in contrast to relatively complex time domain models, that are obtained when modeling manufacturing systems, event domain modeling facilitates obtaining relatively simple (analytical) difference equations as descriptions of discrete-event manufacturing systems. The relation between event domain modeling of a class of event driven manufacturing systems and the time domain has been obtained. This opens possibilities to employ the relatively simple event domain models to do controller computations for manufacturing systems controlled in time domain. This has been illustrated on a typical continuous time manufacturing model predictive control problem. In manufacturing system control typically time domain performance requirements have to be met. This leads to time domain model predictive control objectives and therefore to a continuous time model predictive control formulation. Solving a continuous time model predictive control formulation leads to an untractable infinite dimensional optimization problem in general (see e.g. Section 1.3). In case of a class of discrete-event manufacturing systems it has been shown, by utilizing the relation between event- and time domain, that the continuous time model predictive control problem can be solved (without approximations) by a finite dimensional optimization problem.

⁴Note that in case of the fluid model employed in Chapter 4 the processing delay is not well taken into account, i.e. for an initially empty manufacturing system products instantaneously exit the manufacturing system if there is a non-zero arrival rate of products at the beginning of the manufacturing line.

The picture so far is pretty bleak. A starting academic scientist earns less than an airplane mechanic, has less job security than a drummer in a boy band, and works longer hours than a Bolivian silver miner.

Philip Greenspun

7

An event domain controller design approach for manufacturing systems

The final example in the previous chapter is concluded with the remark that a major open issue is how to formally define stability in the time domain modeling framework as introduced in Section 6.1 and subsequential how to prove and derive conditions for stability of the discrete-event manufacturing system in closed-loop with the time domain model predictive control setup as pointed out in Section 6.5. In this chapter it is explained how the stability issue can be treated for a particular class of manufacturing systems. The stability definition and analysis is performed from the event domain (see Section 6.2) perspective. The approach leads to event domain controllers that are stabilizing in the event domain. A disadvantage however is that the obtained controllers cannot straightforwardly be employed in the time domain due to a causality problem that emerges if the controllers are implemented in the time domain. It is pointed out how this causality problem can be taken care of by using an observer.

The chapter is organized as follows. In Section 7.1 an event domain stability definition is given. Furthermore, it is pointed out how to design an event domain controller which renders the event domain closed-loop system stable according to the given definition, irrespective of the possible presence of measurement errors present in the event times that are employed for feedback to the event domain controller. In Section 7.2 it is pointed out that a stabilizing event domain controller cannot be straightforwardly be employed in the time domain due to a causality problem. In Section 7.3 an observer design technique is proposed which can be employed to solve the causality problem as is encountered in Section 7.2.

7.1 Design of robustly stabilizing event domain controller

Consider a discrete event system described in the event domain as follows.

$$\Sigma_{\mathcal{H}}(\mathbb{K}, \mathbb{U}_{\mathcal{H}} \times \mathbb{W}_{\mathcal{H}}, \mathfrak{B}_{\mathcal{H}}), \quad (7.1)$$

with $\mathbb{K} = \mathbb{Z}_+$, $\mathbb{U}_{\mathcal{H}} = \mathbb{R}^{n_u}$, $\mathbb{W}_{\mathcal{H}} = \mathbb{R}^{n_w}$ and $\mathfrak{B}_{\mathcal{H}}$ defined as

$$\mathfrak{B}_{\mathcal{H}} \triangleq \left\{ \left[u_{\mathcal{H}}^\top \ w_{\mathcal{H}}^\top \right]^\top : \mathbb{Z}_+ \rightarrow \mathbb{U}_{\mathcal{H}} \times \mathbb{W}_{\mathcal{H}} \mid \gamma \left[u_{\mathcal{H}}^\top \ w_{\mathcal{H}}^\top \right]^\top \leq \left[u_{\mathcal{H}}^\top \ w_{\mathcal{H}}^\top \right]^\top, \right. \\ \left. w_{\mathcal{H}} = A\gamma \otimes w_{\mathcal{H}} \oplus B\gamma \otimes u_{\mathcal{H}} \right\}, \quad (7.2)$$

where matrices $A \in \mathbb{R}_{\varepsilon}^{n_w \times n_w}$ and $B \in \mathbb{R}_{\varepsilon}^{n_w \times n_u}$. Note that all the trajectory $w_{\mathcal{H}}$, that satisfy $\mathfrak{B}_{\mathcal{H}}$ defined in (7.2), admit the following difference equation

$$w_{\mathcal{H}}(k+1) = A \otimes w_{\mathcal{H}}(k) \oplus B \otimes u_{\mathcal{H}}(k), \quad w_{\mathcal{H}}(0) = w_{\mathcal{H}_0}, \quad k \in \mathbb{Z}_+, \quad (7.3)$$

for some initial condition $w_{\mathcal{H}_0} \in \mathbb{W}_{\mathcal{H}}$ with constraint $u_{\mathcal{H}}(k-1) \leq u_{\mathcal{H}}(k)$. Let λ^* be the largest *max-plus eigenvalue* of A in (7.2), see Definition 2.1.3. In classical linear system theory, the asymptotic or limit behavior of the solution of an autonomous linear system, i.e. $q(k+1) = A_q q(k)$, is characterized by the eigenvalues of the matrix A_q , see [108] for more details on this issue. A similar interpretation can be given to the largest max-plus eigenvalue of A in (7.3) for the case that (7.3) is autonomous. Assume that the matrix A is row finite and has the largest eigenvalue $\lambda^* > \varepsilon$ and the corresponding max-plus eigenvector $\eta \in \mathbb{R}^{n_w}$ (i.e. η is finite). Note that for the *specific* initial condition $w_{\mathcal{H}_0} = \eta$, one obtains the following solution to the autonomous version of difference equation (7.3)

$$w_{\mathcal{H}}(k) = \lambda^{*\otimes k} \otimes \eta = k\lambda^* + w_{\mathcal{H}_0}, \quad \forall k \in \mathbb{Z}_+.$$

Hence,

$$\lim_{k \rightarrow \infty} \frac{w_{\mathcal{H}_i}(k)}{k} = \lambda^* \quad \forall i \in \mathbb{Z}_{[1, n_w]}, \quad k \in \mathbb{Z}_{>0}. \quad (7.4)$$

Employing Lemma 2.1.4, one can prove (see [31] for a worked-out proof) that for *each* initial condition $w_{\mathcal{H}_0}$ (7.4) holds. Since in the non-autonomous system as described by (7.3) event occurrences in the system can only be *delayed*, due to the term $B \otimes u_{\mathcal{H}}(k)$, one can conclude that the maximum mean event occurrence rate, which in a discrete event manufacturing system context corresponds to the maximum mean throughput [products/time unit] in the system, is characterized by the reciprocal of the maximum max-plus eigenvalue λ^* of the matrix A in (7.2). When the eigenvector of A , i.e.

η , is not finite, it can be shown that only *some* components of the vector $w_{\mathcal{X}}(k)/k$, corresponding to the solution of the autonomous version of (7.3), converge towards λ^* . This is stated in Theorem 3.17 in [31]. Practically this indicates that if no control is applied to system (7.3) (i.e. no event times in $w_{\mathcal{X}}(k)$ are delayed via the term $B \otimes u_{\mathcal{X}}(k)$), it might happen that the difference between different event times might grow unbounded. In a manufacturing context this could mean that for example the number of products in a buffers grows unbounded. This is a typical example of undesirable (unstable) system behavior which one wants to avoid by appropriate controller design.

Example 7.1.1 Consider a simple example of a timed manufacturing system as depicted in Figure 7.1. The system consists of processing units M_1 , M_2 and M_3 and FIFO buffers B_1 , B_2 , B_3 and B_4 , respectively. All the buffers have a capacity to store an infinite amount of products. The processing units or machines M_1 and M_2 , with processing times d_1 [time units] and d_2 [time units], respectively, will start processing a product if, a possibly present, preceding product on the machines is finished and there is at least one product present in the buffers in front of the machines. Products that are finished being processed on machine M_1 and M_2 will be transported, with a transportation delay of D_1 and D_2 [time units], to buffer B_3 and B_4 , respectively. Machine M_3 is an assembling machine on which products from buffer B_3 and B_4 are assembled into one product. The machine M_3 , with assembling time d_3 [time units], will start assembling two products if, a possibly present, preceding to-be-assembled product on machine M_3 is finished and if there is at least one product present in both buffers B_3 and B_4 , respectively. The manufacturing system as depicted in Figure 7.1 can be described by an event domain description as in (7.1). Hence, the matrices $A \in \mathbb{R}_{\varepsilon}^{3 \times 3}$ and $B \in \mathbb{R}_{\varepsilon}^{3 \times 2}$ defining (7.1) then read

$$A \triangleq \begin{bmatrix} d_1 & \varepsilon & \varepsilon \\ \varepsilon & d_2 & \varepsilon \\ D_1 \otimes d_1 \otimes d_1 & D_2 \otimes d_2 \otimes d_2 & d_3 \end{bmatrix}, \quad B \triangleq \begin{bmatrix} D_1 \oplus d_1 & \varepsilon \\ \varepsilon & D_2 \oplus d_2 \\ \varepsilon & \varepsilon \end{bmatrix}, \quad w_{\mathcal{X}} \triangleq \begin{bmatrix} w_{\mathcal{X}_1} \\ w_{\mathcal{X}_2} \\ w_{\mathcal{X}_3} \end{bmatrix}, \quad (7.5)$$

$u_{\mathcal{X}}(k) \triangleq [u_{\mathcal{X}_1}(k) \ u_{\mathcal{X}_2}(k)]^T$ with $w_{\mathcal{X}_1}(k)$, $w_{\mathcal{X}_2}(k)$ and $w_{\mathcal{X}_3}(k)$ representing event times of the events “a products enters machine” M_1 , M_2 and M_3 for the $k - 1$ -th time, respectively. Furthermore, $u_{\mathcal{X}_1}(k)$ and $u_{\mathcal{X}_2}(k)$ represent the event times of the events “a product is released” into buffer B_1 and B_2 for the k -th time, respectively. For parameters $d_1 = d_2 = 2$, $D_1 = D_2 = 0$ and $d_3 = 1$, one can find that $\lambda^* = 2$ and $\eta = [3 \ 3 \ 5]^T$ is the maximum max-plus algebraic eigenvalue and a finite eigenvector of matrix A in (7.2), respectively¹. Hence, if no control is applied to the manufacturing system, (7.4) holds for all initial conditions $w_{\mathcal{X}_0} \in \mathbb{R}^3$. That is, no products will accumulate in buffers B_3 and B_4 (for any input $u_{\mathcal{X}}$).

¹See, for example [31], for an overview of algorithms on how to compute λ^* and η of matrix A .

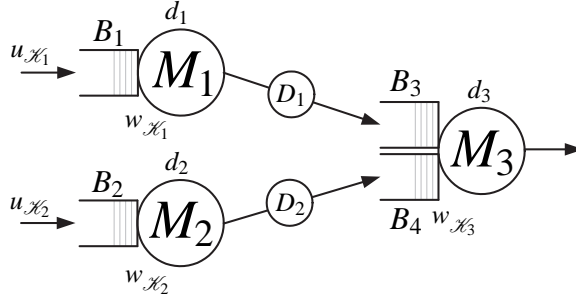

Figure 7.1: Example of an assembly manufacturing line.

Consider now the system parameters $d_1 = 2$, $d_2 = 4$, $D_1 = 0$, $D_2 = 2$, and $d_3 = 3$. By employing Theorem 3.17 in [31], one can conclude that

$$\lim_{k \rightarrow \infty} \frac{w_{\mathcal{H}_1}(k)}{k} = 2, \quad \lim_{k \rightarrow \infty} \frac{w_{\mathcal{H}_2}(k)}{k} = 4, \quad \text{and} \quad \lim_{k \rightarrow \infty} \frac{w_{\mathcal{H}_3}(k)}{k} = 3. \quad (7.6)$$

Hence, products will accumulate in buffer B_3 , since

$$\lim_{k \rightarrow \infty} \frac{w_{\mathcal{H}_1}(k)}{k} \leq \lim_{k \rightarrow \infty} \frac{w_{\mathcal{H}_3}(k)}{k}.$$

In the sequel it will be explained how to design an event domain controller such that the system (7.1) in closed-loop with an event domain controller will be stable, i.e.

Definition 7.1.2 The recursion in (7.3), in closed-loop with an event domain controller with the property

$$u_{\mathcal{H}}(k-1) \leq u_{\mathcal{H}}(k), \quad \forall k \in \mathbb{Z}_+, \quad (7.7)$$

is called **stable** if for all $w_{\mathcal{H}_0} \in \mathbb{R}^{n_w}$ there exists a constant $\rho \in \mathbb{R}_{>\lambda^*}$ such that

$$\lim_{k \rightarrow \infty} \frac{w_{\mathcal{H}_i}(k)}{k} = \rho, \quad \forall i \in \mathbb{Z}_{[1, n_w]}, \quad k \in \mathbb{Z}_{>0}. \quad (7.8)$$

Remark 7.1.3 Due to the fact that the manufacturing system in (7.2) has a capacity constraint characterized by the maximum eigenvalue λ^* of A , it does, from a practical point of view, not make sense to design a controller that assigns for a $\rho \in \mathbb{R}_{\leq \lambda^*}$. Therefore, only $\rho \in \mathbb{R}_{>\lambda^*}$ is considered in (7.8).

To guarantee that the to-be-designed event domain controller has the property as indicated in (7.7), the controller design will be based on the following recursion

$$\tilde{w}_{\mathcal{H}}(k+1) = \tilde{A} \otimes \tilde{w}_{\mathcal{H}}(k) \oplus \tilde{B} \otimes \tilde{u}_{\mathcal{H}}(k), \quad (7.9)$$

where

$$\tilde{A} \triangleq \begin{bmatrix} A & B \\ \mathcal{E} & E \end{bmatrix}, \quad \tilde{B} \triangleq \begin{bmatrix} B \\ E \end{bmatrix}, \quad \tilde{w}_{\mathcal{X}}(k) \triangleq \begin{bmatrix} w_{\mathcal{X}}(k) \\ z_{\mathcal{X}}(k) \end{bmatrix}, \quad z_{\mathcal{X}}(k) \in \mathbb{R}^{n_u}$$

A justification for this design approach follows due to the following result

Lemma 7.1.4 *Let initial conditions $w_{\mathcal{X}}(0)$ and $u_{\mathcal{X}}(-1)$ for the recursion (7.3) and an initial condition $\tilde{w}_{\mathcal{X}}(0) \triangleq [w_{\mathcal{X}}(0)^\top \ u_{\mathcal{X}}(-1)^\top]^\top$ for the recursion (7.9) be given. Apply the input sequence $\tilde{u}_{\mathcal{X}}$ and the corresponding input sequence*

$$u_{\mathcal{X}}(k) \triangleq u_{\mathcal{X}}(k-1) \oplus \tilde{u}_{\mathcal{X}}(k), \quad (7.10)$$

to recursion (7.9) and (7.3), respectively. Then, the first n_w components of the sequence $\tilde{w}_{\mathcal{X}}$ resulting from recursion (7.9) coincide with the sequence $w_{\mathcal{X}}$ resulting from recursion (7.3). Furthermore the last n_u components of $\tilde{w}_{\mathcal{X}}$ coincide with $u_{\mathcal{X}}(k-1)$ for all $k \in \mathbb{Z}_+$ which implies that constrained (7.7) is satisfied for all $k \in \mathbb{Z}_+$.

Proof: The statement can be proven by induction. For $k = 0$ the statement is obvious. Suppose that the statement is true for some $k \in \mathbb{Z}_+$, i.e.

$$z_{\mathcal{X}}(k) = u_{\mathcal{X}}(k-1), \quad (7.11a)$$

$$\tilde{w}_{\mathcal{X}_i}(k) = w_{\mathcal{X}_i}(k), \quad i = 1, \dots, n_w. \quad (7.11b)$$

In the sequel it will be proven that similar equalities, as presented above, also hold for $k+1$. Note that by definition $z_{\mathcal{X}}(k+1) \triangleq z_{\mathcal{X}}(k) \oplus \tilde{u}_{\mathcal{X}}(k)$, follows from recursion (7.9). Then by (7.11a) and (7.10), it follows that

$$z_{\mathcal{X}}(k+1) = u_{\mathcal{X}}(k).$$

Define $q(k) \in \mathbb{R}^{n_w}$ for some $k \in \mathbb{Z}_+$ and let $q_i(k) = \tilde{w}_{\mathcal{X}_i}(k)$ for $i = 1 \dots n_w$. Then, by applying recursion (7.9), relation (7.11a) and (7.11b) one obtains that

$$A \otimes q(k) \oplus B \otimes \underbrace{(u_{\mathcal{X}}(k-1) \oplus \tilde{u}_{\mathcal{X}}(k))}_{u_{\mathcal{X}}(k)} \triangleq q(k+1).$$

■

In the sequel it is explained how the stability notions in Chapter 2 can be utilized to design a controller of the form

$$\tilde{u}_{\mathcal{X}}(k) = \tilde{\kappa}(\tilde{w}_{\mathcal{X}}(k) + \tilde{e}_{\mathcal{X}}(k)), \quad k \in \mathbb{Z}_+, \quad (7.12)$$

which will guarantee that (7.3) ((7.2)) in closed-loop with the event domain controller defined by (7.10) and (7.12) is stable in the sense of Definition 7.1.2. Note that $\tilde{e}_{\mathcal{X}}(k) \in \tilde{\mathbb{E}} \subseteq \mathbb{R}^{n_w+n_u}$ represents event domain measurement noise, i.e. the event times in $\tilde{w}_{\mathcal{X}}(k)$ are assumed not to be known accurately. There is a certain error $\tilde{e}_{\mathcal{X}}(k)$ present in the measurements employed for feedback, this error is assumed to takes values in some known set $\tilde{\mathbb{E}}$ with $0 \in \tilde{\mathbb{E}}$.

Assume the maximum max-plus eigenvalue of \tilde{A} satisfies $\lambda^* \in \mathbb{R}_{>\varepsilon}$. Then, from Lemma 6.3.8 in [30] it follows that there exists a max-plus invertible matrix $P \in \mathbb{R}_{\varepsilon}^{n_w \times n_w}$ such that

$$\left(P^{\otimes -1} \otimes \tilde{A} \otimes P \right)_{ij} \leq \lambda^*, \quad \forall i, j \in \mathbb{Z}_{[1, n_w]}. \quad (7.13)$$

Define variables $\bar{w}_{\mathcal{X}}(k)$ and $\bar{u}_{\mathcal{X}}$ as

$$\bar{w}_{\mathcal{X}}(k) \triangleq P^{\otimes -1} \otimes \tilde{w}_{\mathcal{X}}(k) - \rho k, \quad (7.14a)$$

$$\bar{u}_{\mathcal{X}}(k) \triangleq \tilde{u}_{\mathcal{X}}(k) - \rho k. \quad (7.14b)$$

Note that the function $f_p(\cdot) \triangleq P \otimes (\cdot)$ is *homogeneous*. Then, due to the homogeneity of $f_p(\cdot)$ it follows, by employing (7.14a), that

$$\tilde{w}_{\mathcal{X}}(k) = P \otimes \bar{w}_{\mathcal{X}}(k) + \rho k, \quad (7.15a)$$

$$\tilde{u}_{\mathcal{X}}(k) = \bar{u}_{\mathcal{X}}(k) + \rho k. \quad (7.15b)$$

Performing the coordinate change as defined in (7.14) on the event-domain recursion in (7.3) and employing the relations in (7.15) yields the following recursion

$$\bar{w}_{\mathcal{X}}(k+1) = \bar{A} \otimes \bar{w}_{\mathcal{X}}(k) \oplus \bar{B} \otimes \bar{u}_{\mathcal{X}}(k), \quad (7.16)$$

where

$$\bar{A} \triangleq P^{\otimes -1} \otimes \tilde{A} \otimes P - \rho \quad \text{and} \quad \bar{B} \triangleq P^{\otimes -1} \otimes \tilde{B} - \rho. \quad (7.17)$$

Since, $\rho > \lambda^*$ and (7.13) hold, it follows that the matrix \bar{A} satisfies

$$\bar{A}_{ij} < 0, \quad \forall i, j \in \mathbb{Z}_{[1, n_w]}. \quad (7.18)$$

Due to the fact that (7.18) holds, it follows from Lemma 2.1.2 that \bar{A}^* exists and is given by

$$\bar{A}^* = E \oplus \bar{A} \oplus \dots \oplus \bar{A}^{\otimes n_w - 1}.$$

Note that an equilibrium point, i.e. $\bar{w}_{\mathcal{X}_{eq}}$, of system (7.16) can be computed by solving

$$\bar{w}_{\mathcal{X}_{eq}} = \bar{A} \otimes \bar{w}_{\mathcal{X}_{eq}} \oplus \bar{B} \otimes \bar{u}_{\mathcal{X}_{eq}}, \quad (7.19)$$

where $\bar{u}_{\mathcal{X}_{eq}}$ is an input associated to an equilibrium $\bar{w}_{\mathcal{X}_{eq}}$. According to Lemma 2.1.6 the unique solution to (7.19) is given by

$$\bar{w}_{\mathcal{X}_{eq}} = \bar{A}^* \otimes \bar{B} \otimes \bar{u}_{\mathcal{X}_{eq}}, \quad (7.20)$$

with $\bar{w}_{\mathcal{X}_{eq}}$ being finite under the assumption that the matrix

$$\begin{bmatrix} \bar{B} & \bar{A} \oplus \bar{B} & \dots & \bar{A}^{\otimes n_w - 1} \otimes \bar{B} \end{bmatrix} \quad (7.21)$$

is row-finite. The following result can now be formulated.

Theorem 7.1.5 *Let*

$$\bar{u}_{\mathcal{X}}(k) = \kappa(\bar{w}_{\mathcal{X}}(k)) \quad (7.22)$$

be a control law which is Lipschitz continuous. Suppose that the control law in (7.22) renders equilibrium point $\bar{w}_{\mathcal{X}_{eq}}$ of system (7.16) in closed-loop with (7.22) (at least) exponentially stable in the sense of Definition 2.2.1 with respect to initial conditions $\bar{w}_{\mathcal{X}_0}$ in $\mathbb{R}^{n_w + n_u}$. Then, the following statements hold true

i) *The equilibrium $\bar{w}_{\mathcal{X}_{eq}}$ of the following closed-loop recursion*

$$\bar{w}_{\mathcal{X}}(k+1) = \bar{A} \otimes \bar{w}_{\mathcal{X}}(k) \oplus \bar{B} \otimes \kappa(\bar{w}_{\mathcal{X}}(k) + \bar{e}_{\mathcal{X}}(k)), \quad k \in \mathbb{Z}_+, \quad (7.23)$$

is input-to-state stable with respect to perturbations $\bar{e}_{\mathcal{X}} : \mathbb{Z}_+ \rightarrow \bar{\mathbb{E}} \subseteq \mathbb{R}^{n_w + n_u}$ and initial conditions $\bar{w}_{\mathcal{X}_0}$ in $\mathbb{R}^{n_w + n_u}$.

ii) *The recursion (7.9) in closed-loop with the control law in (7.12) with*

$$\tilde{\kappa}(\tilde{w}_{\mathcal{X}}(k) + \tilde{e}_{\mathcal{X}}(k)) \triangleq \kappa(P^{\otimes -1} \otimes (\tilde{w}_{\mathcal{X}}(k) + \tilde{e}_{\mathcal{X}}(k)) - \rho k) + \rho k, \quad (7.24)$$

is stable in the sense that for all $\tilde{e}_{\mathcal{X}} : \mathbb{Z}_+ \rightarrow \tilde{\mathbb{E}}$ and initial conditions $\tilde{w}_{\mathcal{X}_0} \in \mathbb{R}^{n_w + n_u}$.

$$\lim_{k \rightarrow \infty} \frac{\tilde{w}_{\mathcal{X}_j}(k)}{k} = \rho, \quad \forall j \in \mathbb{Z}_{[1, n_w]}, \quad k \in \mathbb{Z}_{>0}. \quad (7.25)$$

Proof:

i) Due to the hypothesis in Theorem 7.1.5, the equilibrium point $\bar{w}_{\mathcal{X}_{eq}}$ of the following closed-loop system

$$\bar{w}_{\mathcal{X}}(k+1) = \Gamma(\bar{w}_{\mathcal{X}}(k)) \triangleq f(\bar{w}_{\mathcal{X}}(k), \kappa(\bar{w}_{\mathcal{X}}(k))), \quad k \in \mathbb{Z}_+, \quad (7.26)$$

with $f(\bar{w}_{\mathcal{X}}(k), \bar{u}_{\mathcal{X}}(k)) \triangleq \bar{A} \otimes \bar{w}_{\mathcal{X}}(k) \oplus \bar{B} \otimes \bar{u}_{\mathcal{X}}(k)$, is exponentially stable with respect to $\bar{w}_{\mathcal{X}_0} \in \mathbb{R}^{n_w + n_u}$. Note that $\Gamma : \mathbb{R}^{n_w + n_u} \rightarrow \mathbb{R}^{n_w + n_u}$ is Lipschitz continuous due

to the fact that the functions $\kappa : \mathbb{R}^{n_w} \rightarrow \mathbb{R}^{n_u}$ and $f : \mathbb{R}^{n_w+n_u} \times \mathbb{R}^{n_u} \rightarrow \mathbb{R}^{n_w+n_u}$ are Lipschitz continuous with respect to their arguments on the domains \mathbb{R}^{n_u} and $\mathbb{R}^{n_w} \times \mathbb{R}^{n_u}$ with Lipschitz constants L_κ and L_{f_xu} , respectively. Hence, the converse Lyapunov statement in Theorem 2.2.5 holds. That is, there exists a Lyapunov function $V(\cdot)$ and constants $a, b, c \in \mathbb{R}_{>0}$ such that for all $\xi \in \mathbb{R}^{n_w+n_u}$

$$a|\xi - \bar{w}_{\mathcal{H}eq}| \leq V(\xi) \leq b|\xi - \bar{w}_{\mathcal{H}eq}|, \quad (7.27a)$$

$$V(f(\xi, \kappa(\xi))) = V(\Gamma(\xi)) \leq V(\xi) - c|\xi - \bar{w}_{\mathcal{H}eq}|. \quad (7.27b)$$

Furthermore, $V(\cdot)$ is Lipschitz continuous in $\mathbb{R}^{n_w+n_u}$ with Lipschitz constant L_V . Hence, for all $\xi, \varepsilon \in \mathbb{R}^{n_w+n_u}$

$$\begin{aligned} V(f(\xi, \kappa(\xi + \varepsilon))) - V(f(\xi, \kappa(\xi))) &\leq L_V |f(\xi, \kappa(\xi + \varepsilon)) - f(\xi, \kappa(\xi))| \leq \\ &\leq L_V L_{f_u} |\kappa(\xi + \varepsilon) - \kappa(\xi)| \quad (7.28) \\ &\leq L_V L_{f_u} L_\kappa |\varepsilon|. \end{aligned}$$

Combining inequality (7.27b) and the last inequality in (7.28) yields

$$V(f(\xi, \kappa(\xi + \varepsilon))) \leq V(\xi) - c|\xi - \bar{w}_{\mathcal{H}eq}| + L_V L_{f_u} L_\kappa |\varepsilon|, \quad (7.29)$$

for all $\xi, \varepsilon \in \mathbb{R}^{n_w+n_u}$. Inequalities (7.27a) and (7.29) then prove that first statement in Theorem 7.1.5, i.e. for all $\bar{e}_{\mathcal{H}} : \mathbb{Z}_+ \rightarrow \bar{\mathbb{E}}$ and $\bar{w}_{\mathcal{H}0} \in \mathbb{R}^{n_w+n_u}$ the solution of (7.23) satisfies

$$|\bar{w}_{\mathcal{H}}(k)| \leq \beta_{\bar{w}_{\mathcal{H}}}(|\bar{w}_{\mathcal{H}0}|, k) + \gamma_{\bar{w}_{\mathcal{H}}}^{\bar{e}_{\mathcal{H}}}(\|\bar{e}_{\mathcal{H}}\|), \quad \forall k \in \mathbb{Z}_+, \quad (7.30)$$

where the $\beta_{\bar{w}_{\mathcal{H}}}$ and $\gamma_{\bar{w}_{\mathcal{H}}}^{\bar{e}_{\mathcal{H}}}$ is a \mathcal{H} \mathcal{L} -function and \mathcal{H} \mathcal{F} -function, respectively that can be obtained as indicated in (2.35) of Theorem 2.3.4.

ii) In the sequel it will be shown that by employing the coordinate change in (7.14) and (7.15), the feedback law in (7.12), with $\tilde{\kappa}$ defined in (7.24), can be transformed into the form as in (7.23).

Substitute (7.12), with $\tilde{\kappa}$ defined in (7.24), into (7.14b) and subsequently substituting (7.15a) into the obtained expression yields

$$\bar{u}_{\mathcal{H}}(k) = \kappa(P^{\otimes -1} \otimes (P \otimes \bar{w}_{\mathcal{H}}(k) + \rho k + \tilde{e}_{\mathcal{H}}(k)) - \rho k) \quad (7.31)$$

or similarly (due to homogeneity)

$$\bar{u}_{\mathcal{H}}(k) = \kappa(P^{\otimes -1} \otimes (P \otimes \bar{w}_{\mathcal{H}}(k) + \tilde{e}_{\mathcal{H}}(k))). \quad (7.32)$$

Note that $P^{\otimes -1} \otimes (P \otimes \bar{w}_{\mathcal{H}}(k) + \tilde{e}_{\mathcal{H}}(k)) = \bar{w}_{\mathcal{H}}$ in case $\tilde{e}_{\mathcal{H}}(k) = 0$. This fact implies, without loss of generality, that one can state that for all $\tilde{e}_{\mathcal{H}}(k), \bar{w}_{\mathcal{H}}(k) \in \mathbb{R}^{n_w+n_u}$ there exists $\bar{e}_{\mathcal{H}}(k) \in \mathbb{R}^{n_w+n_u}$ such that

$$P^{\otimes -1} \otimes (P \otimes \bar{w}_{\mathcal{H}}(k) + \tilde{e}_{\mathcal{H}}(k)) = \bar{w}_{\mathcal{H}}(k) + \bar{e}_{\mathcal{H}}(k). \quad (7.33)$$

Hence, (7.32) then becomes

$$\bar{\mathbf{u}}_{\mathcal{X}}(k) = \kappa(\bar{\mathbf{w}}_{\mathcal{X}}(k) + \bar{\mathbf{e}}_{\mathcal{X}}(k)). \quad (7.34)$$

According to the hypothesis in Theorem 7.1.5, control law (7.34) renders equilibrium point $\bar{\mathbf{w}}_{\mathcal{X}_{eq}}$ of closed-loop system (7.23) input-to-state stable, i.e. property (7.30) holds. This implies, by employing (7.15a), that the following holds for all $\tilde{\mathbf{w}}_{\mathcal{X}_0} \in \mathbb{R}^{n_w+n_u}$ and $\bar{\mathbf{e}}_{\mathcal{X}} : \mathbb{Z}_+ \rightarrow \bar{\mathbb{E}}$

$$\lim_{k \rightarrow \infty} \frac{\tilde{\mathbf{w}}_{\mathcal{X}_j}(k)}{k} = \rho, \quad \forall j \in \mathbb{Z}_{[1, n_w+n_u]}, \quad k \in \mathbb{Z}_{>0}, \quad (7.35)$$

and due to (7.32), (7.33) also for all $\tilde{\mathbf{e}}_{\mathcal{X}} : \mathbb{Z}_+ \rightarrow \bar{\mathbb{E}}$. ■

The question of how to obtain a control law as given in (7.22) with the properties as given in the hypothesis of Theorem 7.1.5 is discussed in the next section.

An event domain MPC setup

In this section it will be pointed out how to obtain a control law as given in (7.22) with the properties as given in the hypothesis of Theorem 7.1.5. In fact this section contains, for completeness purposes, a brief summary of an event domain based model predictive control strategy proposed in [109]. This model predictive control strategy results in a control law as given in (7.22). For the model predictive control setup an exponential stability result in the sense of Definition 2.2.1 in the event domain is obtained in [109]. Furthermore, it is proven in [109] that the resulting event domain model predictive control law of the form as in (7.22) belongs to the class of max-min-plus-scaling functions. Since max-min-plus-scaling functions are Lipschitz continuous, one can employ the result in Theorem 7.1.5 to conclude that the manufacturing system (7.1), i.e. recursion (7.3), in closed-loop with the event domain based controller, defined by (7.10), (7.12) and (7.24), also exhibits robustness, i.e. stability in the sense of Definition 7.1.2 irrespective of the possible presence of measurement errors $\tilde{\mathbf{e}}_{\mathcal{X}}$.

For fixed $N \in \mathbb{Z}_{\geq 1}$, let

$$\mathbf{w}_{\mathcal{X}}(\bar{\mathbf{w}}_{\mathcal{X}}(k), \mathbf{u}_{\mathcal{X}}(k)) \triangleq \left[\bar{\mathbf{w}}_{\mathcal{X}}^{\top}(k+1|k), \dots, \bar{\mathbf{w}}_{\mathcal{X}}^{\top}(k+N|k) \right]^{\top} \quad (7.36)$$

denote the sequence generated by the recursion (7.16) from initial condition $\bar{\mathbf{w}}_{\mathcal{X}}(k|k) \triangleq \bar{\mathbf{w}}_{\mathcal{X}}(k)$ at event counter $k \in \mathbb{Z}_+$ and by applying the control sequence

$$\mathbf{u}_{\mathcal{X}}(k) \triangleq \left[\bar{\mathbf{u}}_{\mathcal{X}}^{\top}(k|k), \dots, \bar{\mathbf{u}}_{\mathcal{X}}^{\top}(k+N-1|k) \right]^{\top}. \quad (7.37)$$

The class of admissible control sequences defined with respect to $\bar{w}_{\mathcal{X}}(k)$ is

$$\mathcal{U}_{\mathcal{X}}^N(\bar{w}_{\mathcal{X}}(k)) \triangleq \left\{ \mathbf{u}_{\mathcal{X}}(k) \mid \mathbf{w}_{\mathcal{X}}(\bar{w}_{\mathcal{X}}(k), \mathbf{u}_{\mathcal{X}}(k)) \text{ satisfies recursion (7.14)} \right\}. \quad (7.38)$$

Let $N \in \mathbb{Z}_{\geq 1}$ and $\bar{w}_{\mathcal{X}_{eq}}$ (see (7.19)) be given. Furthermore, at event counter $k \in \mathbb{Z}_+$, let $\bar{w}_{\mathcal{X}}(k)$ be given. Then the basic considered event domain model predictive control scenario consists in minimizing, at each event counter $k \in \mathbb{Z}_+$ a finite event domain horizon cost function of the form

$$J_{\mathcal{X}}(\bar{w}_{\mathcal{X}}(k), \mathbf{u}_{\mathcal{X}}(k)) \triangleq \sum_{i=0}^{N-1} \left(\sum_{j=1}^{n_w} \max \{ \bar{w}_{\mathcal{X}_j}(k+i) - \bar{w}_{\mathcal{X}_{eq}}, 0 \} - \mu \sum_{j=1}^{n_u} \bar{u}_{\mathcal{X}}(k+i|k) \right) + \sum_{j=1}^{n_w} \max \{ \bar{w}_{\mathcal{X}_j}(k+N) - \bar{w}_{\mathcal{X}_{eq}}, 0 \}, \quad (7.39)$$

where $\mu \in \mathbb{R}_{>0}$, with event domain prediction model (7.16), over all sequences $\mathbf{u}_{\mathcal{X}}(k)$ in $\mathcal{U}_{\mathcal{X}}^N(\bar{w}_{\mathcal{X}}(k))$. That is, for a given $\bar{w}_{\mathcal{X}}(k) \in \mathbb{R}^{n_w}$, solve

$$\inf_{\mathbf{u}_{\mathcal{X}}(k) \in \mathcal{U}_{\mathcal{X}}^N(\bar{w}_{\mathcal{X}}(k))} J_{\mathcal{X}}(\bar{w}_{\mathcal{X}}(k), \mathbf{u}_{\mathcal{X}}(k)). \quad (7.40)$$

An optimal sequence of controls, if it exists, that minimized (7.40) is denoted by

$$\mathbf{u}_{\mathcal{X}}^*(k) \triangleq \left[\bar{\mathbf{u}}_{\mathcal{X}}^{*\top}(k|k), \dots, \bar{\mathbf{u}}_{\mathcal{X}}^{*\top}(k+N-1|k) \right]^{\top}. \quad (7.41)$$

In [109] the following result is proven.

Theorem 7.1.6 *Suppose that for the tuning parameter μ , in the cost (7.39), there holds*

$$\mu \in \mathbb{R}_{(0, \frac{1}{n_u N})}. \quad (7.42)$$

Then, the optimal sequence of controls that minimizes (7.40) is given by

$$\mathbf{u}_{\mathcal{X}}^*(k) = (-H^{\top}) \otimes (\Phi \otimes \bar{w}_{\mathcal{X}}(k) \oplus \mathbf{w}_{\mathcal{X}_{eq}}) = -(H^{\top} \otimes (-(\Phi \otimes \bar{w}_{\mathcal{X}_{eq}} \oplus \mathbf{w}_{\mathcal{X}_{eq}}))), \quad (7.43)$$

where

$$\mathbf{w}_{\mathcal{X}_{eq}} \triangleq \begin{bmatrix} \bar{w}_{\mathcal{X}_{eq}} \\ \vdots \\ \bar{w}_{\mathcal{X}_{eq}} \end{bmatrix}, \quad \Phi \triangleq \begin{bmatrix} E \\ \bar{A} \\ \vdots \\ \vdots \\ \bar{A}^{\otimes N} \end{bmatrix}, \quad H \triangleq \begin{bmatrix} \boldsymbol{\varepsilon} & \dots & \dots & \boldsymbol{\varepsilon} \\ \bar{B} & & \ddots & \vdots \\ \vdots & & \ddots & \vdots \\ \vdots & & & \ddots & \boldsymbol{\varepsilon} \\ \bar{A}^{\otimes N-1} \otimes \bar{B} & \bar{A}^{\otimes N-2} \otimes \bar{B} & \dots & \bar{B} \end{bmatrix}. \quad (7.44)$$

The optimal event domain model predictive control law is then denoted by a map $\kappa^{\text{MPC}^*} : \mathbb{R}^{n_w} \rightarrow \mathbb{R}^{n_u}$, i.e.

$$\bar{u}_{\mathcal{X}}(k) \triangleq \bar{u}_{\mathcal{X}}^{*\top}(k|k) = \kappa^{\text{MPC}^*}(\bar{w}_{\mathcal{X}}(k)), \quad k \in \mathbb{Z}_+. \quad (7.45)$$

As a direct consequence of Theorem (7.1.6) one can conclude that the model predictive control law in (7.45), resulting from the just described event domain model predictive control strategy, belongs, under the hypothesis of Theorem (7.1.6), to the class of max-min-plus-scaling functions. That is, the event domain model predictive control law $\kappa^{\text{MPC}^*}(\cdot)$ is a continuous piecewise affine function of its argument.

Yet another result that is proven in [109] is the following.

Theorem 7.1.7 *Let $\rho \in \mathbb{R}_{>\lambda^*}$, where $\lambda^* \in \mathbb{R}_{>\varepsilon}$ represents the maximum max-plus algebraic eigenvalue of \tilde{A} in recursion (7.9). Suppose that for the tuning parameter μ , in the cost (7.39), there holds*

$$\mu \in \mathbb{R}_{(0, \frac{1}{n_u N})}. \quad (7.46)$$

*Then, the model predictive control law (7.45) renders the equilibrium point $\bar{w}_{\mathcal{X}_{\text{eq}}}$ of system (7.16) in closed-loop with (7.45) **exponentially stable** in the sense of Definition 2.2.1 with respect to initial conditions $\bar{w}_{\mathcal{X}_0}$ in $\mathbb{R}^{n_w+n_u}$.*

Note that under the results in Theorems 7.1.6 and 7.1.7, the hypothesis in Theorem 7.1.5 holds for the model predictive control law in (7.45), which is a result of the model predictive control strategy presented in this section.

Next, the results that are presented in this chapter up till now, are demonstrated via an illustrative example.

Example 7.1.8 In this example the manufacturing system as considered in Chapter 6 in Example 6.5.8 is taken. However, the buffer B_1 in Example 6.5.8 with a capacity for a finite number of products, i.e. two products ($N_1 = 2$), see Figure 6.3, is in this example replaced by a buffer with a capacity for an infinite number of products. The resulting manufacturing system can then be described by the system description of the form as defined in (7.1) with $\mathfrak{B}_{\mathcal{X}}$ in (7.2) defined by the following matrices and

signals

$$A \triangleq \begin{bmatrix} \varepsilon & \varepsilon & \varepsilon & \varepsilon & \varepsilon \\ \varepsilon & d_1 = 3 & \varepsilon & \varepsilon & 0 \\ \varepsilon & d_1 + d_2 = 7 & d_2 = 4 & \varepsilon & \varepsilon \\ \varepsilon & \varepsilon & 0 & \varepsilon & \varepsilon \\ \varepsilon & \varepsilon & \varepsilon & 0 & \varepsilon \end{bmatrix}, \quad B \triangleq \begin{bmatrix} 0 \\ d_1 = 3 \\ d_1 + d_2 = 7 \\ \varepsilon \\ \varepsilon \end{bmatrix},$$

$$w_{\mathcal{X}}(k) \triangleq \left[w_{\mathcal{X}_2}^1(k-1) \quad w_{\mathcal{X}_2}^2(k-1) \quad w_{\mathcal{X}_3}^2(k-1) \quad w_{\mathcal{X}_3}^2(k-2) \quad w_{\mathcal{X}_3}^2(k-3) \right]^\top. \quad (7.47)$$

The control goal is to stabilize the considered manufacturing system in the sense of Definition 7.1.2 in the presence of measurement noise $\tilde{e}_{\mathcal{X}}$. Furthermore, it is required that the signal $q_{\mathcal{X}} \triangleq w_{\mathcal{X}_3}^2 \triangleq Cw_{\mathcal{X}}$, with

$$C_q \triangleq \begin{bmatrix} \varepsilon & \varepsilon & 0 & \varepsilon & \varepsilon \end{bmatrix}, \quad (7.48)$$

“tracks” the following event domain signal

$$q_{\mathcal{X}}^r(k) \triangleq c_q + \rho k, \quad k \in \mathbb{Z}_+ \quad (7.49)$$

with $\rho \in \mathbb{R}_{(0, \lambda^*)}$ and $c_q \in \mathbb{R}$. Note that the maximum max-plus algebraic eigenvalue of A is $\lambda^* = 4$, which corresponds to a maximum mean throughput of the system of $1/4$ [products/time unit]. The signal $q_{\mathcal{X}}^r(k)$ can be seen as reference due dates, i.e. desired time instances at which the k th product should exist the manufacturing line. The particular values for c_q and ρ in this example are $c_q = 3$ and $\rho = 5$.

To establish the afore mentioned control goal the controller defined by (7.10), (7.12) and (7.24) is employed. The design of $\kappa(\cdot)$ in (7.24) is established by employing the model predictive control setup as described previously, i.e. $\kappa(\cdot) = \kappa^{\text{MPC}^*}(\cdot)$.

To guarantee that the event domain control $u_{\mathcal{X}}$ satisfies the property as indicated by (7.7), the controller synthesis is based on the system recursion given by (7.9), see Lemma 7.1.4 for a justification of this approach. From the matrices A , B and C defined in (7.47) and (7.48), one can obtain matrices \tilde{A} , \tilde{B} and \tilde{C} . Where the matrices \tilde{A} and \tilde{B} define recursion (7.9) and the matrix

$$\tilde{C} \triangleq \begin{bmatrix} C & \varepsilon \end{bmatrix} \quad (7.50)$$

relates the to-be-tracked signal $q_{\mathcal{X}}(k)$ to the signal $\tilde{w}_{\mathcal{X}}(k)$ satisfying recursion (7.9).

A valid choice for matrix P , i.e. one that satisfies (7.13), is given by

$$P \triangleq \begin{bmatrix} 0 & \varepsilon & \varepsilon & \varepsilon & \varepsilon & \varepsilon \\ \varepsilon & 27 & \varepsilon & \varepsilon & \varepsilon & \varepsilon \\ \varepsilon & \varepsilon & 39 & \varepsilon & \varepsilon & \varepsilon \\ \varepsilon & \varepsilon & \varepsilon & 35 & \varepsilon & \varepsilon \\ \varepsilon & \varepsilon & \varepsilon & \varepsilon & 31 & \varepsilon \\ \varepsilon & \varepsilon & \varepsilon & \varepsilon & \varepsilon & 0 \end{bmatrix} \Leftrightarrow P^{\otimes -1} \triangleq \begin{bmatrix} 0 & \varepsilon & \varepsilon & \varepsilon & \varepsilon & \varepsilon \\ \varepsilon & -27 & \varepsilon & \varepsilon & \varepsilon & \varepsilon \\ \varepsilon & \varepsilon & -39 & \varepsilon & \varepsilon & \varepsilon \\ \varepsilon & \varepsilon & \varepsilon & -35 & \varepsilon & \varepsilon \\ \varepsilon & \varepsilon & \varepsilon & \varepsilon & -31 & \varepsilon \\ \varepsilon & \varepsilon & \varepsilon & \varepsilon & \varepsilon & 0 \end{bmatrix}. \quad (7.51)$$

Hence the coordinate change in (7.14) is now defined and therefore the recursion in (7.16), with its matrices \bar{A} and \bar{B} given in (7.17), is defined. Note that if one defines

$$\bar{q}_{\mathcal{X}}(k) \triangleq q_{\mathcal{X}}(k) - \rho k, \quad k \in \mathbb{Z}_+$$

and hence

$$\bar{q}_{\mathcal{X}}(k) = \bar{C}\bar{w}_{\mathcal{X}}(k), \quad k \in \mathbb{Z}_+ \quad (7.52)$$

where $\bar{C} \triangleq \tilde{C} \otimes P$, the afore mentioned ‘‘tracking’’ problem in the original coordinates, i.e. $(u_{\mathcal{X}}(k), w_{\mathcal{X}}(k), q_{\mathcal{X}}(k))$, becomes a point stabilization problem in the new coordinated, i.e. $(\bar{u}_{\mathcal{X}}(k), \bar{w}_{\mathcal{X}}(k), \bar{q}_{\mathcal{X}}(k))$. This can be easily seen by defining

$$\bar{q}'_{\mathcal{X}}(k) \triangleq q'_{\mathcal{X}}(k) + \rho k, \quad k \in \mathbb{Z}_+, \quad (7.53)$$

and subsequential substitution of (7.49) in (7.53), which yields

$$\bar{q}'_{\mathcal{X}}(k) = c_q, \quad \forall k \in \mathbb{Z}_+. \quad (7.54)$$

Hence

$$\bar{q}_{\mathcal{X}}(k) \rightarrow c_q \Rightarrow q_{\mathcal{X}}(k) \rightarrow q'_{\mathcal{X}}(k), \quad k \in \mathbb{Z}_+. \quad (7.55)$$

In order to establish the goal in (7.55) the event domain model predictive control strategy explained in this section will be employed. Since one has that (7.13) is satisfied and the matrix defined in (7.21) is row finite, for the particular matrices \bar{A} and \bar{B} in this example, the equilibrium point $\bar{w}_{\mathcal{X}_{eq}}$ of the recursion (7.16) is, for given $\bar{u}_{\mathcal{X}_{eq}} \in \mathbb{R}$, well defined by (7.20). In order to guarantee that the norm of the steady state error with respect to the point c_q , i.e. $|q_{\mathcal{X}}(k) - c_q|$, will be as small as possible, one associates to c_q the largest² value for $\bar{u}_{\mathcal{X}_{eq}}$ and corresponding equilibrium point $\bar{w}_{\mathcal{X}_{eq}}$ satisfying $\bar{C} \otimes \bar{w}_{\mathcal{X}_{eq}} \leq c_q$. Hence, by employing Lemma 2.1.5 and relation (7.20) one obtains

$$\bar{u}_{\mathcal{X}_{eq}} = -((\bar{C} \otimes \bar{A}^* \otimes \bar{B})^\top \otimes (-c_q)). \quad (7.56)$$

²By the largest it is meant that any other feasible value $\bar{u}_{\mathcal{X}_{eq}}^f$ and corresponding equilibrium $\bar{w}_{\mathcal{X}_{eq}}^f$ satisfies $\bar{w}_{\mathcal{X}_{eq}}^f \leq \bar{w}_{\mathcal{X}_{eq}}$ and $\bar{u}_{\mathcal{X}_{eq}}^f \leq \bar{u}_{\mathcal{X}_{eq}}$.

Under the additional assumption that the matrix

$$\left[\bar{C}^\top \quad (\bar{C} \otimes \bar{A})^\top \quad \dots \quad (\bar{C} \otimes \bar{A}^{\otimes n_w-1})^\top \right]^\top \quad (7.57)$$

is column-finite, $\bar{u}_{\mathcal{X}_{eq}}$ is finite for given $c_q \in \mathbb{R}$. For this example one can verify that the matrix in (7.57) is column-finite. Now one can obtain $\bar{u}_{\mathcal{X}_{eq}} = 1$ and $\bar{w}_{\mathcal{X}_{eq}} = [-4 \ -28 \ -36 \ -37 \ -38 \ -4]^\top$ by employing (7.56) and (7.20), respectively. Choose N and μ in the model predictive control cost given in (7.39) as $N = 2$ and $\mu = 0.4$ to obtain adequate response to disturbances. Note that $\mu = 0.4 \in \mathbb{R}_{(0,1/(N=2))}$ and $\rho = 5 \in \mathbb{R}_{>\lambda^*=4}$. Hence Theorems 7.1.6 and 7.1.7 hold, i.e. the event domain model predictive control law $\kappa^{\text{MPC}^*}(\cdot)$ is known explicitly and is Lipschitz continuous. Furthermore, the model predictive control law $\kappa^{\text{MPC}^*}(\cdot)$ renders the equilibrium point $\bar{w}_{\mathcal{X}_{eq}}$ of system (7.16) in closed-loop with $\kappa^{\text{MPC}^*}(\cdot)$ exponentially stable in the sense of Definition 2.2.1 with respect to initial conditions $\bar{w}_{\mathcal{X}_0}$ in \mathbb{R}^6 . Hence Theorem 7.1.5 applies, i.e. the manufacturing system (7.1), i.e. recursion (7.3), in closed-loop with the event domain based controller defined by (7.10), (7.12) and (7.24) is stable in the sense of Definition 7.1.2 irrespective of the possible presence of event times measurement errors $\tilde{e}_{\mathcal{X}}(k) \in \mathbb{R}^6$.

To give an illustration of the obtained event domain controller, an event domain simulation of the obtained event domain closed-loop recursion is performed. In Figure 6.3 and Figure 6.3 the result of the event domain closed-loop system response resulting from the simulation for initial condition $w_{\mathcal{X}_0} = [0 \ 3 \ 14 \ 10 \ 6]^\top$ is given. For the ease of interpretation of the result, the event domain signals, i.e. $u_{\mathcal{X}}$, $q_{\mathcal{X}} = w_{\mathcal{X}_3}^2$ and $q_{\mathcal{X}}^r$ are presented in the time domain in Figure 6.3. In Figure 6.3 one can observe that over the time interval $t = 0$ to approximately $t = 70$ the trajectory $q_{\mathcal{X}} = w_{\mathcal{X}_3}^2$ ($q_{\mathcal{D}}$) converges to the to-be-tracked desired trajectory $q_{\mathcal{X}}^r$ ($q_{\mathcal{D}}^r$). From approximately $t = 70$ and above the event domain measurement noise $\tilde{e}_{\mathcal{X}}(k)$ is non-zero, i.e. for $k \in \mathbb{Z}_{>14}$ the components of $\tilde{e}_{\mathcal{X}}(k)$ consist of values chosen from a normal distribution with zero mean and variance six. In Figure 6.3 the quantities $\frac{w_{\mathcal{X}_i}}{k}$, $i \in \mathbb{Z}_{[1,5]}$ are presented to illustrate stability in the sense of Definition 7.1.2 irrespective of the presence of non-zero event domain measurement noise $\tilde{e}_{\mathcal{X}}(k)$, i.e. the quantities $\frac{w_{\mathcal{X}_i}}{k}$, $i \in \mathbb{Z}_{[1,5]}$ all converge towards the assigned ρ , which corresponds to the closed-loop system's throughput of $1/5$ [products/time unit]. Although the manufacturing system, on which the presented theory is illustrated, is a relatively simple manufacturing line consisting of just two machines M_1 and M_2 with a buffer with infinite and finite capacity in front of the machines, respectively, one can handle manufacturing systems with much higher complexity. That is, all manufacturing systems that can be modeled within the event domain modeling framework as defined in (7.1), and satisfy the made mild assumptions in this chapter, can be handled. Since, the event domain model predictive control law is known explicitly, see Theorem 7.1.6, no on-line optimization is

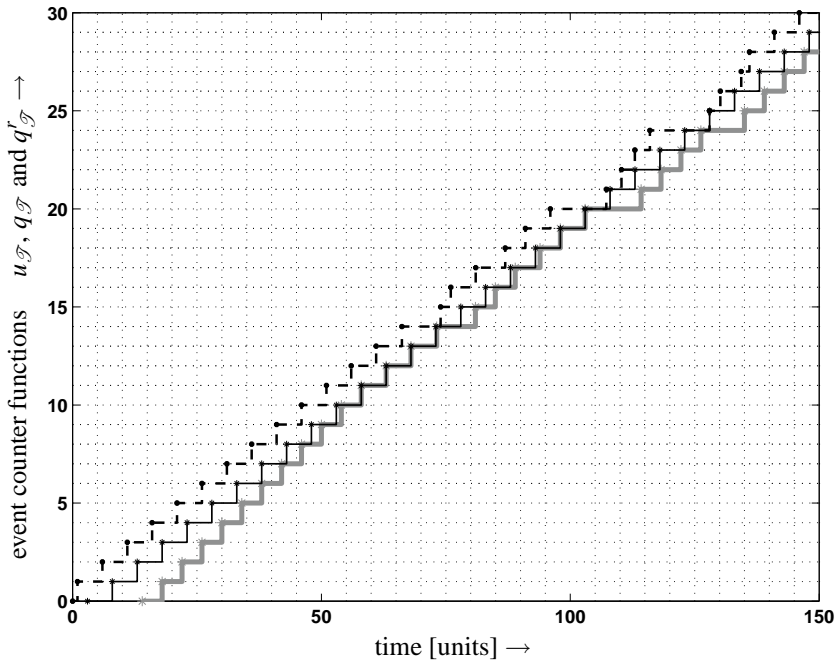

Figure 7.2: In the figure the time domain signals of the corresponding event domain signals, i.e. release times of raw products into the manufacturing line $u_{\mathcal{K}}$ (dashed), the actual event times of products leaving the manufacturing line $q_{\mathcal{K}} = w_{\mathcal{K}_3}^2$ (thick grey) and the desired event times at which products should leave the manufacturing line $q_{\mathcal{K}}^r$ (solid) are plotted along the time axis.

required. This makes the controller design approach also appealing for large scale (but deterministic) manufacturing system applications. Note that the signal space, i.e. the dimension of the modeled manufacturing system scales linearly with the amount of workstations present in a manufacturing line. This is yet another appealing argument which makes the approach suitable to be employed to large scale manufacturing systems. A major technical problem however is a causality problem. In the next section this causality problem will be explained in more detail.

7.2 Causality problem

The major problem of the event domain controller design approach, as explained in the previous sections of this chapter, is that if the obtained controller is employed in the time domain, one will encounter a causality problem. In the sequel it is made

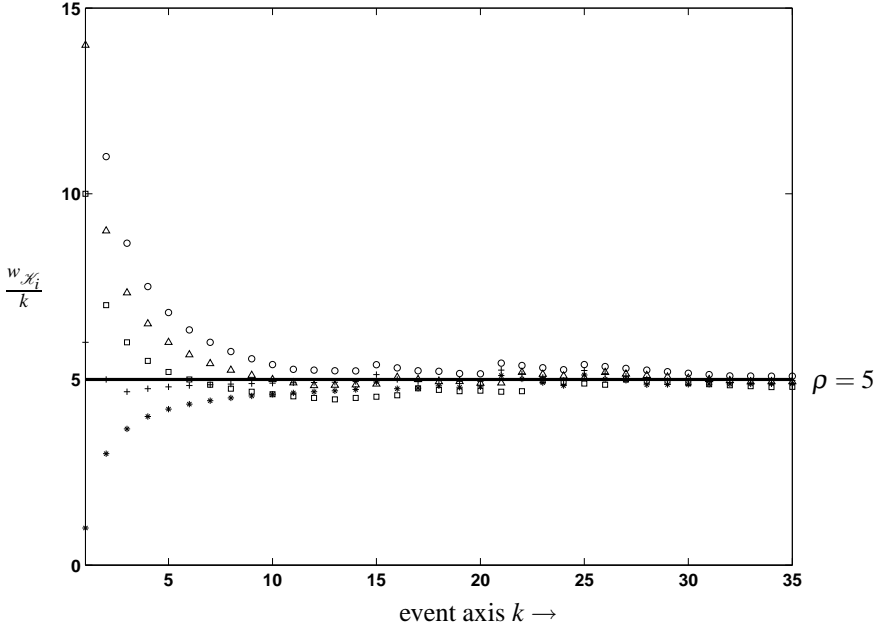

Figure 7.3: The quantities $\frac{w_{\mathcal{X}_1}}{k}$ (*), $\frac{w_{\mathcal{X}_2}}{k}$ (+), $\frac{w_{\mathcal{X}_3}}{k}$ (o), $\frac{w_{\mathcal{X}_4}}{k}$ (Δ) and $\frac{w_{\mathcal{X}_5}}{k}$ (\square) presented along the event counter axis $k \in \mathbb{Z}_{>0}$.

precise what is meant by the causality problem. Recall that the controller structure that is obtained following the event domain controller synthesis method explained in the previous sections of this chapter is of the following form

$$u_{\mathcal{X}}(k+1) \triangleq \kappa_{\mathcal{X}}([w_{\mathcal{X}}(k) \ u_{\mathcal{X}}(k)]^{\top}), \quad k \in \mathbb{Z}_+. \quad (7.58)$$

Recall that in the event domain the signals needed for feedback and the controls, i.e. $w_{\mathcal{X}}(k)$ and $u_{\mathcal{X}}$, respectively, represent time instances of certain events. In Figure 7.4 an illustration is given of the causality problem that one encounters if a controller of the structure as in (7.58) is employed in the time domain. In Figure 7.4 an example of signal realizations, i.e. $w_{\mathcal{X}_2}^1$, $w_{\mathcal{X}_2}^2$ and $w_{\mathcal{X}_3}^2$ of the manufacturing system as considered in Example 7.1.8 of Section 7.1 is shown. Assume the hypothesis in Theorem 6.3.2 of Chapter 6 is satisfied, then one can consider the signals in time domain as is also illustrated in Figure 7.4. Let $t_c \in \mathbb{R}_+$ be the time instance a next event time, of for example a product release time, i.e. $u_{\mathcal{X}}(k+1)$, has to be computed based on the event domain control law depicted in (7.58). In the time domain the left side of t_c , i.e. $t \leq t_c$, represents the past realization of the trajectory depicted in Figure 7.4,

while the right side of t_c , i.e. $t > t_c$, represents the future realization of the trajectory depicted in the Figure 7.4. Note that from Figure 7.4 it becomes clear that at the

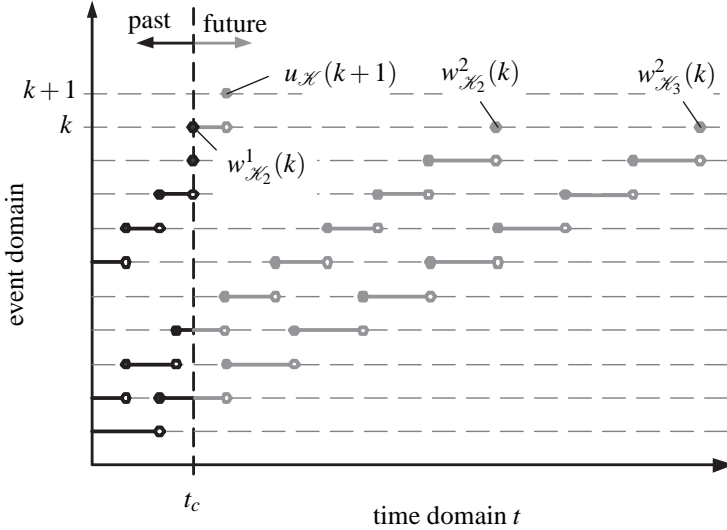

Figure 7.4: Graphical illustration of the causality problem.

time instance a next product release time, i.e. $u_{\mathcal{X}}(k+1)$, has to be computed based on $[w_{\mathcal{X}}(k) \ u_{\mathcal{X}}(k)]^T$, see (7.58), components of $w_{\mathcal{X}}(k)$, e.g. $w_{\mathcal{X}_2}^2(k)$ and $w_{\mathcal{X}_3}^2(k)$, are not necessarily known, i.e. the event times in $w_{\mathcal{X}_2}^2(k)$ and $w_{\mathcal{X}_3}^2(k)$, respectively, are not yet known at time instance t_c . Hence, although an event domain stabilizing controller, i.e. (7.58) can be obtained, one cannot straightforwardly employ the controller in the time domain.

Note that in case of manufacturing lines, like for example the one considered in Example 7.1.8, it is known from a physical point of view that the event times at which a product enters the system for the k th time, i.e. $w_{\mathcal{X}_2}^1(k)$, will always occur before the other events in the system occurring for the k th time. It is this intrinsic physical property of manufacturing lines that leads to the obvious proposal to *reconstruct* the other variables based on information of $w_{\mathcal{X}_2}^1(k)$ that is available at the time instance the controller computation has to be performed. An algorithm which can based on $w_{\mathcal{X}_2}^1(k)$ obtain an *estimate* of the other variables in $w_{\mathcal{X}}(k)$ is therefore required. A proposal on how to design such an algorithm, following an event domain observer design approach, is pointed out in the next section.

7.3 An event domain observer design approach

Consider the following event domain description of a manufacturing system

$$\Sigma_{\mathcal{K}} = (\mathbb{K}, \mathbb{W}_{1\mathcal{K}} \times \mathbb{W}_{2\mathcal{K}}, \mathfrak{B}_{\mathcal{K}}) \quad (7.59)$$

with $\mathbb{K} = \mathbb{Z}$, $\mathbb{W}_{1\mathcal{K}} = \mathbb{R}^{n_1}$ and $\mathbb{W}_{2\mathcal{K}} = \mathbb{R}^{n_2}$ the signal space, and $\mathfrak{B}_{\mathcal{K}} \subseteq \mathbb{W}_{1\mathcal{K}} \times \mathbb{W}_{2\mathcal{K}}$ defined as

$$\mathfrak{B}_{\mathcal{K}} \triangleq \left\{ \begin{array}{l} \left[\begin{array}{c} w_{1\mathcal{K}} \\ w_{2\mathcal{K}} \end{array} \right] : \mathbb{Z} \rightarrow \mathbb{W}_{1\mathcal{K}} \times \mathbb{W}_{2\mathcal{K}} \mid \gamma \left[\begin{array}{c} w_{1\mathcal{K}} \\ w_{2\mathcal{K}} \end{array} \right] \leq \left[\begin{array}{c} w_{1\mathcal{K}} \\ w_{2\mathcal{K}} \end{array} \right], \\ w_{1\mathcal{K}} = \left[\begin{array}{c} u_{\mathcal{K}} \\ y_{\mathcal{K}} \end{array} \right], \quad \left. \begin{array}{l} w_{2\mathcal{K}} = A(\gamma) \otimes w_{2\mathcal{K}} \oplus B(\gamma) \otimes u_{\mathcal{K}} \\ y_{\mathcal{K}} = C(\gamma) \otimes w_{2\mathcal{K}} \end{array} \right\}, \end{array} \right. \quad (7.60)$$

with $A(\gamma) \in \mathbb{R}_{\varepsilon}^{n_2 \times n_2}[\gamma]$, $B \in \mathbb{R}_{\varepsilon}^{n_2 \times \bullet}[\gamma]$ and $C \in \mathbb{R}_{\varepsilon}^{\bullet \times n_2}[\gamma]$. The notation \bullet should be read as ‘‘appropriate dimension’’. In the sequel the operation \otimes will be omitted for notational simplicity purposes. Each element of $\mathfrak{B}_{\mathcal{K}}$ consists of a pair of trajectories $[w_{1\mathcal{K}} \ w_{2\mathcal{K}}]^{\top}$, where

- $w_{1\mathcal{K}}$ represents the *observed* trajectory,
- $w_{2\mathcal{K}}$ represents the *to-be-deduced* trajectory.

The observer design problem in this section then deals with the question how to determine the *to-be-deduced* trajectory based on knowledge of the *observed* trajectory.

Consider the following event domain description

$$\hat{\Sigma}_{\mathcal{K}} = (\mathbb{K}, \mathbb{W}_{1\mathcal{K}} \times \mathbb{W}_{2\mathcal{K}}, \hat{\mathfrak{B}}_{\mathcal{K}}), \quad (7.61)$$

with each element of $\hat{\mathfrak{B}}_{\mathcal{K}}$ consisting of a pair of trajectories $[w_{1\mathcal{K}} \ \hat{w}_{2\mathcal{K}}]^{\top}$, where

- $w_{1\mathcal{K}}$ represents the *observed* trajectory from system (7.59),
- $\hat{w}_{2\mathcal{K}}$ represents an *estimate* of the *to-be-deduced* trajectory $w_{2\mathcal{K}}$.

Definition 7.3.1 Let $[w_{1\mathcal{K}} \ w_{2\mathcal{K}}]^{\top} \in \mathfrak{B}_{\mathcal{K}}^{\text{sub}} \subseteq \mathfrak{B}_{\mathcal{K}}$ with $\mathfrak{B}_{\mathcal{K}}^{\text{sub}} \neq \emptyset$, then system $\hat{\Sigma}_{\mathcal{K}}$, i.e. (7.61), is a dead-beat observer for system $\Sigma_{\mathcal{K}}$, i.e. (7.59), if there exists an event counter $k^* \in \mathbb{Z}$ and a trajectory set $\hat{\mathfrak{B}}_{\mathcal{K}}^{\text{sub}} \subseteq \hat{\mathfrak{B}}_{\mathcal{K}}$ with $\hat{\mathfrak{B}}_{\mathcal{K}}^{\text{sub}} \neq \emptyset$ such that

$$\left\{ \left[\begin{array}{c} w_{1\mathcal{K}} \\ \hat{w}_{2\mathcal{K}} \end{array} \right]^{\top} \in \hat{\mathfrak{B}}_{\mathcal{K}}^{\text{sub}} \subseteq \hat{\mathfrak{B}}_{\mathcal{K}} \right\} \Rightarrow \left\{ \hat{w}_{2\mathcal{K}} = \hat{w}_{2\mathcal{K}} \wedge w_{2\mathcal{K}} \right\}, \quad (7.62)$$

where $\hat{w}_{2\mathcal{K}} \wedge w_{2\mathcal{K}}$ denotes the concatenation at k^* , i.e.

$$(\hat{w}_{2\mathcal{K}} \wedge w_{2\mathcal{K}})(k) \triangleq \begin{cases} \hat{w}_{2\mathcal{K}} & \text{for } k < k^* \\ w_{2\mathcal{K}} & \text{for } k \geq k^*, \end{cases}$$

for all system trajectory $[w_{1\mathcal{K}} \ w_{2\mathcal{K}}]^\top \in \mathfrak{B}_{\mathcal{K}}^{\text{sub}}$.

In observer design is about finding a description for $\hat{\mathfrak{B}}_{\mathcal{K}}$ such that system (7.61) will admit the property as described in Definition 7.3.1. In the sequel a structure or description for $\hat{\mathfrak{B}}_{\mathcal{K}}$ will be proposed that will make that system (7.61) is a dead-beat observer for (7.60) in the sense of Definition 7.3.1.

The following notion will be employed in the dead-beat observer design, i.e.

Definition 7.3.2 Let $\mathfrak{B}_{\mathcal{K}}^{\text{sub}} \subseteq \mathfrak{B}_{\mathcal{K}}$ with $\mathfrak{B}_{\mathcal{K}}^{\text{sub}} \neq \emptyset$. Then, system (7.59) is called *observable* in $\mathfrak{B}_{\mathcal{K}}^{\text{sub}}$ if the following implication holds

$$\left\{ \left[\begin{array}{c} w_{1\mathcal{K}} \\ w_{2\mathcal{K}} \end{array} \right], \left[\begin{array}{c} w_{1\mathcal{K}} \\ w_{2\mathcal{K}} \end{array} \right] \in \mathfrak{B}_{\mathcal{K}}^{\text{sub}} \right\} \Rightarrow \left\{ w_{2\mathcal{K}}^1 = w_{2\mathcal{K}}^2 \right\}. \quad (7.63)$$

The following result can now be formulated:

Theorem 7.3.3 *Let*

$$\mathfrak{B}_{\mathcal{K}}^{\text{sub}} \triangleq \left\{ \left[\begin{array}{c} w_{1\mathcal{K}} \\ w_{2\mathcal{K}} \end{array} \right] : \mathbb{Z} \rightarrow \mathbb{W}_{1\mathcal{K}} \times \mathbb{W}_{2\mathcal{K}} \mid \gamma \left[\begin{array}{c} w_{1\mathcal{K}} \\ w_{2\mathcal{K}} \end{array} \right] \leq \left[\begin{array}{c} w_{1\mathcal{K}} \\ w_{2\mathcal{K}} \end{array} \right], \right. \\ \left. w_{1\mathcal{K}} = \left[\begin{array}{c} u_{\mathcal{K}} \\ y_{\mathcal{K}} \end{array} \right], \quad \left. \begin{array}{l} w_{2\mathcal{K}} = A(\gamma)^* B(\gamma) u_{\mathcal{K}} \\ y_{\mathcal{K}} = C(\gamma) w_{2\mathcal{K}} \end{array} \right\}, \quad (7.64)$$

and

$$\hat{\mathfrak{B}}_{\mathcal{K}}^{\text{sub}} \triangleq \left\{ \left[\begin{array}{c} w_{1\mathcal{K}} \\ \hat{w}_{2\mathcal{K}} \end{array} \right] \in \hat{\mathfrak{B}}_{\mathcal{K}} \mid \hat{w}_{2\mathcal{K}} \leq w_{2\mathcal{K}}, \quad \left[\begin{array}{c} w_{1\mathcal{K}} \\ w_{2\mathcal{K}} \end{array} \right] \in \mathfrak{B}_{\mathcal{K}}^{\text{sub}} \right\}.$$

Suppose system (7.59) is observable in $\mathfrak{B}_{\mathcal{K}}^{\text{sub}}$. Then, system (7.61), with $\hat{\mathfrak{B}}_{\mathcal{K}}$ defined as

$$\hat{\mathfrak{B}}_{\mathcal{K}} \triangleq \left\{ \left[\begin{array}{c} w_{1\mathcal{K}} \\ \hat{w}_{2\mathcal{K}} \end{array} \right] : \mathbb{Z} \rightarrow \mathbb{W}_{1\mathcal{K}} \times \mathbb{W}_{2\mathcal{K}} \mid w_{1\mathcal{K}} = \left[\begin{array}{c} u_{\mathcal{K}} \\ y_{\mathcal{K}} \end{array} \right], \right. \\ \left. \hat{w}_{2\mathcal{K}} = A(\gamma) \hat{w}_{2\mathcal{K}} \oplus B(\gamma) u_{\mathcal{K}} \oplus L(\gamma) (C(\gamma) \hat{w}_{2\mathcal{K}} \oplus y_{\mathcal{K}}) \text{ with } w_{1\mathcal{K}} \in \mathfrak{B}_{\mathcal{K}} \right\}, \quad (7.65)$$

is a dead-beat observer for system (7.59) in the sense of Definition 7.3.1 if

$$(A(\gamma) \oplus L(\gamma)C(\gamma))^* B = A(\gamma)^* B(\gamma) \quad (7.66)$$

is satisfied for a matrix $L(\gamma) \in \mathbb{R}_\varepsilon^{n_2 \times \bullet}[\gamma]$ for which holds $L_{ij}(\gamma) \neq \varepsilon$ for all $i \in \mathbb{Z}_{[1, n_2]}, j \in \mathbb{Z}_{[1, \bullet]}$.

Proof: From the structures of $\mathfrak{B}_{\mathcal{X}}$ and $\mathfrak{B}_{\mathcal{X}}$, defined in (7.65) and (7.60), respectively, it follows that for arbitrary $L(\gamma)$, for which holds $L_{ij}(\gamma) \neq \varepsilon$ for all $i \in \mathbb{Z}_{[1, n_2]}, j \in \mathbb{Z}_{[1, \bullet]}$, the following property holds: If for some $\underline{k} \in \mathbb{Z}$

$$\hat{w}_{2\mathcal{X}}(k) \leq w_{2\mathcal{X}}(k), \quad \text{for } k \leq \underline{k},$$

then there exists an event counter $k^* \in \mathbb{Z}_{>\underline{k}}$ such that

$$\hat{w}_{2\mathcal{X}}(k) \geq w_{2\mathcal{X}}(k), \quad \text{for } k \geq k^*. \quad (7.67)$$

Next, it will be proven that if $L(\gamma)$ is chosen such that it satisfies relation (7.66), then the inequality in (7.67) will hold with equality. Let $\hat{w}_{2\mathcal{X}} \leq w_{2\mathcal{X}}$, i.e.

$$\hat{w}_{2\mathcal{X}} \leq w_{2\mathcal{X}} \Leftrightarrow w_{2\mathcal{X}} = \hat{w}_{2\mathcal{X}} \oplus w_{2\mathcal{X}}, \quad (7.68)$$

which yields

$$\begin{aligned} e_{\mathcal{X}}^{\hat{w}w} &\triangleq \hat{w}_{2\mathcal{X}} \oplus w_{2\mathcal{X}} = \\ &= A(\gamma)\hat{w}_{2\mathcal{X}} \oplus B(\gamma)u_{\mathcal{X}} \oplus L(\gamma)C(\gamma)(\hat{w}_{2\mathcal{X}} \oplus w_{2\mathcal{X}}) \oplus A(\gamma)w_{2\mathcal{X}} \oplus B(\gamma)u_{\mathcal{X}} \quad (7.69) \\ &= (A(\gamma) \oplus L(\gamma)C(\gamma))e_{\mathcal{X}}^{\hat{w}w} \oplus B(\gamma)u_{\mathcal{X}}. \end{aligned}$$

A solution to (7.69) is

$$e_{\mathcal{X}}^{\hat{w}w} = (A(\gamma) \oplus L(\gamma)C(\gamma))^* B(\gamma)u_{\mathcal{X}}. \quad (7.70)$$

Since one has that $w_{2\mathcal{X}} = e_{\mathcal{X}}^{\hat{w}w}$ and that for given $w_{1\mathcal{X}}, w_{2\mathcal{X}}$ the signal $e_{\mathcal{X}}^{\hat{w}w}$ is unique (due to the fact that system (7.59) is observable in $\mathfrak{B}_{\mathcal{X}}^{\text{sub}}$), solution (7.70) is the only solution for the last expression in (7.69). According to the hypothesis in Theorem 7.3.3, the trajectory $w_{2\mathcal{X}}$ from the set of trajectory of interesties, i.e. $\mathfrak{B}_{\mathcal{X}}^{\text{sub}}$, is given by $w_{2\mathcal{X}} = A(\gamma)^* B(\gamma)u_{\mathcal{X}}$. Employing relation (7.70) then yields

$$(A(\gamma) \oplus L(\gamma)C(\gamma))^* B(\gamma)u_{\mathcal{X}} = A(\gamma)^* B(\gamma)u_{\mathcal{X}}, \quad \forall u_{\mathcal{X}}, \quad (7.71)$$

or

$$(A(\gamma) \oplus L(\gamma)C(\gamma))^* B(\gamma) = A(\gamma)^* B(\gamma). \quad (7.72)$$

Hence, choosing $L(\gamma)$ such as described in Theorem 7.3.3 then yields that (7.67) is satisfied with equality, i.e. for some $k^* \in \mathbb{Z}_{>k}$ there holds

$$\hat{w}_{2,\mathcal{X}}(k) = w_{2,\mathcal{X}}(k), \quad \text{for } k \geq k^*. \quad (7.73)$$

This implies that system (7.61), with $\hat{\mathfrak{B}}_{\mathcal{X}}$ defined as in (7.65), is an observer for (7.59) in the sense of Definition 7.3.1 for $\mathfrak{B}_{\mathcal{X}}^{\text{sub}}$ and $\hat{\mathfrak{B}}_{\mathcal{X}}^{\text{sub}}$ as indicated in Theorem 7.3.3. ■

Under the hypothesis in Theorem 7.3.3 system (7.61), with $\hat{\mathfrak{B}}_{\mathcal{X}}$ defined as in (7.65), is a dead-beat observer for system (7.59) if all allowable system trajectories of system (7.59), i.e. $\mathfrak{B}_{\mathcal{X}}$ defined in 7.60, are restricted to the trajectory set $\mathfrak{B}_{\mathcal{X}}^{\text{sub}}$ as defined in (7.64). The physical meaning of this, is that the manufacturing system has once started as an empty system. That is, there has been a time instance that the manufacturing system did not contain any products, i.e. no events have occurred yet. Note that this is a mild assumption in the sense that it is obvious that once the manufacturing system must have started up without any semi-finished or stored products already present in the system.

The issue that is treated next is about how to compute a matrix $L(\gamma) \in \mathbb{R}_\varepsilon^{n_2 \times \bullet}[\gamma]$ such that the conditions on $L(\gamma)$ given in Theorem 7.3.3 are satisfied.

Theorem 7.3.4 *A specific $L(\gamma) \in \mathbb{R}_\varepsilon^{n_2 \times \bullet}[\gamma]$ satisfying (7.66) is given by*

$$L(\gamma) = (A(\gamma)^* \setminus (A(\gamma)^* B(\gamma)) / B(\gamma)) / (C(\gamma) A(\gamma)^*). \quad (7.74)$$

Proof: Note that from the algebraic structure of expression (7.66) one has that for arbitrary $L(\gamma) \in \mathbb{R}_\varepsilon^{n_2 \times \bullet}[\gamma]$ there holds

$$(A(\gamma) \oplus L(\gamma) C(\gamma))^* B(\gamma) \geq A(\gamma)^* B(\gamma), \quad \forall L(\gamma) \in \mathbb{R}_\varepsilon^{n_2 \times \bullet}[\gamma].$$

This implies that searching for the (component wise) largest matrix $L(\gamma)$, for which holds

$$(A(\gamma) \oplus L(\gamma) C(\gamma))^* B(\gamma) \leq A(\gamma)^* B(\gamma), \quad (7.75)$$

will lead to a matrix $L(\gamma)$ for with condition (7.66) in Theorem 7.3.3 is satisfied.

$$\begin{aligned} & (A(\gamma) \oplus L(\gamma) C(\gamma))^* B(\gamma) \leq A(\gamma)^* B(\gamma) \\ \Leftrightarrow & (A(\gamma)^* L(\gamma) C(\gamma))^* A(\gamma)^* B(\gamma) \leq A(\gamma)^* B(\gamma) && \text{(employing (2.3c))} \\ \Leftrightarrow & A(\gamma)^* (L(\gamma) C(\gamma) A(\gamma)^*)^* B(\gamma) \leq A(\gamma)^* B(\gamma) && \text{(employing (2.3b))} \\ \Leftrightarrow & (L(\gamma) C(\gamma) A(\gamma)^*)^* \leq A(\gamma)^* \setminus (A(\gamma)^* B(\gamma)) / B(\gamma) && \text{(employing (2.12c))} \\ \Leftrightarrow & L(\gamma) C(\gamma) A(\gamma)^* \leq A(\gamma)^* \setminus (A(\gamma)^* B(\gamma)) / B(\gamma) && \text{(employing (2.3a))} \\ \Leftrightarrow & L(\gamma) \leq (A(\gamma)^* \setminus (A(\gamma)^* B(\gamma)) / B(\gamma)) / (C(\gamma) A(\gamma)^*) && \text{(employing (2.12b))} \end{aligned} \quad (7.76)$$

The largest $L(\gamma)$ satisfying (7.75) then follows from the last inequality in (7.76) and is given in (7.74) of Theorem 7.3.4. ■

To successfully design an observer as the one proposed in Theorem 7.3.3, observability of system (7.59) in $\mathfrak{B}_{\mathcal{X}}^{\text{sub}}$ is required. In the sequel an observability test is given from which one can conclude that system (7.59) is observable in the sense of Definition 7.3.2.

Theorem 7.3.5 *System (7.59) is observable in $\mathfrak{B}_{\mathcal{X}}^{\text{sub}}$ in the sense of Definition 7.3.2, with $\mathfrak{B}_{\mathcal{X}}^{\text{sub}}$ defined as in (7.64), if and only if the following equality holds true*

$$A(\gamma)^*B(\gamma) = A(\gamma)^*B(\gamma)((C(\gamma)A(\gamma)^*B(\gamma)) \setminus (C(\gamma)A(\gamma)^*B(\gamma))). \quad (7.77)$$

Proof: Can be proven based on the results obtained in [110]. ■

Example 7.3.6 Consider the manufacturing system as considered in Example 7.1.8. The system can be described according to the event domain system description as defined in (7.59) with $\mathfrak{B}_{\mathcal{X}}$ in (7.60) defined by the following matrices and signals

$$A(\gamma) \triangleq \begin{bmatrix} \varepsilon & \varepsilon & \varepsilon & \varepsilon & \varepsilon \\ \varepsilon & d_1\gamma & \varepsilon & \varepsilon & \gamma \\ \varepsilon & d_1d_2\gamma & d_2\gamma & \varepsilon & \varepsilon \\ \varepsilon & \varepsilon & \gamma & \varepsilon & \varepsilon \\ \varepsilon & \varepsilon & \varepsilon & \gamma & \varepsilon \end{bmatrix}, \quad B(\gamma) \triangleq \begin{bmatrix} 0 \\ d_1 \\ d_1d_2 \\ \varepsilon \\ \varepsilon \end{bmatrix}, \quad C(\gamma) \triangleq \begin{bmatrix} 0 & \varepsilon & \varepsilon & \varepsilon & \varepsilon \end{bmatrix},$$

$$w_{1,\mathcal{X}}(k) \triangleq \begin{bmatrix} u_{\mathcal{X}}(k) & w_{\mathcal{X}_2}^1(k) = y_{\mathcal{X}}(k) \end{bmatrix}^{\top},$$

$$w_{2,\mathcal{X}}(k) \triangleq \begin{bmatrix} w_{\mathcal{X}_2}^1(k) & w_{\mathcal{X}_2}^2(k) & w_{\mathcal{X}_3}^2(k) & w_{\mathcal{X}_3}^2(k-1) & w_{\mathcal{X}_3}^2(k-2) \end{bmatrix}^{\top}. \quad (7.78)$$

Note that for notational shortness the operations \otimes in the matrices $A(\gamma)$ and $B(\gamma)$ are omitted, e.g. $d_1d_2\gamma$ in matrix $A(\gamma)$ should be read as $d_1 \otimes d_2 \otimes \gamma$. The goal is to obtain an observer for the manufacturing system of the structure as proposed in Theorem 7.3.3. One can verify, by for example employing the *minmaxgd* toolbox³ for Scilab 4.0, that condition (7.77) in Theorem 7.3.5 is satisfied. With the *minmaxgd* toolbox one can perform analytical computations like star (Kleene star $*$) operations, left and right (pseudo)-inverse (Residuation $\setminus, /$) operations, etc. on the matrices of the form as given in this section. Since the condition in (7.77) is satisfied, one can conclude from Theorem 7.3.3 that system (7.61), with $\mathfrak{B}_{\mathcal{X}}$ defined as in (7.65) and $L(\gamma) \in \mathbb{R}_{\varepsilon}^5[\gamma]$ as in (7.74) of Theorem 7.3.4, is an observer for system (7.59) in the sense of Definition 7.3.1. With the *minmaxgd* toolbox of Scilab 4.0 one can compute

³The *minmaxgd* toolbox for Scilab 4.0 is downloadable from <http://www.istia.univ-angers.fr/hardouin/outils.html>.

$L(\gamma) \in \mathbb{R}_\varepsilon^5[\gamma]$ as defined in (7.74), i.e.

$$L(\gamma) = \begin{bmatrix} 0 \\ 3 \oplus 6\gamma \oplus 9\gamma^2 \oplus 12\gamma^3 \oplus 15\gamma^4 \oplus 18\gamma^5 \oplus 21\gamma^6 \oplus 24\gamma^7 (4\gamma)^* \\ 7(4\gamma)^* \\ 7\gamma(4\gamma)^* \\ 7\gamma^2(4\gamma)^* \end{bmatrix}. \quad (7.79)$$

The example is continued by trying to put the obtained observer in a recursive form. Note that $L(\gamma)$ in (7.79) contains operations working on the signal $\max(\hat{w}_{\mathcal{X}_2}^1, y_{\mathcal{X}})$. Consider for example the first component in $L(\gamma)$, and taking into account the observer structure in $\hat{\mathcal{B}}_{\mathcal{X}}$, one can obtain that

$$\hat{w}_{\mathcal{X}_2}^1(k) = \max(u_{\mathcal{X}}(k), y_{\mathcal{X}}(k), \hat{w}_{\mathcal{X}_2}^1(k)) \quad (7.80)$$

Hence, due to the algebraic loop in above expression it is impossible to put the obtained observer into a recursive form. Therefore the structure of $L(\gamma)$ in (7.79) is slightly altered into the following form

$$L(\gamma) = \begin{bmatrix} \gamma \\ 3 \oplus 6\gamma \oplus 9\gamma^2 \oplus 12\gamma^3 \oplus 15\gamma^4 \oplus 18\gamma^5 \oplus 21\gamma^6 \oplus 24\gamma^7 (4\gamma)^* \\ 7(4\gamma)^* \\ 7\gamma(4\gamma)^* \\ 7\gamma^2(4\gamma)^* \end{bmatrix}. \quad (7.81)$$

One can verify that the $L(\gamma)$ in (7.81), as the one in (7.79), also satisfies (7.66) in Theorem 7.3.3. Hence, the result in Theorem 7.3.3 still applies for the observer defined with the $L(\gamma)$ in (7.81). Note that (7.80) now becomes

$$\hat{w}_{\mathcal{X}_2}^1(k) = \max(u_{\mathcal{X}}(k), y_{\mathcal{X}}(k-1), \hat{w}_{\mathcal{X}_2}^1(k-1)). \quad (7.82)$$

Hence, a recursive equation without algebraic loop is obtained. Note that the terms $(4\gamma)^*$ in (7.81) can be interpreted as a recursive equation of the form

$$x(k) = \max(x(k-1) + 4, \dots), \quad (7.83)$$

where the term that will appear on the dots depends on the terms appearing in front of $(4\gamma)^*$ in (7.81). For more details on this issue the reader is referred to [29]. Define now $x_1(k)$, $x_2(k)$, $x_3(k)$ and $x_4(k)$ to obtain recursive relations, like the one in (7.83), corresponding to the terms $(4\gamma)^*$ in the second up to the last component of $L(\gamma)$ in (7.81), respectively. By taking into account the way the γ operator is defined, one can now obtain the following recursive relation corresponding to the obtained observer in

In the next section the recursion in (7.84) will be employed in combination with the event domain stabilizing controller obtained in Section 7.1 in order to solve the causality problem from which the event domain controller in Section 7.1 suffers if it is implemented in time domain.

7.4 Observer-based output feedback control for manufacturing lines

As explained in Section 7.2, the event domain controller design approach followed in Section 7.1 results in a causality problem when the controller is implement in time domain. Therefore, an observer-based algorithm is proposed which can solve the causality issue encountered when controlling manufacturing lines based on the event domain controller synthesis explained in Section 7.1. Hence, a guaranteed stabilizing and causal controller in time domain is obtained.

Assume Theorem 6.3.2 holds for the considered manufacturing lines. Hence, a time domain representation of the form defined in Definition 6.1.1 can be obtained. Define $y_{\mathcal{G}} : \mathbb{T} \rightarrow \mathbb{Y}_{\mathcal{G}} \triangleq \mathbb{Z}$ as the time domain signal corresponding to the event domain signal $y_{\mathcal{X}}(k)$, which in case of manufacturing lines corresponds to the event times a product enters the manufacturing line for the k th time at the front of the line, i.e. $y_{\mathcal{X}}(k) \triangleq w_{\mathcal{X}_2}^1(k)$ in case of the manufacturing line considered in the Example 7.1.8 and assumed to be defined as the first component of the signal $w_{\mathcal{G}}$ for manufacturing lines of a more general form, i.e. see Definition 6.1.1. Furthermore, it is assumed that the buffer in front of the first machine in the manufacturing line is a buffer which has a capacity for an infinite number of products. Note that this implies that

$$u_{\mathcal{X}}(k) = y_{\mathcal{X}}(k), \quad \forall k \in \mathbb{Z}_+, \quad (7.85)$$

i.e. the k th time a product is released coincides with the k th time a product enters the manufacturing line. This property is required to guarantee that the time instance of the next product release, i.e. $u_{\mathcal{X}}(k+1)$ computed by the event domain controller of Section 7.1, will not be before the time instance the previous product $y_{\mathcal{X}}(k)$ entered the manufacturing line, for this is physically not possible.

Define the signal $y_{\mathcal{G}}^p(t)$ as

$$y_{\mathcal{G}}^p(t) \triangleq y_{\mathcal{G}}(\tau), \quad \tau \in \mathbb{T}_{[t-\delta, t]}, \quad (7.86)$$

for a sufficiently large $\delta \in \mathbb{R}_{>0}$. Note that the signal $y_{\mathcal{G}}^p(t)$ contains, at all times $t \in \mathbb{T}$, past information of $y_{\mathcal{G}}$ over a horizon of δ into the past and is assumed to contain, at least, $n_l \in \mathbb{Z}_{>0}$ event lags. Recall that the event lags contained in a time domain counter function corresponds to the amount of times the corresponding counter function counted a particular event that has occurred.

Let knowledge of $y_{\mathcal{G}}^p(t)$ be available (for feedback) at all times $t \in \mathbb{T}$. Furthermore, suppose that a controller, obtained based on the controller synthesis in Section (7.1), i.e.

$$u_{\mathcal{X}}(k+1) \triangleq \kappa_{\mathcal{X}}([w_{2\mathcal{X}}(k) \ u_{\mathcal{X}}(k)]^\top) \triangleq u_{\mathcal{X}}(k) \oplus \tilde{\kappa}([w_{2\mathcal{X}}(k) \ u_{\mathcal{X}}(k)]^\top), \quad (7.87)$$

and the observer, i.e. recursion (7.84), designed for a manufacturing line, e.g. the manufacturing line in Example 7.3.6, respectively, are given. Then, the following algorithm can be formulated

Algorithm 7.4.1 Let $\chi_0 = 0$ and suppose $y_{\mathcal{G}}^p(t)$ contains at least the number of event lags (n_l) that are contained in $\mathbf{y}_{\mathcal{X}}(k)$ defined in recursion (7.84), i.e. $n_l = 9$ in case of the system considered in Example 7.3.6.

Step 1)

Given the signal $y_{\mathcal{G}}^p(t)$ at time $t \in \mathbb{T}$, wait until $y_{\mathcal{G}}^p(t)(0) - y_{\mathcal{G}}^p(t)(0^-) \geq 1$. If $y_{\mathcal{G}}^p(t)(0) - y_{\mathcal{G}}^p(t)(0^-) \geq 1$, $k = y_{\mathcal{G}}^p(t)(0)$ and

$$\begin{aligned} \mathbf{y}_{\mathcal{X}}(k) &= \boldsymbol{\pi}^y(y_{\mathcal{G}}^p(t)), \\ u_{\mathcal{X}}(k) &= y_{\mathcal{X}}(k), \end{aligned}$$

with

$$\boldsymbol{\pi}^y(y_{\mathcal{G}}^p(t)) \triangleq \inf \left\{ \tau \in \mathbb{T}_{[-\delta, 0]} \mid y_{\mathcal{G}}^p(t)(\tau) \leq k, k \in \mathbb{K}_{[y_{\mathcal{G}}^p(t)(0) - (n_l - 1), y_{\mathcal{G}}^p(t)(0)]} \right\} + t. \quad (7.88)$$

Furthermore, compute

$$\begin{aligned} \chi(k) &= A_{ob} \otimes \chi(k-1) \oplus B_{ob}^u \otimes u_{\mathcal{X}}(k) \oplus B_{ob}^y \otimes \mathbf{y}_{\mathcal{X}}(k), \text{ with } \chi(k-1) = \chi_0 \\ \hat{w}_{2\mathcal{X}}(k) &= C_{ob} \otimes \chi(k) \end{aligned} \quad (7.89)$$

and compute the next event time of a product release, i.e. $u_{\mathcal{X}}(k+1)$, with event domain control law

$$u_{\mathcal{X}}(k+1) \triangleq \kappa_{\mathcal{X}}([\hat{w}_{2\mathcal{X}}(k) \ u_{\mathcal{X}}(k)]^\top), \quad (7.90)$$

where $\kappa_{\mathcal{X}}(\cdot)$ is defined as in (7.87) with $w_{2\mathcal{X}}(k)$ in (7.87) is substituted by $\hat{w}_{2\mathcal{X}}(k)$.

Step 2)

Feed

$$u_{\mathcal{G}}(t) = \begin{cases} k & \text{if } t \in \mathbb{T}_{[u_{\mathcal{X}}(k), u_{\mathcal{X}}(k+1)]}, \\ k+1 & \text{if } t = u_{\mathcal{X}}(k+1), \end{cases} \quad (7.91)$$

as control variable to the manufacturing system and go to Step 1.

Let

$$\mathbb{Y}_{\mathcal{G}}^p \triangleq (\mathbb{T}_{[-\delta,0]} \rightarrow \mathbb{Y}_{\mathcal{G}}), \quad (7.92)$$

then Algorithm (7.4.1) can be seen as a control law of the form

$$\Sigma_{\mathcal{G}}^{\text{MPC}} = (\mathbb{T}, \mathbb{U}_{\mathcal{G}}, \mathbb{Y}_{\mathcal{G}}^p, \mathfrak{B}_{\mathcal{G}}^{\text{MPC}}), \quad (7.93)$$

with

$$\mathfrak{B}_{\mathcal{G}}^{\text{MPC}} \triangleq \left\{ u_{\mathcal{G}} : \mathbb{T} \rightarrow \mathbb{U}_{\mathcal{G}}, y_{\mathcal{G}}^p : \mathbb{T} \rightarrow \mathbb{Y}_{\mathcal{G}}^p \mid u_{\mathcal{G}} \text{ satisfies Algorithm 7.4.1} \right\}. \quad (7.94)$$

The manufacturing line of the form defined in Definition 6.1.1 in closed-loop with Algorithm 7.4.1, i.e. the closed-loop system in time domain, is then given by

$$\Sigma_{\mathcal{G}}^{\text{CL}} = (\mathbb{T}, \mathbb{U}_{\mathcal{G}}, \mathbb{W}_{\mathcal{G}}, \mathbb{Y}_{\mathcal{G}}^p, \mathfrak{B}_{\mathcal{G}}^{\text{CL}}), \quad (7.95)$$

where

$$\begin{aligned} \mathfrak{B}_{\mathcal{G}}^{\text{CL}} \triangleq & \left\{ \left[\begin{array}{ccc} u_{\mathcal{G}}^{\top} & w_{\mathcal{G}}^{\top} & y_{\mathcal{G}}^p \end{array} \right]^{\top} : \mathbb{T} \rightarrow \mathbb{U}_{\mathcal{G}} \times \mathbb{W}_{\mathcal{G}} \times \mathbb{Y}_{\mathcal{G}}^p \mid \left[\begin{array}{cc} u_{\mathcal{G}}^{\top} & y_{\mathcal{G}}^p \end{array} \right]^{\top} \in \mathfrak{B}_{\mathcal{G}}^{\text{MPC}}, \right. \\ & \left. (\sigma^{-t} w_{\mathcal{G}_1})|_{\mathbb{T}_{[-\delta,0]}} = y_{\mathcal{G}}^p, \forall t \in \mathbb{T}, \left[\begin{array}{cc} u_{\mathcal{G}}^{\top} & w_{\mathcal{G}}^{\top} \end{array} \right]^{\top} \in \mathfrak{B}_{\mathcal{G}} \right\}. \end{aligned} \quad (7.96)$$

The following result can now be obtained for the manufacturing lines of the type considered in this section in closed-loop with Algorithm 7.4.1 forming closed-loop system (7.95)

Theorem 7.4.2 *Suppose that for the considered manufacturing line there exist an event domain observer of the form as given in (7.89). Furthermore, let the hypothesis in Theorem 7.1.7 be satisfied. Then, the event domain closed-loop system corresponding to the time domain closed-loop system (7.95) is **stable** in the sense of Definition 7.1.2.*

Proof: Define the event domain observer error as

$$e_{\mathcal{X}}(k) \triangleq w_{2\mathcal{X}}(k) - \hat{w}_{2\mathcal{X}}(k). \quad (7.97)$$

Substitution of (7.97) in the control law (7.87), that is employed in Algorithm 7.4.1, yields

$$u_{\mathcal{X}}(k+1) \triangleq \kappa_{\mathcal{X}}([w_{2\mathcal{X}}(k) + e_{\mathcal{X}}(k) \ u_{\mathcal{X}}(k)]^{\top}). \quad (7.98)$$

Then due to the result in Theorem 7.1.5 the statement in Theorem 7.4.2 follows. \blacksquare

Example 7.4.3 Algorithm 7.4.1 is employed to the manufacturing line considered in Example 7.1.8 to achieve the control goal as formulated in Example 7.1.8. In Example 7.1.8 it is shown how an event domain controller, i.e. (7.87) is designed such that the result in Theorem 7.1.7 applies. In Example 7.3.6 an observer for the manufacturing line from Example 7.1.8, resulting in recursion (7.84), is designed. A simulation result of the manufacturing line in closed-loop with Algorithm 7.4.1 resulting in closed-loop system (7.95) is given in Figure 7.5 the response of the closed-loop system trajectory $q_{\mathcal{F}} = w_{\mathcal{F}_3}^2$ and $u_{\mathcal{H}}$ are presented and compared to the desired reference trajectory $q_{\mathcal{F}}^r$. At $t = 52$ [units] Algorithm 7.4.1 is switched on. Hence, the trajectory $q_{\mathcal{F}}$ converges to the desired trajectory $q_{\mathcal{F}}^r$. Furthermore, in Figure 7.6 one can see that the event domain observer error defined as in (7.97) goes to zero.

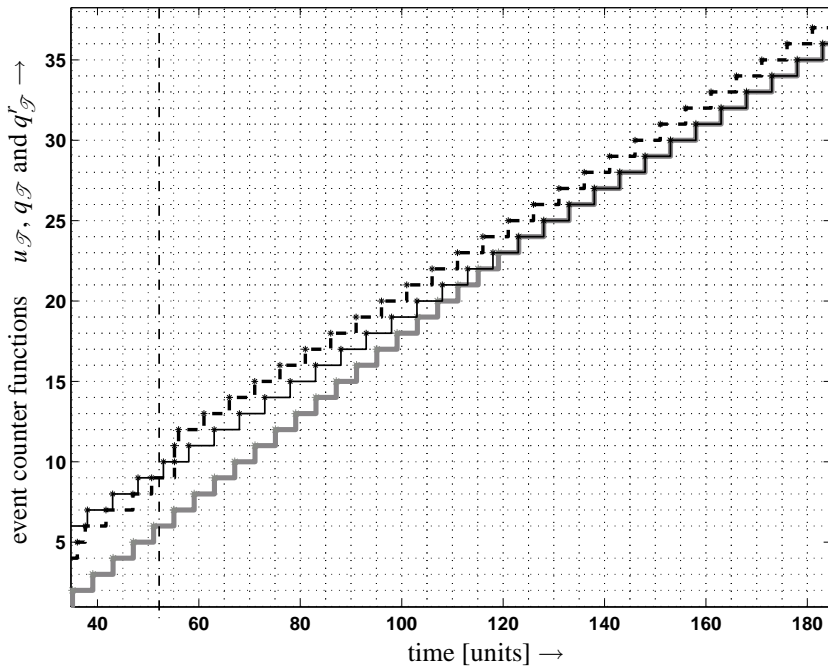

Figure 7.5: In the figure the trajectory $q_{\mathcal{F}}(t) = w_{\mathcal{F}_3}^2(t)$ (solid thick grey) and the control $u_{\mathcal{H}}(t)$ (dashed black) of the closed-loop system (7.96) are presented and compared to the desired reference trajectory $q_{\mathcal{F}}^r(t)$ (solid black).

The example as just illustrated shows how event domain model predictive controller synthesis resulting in an event domain controller structure, that cannot be implemented in time domain due to a causality problem, can be employed in time domain by using

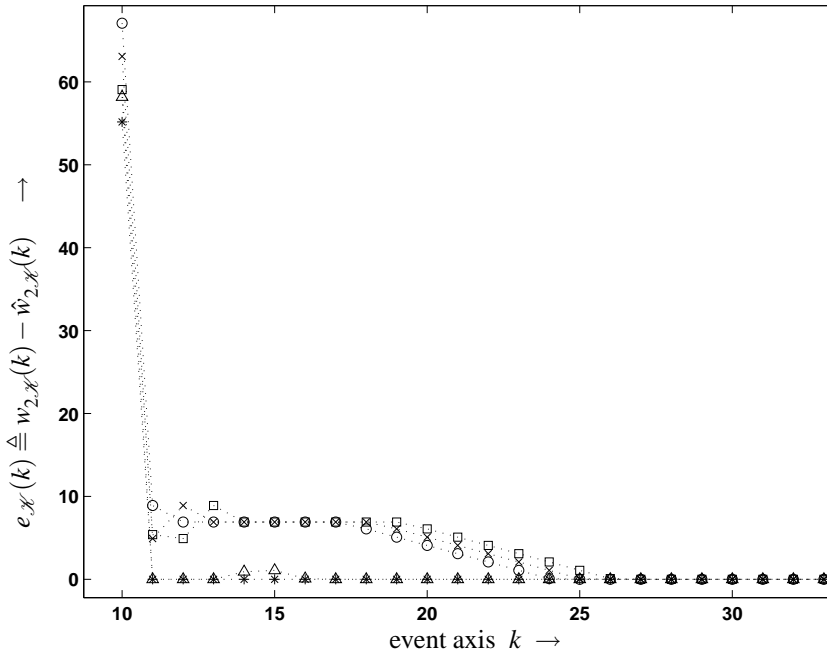

Figure 7.6: Event domain observer error plotted along the event axis $w_{2\mathcal{X}}(k) - \hat{w}_{2\mathcal{X}}(k)$. The first up to the last component of the event domain observer error are denoted by $(*)$, (\wedge) , (\circ) , (\times) and (\square) , respectively.

an observer based approach. This resulted in Algorithm 7.4.1. At the time instance a controller computation has to be made the observer *estimates*, based on the currently available information, the required (future) information that is required in the event domain control law (7.87). Note that as is the case of “conventional controllers” Algorithm 7.4.1 does not perform computation at fixed equidistant time instances. For Algorithm 7.4.1 it is only required to perform computations if “something happens” in the system. That is, every time a new product is entering the manufacturing line, which is the case if $y_{\mathcal{G}}^p(t)(0) - y_{\mathcal{G}}^p(t)(0^-) \geq 1$, a new controller computation is performed.

7.5 Summary

To facilitate stability analysis, in this chapter a model predictive control setup for discrete-event manufacturing systems is formulated in event domain. Since in the event domain the description of the manufacturing system dynamics can be described as difference equations (as is shown in Chapter 6) this approach allows one to employ

”conventional” discrete-time stability analysis of the resulting event domain closed-loop system. It is shown that the approach leads to a constructive approach to design event domain controllers that are robustly stabilizing in the event domain. However, a disadvantage of this approach is that the obtained controllers cannot straightforwardly be employed in the time domain due to a causality problem that emerges. It is pointed out how in case of manufacturing lines this causality problem can be taken care of by using an observer. For this purpose a dead-beat observer design methodology, for the class of manufacturing systems that can be described in the event domain by max plus linear relations, is developed.

*All truth are easy to understand
once they are discovered; the
point is to discover them.*

Galileo Galilei



Conclusions and future research

In this chapter a summary of the contributions of the thesis is presented. Also some open problems and possible future directions that are related to the research presented in this thesis are given.

8.1 Conclusions

Recall from the introductory chapter of this thesis that the main focus of the dissertation is

1. The development of computationally friendly robust model predictive control techniques for a class of nonlinear hybrid systems suitable for manufacturing system control;
2. The development of observer-based output feedback model predictive control techniques for nonlinear systems;
3. The development of model predictive control techniques for discrete-event manufacturing systems.

The main contributions of this thesis can be summarized below.

Robust nonlinear (hybrid) model predictive control

- An approach to design a sub-optimal nonlinear (hybrid) model predictive control algorithm with an a priori input-to-state stability guarantee, with respect to additive disturbances, of the closed-loop system is presented. For the nonlinear model predictive controller, the input-to-state stabilization constraints can be written as a finite number of *linear* inequalities. This fact facilitates, under

some additional assumptions on the model predictive control costs, the possibility to obtain a computationally cheap nonlinear (hybrid) model predictive control algorithm.

- Robust performance of the closed-loop system, perturbed by additive disturbances, can be obtained by modifying the afore mentioned control scheme. This can be achieved by allowing for on-line optimization of the ISS-gain of the closed-loop system. A small ISS-gain of the closed-loop system, perturbed by additive disturbances, yields additive disturbance *rejection* which results in improved performance.
- Proposals to reduce conservativeness of the proposed model predictive control algorithm are given.

General robustness results for discrete-time nonlinear constrained systems

- It has been shown that state feedback laws that can render a closed-loop system input-to-state stable with respect to *additive disturbances* can also render the same closed-loop system input-to-state stable with respect to *state measurement errors* and *additive disturbances*. For the obtained result continuity of the system dynamics with respect to the *state* of the system is required, however, continuity with respect to the system's control variable is *not* required. Under the additional assumption of continuity of the system dynamics with respect to the control variable, also robustness with respect to actuator noise can be established. Hence, it has been shown that under mild conditions state feedback laws that can render a closed-loop system input-to-state stable with respect to *additive disturbances* can also render the same closed-loop system input-to-state stable with respect to *state measurement errors*, *additive disturbances* and *actuator noise*. The results allow for possible discontinuity and set-valuedness of the state feedback laws. Furthermore, the result holds in the possible presence of control and state constraints. The value of the obtained robustness result will become clear from the next item.
- It has been shown how the robustness result can be employed to utilize nonlinear model predictive controller design techniques that can render a closed-loop system input-to-state stable with respect to additive disturbances, in a scenario where a closed-loop system has to be rendered input-to-state stable with respect to state measurement errors (and actuator noise). In literature many results are available that render model predictive controlled closed-loop systems input-to-state stable with respect to additive disturbances. However, only few results are

known to render the model predictive controlled closed-loop systems input-to-state stable with respect to measurement errors (and actuator noise). This fact indicates the value of the robustness result mentioned in the previous item.

Output feedback nonlinear model predictive control

- An observer-based output feedback nonlinear predictive control approach for the class of strongly observable nonlinear discrete-time systems is proposed. It is proven that a *separately* designed controller and observer in closed-loop with the to-be-controlled system result in an asymptotically stable closed-loop system. Input to-state stability notions for differential inclusions are employed to prove the results.
- Constructive procedures for both the design of an input-to-state stable state feedback model predictive controller and a nonlinear observer, are indicated.
- All the results are valid despite the possibility of discontinuous and non-unique model predictive control laws.

The main contributions of this thesis with respect to model predictive controller design for manufacturing systems can be divided into two parts. That is:

1. Fluid model based model predictive control design for manufacturing systems; The discrete-event nature of the manufacturing system is approximated by (piece-wise) continuous dynamical models. Hence the product streams through the manufacturing systems are considered as fluid streams resulting in dynamical fluid models for manufacturing systems. The model predictive control design is based on these fluid models of the discrete-event manufacturing system.
2. Discrete-event based model predictive control design for manufacturing systems; The model predictive control design is directly based on a discrete-event model of the discrete-event manufacturing system.

Fluid model based model predictive control design for manufacturing systems

- It is illustrated how input-to-state stabilizing model predictive control with robust performance can be employed to solve a large scale manufacturing control problem, that possibly exhibits discontinuous hybrid behaviors, in an efficient *decentralized* manner.

- Due to the fact that the fluid models for controller synthesis are (piecewise) continuous and the actual to-be-controlled manufacturing system has a discrete-event nature a quantization (or compatibility) problem is introduced. It is indicated how robustness results can be employed to synthesize model predictive controllers based on fluid models of manufacturing systems to cope with the compatibility issues between fluid models of manufacturing systems and the actual discrete-event nature of the real life manufacturing systems.
- For a class of nonlinear manufacturing systems a model predictive control approach that establishes tracking behavior of the closed-loop system for a class of reference trajectory, which can typically correspond to customer demands over time, is developed.

Discrete-event based model predictive control design for manufacturing systems

- It has been shown that complementary to time domain modeling of manufacturing systems the discrete-event nature of manufacturing systems enables to model manufacturing systems from the so called *event domain* perspective. It is shown that in contrast to relatively complex time domain models, that are obtained when modeling manufacturing systems, event domain modeling facilitates obtaining relatively simple (analytical) difference equations as descriptions of discrete-event manufacturing systems.
- A relation between event domain modeling and the time domain modeling of a class of event driven manufacturing systems has been obtained. This result opens possibilities to employ the relatively simple event domain models to do controller synthesis and perform computations for manufacturing systems controlled in the time domain.
- For a class of discrete-event manufacturing systems it has been shown, by utilizing the relation between event- and time domain, that the continuous time model predictive control problem can be solved (without approximations) by a finite dimensional optimization problem.
- For discrete-event systems that can be described in the event domain as maximum linear systems a (dead-beat) observer design methodology is proposed.
- An output feedback stabilizing (MPC) tracking controller for a class of discrete-event manufacturing systems is proposed.

8.2 Directions for future research

Some possible suggestions for future research in relation to the topics listed in the previous section are given in this section.

Robust nonlinear (hybrid) model predictive control

- For a given additive disturbance set, find ways to estimate a priori the region of attraction, i.e. a robust positive invariant set of the to-be-controlled system in closed-loop with the proposed input-to-state stabilizing model predictive control algorithm.

General robustness results for discrete-time nonlinear constrained systems

- It has been shown how state feedback laws that can render a closed-loop system input-to-state stable with respect to *additive disturbances* can be transformed into state feedbacks that can render the same closed-loop system input-to-state stable with respect to state *measurement errors* and *additive disturbances* (and *actuator noise*). Generalization of the robustness result for more general classes of (discontinuous with respect to the state) nonlinear discrete-time systems is recommended for future research.

Output feedback nonlinear model predictive control

- Search for less conservative small gain conditions which can, possibly, always be satisfied irrespective of an a priori given input-to-state stable state feedback nonlinear model predictive controller.
- Explore the possibilities to drop the *regularity* assumption on the controller. Since, a tight regularity constraint might impose restrictions on the (constrained) stabilizability of the to-be-controlled system, no regularity requirement on the controller will lead to improved feasibility of the model predictive control problem.
- Extend the obtained asymptotic stability result of the closed-loop system to a stronger input-to-state stability result. That is, establish input-to-state stability of the closed-loop system perturbed by *output measurement errors* as disturbance input. This will be useful to conclude about robustness to *output measurement noise* which is always present in a practical situation.
- More research on the development of observer theories that can handle a *hybrid* model structure needs to be performed, while in particular in the context of manufacturing systems hybrid model structures are encountered.

Fluid model based model predictive control design for manufacturing systems

- More research on *decentralized* model predictive controller design has to be performed such that controller design becomes simpler and controller computations become tractable for large scale manufacturing systems.
- Investigate ways to quantify the quantization errors induced by the fact that discrete-event manufacturing systems are controlled by controllers which are synthesized based on dynamical fluid models of those manufacturing systems.

Discrete-event based model predictive control design for manufacturing systems

- Extend the local convergence result for the proposed (dead-beat) discrete-event observer to a global result.
- Extend the proposed output feedback stabilizing (MPC) tracking controller for discrete-event manufacturing lines to the multiple input/output case.

Some more suggestions for future research, that are not directly related to one of the afore mentioned topics, are listed in the sequel.

- It has been shown how state feedback laws that can render the closed-loop system input-to-state stable with respect to *additive* disturbances can be transformed into state feedbacks that can render the closed-loop system input-to-state stable with respect to state *measurement errors* (and *actuator noise*). The result applies to a class of input and state constrained nonlinear discrete-time systems. To explore the possibility to obtain a similar robustness result for continuous-time nonlinear systems is an interesting subject for future research.
- Investigation on implementation aspects of the developed control strategies in industrial environments needs to be performed more thoroughly.
- Perform research in which the existing heuristic methods for the control of manufacturing systems, such as material requirements planning (MRP) and just-in-time production (JIT), are compared to the manufacturing control strategies that are proposed in this thesis.
- Perform research on how (hybrid) control theory can contribute in solving manufacturing *scheduling* problems.

Bibliography

- [1] E. S. Buffa and R. K. Sarin, *Modern Production/Operations Management*. New York: John Wiley & Sons, 1987.
- [2] W. J. Hopp and M. L. Spearman, *Factory Physics*. Irwin/McGraw-Hill, 2000.
- [3] H. P. Wiendahl and F. Hyhuis, "Analysis and control of manufacturing process of job shop production by a new input-output-method," in *Proceedings of Conference on Machine Control Systems*, Brighton, UK, 1984.
- [4] J. D. C. Little, "A proof for the queuing formula $L = \lambda \times w$," *Operation Research*, vol. 9, pp. 383–387, 1961.
- [5] H. P. Wiendahl, *Load-oriented Manufacturing*. Heidelberg: Verlag, 1995.
- [6] R. B. Chase and N. J. Aquilano, *Production & operations management*. Boston: Richard D. Irwin, Inc, 1992.
- [7] P. J. Ramadge and W. M. Wonham, "Supervisory control of a class of discrete-event systems," *SIAM Journal on Control and Optimization*, vol. 25, no. 1, pp. 206–230, 1987.
- [8] C. E. Garcia, D. M. Prett, and M. Morari, "Model predictive control: theory and practice," *Automatica*, vol. 25, no. 3, pp. 335–348, May 1989.
- [9] D. Q. Mayne, J. B. Rawlings, C. V. Rao, and P. O. M. Scokaert, "Constrained model predictive control: stability and optimality," *Automatica*, vol. 36, no. 6, pp. 789–814, June 2000.
- [10] S. J. Qin and T. A. Badgwell, "A survey of industrial model predictive control technology," *Control Engineering Practice*, vol. 11, no. 7, pp. 733–764, July 2003.
- [11] R. Findeisen, L. Imsland, F. Allgöwer, and B. A. Foss, "State and output feed-back nonlinear model predictive control: an overview," *European Journal of Control*, vol. 9, pp. 190–207, 2003.
- [12] E. F. Camacho and C. Bordons, *Model Predictive Control*. London: Springer-Verlag, 2004.
- [13] J. A. Richalet, A. Rault, J. Testud, and J. Papon, "Model predictive heuristic control: applications to an industrial process," *Automatica*, vol. 14, no. 5, pp. 413–428, September 1978.
- [14] C. R. Cutler and B. L. Ramaker, "Dynamic matrix control - a computer control algorithm," in *Proceedings of the Joint Automatic Control Conference*, San Francisco, USA, 1980.

- [15] E. Mosca, G. Zappa, and C. Manfredi, "Multistep horizon self-tuning controllers," in *Proceedings of the 9th IFAC World Conference*, Budapest, Hungary, 1984.
- [16] R. M. C. D. Keyser and A. R. van Cauwenberghe, "Extended prediction self-adaptive control," in *Proceedings of the IFAC Symposium on Identification and System Parameter Estimation*, York, U.K., 1985, pp. 1255–1260.
- [17] D. W. Clarke, C. Mohtadi, and P. S. Tuffs, "Generalized predictive control: I - the basic algorithm and II - extensions and interpretations," *Automatica*, vol. 23, no. 2, pp. 137–160, March 1987.
- [18] R. Soeterboek, *Predictive Control - A Unified Approach*. Prentice-Hall, 1992.
- [19] S. S. Keerthi and E. G. Gilbert, "Optimal infinite horizon feedback laws for a general class of constrained discrete time systems: stability and moving-horizon approximations," *Journal of Optimization Theory and Applications*, vol. 57, no. 2, pp. 265–293, 1988.
- [20] H. Michalska and D. Q. Mayne, "Robust receding horizon control of constrained nonlinear systems," *IEEE Transactions on Automatic Control*, vol. 38, no. 11, pp. 1623–1633, November 1993.
- [21] H. Chen and F. Allgöwer, "A quasi-infinite horizon predictive control scheme for constrained nonlinear systems," in *Proceedings of the 16th Chinese Control Conference*, Quindao, China, 1996, pp. 309–316.
- [22] L. Magni, G. De Nicolao, L. Magnani, and R. Scattolini, "A stabilizing model-based predictive control algorithm for nonlinear systems," *Automatica*, vol. 37, no. 9, pp. 1351–1362, September 2001.
- [23] G. Grimm, M. J. Messina, S. Tuna, and A. R. Teel, "Model predictive control: for want of a local control Lyapunov function, all is not lost," *IEEE Transactions on Automatic Control*, vol. 50, no. 5, pp. 546–558, May 2005.
- [24] A. Bemporad and M. Morari, "Control of systems integrating logic, dynamics, and constraints," *Automatica*, vol. 35, no. 3, pp. 407–427, March 1999.
- [25] M. Lazar, *Model Predictive Control of Hybrid Systems: Stability and Robustness*. Ph.D. thesis, Department of Electrical Engineering, Technische Universiteit Eindhoven, The Netherlands, 2006.
- [26] C. G. Cassandras and S. Lafortune, *Introduction to Discrete Event Systems*. Kluwer Academic Publishers, 1999.
- [27] D. A. van Beek and J. Rooda, "Languages and applications in hybrid modelling and simulation: positioning of Chi," *Control Engineering Practice*, vol. 8, no. 1, pp. 81–91, July 2000.

- [28] D. A. van Beek, K. Man, M. Reniers, J. Rooda, and R. Schiffelers, "Syntax and consistent equation semantics of hybrid Chi," *Journal of Logic and Algebraic Programming*, vol. 68, no. 1-2, pp. 129–210, June-July 2006.
- [29] F. Baccelli, G. Cohen, G. Olsder, and J. Quadrat, *Synchronization and Linearity: An Algebra For Discrete Event Systems*. New York: Wiley, 1992.
- [30] B. De Schutter, *Max-Algebraic System Theory for Discrete Event Systems*. Ph.D. thesis, Faculty of Applied Sciences, K.U. Leuven, Leuven, Belgium, 1996.
- [31] B. Heidergott, G. J. Olsder, and J. van der Woude, *Max Plus at Work: Modeling and Analysis of Synchronized Systems: A Course on Max-Plus Algebra and Its Applications*. Princeton University Press, 2006.
- [32] C. G. Cassandras, Y. Wardi, B. Melamed, S. G., and C. Panayiotou, "Perturbation analysis for online control and optimization of stochastic fluid models," *IEEE Transactions on Automatic Control*, vol. 47, no. 8, pp. 1234–1248, August 2002.
- [33] D. Armbruster, D. Marthaler, and C. Ringhofer, "Kinetic and fluid models hierarchies for supply chains," *SIAM Journal on Multiscale Modeling and Simulation*, vol. 2, no. 1, pp. 43–61, 2004.
- [34] A. A. J. Lefeber, R. A. van den Berg, and J. Rooda, *Modelling manufacturing systems for control: a validation study*, in *Networks of interacting machines: production organization in complex industrial systems and biological cells*; Editors: D. Armbruster, K. Kaneko, A.S. Mikhailov. World Scientific, Book Chapter ISBN 981-256-498-5, 2005.
- [35] R. A. van den Berg, A. A. J. Lefeber, and J. Rooda, "Modeling and control of a manufacturing flow line using partial differential equations," *to appear in IEEE Transactions on Control Systems Technology*, 2007.
- [36] D. Liberzon, "Quantization, time delays, and nonlinear stabilization," *IEEE Transactions on Automatic Control*, vol. 51, no. 7, pp. 1190–1195, July 2006.
- [37] E. K. Boukas, "Manufacturing systems: LMI approach," *IEEE Transactions on Automatic Control*, vol. 51, no. 6, pp. 1014–1018, June 2006.
- [38] A. M. Lyapunov, *Problème gèneral de la stabilitè du mouvement*. Princeton University Press, 1947, report of the French translation in 1907 of the Russian memoire dated 1892.
-

- [39] R. E. Kalman and J. E. Bertram, "Control system analysis and design via the second method of Lyapunov, II: Discrete-time systems," *Transactions of the ASME, Journal of Basic Engineering*, vol. 82, pp. 394–400, 1960.
- [40] E. D. Sontag, "Smooth stabilization implies coprime factorization," *IEEE Transactions on Automatic Control*, vol. 34, no. 4, pp. 435–443, April 1989.
- [41] Z. P. Jiang and Y. Wang, "Input-to-state stability for discrete-time nonlinear systems," *Automatica*, vol. 37, no. 6, pp. 857–869, June 2001.
- [42] G. Grimm, M. J. Messina, S. E. Tuna, and A. R. Teel, "Nominally robust model predictive control with state constraints," in *Proceedings of the 42nd IEEE Conference on Decision and Control*, Maui, Hawaii, USA, December 2003, pp. 1413–1418.
- [43] M. Lazar, B. J. P. Roset, W. P. M. H. Heemels, H. Nijmeijer, and P. P. J. van den Bosch, "Input-to-state stabilizing sub-optimal nonlinear MPC algorithms with an application to DC-DC converters," in *Proceedings of the IFAC Workshop on Nonlinear Model Predictive Control for Fast Systems*, Grenoble, France, October 2006.
- [44] M. Lazar, W. P. M. H. Heemels, B. J. P. Roset, H. Nijmeijer, and P. P. J. van den Bosch, "Input-to-state stabilizing sub-optimal NMPC with an application to DC-DC converters," *To appear in International Journal of Robust and Nonlinear Control*, 2007.
- [45] D. Limon, T. Alamo, F. Salas, and E. F. Camacho, "Input-to-state stability of min-max MPC controllers for nonlinear systems with bounded uncertainties," *Automatica*, vol. 42, no. 5, pp. 797–803, May 2006.
- [46] D. Limon, T. Alamo, and E. F. Camacho, "Input-to-state stable MPC for constrained discrete-time nonlinear systems with bounded additive uncertainties," in *Proceedings of the 41st IEEE Conference on Decision and Control*, Las Vegas, Nevada, USA, December 2002, pp. 4619–4624.
- [47] L. Magni, D. M. Raimondo, and R. Scattolini, "Regional input-to-state stability for nonlinear model predictive control," *IEEE Transactions on Automatic Control*, vol. 51, no. 9, pp. 1548–1553, September 2006.
- [48] B. J. P. Roset, W. P. M. H. Heemels, M. Lazar, and H. Nijmeijer, "On robustness to measurement errors for constrained discrete-time systems," 2007, Accepted for publication in *Automatica*.
- [49] B. J. P. Roset, M. Lazar, W. P. M. H. Heemels, and H. Nijmeijer, "Design of stabilizing output feedback nonlinear model predictive controllers with an application to DC-DC converters," in *Proceedings of the European Control Conference*, Kos, Greece, July 2007, pp. 2999–3004.

- [50] B. J. P. Roset and H. Nijmeijer, "Observer based model predictive control," *International Journal of Control*, vol. 77, no. 17, pp. 1452–1462, November 2004.
- [51] B. J. P. Roset, M. Lazar, W. P. M. H. Heemels, and H. Nijmeijer, "Stabilizing output feedback nonlinear model predictive control: an extended observer approach," 2006, Submitted to a journal.
- [52] B. J. P. Roset, M. Lazar, H. Nijmeijer, and W. P. M. H. Heemels, "A stabilizing output based nonlinear model predictive control scheme," in *Proceedings of the 45th IEEE Conference on Decision and Control*, San Diego, United States, December 2006, pp. 4627–4632.
- [53] B. J. P. Roset and H. Nijmeijer, "Observer based model predictive control," in *Proceedings of the 6th IFAC-Symposium on Nonlinear Control Systems* (invited paper), Stuttgart, Germany, August 2004, pp. 1037–1042.
- [54] B. J. P. Roset, H. Nijmeijer, J. van Eekelen, A. Lefeber, and J. Rooda, "Event driven manufacturing systems as time domain control systems," in *Proceedings of the 44th IEEE Conference on Decision and Control*, Sevilla, Spain, December 2005, pp. 446–451.
- [55] J. van Eekelen, A. Lefeber, J. Rooda, B. J. P. Roset, and H. Nijmeijer, "Control of manufacturing systems using state feedback and linear programming," in *Proceedings of the 44th IEEE Conference on Decision and Control*, Sevilla, Spain, December 2005, pp. 4652–4657.
- [56] R. Cuninghame-Green, *Minmax Algebra*, in *Lecture Notes in Economics and Mathematical Systems*. Berlin: Springer-Verlag, 1979, vol. 166.
- [57] T. Li, "The stability problem in difference equations," *Acta Mathematica*, vol. 63, pp. 99–141, 1934, in German.
- [58] W. Hahn, "On the application of the method of Lyapunov to difference equations," *Mathematische Annalen*, vol. 136, no. 5, pp. 403–441, 1958, in German.
- [59] ———, *Stability Of Motion*. Berlin: Springer-Verlag, 1967.
- [60] P. O. M. Scokaert, J. B. Rawlings, and E. S. Meadows, "Discrete-time stability with perturbations: application to model predictive control," *Automatica*, vol. 33, no. 3, pp. 463–470, March 1997.
- [61] E. D. Sontag, "Further facts about input-to-state stabilization," *IEEE Transactions on Automatic Control*, vol. 35, no. 4, pp. 473–476, April 1990.
-

- [62] E. D. Sontag and Y. Wang, "On characterization of the input-to-state stability property," *Systems & Control Letters*, vol. 24, no. 5, pp. 351–359, April 1995.
- [63] ———, "New characterizations of the input-to-state property," *IEEE Transactions on Automatic Control*, vol. 41, no. 9, pp. 1283–1294, September 1996.
- [64] E. D. Sontag, *The ISS philosophy as a unifying framework for stability-like behavior*, in *Lecture Notes in Control and Information Sciences*, 2000, vol. 259.
- [65] Z. P. Jiang and Y. Wang, "A converse Lyapunov theorem for discrete-time systems with disturbances," *Systems & Control Letters*, vol. 45, no. 1, pp. 49–58, January 2002.
- [66] Z. P. Jiang, Y. Lin, and W. Y., "Nonlinear small-gain theorems for discrete-time feedback systems and applications," *Automatica*, vol. 40, no. 12, pp. 2129–2136, 2004.
- [67] P. O. M. Sokaert, D. Q. Mayne, and J. B. Rawlings, "Suboptimal model predictive control (feasibility implies stability)," *IEEE Transactions on Automatic Control*, vol. 44, no. 3, pp. 648–654, March 1999.
- [68] S. S. Keerthi and E. G. Gilbert, "An existence theorem for discrete-time infinite-horizon optimal control problems," *IEEE Transactions on Automatic Control*, vol. 30, no. 9, pp. 907–909, September 1985.
- [69] L. Magni, G. De Nicolao, and R. Scattolini, "Output feedback receding-horizon control of discrete-time nonlinear systems," in *Proceedings of the IFAC Nonlinear Systems Design Symposium*, Enschede, Netherlands, July 1998, pp. 422–427.
- [70] J. H. Lee and Z. Yu, "Worst-case formulations of model predictive control for systems with bounded parameters," *Automatica*, vol. 33, no. 5, pp. 763–781, May 1997.
- [71] D. Q. Mayne, "Control of constrained dynamic systems," *European Journal of Control*, vol. 7, pp. 87–99, 2001.
- [72] L. Magni, G. De Nicolao, R. Scattolini, and F. Allgöwer, "Robust model predictive control for nonlinear discrete-time systems," *International Journal of Robust and Nonlinear Control*, vol. 13, no. 3-4, pp. 229–246, 2003.
- [73] E. C. Kerrigan and J. M. Maciejowski, "On robust optimization and the optimal control of constrained linear systems with bounded state disturbance," in *Proceedings of the European Control Conference*, Cambridge, UK, September 2003.

- [74] A. Bemporad, "A predictive controller with artificial Lyapunov function for linear systems with input/state constraints," *Automatica*, vol. 34, no. 10, pp. 1255–1260, October 1998.
- [75] J. A. Primbs, V. Nevistic, and J. C. Doyle, "A receding horizon generalization of pointwise min-norm controllers," *IEEE Transactions on Automatic Control*, vol. 45, no. 5, pp. 898–909, May 2000.
- [76] E. D. Sontag, "A Lyapunov-like characterization of asymptotic controlability," *SIAM Journal on Control and Optimization*, vol. 21, no. 3, pp. 462–471, 1983.
- [77] P. Mhaskar, N. H. El-Farra, and P. D. Christofides, "Stabilization of nonlinear systems with state and control constraints using Lyapunov-based predictive control," in *Proceedings of the American Control Conference*, Portland, Oregon, USA, June 2005, pp. 828–833.
- [78] W. Heemels, B. De Schutter, and A. Bemporad, "Equivalence of hybrid dynamical models," *Automatica*, vol. 37, pp. 1085–1091, July 2001.
- [79] A. Bemporad, G. Ferrari-Trecate, and M. Morari, "Observability and controllability of piecewise affine and hybrid systems," *IEEE Transactions on Automatic Control*, vol. 45, no. 10, pp. 1864–1876, October 2000.
- [80] S. V. Raković, E. Kerrigan, D. Q. Mayne, and J. Lygeros, "Reachability analysis of discrete-time systems with disturbances," *IEEE Transactions on Automatic Control*, vol. 51, no. 4, pp. 546–561, April 2006.
- [81] D. Tipper and M. Sundareshan, "Numerical methods for modeling computer networks under nonstationary conditions," *Journal on Selected Areas in Communications*, vol. 8, no. 9, pp. 1682–1695, December 1990.
- [82] C. Agnew, "Dynamic modeling and control of congestion-prone systems," *Operations Research*, vol. 24, no. 3, pp. 400–419, May 1976.
- [83] A. Pitsillides, P. Ioannou, and L. Rossides, "Congestion control for differentiated services using non-linear control theory," in *Proceedings of the 6th IEEE Symposium on Computers and Communications*, Hammamet, Tunisia, 2001, pp. 726–733.
- [84] V. Guffens, G. Bastin, and H. Mounier, "Hop-by-hop congestion control with token buckets in feedback: compartmental analysis and experimental validation with UML," *Technical Report, Center for Systems Engineering and Applied Mechanics (CESAME), Université Catholique de Louvain, Belgium*, July 2003.
-

- [85] A. Lefeber, "Nonlinear models for control of manufacturing systems," in *4th International Symposium on Investigations of Nonlinear Dynamic effects in Production Systems*, Chemnitz, Germany, 2003.
- [86] N. U. Prabhu, *Fundations of Queueing Theory*. Kluwer Academic Publisher, 1997.
- [87] R. A. Freeman and P. V. Kokotović, "Global robustness of nonlinear systems to state measurement disturbances," in *Proceedings of the 32nd IEEE Conference on Decision and Control*, San Antonio, USA, December 1993, pp. 1507–1512.
- [88] M. J. Messina, S. E. Tuna, and A. R. Teel, "Discrete-time certainty equivalence output feedback: allowing discontinuous control laws including those from model predictive control," *Automatica*, vol. 41, no. 4, pp. 617–628, April 2005.
- [89] D. Q. Mayne, S. V. Raković, R. Findeisen, and F. Allgöwer, "Robust output feedback model predictive control of constrained linear systems," *Automatica*, vol. 42, pp. 1217–1222, 2006.
- [90] D. Kazakos and J. Tsiniias, "The input-to-state stability condition and global stabilization of discrete-time systems," *IEEE Transactions on Automatic Control*, vol. 39, pp. 2111–2113, 1994.
- [91] G. Grimm, M. J. Messina, S. E. Tuna, and A. R. Teel, "Examples of zero robustness in constrained model predictive control," in *Proceedings of the 42nd IEEE Conference on Decision and Control*, Maui, Hawaii, USA, December 2003, pp. 3724–3729.
- [92] G. Grimm, M. J. Messina, S. E. Tuna, and A. Teel, "Examples when nonlinear model predictive control is nonrobust," *Automatica*, vol. 40, no. 10, pp. 1729–1738, October 2004.
- [93] R. Findeisen, L. Imsland, F. Allgöwer, and B. A. Foss, "Output feedback stabilization of constrained systems with nonlinear model predictive control," *International Journal of Robust and Nonlinear Control*, vol. 23, pp. 211–227, 2003.
- [94] J. W. Grizzle and P. Moraal, "Newton, observers and nonlinear discrete-time control," in *Proceedings of the 29th IEEE Conference on Decision and Control*, Honolulu, Hawaii, USA, December 1990, pp. 760–767.
- [95] T. Lilge, "On observer design for non-linear discrete-time systems," *European Journal of Control*, vol. 4, pp. 306–319, August 1998.

-
- [96] —, *Zum Entwurf Nicht Linearer Zeitdiskreter Beobachter Mittels Normalform*. Fortschr. -Ber. VDI Reihe 8 Hr. 752. Düsseldorf, 1999, in German.
- [97] H. Nijmeijer and A. van der Schaft, *Nonlinear Dynamical Control Systems*. New York: Springer-Verlag, 1990.
- [98] H. Keller, “Non-linear observer design by transformation into a generalized observer canonical form,” *International Journal of Control*, vol. 46, no. 6, pp. 1915–1930, 1987.
- [99] W. Lin and C. I. Byrnes, “Remarks on linearization of discrete-time autonomous systems and nonlinear observer design,” *System & Control Letters*, vol. 25, no. 1, pp. 31–40, May 1995.
- [100] H. Nijmeijer, “Observability of autonomous discrete time nonlinear systems: a geometric approach,” *International Journal of Control*, vol. 36, pp. 867–874, 1982.
- [101] W. M. Boothby, *An Introduction to Differentiable Manifolds and Riemannian Geometry*. Academic Press, 1986.
- [102] A. Bemporad, “Reducing conservativeness in predictive control of constrained systems with disturbances,” in *Proceedings of the 37th IEEE Conference on Decision and Control*, Tampa, Florida, USA, December 1998, pp. 1384–1389.
- [103] B. Cottenceau, L. Hardouin, and J. Boimond, “Model reference control for timed event graphs in dioids,” *Automatica*, vol. 37, no. 9, pp. 1451–1458, September 2001.
- [104] C. A. Maia, L. Hardouin, R. Santos-Mendes, and B. Cottenceau, “Optimal closed-loop control of timed event graphs in dioid,” *IEEE Transactions on Automatic Control*, vol. 48, no. 12, pp. 2284–2287, December 2003.
- [105] B. Schutter and T. van den Boom, “Model predictive control for max-plus-linear discrete event systems,” *Automatica*, vol. 37, no. 7, pp. 1049–1056, July 2001.
- [106] J. C. Willems, “Paradigms and puzzles in the theory of dynamical systems,” *IEEE Transactions on Automatic Control*, vol. 36, no. 3, pp. 259–294, March 1991.
- [107] B. De Schutter and T. J. J. van den Boom, “Model predictive control for max-min-plus-scaling systems - efficient implementation,” in *Proceedings of the 6th International Workshop on Discrete Event Systems (WODES'02)*, Zaragoza, Spain, October 2002, pp. 343–348.
-

BIBLIOGRAPHY

- [108] J. P. LaSalle, *The Stability and Control of Discrete Process*. New York: Springer, 1986.
- [109] I. Necoara, *Model Predictive Control for Piecewise Affine and Max-Plus-Linear Systems*. Ph.D. thesis, Delft Center for Systems and Control, Technische Universiteit Delft, The Netherlands, 2006.
- [110] G. Cohen, S. Gaubert, and J. Quadrat, "Kernels, images and projections in dioids," in *Proceedings of the WODES'96*, Edinburgh, Scotland, UK, August 1996.

Summary

This thesis considers manufacturing systems and model-based controller design, as well as their combinations. The objective of a manufacturing system is to create products from a selected group of raw materials and semifinished goods. In the field of manufacturing systems control is an important issue appearing at various operation levels. At the level of fabrication, for example, control is necessary in order to assure properly working production processes such that products are being fabricated in the desired way. At a higher level in the hierarchy of manufacturing system control, the product *streams* through the system are controlled in order to satisfy, for example, customer demands in an optimal way. Here, the definition of optimal can be interpreted in various ways, such as “with the least possible costs in terms of money” or “in the shortest possible time”. In this research, the attention is focussed on this higher hierarchy level of manufacturing system control.

In the literature, many heuristic methods have been developed for the control of a manufacturing system. Nowadays, some heuristic methods are still being used in combination with operator experience for management of resources and planning of production. However, as the complexity of the manufacturing systems increases rapidly, the (simple) heuristic methods and operator experience will at some point become incapable of finding an optimal control strategy.

In this dissertation the potential of considering manufacturing system control from a control systems point of view is investigated. The ultimate goal of the research is to eventually obtain a more constructive way to address controller design for manufacturing systems. One control strategy from control systems theory, on which is in particularly focused in this research, is a model-based receding horizon control strategy, known in literature as Model Predictive Control (MPC). Since in manufacturing systems a lot of physical system *constraints* are involved, like for example *finite* machine process capacities, *finite* product storage capacities, *finite* product arrival rates, etc., the capability for a manufacturing control strategy to handle those constraints is a necessity. One of the key features of model predictive control is the capability of handling constraints in the controller design. This is one of the major motivations to investigate the model predictive control principle as a control strategy for manufacturing systems. Other issues that are important and that the model predictive control design methodology can handle is to enforce optimality, to introduce feedback, and the capability of allowing for mixed continuous and discrete model structures. The later are typically encountered when models of manufacturing systems are derived.

The main results that are obtained in this dissertation and that are relevant in the context of manufacturing systems control, but are certainly also relevant beyond this field are:

- One has developed an robust computationally friendly nonlinear model predictive control algorithm that can handle model structures with mixed continuous and discrete dynamics. The algorithm can be designed for additive disturbance rejection purposes;
- Robustness (with respect to measurement noise) results that are in particular of interest in the field of nonlinear model predictive control are obtained;
- An asymptotically stabilizing output based nonlinear model predictive control scheme for a class of nonlinear discrete-time systems is developed.

Results that are relevant in the context of manufacturing systems control are:

- It is illustrated how the afore mentioned developed robust computationally friendly nonlinear model predictive control algorithm can be employed to solve a large scale manufacturing control problem in an efficient *decentralized* manner;
- The relation between the so-called event domain modeling approaches for a class of discrete-event manufacturing systems to time domain models is derived. This results enables one to solve seemingly untractable time domain formulated optimal control problems for a class of manufacturing systems in a tractable manner;
- An observer theory for a class of discrete-event manufacturing systems is developed.

Samenvatting

In dit proefschrift worden fabricagesystemen en model-gebaseerd regelaar ontwerp en hun combinatie beschouwd. Het doel van een fabricage systeem is het creëren van producten uit een geselecteerde groep van ruwe materialen en half fabriekaten. In de wereld van de fabricagesystemen speelt regelen op allerlei verschillende niveaus van operatie een belangrijke rol. Op het niveau van product fabricage is regelen bijvoorbeeld noodzakelijk om te kunnen garanderen dat de productie processen de te produceren producten volgens de gewenste specificaties produceren. Op een hoger niveau in de hiërarchie van het regelen van fabricagesystemen worden de product *stromen* door het systeem geregeld om bijvoorbeeld op een optimale manier aan het product vraag patroon van de klanten te kunnen voldoen. De definitie van optimaal kan hier op verschillende manieren geïnterpreteerd worden, zoals “met zo laag mogelijke kosten in termen van geld” of “in een zo kort mogelijk tijd bestek”. In dit onderzoek, ligt de nadruk op het regelen van fabricagesystemen op het zo net genoemde hiërarchisch hoger liggende niveau.

In de literatuur zijn veel ontwikkelde heuristieken en ad hoc methoden ontwikkeld voor het regelen van fabricagesystemen. Vandaag de dag worden sommige van deze heuristieken nog steeds gebruikt voor het management and plannen van product stromen door een fabriek. Maar omdat de complexiteit van fabricagesystemen snel toeneemt, zijn de (eenvoudige) heuristieken niet meer toereikend om optimaliteit te kunnen garanderen.

In deze dissertatie wordt de potentie om voor het regelen van fabricagesystemen een systeem regeltechnische aanpak te kiezen onderzocht. Het doel van dit onderzoek is om uiteindelijk een meer structurele en theoretisch onderbouwde aanpak voor het regelaar ontwerp met betrekking tot fabricagesystemen te ontwikkelen. Een van de regelstrategieën bekend vanuit de systeem theory, waarop is gefocuseerd in het onderzoek, is een modelgebaseerde regel strategie ook wel bekend in de literatuur als Model Predictive Control (MPC). Omdat men in het geval van fabricagesystemen veelal met fysische systeem *beperkingen* (constraints) temaken heeft, zoals bijvoorbeeld *eindige* machine of process capaciteiten, *eindige* product opslag mogelijkheden, *eindige* product aankomst snelheden, enzovoort, moet een goede regelaar voor het regelen van fabricagesystemen ook met deze systeem beperkingen kunnen omgaan. Een van de eigenschappen van de MPC regelstrategie is dat systeem beperkingen, zoals net genoemd, op een elegante manier kunnen worden verdisconteerd in het regelaar ontwerp. Dit is een van de voornaamste redenen om de MPC regelstrategie met betrekking tot fabricagesystemen te onderzoeken. Andere belangrijke punten die de MPC regelstrategie biedt zijn, het afdwingen van optimaliteit, het induceren van een terugkoppel mechanisme en de mogelijkheid om met een combinatie van zowel continue als dis-

crete (hybride) model structuren te kunnen omgaan. De als laatst genoemde model structuur komt men typisch tegen als men mathematische modellen afleidt voor fabricagesystemen.

De belangrijkste resultaten die uit het onderzoek naar voren zijn gekomen en die relevant zijn met betrekking tot het regelen van fabricagesystemen, maar die zeker ook relevant zijn voor het regeltechnische vakgebied in een wat meer algemene zin zijn:

- Er is een robuust en niet reken intensief niet-lineair MPC algoritme, dat kan omgaan met model structuren die een combinatie zijn van zowel continue als discrete (hybride) dynamica, ontwikkeld. Het algoritme kan ontworpen worden om verstoringen onderdrukking te garanderen;
- Robuustheids resultaten met betrekking tot meetruis zijn verkregen. Deze robuustheids resultaten zijn met name interessant met betrekking tot het niet-lineaire MPC vakgebied;
- Er is een asymptotisch stabiliseerbare uitgang gebaseerde niet-lineair MPC algoritme ontwikkeld voor een klasse van niet-lineaire discrete-tijd systemen.

Resultaten die relevant zijn in de context van het regelen van fabricagesystemen zijn:

- Er is geïllustreert hoe de zo net genoemde ontwikkelde robust en niet reken intensief niet-lineair MPC algoritme kan worden toegepast om een regel probleem voor een grootschalig fabricagesysteem op een efficiënte gedecentralizeerde manier op te lossen;
- Er is een relatie gevonden tussen het zo genoemde event domein modelleren van een klasse van discrete-event fabricagesystemen en tijddomein modellen. Dit resultaat maakt het mogelijk om een tijdsdomein formulering van een optimaal regel probleem voor een klasse van faricagesystemen, dat niet te traceren lijkt in het tijdsdomain, op te lossen op een efficiënte en traceerbare manier met behulp van het event domein;
- Een waarnemer theory voor een klasse van discrete-event fabricagesystemen is ontwikkeld.

Acknowledgements

At the end of this thesis I thank the people who have contributed in one way or the other to the work presented in this thesis. The people that I want to thank in particular are given in the sequel.

First of all, I like to thank my first and second promotor Prof. Henk Nijmeijer and Prof. Koos Rooda, who created the possibility for me to perform four year research, which resulted in this Ph.D. thesis. My gratitude goes to Henk Nijmeijer for his courses, and patience while coaching me. Furthermore, I would like to thank my copromotor Dr. Kanat Çamlıbel for his comments on the thesis, but above all for giving me the freedom that I needed to complete the thesis.

I would like to express my gratitude to my second promotor Prof. Koos Rooda and the members of the core committee Prof. Frank Allgöwer, Prof. Paul van den Bosch and Prof. Hans Hellendoorn for their time to read my thesis and giving valuable comments.

A word of gratitude goes to Joost van Eekelen, Dr. Erjen Lefeber, Dr. Mircea Lazar and Dr. Maurice Heemels for their constructive cooperation on our papers. In particular I thank Maurice Heemels for our discussions and to help me in converting my drafts into more precise (mathematical) formulations.

Many thanks to my room mates Joost van Eekelen and Roel van den Berg for the many laughs and ironical jokes we had. I wish you guys a lot of success in finalizing your “boekje!”. Furthermore, I thank Frans Soers and Henk van Rooy for the koffie.

Thank you Wendy for the beautiful moments that we shared together and you having taught me to appreciate and enjoy the “small” things in life.

At last, but not least, I would like to thank my family and in particular my parents who created a privileged starting position for me in life.

Propositions

1. Sub-optimal nonlinear model predictive controllers with good disturbance rejection properties can be employed to solve a large scale manufacturing control problem in an efficient decentralized manner. *[This thesis, Chapter 3]*
2. It is well known that for linear systems under linear state feedback the following statement holds: Input-to-state stability with respect to additive disturbances implies input-to-state stability with respect to state measurement noise. This statement also holds for discrete-time nonlinear systems that are continuous with respect to the state and that are controlled by a set-valued nonlinear state feedback law that is allowed to be discontinuous.
[This thesis, Chapter 4]
3. A non-causal structure of state observers does not have to be a major obstruction in certainty equivalence output feedback model predictive control.
[This thesis, Chapter 5]
4. Although discrete-event manufacturing systems possess discontinuous behavior in the time domain, a class of them can be described by continuous system equations in the event domain. *[This thesis, Chapter 6 and 7]*
5. Although the optimization problem that results from a continuous-time formulated model predictive control problem with finite prediction horizon is an infinite dimensional problem in general, it can be converted to a finite dimensional optimization problem for a class of discrete-event systems.
[This thesis, Chapter 6]
6. A non-causal feedback control law which is robust to measurement errors can be employed in combination with an anticipating observer resulting in successful certainty equivalence output feedback control. *[This thesis, Chapter 7]*
7. A lot of judgement/review systems are not aware that: “Not everything that can be counted counts, and not everything that counts can be counted.”
8. A picture says more than thousand words but a formula says more than a picture.
9. From the proof of a statement one learns more than the statement itself.
10. Understanding what is not possible is as important as understanding what is possible.
11. To some extent we are all slaves of society.

12. Talent is like a marksman who hits a target that others cannot reach; genius is like the marksman who hits a target others cannot even see. This explains why it is likely that the by society rejected homeless man sleeping under that bridge is actually a genius.

Bas Roset

Eindhoven, July 2007

Curriculum vitea

Bas obtained his BSc-degree and MSc-degree in 1999 and 2002 in Mechanical Engineering from Hogeschool West Brabant and Technische Universiteit Eindhoven, respectively. In 2003 he started working towards a Phd-degree at the Department of Mechanical Engineering of the Technische Universiteit Eindhoven in the research group Dynamics and Control. He participated in the DISC (Dutch Institute of Systems and Control) course program from which he in 2004 successfully obtained his course certificate.