

young cities

Developing Urban Energy Efficiency
Tehrān-Karaj

07

Young Cities Research Paper Series, Volume 07

New Towns—Promises Towards Sustainable Urban Form

From "Shushtar-No" to
"Shahre Javan Community"

Mohammad Reza Shirazi



New Towns—Promises Towards Sustainable Urban Form

From "Shushtar-No" to "Shahre Javan Community"

Young Cities Research Paper Series, Volume 07

Mohammad Reza Shirazi



Young Cities Research Paper Series, Volume 07

Edited by Technische Universität Berlin and
Road, Housing & Urban Development Research Center, Tehran

German-Iranian Research Project

Young Cities

Developing Energy-Efficient Urban Fabric in the Tehran-Karaj Region

Contact Germany

Young Cities Project Center
Technische Universität Berlin
Secr. A 66
Straße des 17. Juni 152
10623 Berlin | Germany
www.youngcities.org

Contact Iran

BHRC Road, Housing & Urban
Development Research Center
P.O. Box 13145-1696
Sheikh Fazlollah Noori Highway
Tehran | Islamic Republic of Iran
www.bhrc.ac.ir

Series editor in chief Holger Ohlenburg

Proofreading Jennifer Helfrich

Design/Typesetting büro-d | Communication Design Berlin

Publisher

Universitätsverlag der TU Berlin
Universitätsbibliothek
Fasanenstr. 88
10623 Berlin | Germany
www.univerlag.tu-berlin.de

BHRC
P.O. Box 13145-1696
Sheikh Fazlollah Noori Highway
Tehran | Islamic Republic of Iran
www.bhrc.ac.ir

ISSN 2193-6099 (Print)

ISBN 978-600-5392-63-0

ISSN 2193-6102 (Online)

ISBN 978-3-7983-2512-8 (Print)

ISBN 978-3-7983-2513-5 (Online)

*Also published online on the Digital Repository
of the Technische Universität Berlin*

URL <http://opus.kobv.de/tuberlin/volltexte/2013/3911/>

URN <urn:nbn:de:kobv:83-opus-39119>

[<http://nbn-resolving.de/urn:nbn:de:kobv:83-opus-39119>]

All texts based on scientific research by the Young Cities project.
All pictures, tables and graphics are courtesy of the respective article's
authors despite any other courtesy is indicated.

© 2013 All rights reserved by the Technische Universität Berlin.

Young Cities Research Paper Series

Editors: Rudolf Schäfer, Farshad Nasrollahi, Holger Ohlenburg,
Cornelia Saalmann, Florian Stellmacher

List of Volumes

01 Accomplishments and Objectives (in Farsi)

*Rudolf Schäfer, Tayebeh Parhizkar, Farshad Nasrollahi,
Holger Ohlenburg, Ghazal Raheb, Florian Stellmacher (Eds.)*

02 Accomplishments and Objectives (in English)

*Rudolf Schäfer, Farshad Nasrollahi, Holger Ohlenburg,
Florian Stellmacher (Eds.)*

03 The Shahre Javan Community Detailed Plan

Elke Pahl-Weber, Sebastian Seelig, Holger Ohlenburg (Eds.)

04 Energy Efficient Housing for Iran

*Farshad Nasrollahi, Philipp Wehage, Effatolsadat Shahriari,
Abbas Tarkashvand*

05 Urban Challenges and Urban Design

*Elke Pahl-Weber, Sebastian Seelig, Holger Ohlenburg,
Nadine Kuhla von Bergmann (Eds.)*

06 Construction Competencies and Building Quality

Bernd Mahrin, Johannes Meyser (Eds.)

07 New Towns—Promises Towards Sustainable Urban Form

Mohammad Reza Shirazi

Bibliographic information published by the Deutsche Nationalbibliothek
The Deutsche Nationalbibliothek lists this publication in the Deutsche
Nationalbibliografie; detailed bibliographic data are available in the
Internet at <http://dnb.dnb.de>

Acknowledgments

This publication is the result of generous support by the Young Cities Project, particularly Professor Pahl-Weber as head of the Team “Urban Development and Design”.

In fall 2010, during my travel to study some works of Kamran Diba in Ahvaz and Shushtar, Iran, I visited the Shushtar New Town (Shushtar-No) complex. Designed and only partially implemented some 35 years ago, the future of Shushtar-No is vulnerable despite its progressive ideas and architecture, leading me to be curious about the reasons behind its current disastrous condition. There were some observable commonalities between this project and the Shahre Javan Community Pilot Project in Hashtgerd, part of a research project conducted at TU Berlin in a close cooperation with Iranian partners and different TU- or Berlin-based chairs and research institutes. Thus I decided to present my observations in a Jour Fixe meeting with the members of the project. The project members showed great interest and curiosity in internationally designed and realized residential complexes from around the world, and I was commissioned by Professor Pahl-Weber to develop my report into a research study. The results of this study are now presented as a separate volume in the Young Cities Research Paper Series.

For the publication of this book, I am grateful to Professor Pahl-Weber who provided me with suggestive and helpful comments and kindly agreed to write a preface for this book. I am also thankful to the Project Center and Professor Schäfer, as well as to the editorial of the Young Cities Research Paper Series, foremost Holger Ohlenburg whose support and comments helped me a great deal. A special thanks goes to Phillip Wehage and Sebastian Seelig who both read the manuscript, giving me helpful suggestions and feedback. Last but not least, I am grateful to Kamran Diba for giving permission to reproduce pictures of his works in this book.

M. Reza Shirazi

Berlin, October 2012

The German side of the Young Cities project is partly funded by German Federal Ministry of Education and Research (BMBF).



SPONSORED BY THE

Federal Ministry
of Education
and Research

Table of Contents

Preface	10
<i>E. Pahl-Weber</i>	
I Introduction	12
II Shushtar-No—Background, Vision, and Reality	18
1 Shushtar-No: Background	20
1.1 Shushtar-No, General Feature	20
1.2 Architect	21
1.3 Architect's Architectural Thinking	22
1.4 Dominant Housing and Construction Trends of the Time	24
2 Shushtar-No: Vision, Concept and Spatial Configuration	26
2.1 Source of Architectural Inspiration	26
2.2 Urban Layout	27
2.3 Compact Urban Form	30
2.4 Housing Layout.	31
2.5 Courtyard Prototype	33
2.6 Social Integrity	35
2.7 Environmental Adaptation.	38
2.8 Local, Middle-Technology	39
2.9 Controlled Vehicular Traffic	39
2.10 Green Space.	40
3 Shushtar-No: Reality	42
4 Conclusion: Obstacles of Idealization	46
III Hashtgerd New Town—Background, Vision, and Reality	48
1 New Towns in Iran, Challenges and Opportunities	50
2 Hashtgerd New Town, Vision and Planning	53
3 Hashtgerd New Town, Reality	58
4 Conclusion: The Fragile Future of Hashtgerd New Town	62

IV	Shahre Javan Community—Background and Vision	64
1	Background	66
2	Young Cities Project	67
3	Shahre Javan Community: Objectives and Goals	69
4	Shahre Javan Community: Thematic Review of the Vision	71
4.1	Source of Architectural and Urban Inspiration	71
4.2	Urban Layout	72
4.3	Compact Urban Form	73
4.4	Mixed Land Use	74
4.5	Housing Typology	74
4.6	Climate Sensitivity	77
4.7	Appropriated Technology	78
4.9	Mobility	80
4.10	Landscape Planning	82
V	Comparative Analysis	86
1	Introductory Remarks: A Contextual Overview	88
2	Climate Sensitive Design	90
3	Low-rise, High-density Urban Form	91
4	Housing Typologies	93
5	Mixed Land Use	95
6	Landscape Planning and Greenery	96
7	Car-free Environment	97
8	Appropriated Technology	99
9	Target Group and Actual User	100
VI	Concluding Remarks—Perspectives and Challenges	102
1	Physical Challenges	104
2	Management Challenges	107
3	Towards the Shahre Javan Community Trust	109
VII	References, Project Profiles, Figures, Tables, and Abbreviations	114

Preface

Can New Towns serve as a relief for megacities? This question has historical roots in urban development and has become very meaningful for the future development of megacities. The International New Towns Institute held a conference in December 2012 called ‘New Towns | New Territories’ which addressed new cities in a very literal way and discussed innovative models of urban development practice (INTI 2013). This question has also been addressed in research projects on future megacities in the region of Tehran and Karaj. Iran has a long history of New Town development. The actual question is: how to develop a New Town that is energy-efficient, affordable, and attractive? One of the main obstacles of New Town development is that people prefer living in the older, larger towns.

One way to deal with this question is to analyze the main elements of an existing New Town, examining both the planning strategies and urban design. This is the contribution of the BMBF funded research project “Young Cities—Developing Urban Energy Efficiency”.

“The establishment of new towns in Iran goes back to the 1930s with sporadic examples, but it was institutionalized in the late 1980s with the establishment of the ‘New Towns Development Corporation’ [NTDC] by the Ministry of Housing and Urban Development. The NTDC has already built 20 new towns in a relatively short period” (Etessam 2005, p. 8). New Town development had been seen as an answer to the challenge of fast growing urban centers. A comparison between British and Iranian development of New Towns ends with the conclusion that “building new towns has been a historical trend, to colonize land, to develop an alternative and to manage growth. As we have also seen, there are successes and failures associated with this approach. It can create local social integration, it can be a vehicle for managing growth and social distinctions, while also generating wider social fragmentation. It can be a short-term solution, while

in the long term it can also become a problem itself if not given proper services and maintenance” (Madanipour 2005, p. 80).

It is a scientific challenge to compare two New Towns developed in very different contexts, with different political systems, urbanization patterns, resource efficiency challenges, and cultures. The criteria for the comparative analysis must be applicable, the context must be explored. In his post-doc work in the research team for urban planning and ar-

chitecture, M. Reza Shirazi frames his comparison around the following aspects: climate sensitive design, low-rise high-density urban design, housing typologies and mixed use designations, landscape planning and mobility, the target group and the actual users.

Whether New Towns can be a relief for fast growing megacities has not yet been answered. Yet this comparative analysis reveals the development and basic needs of the New Towns approach. The examples do not include elements of new government or participation, both of which could help turn New Towns into homes for new inhabitants. However, the comparison is able to demonstrate that these developments did not fail completely.

“Satellite new towns have also been created in Korea and are being used in China to help manage rapid urbanization. The original garden city image has been altered in these newer planned communities by the introduction of elevator buildings, but curving streets and informal building arrangements are still sometimes used“ (Barnett 2011, p.143). The alteration of the garden city image is crucial for the understanding of New Town development in Iran: green and open space in a semi arid climate zone is a challenge. The comparative analysis shows that there are basic differences between the New Towns. The actual solution in the Shahre Javan Community is made possible by an integrated approach to development and planning. Integrating water management with water supply and applying innovative grey water reuse systems makes it possible to develop an urban structure with green spaces which both to enhances the local climate conditions and creates an attractive living environment. Both New Towns take advantage of mixed-use concepts, a crucial point for energy-efficiency. One does so in the traditional, separative way, and the other does so through an integrative approach. Energy and resource efficient urbanism will need the integrated development of mixed-use structures in the future even more than today.

The concept for the Shahre Javan Community shows that integrated urban development can not only serve as a model for New Town development, it can also serve as a model for the development of existing towns and even for megacities.

Elke Pahl-Weber

I

Introduction



Introduction

Building new towns and settlements has a long history in Iran, this land is an ancient dwelling place and has been a center for urbanization. After the Macedonian conquest of Iran and the Seleucid rule (330–250 BC) more than 400 new towns were built, influenced by the polis-state type (Habibi 2007). During the Sassanid Dynasty (224–641 AD), new towns were erected for both military as well as agricultural purposes, in a systematic administrative framework. This continued after the Arab conquest of the 7th century, when the conquerors built their new settlements directly beside existing Iranian towns for security reasons, these neighboring settlements were later unified into fully integrated cities, as in the case of Isfahan (Madanipour 2005).

However, the modern incarnation of new towns wasn't realized until the beginning of the 20th century with the process of industrialization and the establishment of the modern state. Three major forms of new towns in Iran— independent, satellite, and continuous— were planned and realized during four major periods. First is the period between the two world wars, when towns were constructed either for political-military purposes (Zahedan) or economic reasons (Noshahr). After the Second World War and up until 1960, rapid development of the oil industry led new towns to be planned and developed adjacent to the extraction or refinery sites, in order to house those involved in these economic activities—this is the case with Naft-e-sefid, Abadan, and Mahshahr. In the third phase, from 1960 to 1979, oil revenue was pumped into industrial and economic activities, as the result of which the residential demand increased dramatically. Two major forces encouraged this: on the one side the flux of immigration to the big cities encouraged establishment of massive residential constructions within or in the periphery of the cities; on the other, new residential units were required to house the employees of

big companies and industries, such as in Pulad-shahr and Shushtar-No [Shushtar New Town]¹ (Ziari 2009; Ziari 2004; Arjmandnia 1999).

After the Islamic Revolution in 1979, industrial and economic development of the country ground to a halt due to instability and the 8 year Iran-Iraq war. Despite this, the pace of urbanization and urban growth continued to intensify, with the revolutionary government supporting the poor and the growing trend of the rural migration to major cities, to

the extent that, by 1996 more than 60 percent of the population lived in cities. To address this development a new generation of new towns were planned. In 1986, the government approved construction of 12, later growing to 28, new towns around major cities to provide affordable accommodation for low-income families and to mitigate the concentration process. Hashtgerd New Town, as the largest satellite city near Tehran, 65 km to the west was planned to accommodate 500,000 inhabitants (Peykadeh 2008).

The “Young Cities Project” (explained in further detail in chapter IV) conducted by a multidisciplinary research group at Technische Universität Berlin in cooperation with the Building and Housing Research Center (BHRC) of Iran, was provided by NTDC with a site at Hashtgerd New Town to serve as a base for introducing an efficient and sustainable urban fabric into the Tehran-Karaj Region. The ideas and findings of the Young Cities Project have been incorporated into the so-called Shahre Javan Community Pilot Project as a residential neighborhood for about 8,000 inhabitants, with all relevant commercial, official, and cultural services, and is intended for implementation in the future. As introduced by this project, this 45 ha area “has been chosen as the central demonstration area for the exploration of energy and resource efficient, climate responsive solutions for urban form, architecture, landscape and transportation planning, water and energy management, as well as consideration of environmental assessment, and public participation” (Seelig, Ohlenburg, Pahl-Weber 2012b, p.12).

This book intends to present a comparative study between this progressive and innovative project and the Aga Khan Award winning complex of Shushtar-No, designed by Kamran Diba and partly realized some 35 years ago. Given the similarities between the two projects in terms of concept and configuration, and taking into account the fact that Shushtar-No, despite its conceptual and architectural richness, faces numerous problems in its current unpleasant condition (explained in detail later), a comparative study could discover the challenges which Shahre Javan Community Pilot Project may face after its realization, and thus encourage policy-makers and urban managers to take strategic, policy-related decisions to guarantee a more secure future for the project.

This study consists of six chapters. After this introductory chapter, the second chapter focuses on the Shushtar-No project. General features of Shushtar-No, ideas and intentions of the master architect Kamran

Diba, and a thematic review of the project will be presented, followed by a critical review of its current condition, and concluding with an analysis of the obstacles of realization. Chapter III focuses on the subject of new towns in Iran, investigates both the vision and the reality of Hashtgerd New Town, which is the base of the Shahre Javan Community Pilot Project, and shows how fragile the future of this town is. This discussion provides a background for the next chapter which aims to introduce the

Young Cities Project and Shahre Javan Community Pilot Project in a thematic categorization. The fifth chapter deals with the comparative analysis of these two projects; a side by side review of the common themes and ideas which discovers commonalities of the projects on the one hand, and makes us aware of the probable fields of challenge and confrontation for the Shahre Javan Community Pilot Project on the other hand. As the result of this comparison, it becomes evident which challenges may jeopardize the realization and life of this project in future. The book ends on the sixth chapter, which provides some recommendations and suggestions for policy-makers for achieving a more secure future for the project.

¹ Shushtar-No means New Shushtar and denotes to the Shushtar New Town. In this book, the Persian name of Shushtar-No is used.

II

Shushtar-No— Background, Vision, and Reality

This chapter introduces Shushtar-No, its architectural and urban concept, as well as its current situation some 35 years after its partial realization. The aim of this chapter is to give a general overview of the functional reasons behind the planning of this residential complex, the context in which it was originally designed, as well as the thematic concepts behind its configuration, to uncover its vision. Finally, its current appearance and challenges will be discussed, concluding with the main problems it presently faces.

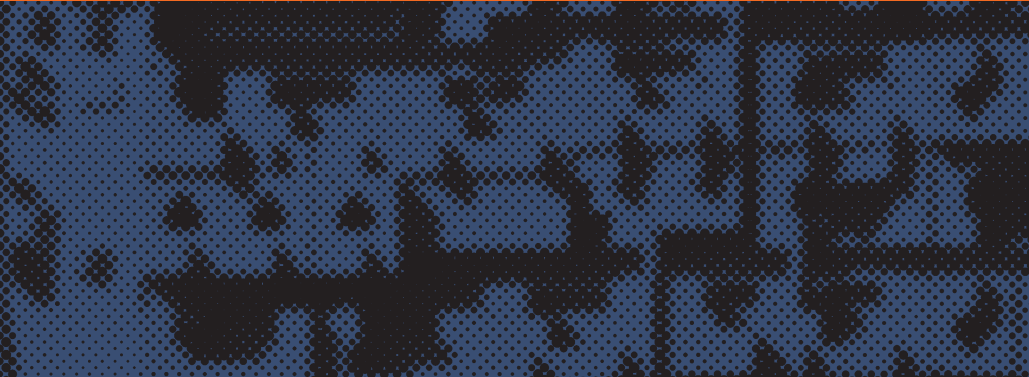
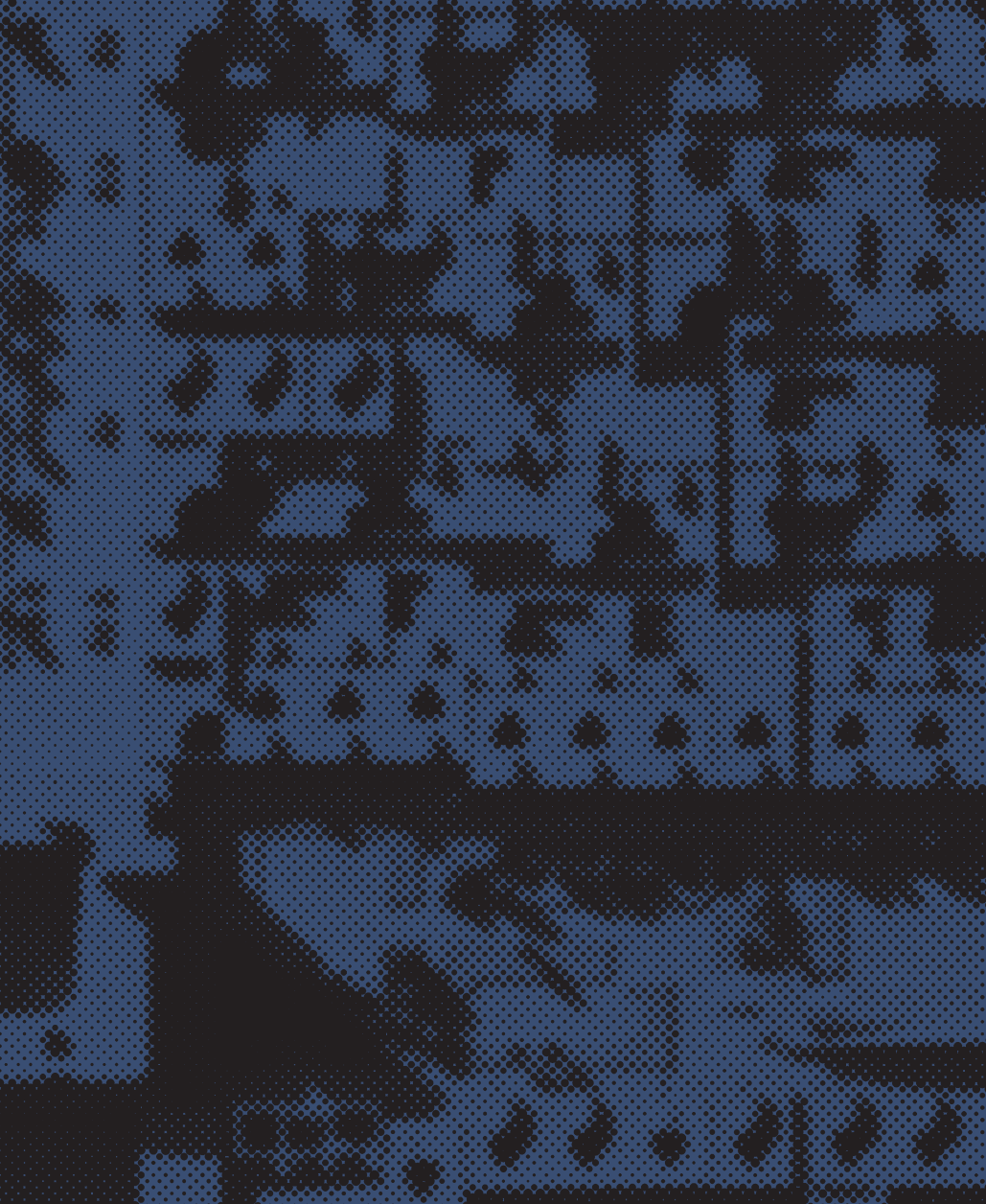

1 Shushtar-No: Background

1.1 Shushtar-No, General Features

During the 1970s, central government of Iran constructed the Dez Dam in northern Khuzistan Province to develop the agricultural production sector. This led to a major sugar cane production and refinery industry, necessitating employment of new staff and laborers. In 1974 Kesht-o-Sanate Karoun (Karoun Agro-industrial Company) decided to build a satellite city and residential community including houses, mosque, commercial center, schools, and other urban facilities for the families of its white and blue collar workers. It was planned to accommodate 6,500 families, 25–30,000 inhabitants, adjoining the old city of Shushtar in Khuzistan province in the southern part of Iran, and supported by a railway system to transport workers to work sites. The site was located to the north of Shushtar, only 2 km away from its center, divided from the old city through the Shatir River, connected by the Shadravan Bridge. It was originally an undulating, gentle slope from north to south, mostly desert and barren.

In 1975, DAZ Architects, Planners, and Engineers Bureau, headed by Kamran Diba, was commissioned to prepare the plans. The construc-

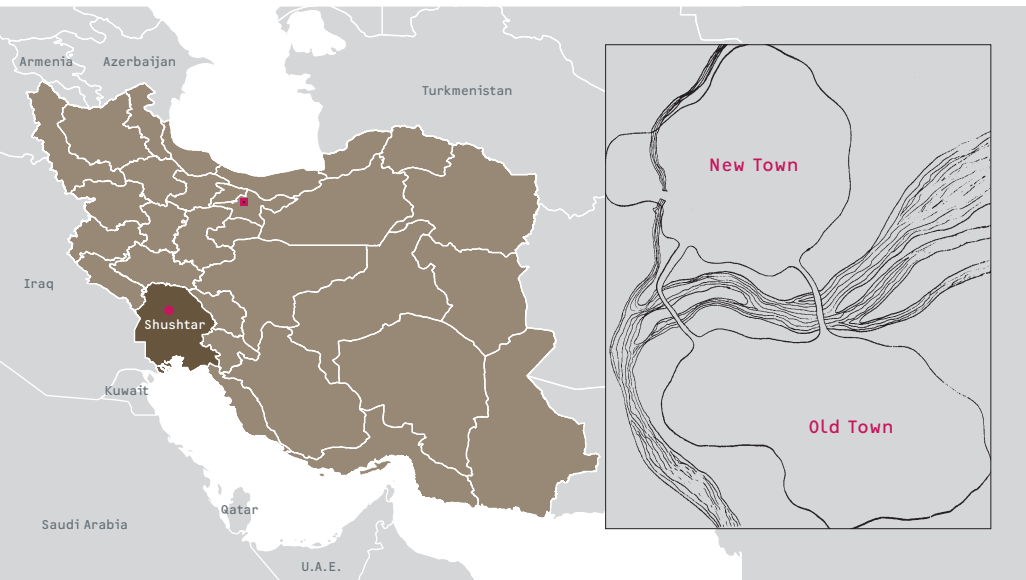

Fig. 1: The Location of Khusistan Province and Shushtar-No in Iran (Döge 2012)

Fig. 2: Old Shushtar and New Town (Diba 1981)

tion was assumed to begin in 1976 and all its five stages to be completed by 1985. However, the political unrest of the Islamic Revolution halted construction in 1978, continuing later and only partly in 1979. Only the first phase of the project was completed, with about 600 houses, except for the mosque, library, and some public buildings, accommodating 700 families and 4,200 inhabitants at that time. After the revolution, DAZ was confiscated by the revolutionary government and went under the

supervision of the Bonyad-e Mostazafan (Foundation of the Destitute).

1.2 Architect

Kamran Diba (born in Tehran, 5 March 1937) is an Iranian architect, urban planner, and painter who studied architecture at Howard University, Washington, DC. Graduating in 1964, followed by a year of post-graduate studies in sociology, he returned to Tehran in 1966 and started his professional career. In 1967 he became director and senior designer of DAZ Consulting Architects, Planners and Engineers. In a short time DAZ undertook diverse projects in Iran as the result of which its staff grew to 150 in 1977. Tehran Museum of Contemporary Art (1969–77), Cultural Center and Garden of Niavaran (1970–78), Shafagh Park (1966–69), Farah's Secretariat (1970–78), Namaz Khaneh (1977–78), Shushtar-No in Khuzestan (1974–80), and Jondi-Shapour University (now Shahid Chamran) in Ahvaz (1968–1978) are some of his important works.

Diba worked entirely in the public sector in Iran. As an urban planning consultant he worked with Iran's Ministry of Housing and Urban Development and his firm developed master plans for a number of cities including Khorramshahr (a port in the Persian Gulf) where he collaborat-



Fig. 3: Contemporary Art Museum, Kamran Diba, view to the courtyard (Author)



Fig. 4: Cultural Center of Niavaran, Kamran Diba, view to the skylights (Author)

ed with the Greek planner Constantinos A. Doxiades. From 1976 to 1978 he was the founder and first director of the Museum of Contemporary Art. As a painter, Diba had several exhibitions in Iran.

In 1977 he left Iran to live in Paris and Washington, DC, working in private practice and completing some housing schemes in Virginia and Spain. In 1977 he was Visiting Critic at Cornell University, Ithaca, NY.

1.3 Architect's Architectural Thinking

Diba's architectural works are intrinsically rooted in his unique architectural thinking which distinguishes itself from the dominant trend of his time. He is notable for the way he understands the West, observes the Iranian culture, thinks about the human dimension of the built environment, and resists the wishes of the dominant technocrats and officials.

Diba belongs to the second generation of Iranian students who were educated in the West and brought back their knowledge of “modernism” to Iran. But Diba's understanding of modernism was never limited to its physical and formal aspects, “but rather the sociological and human values and ideas which existed in the West” (Diba and Javaherian 2005, p.17). However, even these social and humane values are not transferrable as such; they have to be integrated into the Iranian traditional norms and values, to create an entirely new approach. Diba refers to this as a “synthesizing tradition and modernity” (Diba 2010, p. 68) as the result of a continuous dialectic and dialogue between them. This synthesis, for him, helps to keep a connection to the roots without becoming imprisoned in tradition, but rather opening new perspectives into it. By this synthesis, he was searching for a “local style”, well reflected in his architectural works and projects. This “local style”, however, was not restricted to the local and closed to the outside, but the outcome of an open ongoing process of exchange and interaction with “the other”.



Fig. 5: Namaz Khaneh (praying place), Kamran Diba (Author)



Fig. 6: Jondi-Shapour University, Kamran Diba, university mosque (Author)

Diba observes an identity crisis in Muslim societies, the result of an imposition of western values and methods of science and technology, so that “Loss of independence and perhaps a perceived humiliating subjugation to Western ideas and values has brought about an identity crisis in Islamic societies” (Diba 2002, p.119). Despite a sense of re-thinking traditional values in Muslim countries, Diba argues, they “are all building Western-style metropolitan life on different scales—high rises, slums, di-

visive social classes, mega-transportation systems generating everything from pollution to social incoherence” (Ibid.). This irony shows that any call for searching for identity remains a superficial play of words, instead of authentic theorizing and practice; in Diba’s words: they are arguing over the design of the buttons, but producing the suit according to the Occidental model.

In pre-revolution Iran, similar to its post-revolution era, the main architectural attitude was modernism, without considering the particular context of Iranian culture. There was a dominant tendency towards high-rise building as a sign of progress and modernity. The prevailing perception was, the more our cities look like those of developed countries, the more developed we are. According to Diba, imitating and copying the western urbanism model leads to social disaster in Iran, since this kind of dwelling has no history in Iranian culture. In this context, Diba explored the necessity of a “human architecture” which addresses these subtle but vital aspects of life, and tries to provide a practical urban directory for cities to be more adapted to their socio-cultural context, an attempt which was never recognized by the government (Diba 2010, p.194).

In this condition in which the prevailing voice comes from decision-makers influenced by the logic of the market and waves of universalism, the position of architect is of vital importance. The role of architect, Diba believes, is like one of a director of theatre or cinema (Diba and



Fig. 7: Yousef-Abad Garden (Shafag Park), Kamran Diba, view to the central plaza (Author)

Javaherian 2005). An architect must introduce inhabitants to the particular norms of living, and manage their daily life. However, this is not a determinist approach by which the behavior of the user is prescribed in advance. Rather, the architect’s task is “akin to writing a script for human interaction, anticipating all possible action and yet leaving room for spontaneous improvisation within the given architectural spaces” (Diba 1980a, p. 43). To fulfill this attitude to the built environment, Diba intro-

duced the concept of “urban design” for the first time in Iran, and taught a course on this topic at the University of Tehran to develop it in both an academic and professional sphere (Diba and Javaherian 2005).

Diba, in many cases, introduces a sense of resistance—opposing a client’s unrefined ideas when they do not meet his own architectural beliefs and thinking. In the Yousef-Abad Garden, for example, an old dilapidated building was deliberately preserved, despite the wish of the client, first to provide a nostalgic dimension to the complex, and secondly to create a plaza-like space together with two new buildings. He was also against the development plan of the Imam Reza Shrine in Mashhad, a holy place which attracts millions of pilgrims every year; instead of demolishing the old urban texture surrounding the shrine and building highways and new facilities, he advocated preserving the urban tissue, by regenerating and rehabilitating (Diba 2010). His efforts, though unsuccessful in this case, shows his high commitment to admiring the social urban life and integrating any new interferences with the existing fabric.

Due to these characteristics, Diba’s architecture is sometimes referred to as “postmodern architecture” (Diba and Javaherian 2005), a style which, at the time, was limited to the western architectural sphere. This claim is due to his clear and articulated attention to the local culture and architecture, at the same time employing the vocabulary of modernism. However, Diba’s architecture goes beyond superficial imitation and direct reference to historical motifs and signs to provoke a sentimental sense of traditional, but advocates a more indirect recollection which may be referred to as “re-interpretation” rather than “imitation”. In this sense, Diba’s works introduce a “critical regionalist” architecture derived from an intelligent synthesis between tradition and modernity without falling into the trap of sentimentalism.

1.4 Dominant Housing and Construction Trends of the Time

To understand the uniqueness of Diba’s approach in Shushtar-No, a short introduction to the governing status of the housing and construction industry would be helpful. In 1970s Iran the sudden rise in oil revenues and the political ambition of the government led to large-scale investments in housing, resulting in mass housing production and new town construction. This trend was accelerated by the technocrats who discovered a secure source for their ambitions in achieving socio-political distinction. In order to react to the growing housing market it was crucial to short-

en the construction period, making prefabricated mass housing a desirable option. In this way, developers could also release themselves from time-consuming and sometimes problematic process of providing urban and architectural plans by consultation offices. This construction method, based on prefabricated elements produced outside and assembled on site, appeared to be more economic and functional, meeting the wishes of the investors in a short time period.

In addition, this growing market gave jerry builders an active role, with their small-scale simple 3–4 story apartments built in scattered lots all over the cities, buildings in which architectural quality was of little importance. Both these trends in housing were based on a materialistic approach imported from a western context and alien to the socio-cultural values of the Iranian community. Diba obviously opposes this attitude, stating that, “Modernization and technology should not be allowed to impose a scale or way of life which is inappropriate and detrimental to community life” (Diba 1980a, p. 40).

Instead of a “housing development” which addresses the physical needs of inhabitants, regardless of their socio-cultural background, and imports foreign models of dwelling without making them appropriate for the given users, Diba proposes “community development” which goes beyond physical considerations and meets existential dimensions of the people, highlighting their particular “tradition of habitation”. Community development may bring decision making back to the hands of the people, and lead to a bottom-up programming policy. Shushtar-No, with its concentration on social life, cultural particularity, and the traditional lifestyle, aims at “community development,” rather than simple “housing construction”.

II.2 Shushtar-No: Vision, Concept and Spatial Configuration

This section intends to explore conceptual and architectural aspects of Shushtar-No and study them within some key topic areas. The aim of this categorization is to open a thematic perspective of the project and provide a basis for subsequent comparative studies.

2.1 Source of Architectural Inspiration

As mentioned, at the time of designing Shushtar-No, construction and housing in Iran was essentially under the influence of the western style and vulgar modernism was the leading trend in the professional sphere. Diba's architectural approach in this project, similar to his other works, "was a reaction to the pervasive trend of western architectural values in the third world as well as Iran, in which a building symbolized power, commerce, gaudiness, inattention and disrespect to the everyday life and the traditional community culture of the people" (Diba 1998, p.87).



Fig. 8: Old Shushtar, urban pattern (Diba 1981)

In principle, Diba identifies two antagonist issues of the traditional environment: high-rise buildings and uncontrolled vehicle traffic (Ibid., p.121). Both these principles are reflected fundamentally in the architectural approach of the project. In order to go beyond the overwhelming trend of the time, Diba took the values of traditional architectural and social life as his departure point.

Traditional and vernacular architecture of the region, well portrayed in pre-modern cities of Dezful, Shushtar, Yazd, and Kerman, were the main inspiration source for the architect. Diba lists the main characteristics of them as follows: 1) introverted architecture, which preserves the inside from the stark sunlight and makes the familial core livable; 2) human scale, created as the result of the humane proportion of the buildings and the limited width and height of the street networks; 3) narrow street network which makes the space environmentally acceptable as the result of producing shade; 4) open meeting spaces in neighborhood scale which makes socialization achievable; and 5) generation of a common sense of community and belonging resulting from interwoven streets and social exchange (Diba 1986). All these principles, well reflected in the traditional built environment, have been re-interpreted in different forms and employed in the formal and social structure of the complex, and thus produced an urban area which introduces a high sense of community and belonging.

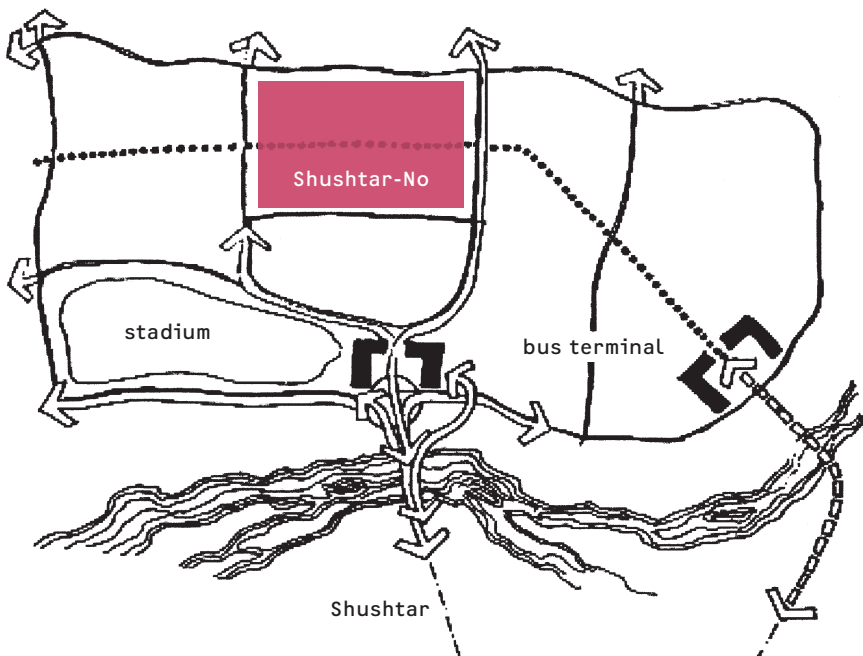

Fig. 9: Diagrammatic structure of the complex (Diba 1981)

2.2 Urban Layout

A main axis, as a spinal cord from beginning to end, serves as a connector by which all the major components, districts, and activities are linked together. At the eastern side, an open space provides room for local farmers to sell their vegetable and food, and thus connects the hinterland activities to the urban texture, a progressive idea which may hinder extreme segregation of the city from the surrounding agricultural zones. A cov-

ered street bazaar culminates in a green public space as the heart of the central residential quarter. A commercial center is located in the middle, with spaces arranged around a courtyard. This neighborhood has its local bath as well as its local mosque. The main axis continued with the community and cultural center. The Friday Mosque is located at a high point, at the mid-section of the long pedestrian boulevard, within a man-made forest. The main axis continues with a pedestrian square and then a park, and finally culminates in the town square (Maidan-e-Shahr), with dimensions of 100×100m, connected to the old city through a pedestrian bridge and working as the principle urban space unifying old and new town (Javaherian and Diba 2005; Diba 1981).

Different types of residential units have been arranged around this spinal cord. Other urban facilities, such as schools, are distributed throughout the area within an accessible distance. A main sport facility is located at the south-western part, a bus station at the south. Two bridges connect the complex to the old city.



Fig. 10: Site plan of Shushtar-No (Diba 1981)
Fig. 11: Topography of the site (Diba 1986)

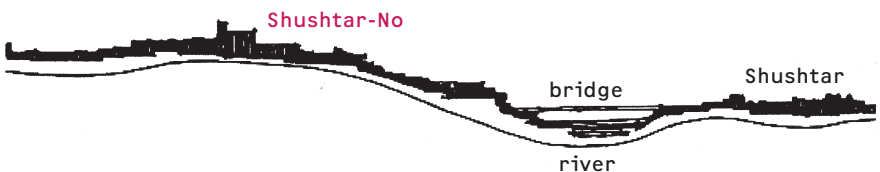

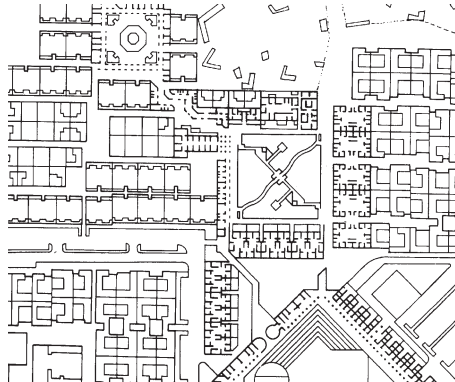
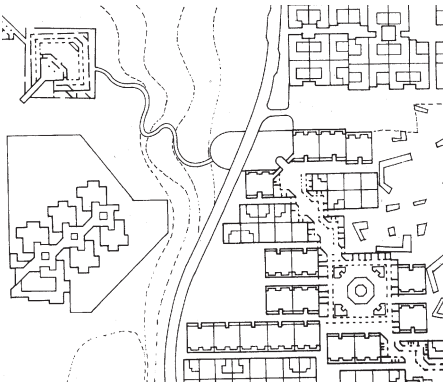
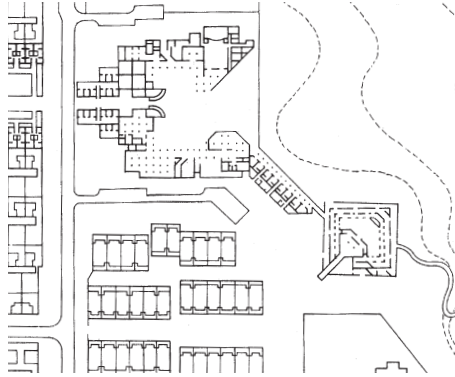
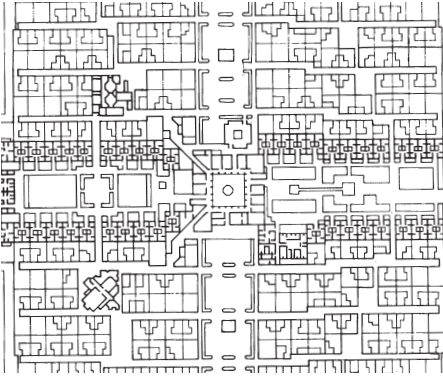
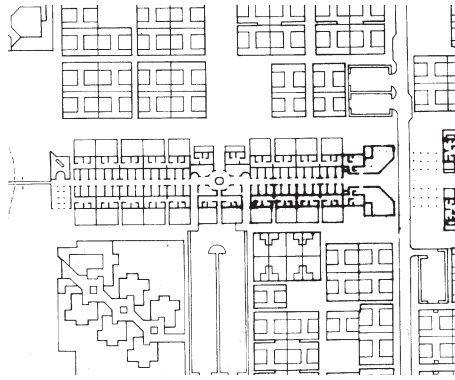
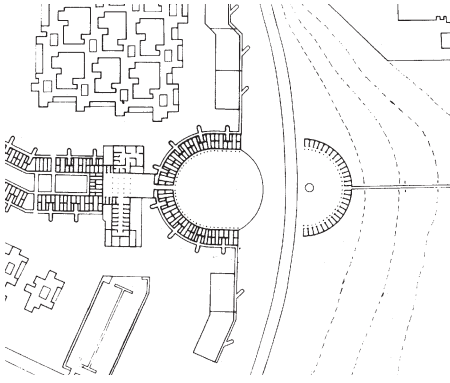

Fig. 12a-f: Detailed site plan: 12a: eastern open space and market; 12.b: bazaar; 12c: central quarter and shopping center; 12d: Community and cultural centre and mosque; 12e: shopping center and school; 12f: park and shopping center (Diba 1981)

2.3 Compact Urban Form

The urban tissue of the old Shushtar, like many other traditional Iranian cities, is dense and compact, every district has its own center with necessary urban facilities including a square, a local mosque, and a bath, linked to the city center by means of a narrow street network efficiently expanded over all the urban fabric.

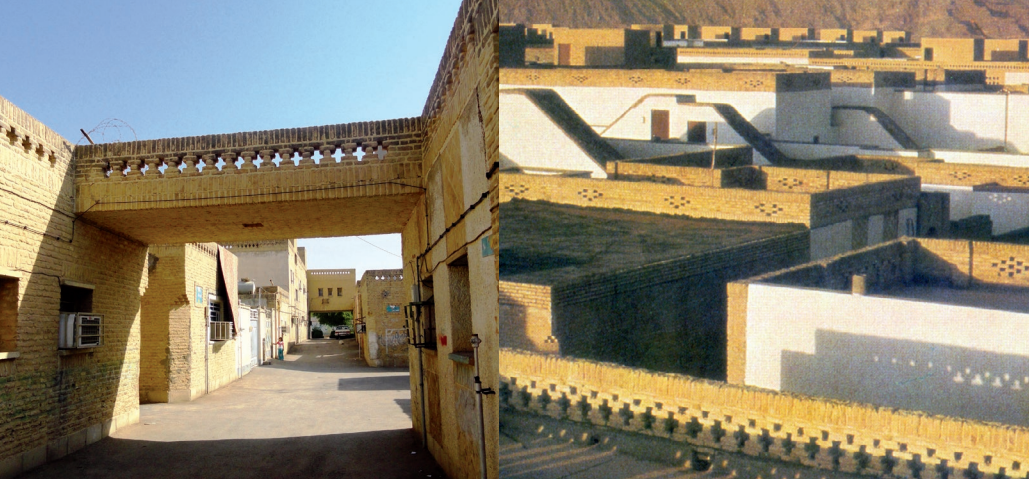
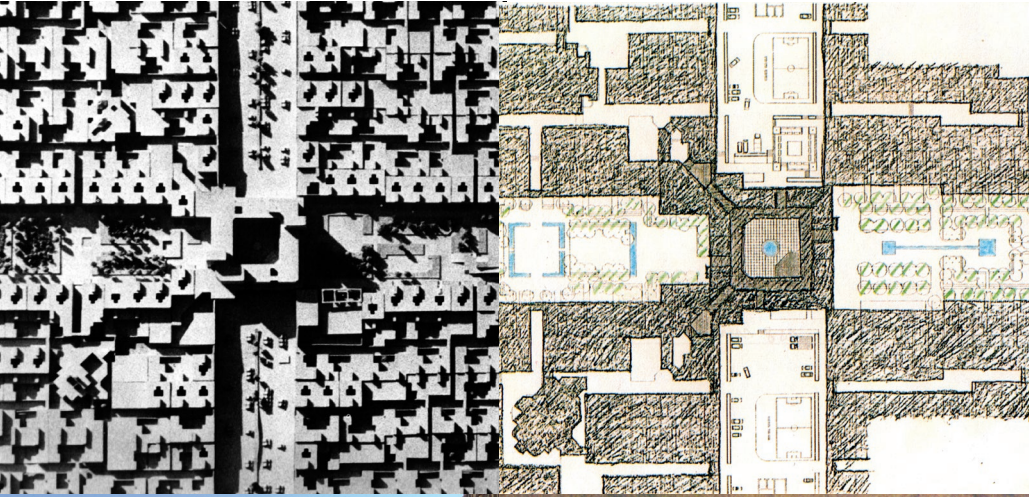

Fig. 13: Compact urban tissue and low-rise, high-density pattern (Diba 1981)
Fig. 15: View to one of the streets (Author)

Fig. 14: Street pattern of the central neighborhood | Fig. 16: Roofscape of the residential section (both Diba 1981)

Taking this traditional urban layout as the departure point, this project is based on a low-rise, high-density horizontal development; houses are close together, in a compact urban tissue, with small courtyards for each unit. Multi-level apartments are absent in this scheme, to give the entire complex “the identity of historical cities”. Districts are separated to have their own individual characteristics, while related to each other to make socialization and contact possible.

Streets are neither straight nor identical; passages are crooked and sometimes dead-end with varying vistas, different in width to provide space for various events like the playing and gathering of children. Thus, a path is not a physical connecting route, but transforms into a social happening. Moreover, streets are mediated by some public spaces, to avoid a monotonous atmosphere in the neighbourhoods.

Compact urban form grants an aesthetic coherence to the community as well. Diba has always been impressed by the vernacular roofscape of the traditional settlements, such as Yazd and Kashan, where roofs are more than just a shelter, and when combined not only generate a uniform, delightful urban vista, but also serve as an open bedroom for the hot summer nights. This concept has been successfully re-interpreted in the Tehran Museum of Contemporary Art, where the undulating roofscape is accessible for to pedestrian use. In the Shushtar-No, as well, roofs are accessible for the inhabitants to be used for sleeping in the evenings, and to enjoy the cool breezes of the night, while brick grilles provide both privacy and shade.

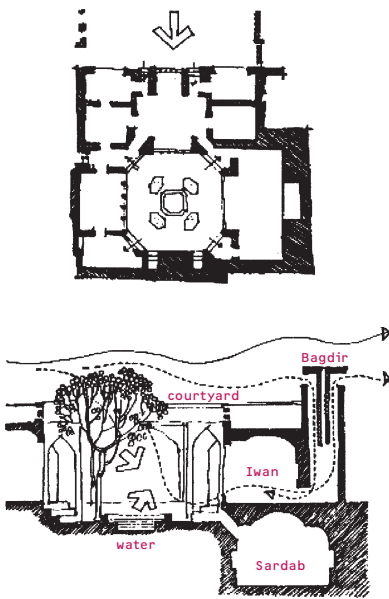

Fig. 17: Typical housing layout in the old Shushtar (Diba 1986)

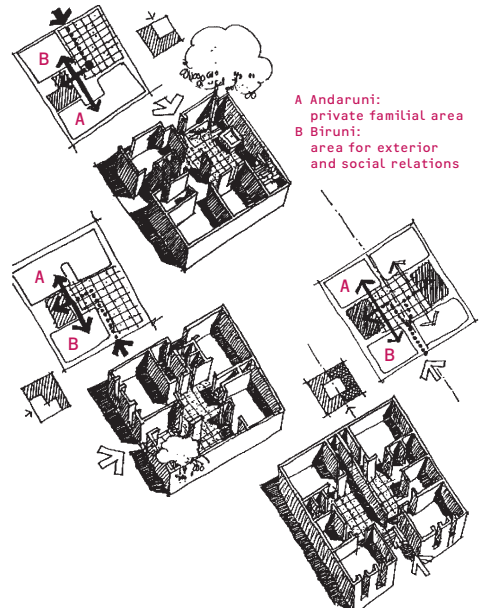

Fig. 18: Housing concept and typology (Diba 1986)

2.4 Housing Layout

In the old city of Shushtar, individual buildings were traditionally formed of four rooms separated by the barrel-vaulted Iwans, circled around an open space courtyard at the heart of the unit. This configuration was in fact an interpretation of the archetype of Chahar-Tag (four arched pavilion), intensively reproduced in different architectural buildings from the Fire Temple up to Mosque and Madrassa. This structure has been re-in-

terpreted in the housing layout of the Shushtar-No.

Interior of the houses is essentially different from that of western style, where every room has its particular and immutable function; dining room, sitting room, bedroom, etc. Here, the housing scheme considers the room “as a flexible interior unit” (Diba 1981, p.169), proposing a “soft furniture”, rooted in the village lifestyle and traditional houses where a room may serve for different purposes during the day and seasons, with changing the furniture. For instance, a room can be transformed into a bedroom at night by expanding the mattresses, can serve as breakfast room after rolling the mattresses and storing them in the cupboards, and, when furnished with some backrests and blankets, can be used to receive guests. In this way, rooms become multifunctional and flexible. They are mainly 5×5 m, the smallest of them 4×4 m and 3×4 m. About 90 % of the entire accommodation is two or three story houses, the rest are apartments.

Another sense of flexibility is also observable in the housing scheme: each two or three-room unit may be extended to a four or six-room larger



Fig. 19: Residential plan of the central neighborhood (Diba 1981)

unit by means of attaching the next door house, if any larger space is needed for a family, or a better economic status has been achieved.

In this schema, as in typical traditional housing configurations, the exclusive family zone (Andaruni in Persian) has been somewhat separated from inclusive family zone (so-called Biruni) providing two related but distinguishable residential realms.

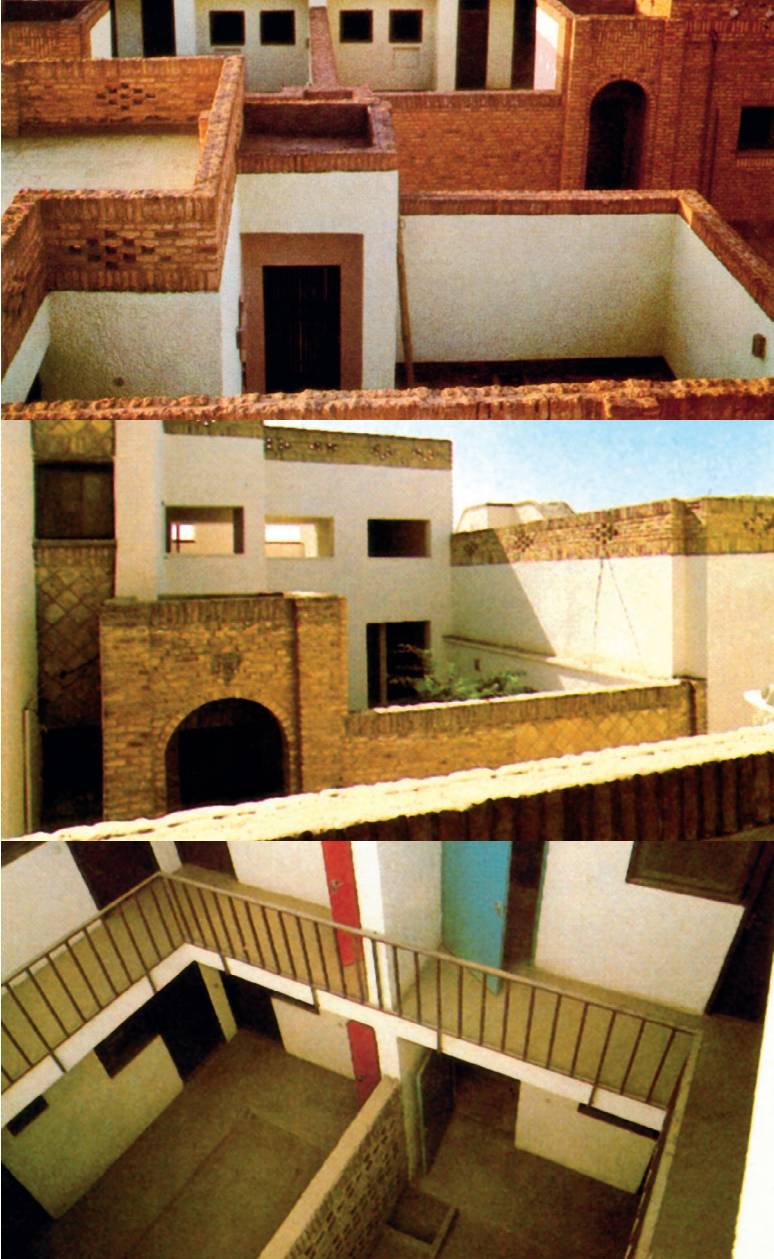

Fig. 20a–c: Different courtyard typologies (Diba 1981)

2.5 Courtyard Prototype

Courtyard prototype is another architectural model re-interpreted in the architectural and urban configuration of the complex. This prototype not only proposes a formal characteristic, but also supports socio-cultural dimensions lived and experienced in the Middle Eastern context since long ago. Like the Chador, the black Persian veil covering women for privacy reasons, middle-eastern vernacular architecture conceals the

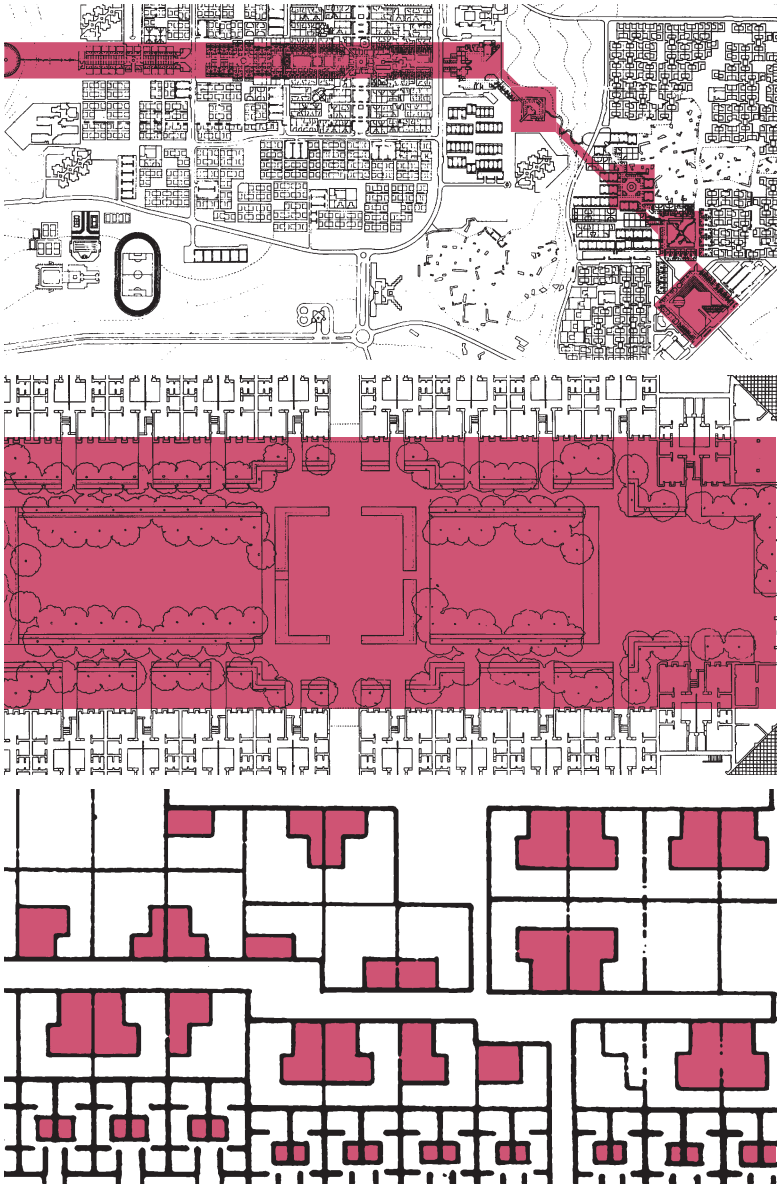

Fig. 21: Urban courtyard, community courtyard, and individual courtyard (Author, after Diba 1981)

inside through an internally-oriented configuration, by means of an internal courtyard which renders the exterior façade as the less important one, giving superiority to the interior space and hence drawing a clear demarcation between the inside and the outside (Diba 1981). This prototype provides a comfortable microclimate within the building against the primarily harsh exterior climatic condition, transforming the heart of the building into a livable microcosm, a paradise inside the settlement, and

securing both the privacy and the intimacy of familial life.

Diba first used this courtyard prototype in the Tehran Museum of Contemporary Art (1967–76); he designed an open courtyard at the heart of the complex surrounded by interconnected galleries and exhibition spaces, serving as an outdoor sculpture court, providing both greenery and water in a geometrically changing configuration. Later, in the Cultural Center of Niavaran (1970–78) a sunken courtyard is connected to the axis of cascading pools and tall plane trees through a narrow bridge over the moat, highlighting the entrance.

Here in Shushtar-No, all the houses, including the apartments, have a courtyard at the center, in order to benefit from all the physical and spiritual implications of this traditional prototype. This schema is observable in all the urban components, from dwelling units up to office buildings and public spaces. In the macro scale, the main urban axis functions as an “urban courtyard” stretching over the entire complex and serving as a space for social urban life. This “urban courtyard” encompasses greenery in the macro scale and is the living heart of the community, like the courtyard of the family unit. In the first phase of the complex, this urban courtyard is more structural and articulated, since the first neighborhood was designed “as a total architectural unit, more like one building rather than loosely organized units within an urban structure” (Ibid., p. 180). This open space is a “community courtyard” which serves all inhabitants as a collecting and socializing space. At the micro level, the courtyard is visualized in different ways in all the building types, from single and apartment housing to the cultural center and mosque, from the schools to the shopping center.

Thus, the prototype of the courtyard is manifested in three major typologies as urban courtyard, community courtyard, and individual courtyard.

2.6 Social Integrity

In his childhood, Diba was fundamentally impressed by the social expression in the high-dense streets of Tehran. A feeling, later enhanced by the social capacity of the Italian towns he visited, particularly their piazzas, where a vivid combination of architectural styles and attitudes are unified with urban life. For him, human interaction and social activity has always been a vital theme, to the extent that he took some courses in sociology at the postgraduate level: “Understanding social situations not only introduced a new challenge and a new dimension to my work, it led to

an anti-architectural attitude” (Diba 1981, p.8). It is architect’s task, he believes, to energize the environment, through which the level of interaction is enhanced and a “sociable architecture” is created.

Thus, Diba’s architecture goes beyond building a physical container, generating a “social event” to create an environment which multiplies and enhances the quality of interaction. Like a theatre director, an architect provides space for human activities and social interaction, through cau-

tious orchestration of the users' behavior. Culture, thus far, is not limited to the physical heritage of the past, grand buildings and edifices, but embraces simple social behaviors like eating and walking in which a great particularity and distinctiveness is observable. Diba presents a detailed explanation of the eating behavior of Iranians, Chinese, and Europeans, explaining how the characteristics of eating has its root in their cultural behavior (Ibid., p. 9).

This attitude inclined Diba to public and institutional architecture which was generally not favored by the leading architects, architects who were crystallizing their ability in the private commissions and villa houses of the upper class (Diba 2010). Even in the Garden of Niavaran, initially planned for office facilities of Empress Farah's Secretariat, Diba suggested publicizing some of the cultural facilities, making them accessible to the people.

Diba's social attitude was clearly manifested in his first realized work, the Shafag Park or Garden of Yousef-Abad (1966–69). Traditional Persian gardens were walled and isolated from the surrounding and usually barren landscape to provide a private, green, interior microcosm with a pleasant microclimate to contrast with the harsh exterior climate. However, Diba goes beyond the typical geometry of Persian gardens and introduces, most likely for the first time in Iran, “the idea of neighborhood and the community center providing social services” (Diba 1981, p.16). With two small libraries for adults and children, a workshop for children, a community hall, and offices available for NGO activities, this park was based on a social program to encourage meeting, participating,

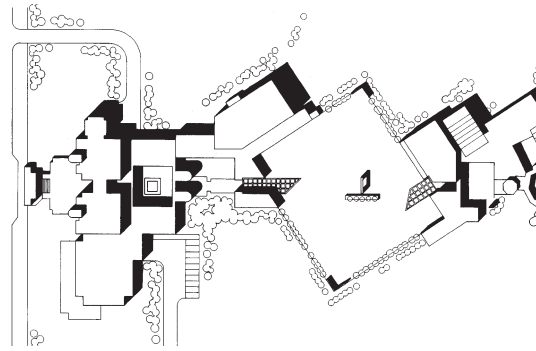
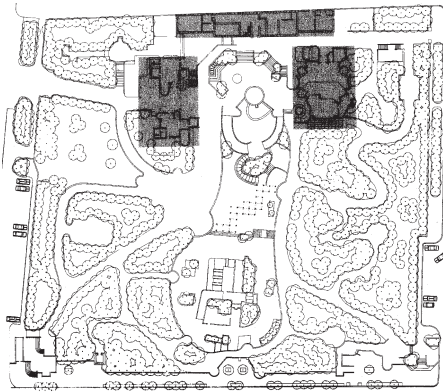

Fig. 22: Garden of Yousef-Abad, site plan (Diba 1981)

Fig. 23: Jondi-Shapour University, beginning of the main pedestrian axis (Diba 1981)

and socializing. Well connected to the adjacent urban texture through a handful of entrances, a walkway meanders through the garden, supplying the visitor with a variety of changing vistas.

In the Jondi-shapour University in Ahvaz (1968), now Shahid Chamran University, a main pedestrian axis connects all the components together and thus works as the social spine of the complex. Starting from the Student Union and cafeteria building, it leads to a small univer-

sity mosque, the courtyard of which provides shaded seating space with a small pool at the center. After a smooth change in direction, the elevated level of the agricultural water canal becomes a pedestrian promenade with trees, lawns, and benches, through which different sport facilities are accessible, such as volleyball and tennis courts. This walkway culminates in the gymnasium, the main sport hall. The idea of an open-ended pathway which maximizes social activity and enhances the quality and quantity of human interaction is a method for making concrete the “human interaction intensification program” which was always a priority for Diba (Ibid., p. 54).

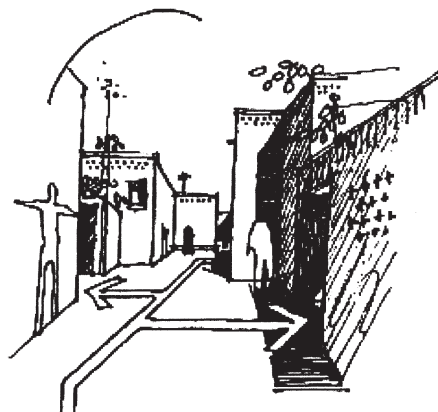
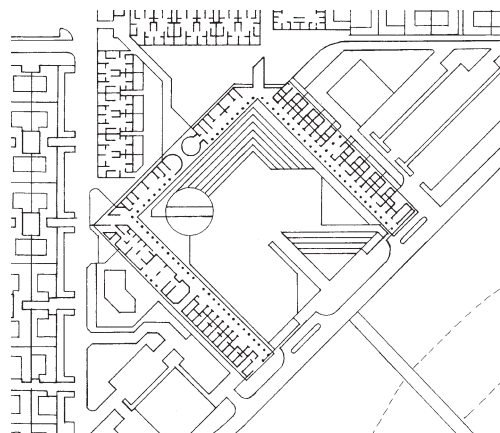
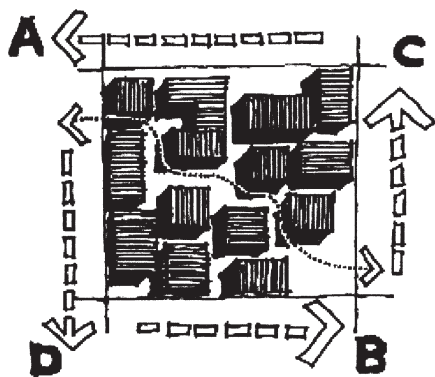
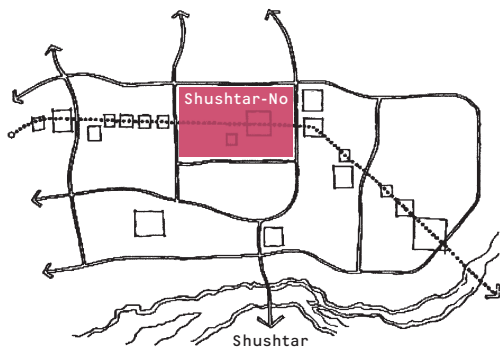

Fig. 24: Distribution of the public services in Shushtar-No (Diba 1986)
 Fig. 25: City square, site plan (Diba 1981)

Fig. 26: Closed texture pattern (Diba 1986)

This human “interaction intensification program” is visualized in the public spaces of the complex in the form of the city plaza and the main spinal axis, as well as few small community centers. The main and largest city square on the river bank is a connector between the new and old city, with a plaza of 100×100 m, surrounded by cultural, social and administrative buildings. The main axis around which all the urban components are assembled is actually a “social axis” by which communal activities and ex-

changes are intensified. The size and dimension of the greenery equipped urban axis and meeting places are intended to set them the main scenes for “urban exchange”. Part of this axis is dedicated to the first phase of the project at the center, where a more coherent urban texture is perceivable. Here, as well, the public space is the main place for community interaction. A more private public space is also planned within the urban tissue, mainly in the service of the neighborhood as a playing ground for local children.

To avoid any social segregation it was suggested to make some houses available for the people of the old city, to link the new and old city as much as possible, prevent any physical and also mental separation between these two settlements, open the society to the outside, and escape creating an absolute company town (Diba and Javaherian 2005; Diba 1980b). To this end, Diba talks about a “social agenda” of this project, which obviously goes beyond constructing a series of houses. In light of this goal, he was against accommodating middle management families far from the laborer’s, arguing that an authentic city must leave no place for any “class stratification” and children of all classes should be educated under the same roof.

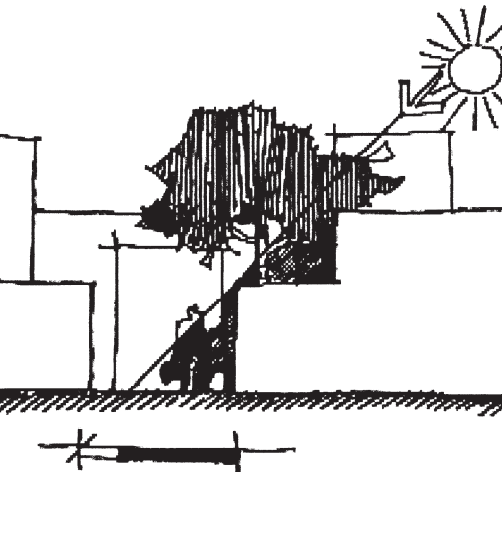

Fig. 27: Narrow street pattern (Diba 1986)

Fig. 28: Deep arcades of the shopping center (Author)

2.7 Environmental Adaptation

The region occupied by the new town suffers from harsh climatic conditions, with summer temperatures up to 50 °C and little precipitation. To mitigate the existing hot climatic condition, a more place-specific architectural configuration is of major importance, for which the traditional urban patterns are a reliable source of inspiration. The concept is of a closed-texture city, where the buildings produce the necessary amount

of shade. Narrow streets, especially the north-south streets, create shadow and breeze, and minimize the convection effect of heat rising from the streets. In the central shopping center, deep arcades provide shade for visitors.

Houses have thick walls and small windows to avoid over-heating the interior. However, installing electronic air-conditioning is unavoidable. Entrance to the interior is through a mediatory protected space between the street and the inside, providing a cool space for socializing (Diba 1986).

2.8 Local, Middle-Technology

Domestic technology and labor was an integral part of the program. Load-bearing walls are built of locally produced bricks; roofs are covered with steel beams or engaged piers, filled by traditional brick barrel-vaults. Floor finishes are terrazzo tiles laid on concrete slabs (Ibid.). Thus, all the construction was based on middle- technology locally available; most of the materials were produced in the region. Employed on-site labors were almost unskilled, 90 percent Iranian, 10 percent Afghan, commissioned by a local contractor. Technicians were local as well, the professionals, such as architects and engineers, were 95 percent Iranian.



Fig. 29a-b: Local available construction technology and materials (Author)

2.9 Controlled Vehicular Traffic

For Diba uncontrolled vehicular traffic is a major enemy of the traditional environment, so that by supplying private cars with access to each unit “we sacrifice the quality and scale of our environment, making the community subservient to cars, and we give in to individual modes of transportation” (Diba 2002, p.121-22). Because of this belief, the complex was planned as a car-free community, to further foster privacy and neighbor-

hood activity. Automobiles were segregated from the internal community life and parking was planned at strategic, external points.

2.10 Green Space

Green space is limited in this complex to economize and simplify its maintenance, since landscaping and maintenance costs go beyond the ability of the community administration. Generally speaking, there are three kinds of greenery in this complex: public greenery, semi-public greenery, and private greenery.

Public greenery was concentrated along the main axis, to make the public space attractive and more comfortable for socializing. As an integral part of public space, the line of greenery starts at the Main Plaza and crosses the entire community. In principle, the managerial institution, at the beginning Keshat-o-Sanate Karoun, was responsible for its maintenance and supervision.

A semi-public, semi-private garden space was designed for the front of the apartment buildings, facing the main axis. The intention was to create private engagement in public greenery, thereby sharing maintenance efforts. In this case, every unit was responsible for maintenance of the

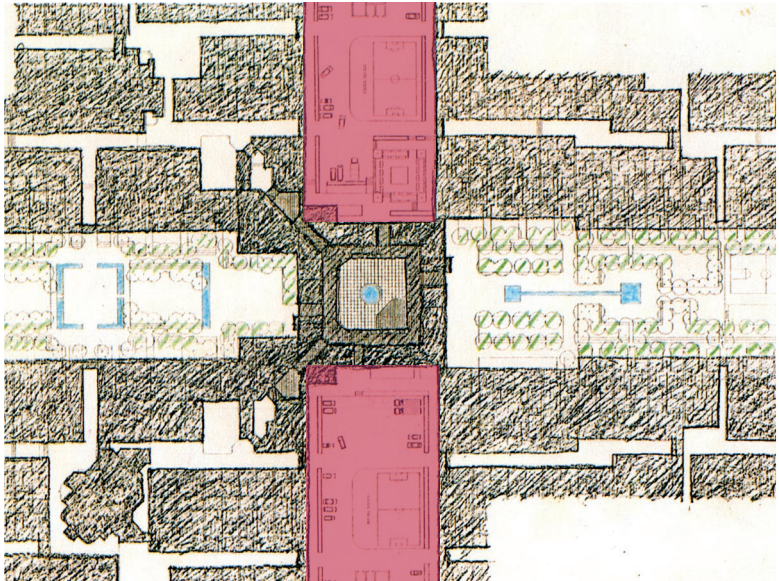

Fig. 30: Parking places are isolated and not allowed to the residential quarters (Author, after Diba 1981)

garden to keep the individual property alive, but all the inhabitants could enjoy the landscaping and its shade. Outside of these two cases, the remaining streets were free of greenery.

Interior green space was confined to the courtyards, where owners were responsible for planting and maintenance. These gardens would support the interior microclimate, and lend a bit of greenery (Diba 1980a).

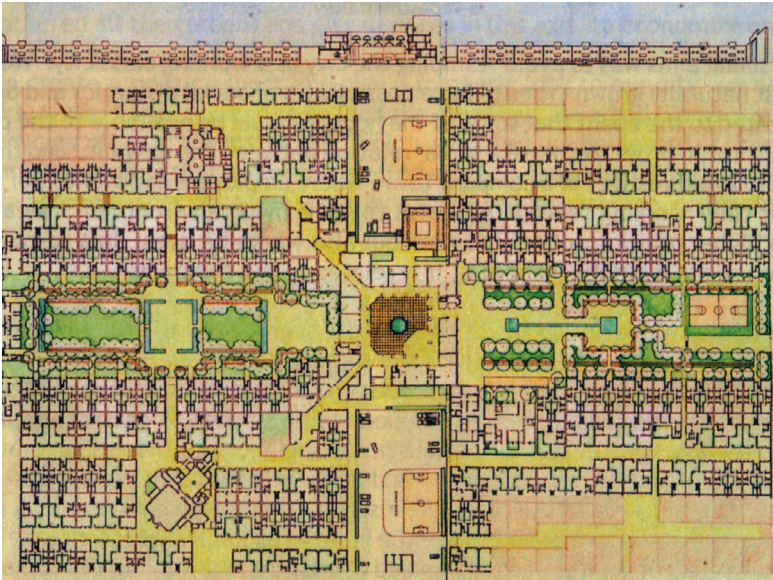

Fig. 31: Public greenery and semi-public, semi-private greenery in front of the apartments (Diba 1981)

3 Shushtar-No: Reality

The first phase of the project, consisting of the central four-district neighborhood, was built partly before the Islamic Revolution, except the mosque, library, and some other main buildings which remained incomplete. This phase included a main urban axis with greenery, framed in a four-fold structure reminiscent of the archetype of Chahar-Tag or Chahar-Bagh, a mosque, a public bath, and a shopping center in the middle.

At the beginning, this complex was under the supervision of the Karoun Agro-industry Company. However, due to political and managerial instability, the maintenance was inefficient and incomplete. Shortly after the Iran-Iraq war in 1980, the war-stricken people of the neighboring villages and settlements were settled here, in some cases in still uncompleted houses, in an urgent but unsystematic way, as the result of which the population density climbed to three times higher than initially planned. The first phase, originally planned to accommodate 4,000 inhabitants, had reached more than 10,000 inhabitants. After the war, a part of the population left their accommodation to return their original homes; however, houses were again occupied by immigrants from neigh-



Fig. 32: The lack of urban service: waste is not regularly collected (Author)



Fig. 33: Green space has been left unattended (Author)

boring settlements and villages who moved to take advantage of the low rents and purchase prices of the new town. Thus, the process of overpopulation never stopped, and continued to escalate, leading to the current disastrous, and tragic, urban condition.

There is no trace of any serious urban service for this community: waste is collected neither regularly nor carefully, green spaces have been neglected, gas pipes cross the façades without care, public passages need

renovation and repair, while air-conditioning units and advertisements are hung helter-skelter on the walls.

The lack of regulation has encouraged people to mismanage their property, without caution, taste, or aesthetic consideration, and with whatever material available. For example, in some cases courtyards have been converted to garages to provide space for cars, huge steel doors constructed with materials not adaptable to the original texture. In a similar way, apartment terraces have been either walled-off, to be added to the interior space, fenced-in for security reasons, or covered for more privacy—all with any material or medium available, in an unfortunate and tasteless manner. In many cases new renovations have been done with materials such as marble or simple cement, according to financial ability of the owner, in a clumsy contrast to the original brick-work.

Although an open area has been dedicated to greenery in front of some houses facing the main square, with the intention of being planted by the inhabitants to encourage participation in increasing the greenery in the community, they are now either walled-off, for privacy or ownership reasons, or left unattended. This treatment shows that the initial imagination of the designer was far from the actual behavior of the inhab-



Fig. 34: Gas pipes, ventilators, and advertisement signs have been installed carelessly (Author)



Fig. 35: Public passages need renovation (Author)

itants; for them privacy and ownership seems to have priority over greenery and public enjoyment.

Small windows facing the street have been extensively walled, for both privacy and security reasons. The height and location of these windows is obviously not coherent with the common perception of Iranian families, regardless of their social class or income status; this could happen in any other place all over the country. The number and repetition of

this interference disturbs the general appearance of the community, creating an unpleasant atmosphere.

The central shopping center, instead of working as the heart of the complex by providing the inhabitants with urban and cultural facilities, has been extensively misused, almost erasing any traces of its role as a livable community center. The existing shops are badly maintained and no longer attractive.

As explained, this complex was never completely constructed; even the first phase was only partly realized. This partial realization hinders fulfillment of the original concept wherein the complex is a livable community, jeopardizing the entire setting. For instance, the mosque, despite its importance and architectural quality, has been left incomplete, while the public bath, now probably unnecessary, has not been regenerated for public service.

Cars, originally and intelligently planned to be parked at specific, external points in favor of social interaction and walking priority, are now either parked in front of the houses or within the garage converted.

A main reason for this treatment is most likely a lack of community awareness regarding the initial concept, as well as an insufficient sense of secu-



Fig. 36: Courtyards have been converted to garages (Author)



Fig. 37: Balconies walled or added to interior (Author)

rity which prevents private cars from being parked in the designated but more distant lots. Now, these parking lots are almost empty.

In sum, these conditions have transformed a complex of great potentiality and vision into a miserable and distressed place, with the lowest property values in the area (Diba and Javaherian 2005).



Fig. 38: Renovation with different materials
 Fig. 40: Semi-public, semi-private greenery walled and added to the property

Fig. 39: Semi-public, semi-private greenery left unattended | Fig. 41: Small windows walled for privacy or security reason (all Author)

4 Conclusion: Obstacles of Idealization

The thematic study of the original ideas and vision behind Shushtar-No uncovers a desire to go beyond conventional styles of housing dominated by the growing modernist approach to the built environment, and to instead open new perspectives on the question of architecture more apt for living in the Iranian context. This concept led Diba to revisit existing housing schemes critically and take benefit from the industrial advantages of the time, while re-interpreting historical principles hidden in the traditional life style. Thus, the original plan was borne of a “vision” or “image” in the mind of the architect, which needed to be realized, built, and lived. The current situation, however, portrays a state of affairs far outside the initial expectation and image. Here, the question is not merely reflecting on the gap between the “vision” and “reality”, but exploring the nature of and reasons behind this schism. Such an inquiry could help any project or design save its “vision” from an extensive “idealization” on the one hand, and to bring the ideal and real as close as possible on the other.

This study shows that the existing schism can be investigated within two major subjects of “architectural thinking” and “management”, the



Fig. 42: Misused shopping center (Author)



Fig. 43: Public parking places are empty (Author)

former addressing the image of the project in the architect’s mind, the latter referring to the later administrative and management issues which are normally out of the hands of architects and planners and highly influenced by external forces and circumstances.

Some of the later challenges and interferences seem to be the result of the initial unrealistic vision of the designer, or at least his, perhaps overly, optimistic approach. For instance, putting low-level windows in

the exterior walls facing the pedestrian streets is against Iranian attention to privacy and security. This is an issue irrelevant of the class or social status of the inhabitants, the desire for privacy and security is the wish of every family. It is due to this concern that almost all of this particular window type have been walled-off or fenced-in. The other issue is designing a semi-private, semi-public green space in front of the apartments in the hopes that inhabitants would be encouraged to maintain it, which, unfortunately, has resulted in a broken, messy, and abandoned piece of land.

The main reason for the current undesirable condition, however, are the later administrative and management decisions. The users and supposed target group were changed, particularly after the Iran-Iraq war created an unforeseen and urgent need to accommodate war-stricken people. This could have become a force for completing implementation of the project, but the unsystematic and unplanned method of sheltering overloaded the partly-realized project, and later shortcomings in providing necessary urban services changed the demographic and socio-cultural situation, leaving space for arbitrary and uncontrolled mismanagement by the inhabitants. Thus, the current situation is more an administrative



Fig. 44: Cars enter the urban texture, despite the original car-free concept (Author)

problem than an architectural one, a circumstance which highlights the importance of management and maintenance in housing projects.

III

Hashtgerd New Town—Background, Vision, and Reality

This chapter aims at revisiting the question of new towns in Iran and studying their objectives and the extent of their success. In this regard, the necessity and the program of establishing new towns will be introduced, and main challenges will be presented. Then, the vision and reality of Hashtgerd New Town will be studied, to shed light on the context in which the Shahre Javan Community Pilot Project would be realized. Different studies will be reviewed to explore the condition of the town, and its current situation will be investigated.



1 New Towns in Iran, Challenges and Opportunities

In 1900 (1279 within the Persian calendar) Iran's population was approximately 9,860,000, only 20.6 percent of which resided in the cities. In 1956 (1335), as the first systematic census of the country shows, the population of the country increased to nearly 19 million, the share of urban population reached 31.4 percent. In this time, Tehran saw a rapid population growth, rising to 1,512,082 inhabitants. Ten years later, the share of urban population grew to 38.7 percent (about 10 million). In 1976, this figure grew to triple that of 1956, with approximately half of the entire population residing in cities. Consequently, the number of cities reached 373, four times what it was at the beginning of the century. This trend continued up until 1996, when the urban population exceeded half of the population, reaching 61.3 percent; Iran had become more urban than rural (Zanjani 2003; Ziari 2009).

These figures make explicit the rapid growth of Iran's population during the 20th century. A fundamental part of this growth can be attributed to the simultaneous and intensive processes of urbanization and industrialization. As a result, cities became attractive to rural people, and they moved to urban centers in search of a better life, and the major cities became attractive for all the people as centers of economic, cultural, and administrative activity.

Following the Islamic Revolution, the last generation of new towns emerged after a pause caused by the Iran-Iraq war and its consequences. In 1986 the government approved construction of twelve new towns

	Population of country (thousands)	Urban population (thousands)	Percentage of Urban Population (%)	Number of Cities
1900	<i>estimated</i> 9,860	2,033	20	99
1956	18,954	5,997	31.4	199
1966	25,078	9,790	38.7	272
1976	33,708	15,855	47	377
1986	49,445	26,845	54.3	496
1996	60,055	36,700	61.3	612
2006	70,495	48,259	68.5	1,020

Tab. 1: Population growth of Iran from 1900 to 2006 (Author, after Zanjani 2003; Ziari 2009)

around the major cities of Iran in an attempt to mitigate the growing social and economic problems facing the megacities, mainly derived from unplanned urbanization and suburbanization advocated by the revolutionary government to support low-income families. Three years later, New Towns Development Corporation (NTDC) was established as the institution responsible for designing and realizing the projects (Talachian 2005). The number of new towns increased to 18 in 1991 (Ghamami 2008).

As of now, 28 new towns are under development, with differing distances from their related mother cities, the shortest of which is Baharestan (15 km far from Isfahan) and the longest being Eshtehard (70 km from Tehran).

In principle, after the revolution, new towns were planned for a variety of reasons: to help house the overflow population of major cities and halt their unchecked growth, to facilitate decentralization of the economy, to restrict informal settlement around the cities, to transfer industrial companies from the metropolises, and, finally, to control suburbanization and its devastating effect on peripheral greenery and agricultural land. The stated goals of the new towns read: "To achieve a balanced economic and social growth and to control [big cities'] aimless development, the best solution is establishing new satellite towns in a proper distance from them. This not only rectifies big cities and decreases their attractiveness, but also changes them to a suitable center for regional economic, social, and spatial development" (Sherkate Omran 1988, p. 20).

The realization and development of the new towns is overseen by NTDC, the main actor of a long provision process. Within overarching national development studies, whose goals and objectives must be met by all local development programs, Localizing Studies (Makan-yabi) are conducted to discover the best site for the new developments. This is preceded by Strategic Area Studies (Motale'ate Mahdoode-ie Rahbordi) which define the area and limits of the new town, after which the Comprehensive Plan (Tarhe Jame) is drawn up to provide a guideline for all the development aspects of the next 25 years. Then, a more detailed framework, called the Detailed Plan (Tarhe Tafsil), brings these guidelines closer to reality, with illustrated maps on 1:500, 1:1,000, and 1:2,000 scales. To fulfill this plan, Preparation Studies (Amadesazi) provide detailed maps for the necessary infrastructure, including street profiles, sewage canals, cadastral maps of plots, etc. At the last stage, NTDC as an independent institution takes the responsibility of realization of the plans, working as the agency which finds and procures the necessary land. Thus, the main task of NTDC is providing Comprehensive and Detailed Plans, supervision of their implementation, offering plots to the clients, preparing necessary infrastructure, and cooperating with related organizations and institutions (Talachian 2005). This process, according to Sa'idnia (2006), is unsuitable for the development of new towns; not only is it very time-consuming, it also does not meet the real needs of the new towns, such that in

some cases, to speed implementation, Preparation Studies are done prior to the Comprehensive and Detailed Plans, and thus a part of the implementation starts even before complete planning and design of the town is finalized.

Despite this reasonable background which supports development of the new towns as a means to attenuate the critical and growing problems of the megacities, the outcome tells us a more disappointing story. In real-

ity, the new towns of Iran suffer from a variety of problems. From the vantage point of policy making and management, the quantitative approach to housing overwhelmed the qualitative approach, a situation escalated by the mass housing production system. The novelty of this topic, and the lack of both relevant experience and practical background, led to crucial problems for the managers as well as for the consulting offices. Moreover, the break in and inconsistency of national policies and strategies, as well as regional priorities, made realization of the initial goals in the given period impossible (Davodpour 2006).

Now, new towns are more dormitory towns for those who are unable to afford renting or purchasing a house closer to their work in the city. In fact, they are a far cry from the original idea of offering sufficient work opportunities for the inhabitants. Therefore, new towns are settled by low-income to middle-income families, mainly employed in governmental or service activities. Due to the lack of urban services, they have failed in absorbing their planned population (Ziari 2009; Eetemad 2004; Gorokhloo and Abedini 2009). A considerable amount of current inhabitants would prefer to leave the new town rather than continue living there (Rezaii and Salahi 2006). Studies show that a sense of place and attachment is weak; the inhabitants feel themselves as temporary residents, not permanent dwellers (Gasemi 2006; Gorokhloo and Abedini 2009; Heidari and Mohammadhoseini 2010). The dominant dependence of these settlements on the big cities hinders socialization and interaction. From an urban design point of view, despite the macro scale endeavors of designers to enhance the quality of space in terms of architectural and urban aesthetics, there is a clear anarchy in the facades and urban vista, due to the lack of any design criteria or code (Majedi 2006).

However, studies show that these problems are not solely characteristic of the after-revolution new towns, but are a general issue for all the new towns. For instance, Fulad-shahr belongs to the third generation of the new towns in Iran (designed in 1966) built some 40 km from Isfahan to provide accommodation for the workers of the Zobe-ahan Industrial Company. A comprehensive study conducted in 1992 shows that more than half of the inhabitants find the city cold and character-less, and many are interested in leaving the complex if possible (Attari 1994; Mashhadizade 2010).

Whatever the current condition of the new towns, they have been massively built and developed, and they will be developed further. What

is now vital is changing the destiny of these settlements, helping them to achieve the character of a true “dwelling place” where all the physical and mental prerequisites are fulfilled. This is not in the hands of an individual person, a designer or an urban planner, nor is it in the hands of an individual institution like NTDCs or City Councils, but rather requires a common intention and holistic action to garner a better future for the new towns.

2 Hashtgerd New Town, Vision and Planning

Hashtgerd New Town was the largest satellite city construction to be approved by the Urban Planning High Council in 1990, with a target population of 500,000 by 2010. It is located 65 km to the west of Tehran, 25 km from Karaj and 75 km from Qazvin . It is 1300 to 1550 meters above sea level. The climate is extreme: hot in summers, cold and very cold in winters; with winters lasting longer than summers, this area belongs to a cold climatic area. Now only 40 minutes driving distance from Tehran by car, this will be reduced to 25 minutes after being connected to the Tehran Metro line. The line 5 of the Tehran Metro is planned to reach Hashtgerd, probably in 2013, now partly realized from Sadegieh in western Tehran to Golshahr.

This new town belongs to the Savejbolag county, formerly one of the 13 counties of the Tehran province, now one of the 4 counties of the Alburz province after recognition of Karaj urban area as a separate province in 2012.

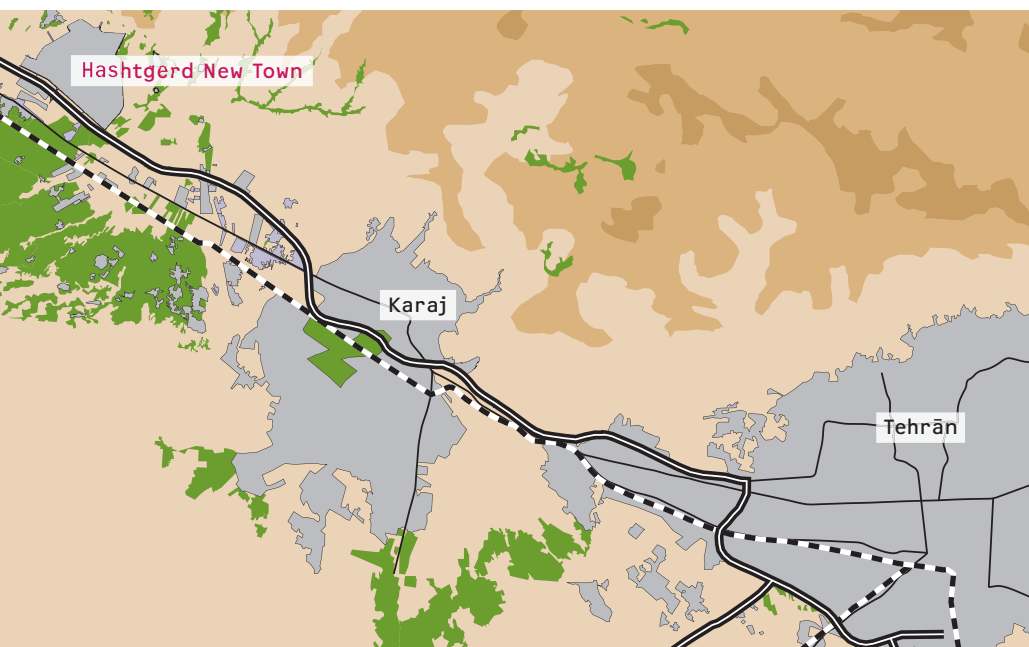

Fig. 45: The location of Hashtgerd New Town (Young Cities Project)

The site was selected according to specific criteria, such as optimum distance from Tehran, available barren land to avoid destruction of agricultural fields, and adequate natural resources such as water. The selected location is in the thousands of hectares of non-agricultural barren, publicly owned land to the west of Tehran. Rich underground water resources could support future urbanization. Moreover, it is well located between two other big cities of Karaj (25 km) and Qazvin (60 km), and is

connected to the surrounding settlements via the Tehran-Qazvin highway (Hashtgerd NTDC 1993).

Tarh-va-Me'mari Consultation provided the Comprehensive Plan in which social, economic and geographic aspects were analyzed at three levels: province, urban area, and physical development of the new town. The resulting surveys clarified that there was rapid population growth in the region, mainly immigrants from other parts of the country (40 percent born outside their present place of residence), with a high concentration of population, employment, production (public as well as private), and services in the city of Tehran. These facts and figures justified the establishment of new towns in the vicinity of Tehran.

The predicted population for Hashtgerd New Town was calculated in two scenarios, for three periods, 1996, 2006, and 2016. The initial plan intended to accommodate 350,000 inhabitants (desired assumption) or 230,000 (probable assumption) in 2016.

From an economic point of view it was planned to transform the town to a semi-dormitory, semi-independent community in 2006, providing job opportunities in industry (35 percent), construction (17 percent), and different social services like commerce and restaurants, transportation, and public works, (about 10 percent each), and others.

From a physical point of view, Hashtgerd New Town is comprised of two sections, industrial (350 ha) south of the highway, and residential (4,000 ha) to the north, with an average density of 140 pph. It was intended that, by 2020, the new town would be connected to the old Hashtgerd, functioning as the main administrative center and converting the old town into a district of the larger city.

The general framework of the new town is a grid-like pattern served by some linear north-south and west-east streets, supplemented by a hierarchy of street networks. A green belt of 600 ha, 200 m deep in the north and 400 m in the south, surrounds the new town. Commercial, cultural, religious, and administrative functions are concentrated at the center. However, commercial buildings are not exclusively within the center but

	1996		2006		2016	
	Population	Population	Growth Rate	Population	Growth Rate	
probable assumption	30,000	102,000	13.0	230,000	8.4	
desired assumption	38,000	143,000	14.1	350,000	9.3	

Tab. 2: Population prediction in Hashtgerd New Town (Hashtgerd NTDC, 1993)

are also distributed throughout. Some urban facilities like parks, a sport stadium, a university, and bus terminals, are located at the exterior area in the vicinity of the green belt.

Local facilities have been distributed according to the urban zones. In Hashtgerd New Town, every urban module located between the main street networks constitutes an urban zone (nahie) with 20,000 inhabitants. There are 23 urban zones in sum. Local facilities have been distrib-

uted in every district and urban zone, to serve at the neighborhood scale and create semi-independent districts in terms of initial public services.

The Detailed Plan of the central area of the new town was prepared in 2004. In it, 16 zones (nahie) were located in 5 districts/phases, aiming at accommodating 238,000 inhabitants in 1858 ha land embracing 186 ha in phase 1, 240 ha in phase 2, 283 ha in phase 3, 489 ha in phase 4, and 137 ha in the Bagh-shahr (garden city) area (Peykadeh 2004).

The 1990s saw the beginning of construction for phases 1, 2, and 3. Up to 2006, the built area reached 521 ha, 123 ha of which was residential, 76 ha was green area, 330 ha was public access (streets), and 319 ha was other urban services (Peykadeh 2008). In 2009, about 37 percent of phase 1, 2, and 3 was developed, 56 percent of which was dedicated to streets, 27 percent to residential uses, 17 percent to other uses (Azizi and Arbab 2010).



Fig. 46: First Comprehensive Plan of Hashtgerd New Town (Tarh-va-Me'mari Consultation)

Eighteen years after the commencement of planning and construction, it was necessary to revise the original Comprehensive Plan to adapt it to social, economic, and demographic changes in the region, to address obstacles to the realization of the plans, and to facilitate its construction from administrative and legal points of view. In 2008, Peykadeh Consulting Engineers released the results of the revision and proposed some changes in the physical, managerial, and socio-demographic dimen-











sions of the new town. These changes focused on the periphery of the central part, since the central area was mainly built up or sold. To achieve optimal distribution of urban facilities, a mediatory scale of “district” (mantageh) was added; the city was divided into 5 districts and 19 zones (nahie). A flexible mixed use area was to provide room for later necessary land uses. The green belt was converted to major urban services such as sport facilities, a hospital, and a university, justified by the idea that this amount of green belt is too large to be maintained carefully. To enhance the quality of the urban landscape, establishment of a controlling office was proposed to approve all the plans and designs and to permanently monitor their complete realization.



Fig. 47: Detailed plan of the central area, First Comprehensive Plan of Hashtgerd New Town (Tarh-va-Me'mari Consultation)



Fig. 48: Revised comprehensive plan (Young Cities Project, after Peykadeh Consulting Engineers)

- | | | | |
|---|-------------------------------|---|--------------------------|
|  | Buildings Hashtgerd |  | Technical Infrastructure |
|  | Residential |  | Utility |
|  | Social Infrastructure |  | Green |
|  | Service/Retail Infrastructure |  | Highway |
|  | Mixed Use |  | District Boundary |

3 Hashtgerd New Town, Reality

In general, this town was, to a great extent, unsuccessful in absorbing the over-population of the peripheral big cities and meeting its objectives (Gorokhloo and Panahandeh-khah 2009). In 1996, the population reached only 1,200, far from the planned population of about 30,000. Although the predicted population for 2001 was about 56,000 and about 102,000 for 2006, its population grew only to 15,736, far from the initial objective (Zabardast and Jahanshahloo 2007). It was estimated that in 2007 population rose to 19,298. Approximately 40 percent of the already sold parcels are not yet developed, of the 8,895 erected units, only 5,145 units have been occupied as of 2005.

Surveys and studies have been regularly conducted which shed light on the current condition of the city from a variety of perspectives. A study conducted in 2004 shows that in general, the inhabitants are mainly young families, with a high rate of literacy and average level of education (majority with High school certificate). They are generally employed in either industrial or public service sectors, mainly in Hashtgerd New Town or its vicinity (78 percent) and partly in Tehran (19 percent). The majority of the inhabitants had their original residency in Tehran (49.2 percent), the vicinity of Hashtgerd New Town (31.7 percent), and in Karaj (16.6 percent). The main reason (31.2 percent) for moving to this town was the cheaper price of housing, and closeness to the working place (26.1 percent). The inhabitants suffer from a lack of important urban facilities, such as medical centers, greenery, poor public transportation, and poor educational facilities, forcing the majority of them (72.5 percent) to leave the city everyday to fulfill their needs in neighboring locations. However, 80.8 percent are satisfied with their life, and 70.7 percent are satisfied with their residency in the city (Rahmani 2004).

Another study conducted in 2004 confirms the above mentioned results. About 39.4 percent of the current population has come from Tehran, 18.2 percent from Karaj. Thus, in general, 57.6 percent of the inhabitants

	1996 (Markaze Amar)	2002 (Estimation of Peykadeh)	2006 (Markaze Amar)	2007 (Estimation of Peykadeh)	2007 (Markaze Amar)
Hashtgerd New Town	1,200	9,800	15,736	19,298	18,598

Tab. 3: Population of Hashtgerd New Town (Markaze Amar 2011 and Peykadeh 2008)

are from Tehran and Karaj; this trend meets the initial goal of the town regarding absorbing the overpopulation of Tehran and Karaj. For 42.7 percent of the people the main reason for living in Hashtgerd New Town was the cheaper price of housing; only 26.1 percent settled due to better living conditions, 20.6 percent came to be closer to their work. In general, the satisfaction with life in the town as well as the intention to abandon the town is average (Zabardast and Jahanshahloo 2007).

These figures are mostly acknowledged by the Comprehensive Plan Revision (2008). The majority of the inhabitants have moved from Tehran, its peripheral cities, or Karaj. 31.2 percent of the workers work in the vicinity, 16 percent must commute between Tehran and Hashtgerd New Town. The main problem is the insufficient urban facilities, including educational, cultural, recreational, medical, and police facilities. Daily traffic is mainly inter-city (64 percent). The destinations of external journeys are old Hashtgerd (45 percent), Tehran (19 percent), and Karaj (13 percent). With a car ownership of about 50 percent, daily traffic is done by private vehicle (40 percent) or public transportation (39 percent), including taxi and private taxis (Peykadeh 2008).

A later survey conducted in 2009 explores the status of identity in Hashtgerd New Town, clarifying that in general, the sense of identity is slightly under average, showing that phases 1 and 2 offer a better sense of identity for the inhabitants than following phases. This indicates that the longer the residency, and the more the inhabitants are satisfied with their life, the greater the sense of identity. This study also reveals that satisfaction with life and security, as well as the trend to dwelling permanently in this town is average (Azizi and Arbab 2010).

From the point of view of the urban design and architectural quality, it can be said that, despite the observable order in the master plan of the town, the current cityscape is somewhat disorganized and chaotic, high-



Fig. 49: View to the public space of one of the residential quarters with apartment buildings (Author)



Fig. 50: View to the Municipality building at the central square (Author)

lighting the lack of a permanent and effective monitoring and supervision by the municipality and urban management, very similar to most other Iranian cities where the cityscape does not follow a clear logic. In general, the urban and architectural quality of Hashtgerd New Town suffers from two major problems. On the one hand, the dispersed construction of the town, where the population and construction density is distributed heterogeneously, creates a non-uniform cityscape. Moreover, partial construc-

tion of the space, particularly the public spaces, has led to a poor urban atmosphere, for example where the central public spaces and greeneries have been left unattended and non-realized. On the other hand, uncontrolled interferences in commercial spaces, particularly in the central parts such as shopping centers, have generated a chaotic cityscape. In terms of architectural quality, constructed residential and non-residential buildings follow the same regular and common architectural typologies, so that no remarkable change in quality is observable, thus the current condition does not suggest any innovation or creativity.

As far as the future of Hashtgerd New Town is concerned, the Maskane Mehr (Mehr Housing) project will soon change its perspective. Mehr Housing is an initiative by the government to provide residences for low-income or middle-income families all over the country. Partly financed by the owner, the government assigns small units to the dweller in a long term reimbursement process at the end of which the dweller owns the house. Massive housing projects constructed with a low-middle quality and low cost hold small apartment units suited for young families.

Hashtgerd New Town was the second biggest site, after Parand new town, for the Mehr Housing development in Tehran province. In 2011, 1,000 residential units were completed, 50,000 under rapid construction. This mass housing production will change the demographic characteristics of the new town, and consequently its socio-cultural as well



Fig. 51: View to the central commercial zone (Author)



Fig. 52: View to the central Mosque and cultural centre (Author)

as economics status in the near future. A simple calculation shows that with the existing family size of 3.6 (census of 2006) this housing program may absorb 180,000 new dwellers and raise the entire population to about 200,000 in a short time—10 times its current population—which may later increase further to meet the probable assumption of 230,000 for 2016. This estimation seems to be very optimistic taking into account the existing condition of the Hashtgerd New Town in terms of urban facilities and

its attractiveness for living on the one hand, and the Mehr Housing project and its submission policy-people may consider it as an investment tool rather than residency place-on the other. However, even only partly realizing the Mehr Housing project, and with just partial occupation of the built residential units, the future of the city will still be greatly affected.

This implies that in the near future Hashtgerd New Town might be significantly changed due to its demographic growth, and consequently all the indicators such as satisfaction with life, social interaction, sense of attachment, trend to staying, and commuting between the neighbouring settlements, will affect its current status as a dormitory city. In this variable condition any solid prediction in these fields seems to be impossible; what is certain is the unpredictable but different future of the Hashtgerd New Town.

This ambiguity might be escalated after the separation of Karaj from the Tehran province and the establishment of the Alburz province, since Hashtgerd New Town is no longer understood as part of Tehran, but as a satellite city of Karaj. It is not clear if the Tehranis would still be interested in residing in Hashtgerd New Town when it belongs to another province.



Fig. 53: View to the residential quarter with lower density (Author)



Fig. 54: View to a school (Author)

4 Conclusion: The Fragile Future of Hashtgerd New Town

Taking into account the initial plan, revised plan, and the existing condition of Hashtgerd New Town one may come to the conclusion that this schema is unsuccessful in meeting its objectives and goals. However, the reality is that efforts have been made to implement the plan and, up to now, a huge amount of construction has been done, with a considerable extent still under construction. In other words, although the future of Hashtgerd New Town seems to be fragile, a realistic approach to the question of New Towns in Iran is not stopping its realization, but revising its objectives in a more realistic way, encouraging more investment from governmental and private sectors, implementing initiatives to solve the problems, and making them more attractive to current and potential inhabitants. A promising initiative could be envisaging innovative plans and programs for the new developments and enhancing quality of life, thus promising a better future for the inhabitants. The Shahre Javan Community Pilot Project is an attempt of this kind.



Fig. 55: Cityscape, a panorama view to the town (Author)



IV

The Shahre Javan Community— Background and Vision

This chapter focuses on the Shahre Javan Community Pilot Project: its layout, goals, and objectives. First, the background of the research project and its structure will be introduced. This will be followed by presenting the Shahre Javan Community Pilot Project and providing a thematic review of its vision as conceptualized by the design teams, encompassing the different aspects and dimensions. This review will provide a base for the later comparative studies.



1 Background

The Future Megacities Program is funded by the German Federal Ministry of Education and Research (BMBF). As a part of the “Framework Program—Research for Sustainability”, it contributes to BMBF’s “High-Tech Strategy for Climate Protection”. The main goal of this research initiative is to create examples of best practice sustainable urban development.

In this respect, the project covers a wide thematic and geographic breadth, dealing with great urban agglomerations in China, Ethiopia, India, Iran, Morocco, Peru, South Africa, and Vietnam. The emphasis of all the research is “prevention and therapy” instead of just “diagnose”, and is focused on specific energy- and climate-efficient structures in areas of housing and construction, nutrition and urban agriculture, public health and quality of life, urban planning and governance, direct energy supply and consumption, mobility and transport, water supply, waste treatment, and environmental management.

This research establishes close cooperation between the German and local partners and institutions, academic as well as administrative. It also includes political, economic, and societal stakeholders to make it more place-specific.

2 Young Cities Project

The “Young Cities: Urban Energy Efficiency. Developing Energy-Efficient Urban Fabric in the Tehran-Karaj Region” is one of the abovementioned research projects which aims to “develop methodologically sound solutions for implementing low carbon, climate change resilient housing within the specific climatic, environmental, cultural, and economic context of Iran” (Seelig, Ohlenburg and Pahl-Weber 2012a, p.10). It intends to achieve substantial improvements in energy-efficiency by means of changing linear mass and energy flows towards an interlinked urban system of urban form, technical infrastructure and object planning, accompanied by assessment and management. Thus, the main goal is “developing methodological and applicable solutions for low carbon and resilient housing in the specific climatic, cultural and economic context of Iran” (Seelig, Wehage and Pahl-Weber 2011). Technische Universität Berlin is the main director of the project in cooperation with two other Berlin-based universities and a few other research or professional companies. The cooperative partner in Iran is the Building and Housing Research Center (BHRC), a research institute under the Ministry of Roads and Urbanism. It also includes The New Towns Development Corporation of Iran (NTDC), the Housing Investment Company (HIC) and some other academic and professional companies as well as NGOs.

The research is conducted by four teams which cover different scientific disciplines involved in the project, including Urban Development and Design, Urban Infrastructure Systems, Design, Structure and Engineering, and a supplementary Supporting Module which consists of four dimensions: Project Management, Environmental Assessment, Capacity Building, and Awareness Raising. Team 1 consists of five dimensions of Urban Planning and Design, Urban Design and Architecture, Landscape Planning, Transport and Mobility, and Climatology. Supported by the dimension Environmental Assessment, the team works on developing and applying energy efficient, climate responsive, and sustainable planning and management concepts which integrate urban design, architecture, transport, and landscape planning on a nearly 45 ha Shahre Javan Community Pilot Project area. Team 2 includes three dimensions of Energy Management, Water and Wastewater Management, and Integrated Urban Technologies, and focuses on testing and implementing integrated water and waste systems, as well as energy supply systems.

Team 3 consists of dimensions of Structural Design, Architecture and Engineering, and Building Services Engineering, designing objects and buildings while taking into account optimized structural design and efficient building technologies, materials, and installation systems as a part of the Shahre Javan Community Pilot Project.

Within and in the close vicinity of the Shahre Javan Community Pilot Project are some single pilot projects with different functions and

objectives. The first one is the new Quality Building, a five story apartment building which consumes 50 percent less energy than conventional Iranian apartment buildings and was completed in 2010. The New Generation Pilot Project Educational Building is located to the south-east in the opposite corner of the Shahre Javan Community area. Called the LIFEcenter, it is a center for Learning, Information, Forum and Exhibition, an educational building for vocational training to implement and train modern and sustainable building methods on site (Böhm and Mahrin 2011). The New Generation Office Building is another pilot project located in the south-western corner of the Shahre Javan Community area. The main objective of this building is to reduce energy consumption and improve internal thermal comfort by means of architectural design (Nasrollahi and Steffan 2011).

This project targets three scales: defining criteria for energy-efficiency in Hashtgerd New Town and other semi-arid regions at the neighborhood scale; developing and implementing adequate planning and design strategies in the form of a real-life planning project in Hashtgerd New Town and its subsequent evaluation; and finally elaborating manuals and guidelines for energy-efficient and resilient urban planning and design in Iran and the MENA-Region.

The employed methodology is a “research by design” approach; the planning and realization processes of the pilot projects are the main basis for scientific results.

3 The Shahre Javan Community: Objectives and Goals

To realize innovative ideas concerning a livable energy-efficient neighborhood, this project has selected a nearly 45 ha site as the main Pilot Project in which the entire area will be designed from urban infrastructure to housing scheme and public space. In other words, it is the site of realization of the particular measures and innovations developed by the research groups of the project. This site, marked by NTDC for this purpose, is located in the south of Hashtgerd New Town and is supposed to accommodate about 8,850 residents in 2000 housing units. Thus, “The area is developed in a trans-disciplinary manner tying together the Dimensions of urban planning, urban design, architecture, landscape planning, transportation planning and mobility management, urban climatology, water-, waste water- and energy management. Accompanying measures are con-

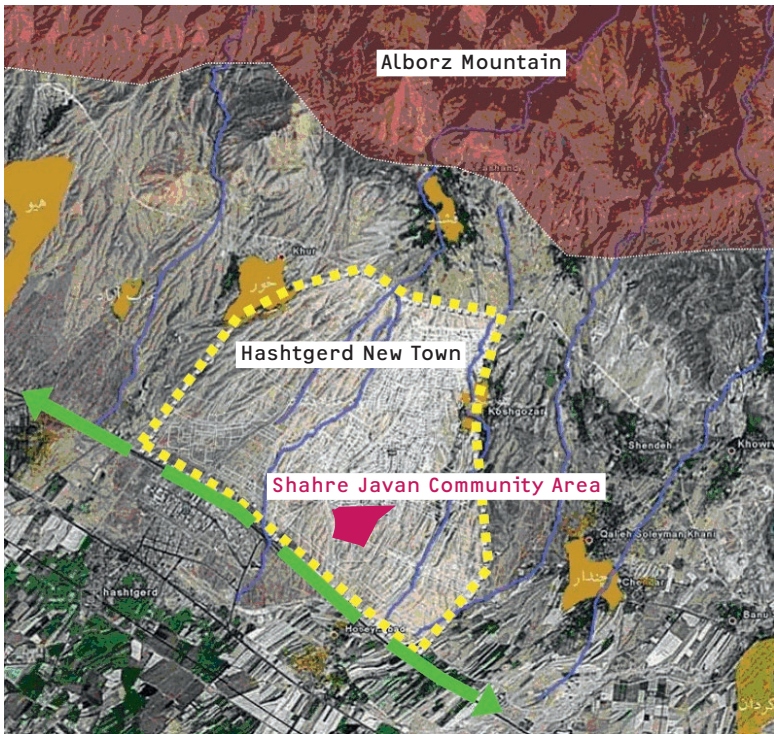

Fig. 56: The location of Shahre Javan Community Pilot Project in Hashtgerd New Town, Aerial view (Author, after Young Cities Project)

ducted through participation, capacity building, environmental assessment and accompanying monitoring” (Pahl-Weber, Seelig and Ohlenburg 2011, p. 60).

Based on this approach, the Shahre Javan Community Pilot Project plays an essential role and has to cover a range of advantages, listed below (Ibid., p. 61):

- It serves as a tool to collect information, by efficiently clarifying the local conditions,
- As a pilot project it is a clearly defined task, with a fixed team and budget,
- It follows a “research by design” method, fostering constant feedback loops between design and scientific evaluation leading to applicable and concrete solutions,
- It raises awareness, given that the aims of the Pilot Project are adapted in the planning process (through feedback loops),
- It fosters communication within the Project since it is elaborated through a conversational process encouraging exchange between the partners,
- It is a model project and thus excluded from daily routine, allowing for innovative and new approaches,
- It is a laboratory to elaborate approaches for subsequent scaling-up of the solutions.

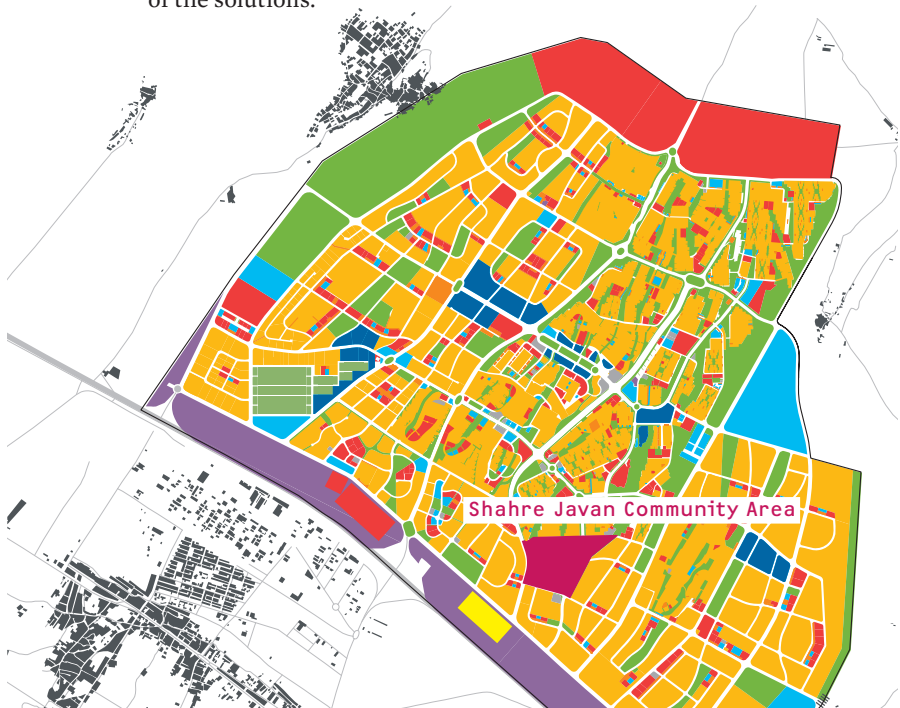

Fig. 57: The Location of Shahre Javan Community Pilot Project in Hashtgerd New Town Comprehensive Plan (Author, after Peykadeh 2008)

The employed research methodology is combined, depending on the goal of every stage. It includes a literature review of existing knowledge as well as analytical reading of best practices. Any planning proposal is verified by model simulations using different software tools and programs such as Envi-met, VISUM, VISEVA+, ECOTECT, ENERGYPLUS and others.

4 The Shahre Javan Community: Thematic Review of the Vision

4.1 Source of Architectural and Urban Inspiration

A close examination of the existing urban pattern in Hashtgerd New Town shows that the topographical situation is largely ignored; all the plots are arranged in a rectangular layout with a common width of 15 to 18 m. The positioning of building volume follows the conventional regulations of the urban planning system prescribed for all the cities. Thus, “The linear arrangement of the buildings makes for uniform linear open spaces oriented towards the public and private sides of the houses,” as seen in figure 58 (Wehage and Pahl-Weber 2012, p. 39). An enclosed wall delineates the plot area, and cuts it from the outside. This project tries to go beyond this conventional urban layout and open new perspectives.

To achieve a place-specific approach to the urban design, the traditional Iranian-Islamic city was taken as the main source of inspiration, providing principles and ideas for designing an optimal urban form for this neighborhood. Based on a literature review, the main characteristics which deserve attention are: the access, composed of different sized pathways that create a clear spatial hierarchy between public and private spheres; the introverted courtyard house which combines privacy, social interaction and protection against climate, in addition to providing light for the interior; the compact, attached housing arrangement which minimizes the amount of exposed surfaces, reduces cooling and heating demand, and provides thermal comfort by creating external spaces that



Fig. 58: Existing typical housing typology and urban pattern (Wehage and Pahl-Weber)

are sheltered from direct sunlight; narrow lanes bordered by high walls which create well-shaded spaces during hot summer afternoons and protect inhabitants from harmful winds; and finally, the proximity of different land uses, which are functionally separated by the access network, providing an appropriate amount of privacy while simultaneously providing easy access to services (Ibid.). As will be discussed later, different parts of the project, particularly the aspects of urban design and architec-

tural design, attempt to interpret these characteristics in a modern way at different scales, from quarter to neighborhood to single building, in order to bridge between modern and traditional modes of spatial configuration (Seelig, Wehage and Pahl-Weber 2011).

4.2 Urban Layout

The entire area consists of twenty-nine compact neighborhood clusters, organized in four rows, and located on the ridges of the site's hills stretching from north to south. Every cluster is an average of 100m long and 60 m wide, accommodates 250–300 residents, and surrounds a central space (15 m by 30 m) around which four building groups are situated. This semi-public, semi-private space is the core of each residential cluster and provides the inhabitants with a common space to help foster the coherence of the neighborhoods (Seelig, Wehage and Pahl-Weber 2011). To access the clusters, one must walk through a narrow 6-meter wide street which connects the neighborhoods from north to south and east to west. Clusters are car-free zones, except for service and emergency purposes; parking is provided in underground parking lots below the neighborhood units.

Access to the area is by two main north-south roads, with a reduced road width of 13 m. Residential clusters are accessible by foot and bike through a six meter wide path from the access streets of the quarter. Cars are not welcome in the residential areas, except for service and emergen-



Fig. 59: Site plan of the Shahre Javan Community Pilot Project (Wehage, Seelig, Pahl-Weber)

Fig. 60: Land use plan of the Shahre Javan Community Pilot Project (Seelig, Wehage, Pahl-Weber)

cy vehicles. Cultural and educational services including a mosque and elementary schools are located at the heart of the complex. The shopping center is located at the south-western border to serve on a regional scale.

Urban layout gives priority to the existing local topography of the site, taking advantage of the natural landscape and vegetation. To avoid extra earth moving work, all the clusters are located on the ridges of the hills, with main accesses in the valleys. The green corridor on the eastern

edge of the area has been preserved. Moreover, housing height is limited to three stories to keep views to the surroundings open. All these measures attempt to adapt the urban layout to the existing conditions and to take benefit from natural forces.

4.3 Compact Urban Form

Compact urban form has been a main concept in developing the Shahre Javan Community area. The source of inspiration for the design team is the dense and compact urban form of the traditional Iranian city, which presents a clear hierarchy of public, semi-private, and private spaces and access systems (Wehage and Pahl-Weber 2012). Therefore, the proposed urban pattern is fairly dense, the average floor area ratio is 1.6, the equivalent of 228 persons per hectare. Perhaps counter-intuitively for its denseness, this pattern actually helps to preserve an appropriate level of privacy for the residents.

The compact urban form pattern can enhance resource efficiency; this model is suitable for the implementation of decentralized disposal systems, such as waste water treatment, as well as developing energy-efficient grid-bound supply systems. Simulation studies show that the em-



Fig. 61: Compact urban form in the traditional Iranian city, Isfahan



Fig. 62: compact urban form in the Shahre Javan Community Pilot Project (Wehage, Seelig, Timme, Pahl-Weber)

ployed pattern of compactness can remarkably reduce direct solar radiation and thermal loss, as well as the cooling demand by producing natural shade. However, despite claims about the contribution of high-density to a more sustainable urban life, a solely quantitative approach is not able to achieve this goal, “a more qualitative approach to urban growth” is urgently needed (Seelig and Pahl-Weber 2012, p. 35).

4.4 Mixed Land Use

The area's compact urban form has been combined with a mixed land use schema to achieve a more livable, vital, and flexible urban life for the inhabitants. The mixed use capacity of the area is realized in two dimensions, both horizontal and vertical. Horizontal mixed use means mixed horizontal distribution of different kinds of land uses over the entire area, including residential, commercial, educational, and cultural ones. Since larger land uses with regional capacity could intensify traffic, these structures, such as the shopping center, office buildings, and the secondary school, are located at the edge of the area. Social land uses are located in the center to make them accessible by walking, including the mosque, attached cultural functions, the kindergarten, and the primary school. At the neighborhood scale, commercial activities are mixed within residential units.

Finally, the idea of “vertical mixed use units” has been introduced on the sub-neighborhood scale around the courtyards of each sub-neighborhood to provide both commercial and social functions within the walking distance. These small commercial units can be used for “small scale commercial and social uses, such as convenience shops for the daily needs, service units for the supply of the neighborhood (crafts, restaurants, copy shop, barber) and small scale social amenities (e.g. neighborhood center)” (Seelig, Wehage and Pahl-Weber 2012a, p.73). Thus, inhabitants walk through the residential quarter to experience and enjoy this pattern of mixed use, which simultaneously enhances their social contact.

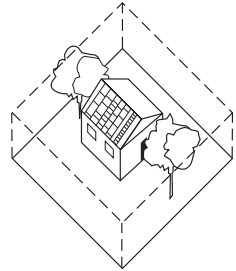
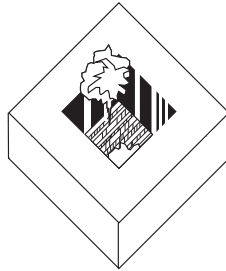

Fig. 63: The pattern of vertical mixed land use (Seelig, Wehage, Pahl-Weber)

Fig. 64: Introverted courtyard typology versus extroverted typology (Wehage and Leubert, after Mansour)

4.5 Housing Typology

The traditional housing scheme based on introverted arrangements of space, was at one point transformed into an extroverted arrangement which threatens principles of privacy and intimacy, and this scheme has become the main urban pattern applied for the New Towns, among them Hashtgerd New Town. This project intends to go beyond this dominant pattern and introduce new housing typologies. Defining the housing ty-

pology, however, is not an isolated endeavor; it is fundamentally related to and influenced by the exterior and existing parameters of urban design, users, codes, energy-efficiency measures, sense of place, and vernacular architecture. For example, housing typology must be adapted to the already developed urban design pattern, as well as to a number of “hard facts” including “The system of access as part of the mobility system, the technical infrastructure, the plot orientation and the design-requirements to avoid earthquake hazards, form preconditions of the site” (Pahl-Weber et al. 2011). Moreover, some “soft facts,” such as identity and flexibility, require a sensitive approach in the architecture. Thus, any housing typology has to meet diverse parameters and prerequisites.

In pursuit of the most climate-sensitive architectural typology, the courtyard prototype offers the best option by which “a more constant micro-climate” can be achieved. As a climatically appropriate form dominant in traditional Iranian cities, this prototype has been employed in the Shahre Javan Community area by introducing a contemporary interpretation of the courtyard house. This typology must be adaptable to different plot sizes, provide space for mixed uses activities, encompass a hierarchy of access, have the optimal climatic orientation, utilize regional technologies, and follow a “low rise-high density” pattern. Another important factor is the “demand for absolute privacy”: the home is the final step through a hierarchical order to the private realm. Thus, the intro-

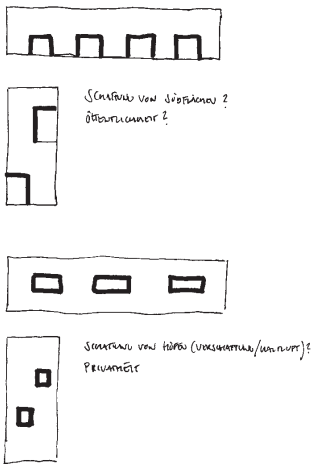

Fig. 65: The pattern of courtyard housing (Wehage, Wolpert, Pahl-Weber)

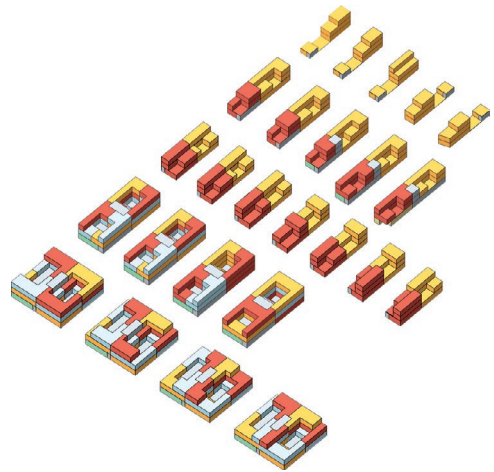

Fig. 66: Variety of alternatives for housing typology (Wehage, Pahl-Weber)

version of the traditional courtyard house “allows for a climate adapted dense urban configuration and for privacy as the main requirements of the socio-cultural context” (Wehage and Pahl-Weber 2012, p.39). To achieve this, a hierarchical system has been developed in the interior layout of the traditional house, from public to private, reflected in the organization of interior areas dedicated to family life, guests, and strangers, around a central courtyard.

Based on this concept, two to three-story stacked courtyard houses, with an unusual depth of 20 to 35 meters, have been designed with a north-south orientation which maximizes energy potential and a vertical organization which provides sun for every residential unit. Moreover, the buildings have terraces and niches in the upper floors to increase solar radiation for energy production. Thus, “The flexible organization of floors around the courtyard allows for zoning of the living rooms depending on privacy and climate” (Wehage and Pahl-Weber 2012, p. 41).

Different types have been defined according to the plot areas foreseen in the urban design scheme. In general four types have been identified, with 6, 7.5, 9, and 15m width, providing different unit areas from 60 to 180m². In each typology, interior courtyards ensure privacy and offer livable micro-climatic conditions. These typologies, however, have to be re-formulated into various morphological alternatives to fit the characteristics of a given plot. Figure 66 shows some possible morphological alternatives.

In general, access to the houses is either through an entrance on street level or by an additional entrance from the parking garage in the basement. A hallway functions as a mediatory space to the central stairway which connects the upper and lower levels and may be used as a vertical interchange element. To prevent the privacy of the residential units through a hierarchy of spaces, and to enhance mixed use pattern on the



Fig. 67: Perspective to the sub-neighborhood (Wehage, Pahl-Weber)

Fig. 68: Ground level of the sub-neighborhood (Wehage, Wolpert, Pahl-Weber Pahl-Weber)

ground floor, the area facing the street is considered as a potential commercial unit for providing services at the neighborhood scale. The issue of privacy is also ensured by a vertical organization of space, such that the apartments located around a central courtyard enjoy a variety of private areas inside, and to the extent that areas for guests, services zones (like kitchen, baths, inner stairway etc.) and private family life can be individually organized due to the flexibility of the structure.

As can be seen in Fig. 68, every sub-neighborhood has its unique size and dimension, resulting in different types and consequently different plans and spatial configurations. In this sub-neighborhood, the northern blocks have two ground-level apartments, each occupying both the first and second levels, while in all, except for two, the southern side has been dedicated to local commercial space. In the southern blocks, each housing-row has two two-story (duplex) apartments with separated courtyards.

4.6 Climate Sensitivity

This project is environmentally sensitive in a variety of aspects, to derive benefit from the natural potentialities of the location. By employing a compact urban pattern, direct solar radiation is reduced and thermal loss is decreased, since minimizing the exposed building surfaces by minimizing the surface-area-to-volume (SA:V) ratio affects the thermal loss of the building.

All the buildings of the area have been oriented towards the south to reduce cooling demand (by 23 percent) and heating demand (up to 16 percent). Moreover, the compact urban pattern produces enough shade to



Fig. 69: View to public space at the sub-neighborhood (Wehage, Wolpert, Pahl-Weber)



Fig. 70: View to the courtyard of a residential unit (Wehage, Wolpert, Pahl-Weber)

also contribute towards reduced cooling demand. The advantage of this pattern is not limited to the indoor space; outdoor thermal comfort is also considerably improved.

In terms of the wind, prevailing north-western and western, as well as hot and dusty winds from the southeast in summer, are blocked by the particular arrangement of the buildings, at the same time that the northern cool winds are channelled through the site and passed through the

urban texture. Open green spaces will cool down the air and increase humidity through evaporation. The mixed use scheme contributes to environmental preservation by means of reducing travel demand for everyday needs and encouraging walking and cycling, thereby reducing CO₂ emissions.

On the scale of single buildings, the courtyard prototype supports ventilation, allows natural cooling, and reduces direct exposure to the sun. North-south orientation and the unusual depth, 20 to 35 meters, of the buildings both help to maximize energy potential. Direct sunlight is made available to each of the units via the vertical scheme of the buildings.

The housing alternatives southern façade is the main source of benefit from solar energy and optimal sunlight. The design is of a flexible façade which regulates light and sun.

4.7 Appropriated Technology

The compact urban form of the Shahre Javan Community area allows for efficient energy supply with the employment of a grid-bound supply system. This translates into an energy concept based on heating through co-generation of heat and power from natural gas and distribution via dis-



Fig. 71: Energy concept for the Shahre Javan Community area (Nytsch-Geusen, Huber)

trict heating networks, while cooling takes place through solar cooling in decentral absorption chillers powered by thermal power and district heating.

For water and waste management, a decentralized treatment system with middle-technology has been developed “in order to provide a reliably working system” appropriate for the Iranian context. This method keeps about 70 percent of water in the local cycle. Gray water from

bath tubes, showers, sinks and washing machines will be collected separately and treated in decentralised, vertical flow, constructed wetlands. Constructed wetlands (CW) are based on a robust and well developed low-tech solution and have low maintenance demand. To reduce piping, CWs will be located close to the houses. The particular topography of the site enables natural gravity transport of gray water. The treated gray water has a very high quality and can be reused for non-in-house purposes, such as irrigation of green spaces and service water (Nuñez von Voigt and Vocks 2012). Black water is not treated due to the complex, high-tech system needed. The rain water will be collected in a separate sewer system and reused for the artificial water body. Accordingly, approximately 50 percent of water will be recycled locally (Seelig 2011)

Within the housing typologies, a middle-technology option has been developed to enhance optimal use of natural sunlight. The non-load-bearing part of the outer façade has sun shutters, the regulation of which changes the energy-impact throughout the day and the seasons, as well as offering graduated control over the privacy of the inner living spaces. In this regard, two measures have been considered to maximize natural light and minimize summer heat. In front of all openings is a flexi-

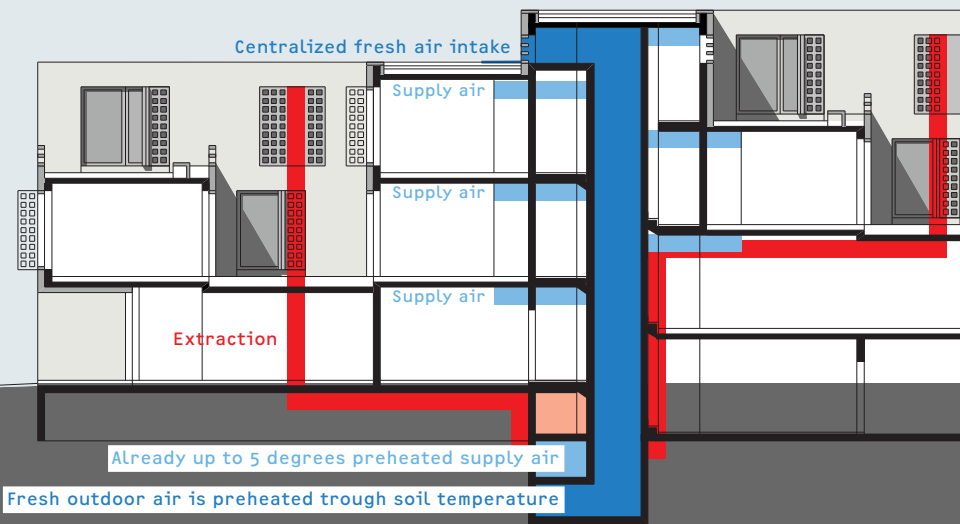

Fig. 72: Sub-soil energy use as example for energy saving heating technologies (Wolpert, Wehage, Pahl-Weber)

ble shutter which can be opened in winter to capture as much daylight as possible and maximize the solar preheating of rooms. This shutter can be closed in summer time to avoid overheating. Moreover, some large rotatable light shelves are in service to control the atmosphere of the courtyard: with a depth of 60 and located a distance of 120 cm apart, they can provide shade and moderate the temperature of the courtyard in summer time. Alternatively, a sun screen made of photovoltaic fabric can cover the

courtyard in summer time to prevent overheating and produce energy. In the evening this energy can be used for lighting. In the winter, the fabric could be rolled back up to allow more sunlight inside.

A central air supply and intake system will be developed at a sub-neighborhood scale to use subsoil energy to provide heat exchange for warming as well as cooling purposes. In this scheme, possible construction methods are all simple and regionally available: pre-fabricated in-situ construction methods, or a combination of semi-precast-elements.

4.8 Mobility

The main principle of the traffic strategy is to reduce traffic and increase mobility within the quarter by means of provoking a shift of mobility routines by supporting ecologically friendly means of transport and providing modern, efficient public transport network. This traffic scheme, moreover, aims at increasing accessibility, traffic safety, flexibility, and energy efficiency on the one hand, while reducing CO₂ and noise emissions on the other. In this regard, the concept combines “push” and “pull” strategies, using hard and soft policies placing motorized traffic as secondary in importance. The objective of soft policy is to provide the in-



Fig. 73: Traffic concept of the Shahre Javan Community area (Döge, Arndt)

habitants with information, i.e. mobility information packages, which encourages them to shift towards eco-friendly traffic behavior. Hard policy, on the other hand, addresses physical aspects of public transport, footpath, and bicycle systems. In this regard, a hierarchically structured public transport system has been developed, consisting of LightRail/Bus Rapid Transit (capacity: 2,000–30,000 Passengers/h, Catchment area: < 300 m), Citybus (capacity: 1,000–4,000 Passengers/h, Catchment area:

250m–300m), and local-neighborhood bus (Minibus, Catchment area: < 250 m) (Döge and Arndt 2012).

This scheme is supported by the dense mixed land use urban pattern of the quarter, since in this pattern local services are available within walking distance. Traffic simulations with VISUM prove that the employed land use concept for the 35ha area, when compared to functionally separated land use concepts, can reduce individual car trips by 3 percent, as well as reducing public transportation trips by 7 percent. In this quarter, central location of the social amenities provides easy, by-foot accessibility for most of the inhabitants in a catchment area of 300m. Other local services, such as the shopping center and secondary school, are located at the quarter’s border. “This keeps motorized traffic out of the quarter, [and] ensures efficient access with public transport” (Ibid., p. 87). In overview, the area is surrounded by a high capacity transportation system of citybus and Bus Rapid Transit, before developing a Light Rail Transit which will be connected to the Hashtgerd-Karaj-Tehran Metro line. The residential clusters and neighborhoods will be served by a minibus line with stops a maximum of 250 m from any residential unit. Street parking is forbidden, except on the surrounding roads. Taxi stops are also avail-

Main Road [RASt 2006: p. 60]

- $v_{max} = 50 \text{ km/h}$
- two lanes
- conceptual requirements: public transport (BRT/LRT), 1,600–2,600 car/h
- border space equipped with additional green or parking places

(according cross section 11.13 RAST 06)

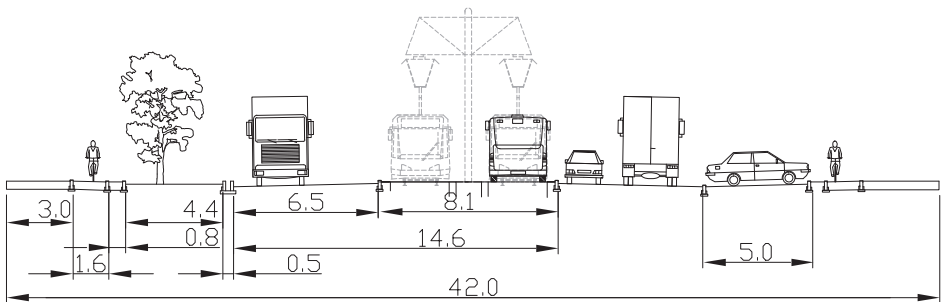

Fig. 74: Cross section of the main road (Döge, Arndt)

able, combined with car sharing stations. Pedestrian and bicycle paths are provided in separate lanes.

Sub-neighborhoods are closed to cars, except in emergency cases. Parking spaces for the residents have been provided in underground parking lots.

4.9 Landscape Planning and Environmental Assessment

Landscape Planning and Environmental Assessment consider different environmental factors and ecosystem functions, supporting environmental protection and enhancement, as well as human recreation. As mentioned, the urban gross density is equivalent to 228 persons per hectare, which is achievable with a more compact urban form and reduced built-up areas. In general, 56 percent of the area is built-up area, compared to 72 percent of the Comprehensive Plan proposed by NTDC (Seelig, Wehage and Pahl-Weber 2012a, p.74). This implies availability of more un-built space potential for improving the microclimate through a reduction of the heat island effect and thermal stress.

Based on an Environmental Assessment of the draft land use concept, the urban land use has been modified to preserve valuable biotope structures (eastern valley). Several changes are proposed: the relocation of a planned street, as well as environmental enhancement measures and compensation sites proposed to compensate for the impacts caused by the planned construction work (Ohlenburg et al. 2012). A further proposal is a 7 m² per capita green space (access radius 500 m), based on Iranian and German planning standards. This means a demand of about 56,000 m² of



Fig. 75: Distribution of greenery in Shahre Javan Community area (Ohlenburg, Nagel, Demuth, Garske)

green and open space for 8,000 inhabitants. To meet this demand, in addition to the central park, the east adjacent green space structures had to be partially included in the green space calculation (Demuth et al. 2012, p.81). As for landscaping, native or adaptive trees and shrubs with minimal water consumption are the best option due to the scarcity of water resources. In this regard, treated gray water from the decentralized constructed wetlands will serve for irrigation purposes, the rest of which will

be allowed to seep to enrich the groundwater. The plan also includes installation of water saving irrigation systems (Ibid.).

According to a landscape design study (Fenk and Strein 2012), landscaping of this area is a combination of three greenery concepts of Central Park, Green Connection, and Big Scale Greenery, all linked to the human-made cultural landscape. The Central Park is the major pedestrian avenue linked to a set of (semi-)private and public spaces with unique views to the surroundings. The northern part of the park works as the gate or the main public entrance on the pedestrian level to the Shahre Javan Community area with “an iconic staircase flanked with constructed orchards”. A Green Connection including tree clusters and lush green spaces connects the Central Park to the Big Scale Greenery in the east. The main public space of the complex is right in the middle of the Central Park, accessed by a large rainwater basin which works as an open plaza flanked by staircases and ramp-systems. As the cultural heart of the complex, it interweaves the public strip with spaces for religious purposes, schoolyards, school gardens, and constructed wetlands on different levels into one entity. In the southern part of the Central Park there exists a patchwork of landscape architecture elements of tree clusters, construct-



Fig. 76: Distribution of greenery in Shahre Javan Community area (Ohlenburg, Nagel, Demuth, Garske)

ed wetlands, sport- and playgrounds and a rainwater recharge tank embedded in dry landscape fields.

The Big Scale Greenery in the eastern part of the site is a large multi-functional landscape divided in three parts of High Park, Upper Park, and Lower Park. The High Park aims at providing an urban agriculture space, mainly for private gardening based on natural resources and decentralized irrigation systems. In the Upper Park there is an observa-

tion deck and a variety of recreational and sport facilities. The Lower Park includes a valley characterized by the water course edged by riparian vegetation and orchard trees. Here there is a pedestrian area, bicycle lanes on the western side, and a link to the commercial zone. Thus, the Big Scale Greenery provides a symbiosis of socio-cultural, ecological, and economical infrastructure within a local aesthetic entity.

On the neighborhood scale, the greenery at the center of each neighborhood provides a gathering place for social interaction and activity, strengthened by the mixed use pattern scheme. In some cases private gardens have also been designed in front of the apartments, intended to be planted and maintained by the owners of the apartment units.



Fig. 77: Landscaping in sub-neighborhood level (Wehage, Seelig, Timme, Pahl-Weber)

V

Comparative Analysis

This chapter provides a comparative analysis between Shushtar-No and Shahre Javan Community Pilot Project in order to discover similarities in concepts and objectives. In chapters II and IV a short but articulated thematic introduction to both projects was provided. Putting these thematic studies together, it becomes evident that both projects, despite essential differences in terms of the context, approach, and goals, have some commonalities in regard to the over-arching concept, as well as in architectural and urban initiatives, which deserve consideration. In this chapter, after some introductory remarks which address the different contexts and goals of the projects, a parallel comparative analysis will be presented in which every thematic subject is studied in both cases.



1 Introductory Remarks: A Contextual Review

These two projects reflect two different conditions, which define their departure point, planning strategy, and goals. In other words, their planning and design agendas have been influenced by different contexts and have different responses to their individual economic, politic, and environmental pre-conditions. In general, while Shuhstar-No aimed at designing a community which opposes dominant modern principles and, in contrast, attempts to showcase the achievements of a traditional urban texture, Shahre Javan Community takes the current unsustainable condition of Iranian cities, their problems in the fields of energy-consumption and energy-efficient housing, as the main point of departure.

Shushtar-No has to be understood in a context where large investments in the housing sector accelerated the dominant trend towards modernized construction approaches which neglected socio-cultural values of Iranian community and culminated in an “identity crisis” (Diba 2002). To resist this overwhelming trend of “housing development” Diba proposes a “community development” to address traditional Iranian life-style and habitation.

The Shahre Javan Community, on the other hand, was created in the context of the massive population growth of Iranian cities in the last 30 years, the resulting critical social, ecological, and economic challenges, the growing demand for housing, and the increasing energy consumption. Various facts and data support the argument that a move towards energy-efficient housing systems is urgent and necessary, including the increasing energy consumption rate of 7 percent per annum in Iran, and the building sector’s high share of energy consumption accounting for about 40 percent of national consumption, such that “The rising energy demand and the impact of the built environment on Green House Gas (GHG) emission make the built environment a crucial factor of mitigating Iranian climate change impacts” (Seelig, Ohlenburg, Pahl-Weber 2012a, p.10). Moreover, the worldwide phenomenon of climate change will transform Iran’s climate and development context, such as higher and dryer temperatures, less precipitation, longer periods of cooling demand, and the danger of sea level rise - all of which will be even more critical in large urban agglomerations like Tehran-Karaj. As expressed by the design team, “These challenges define the context and impetus for the Young Cities project. Considering predicted climate change impacts, the huge mitigation potential and a rising political awareness of energy efficiency, the ‘Young Cities’

project aims to develop methodologically sound solutions for implementing low carbon, climate change resilient housing within the specific climatic, environmental, cultural, and economic context of Iran” (Ibid.).

To meet the abovementioned challenges and questions, Young Cities Project has developed a multidimensional and multidisciplinary research and design team to cover all the fields and areas in question, establishing different Dimensions (see chapter IV) to carefully address diverse aspects

of the problem. Taking benefit from the progressive international literature and practical examples on the one hand, while trying to adapt these findings to the specific context of Iran by means of introducing innovative solutions and approaches proved by different tools such as simulation on the other, the Young Cities Project, and Shahre Javan Community Pilot Project as the site of manifestation, has introduced a leading concept which should be recognized and evaluated worldwide, particularly in the Middle East and North African regions which suffer from similar problems.

However, putting this project in the context of Iran with its unique socio-cultural, political, and administrative characteristics may lead us to be cautious about the future of the work. Some previous examples such as the case of Shushtar-No provides a good, reliable basis to revisit this critical issue. As explained in chapter II, despite progressive ideas employed in this complex, the current situation is unacceptable and even tragic. The question is, how should we evaluate the unfortunate and unpredicted failure of this project? We discussed that a range of problems have influenced the life of this complex, not just the under-estimates or probable mistakes in design and planning, but also the later managerial and administrative decisions of the policy makers, and their inattention to the initial concepts and ideals. Now the question is how to ensure that the same thing will not happen for the Shahre Javan Community after its realization, and how to learn from similar cases. Here, the necessity of a comparative investigation between these two projects becomes clear, to show what has happened to similar initiatives and concepts within the Shushtar-No experience, and, thus, what could be a challenge for the Shahre Javan Community in the future. The main argument, as supported by the case of Shuhstar-No, is that what jeopardizes the future of the Shahre Javan Community is not the conceptual basis, but the treatment and decisions of policymakers, city administrators, and urban management during or after project realization. In other words, while it is the task of the designers to account for probable future challenges of the project – and, as will be explained in this chapter, a set of regulations and suggestions have been carefully proposed in the form of a Detailed Plan to avoid these future challenges and guarantee a secure implementation – it is also the duty of the policy makers to be sensitive about the careful realization of the projects on the one hand, and to plan for effective control, monitoring, and maintenance of the complex on the other. This comparative investigation will provide a basis on which the proposals of the last chapter will be grounded.

It is worth mentioning that this chapter only concentrates on the commonalities; obviously differences in goals, approaches, and employed innovations are considerable, and the Shahre Javan Community Pilot Project represents a more diverse and multidimensional approach due to the complexity of the project's context on the one hand, and its multifaceted goals and objectives on the other.

2 Climate Sensitive Design

Environmental adaptation is a key issue for both projects and special approaches and methods have been employed to achieve this goal. Despite differences in the climatic condition of the two—Shushtar-No is located in an arid area with hot summers and mild winters, while Hashtgerd in a semi-arid area with cold winters and warm summers—similar urban patterns have been taken as the inspiration source for the most effective environmental adaptation, namely, the “closed texture” (Diba 1986) of the traditional Iranian city and the “dense and clearly readable urban pattern” (Pahl-Weber, Seelig and Ohlenburg 2011, p.60) of the traditional Islamic city. Although the suitability of this particular form for both climates requires scientific investigation, both projects strove to benefit from the typical vernacular urban pattern. This common concern has been incorporated in similar physical considerations, such as creating compact texture with narrow streets to produce sufficient shade and breeze, minimize exposed building surfaces to reduce thermal loss, optimize orientation of the buildings to enjoy natural breeze and ventilation, and benefit natural ventilation, cooling, and sunlight advantages of the courtyard typology. Some differences, of course, are observable, mostly derived from the availability of different construction technologies: while Shushtar-No employs more traditional methods, such as construct-

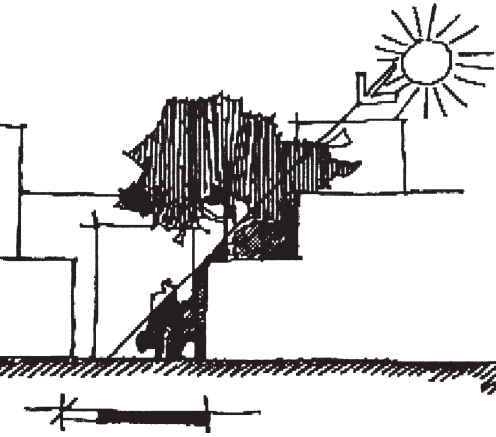

Fig. 78: Narrow streets in Shushtar-No (Diba 1986)

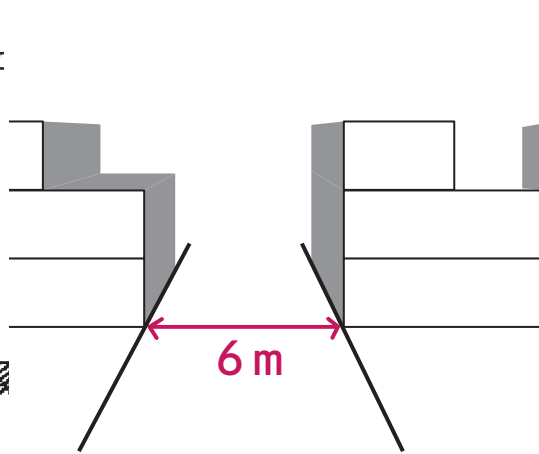

Fig. 79: Narrow streets in Shahre Javan Community Pilot Project, schematic design (Seelig, Wehage, Leubert, Pahl-Weber)

ing thick load-bearing walls, Shahre Javan Community Pilot Project uses more advanced technologies such as photovoltaic sun screens to optimize on environmental conditions.

3 Low-rise, High-density Urban Form

Both projects have taken the traditional urban pattern of typical Iranian cities as the source of inspiration for planning and designing urban layout; while Shushtar-No refers to the neighboring traditional city of Shushtar as a reference, the Shahre Javan Community Pilot Project refers to the “typical” or “general” image of a traditional city and intends to re-interpret its urban configuration in a new way- using the compact urban texture of the city of Kerman as a reference image. Whatever the inspiration sources are, both cases propose a compact urban form with a low-rise, high-density approach, but using different formal interpretations.

A close observation of the urban pattern designs (Fig. 80) shows that, urban configuration of Shushtar-No is more regular than the Shahre Javan Community Pilot Project, maybe due to the undulating topography of the latter case. Further, street geometry in the former case is strictly regular and thus far from the organic street pattern of the traditional city, while in the latter case, street pattern follows an irregular, somewhat organic order more similar to the organic street patterns of the traditional city. This is easily perceivable by comparing figure-ground maps of both projects. Finally, Shushtar-No generally appears more compact than the Shahre Javan Community in terms of built-up areas; urban blocks are densely linked and interwoven.

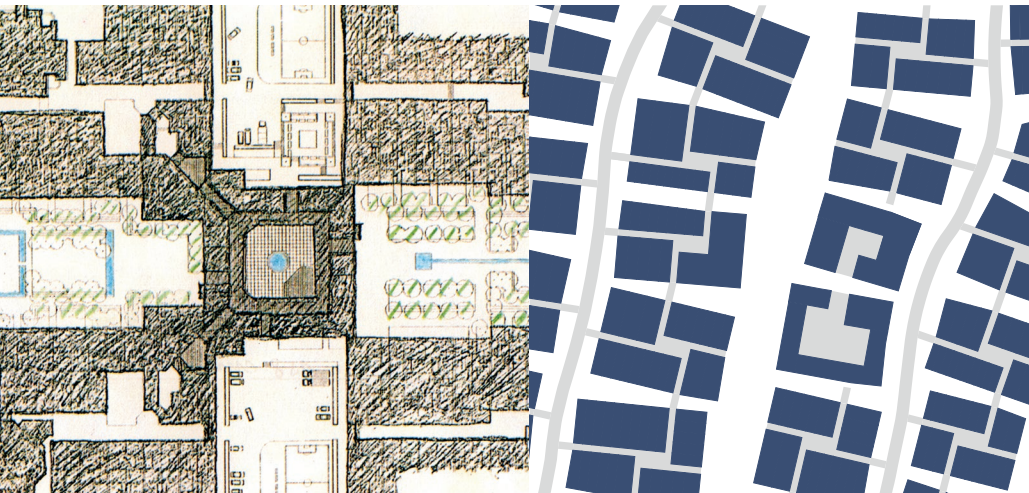

Fig. 80: Figure-Ground scheme of the projects (Left: Diba 1981; right: Wehage, Seelig, Pahl-Weber)

The low-rise, high-density approach has been manifested differently in these projects. In Shushtar-No the majority of the buildings are non-apartments (90 percent), while in Shahre Javan Community Pilot Project the general residential pattern is composed of apartments. However, since in the latter case the highest building typology is not more than four stories, both of the projects could be categorized as low-rise, high-density complexes.

Another difference is the pattern of “street” or “passageway” in both projects. In Shushtar-No there is a clear continuous hierarchy typical of traditional cities, from the central public space up to the culs-de-sac. This character grants the complex a particular ambiance (Stimmung), such that a short walk through the streets is reminiscent of a traditional city. In the Shahre Javan Community Pilot Project a sense of spatial hierarchy is also observable, where the streets are arranged by the dominant dispersed hierarchy which starts from a public space and ends in a semi public space (in sub-neighborhood blocks).

4 Housing Typologies

In both projects, the courtyard prototype is understood as the optimal model upon which the basic configuration of entire complexes and residential units are organized, it is a prototype which addresses both the physical and socio-cultural prerequisites of dwelling in Iran. There are three distinguishable levels of implementation for this prototype: urban, community, and unit. As illustrated in chapter II 2.5, Shushtar-No shows a clear hierarchy of courtyard implementation from urban to individual unit level: the spinal open space stretching through the complex works as an urban courtyard, central open space is the community courtyard, and each residential unit enjoys its individual interior courtyard. The urban courtyard in the Shahre Javan Community Pilot Project is fragmented due to the urban layout, it is comprised of several landscaping areas incorporated in the Central Park and Green Connection. Community courtyards are more effective in this project, since every residential cluster has been organized around a central open space. Urban blocks of the residential neighbourhoods are divided into residential units designed around a central individual courtyard.

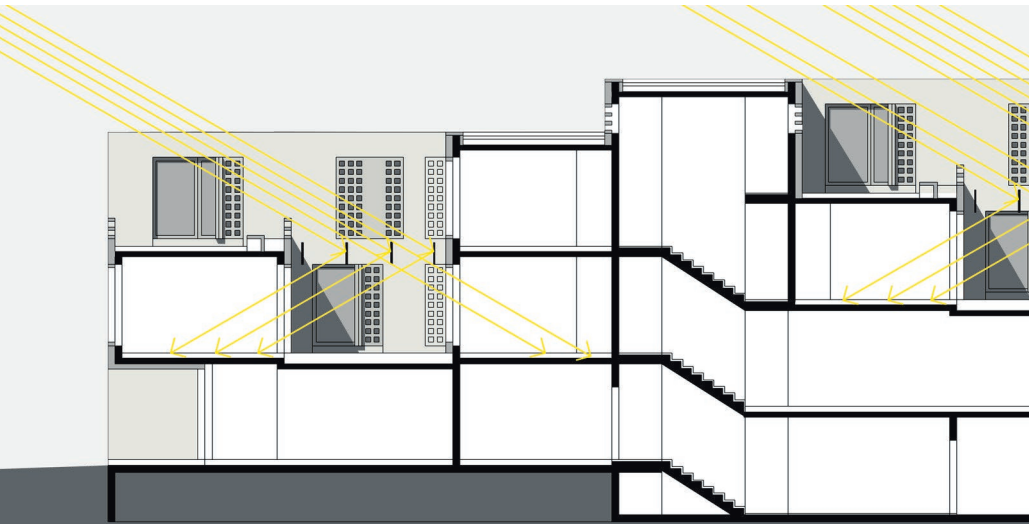

Fig. 81: Architectural measures to protect privacy and to use the sunlight (Wolpert, Wehage, Pahl-Weber)

Thus, the courtyard prototype has been employed as the central concept for the housing layout in both projects: in the case of Shushtar-No, with direct reference to the traditional housing typology in the old Shushtar (Fig. 17); in the Shahre Javan Community Pilot Project the courtyard as an optimal prototype has prioritized its unique capacities and potentialities. In Shushtar-No, single residential units employ a formal interpretation direct from the traditional courtyard scheme, where the courtyard

defines the central space around which all the living rooms are gathered. This courtyard contains typical elements such as a pool and greenery (Fig. 18). In the apartment buildings, this courtyard is transformed into a joint open space at the center to provide light for the interior.

In Shahre Javan Community Pilot Project the courtyard prototype has been interpreted differently. In this case, the “interior courtyard” plays the key role such that all the units have access to an interior courtyard. This courtyard, in addition to its climatic advantages, must help meet the demand for privacy (Wehage and Pahl-Weber 2012). Here, some architectural measures have been considered to prevent possible visibility and protect privacy, such as making the exterior edge of the courtyard inaccessible by means of putting a greenery box and thus hindering direct view, or covering the windows with grilles, and allocating interior courtyards to one single two-story apartment in which visibility of the lower level is not in question.

This issue is of high importance when one considers the later interventions by the inhabitants of the Shushtar-No complex to guarantee their privacy and security. As explained in detail in chapter II 2, residents of Shushtar-No have walled the exterior windows and in some cases balconies to protect privacy and enhance security. This example shows that if the desire for privacy and security, as a fundamental factor for the residents, could not be met in a building, then the inhabitants would solve this problem using any immediately available measures or interventions, drastically changing the urban scape for the worse.

5 Mixed land use

The concept of mixed use is realized in Shushtar-No as a separation between dwelling and work, typical in traditional Iranian cities where there is a clear division between dwelling-place and working place: local services for the neighborhood (mahalla) purposes are collected at the neighborhood center, separate from the residential areas. Thus, in Shushtar-No, local needs and services on the neighborhood scale have been provided in central, mixed use areas.

In the case of Hashtgerd, the concept of “mixed use” has been interpreted differently and is manifested in two patterns: “vertical mixed use” and “horizontal mixed use,” where the local services are more fundamentally linked to the residential units, with a close connection between dwelling and work. This connectivity is more observable in the residential units located around the central public space in the blocks where the ground floor has been dedicated to commercial activities in the hope of enhancing social livability at the neighborhood scale. To compare, in Shushtar-No a concentrated mixed use is observable, whereas in the Shahre Javan Community, commercial units are more deconcentrated (see Fig. 69).

Theoretically this concept is a progressive idea whose advantages are extensively acknowledged by scholars. However, both approaches (employed in Shushtar-No and the Shahre Javan Community Area) may have some crucial challenges in the absence of systematic neighborhood control and management. A main challenge is the misuse of commercial spaces, in the sense that the owners might (for more profit) dedicate these spaces to functions which may be disturbing to neighborhoods and their socio-cultural sensitivity. Originally visualized as a place for light shopping purposes, supplying the everyday needs of inhabitants, there is the potential for them to be transformed into noisy workshops or other disruptive pursuits. Moreover, regular customer traffic could jeopardize neighborhood security and privacy, leading to resident dissatisfaction. Additionally, the façade of the commercial units may be changed or re-organized in an inappropriate way, consequently disturbing the aesthetics of the complex – unless unambiguous regulations and strict control are taken into consideration for the entire Shahre Javan Community area. To avoid these inconveniences, clear-cut regulations have been proposed at the urban planning and urban design level, including defining allowable

non-disturbing uses for the commercial spaces of the sub-neighborhoods, and providing separate entrances for them (see Seelig, Wehage and Pahl-Weber 2012b, pp.97–98). A careful implementation and observation of these regulations may prevent the abovementioned challenges.

6 Landscape Planning and Greenery

In Shushtar-No, greenery was limited to economize and simplify its maintenance; an architectural decision borne of the architect's awareness of the generally low maintenance quality common in Iranian public spaces. This fact is observable in the complex's existing situation where the limited central greenery has been left unattended and thus in disrepair (see chapter II 2). To find an intermediate solution and raise residents' awareness and concern about the importance of greenery, some semi-public, semi-private garden spaces have been designed in front of the apartments for which the residents were to be responsible. However, these pieces of landscaping are now either walled-in and added to the property, or left out and neglected.

In the Shahre Javan Community Pilot Project, maintenance of the main greenery spaces, "Central Park", "Green Connection", and "Big Scale Greenery"—taking their complete implementation for granted—will be a critical issue. Key questions include: who will pay for realization, and who will cover the costs of and be responsible for maintenance (the municipality or the community itself). But this is not the only challenge. The importance of the proposed greenery for the community has been well studied and elaborated by the research and planning team, and progressive but place-specific measures have been developed to minimize the costs of the maintenance, in what promises a pragmatic prototype for similar cases (see Ohlenburg et al. 2012, pp.101–104; Fenk and Strein 2012, pp.105–106). However, initiatives have to be planned, mainly by the local administra-



Fig. 82: Semi-public greenery in front of the residential units (Wehage, Seelig, Timme, Pahl-Weber)

tion, to secure full implementation, since a partial realization will not meet the needs (or reach the potential) of the landscaping. On the other hand, some private gardens have been designed in housing areas, which, like Shushtar-No, are supposed to be planted and maintained by the residents. What is needed in this case is a clarification of ownership, maintenance costs, and managerial support to provide a secure base for such a vision and prevent a fate similar to that of Shushtar-No's landscaping.

7 Car-free Environment

Providing a car-free built environment and encouraging residents to park their private vehicles out of the residential quarters was a progressive concept for Shushtar-No, especially since, in the 1970s, private cars were not affordable and therefore less usual, particularly in a complex where the majority of inhabitants belonged to the labor class. The architect's principle intention was likely inspired by that time's critique on the overwhelming technology rather than environmental concerns, and was aimed at creating walkable spaces, making the residential quarters more livable, and enhancing social contact. On the other hand, the car-free quarters of the Shahre Javan Community Pilot Project came more from an environmental point of view, as a tool to decrease CO₂ emissions and energy consumption at the neighborhood level; a very effective and common concept in the current literature on sustainable development. In other words, cars were for Shushtar-No an enemy of social life, while for the Shahre Javan Community they were an enemy of the environment and a source of pollution.

In Shushtar-No cars were supposed to be parked and left in designated parking lots outside the residential quarters, access to the residential units was by foot. In the Shahre Javan Community, the initial idea was to follow a similar approach, this was later changed and rightly so given the probable unwillingness of the inhabitants. The only justification was the current, excessive car-dependency of Iranians, which makes any radical change of behavior almost impossible. Moreover, the existing poor public transportation encourages people to orient their life towards private cars. In the final concept, parking spaces were provided within the residential quarters in underground parking lots designed with direct access to the residential units.

The way this kind of parking scheme has been treated in Shushtar-No is very indicative. Residents don't care about using public parking lots, they drive their cars into the residential quarters, and either park them in front of the houses or in the garages they've built out of their courtyards. This is not feasible in the Shahre Javan Community, as the spatial configuration of the neighborhoods does not allow it. In general it can be argued that, although a completely car free neighborhood may have more environmental and social advantages for, and be more socially acceptable to, the inhabitants, provided that they are adequately informed, this media-

tory approach—providing parking space for all the residential units—appears to be both more acceptable and more feasible. This approach, simultaneously meets the inhabitants' concern for a private car, while helping them to re-consider their car use patterns. This is the concept behind “soft policy”, the aim of which is to provide inhabitants with information which encourages them to shift towards environmentally-friendly traffic behavior.

However, when accounting for the current traffic problems in Iranian cities, it could be argued that the planned general traffic package, the “hard policy”, which considers a range of aspects from footpath and bicycle to Light-Rail and BRT, may fail to be realized in the near future. As a result of a systematic analysis of the existing conditions and the given comprehensive plan (see Döge and Arndt 2012), the proposed scheme combines all possible modes to achieve an efficient transportation system. However, the reality, which is out of the hand of the planners, shows a different story. For instance, the BRT system has been recently integrated into the transportation network of major cities like Tehran, and the Metro line of Tehran is supposed to be connected to Hashtgerd New Town in 2013, after several retardations. Even if realized in 2013, extending the metro line into the city is unfeasible, as long as the current problem with absorbing new inhabitants remains unsolved, and the population growth does not remarkably increase. Nonetheless, the proposed traffic package introduces a progressive and pragmatic framework which can be used and adapted for other similar cases.

8 Appropriated Technology

In both projects, the employed construction technology is neither primitive nor advanced (high-tech), but a middle-level technology based on what is available. However, this approach is more recognizable in the case of the Shahre Javan Community, since a range of technical issues have been identified to meet the goals of the project regarding energy-efficiency and environmental adaptability. In Shushtar-No the materials and construction methods were locally available, while the employed labor were mainly native people. In the case of the Shahre Javan Community Pilot Project, the employed technology is not limited to building construction, but extends to the mechanical facilities at the building and community scale, such as the decentralized water and waste treatment system. Considering issues of “availability” and “locality” within the scale of region, many techniques and materials are locally available, excepting just a few. During actual construction and realization, local contractors and labor have priority, while simple materials are supplied from neighboring factories, supporting the new town’s economy from the beginning.

9 Target Group and Actual User

Shushtar-No was originally designed for the employees of the Karoun Agro-industrial Company; there was a somewhat clear idea of the users, their social status, the number of inhabitants, etc. This has enabled the design group to plan for this complex in detail. However, as was explained in II.2, due to the political conditions after the Islamic Revolution and the Iran-Iraq war, this initial intention was neglected and the residential structure of the complex was drastically changed. Most of the current, observable problems with Shushtar-No are rooted in this radical change; the unexpected residents are very diverse and generally form lower social classes than was originally planned for.

In the case of the Shahre Javan Community, there was no clear picture of the probable users, their social class, or their background. This ambiguity was chiefly due to the ambiguous and changing character of Iranian New Towns, as well as the difference between the predicted structure and the reality, what made any precise prediction by the Hashtgerd NTDC impossible. This uncertainty in regard to the target group is critical, since it makes achieving a clear understanding about the wishes, behavior, and expectations of the probable users impossible. For instance, innovative initiatives would be more welcome if the area is inhabited and managed by a homogeneous, culturally and socially educated people, rather than by diverse, heterogeneous families. Moreover, any collective activity for more efficient community management would work better in a more homogeneous community.

It may be argued that, given the existing demographic pattern of Hashtgerd New Town, users would likely be similar in income and socio-cultural status, namely people from middle class with moderate income. In fact, it seems that, in the near future, this town will not be attractive enough for high-educated or high-income families, and no considerable change is expected. Policy makers and local administrators must take careful measures to avoid occupation of the complex under unexpected conditions and by unsolicited groups, and so to avoid the types of challenges experienced by Shushtar-No.

VI

Concluding Remarks— Perspectives and Challenges

The thematic comparison presented here indicates that future challenges of the Shahre Javan Community Pilot Project are of two distinguishable kinds: some address physical dimension of the project such as architectural and urban design aspects, others are more management and planning issues, basically non-physical, and controlled by policy-makers and urban administrators during or after realization. In this sense, to bypass challenges like those of Shushtar-No, physical as well as policy revisions are crucial, though, as will be explained, the latter is more determinant and effective. In what follows, both dimensions are reviewed and discussed.

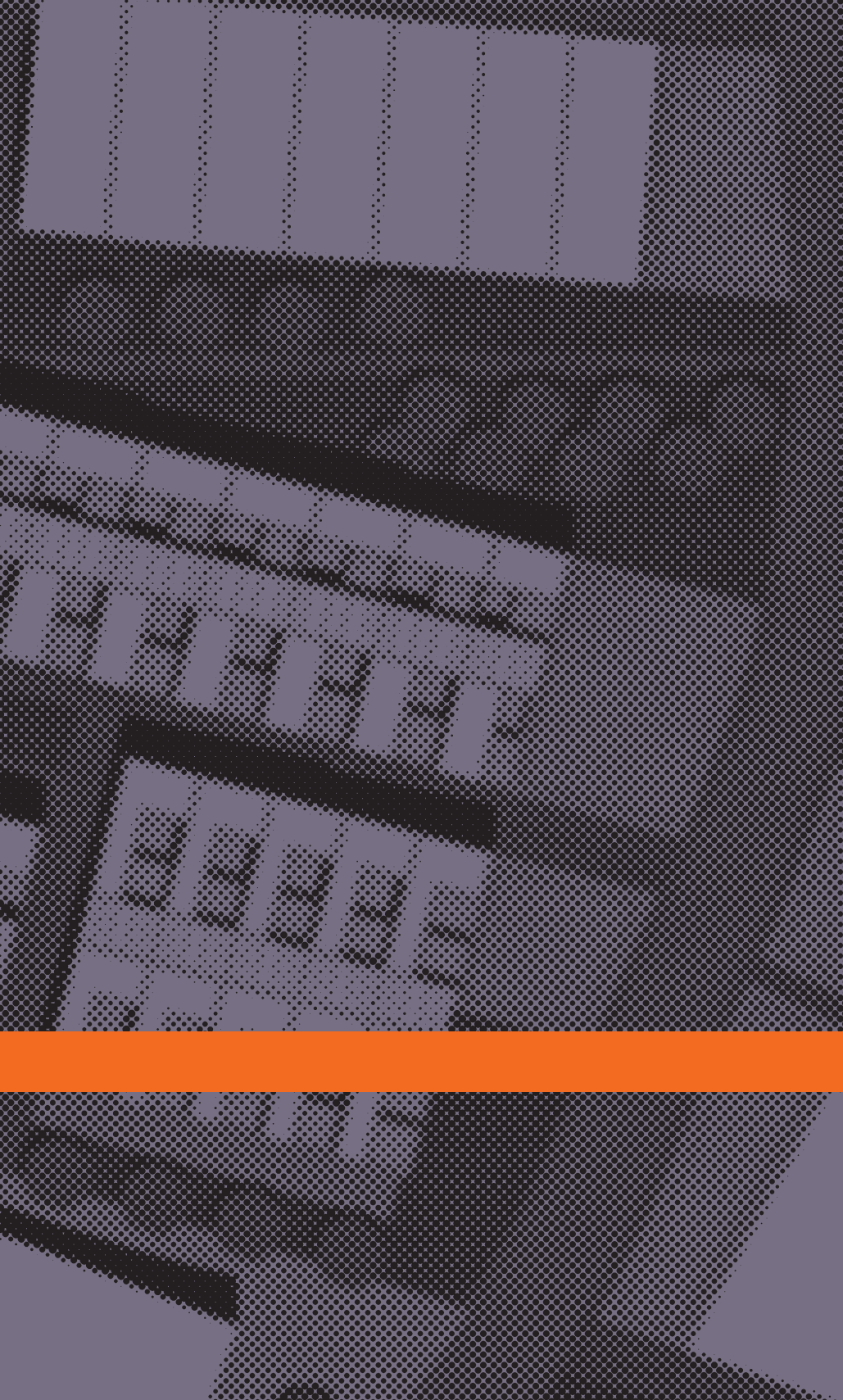

1 Physical Challenges

The street hierarchy is an essential character of the traditional urban pattern of Iranian cities which serves as the inspiration for the urban layout of the Shahre Javan Community. The existing order in the hierarchy of street-networks (see chapter IV 4.2), which links public spaces to semi-public spaces in the sub-neighborhoods through a short and narrow street, can be reclaimed with landscaping and landscape design of areas like the “Central Park”, “Green Connection”, and “Big Scale Greenery”. This is addressed in the landscaping scheme of the complex (see Fig. 76), which attempts to make passages physically distinguishable and thus mentally perceivable by visitors. A careful development of this measure in the final detailed plans will certainly grant the walkers a feeling of street-network hierarchy.

Central public space of the sub-neighborhood is a key character of the project which strengthens the sense of community and can work as a gathering-place for socializing and exchange. The multiplicity of this space, which provides all the inhabitants with an individual community space, may raise the sense of belonging and attachment, provided that community management could supply all the necessary pre-requisites. In other words, these public spaces are optimal only if they are kept livable and enjoyable for the inhabitants by being maintained and managed carefully; the absence of such support may leave these spaces barren, transforming them into unappealing spaces. This requires vigilant management of the complex after its realization, either by the city or the community administration.

The main field of future challenges is in housing typologies, since they form the core of community social life. In this regard, the concept of the inner courtyard deserves special attention as it promises a variety of socio-cultural and environmental advantages. As explained in chapter V 4, measures—such as putting grilled surfaces in front of the windows and walling some sides of the balcony—have been considered to meet the question of privacy and solve the problem of visibility. Re-interpreting the concept of courtyard, as a forgotten potentiality, in the form of innovative spatial configurations may shed light on this concept’s potential for modern life. Therefore, careful monitoring and long-term observation of the functionality of this housing typology in terms of social issues—privacy and security—as well as environmental efficiency—optimal environmen-

tal adaptation despite multi-story buildings—is necessary to achieve clear and reliable results.

On the other hand, as happened in the case of Shushtar-No, owners of the apartments may change the appearance of these courtyards, particularly in places which face outwards and are part of the urban scape of the community, for security, privacy, and even functional reasons, by means of physical interferences such as walling, ceiling, or fencing. Lacking any

construction code in general and an extra community-based agreement in particular, transfiguration of the community and its urban scape to a state of disorder might be unavoidable. The indeterminacy of target groups and users' social class increases this possibility. To hinder this, more effective architectural measures are required, supported by a community-base agreement to restrict any radical interference in exterior fronts of the buildings - two measures envisaged in the provided Detailed Plan (see: Pahl-Weber, Seelig and Ohlenburg 2012).

The concept of mixed land use grants a positive perspective to this residential area, so that, with a full realization of the project, all the objectives of the mixed use approach can be achieved, and residents can enjoy optimal accessibility to their everyday needs. To avoid any kind of misuse in the sub-neighborhood scale, in the form of changing their function, extending their activities to the public space, or disturbing residents through noise (see chapter V 5), full observation of the proposed regulations (see Seelig, Wehage and Pahl-Weber 2012b) is urgent, supported by an efficient community management scheme.

The proposed greenery and public space dispersed over the area, but concentrated in some particular places such as parks—the biggest of which are on the eastern border - would be a future challenge from various perspectives. Creative planning and design of these large pieces of land incorporate progressive landscaping ideas and are based on comprehensive studies of the existing landscape, but feasibility of implementation necessitates multifaceted supports from design (detailed landscape plans for realization) to construction period, and, of course, a post-realization maintenance system. Who is going to provide construction plans, who will pay for implementation (municipality, NTDC, or the community itself), and who is responsible for maintenance costs (despite low costs due to innovative methods), are questions which must be clarified before realization. It seems that in the near future, even after probable realization of the residential units, the proposed landscape design is slightly ambitious (especially the elements heavily characterized by constructive elements and long term irrigated lush green structures). Although these elements have not been part of the binding design, but are only in the landscape design study, these measures need considerably high maintenance and could be higher than the capacity and financial ability of the local administration, potentially adding construction costs to the residential unit prices making them unaffordable for normal residents. On the

other hand, since greenery and landscaping is an integral part of the entire project and is supposed to support energy efficiency of the complex in terms of controlling micro-climate and being integrated into the water concept (such as wetlands), non-realization and even semi-realization of the landscaping may disturb achieving planned environmental visions. Moreover, even after its realization, due to the low quality of maintenance in Iran, specific measures must be taken by the responsible administra-

tion to keep the landscaping at an acceptable level. In regard to the small greenery spaces behind residential units, their ownership has to be clarified by the time of selling the residential units and its maintenance method has to be regulated by the community from the beginning to avoid any possible problems later on, like those experienced in Shushtar-No (see chapter II 2).

A shift from an absolutely car-free environment to a semi-car-free one is an understandable decision, taking into account the current status of car ownership in Iran. As explained before (chapter V 7), the mediatory approach employed is feasible and reasonable, allowing cars to enter the sub-neighborhood in underground parking, but keeping clear the spaces for walking and socializing. The general traffic plan incorporates a range of traffic options from walking to Light-Rail and BRT. The “hard policy” is actually a “visionary plan” which accounts for the reality of modern Iran, but will still raise inhabitant awareness and draw their attention towards an “optimal traffic scheme”. It is the task of the local administration to take advantage of the plan’s systematic approach and format its suggestions into a practical step-by-step implementation strategy which reflects the latest local and regional traffic capacity.

2 Management Challenges

The non-physical challenges are mostly strategic and policy-related concerns, addressing both the period of implementation and the time afterwards. In this sense, they mainly address the after-design period, directing the local and responsible administration. To address these non-physical concerns and achieve the goals of a Pilot Project a community trustee should be established before implementation of the project, via constructive contribution from related administrations at the national, regional, and local levels.

The main non-physical challenge of this complex is the uncertain nature of the users. The question is: who will be settled in this area? This becomes more important when we notice that the interaction of users with a building is highly related to their socio-cultural background; initiatives of a project may be welcomed by some but rejected by others. In the case of the Shahre Javan Community Pilot Project, there is no clear image of the probable users, due to the semi-realization of the planned vision at the national level, failure to attract the target population at the regional level, and the changing character of decision makers at the local level. Thus the users who will eventually occupy the project area must adapt to the visions and imagination of the design group. This adaptation is not an easy task, and this condition could result in a chain of interrelated problems in the future.

As explained in chapter III, Hashtgerd New Town is far from achieving its vision in regard to attracting the predicted number of residents. Studies (Zabardast and Jahanshahloo 2007) show that a primary reason for choosing to reside in this town is the low price of the residential units, making it affordable for low income families. Due to the high quality of the Shahre Javan Community Pilot Project, and despite its mid-technology character, the price of the constructed units will be remarkably higher than the average price in the town (even if no extra charge is needed to cover the maintenance costs of the area) and this will make them unaffordable for the low income families who are the main residents of the town. This has already happened in the “New Quality Building”, a five-story pilot residential apartment located in the north-west of the area aiming at consuming 50 percent less energy than a standard Iranian residential building by means of efficient construction with available technologies and materials (Rückert et al. 2011). Two years after its complete

realization in 2010, the residential units have still not all been sold, due to their higher than average price. Yet, without some type of radical shift in the near future, the city may remain unattractive for the high-income families. A subsidy based strategy, making residential units more affordable, may end in lack of convergence between the capacity of the complex and the behavior of the residents, a fate like that of Shushtar-No. This brings up another important issue: “behavioral sustainability”.

As explained in chapter IV 2, the main goal of the Shahre Javan Community Pilot Project is a more energy efficient community. To achieve this goal, different initiatives have been planned in a variety of dimensions, such as urban planning, mobility, energy consumption, etc.. All these initiatives can provide a physical infrastructure culminating in a more efficient community, provided that the inhabitants care about them. This care is what is encompassed by “behavioral sustainability”. Behavioral sustainability contrasts with technical sustainability which addresses technologies, materials, and physical considerations necessary for a sustainable situation. For instance, constructing a sustainable building in which efficient construction technology promises low energy consumption and provides a comfortable atmosphere for the inhabitants meets only one aspect of sustainability. Behavioral sustainability, as Williams et al. (2010, p.185) put it, “contrasts with technical in that it refers to the sustainable actions of those living, working and enjoying their leisure time in a development.” In this sense, providing a physical field for a sustainable action, for example providing cycling and pedestrian paths or recycling facilities may encourage people to act more sustainably, but cannot guarantee it; the inhabitants must behave in sustainable manner. Studies show that inhabitants of sustainable buildings do not behave more sustainably than other people (Ibid.). Therefore, it can be said that providing the physical prerequisites for being sustainable can help lead to an actual sustainable lifestyle “if and when people are ready to take them up.” (Ibid., p.212). This means that we may prepare a physical environment, in which theoretically all the prerequisites of a sustainable urban life are met, but this does not necessarily lead to a sustainable situation, the inhabitants must live in sustainable manner of their own accord.

To put this issue in the context of the Shahre Javan Community Pilot Project one may argue that some long-term planning strategies are required to secure optimal usage of the initiatives employed in the project and to achieve an optimal sustainable lifestyle. Of course, changing the consumption behavior of the inhabitants, particularly in this case in which the probable users are not yet defined, is not the task of the designers. However, within this project, some “awareness raising” programs have been planned to make the inhabitants aware of the behavioral aspects of energy efficiency.

From another perspective, the success of the employed initiatives and measures can be determined only if their efficiency is proved by means of

continuous monitoring after realization. This monitoring can reveal the efficiency and practicality of the measures, highlighting both their problems and their advantages, and helping with later modifications and revisions. Only after systematic monitoring will the findings of the pilot project be reliable enough to be developed as a strategy and incorporated into national policies. But the two questions remain: who is going to undertake this responsibility after realization and who will cover the costs?

3 Towards the Shahre Javan Community Trust

To meet all the above-mentioned concerns, some leading international experiences could provide constructive suggestions. It is common internationally for specific projects, or places, with a different vision to be managed and monitored by a community-based administration. The administration's role includes policy-making, planning, construction, management and continuous monitoring and assessment of the community, from design to realization and after. Leading examples of this kind are Dockside Green in Victoria, Canada, BedZED in London, and UniverCity in Burnaby, Canada. Reviewing the case of UniverCity may reveal some helpful pointers.

UniverCity on Burnaby Mountains was designed to be “a compact, mixed-use and transit-oriented community founded on principles of environmental, economic, and social sustainability” neighboring Simon Fraser University (SFU) in Burnaby, British Columbia. Based on the Official Community Plan (1996) up to 4,536 residential units were planned in two district neighborhoods to the South and East of SFU's campus. Currently home to about 3,000 inhabitants, it will accommodate more than 10,000 when fully implemented. To meet its sustainability goals, different initiatives have been implemented such as Habitat Preservation, New Green Building Requirements, Stormwater Management, and Sustainable Transportation Options.

SFU Community Corporation is managed by a Board of Directors comprised of key SFU stakeholders, faculty, and student representatives as well as a number of prominent real estate and legal experts from in and around Vancouver and the Lower Mainland, and is responsible for the development of the UniverCity community. Acting as Trustee for the SFU Community Trust, the board of the SFU Community Corporation establishes policy for SFU Community Trust and plays an active role in shaping the planning and development of UniverCity.

A comprehensive set of Development Guidelines was established in 2002 to complement existing regulations incorporated into a document including very specific design criteria relating to the community as a whole, as well as individual parcels. This document is to “ensure consistency in the aesthetic and quality of development while still allowing for diversity and creativity”. Each development proposal has to follow guideline instructions, and will be approved by the SFU Community Trust.

Continuous assessment and monitoring is another duty of the SFU

Community Trust. In early 2010 a group was hired to undertake a follow-up survey, the first one conducted in 2007. Designed as a mail-back questionnaire, detailed information was obtained in regard to the wishes, satisfaction, and challenges of the community residents. Based on this study, in general 9 out of 10 residents were satisfied with UniverCity as a place to live. More recent survey of 2010 depicts a general increase in satisfaction with life at UniverCity¹.

This experience shows that to secure the visions and objectives of a distinguished project, a highly qualified and powerful administrative unit has to supervise, control, and observe all the stages of the project, mobilize existing potentialities, and prevent deviation.

In the Shahre Javan Community Pilot Project, in which a unique planning and design strategy has been developed, establishment of a “Community Management and Monitoring Unit” (CMMU) would help with solving challenges. Exceptional permission from the local administration for this project, where conventional construction regulations of Iranian cities have not been observed, implies that this complex has the capacity to work as a true “Pilot Project”, a prototypical residential community whose efficiency and sufficiency has to be proved, improved, and developed for use in future developments and cases. This capacity can be utilized to establish a community-based office involved in the realization of the project from the beginning. This Unit (CMMU), in turn, has to work as the practical agent of a higher policy-making committee, as a Trustee for the entire community. Since different governmental and administrative sections have been involved from the beginning in the research project, this Trustee – which can be called Shahre Javan Community Trust, (SJCT)—must consist of some legal members, such as the director of Hashtgerd branch of NTDC, the head of BHRC, Mayor of Hashtgerd New Town, head of Hashtgerd City Council, and some natural members from among the resident citizens. Thus, SJCT will be responsible for all the policy-making, planning, realization, management, and monitoring of the community, and the CMMU will be the local, on-site agent of this Trustee.

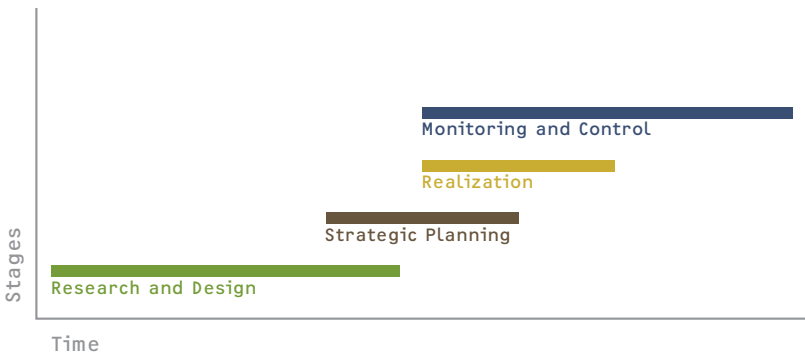

Fig. 83: Time-stage framework (Author)

In this way, as can be seen in Fig. 83, instead of stepping into the phase of immediate realization after design, a mediatory phase of “strategic planning” will be established to plan for the optimal implementation of the project in a reasonable future, by means of a parallel activity of “awareness raising” and “marketing” as the result of which most of the above-mentioned concerns could be met in advance. CMMU can work as the base for such an in-between stage. SJCT, based on the power and trust

of its members, will be able to attract national or regional financial support (from the national government and regional administration) to serve as an ideal “pilot project”, the result of which could, after necessary modifications based on monitoring reports, be implemented in construction policies at the national level.

Thus, the main tasks of CMMU under the supervision of the Trustee would be:

- Establishing an on-site exhibition box as Info-CMMU office which provides necessary information about the project, its goals, initiatives, etc.
- Careful monitoring of the current situation and possible methods for procuring necessary investment.
- Policy making in regard to potential target groups according to circumstances as they arise.
- Attracting potential development companies who are interested in being involved in the project.
- Providing development guidelines as supplementary construction regulations to the existing conventional urban regulations in order to meet the specific expectations of the project.
- Supervising during the construction phase to achieve optimal and careful implementation.
- Continuous monitoring after realization, in the form of annual on-site surveys and monitoring reports.
- Maintenance of the complex and management of the community.

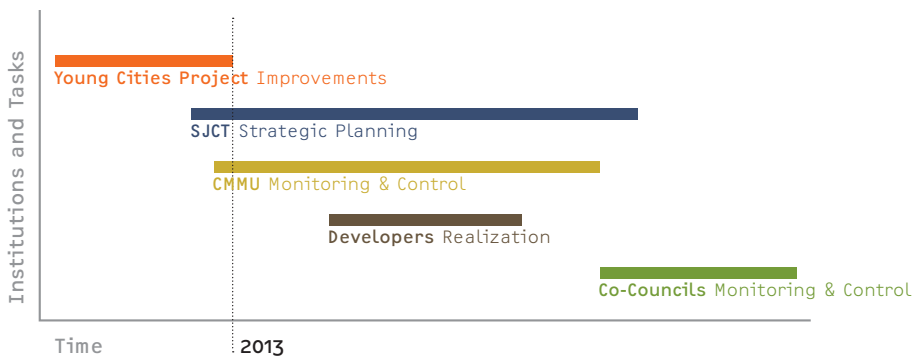

Fig. 84: Involved institutions and their tasks (Author)

This body of community management, supported by high-level local authorities, can later be incorporated into community-based authorities such as neighborhood councils and Mahalla-directors, as has been depicted in Fig. 84, in case this initiative is realized in Hashtgerd New Town.

There are sufficient concerns to encourage responsible administrators to establish such a Trustee and operational unit. For example, direct realization of the project without establishing such a management

and monitoring unit will put the future of the complex in the hands of development companies, companies whose interests do not necessarily coincide with those of the project planners in areas such as the quality of construction, optimal implementation of the project, and future community challenges. Furthermore, inefficient controlling of the proposed regulations—as manifested in the Detailed Plan (see Pahl-Weber, Seelig and Ohlenburg 2012)—may jeopardize optimal achievement of the goals. Therefore, priority should be given to the establishment of the above-mentioned Trustee and CMMU.

In conclusion, it is worth mentioning that even after establishment of such management units, considerations must be taken to prevent the transformation of this community into a “gated community”. In fact, setting out a community-based management and maintenance system to monitor the community and control the movement and behavior of the residents may create a gated community which remains isolated and socially excluded from the greater city. Steps must be made to avoid this spatial segregation, such as making public spaces, public facilities, and big greenery fields easily accessible to all citizens.

¹ Materials of UniverCity have been provided based on the brochures, related website (<http://www.univercity.ca/>) and published reports.

VII
References,
Project Profiles,
Figures, Tables,
and Abbreviations

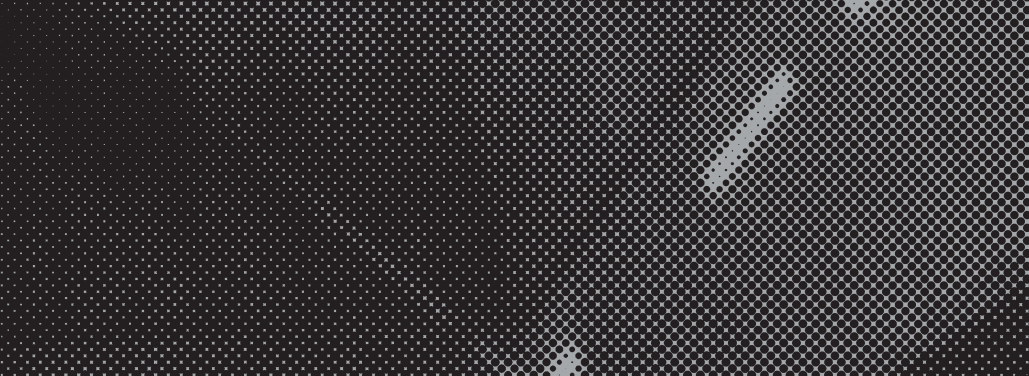

References

Arjmandia, A. (1999):

hayate ejtema'i dar shahre jaded. In: Abadi, no. 29, pp. 41–50.

Attari, A. (1994):

masaele farhangi–ravanie puladshahr. In: Naji, K. (Ed.): *New Towns, New Culture of Urbanism* (NTDC, Tehran) pp. 185–192.

Azizi, M. and Arbab, P. (2010):

shenasai va arziabie faraiande sheklgirie hoviat dar shahrhaie jaded. In: *Honarhaie Ziba*, no.42, pp. 47–58.

Barnett, J. (2011):

City design, Modernist, Traditional, Green and Systems Perspectives (Routledge, New York).

Böhm, A. and Mahrin, B. (2011):

New Generation Educational Building 'Life Center'. In: Schäfer, R., Nasrollahi, F., Ohlenburg, H. and Stellmacher, F. (Eds.): *Accomplishments and Objectives. Young Cities Research Paper Series, Vol. 02* (TU Berlin, Berlin) pp. 74–81.

Davodpour, Z. (2006):

nagshe shahrhaie jadid dar sheklgirie sokoonatgahhaie kalanshahre Tehran. In: Karbalaii Nuri, R. and Riahi, F. (Eds.): *tarhhaie tose'ie shahri, egtesad, modiriat, hamlonagl va terafik dar shahrhaie jadid* (NTDC, Tehran) pp. 61–78.

Demuth, B., Garske, T., Heiland, S., Ohlenburg, H., Nagel, P. and Köppel, J. (2012): *Landscape Planning and Environmental Assessment*. In: Pahl-Weber, E., Seelig, S. and Ohlenburg, H. (Eds.): *The Shahre Javan Community Detailed Plan, Planning for a Climate Responsive and*

Sustainable Iranian Urban Quarter. Young Cities Research Paper Series, Vol. 03 (TU Berlin, Berlin) pp. 81–85.

Diba, K. (1980a):

The Recent Housing Boom in Iran—Lessons to Remember. In: Safran, L. (Ed.): *Housing: Process and Physical Form* (Aga Khan Award for Architecture Philadelphia) pp. 38–40.

Diba, K. (1980b):

A Case Study: Design Concept of Shushtar New Town. In: Safran, L. (Ed.): *Housing: Process and Physical Form* (Aga Khan Award for Architecture Philadelphia) pp. 41–44.

Diba, K. (1981):

Kamran Diba, Buildings and Projects (Hatje, Stuttgart).

Diba, K. (1986):

Technical Review Summary (Aga Khan Award for Architecture).

Diba, K. (2002):

What Islamic Architecture Is Not. In: Petruccioli, A. and Pirari, K. (Eds.): *Understanding Islamic Architecture* (Routledge Curzon, New York) pp. 119–124.

Diba, K. (2010):

baghi miane do khiaban, in conversation with Reza Daneshvar (Alborz Paris).

Diba, K. and Javaherian, F. (2005):

Shushtar New Town. In: Eetesam, I. (Eds.): *New Towns* (New Towns Development Cooperation, Tehran) pp. 15–36.

Döge, N. and Arndt, W. (2012):

Mobility and Transportation. In: Pahl-Weber, E., Seelig, S. and Ohlenburg, H. (Eds.): *The Shahre Javan Community Detailed Plan, Planning for a Climate Responsive and Sustainable Iranian Urban Quarter*. Young Cities Research Paper Series, Vol. 03 (TU Berlin, Berlin) pp. 86–92.

Eetemad, G. (2004):

tafavote ahdafe avvalie va nataieje hasele az ehdase shahrhaie jadid va elale an. In: Naji, K. (Ed.): *New Towns, New Culture of Urbanism* (NTDC, Tehran) pp. 19–23.

Etessam, I. (2005):

Introduction to “International Conference on New Towns”, Full articles (Tehran).

Fenk, A. and Strein C. (2012):

Open and Green Space Design. In: Pahl-Weber, E., Seelig, S. and Ohlenburg, H. (Eds.): *The Shahre Javan Community Detailed Plan*,

Planning for a Climate Responsive and Sustainable Iranian Urban Quarter. Young Cities Research Paper Series, Vol. 03 (TU Berlin, Berlin) pp. 105–106.

Gasemi, M. (2006):

barrasie hesse makan dar shahrhaie jaded. In: Karbalaii Nuri, R. and Riahi, F. (Eds.): *hoviiate shahrhaie jaded* (NTDC, Tehran) pp. 323–335.

- Ghamami, M.** (2008):
darbareie masa'le shahrsazie dr Irane emrooz (Agah, Tehran).
- Gorokhloo, M.** and Panahandeh-khah, M. (2009):
arziabie amalkarde shahrhaie jadid dar jazbe jam'iate kalanshahrha.
In: Pajuheshhaie Jografiaie Ensani, no. 67, pp. 17–25.
- Gorokhloo, M.** and Abedini, A. (2009):
arziabie chaleshha va moshkelate shahrhaie jadid va mizane
movaffagiate anha dar Iran: shahre jadide Sahand. In: Modarrese
Oloome Ensani, 13(1) pp. 165–191.
- Habibi, S. M.** (2007): az shar ta shahr (Tehran University Press, Tehran).
- Hashtgerd NTDC** (1993):
An Outlook: The New Town of Hashtgerd (nashr-e oloum-e daneshgahi,
Tehran).
- Heidari, A.** and Mohammadhoseini, P. (2010):
hesse makan dar shahrhaie jaded. In: Abadi, 19 (65) pp. 88–91.
- INTI** (International Newtown Institute) (2013):
Conference New Towns | New Territories. Online: <http://www.newtowninstitute.org/spip.php?article663> (Accessed 2013-03-05).
- Madanipour, A.** (2005):
Why do we build new towns? Experiences of Britain and Iran,
Proceeding of International Conference on New Towns 2005 (NTDC,
Tehran) pp. 69–81.
- Majedi, H.** (2006):
barrasie shahrhaie jadid az dide zibaiishenasi va hoviate shahri. In:
Karbalaie Nuri, R. and Riahi, F. (Eds.): hoviate shahrhaie jaded (NTDC,
Tehran) pp. 400–409.
- Mashhadizade Dehgani, N.** (2010):
barnamerizie shahri dar Iran (IUST Publishing Center, Tehran).
- Nasrollahi, F.** and Steffan, C. (2011):
New Generation Office Building. In: Schäfer, R., Nasrollahi, F.,
Ohlenburg, H. and Stellmacher, F. (Eds.): Accomplishments and
Objectives. Young Cities Research Paper Series, Vol. 02 (TU Berlin,
Berlin) pp. 82–90.

Nuñez von Voigt, T. and Vocks, M. (2012): Water Supply and Waste
Water Disposal. In: Pahl-Weber, E., Seelig, S. and Ohlenburg, H. (Eds.):
The Shahre Javan Community Detailed Plan, Planning for a Climate
Responsive and Sustainable Iranian Urban Quarter, Berlin, Young Cities
Research Paper Series, Vol. 03, pp. 93–95.

Ohlenburg, H., Seelig, S., Demuth, B. and Pahl-Weber, E. (2012): Procedural and Regulatory Innovations in the Iranian Detailed Plan Towards Greater Climate Responsiveness and Sustainability. In: Pahl-Weber, E., Seelig, S. and Ohlenburg, H. (Eds.): *The Shahre Javan Community Detailed Plan, Planning for a Climate Responsive and Sustainable Iranian Urban Quarter*. Young Cities Research Paper Series, Vol. 03 (TU Berlin, Berlin) pp. 15–20.

Pahl-Weber, E., Seelig, S. and Ohlenburg, H. (2011): Pilot Project 35 ha Area. In: Schäfer, R., Nasrollahi, F., Ohlenburg, H. and Stellmacher, F. (Eds.): *Accomplishments and Objectives*. Young Cities Research Paper Series, Vol. 02 (TU Berlin, Berlin) pp. 60–72.

Pahl-Weber, E., Wehage, P., Wolpert, A. and Leubert, N. (2011): Energy-efficient Homes, New Generation Residential Buildings, unpublished paper.

Peykadeh (2008): baznegarie tarhe jame shahre jadide Hashtgerd (Tehran).

Peykadeh (2004): tarhe tafsilie gesmati az shahre jedide Hashtgerd (Tehran).

Rahmani, N. (2004): negareshi bar shahre jadide Hashtgerd (Hashtgerd NTDC, Tehran).

Rezaii, R. and Salahi, G. (2006): shahre Pardis dar negahe shahrvandane saken. In: Karbalaii Nuri, R. and Riahi, F. (Eds.): *tajarobe ijade shahrhaie jaded dar Iran va Jahan* (TDC, Tehran) pp. 127–132.

Rückert, K., Grunwald, J. and Mahrin, B. (2011): Pilot Project New Quality. In: Schäfer, R., Nasrollahi, F., Ohlenburg, H. and Stellmacher, F. (Eds.): *Accomplishments and Objectives*. Young Cities Research Paper Series, Vol. 02 (TU Berlin, Berlin) pp. 90–94.

Sa'idnia, A. (2006): lozome tagiir dar shiveie tolid-e tarhhaie shahri dar shahrhaie jaded. In: Karbalaii Nuri, R. and Riahi, F. (Eds.): *tarhhaie tose'ie shahri, egtesad, modiriat, hamlonagl va terafik dar shahrhaie jadid* (NTDC, Tehran) pp. 85–103.

Seelig, S. (2011): A master plan for low carbon and resilient housing: The 35 ha area in Hashtgerd New Town, Iran. In: *Cities*, 28(6), pp. 545–56

Seelig, S., Wehage, P. and Pahl-Weber, E. (2011): Energie und Identität—Stadtgestaltung für eine energiegerechte New Town in Iran. In: *Stadtbauwelt* (189) pp. 64–69.

- Seelig, S., Wehage, P. and Pahl-Weber, E. (2012a):**
Urban Planning. In: Pahl-Weber, E., Seelig, S. and Ohlenburg, H. (Eds.): The Shahre Javan Community Detailed Plan, Planning for a Climate Responsive and Sustainable Iranian Urban Quarter. Young Cities Research Paper Series, Vol. 03 (TU Berlin, Berlin) pp. 72–78.
- Seelig, S., Wehage, P. and Pahl-Weber, E. (2012b):**
Urban Planning, Urban Design, and Architecture. In: Pahl-Weber, E., Seelig, S. and Ohlenburg, H. (Eds.): The Shahre Javan Community Detailed Plan, Planning for a Climate Responsive and Sustainable Iranian Urban Quarter. Young Cities Research Paper Series, Vol. 03 (TU Berlin, Berlin) pp. 96–100.
- Seelig, S., Ohlenburg, H. and Pahl-Weber, E. (2012a):**
Young Cities Project Background and Goals. In: Pahl-Weber, E., Seelig, S. and Ohlenburg, H. (Eds.): The Shahre Javan Community Detailed Plan, Planning for a Climate Responsive and Sustainable Iranian Urban Quarter. Young Cities Research Paper Series, Vol. 03 (TU Berlin, Berlin) pp. 10–11.
- Seelig, S., Ohlenburg, H. and Pahl-Weber, E. (2012b):**
The Shahre Javan Community Pilot Project. In: Pahl-Weber, E., Seelig, S. and Ohlenburg, H. (Eds.): The Shahre Javan Community Detailed Plan, Planning for a Climate Responsive and Sustainable Iranian Urban Quarter. Young Cities Research Paper Series, Vol. 03 (TU Berlin, Berlin) pp. 12–14.
- Seelig, S. and Pahl-Weber, E. (2012):**
Population and Social Studies. In: Pahl-Weber, E., Seelig, S. and Ohlenburg, H. (Eds.): The Shahre Javan Community Detailed Plan, Planning for a Climate Responsive and Sustainable Iranian Urban Quarter. Young Cities Research Paper Series, Vol. 03 (TU Berlin, Berlin) pp. 32–38.
- Sherkate Omrane Shahrhaye Jadid (1989):**
amalkard-e shahrhaye jadid ta paian-e sale 1367 (NTDC, Tehran).
- Shi'e, E. (2006):**
mogeiate shahrhaie jadide iran be nesbate shahrhaie asli va barrasie masaele paidari anha. In: Karbalaii Nuri, R. and Riahi, F. (Eds.): tarhhaie tose'ie shahri, egtesad, modiriati, hamlonagl va terafik dar shahrhaie jadid (NTDC, Tehran) pp. 151–165.

Talachian, M. (2005): negahi be sharha-ie jaded-e Iran (NTDC, Tehran).

Wehage, P. and Pahl-Weber, E. (2012):
Architectural Studies. In: Pahl-Weber, E., Seelig, S. and Ohlenburg, H. (Eds.): The Shahre Javan Community Detailed Plan, Planning for a Climate Responsive and Sustainable Iranian Urban Quarter. Young Cities Research Paper Series, Vol. 03 (TU Berlin, Berlin) pp. 39–41.

- Williams, K., Dair, C. and Lindsay, M. (2010):**
Neighbourhood Design and Sustainable Lifestyle. In: Jenks, M. and Jones, C. (Eds.): Dimensions of the Sustainable City (Springer, London and New York) pp. 183–214.
- Zabardast, E. and Jahanshahloo, L. (2007):**
barrasie amalkarde shahre jadide Hashtgerd dar jazbe sarrize jam'iat. In: Jografia va Tose'e (10) pp. 5–22.
- Zanjani, H., Eslambulchi, S. and Rahmani, F. (2003):**
rahnemaie jam'iate shahrhaie Iran (Centre for Iranian Urbanism and Architecture Studies, Tehran).
- Ziari, K. (2009):**
Barnamerizi-e shahrhai-e jaded (SAMT, Tehran).
- Ziari, K. (2004):**
arziabi-e nazarie va karkrd shahrhai-e jadid dar Iran. In: Naji, K. (Ed.): New Towns, New Culture of Urbanism (NTDC, Tehran) pp.97–114.

Project Profiles

Shushtar-No (Shushtar New Town)

Designer in Charge: Kamran Diba
Project Manager: A. Kashanijo, P. Rezagholizadeh
Senior Designer and Design Coordinator: C. P. Saberwal
Planners: S. Sadegh, Rawindra
Urban Designer: S. K. Manchandara
Landscape Architect: S. H. Bagley
Design Team: P. Pezeshki, G. H. Mamnoon
Contractor: Gilard Sistan & Day Construction Company

Young Cities: Developing Energy-Efficient Urban Fabric in the Tehran-Karaj Region

Project Coordinator (Germany): Prof. Dr. R. Schäfer
(Berlin University of Technology)
Project Coordinator (Iran): Dr. T. Parhizkar
(Building and Housing Research Center)

Project Dimensions

Urban Planning and Urban Design: Prof. E. Pahl-Weber, S. Seelig
Urban Design and Architecture: Prof. E. Pahl-Weber, Ph. Wehage
Transport and Mobility: Dr. W.-H. Arndt, N. Döge
Landscape Planning: Prof. Dr. S. Heiland, Dr. B. Demuth
Climatology: Dr. E. Reimer, Dr. S. Sodoudi, Dr. I. Langer

Energy Management: Prof. Dr. C. Nytsch-Geusen, J. Huber, Dr. S. Unger
Water Management: Dr. S. Mohajeri, T. Nuñez von Voigt
Waste Water Management: U. Görschel, Dr. M. Vocks

Design and Structure: Prof. Dr. K. Rückert, E. Shahriari, J. Grunwald,
S. Boog

Building Services Engineering: Prof. C. Steffan, Dr. F. Nasrollahi

Architecture and Engineering: Prof. U. Frank, A. Böhm

Project Management: Prof. Dr. B. Kochendörfer

Environmental Assessment: Prof. Dr. J. Köppel, H. Ohlenburg

Awareness Raising: Dr. H.-L. Dienel, S. Schröder, J. Schmithals

Capacity Development: Prof. Dr. J. Meyser, B. Mahrin

Figures

Fig. 1:	The location of Khusistan Province and Shushtar-No in Iran (Döge 2012)	20
Fig. 2:	Old Shushtar and New Town (Diba 1981)	20
Fig. 3:	Contemporary Art Museum, Karman Diba, view to the courtyard (Author)	21
Fig. 4:	Cultural Centre of Niavaran, Karman Diba, view to the skylights (Author)	21
Fig. 5:	Namaz Khaneh (praying place), Karman Diba (Author)	22
Fig. 6:	Jondi-Shapour University, Karman Diba, university mosque (Author)	22
Fig.7:	Yousef-Abad Garden (Shafag Park), Kamran Diba, view to the central plaza (Author)	23
Fig. 8:	Old Shushtar, urban pattern (Diba 1981)	26
Fig. 9:	Diagrammatic structure of the complex (Diba 1981)	27
Fig. 10:	Site plan of Shushtar-No (Diba 1981)	28
Fig. 11:	Topography of the site (Diba 1986)	28
Fig. 12:	Detailed site plan (Diba 1981)	29
Fig. 13:	Compact urban tissue and low-rise, high-density pattern (Diba 1981)	30
Fig. 14:	Street pattern of the central neighborhood (Diba 1981)	30
Fig. 15:	View to one of the streets (Author)	30
Fig. 16:	Roofscape of the residential section (Diba 1981)	30
Fig. 17:	Typical housing layout in old Shushtar (Diba 1986)	31
Fig. 18:	Housing concept and typology (Diba 1986)	31
Fig. 19:	Residential plan of the central neighborhood (Diba 1981)	32
Fig. 20:	Different courtyard typologies (Diba 1981)	33

Fig. 21: Urban Courtyard, Community Courtyard, and Individual Courtyard (Author, after Diba 1981)	34
Fig. 22: Garden of Yousef-Abad, site plan (Diba 1981)	36
Fig. 23: Jondi-Shapour University, beginning of the main pedestrian axis (Diba 1981)	36
Fig. 24: Distribution of the public services in Shushtar-No (Diba 1986)	37
Fig. 25: City square, site plan (Diba 1981)	37
Fig. 26: Closed texture pattern (Diba 1986)	37
Fig. 27: Narrow street pattern (Diba 1986)	38
Fig. 28: Deep arcades of the shopping center (Author)	38
Fig. 29: Locally available construction technology and materials (Author)	39
Fig. 30: Parking places are isolated and not allowed in the residential quarters (Author, after Diba 1981)	40
Fig. 31: Public greenery and semi-public, semi-private greenery in front of the apartments (Diba 1981)	41
Fig. 32: The lack of urban services: waste is not collected regularly (Author)	42
Fig. 33: Green space has been left unattended (Author)	42
Fig. 34: Gas pipes, ventilators, and advertisement signs have been installed carelessly (Author)	43
Fig. 35: Public passages need renovation (Author)	43
Fig. 36: Courtyards have been converted to garages (Author)	44
Fig. 37: Balconies walled or added to interior (Author)	44
Fig. 38: Renovation with different materials (Author)	45
Fig. 39: Semi-public, semi-private greenery left unattended (Author)	45
Fig. 40: Semi-public, semi-private greenery walled and added to the property (Author)	45

Fig. 41: Small windows walled for privacy or security reason (Author)	45
Fig. 42: Misused shopping center (Author)	46
Fig. 43: Public parking places are empty (Author)	46
Fig. 44: Cars enter the urban texture, despite the original car-free concept (Author)	47

Fig. 45: The location of Hashtgerd New Town (Young Cities Project).	53
Fig. 46: First Comprehensive Plan of Hashtgerd New Town, Tarh-va-Me'mari Consultation (Tarh-va-Me'mari Consultation)	55
Fig. 47: Detailed Plan of the central area, First Comprehensive Plan of Hashtgerd New Town, Tarh-va-Me'mari Consultation (Tarh-va-Me'mari Consultation)	56
Fig. 48: Revised Comprehensive Plan, Peykadeh Consulting Engineers (Young Cities Project, after Peykadeh Consulting Engineers)	57
Fig. 49: View to the public space of one of the residential quarters with apartment buildings (Author)	59
Fig. 50: View to the Municipality building at the central square (Author)	59
Fig. 51: View to the central commercial zone (Author)	60
Fig. 52: View to the central Mosque and cultural center (Author).	60
Fig. 53: View to the main public park (Author).	61
Fig. 54: View to a local shopping and commercial center (Author)	61
Fig. 55: Cityscape, a panorama view to the town (Author).	62
Fig. 56: The location of the Shahre Javan Community Pilot Project in Hashtgerd New Town, Aerial view (Author, after Young Cities Project)	69
Fig. 57: The location of the Shahre Javan Community Pilot Project in Hashtgerd New Town Comprehensive Plan (Author, after Peykadeh 2008)	70
Fig. 58: Typical housing typology and urban pattern (Wehage and Pahl-Weber 2012)	71
Fig. 59: Site plan of the Shahre Javan Community Pilot Project (Wehage, Seelig, Pahl-Weber)	72
Fig. 60: Land use plan of the Shahre Javan Community Pilot Project (Seelig, Wehage, Pahl-Weber)	72
<hr/>	
Fig. 61: Compact urban form in the traditional Iranian city, Isfahan.	73
Fig. 62: Compact urban form in the Shahre Javan Community Pilot Project (Wehage, Seelig, Timme, Pahl-Weber)	73
Fig. 63: The pattern of vertical mixed land use (Seelig, Wehage, Pahl-Weber 2012)	74

Fig. 64: Introverted courtyard typology versus extroverted typology (Wehage and Leubert, after Mansour)	74
Fig. 65: The pattern of courtyard housing (Wehage, Wolpert, Pahl-Weber)	75
Fig. 66: Variety of alternatives for housing typology (Wehage, Pahl-Weber)	75
Fig. 67: Perspective to the sub-neighborhood (Wehage, Pahl-Weber)	76
Fig. 68: Ground level of the sub-neighborhood (Wehage, Wolpert, Pahl-Weber)	76
Fig. 69: View to the public space of the sub-neighborhood (Wehage, Wolpert, Pahl-Weber)	77
Fig. 70: View to the courtyard of a residential unit (Wehage, Wolpert, Pahl-Weber)	77
Fig. 71: Energy concept for the Shahre Javan Community area (Nytsch-Geusen, Huber)	78
Fig. 72: Sub-soil energy use as example for energy saving heating technologies (Wolpert, Wehage, Pahl-Weber)	79
Fig. 73: Traffic concept of the Shahre Javan Community area (Döge, Arndt)	80
Fig. 74: Cross section of the main road (Döge, Arndt)	81
Fig. 75: Distribution of greenery in the Shahre Javan Community area (Ohlenburg, Nagel, Demuth, Garske)	82
Fig. 76: Landscaping scheme of the Shahre Javan Community area (Fenk, Strein, Pahl-Weber)	83
Fig. 77: Landscaping in sub-neighborhood level (Wehage, Seelig, Timme, Pahl-Weber)	84
Fig. 78: Narrow streets in Shushtar-No (Diba 1986)	90
Fig. 79: Narrow streets in the Shahre Javan Community Pilot Project, schematic design (Seelig, Wehage, Leubert, Pahl-Weber)	90
<hr/>	
Fig. 80: Figure-Ground scheme of the projects (left: Diba 1981; right: Wehage, Seelig, Pahl-Weber)	91
Fig. 81: Architectural measures to protect privacy and to use the sunlight (Wolpert, Wehage, Pahl-Weber)	93
Fig. 82: Semi-public greenery in front of the residential units (Wehage, Seelig, Timme, Pahl-Weber)	96

Fig. 83: Time-stage framework (Author) 110

Fig. 84: Involved institutions and their tasks (Author). 111

Tables

Tab. 1: Population growth of Iran from 1900 to 2006 (Author, after Zanjani 2003; Ziari 2009)	50
Tab. 2: Population prediction in Hashtgerd (Hashtgerd NTDC, 1993)	54
Tab. 3: Population of Hashtgerd New Town (Markaze Amar 2011 and Peykadeh 2008)	58

Abbreviations

AAC	Autoclaved Aerated Concrete
BHRC	Building and Housing Research Center
BMBF	German Federal Ministry of Education and Research
CMMU	Community Management and Monitoring Unit
CW	Constructed Wetlands
ETICS	External thermal Insulation Composite System
HIC	Housing Investment Company
NTDC	The New Towns Development Corporation of Iran
pph.	person per hectare
SA:V	surface-area-to-volume
SJCT	Shahre Javan Community Trust



Universitätsverlag der TU Berlin

ISSN 2193-6099 (Print)

ISSN 2193-6102 (Online)

ISBN 978-3-7983-2512-8 (Print)

ISBN 978-3-7983-2513-5 (Online)



BHRC

**Road, Housing & Urban
Development Research
Center**

ISBN 978-600-5392-63-0