

# REPORT OF 2<sup>nd</sup> INTERNATIONAL WORKSHOP ON HAKE OTOLITH AGE READING. (Vigo, 15-19 February, 1999)

By

Piñeiro C. (Chairperson)<sup>1</sup>, Afonso M. H.<sup>2</sup>, Arego S.<sup>3</sup>, Bellail R.<sup>4</sup>, Labastie J.<sup>4</sup>, Loureiro I.<sup>1</sup>, Lucio P.<sup>3</sup>, Marecos L.<sup>2</sup>, Mc Cormick H.<sup>5</sup>, Moguelet Ph.<sup>4</sup>, Morgado C.<sup>2</sup>, Sainza M.<sup>1</sup>, Santurtún M.<sup>3</sup>, Trujillo V.<sup>1</sup>, Watson T.<sup>6</sup> and Woods F.<sup>5</sup>

## 1. Introduction

One of the main goals of the EC Study Contract No. **97/015** (DEMASSESS) is to improve the knowledge of Hake (*Merluccius merluccius*) growth for the northern and southern stocks.

The growth of European Hake from Atlantic waters has been widely studied and many researchs have been carried out to improve the knowledge on the formation and interpretation of rings in the otoliths Hickling, 1930; Bagenal, 1954, Bussy, 1966; Robles *et al.*, 1975; Decamps and Labastie, 1978; Iglesias and Dery, 1981; Goñi, 1983; Goñi and Piñeiro, 1988; Guichet, 1988; Lucio *et al.* 1998a, b; Piñeiro and Hunt, 1989; Piñeiro and Pereiro, 1993; Piñeiro and Meixide, 1994; ICES CM 1983, 1984, 1986, 1996, 1997, 1999)).

Due to difficulties encountered in age determination, Hake has been considered by EFAN (European Fish Ageing Network) as a priority study case.

Taking into account the recommendations of the Workshop on Hake ageing held in Vigo, in 1997 based on otoliths interpretation (Anon., 1997), it was decided to carry out an exchange of Hake otoliths from these stocks in 1998 between the countries involved in hake stock assessment. The participants of this workshop were: IPIMAR/Portugal, IEO/Spain, AZTI/Spain, IFREMER/France, MIFRC/Ireland and CEFAS/England.

Conducting an age reading Workshop on Hake is considered a priority because:

- Hake is of great commercial importance, which is reflected into catch value and related economy especially for Spain, France and Portugal, amongst others.
- Although several International *ad hoc* Workshops have been devoted to otolith age reading (ICES CM 1983, 1984, 1986, 1998, 1999 and Anon., 1997) a standard criteria of Hake otolith interpretation has not yet been reached for all ages.
- In recent years the ICES Working Group on the Assessment of Southern Shelf Demersal Stocks has applied numerical methods (Kimura and Chikuni, 1987) to the annual length composition of catches in order to obtain a catch at age matrix for the assessment of the Southern stock of Hake (ICES CM 1992, 1994, 1995). However, the Working Group considers the use of age length keys more reliable in order to obtain catch at age data.
- Also new inexperienced staff become involved with hake age determination and need to get used to the otolith interpretation criteria.

In order to analyse the results of this exchange and to follow the recommendation of ICES (ICES CM 1994) and the Workshop of 1997 (Anon., 1997), a new Workshop was planned for

the first quarter of 1999. The objective was to continue the work started in the 1997 Workshop (Anon., 1997) in order to improve the agreement between readers.

<sup>1</sup> Instituto Español de Oceanografía (IEO, Spain)

<sup>2</sup> Instituto de Investigação das Pescas e do Mar (IPIMAR, Portugal)

<sup>3</sup> Instituto Tecnológico, Pesquero y Alimentario (AZTI, Spain)

<sup>4</sup> Institut Français de Recherche pour l'Exploitation de la Mer (IFREMER, France)

<sup>5</sup> Marine Institute Fisheries Research Centre (MIFRC, Ireland)

<sup>6</sup> Centre for Environment, Fisheries & Aquaculture Science. (CEFAS, United Kingdom)

## 2. Objectives of the Workshop

- Analysis and discussion of the results of the otoliths hake exchange in order to overcome the main problems refereed in the last workshop.
- Elaborate a consensus on ageing criteria between the main laboratories involved in Northern and Southern Hake stock assessments.
- Establish a protocol for Hake age determination.

## 3. Participants

Afonso M. H., IPIMAR, Lisbon, Portugal

Arego S., AZTI, Sukarrieta, Spain

Bellail R., IFREMER, Lorient, France

Labastie J., IFREMER, La Rochelle, France

Loureiro I., IEO, Vigo, Spain

Lucio P., AZTI, Sukarrieta, Spain

Marecos L., IPIMAR, Lisbon, Portugal

Mc Cormick H., MIFRC, Dublin, Ireland

Moguedet Ph., IFREMER, La Rochelle, France

Morgado C., IPIMAR, Lisbon, Portugal

Piñeiro C., IEO, Vigo, Spain (Chairperson)

Sainza M., IEO, Vigo, Spain

Santurtún M., AZTI, Sukarrieta, Spain

Trujillo V., IEO, Vigo, Spain

Watson T., CEFAS, Lowestoff, England

Woods F., MIFRC, Dublin, Ireland

Alain Biseau, IFREMER, Lorient, France (*Last day* \*)

(\*) *Chairman of the ICES Working Group on the Assessment of Southern Shelf Demersal Stocks.*

## 4. Material and Methods

### 4.1. Material

The otolith collection exchange conducted during 1998 was composed of 200 Hake otolith sections from individuals ranging between 12cm and 102cm length. Two samples were available:

Sample 1: 100 otolith sections prepared by IEO from commercial catches sampled throughout the year and from a demersal survey conducted during the last quarter of 1997 in the Galician and Cantabrian Sea (ICES Divisions VIIIc and IXa respectively). The size ranged from 12cm to 69 cm.

Sample 2: 100 otolith sections prepared by IFREMER from a demersal survey conducted

during the last quarter of 1997 in the Bay of Biscay and the Celtic Sea (ICES Divisions VIIIa, b and VIIf, g, h, respectively). The size ranged between 19cm and 102 cm.

Otoliths were mounted in black coloured resin blocks and thin sections were obtained through the nucleous level for ageing purposes. The method of otolith preparation was quite similar for both Institutes: IEO stored the otoliths in a solution of glycerine (40%) in order to enhance the rings prior to sectioning and mounted the thin sections on glass slides. IFREMER stored the otoliths dry and made several cuts for the same otolith, in order to achieve the optimum cut. In this case, sections were not mounted on glass slides.

Catch date and sex information were available and also the total length in the case of IEO samples.

Two readings were performed during the workshop (second and third readings). Due to time constraints subsamples of the exchange sample were chosen for these readings. The size range of each subsample was maintained. The second reading consisted of 95 otolith sections, 41 from IFREMER and 54 from IEO, attempting to include well sectioned otoliths. The third reading consisted of 64 otoliths, 33 from IFREMER and 31 from IEO. Otoliths used in the second reading were excluded from the third reading in order to avoid the influence memory may have. The length frequency distribution of the samples aged are presented in Figure 1.

#### 4.2 Age determination

Ageing was carried out with magnification x20, using a stereomicroscope under reflected light. Transmitted light was used occasionally. During the workshop a video camera and monitor were available for the discussion of the criteria used in otolith age interpretation. To assess whether the readers counted the same rings, it was decided to take *radii* measurements as per the protocol (**Annex 1**).

Since three sections of IFREMER samples were made of each otolith, depending on the section chosen for age determination, readers may have assigned different measurements to the same otolith. As a result it was decided only to consider the measurements of the IEO sample.

Eleven readers participated in the exchange but only ten carried out age readings in the Workshop (R6 did not read). Although all readers were experienced in reading otoliths, two participants were considered to be more experienced in ageing Hake (see table below \*\*). Three of the readers did not participate in the previous 1997 Hake otolith workshop (see table below \*).

During the otolith exchange the codes used for readers in the analyses were as follows:

READERS	CODE	READERS	CODE
Jacques Labastie (IFREMER)	R1 **	Maria Sainza (IEO)	R7
Lourdes Marecos (IPIMAR)	R2	Carmen G <sup>a</sup> Piñeiro (IEO)	R8 **
Hortense Afonso (IPIMAR)	R3	Robert Bellail (IFREMER)	R9
Terry Watson (CEFAS)	R4 *	Fiona Woods (MIFRC)	R10 *
Susana Arego (AZTI)	R5	Helen Mc Cormick (MIFRC)	R11 *
Isabel Loureiro (IEO)	R6		

\* Not present in the first workshop in hake otoliths

\*\* Experts in hake otoliths

The general criteria adopted for ageing each otolith are shown in the protocol (**Annex 1**).

These are based on the number of annual translucent rings.

In order to attain the objectives of the Workshop the following tasks were performed:

- Analysis of the exchange results (first reading).
- Discussion about individual interpretations of the otoliths, not only on those on which there was a large discrepancy amongst readers but also those on which the age assigned was the same.
- Reading of the 2<sup>nd</sup> sub-sample (95 otoliths).
- Analysis of the second reading results.
- Reading of the 3<sup>th</sup> sub-sample (64 otoliths), conducted to ascertain whether application of the discussed criteria improved agreement between readers.
- Analysis of the third reading results.
- Interpretation of the growth pattern for the first years of the biological cycle of the fish.
- Report of the workshop.

In order to conduct statistical analysis it was decided to split the samples according to institute (IEO, IFREMER) due to their different characteristics (different area and preparation technique).

In comparison with the last workshop a more extensive analysis was performed in order to provide more details concerning individual performances. Several methods were used to analyse the results of the exchange, such as those recommended by the Workshop on Sampling Strategies for Age and Maturity (ICES CM, 1994). However, the Wilcoxon's rank test was considered inappropriate in performing multiple paired comparisons when more than two readers are involved in ageing the same collection, which is observed in this Workshop (Zar, 1996).

### **4.3. Data Analysis**

#### **4.3.1. Exploratory data analysis (EDA)**

- Determination of the modal age and of the difference between each readers' age and the modal age. The modal age was calculated based on results from readers R1, R2, R3, R5, R7 and R8. In case of bi-modality the modal age was estimated from readers R1 and R8, the readers with most experience.
- Graphical representation by reader for each sample (IEO and IFREMER), using box-whisker plots (median and interquartil range by reader). The box-whisker plots were used to summarise the observations and are useful in observing and comparing the distribution of the otolith readings by reader.
- Age reading comparisons were carried out according recommendations made by ICES (ICES CM, 1994). A spreadsheet to produce the age bias plots and related tables was kindly made available by Guus Eltink (RIVO. IJmuiden. The Netherlands).
- For each otolith, mean age, mode, range and standard deviation were estimated. Modal bias

plots showed average age  $\pm 2$  standard deviation of each age reader and all age readers were plotted against modal age, which was considered to be the referential age. The modal age was calculated as commented before.

#### 4.3.2. Computation of reproducibility measures :

1) Average percent age error (APE), Beamish and Fournier (1981) is an index of reading precision to compare a series of observations. The formula is as follows:

$$APE = \frac{100}{n} \sum_{i=1}^n \left( \frac{1}{r} \sum_{j=1}^r \frac{|x_{ij} - \bar{x}_i|}{\bar{x}_i} \right) \quad (1)$$

n = number of otoliths

r = number of readings for each otolith

$x_{ij}$  = the  $j$  value of age estimation for the otolith

$\bar{x}_i$  = average age calculated for the otolith

2) The Mean Coefficient of Variation (V)

$$V = \frac{100}{n} \left[ \sum_{i=1}^n \left( \frac{sd}{x_i} \right) \right] \quad (2)$$

sd = the standard deviation for the otolith  $i$

3) The index of precision (D) (Chang, 1982):

$$D = \frac{1000}{n} \left[ \sum_{i=1}^n \frac{V}{r^{0.5}} \right] \quad (3)$$

V is described in 2)

These measurements are more appropriate than the conventional percent of agreement when comparing ages, since those take into account the average year class of fish.

#### 4.3.3. Grouping readers

In order to determine the different groups of readers with higher agreement between them, the following statistical analyses were carried out:

- Hierarchical cluster analysis using average linkage (between groups) based on squared Euclidean measure for readers without transforming the data.
- Multiscaling dimension (MSD) to show the multidimensional space based on squared Euclidean measure for readers without the transformation of input data using an ordinal measure scale.

## 5. Results

### 5.1. First Reading

The results of the 200 otoliths ageing are summarised in Tables 1 and 2.

The Box-whisker plot for all readings from IEO sample pointed out three general groups with similar interpretations (Figure 2a):

- 1/ R1, R2, R4, R8 and R9
- 2/ R3, R5, R6 and R7
- 3/ R10 and R11

The Box-whisker plot for all readings from the IFREMER sample pointed out four general groups with similar interpretations but these groups are different from the previous ones (Figure 2b):

- 1/ R1, R2, R6, R7, R8 and R9
- 2/ R3 and R5
- 3/ R4
- 4/ R10 and R11

The IEO sample Modal bias plot by reader (Table 3 and Figure 3 a, b) showed that R4, R10 and R11 in general underestimated the ages. This could be due to their lack of experience in hake age determination. On the other hand, readers R3, R6 and R8 presented a tendency to overestimate the ages of the older fish. Reader R5 showed a tendency to overestimate fish of ages 2 and 3. The Modal bias plot for all readers shows some problems in age determination for age 5 and above.

The Modal bias plot results of the IFREMER sample (Table 4 and Figure 4 a, b) showed that the same readers (R4, R10 and R11) are still underestimating the ages. On the other hand, R9 tended to underestimate the older ages. R3 presented a tendency to overestimate fish from age 2 and above whilst R5 overestimated the younger fish (ages 2 and 3). The Modal bias plot for all readers show that ages are underestimated in relation to the modal age.

The APE, V and D indices are shown in Table 5. When the analysis is carried out using only the more experienced readers (R1 and R8) these indices decreased considerably. The results are different for the two samples. The IFREMER sample consists in larger individuals than the IEO sample. Thus, the IEO sample APE and V indices are higher than those for the IFREMER sample (Figure 5a-d). It should be noticed that the APE index is very sensitive to differences in younger ages.

The dendrogram obtained from the hierarchical cluster analysis from the IEO and IFREMER samples point out the presence of two main groups, depending on the distance assumed (Figures 6a ,b). In order to clarify the groups, a plot of coordinates from MSD analysis was carried out for each sample (Figures 7a, b). It can be seen from these plots that the first dimension splits also the plot into two groups, supporting the results of the hierarchical cluster analysis.

The two groups in each case are as follows:

- 1/ R1, R2, R3, R5, R6, R7, R8 and R9
- 2/ R4, R10 and R11

The first group consisted of readers with variable levels of experience in Hake otolith reading. The second group consisted of readers with little or no experience in reading Hake otoliths prior to this exchange, although they show extensive experience in reading otoliths of other species.

## 5.2 Second Reading

The readings of the 95 otoliths used in the second reading are presented in Tables 6 and 7.

The box-whisker plot for all the readings from IEO sample pointed out three groups with similar interpretations (Figure 8a):

- 1/ R1, R7 and R8
- 2/ R2, R3, R4, R5, R9 and R10
- 3/ R11

The box-whisker plot for all the readings from the IFREMER sample also pointed out three groups with similar interpretations but these groups are different from the previous ones (Figure 8b):

- 1/ R1, R2, R3, and R4
- 2/ R5, R7, R8, R9 and R10
- 3/ R11

In both cases, R11 appears isolated from the other readers. It is to be noted that some readers changed location.

The IEO sample Modal bias plot by reader showed that R4, R9 and R11 in general overestimated the ages. From the first reading to the second reading they changed their criteria of interpretation (Figure 9a,b) because of their lack of experience in Hake age determination. The Modal bias plot for all readers shows improvement in ageing fish younger than 3 years. However, problems in age determination from age 4 and above still remain.

The Modal bias plot results from the IFREMER sample show that the same readers are still overestimating the ages (Figure 10 a, b). R5, R7, R8 are underestimating some ages. The Modal bias plot for all readers shows that in general ages 0 to 3 are well estimated, although problems still remain for the older ages (4 and above). Ages from 3 to 5 are overestimated in relation to the modal age (Tables 8 and 9).

The APE and V Indices are shown in Table 10. The IEO reproducibility measures (APE, V and D indices) are higher than those of the IFREMER sample, but when each sample is compared with the first reading (all readers) there is a mean reduction of error of 12%.

The reproducibility measures obtained with the IEO otoliths collected in the 4<sup>th</sup> quarter were calculated in order to analyse whether the differences in the age attributed by readers were due to difficulties in interpreting the edge. Results obtained were similar to those obtained considering all otoliths (Table 10).

The dendrogram from the hierarchical cluster analysis obtained in both samples, based on the distance used previously, pointed out different results (Figure 11a, b).

In the case of the IEO sample, there are two main groups as follows:

1/ R1, R2, R3, R5, R7, R8, R9 and R10  
2/ R4 and R11

In the case of the IFREMÉR sample there are two groups as follows:

1/ R1, R2, R3, R4, R5, R7, R8, R9 and R10  
2/ R11

Again, R11 appears isolated from the other readers. The MSD plots (Figure 12 a, b) show also the same pattern for R11, R4 and R9, which are moving around the main group.

It can be seen that the main group is almost stable and the less experienced readers are quite erratic/unstable.

The results obtained from the first and second readings are consistent. The readers with the least \experience in ageing Hake otoliths appear to have unstable criteria for their age determination. On the other hand, in general terms ages 0 to 3 are well estimated and the problems in age determination only remain for older Hake (age 4 and above).

### **5.3. Third Reading**

The results of the ageing of the 64 otoliths (31 from IEO and 33 from IFREMÉR) used in the third reading are presented in Tables 11 and 12.

The Box-whisker plot for the all readings from IEO sample pointed out three main groups with similar interpretations (Figure 13 a):

1/ R1, R4, R7, R8 and R9,  
2/ R2, R3 and R5  
3/ R10 and R11

The Box-whisker plot for all the readings from the IFREMÉR sample pointed out two groups with similar interpretations but these groups are different from the previous ones (Figure 13b):

1/ R1, R2, R3, R5, R8, R9, R10 and R11  
2/ R4 and R7

The IEO sample Modal bias plot by reader show that the new readers (R4, R10 and R11) tend to underestimate or overestimate ages up to 2 (Figure 14 a). In general the ages older than 4 are overestimated by all readers (Figure 14 b).

The results from the IFREMÉR sample show that the reader R9 is overestimating the ages up to one (Figure 15a). The Modal bias plot for all readers shows that ages from 0 to 6 are quite well estimated, although problems still remain for age 5 (Figure 15b).

The APE, V and D indices are presented in Table 13. The reproducibility measures obtained with the IEO sample are higher than those from the IFREMÉR sample. But, when each sample measures are compared to the first reading measures including all readers, there is a clear reduction of error for the IFREMÉR reproducibility values. As mentioned before, the difference between the results of both samples might come from the different length frequency distributions. The IEO sample consisted in more young fish than the IFREMÉR sample.

The dendograms from the hierarchical cluster analysis obtained based on the same cut distance



previously used, pointed out two main groups for both samples but with different readers in each of them (Figure 16 a, b).

IEO sample:

1/ R1, R2, R3, R5, R7,R8, R9 and R11

2/ R4 and R10

IFREMER sample:

1/ R2, R3, R5, R7, R8

2/ R1, R4, R9, R10 and R11

The MSD plots (Figure 170 a, b) also show the general pattern found in the previous readings. A group of readers, which includes R4, R9, R10 and R11, are moving around the more experienced main group.

In general terms, ages 0 to 4 are well estimated and the problems in age determination remain for older Hake.

## 6. Discussion

The results obtained throughout these three readings are consistent. The readers with less experience in ageing Hake otoliths (R4, R9, R10 and R11) appear to have unstable criteria for age determination (Tables 14, 15). The differences found in the results of the third reading with respect to the second one, could be due to the low number of otoliths read (31) and the criteria used to select the third subsample. However, throughout the three readings, the non-experienced readers have changed their criteria of interpretation in relation to the consensus ageing criteria established in the previous workshop.

The analyses of the readings from the IFREMER samples show better agreement than those from the IEO samples. This could be due to the methodology used for the analysis in which differences in older ages cause less discrepancy than differences in younger ages. It has to be considered that the IEO sample has a higher proportion of fish smaller than 45 cm, particularly juvenile fish, while the IFREMER sample has a greater number of old individuals.

As it was mentioned in the Report of the First Workshop (Anon., 1997), one of the main problems of the ageing of this species is the location of the first annual ring (Figure 18 a, b and c). It seems that in the first reading the new readers had some problems in locating that ring, the check and consequently the second ring. During the present workshop there was a remarkable improvement in identifying the same ring as the first annual ring by all readers (Figure 19). ). In general, the standardised principles for the interpretation of hake otoliths established in the first Workshop were followed by all readers.

Concerns were expressed from the majority of the readers regarding the poor preparation of some otolith sections, like nucleous missing, or several sections from the same otolith showing different ring structures. Respecting to the IFREMER sample, different ages could have been assigned to the same otolith depending on what section was chosen for age determination.

During the Workshop, the use of various microscopes and time constraints could have been also sources of error. Different size ranges of samples in each reading could have decreased also the values of the agreement indices considered in this work. This may be particularly relevant regarding the third reading results.

Some readers found the interpretation of the otoliths from the Southern Hake stock more

difficult, which may be related the different growth and otoliths pattern between the two stocks.

In terms of reproducibility measures (APE, V and D), the values for all readers in general decreased since the first reading, particularly for the IFREMER sample. V and D indices of expert readers reduced, but the APE index remained the same. It should be stressed that this measures of agreement should be interpreted with caution due to influence of sample size and of younger ages, in the case of APE.

Results indicate that in a near future it may be possible to use the annual ALK instead of numerical methods to estimate age composition of catches in the case of the Southern stock Hake assessment, taking into account the observed agreement between the readers involved.

At the moment the age structure composition of the Northern Hake stock catches are only based on IFREMER ALKs. Therefore, if an agreement on age reading is reached, the possibility of applying ALKs from AZTI in addition to IFREMER can be considered.

It was agreed that a comprehensive reference otolith collection representative of all ages used in the age length key should be prepared, in order to help readers and also for training purposes.

## **7. Conclusions**

- The statistical analysis shows two main groups of readers: experienced and no experienced. It is recognised the importance of experience in Hake ageing.
- The agreement between readers for ages 0 to 4 improved comparatively to the first Hake Workshop. This can be a result of the adoption of the ageing criteria established in that Workshop.
- There was a high level of variability between readers for ages 5 and older.
- A high agreement in locating the first annual ring between readers was achieved.
- The less experienced readers showed improvement in their age interpretation criteria.
- Despite the improvement of all the readers, the results highlight the difficulties in interpreting the age of Hake otoliths and justify the need for periodical exchange exercises.

## **8. Recommendations**

- Results indicate that may be possible to use the annual ALK, instead of numerical methods, to estimate the age composition of catches of the Southern Stock of Hake.
- In order to use the same ALK for Northern stock assessment, the age estimation criteria should be the same for AZTI and IFREMER.
- Informal exchanges should be carried out between Institutes on a regular basis, especially for those who supply ALK's to the assessment Working Group.
- Images of sectioned otoliths from the exchange collection will be digitised and interpreted by the more experienced readers. This will act as both a reference collection and an age determination guide.

- Another otolith exchange and Workshop should be convened in the next two years.
- Statistical tests on age data of each Institute should be carried out before they are combined for ALK's.
- It is desirable that at least two people per Institute should be involved in Hake age determination. Also some more countries should take part in this studies.
- Otoliths used in an exchange should be prepared following the same methodology and suitable for transportation.
- It is necessary to validate the age estimation of this species by conducting more studies on the life history events of the fish, in addition to exploring alternative validation techniques (tagging, microchemistry, etc.). These recommendations require a dedicated project on these matters.

## 9. Contributions to the Workshop

Additional information was presented during the Workshop, in order to improve the age determination of this species:

- Quarterly length composition (in percentage) of juvenile Hake (<30 cm) catches, including discards by bottom trawlers in the Bay of Biscay, for the period 1988-1997, from AZTI. (Values for the 3<sup>rd</sup> quarter of 1988 were estimated from the 2<sup>nd</sup> and 4<sup>th</sup> quarters) (Annex II).
- Preliminary results on daily growth of juvenile hake, from IPIMAR (Annex III).
- A training guide to introduce the readers to the age reading criteria established for hake with digitised images of otolith sections from ages 0 to 4 (Annex IV).

## 10. References

- Anon. 1997. Report of the Workshop on Hake otoliths age readings. EC Study Contract no. 95/038 "Biological studies of Demersal Fish (BIOSDEF)12pp.
- Bagenal, T.B. 1954. Growth rate of the hake (*Merluccius merluccius L.*) in the Clyde and other Scottish areas. J. Mar. Biol. Ass, U.K., 33(1): 69-95.
- Beamish, R. J. and Fournier, D. A. 1981. A method for comparing the precision of a set of age determinations. Can. J. Fish. Aquat. Sci. 38 : 982-983.
- Busy, M. M., 1966. La croissance du merlu dans le Golfe de Gascogne. ICES, C.M. 1966/G:17.
- Chang, W. Y. B., 1982. A statistical method for evaluating the reproducibility of age determination. Can. J. Fish Aquat. Sci. 39 : 1208-1210.
- Decamps, P. and J. Labastie, 1978. Note sur la lecture et l'interpretation des otolithes du merlu. ICES, C.M. 1978/G:41.
- Eltink, G., 1994. Comparison of otolith readings. Working document for the Workshop on sampling strategies for age and maturity, 1994 at ICES Copenhagen.

- Goñi, R., 1983. Growth studies of European hake (*Merluccius merluccius* L.) from the Northwest African shelf. Demersal Fish Committee C.M. 1983/G10.
- Goñi, R. and C. Piñeiro, 1988. Study of the growth pattern of European hake (*Merluccius merluccius* L.) from the Southern stock: ICES Divisions VIIIc and IXa. ICES, C.M. 1988/G:18.
- Guichet, R. 1988. Etude de la croissance du merlu européen (*Merluccius merluccius* L.) au cours de ses premières années. Analyse per NORMSEP des distributions en taille observées trimestriellement en mer de 1980-87. Working Paper in ICES, C.M. 1988/WP assess:24.
- Hickling, C.F., 1930. The natural history of the hake. Part III. Seasonal changes in the condition of hake. Fish. Invest., Ser. II, XII (1).
- ICES CM, 1983. Confrontation Technique sur les Methodologies Utilisées pour la Lecture des Otoliths de Merlu. La Rochelle, France, 7-13 June, 1983. Appendix of Report of the Working Group on Assessment of Hake Stocks. ICES, C.M. 1983/Assess:2.
- ICES CM, 1984. Report of the *ad hoc* Hake Otolith Working Group, La Rochelle, France, 28 May - 1 June 1984. ICES, C.M. 1984/G:74.
- ICES CM, 1986. Report of the *ad hoc* Study Group on Hake, Lowestoft, 2-6 June 1986. ICES, C.M. 1986/G:93.
- ICES CM, 1992. Report of the Working Group on the Assessment of Southern Shelf Demersal Stocks, Copenhagen, 8-17 September 1992. ICES, C.M. 1993/Assess:3.
- ICES CM, 1994. Report of the Workshop on Sampling Strategies for Age and Maturity. ICES, C.M. 1994/D: 1, 67 pp.
- ICES CM, 1994. Report of the Working Group on the Assessment of Southern Shelf Demersal Stocks. ICES CM. 1994/Assess 3: 447 pp.
- ICES CM, 1995. Report of the Working Group on the Assessment of Southern Shelf Demersal Stocks. ICES CM. 1995/Assess 6: 598 pp.
- ICES CM, 1996. Report of the Working Group on the Assessment of Southern Shelf Demersal Stocks. ICES CM 1996/Assess 5: 493 pp.
- ICES CM, 1997. Report of the Working Group on the Assessment of Southern Shelf Demersal Stocks. ICES CM 1997/Assess 5: 640 pp.
- ICES CM, 1998. Report of the Working Group on the Assessment of Southern Shelf Demersal Stocks. ICES CM 1998/Assess 4: 664 pp.
- Iglesias, S. and L. Dery, 1981. Age and growth studies of hake (*Merluccius merluccius* L.) from ICES divisions VIIIc and IXa. ICES, C.M. 1981/G:38.
- Kimura, D. K. and S. Chikuni. 1987. Mixtures of the empirical distributions: an iterative application of the age-length key. Biometrics. 13: 23-35.
- Lucio, P., Murua, H. and Santurtún, M., 1998a. Growth and reproduction of hake (*Merluccius merluccius*) in the Bay of Biscay during the period 1996-1997. Crecimiento y reproducción de la merluza (*Merluccius merluccius*) del Golfo de Vizcaya en el período 1996-1997. Sexto Coloquio Internacional sobre Oceanografía del Golfo de Vizcaya. Donostia-San Sebastián. Abril 1998. (*in*

*press* in OZEANOGRAFIKA)

- Lucio, P., Santurtún, M., and Murua, H., 1998b. Growth and reproduction of hake (*Merluccius merluccius*) in the Bay of Biscay during 1996-1997. I.C.E.S. C.M. 1998/CC:20. 24p+12.
- Piñeiro, C. and J. J. Hunt, 1989. Comparative study on growth of european hake (*Merluccius merluccius L.*) from Southern stock using whole and sectioned otoliths, and length frequency distributions. ICES, C.M. 1989/G:37.
- Piñeiro, C. and M. Meixide, 1994. Analysis of results obtained in the Spanish-French meeting about otolith age reading of european hake. Working Paper in ICES, C.M. 1994.
- Piñeiro, C.G. and J.A. Pereiro, 1993. Study on juvenile growth pattern of European hake (*Merluccius merluccius L.*) using whole otoliths and length frequency distributions from commercial catches and fish surveys. ICES C.M./G:12.
- Robles, R, Pereiro, J. A., Iglesias, S. et Pereiro, F. J., 1975. Étude sur la croissance du merlu européen, *Merluccius merluccius L.* du NW de L'Espagne. C.M. 1975/ G : 8 Comité des ICES.
- Zar, J. H. 1996. Biostatistical analysis. Prentice Hall, New Jersey, 3th edition, 662pp.

Table 1.- Assigned ages for readers in the first reading of IEO sample.

ID	Month	Length	Sex	Age R1	Age R2	Age R3	Age R4	Age R5	Age R6	Age R7	Age R8	Age R9	Age R10	Age R11	mode
20250	10	34	1	2	3	3	3	3	3	3	3	2	1	2	3
20253	10	33	1	2	3	3	3	3	3	3	3	3	1	1	3
20260	10	35	1	2	3	3	2	3	3	3	2	2	1	1	3
20264	10	36	2	2	2	3	2	3	4	3	2	2	2	2	2
20267	10	32	2	2	2	3	2	3	2	2	2	2	1	1	2
20272	10	30	2	2	2	3	2	3	2	2	2	2	3	2	2
20275	10	31	2	2	3	3	2	3	3	2	3	2	1	1	3
20279	10	29	2	2	2	2	2	2	2	2	2	2	3	1	2
20289	10	28	2	2	2	2	2	2	3	2	2	2	1	1	2
20301	10	24	3	1	2	2	2	2	2	2	2	1	1	1	2
20302	10	22	3	1	1	1	1	1	1	1	1	1	0	0	1
20305	10	13	3	0	0	0	0	0	0	0	0	0	0	0	0
20310	10	12	3	0	0	0	0	0	0	0	0	0	0	0	0
20314	10	21	3	1	1	1	1	2	1	1	1	1	2	0	1
20317	10	16	3	0	0	0	1	1	0	0	1	0	1	0	0
20318	10	23	3	1	1	2	1	2	2	2	1	1	2	2	0
20322	10	25	3	1	1	2	3	2	2	2	1	1	2	2	0
20324	10	20	3	1	1	1	1	2	1	1	1	0	2	1	1
20328	10	13	3	0	0	0	0	0	0	0	0	0	0	0	0
20332	10	13	3	0	0	0	0	0	0	0	0	0	0	0	0
20333	10	15	3	0	0	0	0	0	0	0	0	0	0	0	0
20336	10	17	3	0	0	0	0	1	0	1	0	0	0	0	0
20343	10	27	1	2	1	2	1	2	2	2	1	1	0	2	2
20347	10	19	3	1	1	0	1	1	1	1	1	1	0	0	1
20356	10	13	3	0	0	0	0	0	0	0	0	0	0	0	0
20358	10	12	3	0	0	0	0	0	0	0	0	0	0	0	0
20359	10	18	3	0	0	0	1	1	1	1	1	0	0	0	0
20361	10	40	1	3	3	4	2	4	3	3	3	3	1	1	3
20362	10	43	1	3	3	4	2	4	3	4	3	3	1	2	3
20366	10	14	3	0	0	0	0	0	0	0	0	0	0	0	0
20372	10	15	3	0	0	0	0	0	0	0	0	0	0	0	0
20377	10	38	1	3	3	4	3	4	3	4	3	2	1	1	3
20378	10	37	1	3	3	3	1	4	4	3	3	3	1	1	3
20382	10	26	2	1	1	2	2	2	2	2	1	1	1	1	1
20385	10	43	2	3	3	5	1	4	4	4	3	4	1	1	3
20390	10	40	1	4	3	5	1	4	3	4	3	4	1	1	4
20393	10	16	2	0	0	0	0	0	1	0	1	0	0	0	0
20401	10	18	2	0	0	0	0	1	1	1	1	0	0	0	0
20402	10	44	2	4	4	5	1	4	4	4	4	4	1	1	4
20403	10	56	2	5	6	7	4	5	7	5	6	3	2	2	5
20404	10	64	2	7	6	8	3	6	9	6	7	6	2	2	6
20405	10	42	1	3	3	4	2	4	4	4	3	4	2	1	3
20417	10	39	2	3	3	4	3	4	4	4	3	5	1	1	3
20418	10	17	3	0	0	0	0	1	0	0	0	1	0	0	0
20422	10	41	2	3	3	4	2	4	4	4	3	5	1	1	3
20423	10	44	2	4	3	5	2	4	4	4	4	4	1	1	4
20424	10	50	2	5	5	6	3	5	5	5	5	4	1	1	5
20425	10	44	1	5	4	5	4	4	4	4	6	5	2	1	4
20427	10	53	2	5	4	6	3	5	5	5	5	5	2	1	5
20436	10	45	1	4	4	5	2	4	4	4	4	4	1	1	4
2	1	19	3	1	1	1	1	1	1	1	1	1	1	1	1
3	1	20	2	1	1	1	1	2	1	1	1	1	1	1	1
32	1	17	3	1	1	1	1	1	1	1	1	1	1	1	1
37	1	24	2	2	2	2	2	2	2	2	1	1	1	1	2
40	1	44	2	4	5	5	3	4	5	5	5	6	2	2	5
42	1	52	2	5	5	7	4	5	6	5	6	7	2	2	5
44	1	46	1	5	4	5	4	5	5	5	6	8	2	2	5
46	1	41	1	5	4	4	3	4	4	4	4	4	2	2	4
178	2	28	1	3	2	2	2	3	2	3	2	4	1	1	1
189	2	68	2	8	7	10	5	7	9	7	8	6	3	4	7
195	2	45	1	4	4	5	3	4	5	5	5	7	2	2	2
196	2	53	2	6	5	6	4	5	6	5	7	4	3	2	5
197	2	57	2	6	6	7	5	5	5	6	6	5	3	2	6
944	6	50	2	5	5	6	4	5	5	5	5	5	3	2	5
951	6	37	2	3	3	4	3	3	3	3	3	4	2	2	3
953	6	40	2	3	4	4	3	4	4	3	3	5	2	2	3
958	6	34	2	3	2	3	1	3	2	3	3	4	1	1	3
964	6	31	1	2	2	3	2	3	3	3	3	3	1	1	3
966	6	30	2	2	2	2	2	3	2	2	2	5	1	1	2
1030	8	25	1	1	1	2	1	2	1	2	2	3	1	1	2
1033	8	23	1	1	1	1	1	2	1	2	2	1	1	1	1
1039	8	24	1	1	1	1	1	2	1	2	2	2	1	1	1
1065	8	47	3	4	4	5	5	4	4	4	5	3	1	1	4
1067	8	48	2	5	5	5	5	5	5	5	5	5	1	1	5
1070	8	54	2	5	5	6	5	5	5	5	6	6	1	1	5
1073	8	43	3	4	3	5	3	4	4	4	4	6	2	1	4
1074	8	49	3	5	4	6	4	4	5	5	5	5	2	1	5
1089	8	33	3	2	3	3	3	3	3	3	4	2	1	1	3
1208	11	61	3	6	6	8	5	6	8	7	7	7	3	2	6
1209	11	64	3	7	6	9	5	6	8	7	8	6	3	2	7
1211	11	69	3	7	6	9	5	7	8	6	7	6	3	2	7
1212	11	62	3	6	7	8	4	6	8	6	7	6	3	2	6
1763	4	27	1	2	1	2	1	3	2	2	2	2	1	1	2
1767	6	15	3	0	0	1	1	1	1	1	1	0	0	0	1
1776	4	18	3	1	1	1	2	1	1	1	1	1	1	1	1
1777	4	21	2	1	1	1	2	2	2	2	2	1	1	1	1
1793	8	19	3	1	1	1	1	1	1	1	1	1	1	1	1
1803	8	22	3	1	1	1	1	2	1	1	2	1	1	1	1
1834	8	16	1	0	0	0	1	1	1	0	0	0	0	0	0
1845	8	17	3	0	0	0	1	1	1	1	0	0	0	0	0
10015	9	15	3	0	0	0	0	1	0	0	0	0	0	0	0
10029	9	16	2	0	0	0	0	1	1	1	0	0	0	0	0
10072	9	35	2	3	3	4	1	3	4	3	3	3	1	2	3
10077	9	39	2	3	3	4	1	4	4	3	3	3	1	1	3
10099	9	32	2	2	2	3	1	3	2	2	2	3	1	1	2
10155	9	29	1	2	2	2	2	3	2	2	2	2	1	1	2
10156	9	38	2	3	3	3	2	4	3	3	3	4	1	1	3
10160	9	36	2	3	3	4	1	4	3	3	3	4	1	1	3
10300	9	42	1	4	4	5	5	4	4	4	5	4	2	2	4
10305	9	18	1	0	0	1	1	1	1	1	1	0	0	0	1

Table 2.- Assigned ages for readers in the first reading of IFREMER sample.

ID	QUARTER	Length	Sex	Age R1	Age R2	Age R3	Age R4	Age R5	Age R6	Age R7	Age R8	Age R9	Age R10	Age R11	mode
F7	4	31	1	2	3	3	1	3	3	3	2	3	1	1	3
F8	4	31	2	2	2	3	1	3	3	3	2	3	1	1	2
F9	4	30	2	2	1	2	1	2	2	2	2	2	1	1	2
F10	4	28	2	2	1	2	1	2	2	2	2	2	1	1	2
F11	4	21	1	1	1	1	1	2	1	1	1	1	0	0	1
F18	4	42	2	3	4	4	1	4	4	3	3	4	1	2	3
F19	4	40	2	3	3	4	1	4	3	3	3	3	1	1	3
F20	4	45	2	4	4	5	2	5	4	4	3	4	1	1	4
F21	4	40	2	3	3	4	1	4	2	3	3	4	1	1	3
F22	4	32	2	2	3	4	1	4	3	3	3	3	1	1	3
F23	4	36	2	3	2	3	1	3	3	3	2	3	1	1	3
F25	4	32	1	2	2	3	1	3	2	3	2	3	1	1	2
F26	4	43	2	4			1		3	4	3		0		4
F28	4	40	2	3	3	4	1	4	3	3	3		1	2	3
F31	4	29	1	2	2	2	1	3	2	3	2		1	1	2
F32	4	28	1	2	2	2	1	2	2	2	2	2	1	1	2
F34	4	21	1	1	1	1	1	1	1	1	1	1	1	1	1
F35	4	20	1	1	1	1	1	1	1	1	1	1	0	1	1
F55	4	61	2	6	7	8	1	6	5	6	6	6	2	2	6
F56	4	47	2	4	4	5	5	5	6	4	5	7	2	2	
F57	4	49	2	5	5	5	5	5	5	6	5	5	2	2	5
F62	4	29	1	2	2	2	2	3	2	2	2	2	1	1	2
F63	4	27	2	2	1	2	2	3	2	2	2	2	0	0	2
F64	4	21	1	1	1	1	1	2	1	2	1	2	0	0	1
F65	4	23	2	1	1	1	1	2	1	2	1	2	0	0	1
F78	4	44	1	4	4	5	3	5	4	5	4	6	1	1	
F84	4	53	2	5	4	6	4	6	5	5	5	9	2	2	5
F144	4	58	2	6	7	9	2	7	7	7	6	2	2	2	7
F180	4	56	2	5	4	6	5	6	5	5	4	5	2	2	
F210	4	68	2	7	6	8		6	4	6	5	6	3	3	6
B1046	4	36	2	3	2	2	4	3	3	2	2	3	1	0	2
B1046	4	39	2	3	3	4	3	5	5	3	3	6	1	1	3
B1046	4	43	2	4	3	6	2	6	6	4	3	6	1	1	
B1046	4	45	2	4	3	5	2	5	5	4	4	3	1	1	4
B1048	4	20	3	1	1	1	2	1	1	1	1	1	0	0	1
B1048	4	21	3	1	1	1	2	1	1	1	1	1	0	0	1
B1048	4	24	3	1	1	1	2	1	1	1	1	1	0	0	1
B1008	4	20	3	1	1	1	1	1	1	1	1	1	0	0	1
B1008	4	21	3	1	1	1	2	1	1	1	1	2	0	0	1
B1008	4	38	1	3	3	4	3	4	4	2	3	7	1	1	3
B1008	4	41	1	4	3	5	4	4	4	3	4	5	1	1	4
B1008	4	49	1	5	4	6	5	5	4	4	4	4	1	2	4
B1008	4	31	2	2	2	3		3	3	2	2	2	1	1	2
B1048	4	25	3	1	2	1	2	1	1	1	1	1	0	1	1
B1048	4	26	3	2	2	2	3	2	2	2	2	1	0	1	2
B1048	4	32	1	2	2	3	2	3	3	2	3		1	1	
B1048	4	39	1	3	3	4	2	3	4	3	3	2	1	2	3
B1048	4	41	1	4	4	5	2	4	4	4	4	3	1	1	4
B1048	4	34	2	2	2	3	2	3	3	2	3	2	1	1	
B1008	4	35	2	3	3	3	3	3	3	3	3	3	2	2	3
B1008	4	36	2	3	2	3	3	3	3	2	3	2	1	1	3
B1008	4	37	2	3	3	4	3	4	4	3	3	3	1	1	3
B1008	4	41	2	3	3	4	3	4	3	3	3	3	1	1	3
B1010	4	40	1	3	3	4	2	3	3	3	3	2	1	1	3
B1048	4	41	2	3	3	4	4	5	3	4	3	2	2	1	3
B1050	4	23	3	1	1	1	2	1	1	2	1	1	0	0	1
B1052	4	22	3	1	1	1	3	1	1	2	1	1	0	0	1
B1052	4	24	3	1	1	1	5	1	1	2	1	1	0	0	1
B1010	4	48	1	5	4	6	3	5	4	4	4	3	2	2	4
B1010	4	51	2	5	4	6	2	6	5	5	5	3	3	2	5
B1062	4	54	2	5	7	7	1	7	6	7	7	7	6	5	7
B1062	4	74	2	8	7	8	5	8	8	8	8	4	4	4	8
B1060	4	70	2	9	5	7	7	7	7	6	7	5	3	3	7
B1094	4	78	2	9	7	9	2	7	8	6	8	6	0	0	
B1096	4	52	2	5	5	6	3	5	5	5	5	3	3	3	5
B1096	4	55	2	5	5	5	2	5	4	5	4	4	3	3	5
B1092	4	52	1	5	4	5	2	5	5	3	5	5	3	2	5
B1130	4	52	2	5	4	6	4	6	6	4	5	2	2	3	5
B1142	4	54	2	5	5	7	7	8	5	6	5	6	2	2	5
B1156	4	54	1	6	5	6	3	6	6	5	6	5	2	1	6
1202	4	32	2	2	2	3	3	3	2	2	2	2	1	1	2
1202	4	33	2	2	2	3	5	3	2	2	2	2	1	1	2
1202	4	36	2	3	2	3	3	3	2	2	2	3	1	1	
1204	4	20	3	1	1	1	2	1	1	1	1	1	0	0	1
1204	4	21	3	1	1	1	3	1	1	1	1	1	0	0	1
1204	4	22	1	1	1	1	2	1	1	1	1	2	0	0	1
1204	4	24	1	1	1	1	2	1	1	1	1	1	0	0	1
1204	4	22	2	1	1	1	2	1	1	1	1	1	0	0	1
1170	4	32	1	2	2	3		2	2	2	2	2	0	0	2
1170	4	25	2	1	1	1		2	1	1	1	1	0	0	1
1170	4	26	2	1	1	2		2	1	1	1	2	0	0	1
1170	4	30	2	2	2	2		3	2	2	2	2	0	0	2
1174	4	29	1	2	2	3		3	2	2	2	2	0	0	2
1174	4	32	1	2	2	3		3	2	2	2	2	0	0	2
1174	4	34	1	3	3	4		4	2	3	2	3	1	1	3
1204	4	23	2	1	1	1	3	2	1	1	1	2	0	0	1
1204	4	24	2	1	1	1	2	2	1	1	1	2	0	0	1
1204	4	36	2	3	2	3	1	4	2	5	2	4	1	1	
1204	4	42	2	3	3	6	2	5	5	1	5	1	1	1	
1174	4	31	2	2	2	3	3	3	3	2	3	2	1	0	
1176	4	38	1	3	2	4	2	4	3	2	3	2	1	1	3
1180	4	41	2	3	3	6	1	4	5	3	5	3	1	1	3
1184	4	42	1	4	3	5	2	4	4	4	4	3	1	1	4
1186	4	40	1	3	3	4	2	5	3	3	3	3	1	1	3
1194	4	40	1	3	3	4	2	4	3	3	3	3	1	1	3
1194	4	44	1	4	3	5	3	4	4	3	4	3	1	1	4
1210	4	56	1	6	4	5	5	5	5	5	5	5	2	3	5
1196	4	50	1	5	5	6	4	6	8	6	8	6	2	3	6
1238	4	51	1	5	3	4	3	4	3	3	3	4	2	2	3
1238	4	42	2	3	3	5	2	4	4	3	2	4	1	1	3
1216	4	42	1	4	3	5	2	4	3	3	3	3	1	1	3
1216	4	43	1	4	3	5	3	4	3	3	3	3	1	1	3
1242	4	40	1	4	3	4	2	4	3	3	3	2	1	1	
1244	4	68	2	8	10	12	2	9	12	10	10	2	2	2	10
1222	4	44	2	4	2	4	1	4	3	3	3		1	1	4
1224	4	44	1	4	4	7	2	5	4	4	3	4	1	1	4
1224	4	45	1	4	5	7	3	5	5	4	5	3	2	2	5
1270	4	102	2	16	15	17	15	14	16	16	16	12	11	16	16

**Table 3.-By modal age are presented the average age recorded, 2\*stdev and number of age readings by reader and of all readers from IEO sample. First reading**

<b>READER 1</b>																
Modal age	0	1	2	3	4	5	6	7	8	9	10	11	12	13	14	15
Age recorded	0,00	0,85	1,85	2,71	4,22	5,00	6,25	7,50	-	-	-	-	-	-	-	-
2*stdev	0,00	0,75	0,75	0,93	0,88	0,89	1,00	1,41	-	-	-	-	-	-	-	-
n	18	13	13	21	9	11	4	2	0	0	0	0	0	0	0	0
<b>READER 2</b>																
Modal age	0	1	2	3	4	5	6	7	8	9	10	11	12	13	14	15
Age recorded	0,00	0,85	1,77	2,95	3,67	4,82	6,25	6,50	-	-	-	-	-	-	-	-
2*stdev	0,00	0,75	0,88	0,77	1,00	1,21	1,00	1,41	-	-	-	-	-	-	-	-
n	18	13	13	21	9	11	4	2	0	0	0	0	0	0	0	0
<b>READER 3</b>																
Modal age	0	1	2	3	4	5	6	7	8	9	10	11	12	13	14	15
Age recorded	0,00	1,00	2,31	3,62	4,89	5,91	7,75	9,50	-	-	-	-	-	-	-	-
2*stdev	0,00	0,82	0,96	1,18	0,67	1,40	1,00	1,41	-	-	-	-	-	-	-	-
n	18	13	13	21	9	11	4	2	0	0	0	0	0	0	0	0
<b>READER 4</b>																
Modal age	0	1	2	3	4	5	6	7	8	9	10	11	12	13	14	15
Age recorded	0,22	1,15	1,69	2,05	2,89	3,91	4,25	5,00	-	-	-	-	-	-	-	-
2*stdev	0,86	0,75	0,96	1,61	3,07	1,40	1,91	0,00	-	-	-	-	-	-	-	-
n	18	13	13	21	9	11	4	2	0	0	0	0	0	0	0	0
<b>READER 5</b>																
Modal age	0	1	2	3	4	5	6	7	8	9	10	11	12	13	14	15
Age recorded	0,44	1,38	2,54	3,57	4,00	4,82	5,75	7,00	-	-	-	-	-	-	-	-
2*stdev	1,02	1,01	1,04	1,01	0,00	0,81	1,00	0,00	-	-	-	-	-	-	-	-
n	18	13	13	21	9	11	4	2	0	0	0	0	0	0	0	0
<b>READER 6</b>																
Modal age	0	1	2	3	4	5	6	7	8	9	10	11	12	13	14	15
Age recorded	0,28	1,08	2,15	3,33	3,89	5,36	7,50	8,50	-	-	-	-	-	-	-	-
2*stdev	0,92	0,55	1,38	1,15	0,67	1,35	3,46	1,41	-	-	-	-	-	-	-	-
n	18	13	13	21	9	11	4	2	0	0	0	0	0	0	0	0
<b>READER 7</b>																
Modal age	0	1	2	3	4	5	6	7	8	9	10	11	12	13	14	15
Age recorded	0,22	1,08	2,08	3,24	4,00	5,00	6,25	6,50	-	-	-	-	-	-	-	-
2*stdev	0,86	0,55	0,55	1,08	0,00	0,00	1,00	1,41	-	-	-	-	-	-	-	-
n	18	13	13	21	9	11	4	2	0	0	0	0	0	0	0	0
<b>READER 8</b>																
Modal age	0	1	2	3	4	5	6	7	8	9	10	11	12	13	14	15
Age recorded	0,17	1,08	1,85	3,00	4,33	5,55	6,75	7,50	-	-	-	-	-	-	-	-
2*stdev	0,77	0,55	0,75	0,63	1,73	1,38	1,00	1,41	-	-	-	-	-	-	-	-
n	18	13	13	21	9	11	4	2	0	0	0	0	0	0	0	0
<b>READER 9</b>																
Modal age	0	1	2	3	4	5	6	7	8	9	10	11	12	13	14	15
Age recorded	0,06	0,77	2,15	3,33	4,22	5,30	6,00	6,00	-	-	-	-	-	-	-	-
2*stdev	0,47	0,88	2,14	2,03	1,67	2,99	1,63	0,00	-	-	-	-	-	-	-	-
n	18	13	13	21	9	10	4	2	0	0	0	0	0	0	0	0
<b>READER 10</b>																
Modal age	0	1	2	3	4	5	6	7	8	9	10	11	12	13	14	15
Age recorded	0,06	0,85	1,31	1,14	1,44	1,91	2,75	3,00	-	-	-	-	-	-	-	-
2*stdev	0,47	1,38	1,71	0,72	1,05	1,40	1,00	0,00	-	-	-	-	-	-	-	-
n	18	13	13	21	9	11	4	2	0	0	0	0	0	0	0	0
<b>READER 11</b>																
Modal age	0	1	2	3	4	5	6	7	8	9	10	11	12	13	14	15
Age recorded	0,00	0,62	1,23	1,24	1,22	1,55	2,00	3,00	-	-	-	-	-	-	-	-
2*stdev	0,00	1,01	0,88	0,87	0,88	1,04	0,00	2,83	-	-	-	-	-	-	-	-
n	18	13	13	21	9	11	4	2	0	0	0	0	0	0	0	0
<b>ALL READERS</b>																
Modal age	0	1	2	3	4	5	6	7	8	9	10	11	12	13	14	15
Age recorded	0,13	0,97	1,90	2,74	3,53	4,46	5,59	6,36	-	-	-	-	-	-	-	-
2*stdev	0,68	0,92	1,37	2,03	2,61	3,09	3,79	4,12	-	-	-	-	-	-	-	-
n	198	143	143	231	99	120	44	22	0	0	0	0	0	0	0	0



**Table 4.- By modal age are presented the average age recorded, 2\*stdev and number of age readings by reader and of all readers from IFREMER sample. First reading.**

<b>READER 1</b>																
Modal age	0	1	2	3	4	5	6	7	8	9	10	11	12	13	14	15
Age recorded	-	1,00	2,06	3,08	4,18	5,00	6,00	6,67	8,00	-	8,00	-	-	-	-	-
2*stdev	-	0,00	0,49	1,14	0,81	0,94	1,63	4,16	0,00	-	-	-	-	-	-	-
n	0	23	17	25	11	10	4	3	1	0	1	0	0	0	0	0

<b>READER 2</b>																
Modal age	0	1	2	3	4	5	6	7	8	9	10	11	12	13	14	15
Age recorded	-	1,00	1,82	2,92	3,09	4,50	5,75	6,33	7,00	-	10,00	-	-	-	-	-
2*stdev	-	0,60	0,79	0,80	2,44	1,05	1,91	2,31	0,00	-	0,00	-	-	-	-	-
n	0	23	17	25	11	10	4	3	1	0	1	0	0	0	0	0

<b>READER 3</b>																
Modal age	0	1	2	3	4	5	6	7	8	9	10	11	12	13	14	15
Age recorded	-	1,04	2,47	4,04	4,82	5,80	7,50	7,67	8,00	-	12,00	-	-	-	-	-
2*stdev	-	0,42	1,03	1,35	3,56	1,58	2,00	2,31	0,00	-	0,00	-	-	-	-	-
n	0	23	17	25	11	10	4	3	1	0	1	0	0	0	0	0

<b>READER 4</b>																
Modal age	0	1	2	3	4	5	6	7	8	9	10	11	12	13	14	15
Age recorded	-	1,87	1,47	2,00	1,91	3,70	2,00	3,33	5,00	-	2,00	-	-	-	-	-
2*stdev	-	2,12	3,01	2,00	1,89	3,27	3,65	6,43	0,00	-	0,00	-	-	-	-	-
n	0	23	17	25	11	10	4	3	1	0	1	0	0	0	0	0

<b>READER 5</b>																
Modal age	0	1	2	3	4	5	6	7	8	9	10	11	12	13	14	15
Age recorded	-	1,26	2,71	3,88	4,09	5,60	6,00	7,00	8,00	-	9,00	-	-	-	-	-
2*stdev	-	0,90	0,94	1,20	2,89	1,93	0,00	0,00	0,00	-	0,00	-	-	-	-	-
n	0	23	17	25	11	10	4	3	1	0	1	0	0	0	0	0

<b>READER 6</b>																
Modal age	0	1	2	3	4	5	6	7	8	9	10	11	12	13	14	15
Age recorded	-	1,00	2,18	3,28	4,00	5,00	5,75	6,67	8,00	-	12,00	-	-	-	-	-
2*stdev	-	0,00	0,79	1,47	1,26	0,94	3,42	1,15	0,00	-	0,00	-	-	-	-	-
n	0	23	17	25	11	10	4	3	1	0	1	0	0	0	0	0

<b>READER 7</b>																
Modal age	0	1	2	3	4	5	6	7	8	9	10	11	12	13	14	15
Age recorded	-	1,22	2,18	2,92	3,73	4,80	5,75	6,67	8,00	-	10,00	-	-	-	-	-
2*stdev	-	0,84	0,79	0,80	0,93	1,84	1,00	1,15	0,00	-	0,00	-	-	-	-	-
n	0	23	17	25	11	10	4	3	1	0	1	0	0	0	0	0

<b>READER 8</b>																
Modal age	0	1	2	3	4	5	6	7	8	9	10	11	12	13	14	15
Age recorded	-	1,00	2,00	2,92	3,64	4,90	6,25	6,67	8,00	-	10,00	-	-	-	-	-
2*stdev	-	0,00	0,00	1,14	1,01	0,63	2,52	1,15	-	-	-	-	-	-	-	-
n	0	23	17	25	11	10	4	3	1	0	1	0	0	0	0	0

<b>READER 9</b>																
Modal age	0	1	2	3	4	5	6	7	8	9	10	11	12	13	14	15
Age recorded	-	1,22	1,88	2,88	2,64	3,70	5,75	1,67	4,00	-	-	-	-	-	-	-
2*stdev	-	1,04	1,71	3,18	3,61	5,25	1,00	5,77	-	-	-	-	-	-	-	-
n	0	23	17	25	11	10	4	3	1	0	1	0	0	0	0	0

<b>READER 10</b>																
Modal age	0	1	2	3	4	5	6	7	8	9	10	11	12	13	14	15
Age recorded	-	0,04	0,65	1,12	1,00	2,40	2,25	3,67	4,00	-	2,00	-	-	-	-	-
2*stdev	-	0,42	0,99	0,66	0,89	1,03	1,00	4,16	-	-	-	-	-	-	-	-
n	0	23	17	25	11	10	4	3	1	0	1	0	0	0	0	0

<b>READER 11</b>																
Modal age	0	1	2	3	4	5	6	7	8	9	10	11	12	13	14	15
Age recorded	-	0,13	0,65	1,20	1,09	2,40	2,25	3,33	4,00	-	2,00	-	-	-	-	-
2*stdev	-	0,69	0,99	0,82	1,08	1,03	1,91	3,06	-	-	-	-	-	-	-	-
n	0	23	17	25	11	10	4	3	1	0	1	0	0	0	0	0

<b>ALL READERS</b>																
Modal age	0	1	2	3	4	5	6	7	8	9	10	11	12	13	14	15
Age recorded	-	0,98	1,82	2,75	3,11	4,35	5,02	5,42	6,55	-	7,00	-	-	-	-	-
2*stdev	-	1,29	1,78	2,34	3,20	3,06	4,10	4,85	3,73	-	9,08	-	-	-	-	-
n	0	253	187	275	121	110	44	33	11	0	11	0	0	0	0	0

Table 5.- Indices of Beamish and Fournier (APE) and Coefficient of Variation (V). First reading of IEO and IFREMER samples.

### FIRST READING

	APE	V	D	n
<b>IEO SAMPLE</b> All Readers 1 <sup>st</sup> reading (%)*	37,53	53.03	16.00	100
<b>IEO SAMPLE</b> Readers 1&8 1 <sup>st</sup> reading (%)**	13.47	19.04	11.31	100
<b>IFREMER SAMPLE</b> All Readers 1 <sup>st</sup> reading (%)*	32.68	44.56	13.68	107
<b>IFREMER SAMPLE</b> Readers 1&8 1 <sup>st</sup> reading (%)**	5.20	7.36	5.20	107

\* included the readings from all readers, with and without experience

\*\* only the expert readers who are involved in the ICES WGSSDS

Table 6.- Assigned ages for readers in the second reading of IEO sample.

ID	Month	Sex	Age R1	Age R2	Age R3	Age R4	Age R5	Age R7	Age R8	Age R9	Age R10	Age R11	MODE
20250	10	1	2	3	3	3	3	2	2	3	3	6	2
20253	10	1	3	3	3	5	3	2	2	4	3	6	3
20264	10	2	3	4	4	6	3	2	2	4	5	8	
20267	10	2	2	2	2	3	2	2	2	2	4	4	2
20275	10	2	3	3	3	3	3	2	2	3	3	4	3
20279	10	2	2	2	2	2	2	1	2	2	3	4	2
20289	10	2	2	2	2	2	2	1	2	2	2	3	2
20301	10	3	2	2	2	2	2	1	1	2	2	2	2
20302	10	3	1	1	1	1	1	1	1	1	2	1	1
20305	10	3	0	0	0	0	0	0	0	0	0	0	0
20310	10	3	0	0	0	0	0	0	0	0	0	0	0
20314	10	3	1	1	1	1	1	1	1	1	1	1	1
20317	10	3	0	0	0	1	0	0	0	0	0	0	0
20318	10	3	1	1	1	1	2	1	1	1	1	1	1
20322	10	3	1	1	1	2	2	1	1	1	1	1	1
20324	10	3	1	1	1	1	1	1	1	1	1	2	1
20358	10	3	0	0	0	0	0	0	0	0	0	0	0
20359	10	3	0	0	0	1	0	1	0	0	1	0	0
20361	10	1	3	3	3	3	3	3	2	3	3	6	3
20362	10	1	3	3	3	5	3	3	3	4	4	4	3
20366	10	3	0	0	0	0	0	0	0	0	0	0	0
20372	10	3	0	0	0	0	0	0	0	0	0	0	0
20377	10	1	3	4	3	4	3	3	3	3	3	7	3
20378	10	1	3	3	3	3	3	2	2	4	4	6	3
20382	10	2	1	1	1	1	1	1	1	1	1	2	1
20385	10	2	4	4	4	3	4	3	3	6	2	9	4
20390	10	1	4	4	4	3	3	3	3	4	4	7	
20402	10	2	4	4	5	3	3	3	2	6	1	8	
20403	10	2	6	5	6	11	4	5	5	9	4	10	5
20404	10	2	7	6	6	4	5	6	6	7	5	8	6
44	1	1	6	6	5	7	5	7	6	8	7	10	6
46	1	1	5	4	4	3	4	3	4	6	3	10	4
178	2	1	2	2	2	2	3	2	2	3	3	4	2
196	2	2	6	5	5	8	4	5	6	7	7	8	5
197	2	2	6	6	6	8	5	5	6	5	6	5	6
944	6	2	5	5	5	5	5	4	5	7	5	7	5
951	6	2	3	3	3	3	3	3	2	4	3	5	3
953	6	2	4	3	3	3	3	3	2	3	3	6	3
1089	8	3	2	3	3	4	2	2	4	5	3	4	2
1208	11	3	6	7	6	5	5	6	6	7	6	10	6
1209	11	3	7	7	7	8	5	6	6	8	5	7	7
1211	11	3	6	7	6	7	5	5	5	7	5	7	5
1212	11	3	6	6	6	6	6	6	5	7	6	12	6
1763	4	1	2	2	2	2	2	2	2	2	2	4	2
1767	6	3	0	1	1	1	0	0	0	0	1	0	0
1776	4	3	1	1	1	1	1	1	1	1	2	1	1
1777	4	2	1	2	1	1	1	1	1	1	2	1	1
1793	8	3	1	1	1	1	1	0	0	1	1	1	1
1803	8	3	1	1	1	1	1	1	1	1	1	2	1
10155	9	1	2	2	2	2	2	1	1	2	3	3	2
10156	9	2	3	3	3	7	3	2	2	5	3	5	3
10160	9	2	3	3	4	2	3	2	2	4	3	5	3
10300	9	1	4	5	4	9	4	3	5	5	8	7	4
10305	9	1	1	1	1	1	1	1	0	1	1	0	1

Table 7.- Assigned ages for readers in the second reading of IFREMER sample.

ID	Month	Sex	Age R1	Age R2	Age R3	Age R4	Age R5	Age R7	Age R8	Age R9	Age R10	Age R11	MODE
F7	11	1	2	3	3	2	3	2	2	2	1	8	2
F8	11	2	2	3	2	3	3	2	2	2	2	5	2
F9	11	2	2	2	2	3	2	1	2	1	1	5	2
F10	11	2	2	3	2	2	2	1	2	2	2	5	2
F11	11	1	1	1	1	1	1	1	1	2	1	3	1
F18	11	2	3	4	3	4	4	2	3	3	4	6	3
F19	11	2	3	3	3	3	3	3	2	3	4	6	3
F20	11	2	4	4	4	4	4	4	3	4	4	5	4
F21	11	2	3	3	3	2	4	3	2	4	3	5	3
F22	11	2	2	3	3	3	3	3	2	2	3	4	3
F23	11	2	3	3	3	3	3	2	2	4	3	6	3
F25	11	1	3	3	3	3	3	2	2	3	3	7	3
F56	11	2	4	5	4	5	4	3	5	4	5	8	4
F57	11	2	5	5	5	6	4	5	5	6	5	12	5
F62	11	1	2	2	2	2	2	2	2	2	2	2	2
F63	11	2	2	2	2	1	1	1	1	1	1	3	
F64	11	1	1	1	1	1	1	1	1	1	1	1	1
F65	11	2	1	1	1	1	1	1	1	1	1	2	1
F78	11	1	4	4	4	5	4	4	4	4	7	9	4
F84	11	2	4	4	4	6	4	4	4	5	6	12	4
F180	11	2	6	6	4	10	4	5	5	4	4	11	
F210	11	2	6	6	6	7	5	5	4	5	6	8	6
1202	11	2	2	2	2	2	2	1	1	2	2	4	2
1202	11	2	2	2	3	2	2	2	2	2	2	3	2
1202	11	2	3	2	3	3	2	2	2	2	2	6	2
1204	11	3	1	1	1	1	1	1	1	1	1	1	1
1204	11	3	1	1	1	1	1	1	1	1	1	1	1
1204	11	1	1	1	1	1	1	1	1	1	1	1	1
1204	11	1	1	1	1	1	1	1	1	1	1	2	1
1204	11	2	1	1	1	1	1	1	1	1	1	2	1
1204	11	2	1	1	1	1	1	1	1	1	1	1	1
1204	11	2	1	1	1	2	1	1	1	1	2	1	1
1204	11	2	3	3	3	2	2	2	2	2	2	3	
1204	11	2	3	4	5	3	2	3	3	3	3	5	3
1174	11	2	2	2	3	2	2	2	1	1	2	4	2
1176	11	1	3	3	3	4	2	2	2	2	2	4	
1180	11	2	3	4	4	3	3	3	2	2	2	9	3
1194	11	1	3	3	3	3	3	3	2	4	2	5	3
1194	11	1	4	4	4	3	3	3	3	4	2	4	
1216	11	1	4	3	3	5	3	3	2	4	3	7	3
1216	11	1	4	3	4	3	3	2	2	4	3	7	

**Table 8.- By modal age are presented the average age recorded, 2\*stdev and number of age readings by reader and of all readers from IEO sample. Second reading.**

READER 1																
Modal age	0	1	2	3	4	5	6	7	8	9	10	11	12	13	14	15
Age recorded	0,00	1,00	2,00	3,10	4,33	5,75	6,20	7,00	-	-	-	-	-	-	-	-
2*stdev	0,00	0,00	0,00	0,63	1,15	1,00	0,89	0,00	-	-	-	-	-	-	-	-
n	8	11	9	10	3	4	5	1	0	0	0	0	0	0	0	0

READER 2																
Modal age	0	1	2	3	4	5	6	7	8	9	10	11	12	13	14	15
Age recorded	0,13	1,09	2,22	3,10	4,33	5,50	6,20	7,00	-	-	-	-	-	-	-	-
2*stdev	0,71	0,60	0,88	0,63	1,15	2,00	0,89	0,00	-	-	-	-	-	-	-	-
n	8	11	9	10	3	4	5	1	0	0	0	0	0	0	0	0

READER 3																
Modal age	0	1	2	3	4	5	6	7	8	9	10	11	12	13	14	15
Age recorded	0,13	1,00	2,22	3,10	4,00	5,50	5,80	7,00	-	-	-	-	-	-	-	-
2*stdev	0,71	0,00	0,88	0,63	0,00	1,15	0,89	0,00	-	-	-	-	-	-	-	-
n	8	11	9	10	3	4	5	1	0	0	0	0	0	0	0	0

READER 4																
Modal age	0	1	2	3	4	5	6	7	8	9	10	11	12	13	14	15
Age recorded	0,38	1,09	2,44	3,80	5,00	7,75	6,00	8,00	-	-	-	-	-	-	-	-
2*stdev	1,04	0,60	1,45	2,95	6,93	5,00	3,16	0,00	-	-	-	-	-	-	-	-
n	8	11	9	10	3	4	5	1	0	0	0	0	0	0	0	0

READER 5																
Modal age	0	1	2	3	4	5	6	7	8	9	10	11	12	13	14	15
Age recorded	0,00	1,18	2,22	3,00	4,00	4,50	5,20	5,00	-	-	-	-	-	-	-	-
2*stdev	0,00	0,81	0,88	0,00	0,00	1,15	0,89	0,00	-	-	-	-	-	-	-	-
n	8	11	9	10	3	4	5	1	0	0	0	0	0	0	0	0

READER 7																
Modal age	0	1	2	3	4	5	6	7	8	9	10	11	12	13	14	15
Age recorded	0,13	0,91	1,56	2,50	3,00	4,75	6,00	6,00	-	-	-	-	-	-	-	-
2*stdev	0,71	0,60	1,05	1,05	0,00	1,00	1,41	0,00	-	-	-	-	-	-	-	-
n	8	11	9	10	3	4	5	1	0	0	0	0	0	0	0	0

READER 8																
Modal age	0	1	2	3	4	5	6	7	8	9	10	11	12	13	14	15
Age recorded	0,00	0,82	2,00	2,20	4,00	5,25	5,80	6,00	-	-	-	-	-	-	-	-
2*stdev	0,00	0,81	1,73	0,84	2,00	1,00	0,89	0,00	-	-	-	-	-	-	-	-
n	8	11	9	10	3	4	5	1	0	0	0	0	0	0	0	0

READER9																
Modal age	0	1	2	3	4	5	6	7	8	9	10	11	12	13	14	15
Age recorded	0,00	1,00	2,56	3,70	5,67	7,50	6,80	8,00	-	-	-	-	-	-	-	-
2*stdev	0,00	0,00	2,03	1,35	1,15	2,00	2,19	0,00	-	-	-	-	-	-	-	-
n	8	11	9	10	3	4	5	1	0	0	0	0	0	0	0	0

READER10																
Modal age	0	1	2	3	4	5	6	7	8	9	10	11	12	13	14	15
Age recorded	0,25	1,27	2,78	3,20	4,33	5,25	6,00	5,00	-	-	-	-	-	-	-	-
2*stdev	0,93	0,93	1,33	0,84	6,43	2,52	1,41	0,00	-	-	-	-	-	-	-	-
n	8	11	9	10	3	4	5	1	0	0	0	0	0	0	0	0

READER 11																
Modal age	0	1	2	3	4	5	6	7	8	9	10	11	12	13	14	15
Age recorded	0,00	1,18	3,78	5,40	8,67	8,00	9,00	7,00	-	-	-	-	-	-	-	-
2*stdev	0,00	1,21	2,19	1,93	3,06	2,83	5,29	0,00	-	-	-	-	-	-	-	-
n	8	11	9	10	3	4	5	1	0	0	0	0	0	0	0	0

ALL READERS																
Modal age	0	1	2	3	4	5	6	7	8	9	10	11	12	13	14	15
Age recorded	0,10	1,05	2,35	3,28	4,58	5,83	6,18	6,00	-	-	-	-	-	-	-	-
2*stdev	0,60	0,73	1,80	2,19	4,31	3,66	3,32	4,47	-	-	-	-	-	-	-	-
n	81	111	91	101	31	41	51	11	0	0	0	0	0	0	0	0

**Table 9.- By modal age are presented the average age recorded, 2\*stdev and number of age readings by reader and of all readers from IFREMER sample. Second reading.**

<b>READER 1</b>																
Modal age	0	1	2	3	4	5	6	7	8	9	10	11	12	13	14	15
Age recorded	-	1,00	2,11	3,00	4,00	5,00	6,00	-	-	-	-	-	-	-	-	-
2*stdev	-	0,00	0,67	0,94	0,00	0	0,00	-	-	-	-	-	-	-	-	-
n	0	10	9	10	4	1	1	0	0	0	0	0	0	0	0	0

<b>READER 2</b>																
Modal age	0	1	2	3	4	5	6	7	8	9	10	11	12	13	14	15
Age recorded	-	1,00	2,33	3,30	4,25	5,00	6,00	-	-	-	-	-	-	-	-	-
2*stdev	-	0,00	1,00	0,97	1,00	0,00	0,00	-	-	-	-	-	-	-	-	-
n	0	10	9	10	4	1	1	0	0	0	0	0	0	0	0	0

<b>READER 3</b>																
Modal age	0	1	2	3	4	5	6	7	8	9	10	11	12	13	14	15
Age recorded	-	1,00	2,44	3,30	4,00	5,00	6,00	-	-	-	-	-	-	-	-	-
2*stdev	-	0,00	1,05	1,35	0,00	0,00	0,00	-	-	-	-	-	-	-	-	-
n	0	10	9	10	4	1	1	0	0	0	0	0	0	0	0	0

<b>READER 4</b>																
Modal age	0	1	2	3	4	5	6	7	8	9	10	11	12	13	14	15
Age recorded	-	1,10	2,33	3,20	5,00	6,00	7,00	-	-	-	-	-	-	-	-	-
2*stdev	-	0,63	1,00	1,58	1,63	0,00	0,00	-	-	-	-	-	-	-	-	-
n	0	10	9	10	4	1	1	0	0	0	0	0	0	0	0	0

<b>READER 5</b>																
Modal age	0	1	2	3	4	5	6	7	8	9	10	11	12	13	14	15
Age recorded	-	1,00	2,22	3,10	4,00	4,00	5,00	-	-	-	-	-	-	-	-	-
2*stdev	-	0,00	0,88	1,14	0,00	0,00	0,00	-	-	-	-	-	-	-	-	-
n	0	10	9	10	4	1	1	0	0	0	0	0	0	0	0	0

<b>READER 7</b>																
Modal age	0	1	2	3	4	5	6	7	8	9	10	11	12	13	14	15
Age recorded	-	1,00	1,67	2,70	3,75	5,00	5,00	-	-	-	-	-	-	-	-	-
2*stdev	-	0,00	1,00	0,97	1,00	0,00	0,00	-	-	-	-	-	-	-	-	-
n	0	10	9	10	4	1	1	0	0	0	0	0	0	0	0	0

<b>READER 8</b>																
Modal age	0	1	2	3	4	5	6	7	8	9	10	11	12	13	14	15
Age recorded	-	1,00	1,78	2,20	4,00	5,00	4,00	-	-	-	-	-	-	-	-	-
2*stdev	-	0,00	0,88	0,84	1,63	0,00	0,00	-	-	-	-	-	-	-	-	-
n	0	10	9	10	4	1	1	0	0	0	0	0	0	0	0	0

<b>READER 9</b>																
Modal age	0	1	2	3	4	5	6	7	8	9	10	11	12	13	14	15
Age recorded	-	1,10	1,78	3,00	4,25	6,00	5,00	-	-	-	-	-	-	-	-	-
2*stdev	-	0,63	0,88	2,49	1,00	0,00	0,00	-	-	-	-	-	-	-	-	-
n	0	10	9	10	4	1	1	0	0	0	0	0	0	0	0	0

<b>READER 10</b>																
Modal age	0	1	2	3	4	5	6	7	8	9	10	11	12	13	14	15
Age recorded	-	1,10	1,78	3,00	5,50	5,00	6,00	-	-	-	-	-	-	-	-	-
2*stdev	-	0,63	0,88	1,33	2,58	0,00	0,00	-	-	-	-	-	-	-	-	-
n	0	10	9	10	4	1	1	0	0	0	0	0	0	0	0	0

<b>READER 11</b>																
Modal age	0	1	2	3	4	5	6	7	8	9	10	11	12	13	14	15
Age recorded	-	1,50	4,67	6,00	8,50	12,00	8,00	-	-	-	-	-	-	-	-	-
2*stdev	-	1,41	3,46	2,83	5,77	0,00	0,00	-	-	-	-	-	-	-	-	-
n	0	10	9	10	4	1	1	0	0	0	0	0	0	0	0	0

<b>ALL READERS</b>																
Modal age	0	1	2	3	4	5	6	7	8	9	10	11	12	13	14	15
Age recorded	-	1,08	2,31	3,28	4,73	5,80	5,80	-	-	-	-	-	-	-	-	-
2*stdev	-	0,61	2,13	2,45	3,36	4,50	2,27	-	-	-	-	-	-	-	-	-
n	0	100	90	100	40	10	10	0	0	0	0	0	0	0	0	0

Table 10.- Indices of Beamish and Fournier (APE) and Coefficient of Variation (V) from the second reading of IEO and IFREMER samples.

**SECOND READING**

	APE	V	D	n
<b>IEO SAMPLE</b> All Readers (%)*	29.00	41.77	13.21	54
<b>IEO SAMPLE</b> Readers 1&8 (%)**	13.48	12.77	9.03	54
<b>IEO SAMPLE</b> All Readers 4 quarter (%)***	29.68	44.13	13.95	54
<b>IEO SAMPLE</b> All Readers without 4,9,10,11(%)****	19.48	25.84	10.55	54
<b>IEO SAMPLE</b> All Readers without 10,11(%)*****	23.47	32.16	11.37	54
<b>IFREMER SAMPLE</b> All Readers (%)*	20.76	30.74	9.73	41
<b>IFREMER SAMPLE</b> Readers 1&8 (%)**	10.13	14.33	10.13	41
<b>IFREMER SAMPLE</b> All Readers without 4,9,10,11 (%)****	11.18	14.76	6.03	41
<b>IFREMER SAMPLE</b> All Readers without 10,11 (%)*****	13.10	17.73	6.28	41

\* included the readings from all readers, with and without experience

\*\* only the expert readers who are involved in the ICES WGSSDS

\*\*\* included the readings from all readers, 4 quarter only

\*\*\*\* included the reading from the readers with closer ages from the cluster analysis (1,2,3,5,7 & 8)

\*\*\*\*\* included the reading from the readers with closer ages from the cluster analysis (1,2,3,4,5,7,8 & 9)

Table 11.- Assigned ages for readers in the third reading of IEO sample.

ID	Month	Length	Sex	Age R1	Age R2	Age R3	Age R4	Age R5	Age R7	Age R8	Age R9	Age R10	Age R11	mode
20250	10	34	1	2	3	3	2	3	2	3	3	5	2	3
20253	10	33	1	2	3	3	2	2	2	3	3	5	3	
20260	10	35	1	3	3	3	2	2	2	2	2	5	3	
20264	10	36	2	2	4	2	2	3	3	3	2	6	2	3
20267	10	32	2	2	2	2	2	2	2	2	2	5	2	2
20289	10	28	2	2	2	2	1	2	1	1	1	3	2	2
20322	10	25	3	1	1	1	2	1	1	1	2	2	1	1
20336	10	17	3	0	0	0	0	0	0	0	0	1	0	0
20378	10	37	1	3	3	3	3	3	2	3	3	4	4	3
20385	10	43	2	3	4	4	3	3	3	3	5	3	5	3
20390	10	40	1	4	3	4	2	3	3	3	4	4	3	3
20393	10	16	2	0	0	0	0	0	0	0	0	1	0	0
20401	10	18	2	0	0	0	0	0	0	0	0	1	0	0
20404	10	64	2	7	7	6	4	4	6	6	5	5	5	6
20405	10	42	1	3	4	4	2	3	3	3	2	4	4	3
20417	10	39	2	3	3	3	3	3	3	3	3	5	4	3
20422	10	41	2	4	3	3	2	4	3	3	3	4	5	3
20423	10	44	2	4	4	3	2	3	3	3	3	4	5	3
20424	10	50	2	5	6	5	7	4	4	4	6	7	4	4
20427	10	53	2	5	5	5	3	4	4	4	4	6	5	
2	1	19	3	0	1	1	1	1	1	1	1	1	1	1
3	1	20	2	1	1	1	1	1	1	1	1	1	1	1
195	2	45	1	4	6	5	5	4	4	6	6	6	5	4
964	6	31	1	2	2	3	2	3	2	2	2	4	2	2
966	6	30	2	2	2	2	2	2	2	1	2	3	2	2
1033	8	23	1	1	1	1	1	1	1	1	1	2	1	1
1039	8	24	1	1	1	1	1	1	1	1	1	2	1	1
1763	4	27	1	2	2	2	2	3	2	2	2	4	2	2
1803	8	22	3	1	1	1	1	1	1	1	1	2	1	1
10155	9	29	1	2	3	2	1	2	2	1	2	1	2	2
10156	9	38	2	2	4	3	2	3	3	2	4	3	4	3



Table 12.- Assigned ages for readers in the third reading of IFREMER sample.

ID	Quarter	Length	Sex	Age R1	Age R2	Age R3	Age R4	Age R5	Age R7	Age R8	Age R9	Age R10	Age R11	mode
F7	4	31	1	2	3	3	2	3	2	3	3	2	3	3
F9	4	30	2	2	2	2	2	2	1	2	2	2	2	2
F18	4	42	2	3	4	4	3	4	3	3	5	5	5	3
F19	4	40	2	3	3	3	3	3	3	3	3	2	2	3
F21	4	40	2	3	3	3	3	3	2	3	3	3	3	3
F23	4	36	2	3	3	3	3	3	2	3	5	6	3	3
F25	4	32	1	2	3	3	3	3	2	3	3	5	3	3
F32	4	28	1	2	1	1	2	2	1	2	2	3	2	2
F34	4	21	1	1	1	1	1	1	1	2	1	1	1	1
F35	4	20	1	1	1	1	1	1	1	1	1	1	1	1
F57	4	49	2	5	5	5	4	3	6	5	6	5	5	5
F62	4	29	1	2	2	2	1	2	2	2	2	2	2	2
F64	4	21	1	1	1	1	1	1	1	1	1	1	1	1
F180	4	56	2	6	4	4	9	4	4	4	7	5	6	4
F210	4	68	2	7	6	6	4	5	6	6	5	4	6	6
B1048	4	25	3	2	1	1	1	1	1	1	1	1	1	1
B1048	4	26	3	2	2	2	1	2	2	2	2	2	2	2
B1048	4	32	1	2	2	3	2	2	2	3	4	2	3	2
B1048	4	39	1	3	3	3	2	3	3	3	2	2	3	3
B1048	4	41	1	4	4	4	3	4	4	4	4	3	4	4
B1048	4	34	2	2	2	2	2	2	2	2	4	2	2	2
B1008	4	36	2	3	2	2	2	2	2	2	3	3	3	2
B1048	4	41	2	3	3	3	3	3	3	3	5	3	3	3
B1050	4	23	3	1	1	1	1	1	1	1	1	1	1	1
B1052	4	22	3	1	1	1	1	1	1	0	1	1	0	1
B1052	4	24	3	1	1	1	1	1	1	0	1	1	0	1
B1010	4	51	2	6	4	4	3	4	5	4	4	4	4	4
B1062	4	54	2	5	7	6	7	6	6	6	8	7	6	6
1204	4	42	2	3	4	4	3	3	4	4	3	3	4	4
1176	4	38	1	2	2	3	2	2	2	2	2	2	2	2
1216	4	43	1	4	3	3	3	3	4	3	4	3	3	3
1224	4	44	1	4	4	4	3	4	4	4	6	3	6	4
1224	4	45	1	4	5	5	3	4	5	5	5	4	4	5

Table13.- Indices of Beamish and Fournier (APE) and Coefficient of Variation (V) from the second reading of IEO and IFREMER samples. Third reading.

### THIRD READING

	APE	V	D	n
<b>IEO SAMPLE</b> All Readers (%)*	35.18	55.29	17.48	31
<b>IEO SAMPLE</b> Readers 1&8 (%)**	13.31	7.93	5.61	31
<b>IEO SAMPLE</b> All Readers without 4,9,10,11(%)***	12.49	15.27	6.23	31
<b>IFREMER SAMPLE</b> All Readers (%)*	15.06	20.91	6.61	33
<b>IFREMER SAMPLE</b> Readers 1&8 (%)**	13.43	18.99	13.43	33
<b>IFREMER SAMPLE</b> All Readers without 4,9,10 & 11 (%)****	10.94	14.28	5.83	33

\* included the readings from all readers, with and without experience

\*\* only the expert readers who are involved in the ICES WGSSDS

\*\*\* included the readings from all readers, 4 quarter only

\*\*\*\* included the reading from the readers with closer ages from the cluster analysis  
(1,2,3,5,7 & 8)

\*\*\*\*\* included the reading from the readers with closer ages from the cluster analysis  
(1,2,3,4,5,7,8 & 9)

**Table 14.- By modal age are presented the average age recorded, 2\*stdev and number of age readings by reader and of all readers from IEO sample. Third reading.**

READER 1																
Modal age	0	1	2	3	4	5	6	7	8	9	10	11	12	13	14	15
Age recorded	0,00	0,83	2,00	3,00	4,50	-	7,00	-	-	-	-	-	-	-	-	-
2*stdev	0,00	0,82	0,00	1,63	1,41	-	0,00	-	-	-	-	-	-	-	-	-
n	3	6	6	10	2	0	1	0	0	0	0	0	0	0	0	0

READER 2																
Modal age	0	1	2	3	4	5	6	7	8	9	10	11	12	13	14	15
Age recorded	0,00	1,00	2,17	3,50	6,00	-	7,00	-	-	-	-	-	-	-	-	-
2*stdev	0,00	0,00	0,82	1,05	0,00	-	0,00	-	-	-	-	-	-	-	-	-
n	3	6	6	10	2	0	1	0	0	0	0	0	0	0	0	0

READER 3																
Modal age	0	1	2	3	4	5	6	7	8	9	10	11	12	13	14	15
Age recorded	0,00	1,00	2,17	3,20	5,00	-	6,00	-	-	-	-	-	-	-	-	-
2*stdev	0,00	0,00	0,82	1,26	0,00	-	0,00	-	-	-	-	-	-	-	-	-
n	3	6	6	10	2	0	1	0	0	0	0	0	0	0	0	0

READER 4																
Modal age	0	1	2	3	4	5	6	7	8	9	10	11	12	13	14	15
Age recorded	0,00	1,17	1,67	2,30	6,00	-	4,00	-	-	-	-	-	-	-	-	-
2*stdev	0,00	0,82	1,03	0,97	2,83	-	0,00	-	-	-	-	-	-	-	-	-
n	3	6	6	10	2	0	1	0	0	0	0	0	0	0	0	0

READER 5																
Modal age	0	1	2	3	4	5	6	7	8	9	10	11	12	13	14	15
Age recorded	0,00	1,00	2,33	3,10	4,00	-	4,00	-	-	-	-	-	-	-	-	-
2*stdev	0,00	0,00	1,03	0,63	0,00	-	0,00	-	-	-	-	-	-	-	-	-
n	3	6	6	10	2	0	1	0	0	0	0	0	0	0	0	0

READER 7																
Modal age	0	1	2	3	4	5	6	7	8	9	10	11	12	13	14	15
Age recorded	0,00	1,00	1,83	2,80	4,00	-	6,00	-	-	-	-	-	-	-	-	-
2*stdev	0,00	0,00	0,82	0,84	0,00	-	0,00	-	-	-	-	-	-	-	-	-
n	3	6	6	10	2	0	1	0	0	0	0	0	0	0	0	0

READER 8																
Modal age	0	1	2	3	4	5	6	7	8	9	10	11	12	13	14	15
Age recorded	0,00	1,00	1,50	2,90	5,00	-	6,00	-	-	-	-	-	-	-	-	-
2*stdev	0,00	0,00	1,10	0,63	2,83	-	0,00	-	-	-	-	-	-	-	-	-
n	3	6	6	10	2	0	1	0	0	0	0	0	0	0	0	0

READER9																
Modal age	0	1	2	3	4	5	6	7	8	9	10	11	12	13	14	15
Age recorded	0,00	1,17	1,83	3,20	6,00	-	5,00	-	-	-	-	-	-	-	-	-
2*stdev	0,00	0,82	0,82	1,84	0,00	-	0,00	-	-	-	-	-	-	-	-	-
n	3	6	6	10	2	0	1	0	0	0	0	0	0	0	0	0

READER10																
Modal age	0	1	2	3	4	5	6	7	8	9	10	11	12	13	14	15
Age recorded	1,00	1,67	3,33	4,20	6,50	-	5,00	-	-	-	-	-	-	-	-	-
2*stdev	0,00	1,03	2,73	1,84	1,41	-	0,00	-	-	-	-	-	-	-	-	-
n	3	6	6	10	2	0	1	0	0	0	0	0	0	0	0	0

READER11																
Modal age	0	1	2	3	4	5	6	7	8	9	10	11	12	13	14	15
Age recorded	0,00	1,00	2,00	3,80	4,50	-	5,00	-	-	-	-	-	-	-	-	-
2*stdev	0,00	0,00	0,00	2,27	1,41	-	0,00	-	-	-	-	-	-	-	-	-
n	3	6	6	10	2	0	1	0	0	0	0	0	0	0	0	0

ALL READERS																
Modal age	0	1	2	3	4	5	6	7	8	9	10	11	12	13	14	15
Age recorded	0,10	1,08	2,08	3,20	5,15	-	5,50	-	-	-	-	-	-	-	-	-
2*stdev	0,61	0,67	1,44	1,68	2,08	-	2,16	-	-	-	-	-	-	-	-	-
n	31	61	61	101	21	0	11	1	0	0	0	0	0	0	0	0

**Table 15.- By modal age are presented the average age recorded, 2\*stdev and number of age readings by reader and of all readers from IFREMER sample. Third reading.**

READER 1																
Modal age	0	1	2	3	4	5	6	7	8	9	10	11	12	13	14	15
Age recorded	-	1,14	2,13	2,89	4,60	4,50	6,00	-	-	-	-	-	-	-	-	-
2*stdev	-	0,76	0,71	1,20	2,68	1,41	2,83	-	-	-	-	-	-	-	-	-
n	0	7	8	9	5	2	2	0	0	0	0	0	0	0	0	0

READER 2																
Modal age	0	1	2	3	4	5	6	7	8	9	10	11	12	13	14	15
Age recorded	-	1,00	1,88	3,11	4,00	5,00	6,50	-	-	-	-	-	-	-	-	-
2*stdev	-	0,00	0,71	0,67	0,00	0,00	1,41	-	-	-	-	-	-	-	-	-
n	0	7	8	9	5	2	2	0	0	0	0	0	0	0	0	0

READER 3																
Modal age	0	1	2	3	4	5	6	7	8	9	10	11	12	13	14	15
Age recorded	-	1,00	2,13	3,11	4,00	5,00	6,00	-	-	-	-	-	-	-	-	-
2*stdev	-	0,00	1,28	0,67	0,00	0,00	0,00	-	-	-	-	-	-	-	-	-
n	0	7	8	9	5	2	2	0	0	0	0	0	0	0	0	0

READER 4																
Modal age	0	1	2	3	4	5	6	7	8	9	10	11	12	13	14	15
Age recorded	-	1,00	1,75	2,78	4,20	3,50	5,50	-	-	-	-	-	-	-	-	-
2*stdev	-	0,00	0,93	0,88	5,37	1,41	4,24	-	-	-	-	-	-	-	-	-
n	0	7	8	9	5	2	2	0	0	0	0	0	0	0	0	0

READER 5																
Modal age	0	1	2	3	4	5	6	7	8	9	10	11	12	13	14	15
Age recorded	-	1,00	2,00	3,11	3,80	3,50	5,50	-	-	-	-	-	-	-	-	-
2*stdev	-	0,00	0,00	0,67	0,89	1,41	1,41	-	-	-	-	-	-	-	-	-
n	0	7	8	9	5	2	2	0	0	0	0	0	0	0	0	0

READER 7																
Modal age	0	1	2	3	4	5	6	7	8	9	10	11	12	13	14	15
Age recorded	-	1,00	1,75	2,67	4,20	5,50	6,00	-	-	-	-	-	-	-	-	-
2*stdev	-	0,00	0,93	1,41	0,89	1,41	0,00	-	-	-	-	-	-	-	-	-
n	0	7	8	9	5	2	2	0	0	0	0	0	0	0	0	0

READER 8																
Modal age	0	1	2	3	4	5	6	7	8	9	10	11	12	13	14	15
Age recorded	-	0,86	2,13	3,00	4,00	5,00	6,00	-	-	-	-	-	-	-	-	-
2*stdev	-	1,38	0,71	0,00	0,00	0,00	0,00	-	-	-	-	-	-	-	-	-
n	0	7	8	9	5	2	2	0	0	0	0	0	0	0	0	0

READER 9																
Modal age	0	1	2	3	4	5	6	7	8	9	10	11	12	13	14	15
Age recorded	-	1,00	2,63	3,67	4,80	5,50	6,50	-	-	-	-	-	-	-	-	-
2*stdev	-	0,00	1,83	2,24	3,29	1,41	4,24	-	-	-	-	-	-	-	-	-
n	0	7	8	9	5	2	2	0	0	0	0	0	0	0	0	0

READER 10																
Modal age	0	1	2	3	4	5	6	7	8	9	10	11	12	13	14	15
Age recorded	-	1,00	2,25	3,44	3,60	4,50	5,50	-	-	-	-	-	-	-	-	-
2*stdev	-	0,00	0,93	3,02	1,79	1,41	4,24	-	-	-	-	-	-	-	-	-
n	0	7	8	9	5	2	2	0	0	0	0	0	0	0	0	0

READER 11																
Modal age	0	1	2	3	4	5	6	7	8	9	10	11	12	13	14	15
Age recorded	-	0,71	2,25	3,11	4,80	4,50	6,00	-	-	-	-	-	-	-	-	-
2*stdev	-	0,98	0,93	1,56	2,19	1,41	0,00	-	-	-	-	-	-	-	-	-
n	0	7	8	9	5	2	2	0	0	0	0	0	0	0	0	0

ALL READERS																
Modal age	0	1	2	3	4	5	6	7	8	9	10	11	12	13	14	15
Age recorded	-	0,97	2,09	3,09	4,20	4,65	5,95	-	-	-	-	-	-	-	-	-
2*stdev	-	0,59	1,06	1,52	2,29	1,63	2,00	-	-	-	-	-	-	-	-	-
n	0	70	80	90	50	20	20	0	0	0	0	0	0	0	0	0

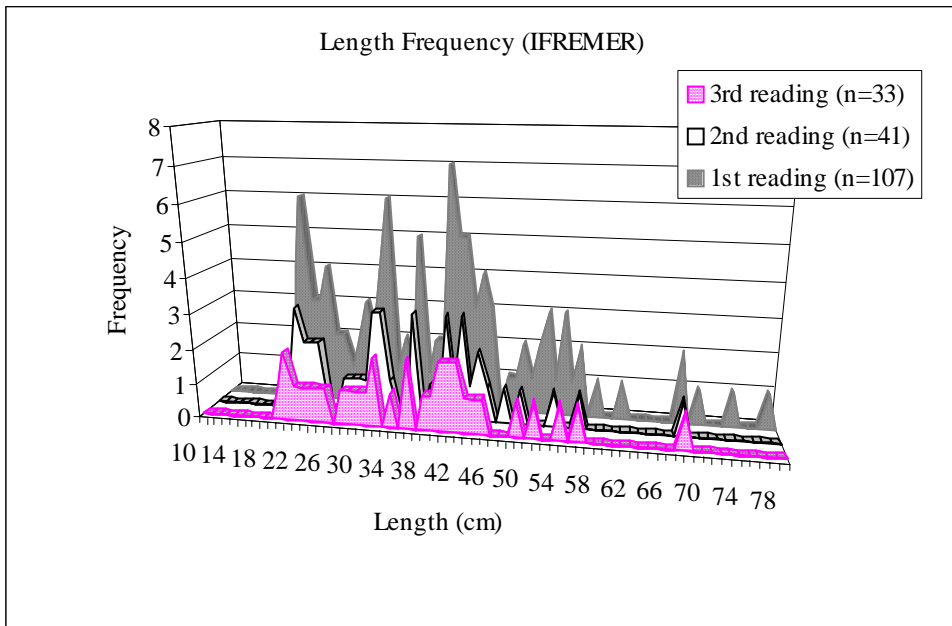
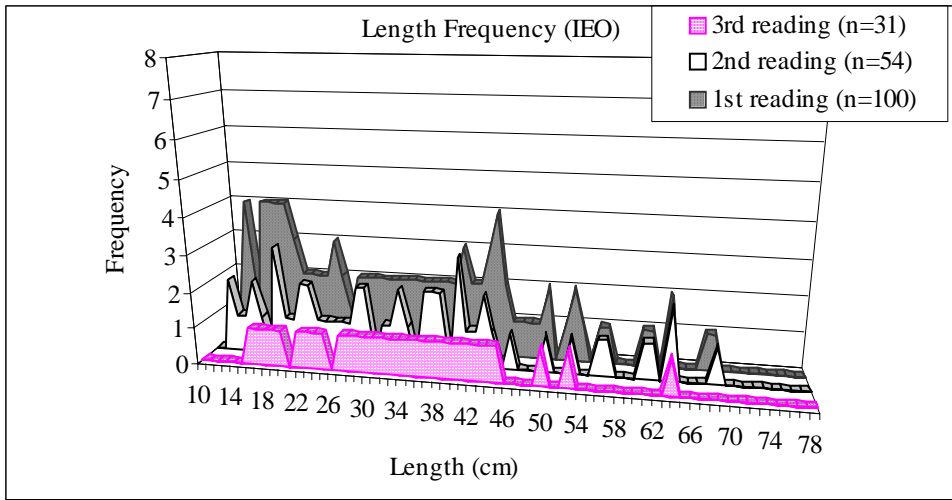
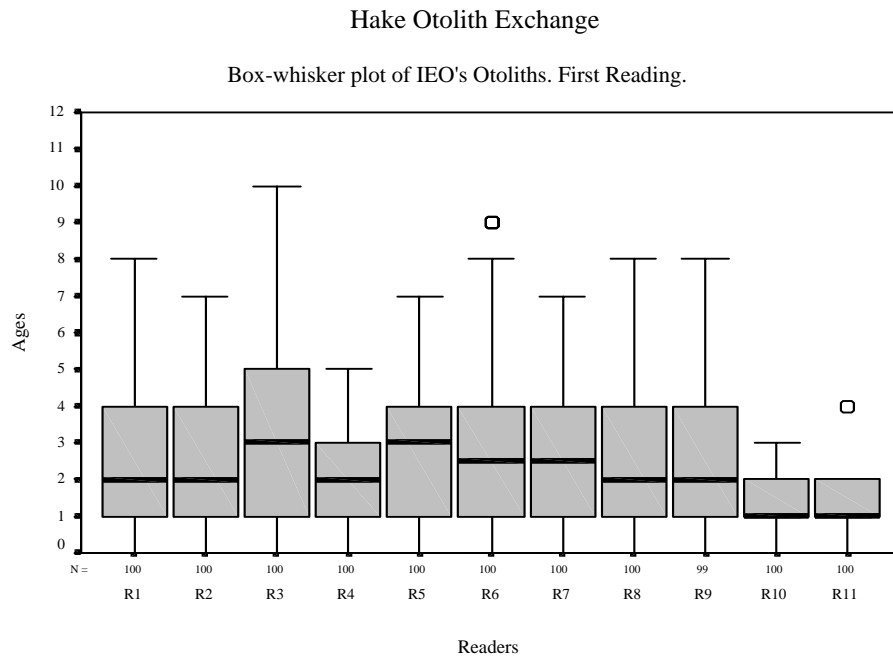

Figure 1.- Length Frequency distribution from the three readings sets of IEO and IFREMER samples

a)



b)

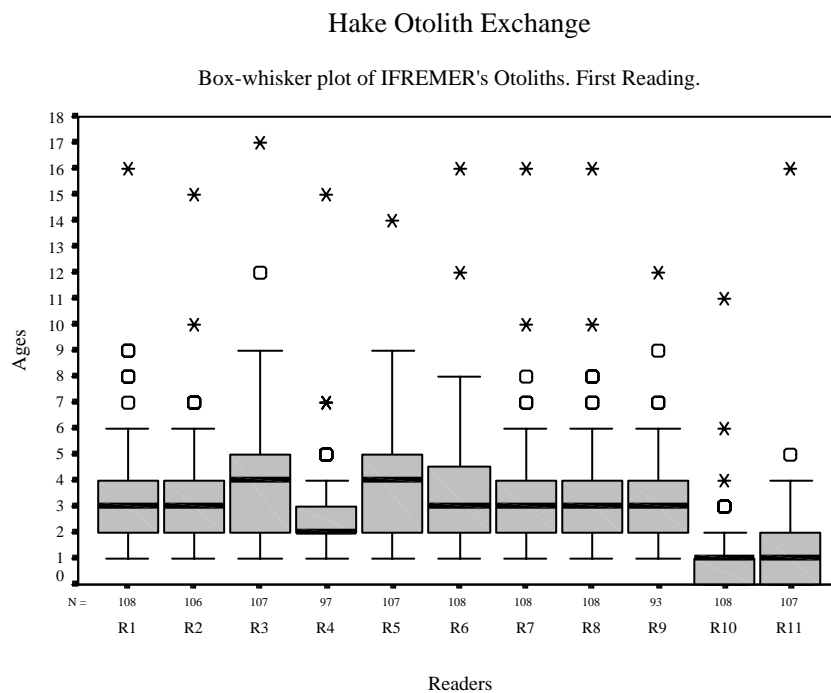

Figure 2.- Box-whisker plot for the first reading of the IEO (a) and IFREMER (b) samples (\* Extreme value □ Outliers). Age readings for all readers.

### HAKE EXCHANGE IEO SAMPLE (FIRST READING)

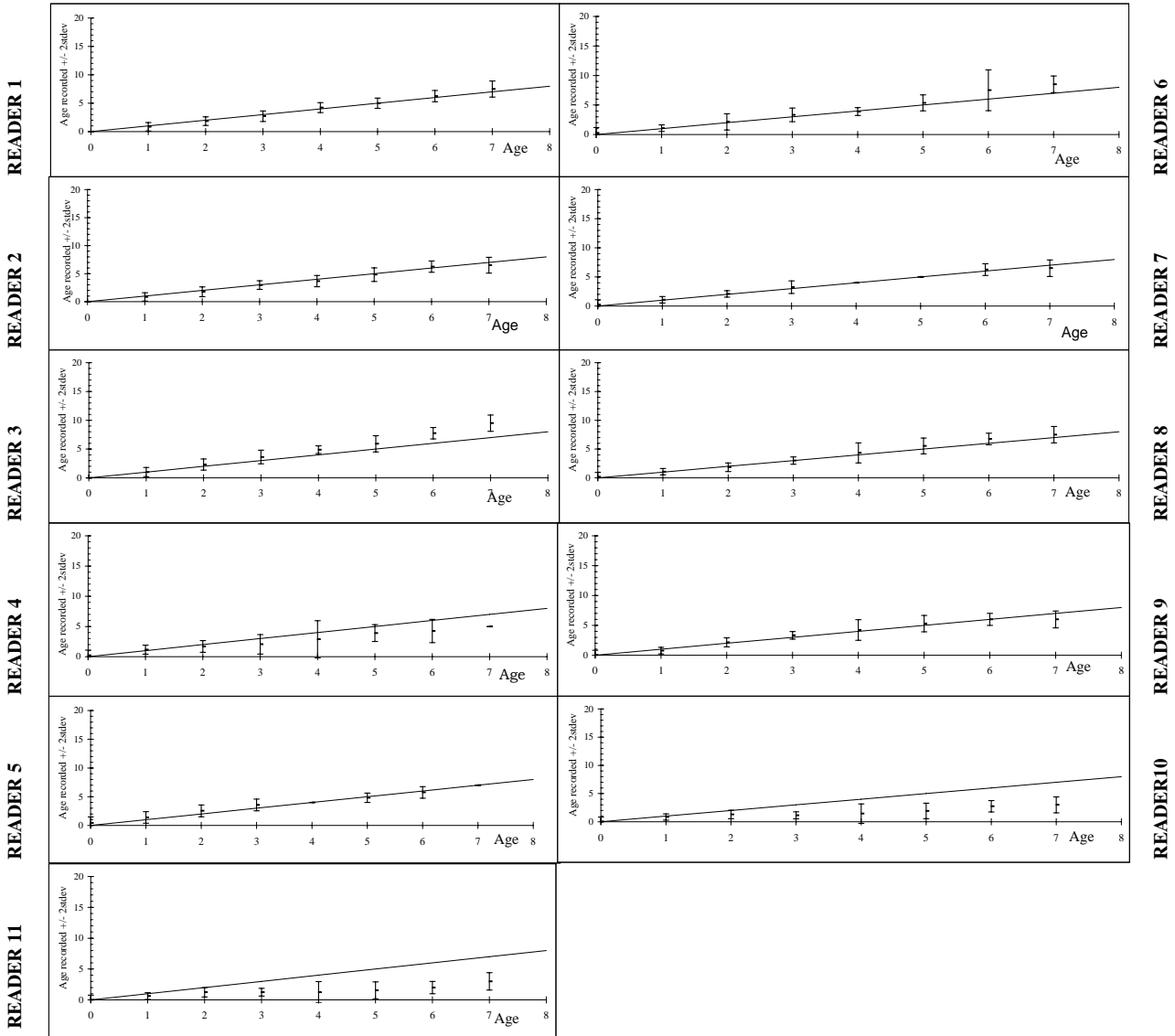

Figure 3a.- In above age bias plots average age +/- 2stdev of each age reader is plotted against modal age.

Modal age	0	1	2	3	4	5	6	7	8
Age recorded	0,13	0,97	1,90	2,74	3,53	4,46	5,59	6,36	-
2*stdev	0,68	0,92	1,37	2,03	2,61	3,09	3,79	4,12	-

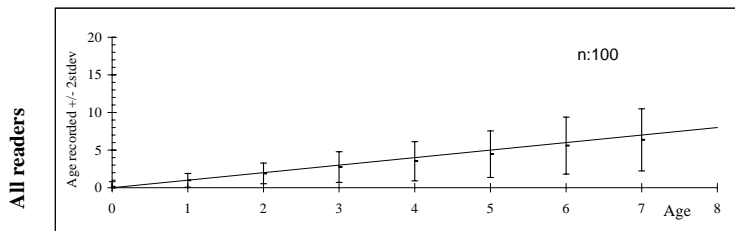

Figure 3b.- In above age bias plot average age +/- 2stdev of all age readers is plotted against modal age.

HAKE EXCHANGE IFREMER SAMPLE (FIRST READING)

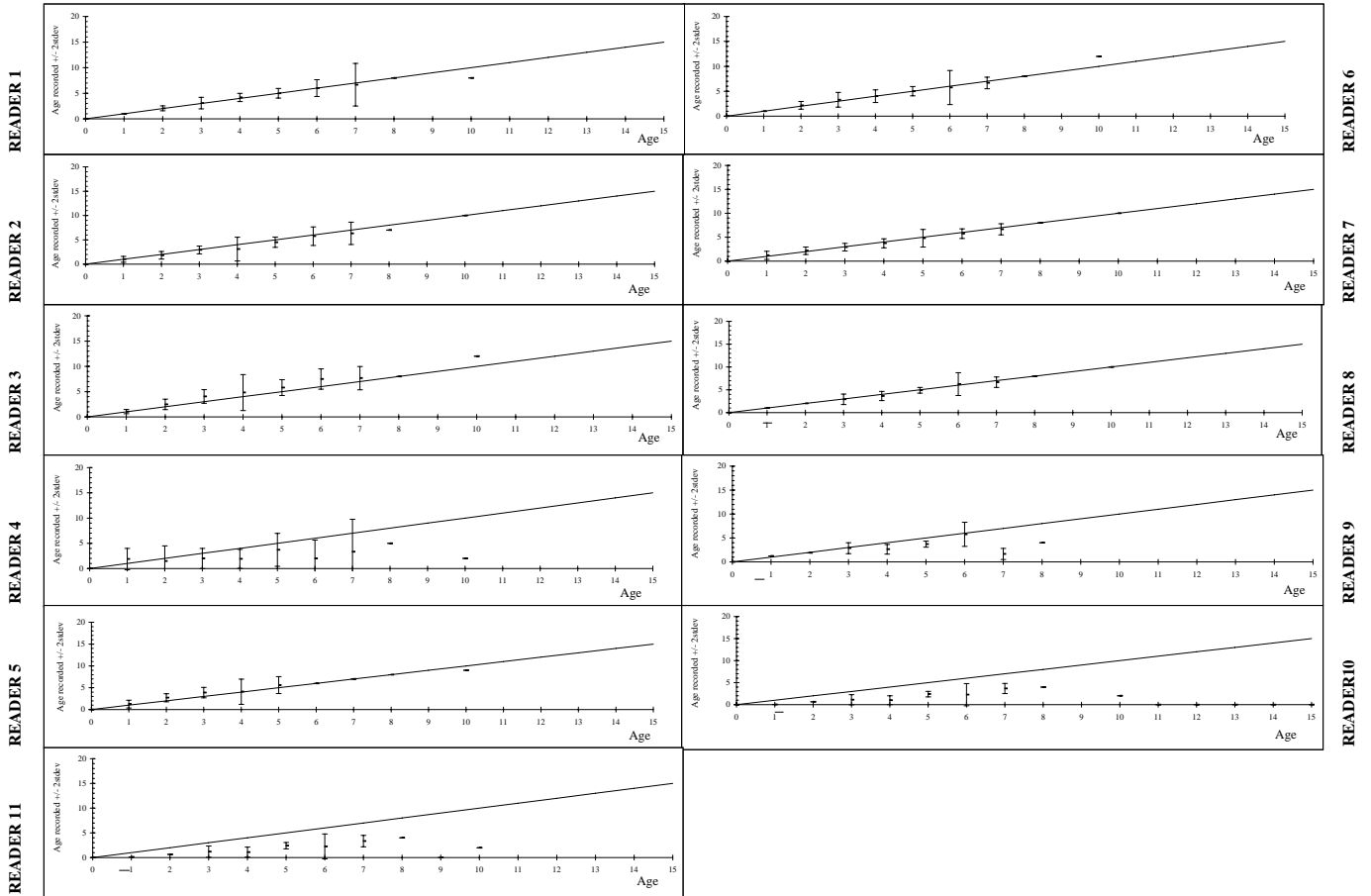

Figure 4a.- In above age bias plots average age +/- 2stdev of each age reader is plotted against modal age.

Modal age	0	1	2	3	4	5	6	7	8	9	10	11	12	13	14	15
Age recorded	-	0,98	1,82	2,75	3,11	4,35	5,02	5,42	6,55	-	7,00	-	-	-	-	-
2*stdev	-	1,29	1,78	2,34	3,20	3,06	4,10	4,85	3,73	-	9,08	-	-	-	-	-

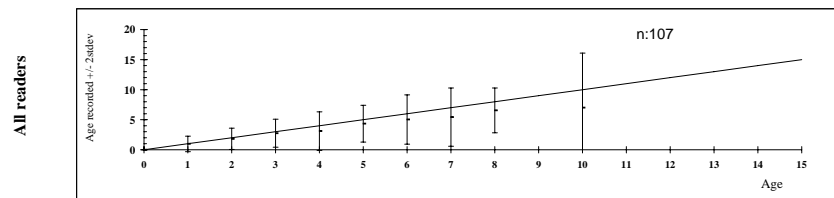

Figure 4b.- In above age bias plot average age +/- 2stdev of all age readers is plotted against modal age.



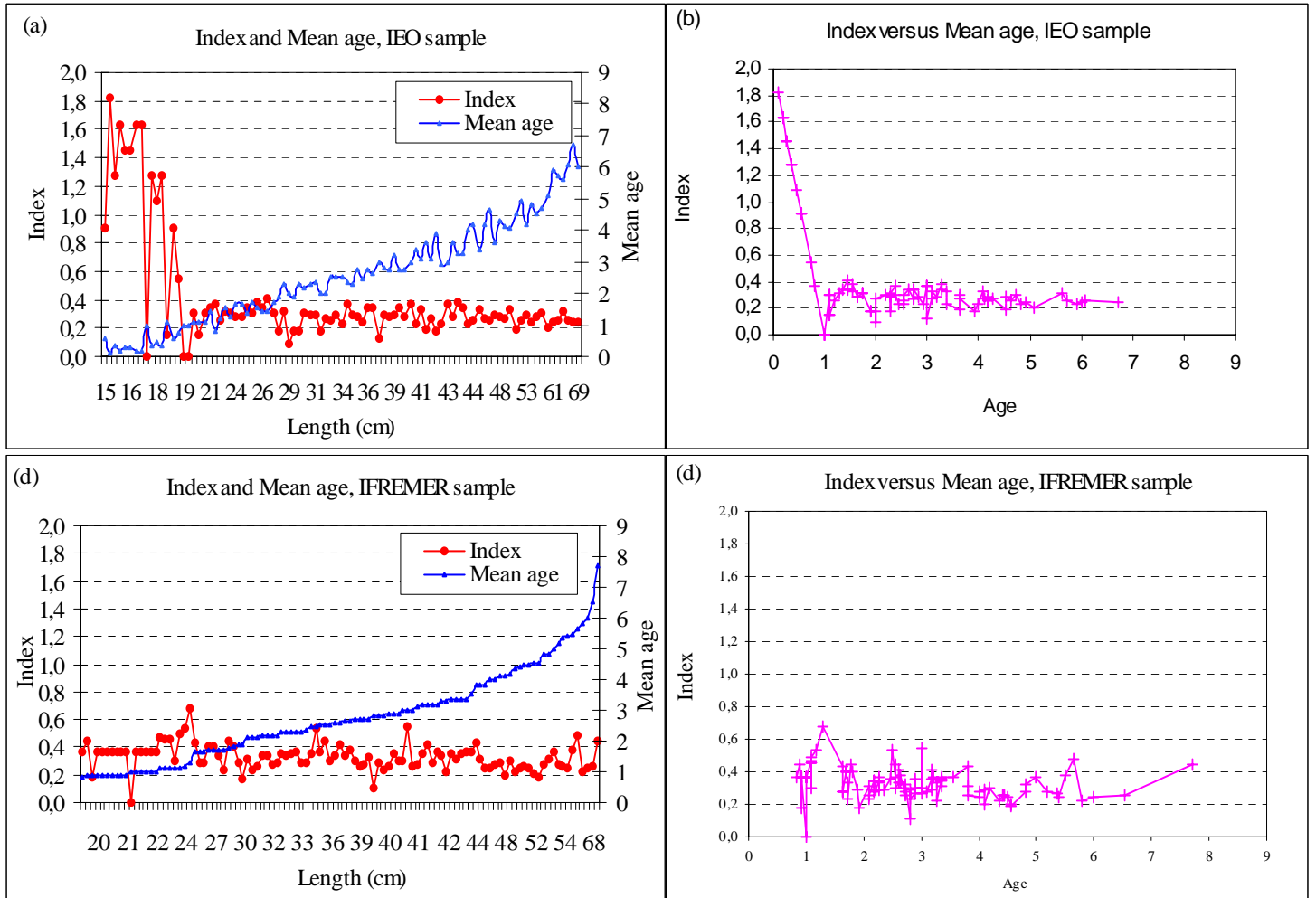
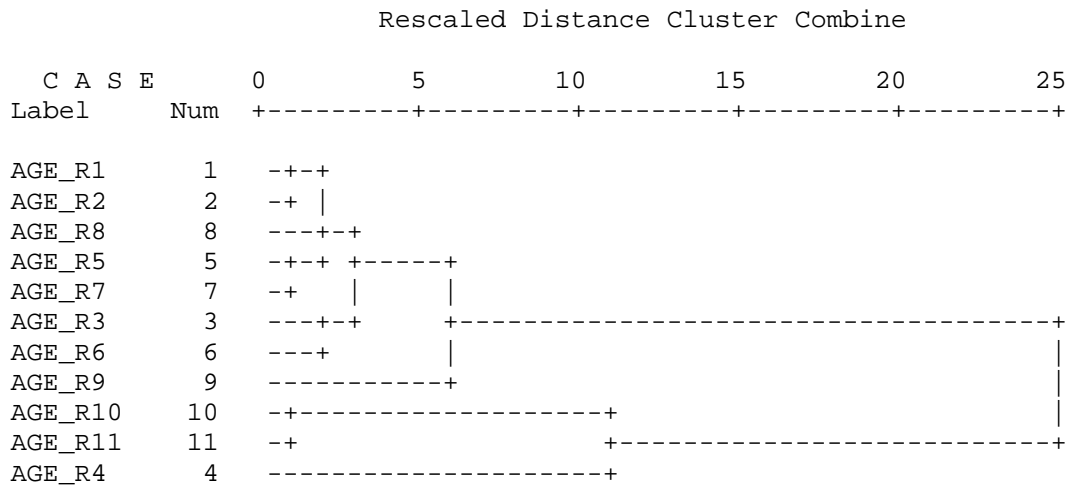

Figure 5.- APE and or versus mean age for both samples: IEO (a, b) and IFREMER (c, d). First reading.

a)



b)

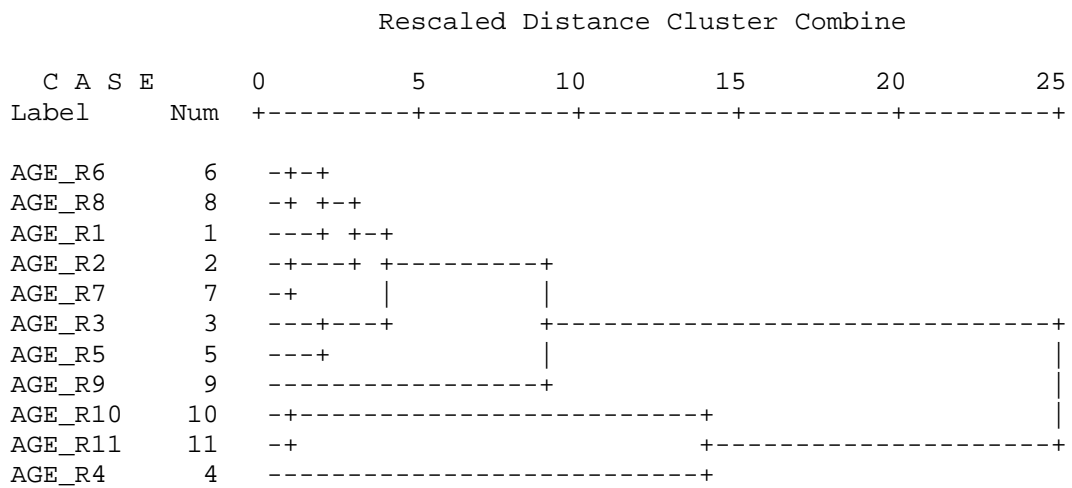
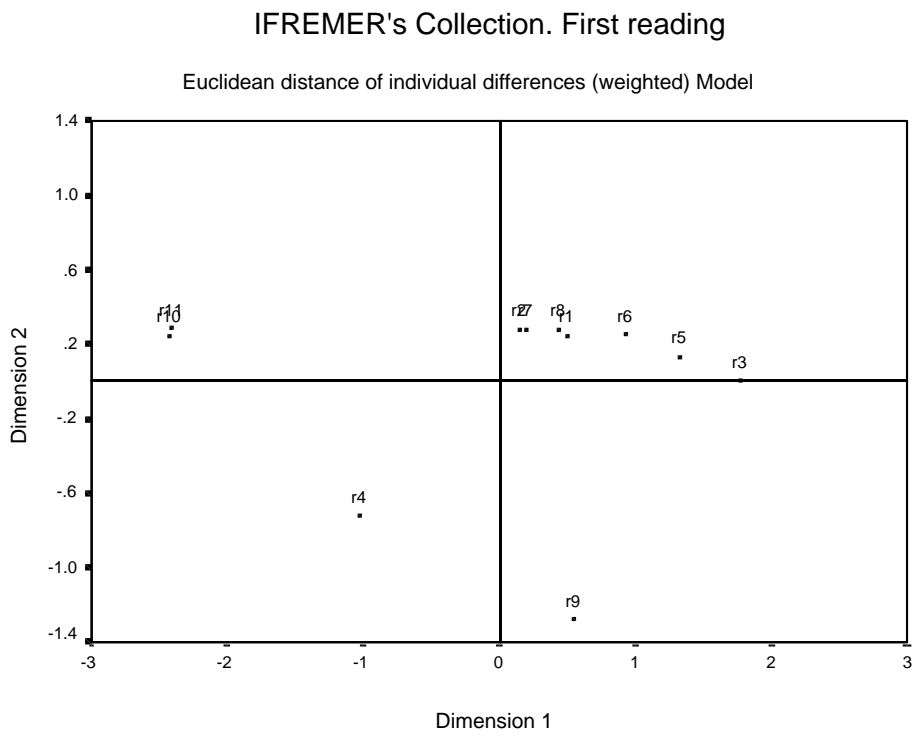
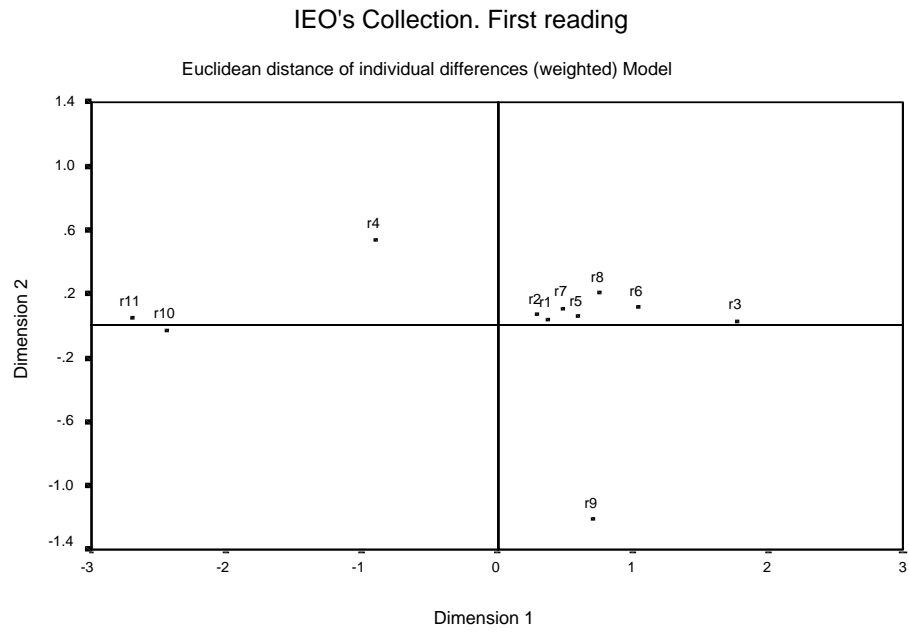

Figure 6.- Dendrogram obtained from the hierachical cluster analysis from IEO (a) and IFREMÉR (b) samples. First reading.

a)



b)

Figure 7.- M.S.D. plots analysis from IEO (a) and IFREMER (b) samples.

a)

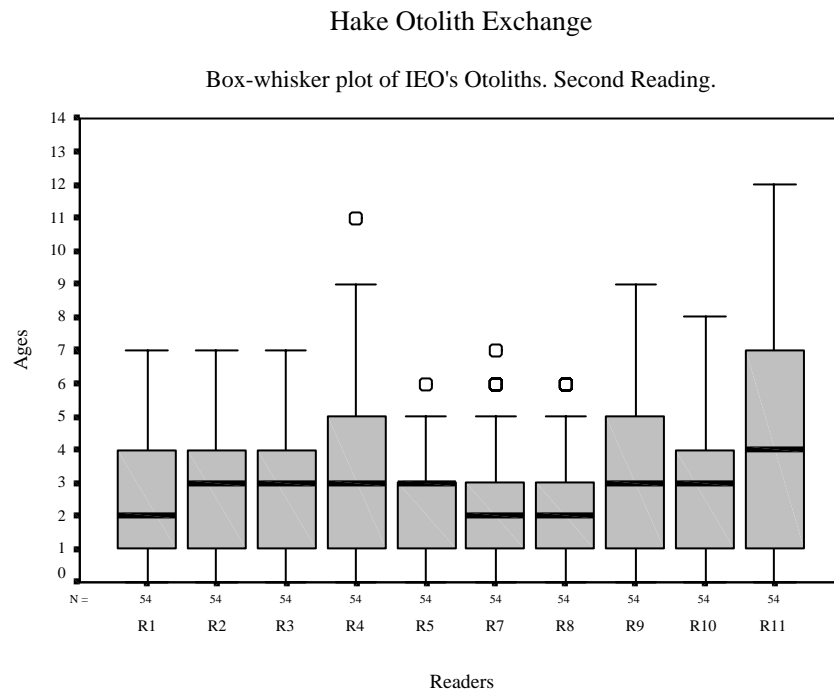

b)

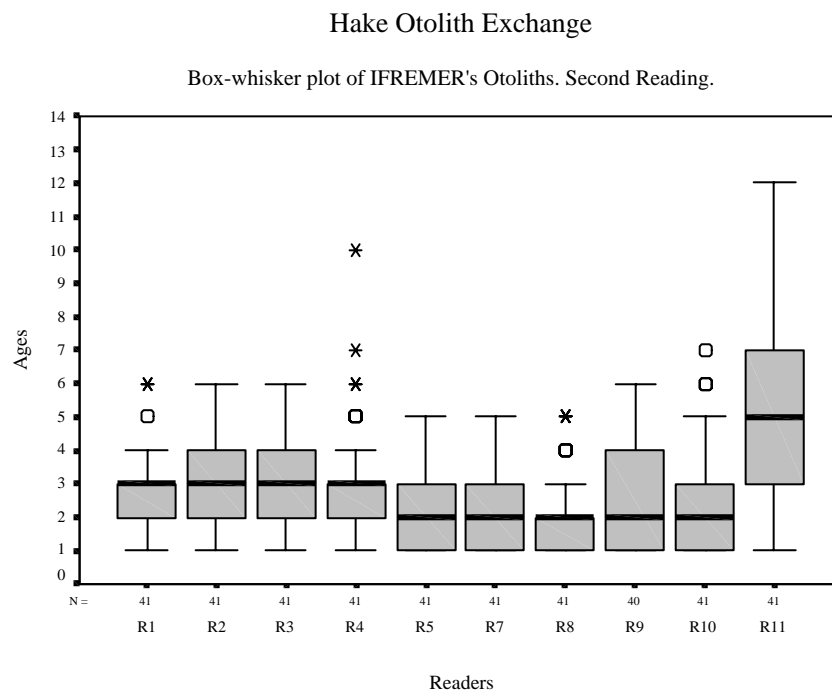

Figure 8.- Box-whisker plot for the second reading of IEO (a) and IFREMER (b) samples. (\* extreme values, □ outliers). Age readings for all readers.

## HAKE EXCHANGE IEO SAMPLE (SECOND READING)

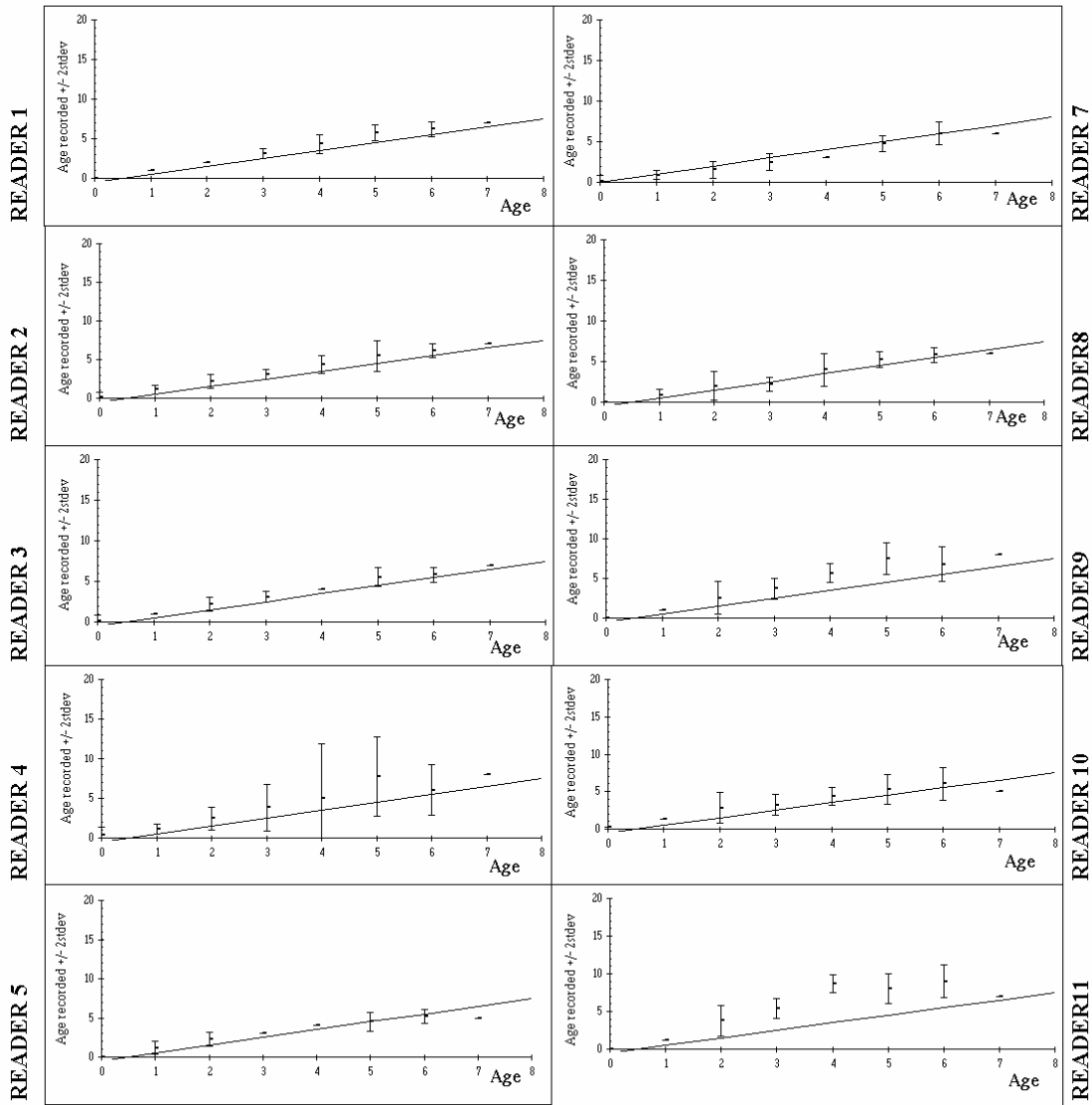

Figure 9a.- In above age bias plots average age +/- 2stdev of each age reader is plotted against modal age

Modal age	0,5	1,5	2,5	3,5	4,5	5,5	6,5	7,5	8,5	9,5	10,5	11,5	12,5	13,5	14,5
Age recorded	0,10	1,05	2,35	3,28	4,58	5,83	6,18	6,00	-	-	-	-	-	-	-
2*stdev	0,60	0,73	1,80	2,19	4,31	3,66	3,32	4,47	-	-	-	-	-	-	-

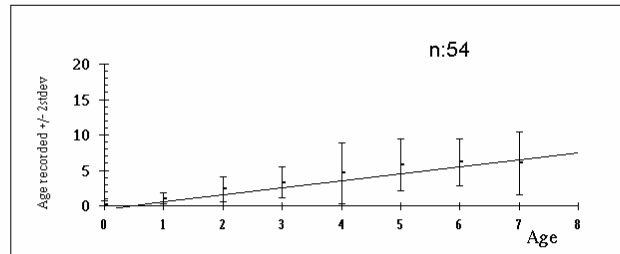

Figure 9b.- In above age bias plot average age +/- 2stdev of all age readers is plotted against modal age.

## HAKE EXCHANGE IFREMER SAMPLE (SECOND READING)

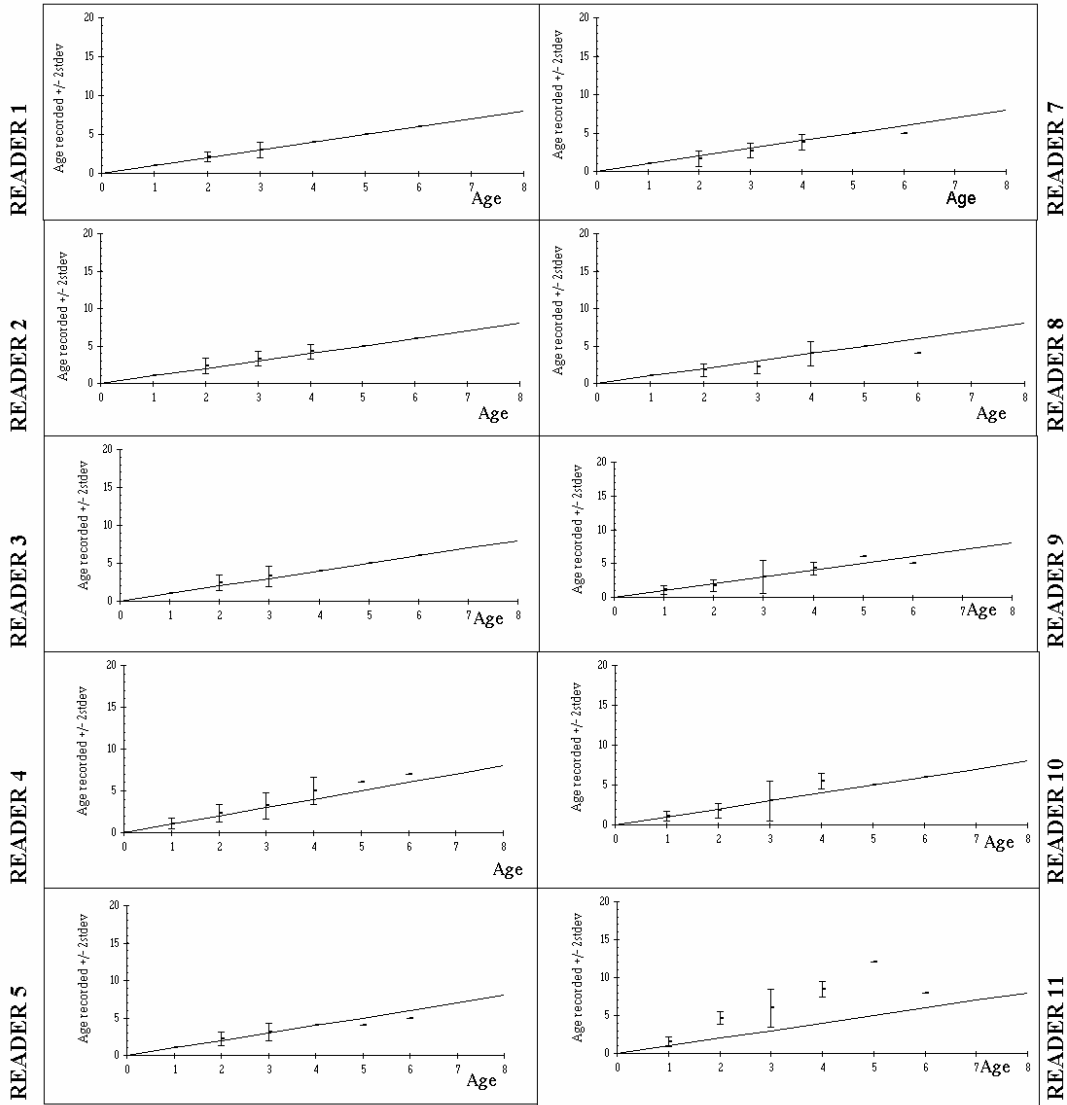

Figure 10a. In above age bias plots average age +/- 2stdev of each age reader is plotted against modal age.

Modal age	0	1	2	3	4	5	6	7	8	9	10	11	12	13	14	15
Age recorded	-	1,08	2,31	3,28	4,73	5,80	5,80	-	-	-	-	-	-	-	-	-
2*stdev	-	0,61	2,13	2,45	3,36	4,50	2,27	-	-	-	-	-	-	-	-	-

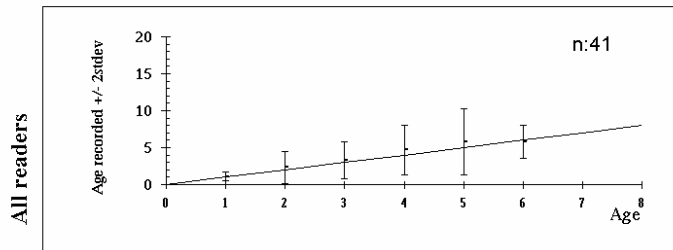
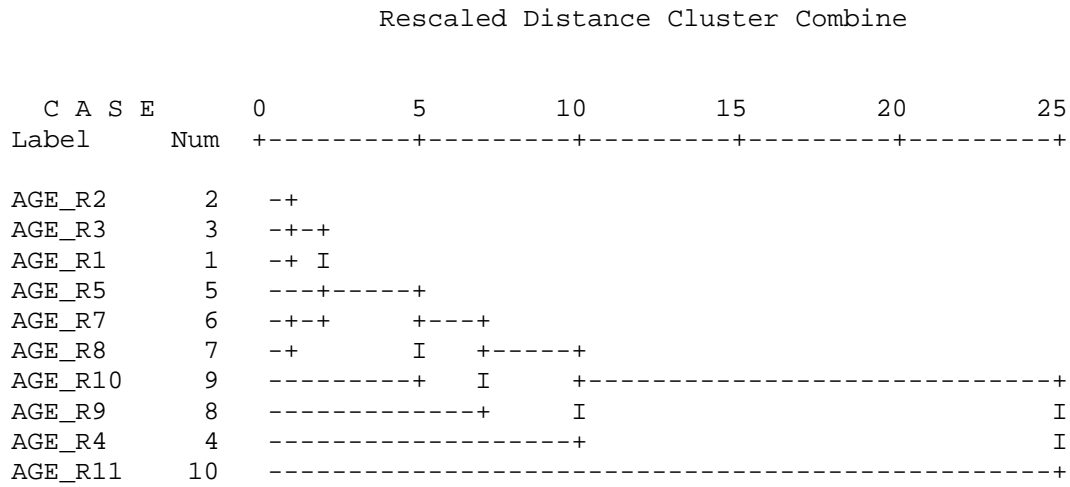

Figure 10b.- In above age bias plot average age +/- 2stdev of all age readers is plotted against modal age.

a)



b)

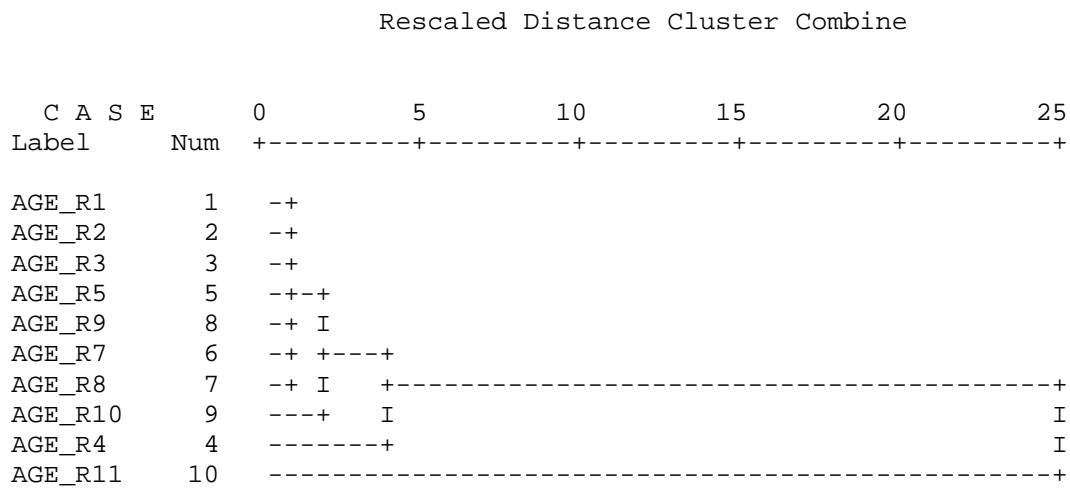
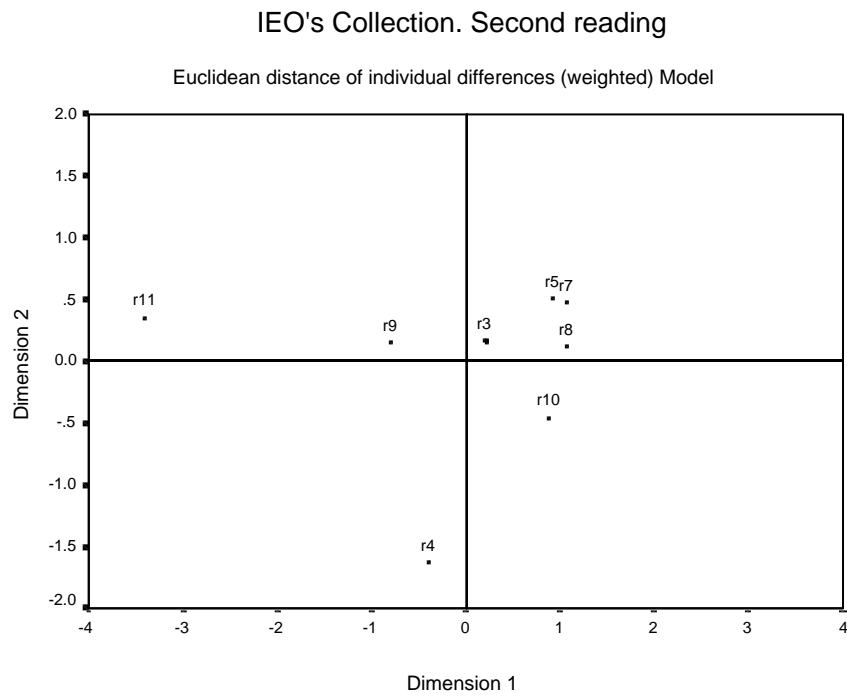

Figure 11.- Dendrogram obtained from the hierachical cluster analysis from IEO (a) and IFREMER (b) samples. Second Reading.

a)



b)

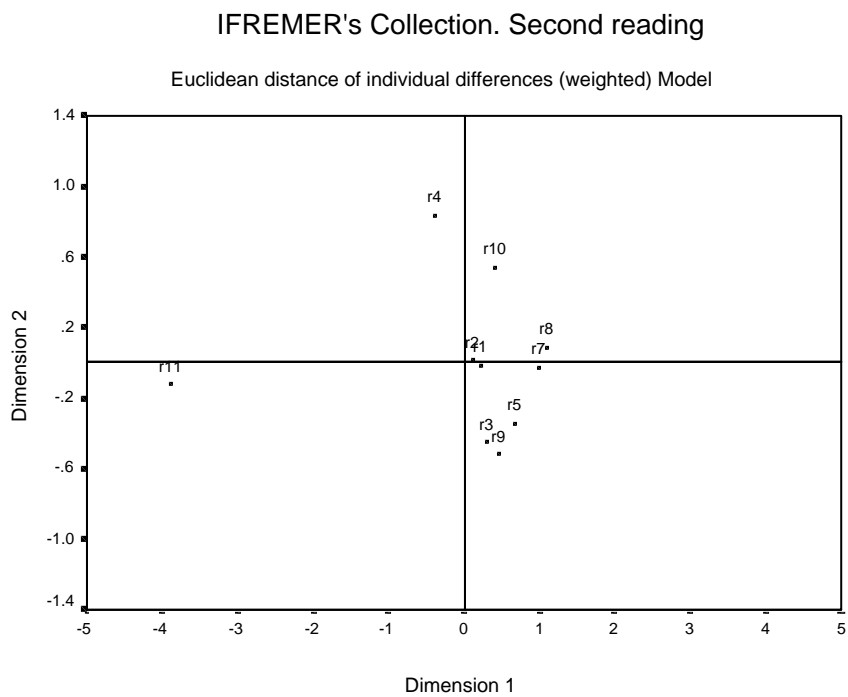
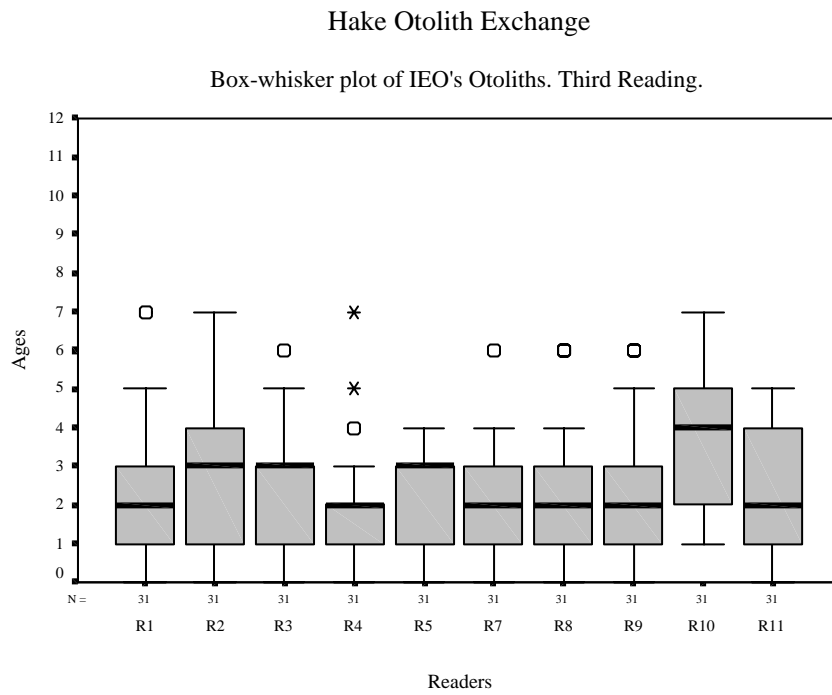

Figure 12.- M.S.D. plots analysis from IEO (a) and IFREMER (b) samples. Second Reading.



a)



b)

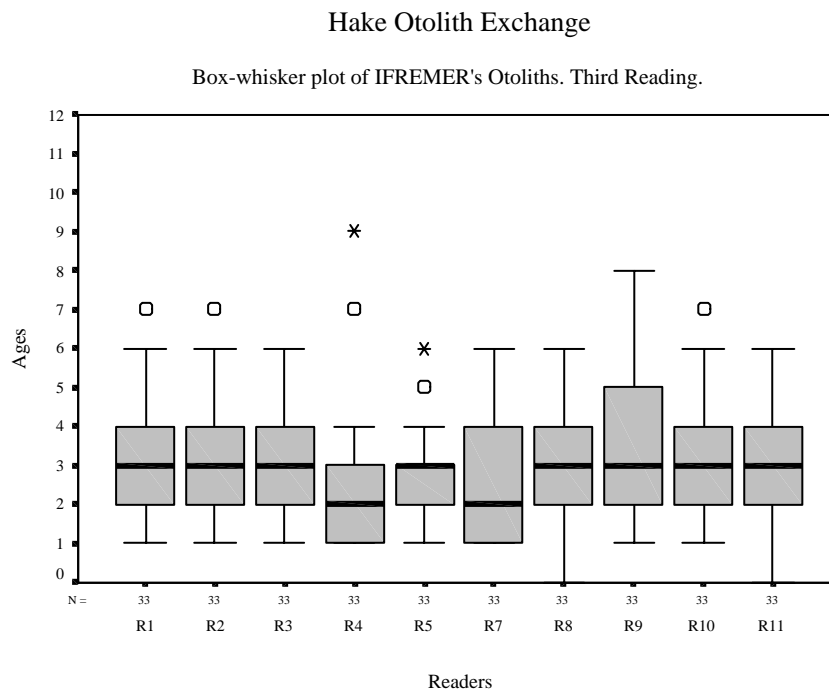

Figure 13.- Box-whisker plot for the third reading of the IEO (a) and IFREMER (b) samples. (\* Extreme value □ Outliers). Age readings for all readers.

## HAKE EXCHANGE IEO SAMPLE (THIRD READING)

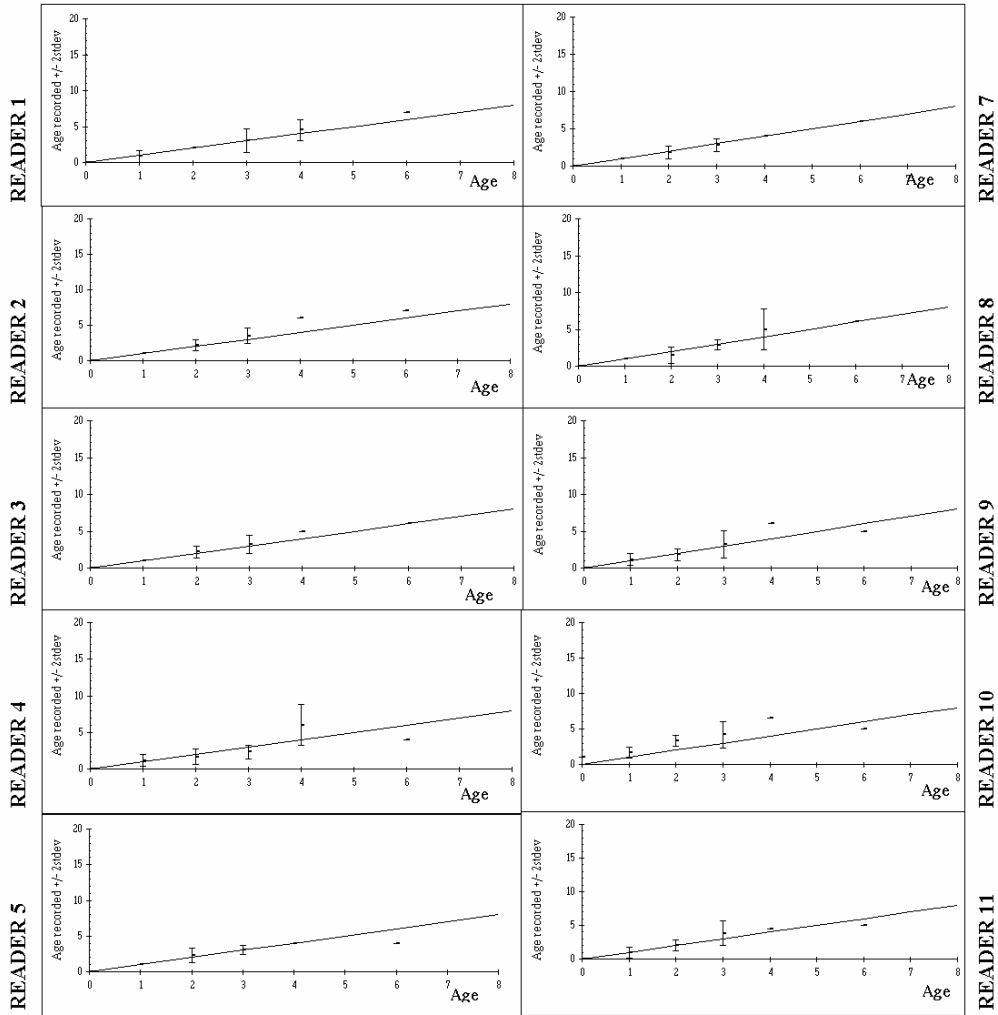

Figure 14a. In above age bias plots average age +/- 2stdev of each age reader is plotted against modal age.

Modal age	0	1	2	3	4	5	6	7	8	9	10	11	12	13	14	15
Age recorded	0,10	1,08	2,08	3,20	5,15	-	5,50	-	-	-	-	-	-	-	-	-
2*stdev	0,61	0,67	1,44	1,68	2,08	-	2,16	-	-	-	-	-	-	-	-	-

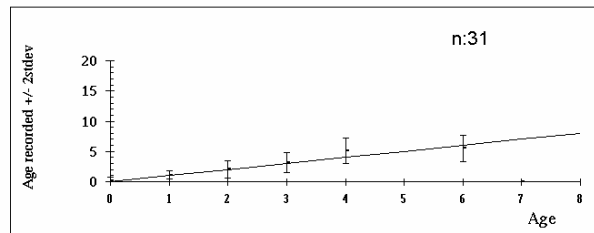

Figure 14b.- In above age bias plot average age +/- 2stdev of all age readers is plotted against modal age.

## HAKE EXCHANGE IFREMER SAMPLE (THIRD READING)

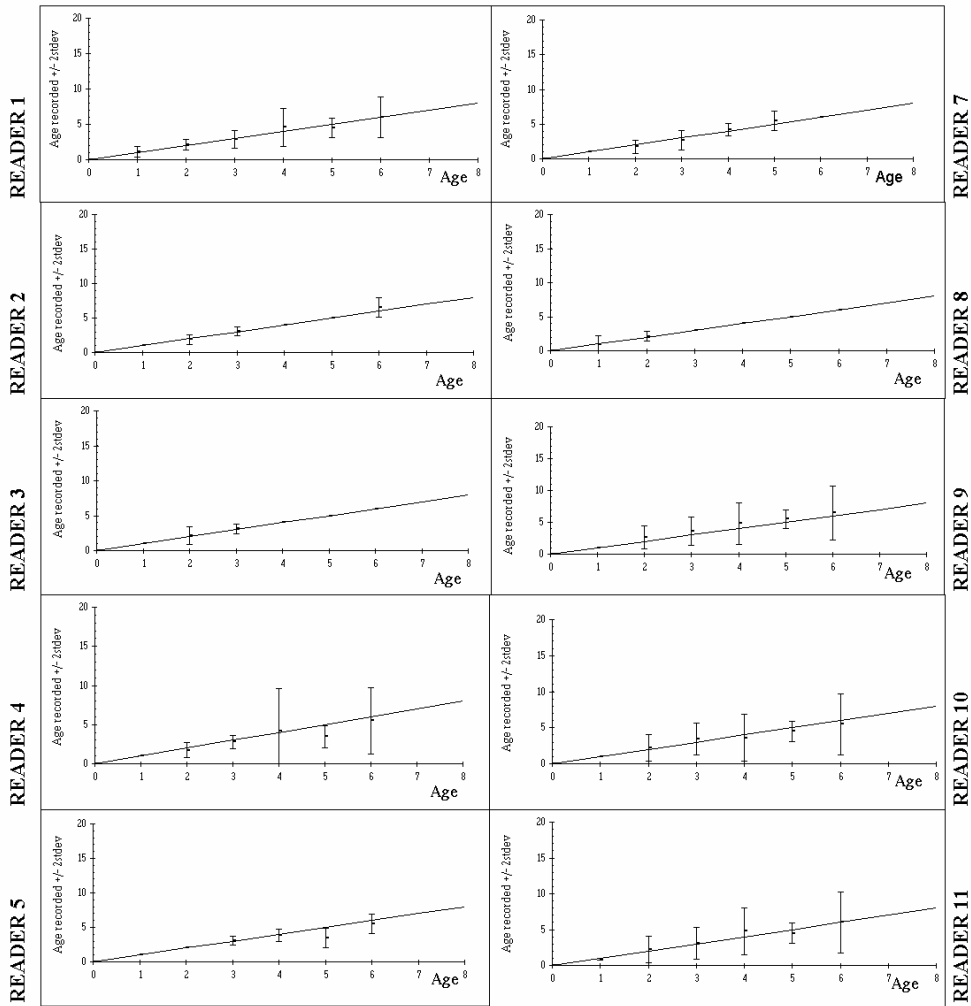

Figure 15a.- In above age bias plots average age +/- 2stdev of each age reader is plotted against modal age.

Modal age	0	1	2	3	4	5	6	7	8	9	10	11	12	13	14	15
Age recorded	-	0,97	2,09	3,09	4,20	4,65	5,95	-	-	-	-	-	-	-	-	-
2*stdev	-	0,59	1,06	1,52	2,29	1,63	2,00	-	-	-	-	-	-	-	-	-

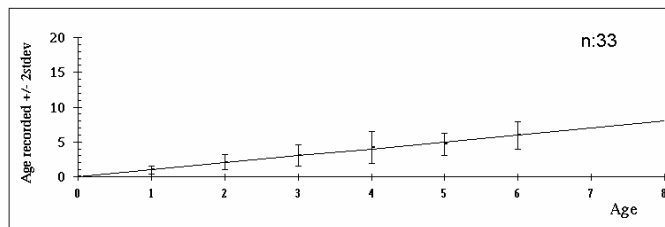
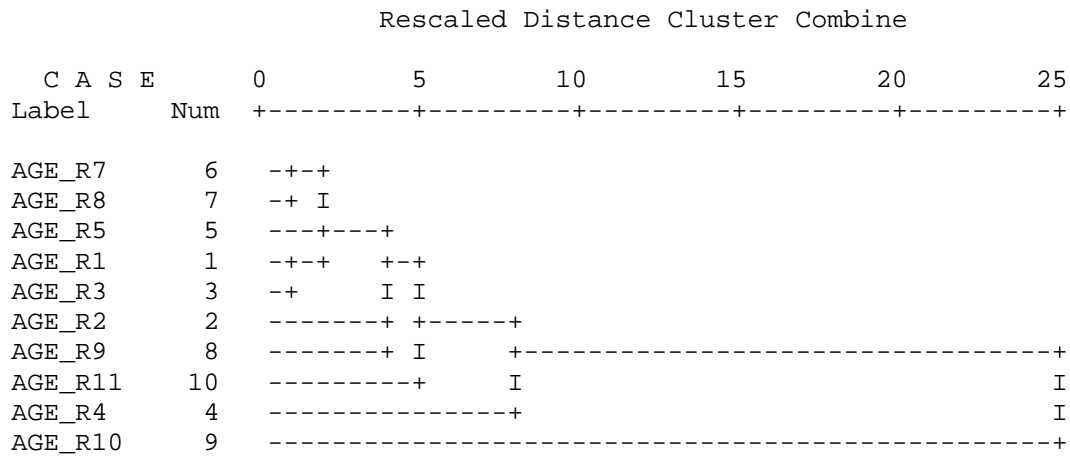

Figure 15b.- In above age bias plot average age +/- 2stdev of all age readers is plotted against modal age.

a)



b)

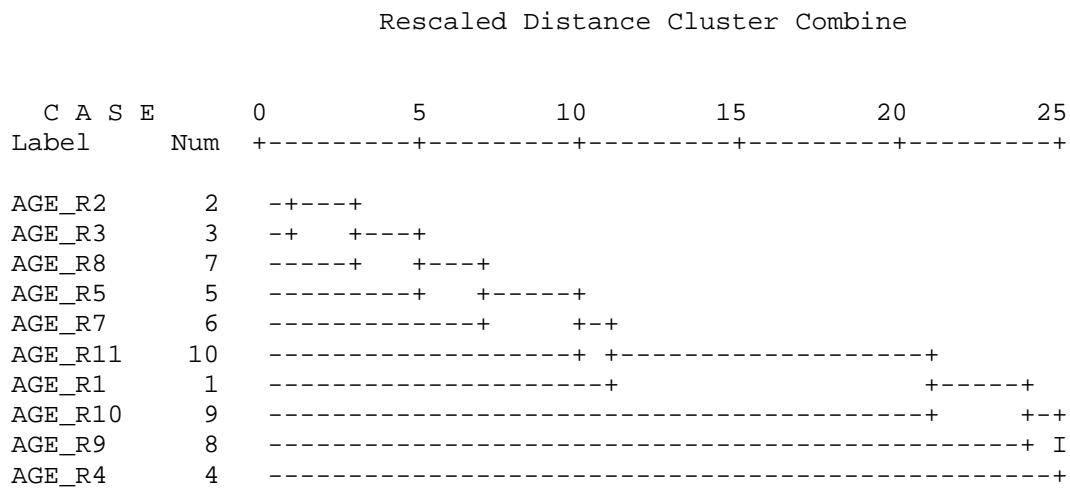
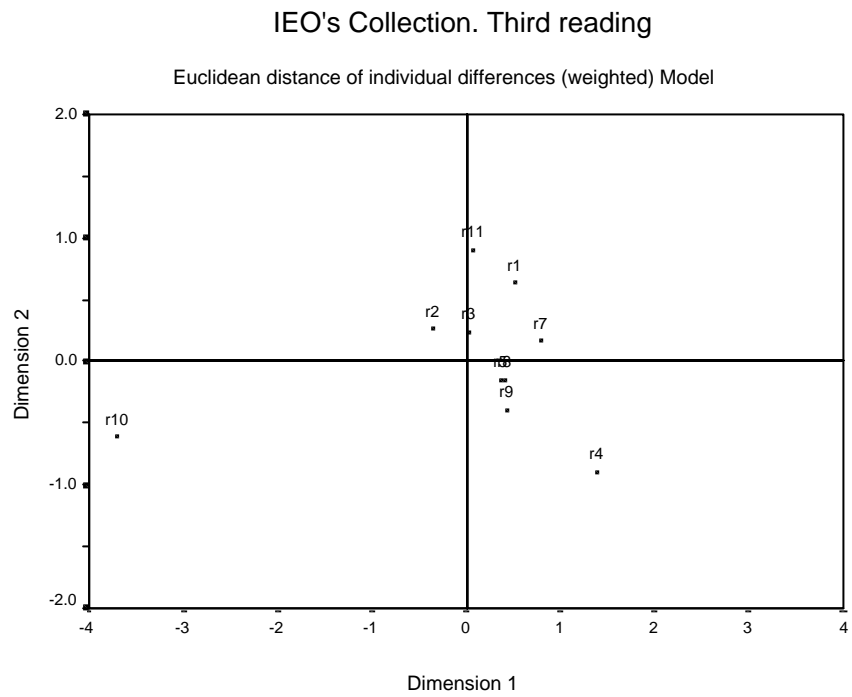

Figure 16.- Dendrogram obtained from the hierachical cluster analysis from IEO (a) and IFREMER (b) samples. Third reading.

a)



b)

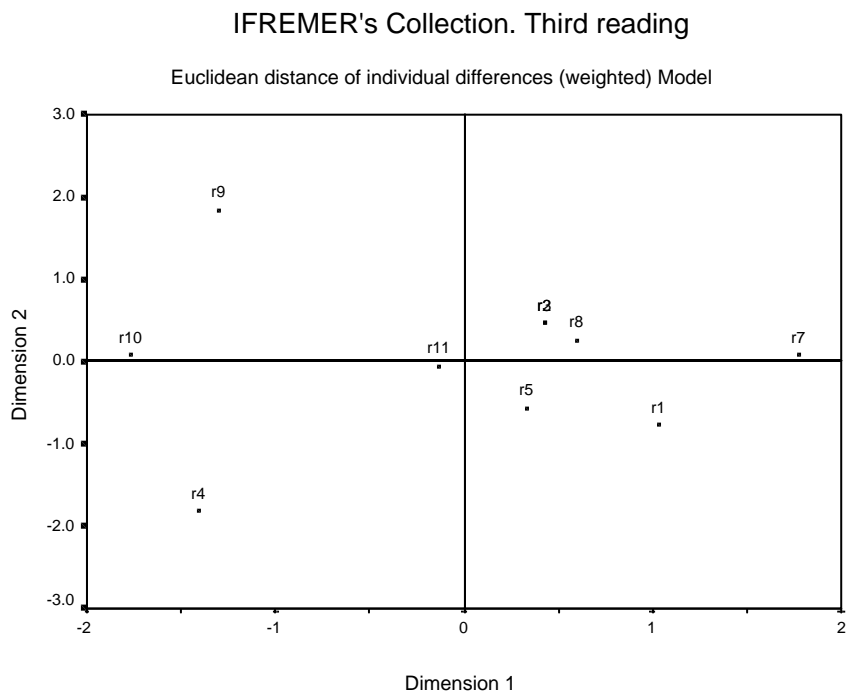
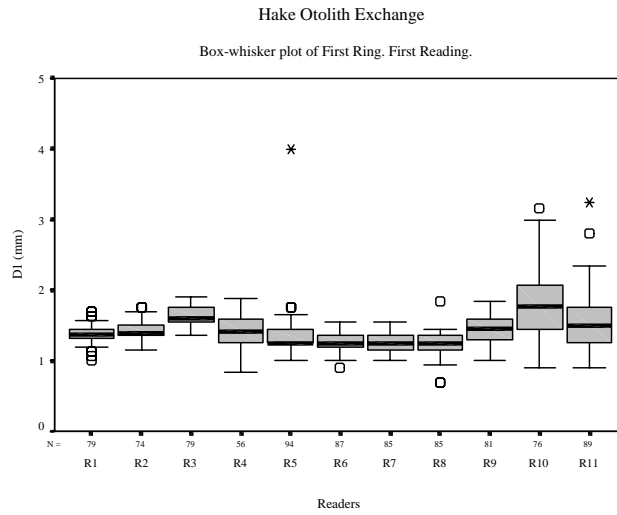
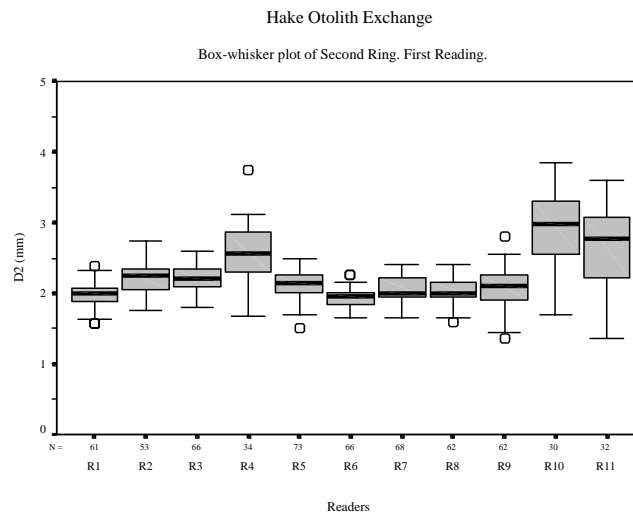

Figure 17.- M.S.D. plots analysis from IEO (a) and IFREMER (b) samples.

a)



b)



c)

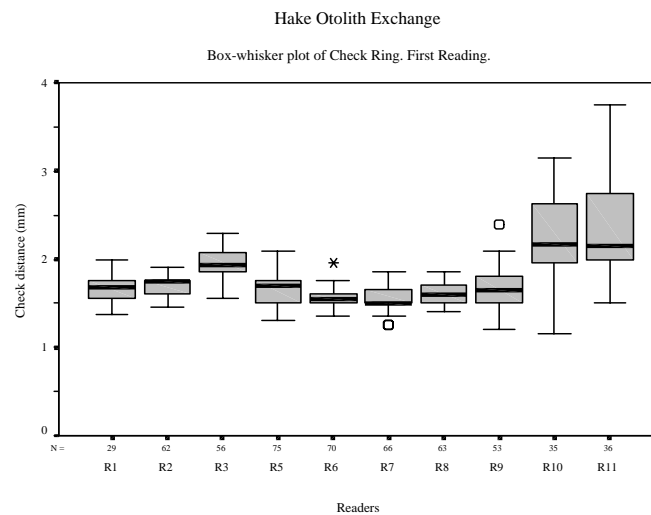

Figure 18.- Box-whisker plot for the measurements of rings: first (a), second (b) and check (c) determined by each reader in the first reading of IEO sample. (\* Extreme values, □ outliers).

### Hake Otolith Exchange

Box-whisker plot of First Ring. Second Reading.

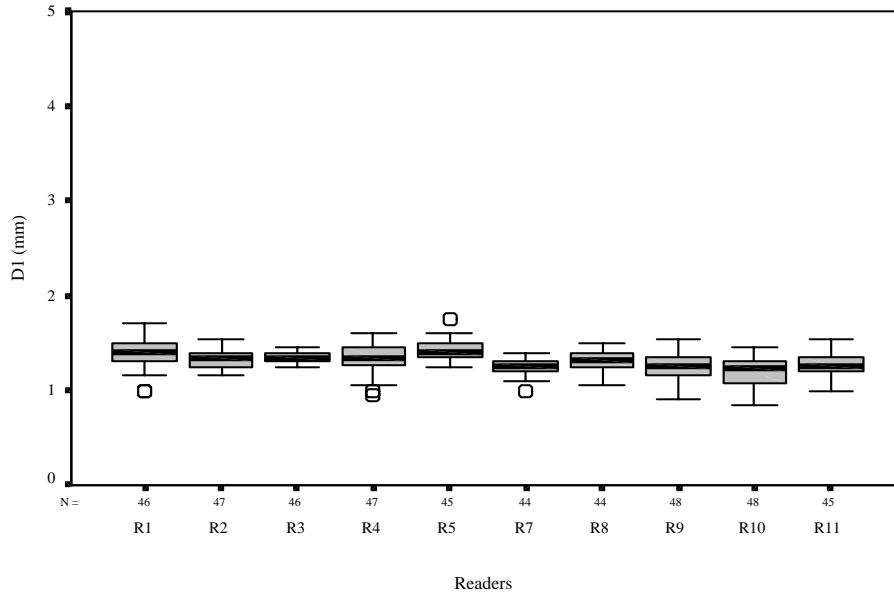

Figure 19.- First ring measurement determined by reader in the second reading.

HAKE AGEING WORKSHOP , 15-19 February, 1999 (IEO - VIGO).

Name	LAB.	Adress	E mail	FAX
Jacques Labastie	IFREMER	BP7 17137 L' Houmeau (France)	<i>jLabas@ifremer.fr</i>	33 5 46 50 93 79
Robert Bellail	IFREMER	Rue F. Toullee 56100 Lorient (France)	<i>rbellail@ifremer.fr</i>	33 2 97 83 41 06
Philippe Moguedet	IFREMER	BP7 17 137 L'HOUMIAU , LA ROCHELLE, FRANCE	<i>philippe.moguedet@ifremer.fr</i>	33 546 50 9379
Lourdes Marecos	IPIMAR	Avda. Brasilia - 1400 LISBOA	<i>lgodinho@ipimar.pt</i>	351 1 301 59 48
Maria Ortense Afonso	IPIMAR	Avda. Brasilia - 1400 LISBOA	<i>hafonso@ipimar.pt</i>	351 1 301 59 48
Cristina Morgado	IPIMAR	Avda. Brasilia - 1400 LISBOA	<i>cmorgado@ipimar.pt</i>	352 1 301 59 48
Paulino Lucio	AZTI	Isla de Txatxarramendi s/n 48395.	<i>paulino@rp.azti.es</i>	34 4 687 0006
		SUKARRIETA (Bizkaia)		
Marina Santurtun	AZTI	Isla de Txatxarramendi s/n 48395.	<i>marina@rp.azti.es</i>	34 4 687 0006
		SUKARRIETA (Bizkaia)		
Susana Arego	AZTI	Isla de Txatxarramendi s/n 48395.	<i>susana@rp.azti.es</i>	34 4 687 0006
		SUKARRIETA (Bizkaia)		
Carmen G <sup>a</sup> Piñeiro	IEO,Vigo	Cabo Estay - Canido - Apdo 1552. 36200 VIGO	<i>carmen.pineiro@vi.ieo.es</i>	34 86 49,23,51
Maria Sainza	IEO, Vigo	Cabo Estay - Canido - Apdo 1552. 36200 VIGO	<i>maria.sainza@vi.ieo.es</i>	34 86 49,23,51
Isabel Loureiro	IEO, Vigo	Cabo Estay - Canido - Apdo 1552. 36200 VIGO	<i>isabel.loureiro@vi.ieo.es</i>	34 86 49,23,51
Valentin Trujillo	IEO, Vigo	Cabo Estay - Canido - Apdo 1552. 36200 VIGO	<i>valentin.trujillo@vi.ieo.es</i>	34 86 49,23,51
Terry Watson	CEFAS	Lowestoft Laboratory, Pakefield Road, Lowestoft		44 (0) 1502 562244
		Suffolk NR33 OHT, UK		
Fiona Watson	MIFRC	ABBOTSTOWN, CASTLEKNOCK, D-15	<i>fwoods@frc.ie</i>	00 353 1 8205078
Helen Mc Cormick	MIFRC	ABBOTSTOWN, CASTLEKNOCK, D-16	<i>helenmc@frc.ie</i>	1 353 1 8205078



# **Annex I**

## **PROTOCOL ON HAKE AGE READINGS OTOLITH EXCHANGE, 1998**

Following the recommendations from the last workshop on Hake age determination in Vigo (June, 1997) another otolith exchange will be conducted during 1998 in order to continue with the work started and including more participants, ideally readers from countries involved in stock assessment .

A collection of 200 Hake otolith sections from different areas: VII Sub-area and Division VIIIab +VIIIc + IXa, (ICES) will be exchanged among different readers during 1998, To analyse and discuss the results of the exchange and to identify the age interpretations problems another Workshop will be convened in the first semester of 1999, in Vigo. (Spain)

### **PARTICIPANTS:**

- |            |                         |
|------------|-------------------------|
| - France   | - IFREMER (La Rochelle) |
| - Spain    | - IEO. Vigo             |
| - Spain    | - AZTI. Bilbao          |
| - Ireland  | - FRC. Dublín           |
| - Portugal | - IPIMAR Lisbon         |
| - England  | - CEFAS. Lowestoft      |
| - France   | - IFREMER (Lorient)     |

The otolith sections should be viewed with a binocular microscope on a black background under reflected light. Otolith interpretation commences at the nucleus and proceeds to the edge and the first of January is conventionally adopted as hake birthday.

To minimise the bias between readers and the risk of errors is recommended to follow rules for reading the otoliths. The observation of the section for ageing will be as follows:

1- Annual growth cycle consist in one opaque and one translucent or hyaline zone under reflected light but for counting the hyaline rings will be take into account.

2- In the samples the rings considered for age estimations should be measured in order to know whether the readers count the same rings or not. According with this, the radius of every annual ring will be measured following the axis indicated in the drawing below.

**D = Diameter of the section**

**R1= Radius of the first hyaline ring**

**R2 =Radius of the second hyaline ring**

**ch = Check (is quite frequent)**

**R3= Radius of the third hyaline ring**

.....

**Rt = Radius of the total section**

*These two rings are not always visible:*

**P = Ring called “Pelagic” very characteristic ring before the first annual ring**

**r = another peculiar ring called “Recruitment ring”.**

3- Due to take measurements of every ring is hard and time consuming, we suggest to measure only the first three rings and the **P, r, Ch** (when they are seen) and **D from the otoliths section belonged to IEO Vigo collection (1-18) slides**. The measurements should be taken from the centrum of the otolith to the end of every translucent band or ring.

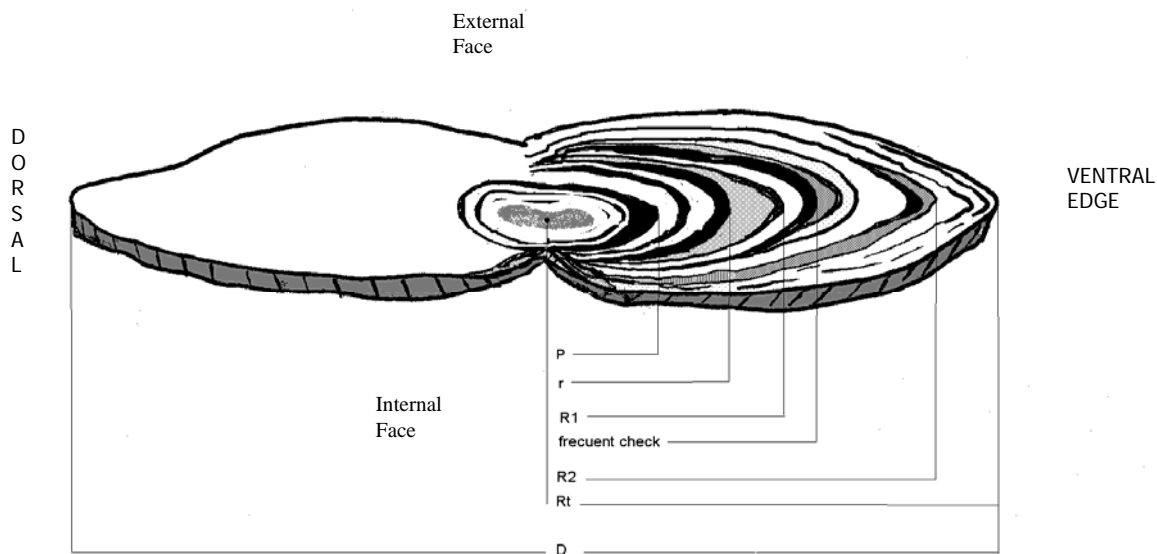

Is very important to situate the first **annual ring** considered by reader because this is one of the main discrepancies between readers. (To consult the Report of Workshop on Hake otolith age reading)

3.-The Magnification used for taking the measurements **will be X.20** and the **units** should be presented in **mm**. The Diameter is the maximal length between one extreme to the other of the section will be measured.

**COUNTING OF THE HYALIN ZONES AND RULES USED FOR AGE ESTIMATION**

Period	Quarter 1	Quarter 2	Quarter 3	Quarter 4
N rings hyaline edge	Age = N	age = N	age = N-1 early winter	age = N-1 early winter
N rings opaque edge	age = N+1 tardy winter	age = N	age = N	age = N

In order to standardise the estimated ages assigned for posterior analyses, the notation will be as follow :

- **hyaline edge** = **1**
- **opaque edge** = **2**
- **Age 2/ edge opaque** = **2 /2**
- **Age 2, not sure** = **2?**
- **Unreadable** = **?**

The slides with blue numbers between 1-18 were prepared in Vigo (IEO), slides 1-9 belong to the ICES Division VIIIc and 10-18 belong to Division IXa. This collection is stored in a plastic and transparent box .

The IFREMER collection is in the black box , the sections are in a black slides belong to different areas: ICES Divisions VIIIc and , VIIIab and VII, but not all of the sections are for reading. The otoliths which have to be read are those indicated in the page form of IFREMER (***IFREMERoto.XLS***). There in every cell appear the number of the black slide (written by pencil) and also the code of otolith that has to be read as well as its location in the slide.

If some of the participants do not have the Report of the last Workshop (June, 1997) that may be interesting to consult it, please ask me, I will send it.

For any problem , please contact to Carmen Piñeiro in Vigo.

➤ The files attached:

- The protocol : ***Hkprtoco98.doc***
- The flow chart of the otolith exchange: ***actividad.ppt***
- For saving the readings from both samples: ***Exhake.xls***
- Information of how to read Ifremer sample: ***IFREMERoto.XLS***

---

Carmen G. Piñero Alvarez  
Instituto Español de Oceanografía  
C. O. de Vigo  
Apartado 1552, 36280 Vigo,  
Spain  
[carmen.pineiro@vi.ieo.es](mailto:carmen.pineiro@vi.ieo.es)  
fax: +34(986) 49 23 51  
telf: +34(986) 49 21 11

**ACTIVITIES FLOW CHART**

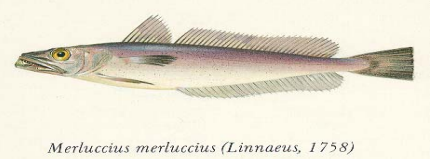

Hake otolith Exchange 98-99

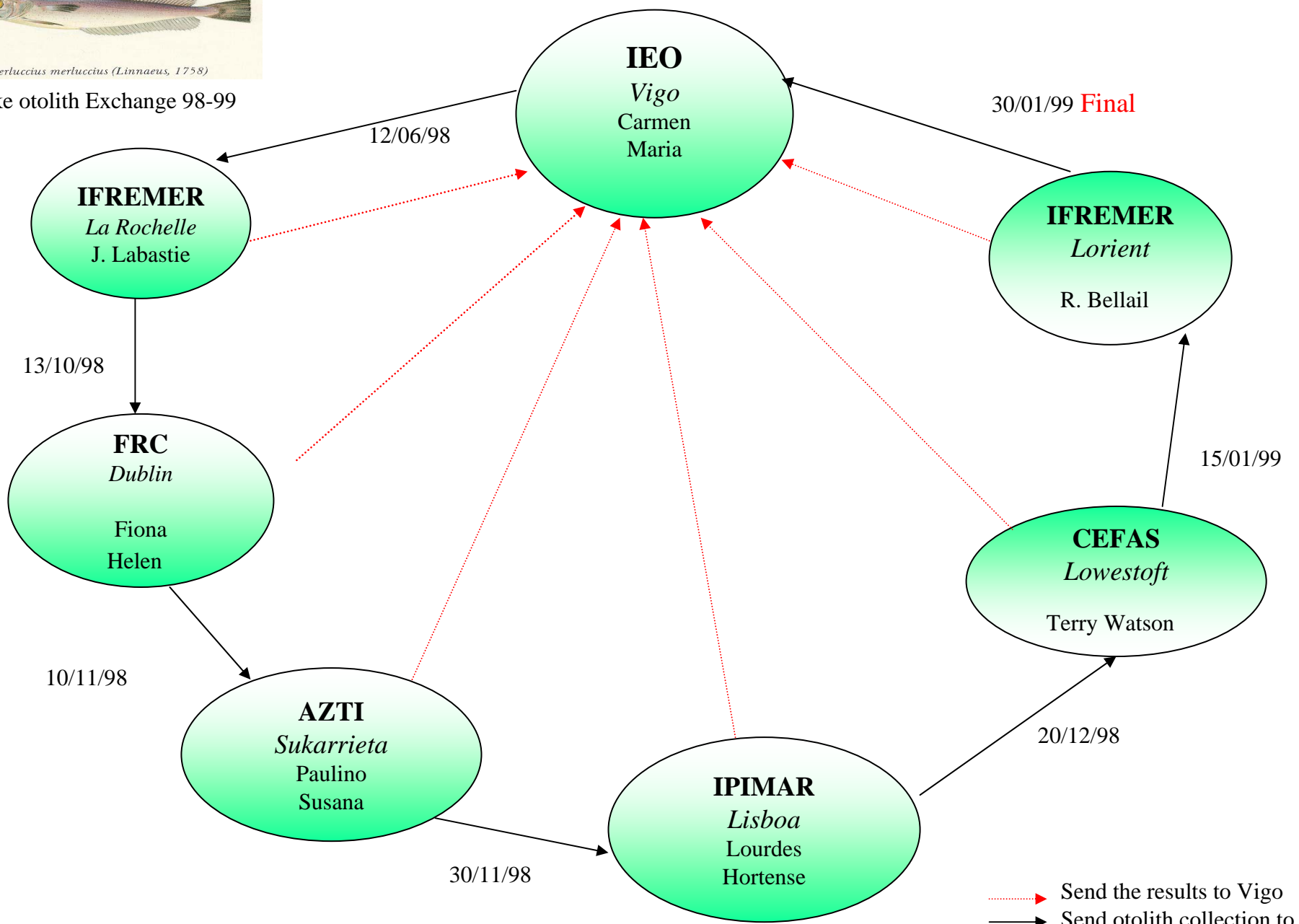

.....> Send the results to Vigo  
——> Send otolith collection to

OTOLITHS VIGO																
1 <sup>st</sup> READING																
SPECIES: HAKE				MONTH : Various				MAGNIFICATIONS: x20				READER:				
				YEAR : 1997				UNITS:				DATE OF READING:				
				AREA : VIIIc + IXa				LIGHT: reflected								
EDGE 1 = Hyaline		SEX: 1 = Male														
2 = Opaque		2 = Female														
3 = Unknown		3 = Indeterminate														
Porte	Code	Month	Sex	Legth	RINGS MEASUREMENT										OBSERVATIONS	
					AGE	EDGE	D	RT	P	r	R1	check	R2	R3		
1	20250	10	1													
	20253	10	1													
	20260	10	1													
	20264	10	2													
	20267	10	2													
2	20272	10	2													
	20275	10	2													
	20279	10	2													
	20289	10	2													
	20301	10	3													
	20302	10	3													
3	20305	10	3													
	20310	10	3													
	20314	10	3													
	20317	10	3													
	20318	10	3													
	20322	10	3													
4	20324	10	3													
	20328	10	3													
	20332	10	3													
	20333	10	3													
	20336	10	3													
	20343	10	1													
5	20347	10	3													
	20356	10	3													
	20358	10	3													
	20359	10	3													
	20361	10	1													
	20362	10	1													
6	20366	10	3													
	20372	10	3													
	20377	10	1													
	20378	10	1													
	20382	10	2													
	20385	10	2													
7	20390	10	1													
	20393	10	2													
	20401	10	2													
	20402	10	2													
20403	10	2														
20404	10	2														

OTOLITHS IFREMER							
<b>Number : 1</b>	Upper level						
Station							
Sex, length							
Age							
	Lower level						
Station	F1	F2	F3	F4	F5	F6	
Sex, length							
Age							
<b>Number : 2</b>	Upper level						
Station							
Sex, length							
Age							
	Lower level						
Station	F7	F8	F9	F10	F11	F18	
Sex, length							
Age							
<b>Number : 3</b>	Upper level						
Station							
Sex, length							
Age							
	Lower level						
Station	F19	F20	F21	F22	F23	F25	
Sex, length							
Age							
<b>Number : 4</b>	Upper level						
Station							
Sex, length							
Age							
	Lower level						
Station	F26		F28			F31	
Sex, length							
Age							
<b>Number : 5</b>	Upper level						
Station							
Sex, length							
Age							
	Lower level						
Station	F32		F34	F35		F55	
Sex, length							
Age							
<b>Number : 6</b>	Upper level						
Station							
Sex, length							
Age							
	Lower level						
Station	F56	F57				F62	
Sex, length							
Age							
<b>Number : 7</b>	Upper level						
Station							
Sex, length							
Age							
	Lower level						
Station	F63	F64	F65				
Sex, length							
Age							

## **Annex II**



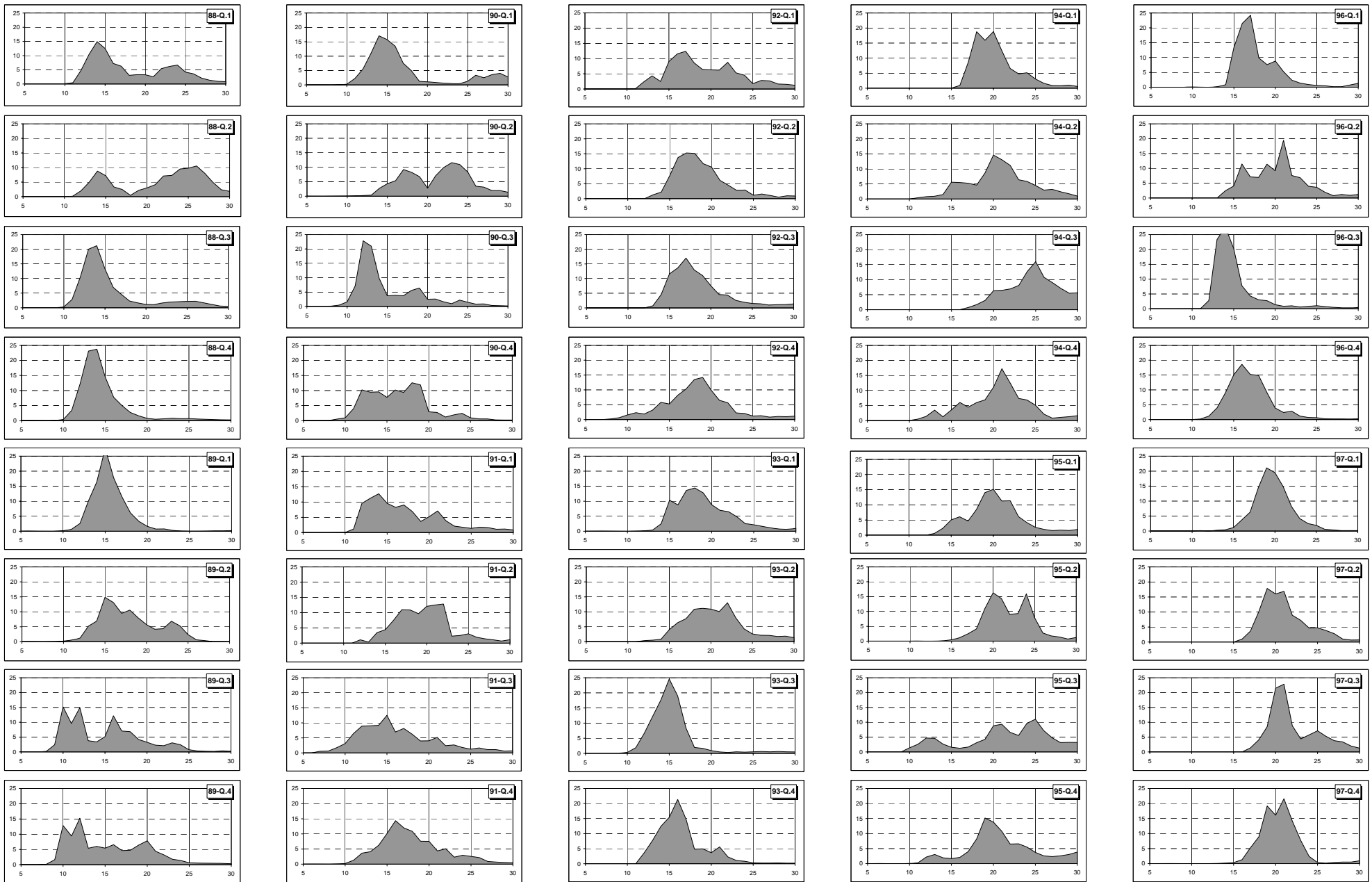

Figure1.- Quarterly Length distributions, in percentages, of juvenile Hake (<30 cm) catches (including discards) by bottom trawlers in the Bay of Biscay, in the period [1988-1997]. (Values for 3rd quarter 1988 have been estimated from 2nd and 4th quarters).

## **Annex III**

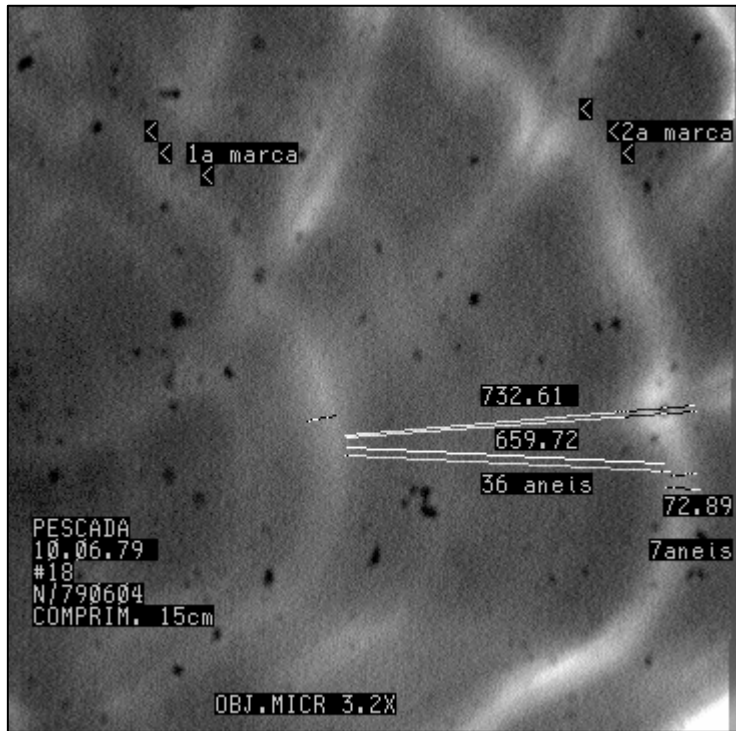

Fig. 5C – Picture showing 1st and 2nd checks



Fig. 5 D – Light microscope picture showing 2nd and 3rd checks

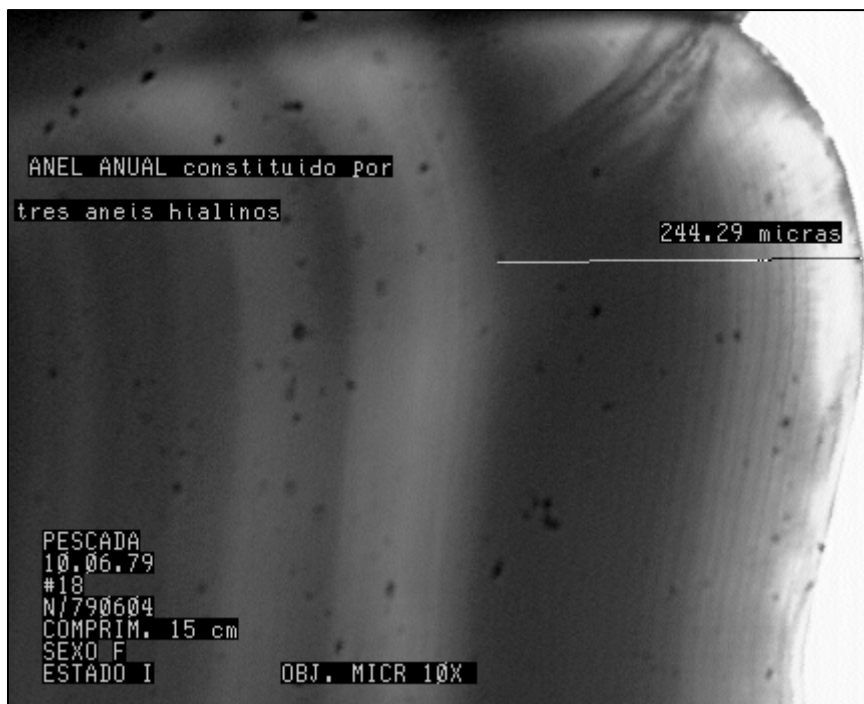

Fig. 5 E – Third Check and Edge of the otolith

Total Length = 19 cm

Short description

Otolith radius = 3985.23  $\mu\text{m}$

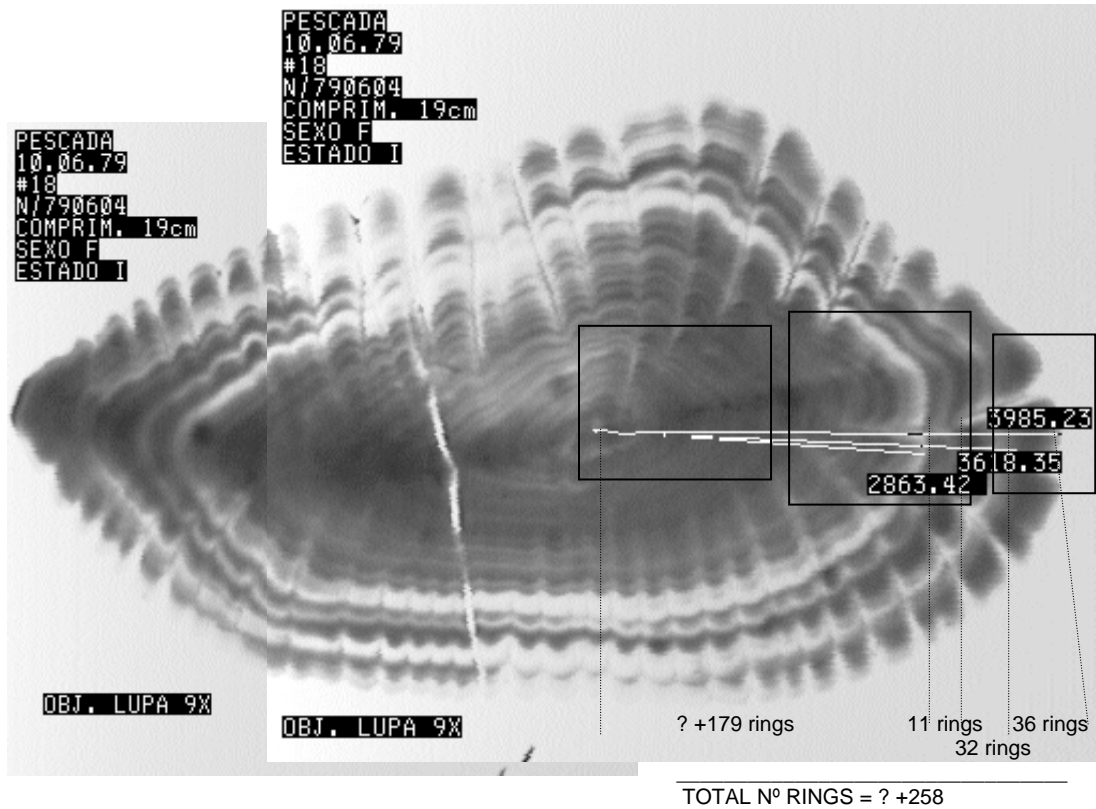

Fig. 6 – Stereomicroscope with 9X objective

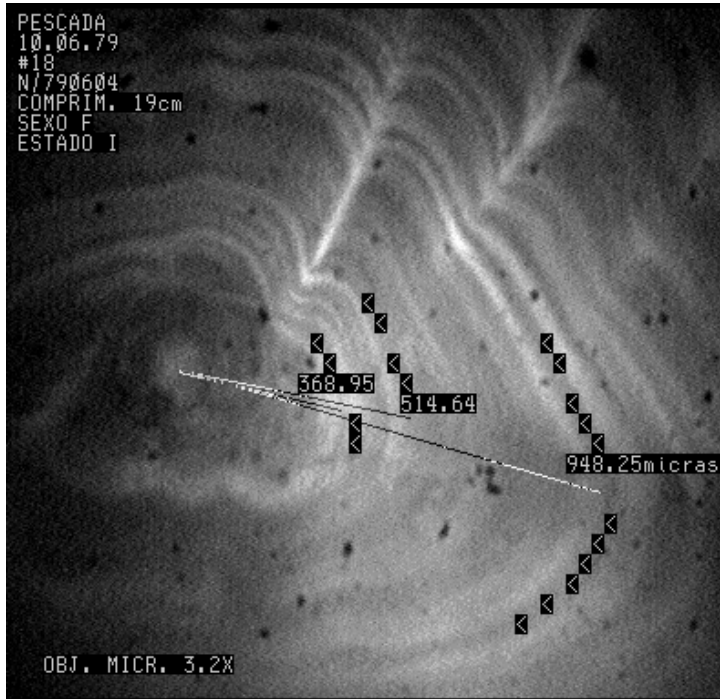

Fig 6 A – Light microscope

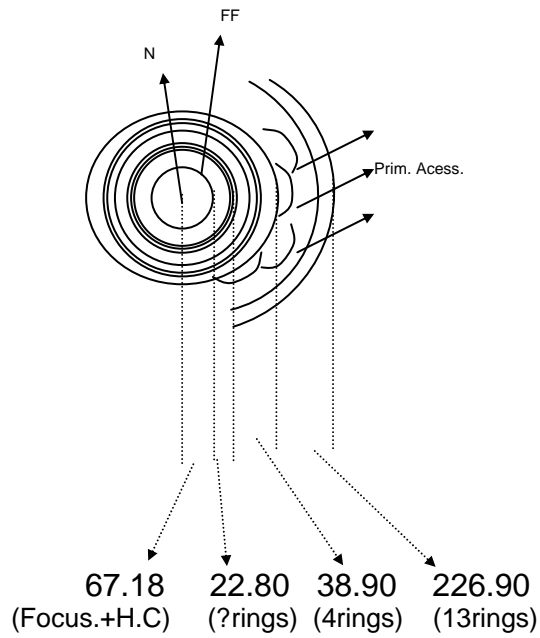

Fig. 6 B – Core and Primordia Assesory interpretation

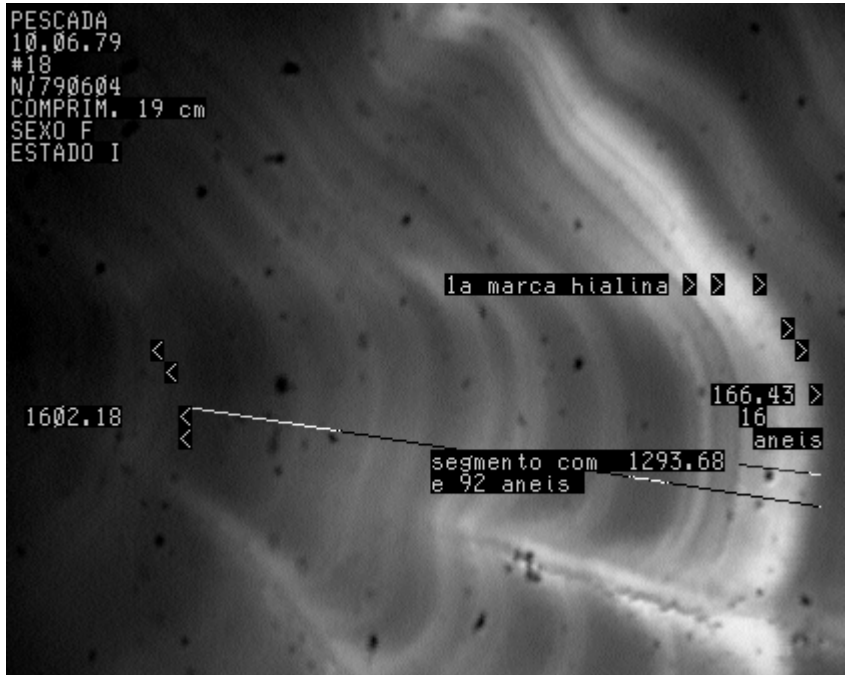

Fig. 6 C- First hyaline check with radius = 2863.42  $\mu\text{m}$

In this otolith we can see one check between the First Check (1<sup>ST</sup> annual ring?) and the 2<sup>nd</sup> Check (2<sup>nd</sup> annual ring?) that after Workshop held in 1997 in Vigo (23-27 June) is called “the Check” that is thought to be several times between 1<sup>st</sup> and 2<sup>nd</sup> annual rings.

Total Length = 20 cm

Short description

Otolith radius = 4133.40  $\mu\text{m}$

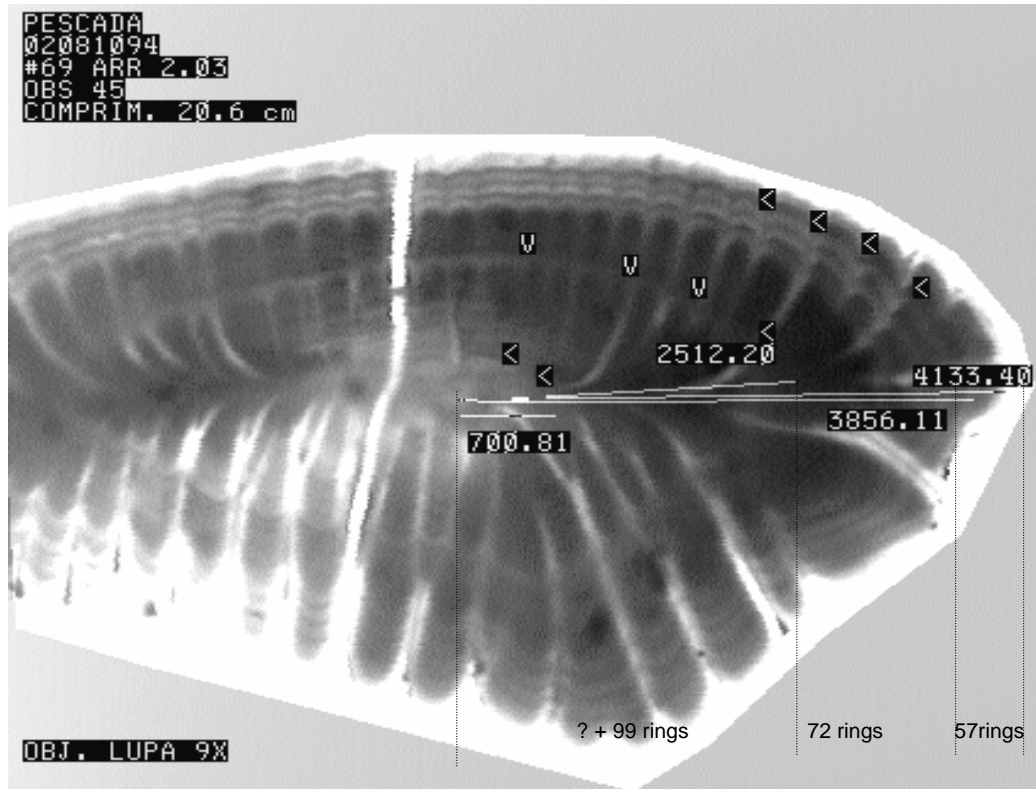

Fig. 7 – Stereomicroscope with 9X objective

Total length = 20 cm

Month June

One hyaline check at 2512.20  $\mu\text{m}$

Hyaline edge



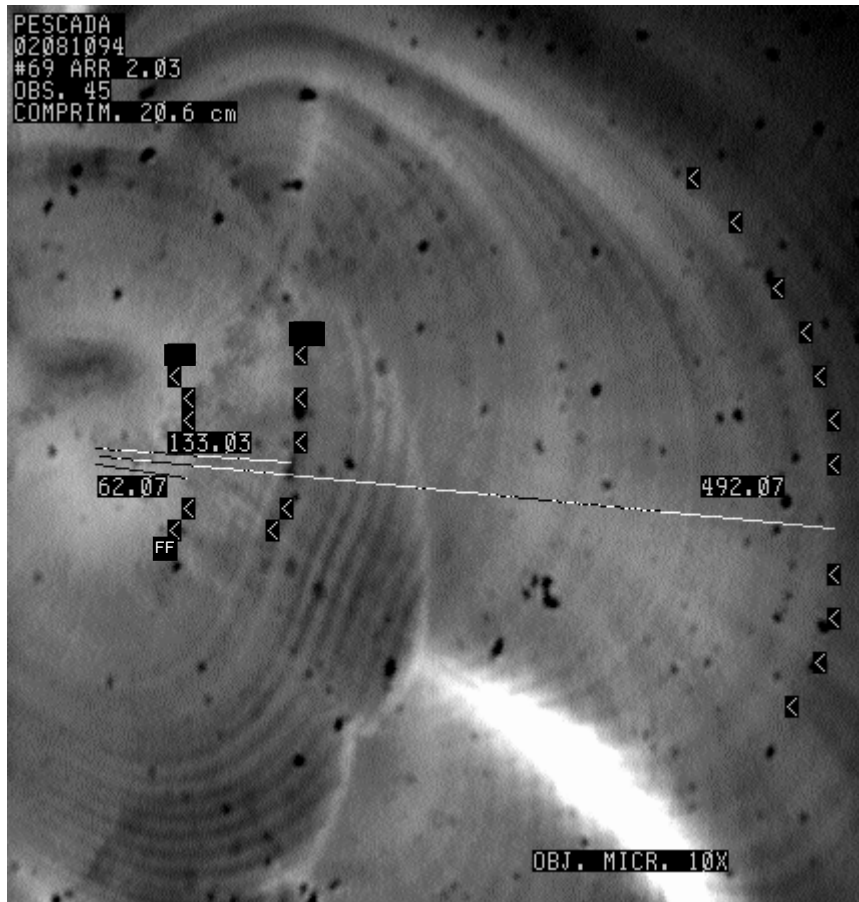

Fig. 7 A – Core and Assesory Primordia picture

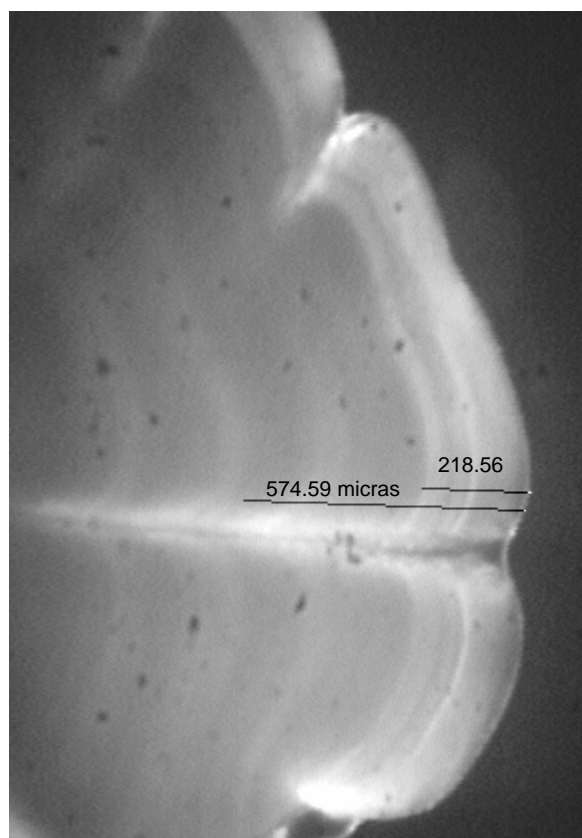

Fig. 7 B – Hyaline Edge with thin 34 daily? rings in a segment of 218.56  $\mu\text{m}$ .

Comparing the measurements and daily ring interpretation

Length (cm)	Month of capture	Core Hatch check	First Feeding		In between		Accessory Primordia		Check		Check		Check		Check		Edge		TOTAL	
			Radius (µm)	Segment (µm)	N° Increm.	Segment (µm)	N° Increm.	Segment (µm)	N° Increm.	Segment (µm)	N° Increm.	Segment (µm)	N° Increm.	Segment (µm)	N° Increm.	Segment (µm)	N° Increm.	Segment (µm)	N° Increm.	OtolR adius(µm)
8	Jun	41.59	29.52	13	61.74	12	346.33	20	577.96	26							495.39	22	1552.53	93
13	Jun	-	-	-	-	-	-	25	1497.72*	59	660.37	24					645.25	24	2799.17	?+132
15	Jun	-	-	-	-	-	-	-	1672.39*	68	732.61	43	385.23	42			244.29	24	2820.74	?+177
19	Jun	-	67.18*	-	60.48	?+4	226.90	13	1602.18	70	1293.68	92	265.62	11	291.67	32	363.14	36	3985.23	?+258
20	Out	-	62.07*	-	70.96	?+6	359.04	20	2098.97	73	1089.00	72					574.79	57	4133.40	?+228

\* Radius instead of segment

# Annex IV

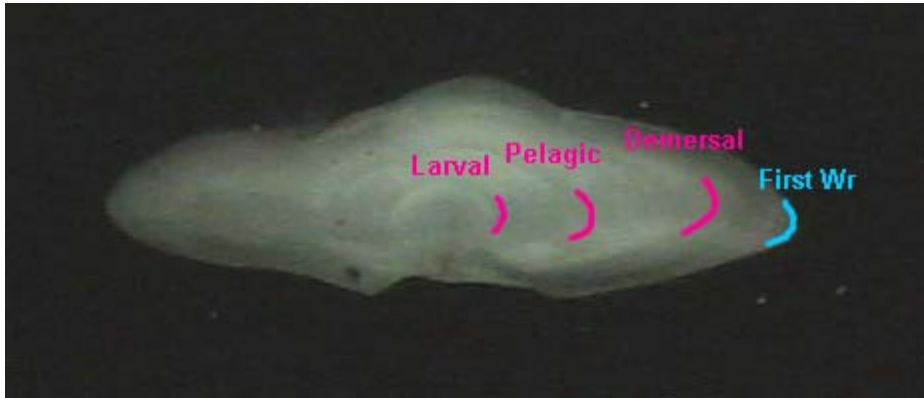

Figure 1.- Otolith from a fish of 13 cm long, caught in October and age 0. The figure show the typical checks before the First winter ring (Wr).

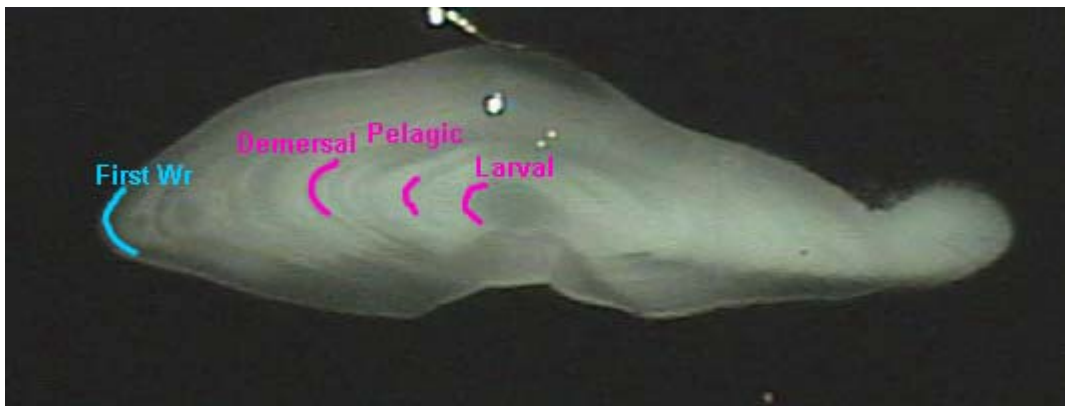

Figure 2.- Otolith from a fish of 19 cm long, caught in January, sex indeterminate and age 1.

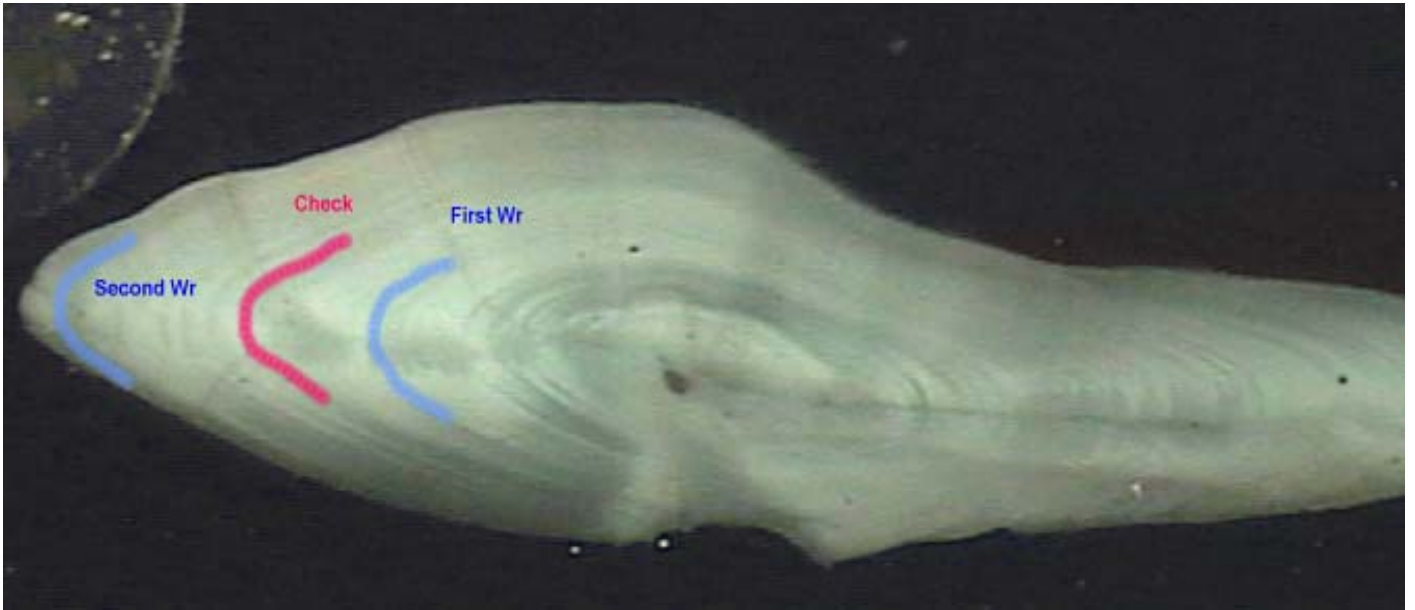

Figure 3.- Otolith from a fish of 32 cm long, caught in November, sex female and age 2.

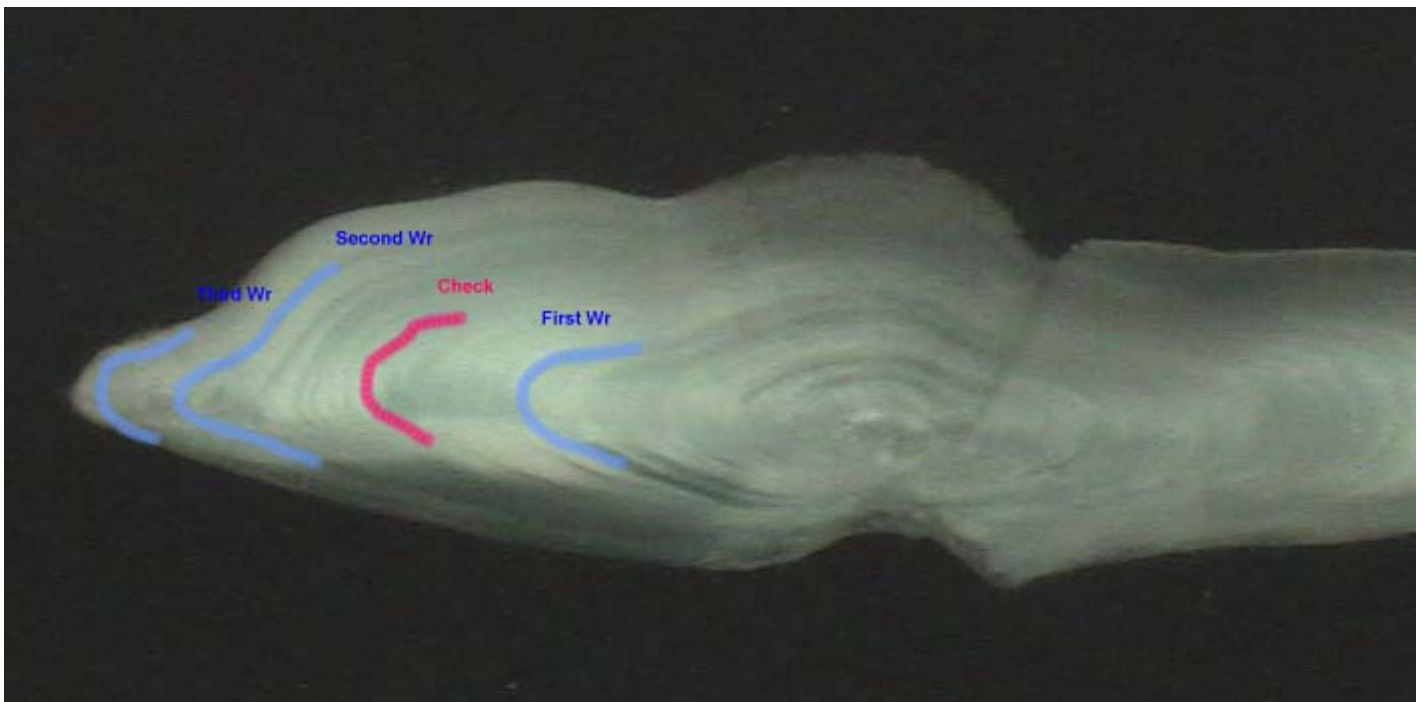

Figure 4.- Otolith from a fish of 40 cm long, caught in November, sex male and age 3.

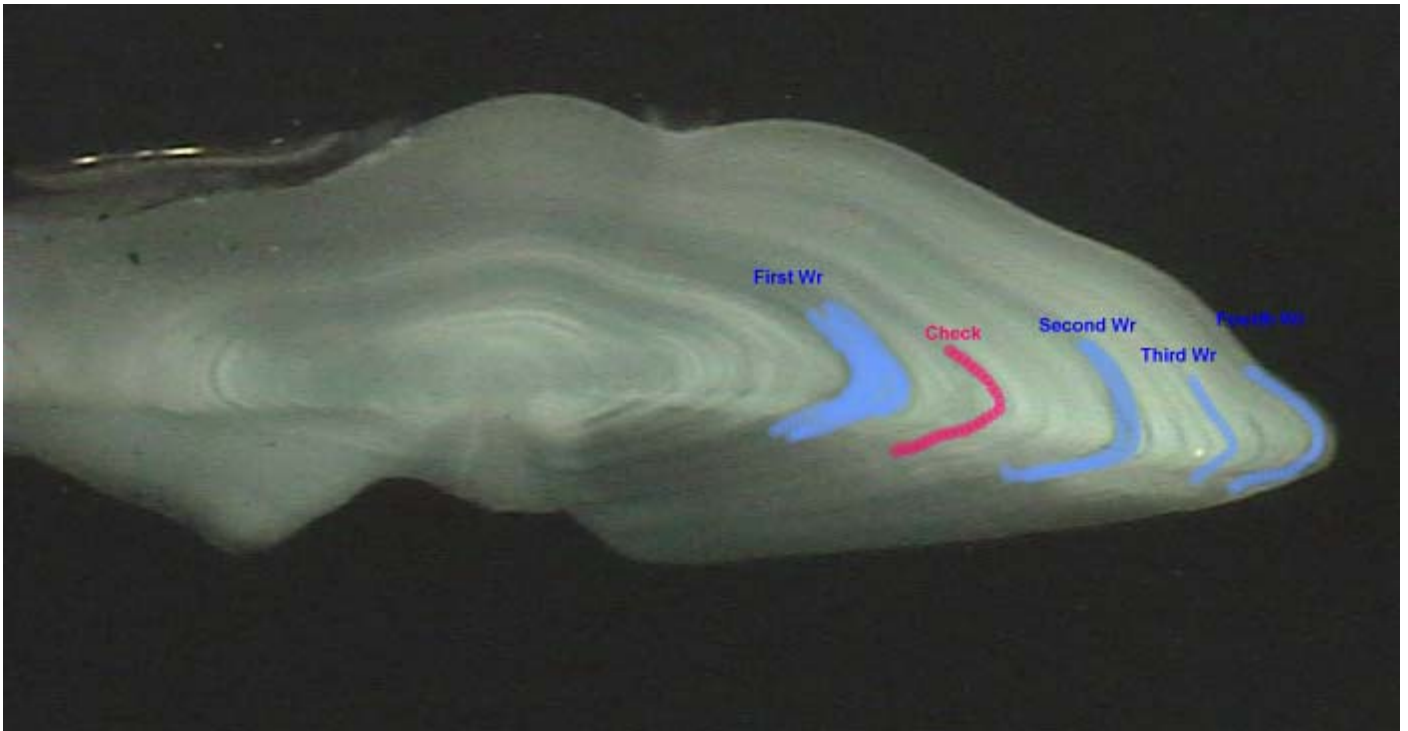

Figure 5.- Otolith from a fish of 41 cm long, caught in January, sex male and age 4.