



## Full Length Article

# Production of fuel-blends from waste tyre and plastic by catalytic and integrated pyrolysis for use in compression ignition (CI) engines

Babalola Aisosa Oni<sup>a,\*</sup>, Samuel Eshorame Sanni<sup>b</sup>, Oluwasanmi S. Olabode<sup>c</sup>

<sup>a</sup> Department of Chemical Engineering, China University of Petroleum, Beijing, China

<sup>b</sup> Department of Chemical Engineering, Covenant University, P.M.B 1023, Ota, Nigeria

<sup>c</sup> Department of Petroleum Engineering, Covenant University, P.M.B 1023, Ota, Nigeria



## ARTICLE INFO

**Keywords:**  
 Pyrolysis  
 Emission  
 Polystyrene  
 Brake thermal efficiency  
 Tyres  
 Plastics

## ABSTRACT

The increase in energy demand and depletion of oil reserves has prompted researchers to seek alternative fuels for compression ignition engines. In this study, the characteristics of the fuels obtained from waste tyres/plastics were determined and compared with those of diesel fuel. The waste plastic oil was obtained from polyethylene terephthalate, polypropylene, high-density polyethylene, polystyrene, low-density polyethylene, and poly (vinyl chloride), thereafter, they were each blended with distilled waste tyre oil from used Dunlop tyres, in different ratios, for use as substitute fuels in a CI engine. The engine (Kirloskar, TAF 1 model) performance was studied based on its combustion, brake thermal efficiency (BTE) and emission characteristics when run on the fuels obtained from the waste-tyres/plastics. The test results showed the engine gave a higher performance in terms of BTE for E (33.9%) and F (36.9%) whereas, others gave lower performance (A- (31.9%), B (30%), C (29.7%), D (32.4%) with respect to diesel fuel. The pyrolyzed Polystyrene/tyre blends gave the highest BTE of 36.9%, with low emission. Although lower emissions were recorded for the blended fuels relative to the diesel fuel, the resulting peak emissions for the blends are in the following increasing order: unburnt HC (B (30.1) < D (30.1) < F (30.2) < A(30.4) < E (30.7) < C(31 ppm), NO<sub>x</sub> (F (1001) < B (1100) < D (1107) < C (1107) < E (1108) < 1150 ppm) and CO (F (0.003) < E (0.004) < B (0.005) < A(0.006) < C(0.007) < D (0.008) ppm.

## 1. Introduction

Currently, the world's growing population and increase in manufacturing activities have spurred the need for high energy demands which has also resulted in a rise in energy consumption [1]. The increasing concerns of the price of fossil fuel, and its environmental implications have obligated several governments, societal investors and policy makers to emphasize on the need for alternative fuels [2]. This has led to the recovery of fuels from wastes obtained from several feedstocks, which are converted into high yield of biofuels through the process of pyrolysis [1,3]. The pyrolyzed liquids are then post-treated for the production of chemicals, heat and power. However, some limitations include, gum formation due to the presence of unstable components, low heating value of the fuels imparted by oxygenated compounds, water content, corrosion due to the formation of organic acids and phase instability which also control the commercialization of renewable fuels obtained from pyrolyzed wastes [1–3].

About 1.7 billion of waste tyres are generated globally [2–3]; the

stages involved in processing the waste tyres, include pyrolysis, mechanical grinding, tyre re-treading, landfill, etc. [2,4]. Although, due to unavailability of landfill space and large fires at stockpiles, these practices are constrained. Generally, waste tyres are nonbiodegradable and give off poisonous gases when burnt in incinerators thus constituting environmental nuisance [3,5]. The products obtained from pyrolyzed waste tyres are oil, char, released gas, residual products and steel [4].

One of the most effective and reasonable ways to post-treat waste tyres with minimal or no pollution is by pyrolysis in rotary kiln, fixed bed (batch), fluidized bed, vacuum and moving screw bed [2,5]; the fixed bed reactor is the most common one which is operated at 450–700 °C under nitrogen atmosphere [6] to give products such as liquid (21–60 wt%), solid (26–48 wt%) which can be used as fuel or converted to carbon, and 10–27 wt% C<sub>1</sub>–C<sub>4</sub>/gases which can serve as fuel heat-source during pyrolysis [4,6]. Furthermore, the pyrolyzed oil is blended with regular fuel or improved upon to obtain petroleum-grade products. Oil from waste tyre pyrolysis, has similar properties with those of petroleum diesel; it contains 1.39 wt% sulphur and 0.44 wt% nitrogen

\* Corresponding author.

E-mail address: [babalola.oni@covenantuniversity.edu.ng](mailto:babalola.oni@covenantuniversity.edu.ng) (B.A. Oni).

<https://doi.org/10.1016/j.fuel.2021.120801>

Received 8 January 2021; Received in revised form 29 March 2021; Accepted 31 March 2021

Available online 13 April 2021

0016-2361/© 2021 Elsevier Ltd. All rights reserved.

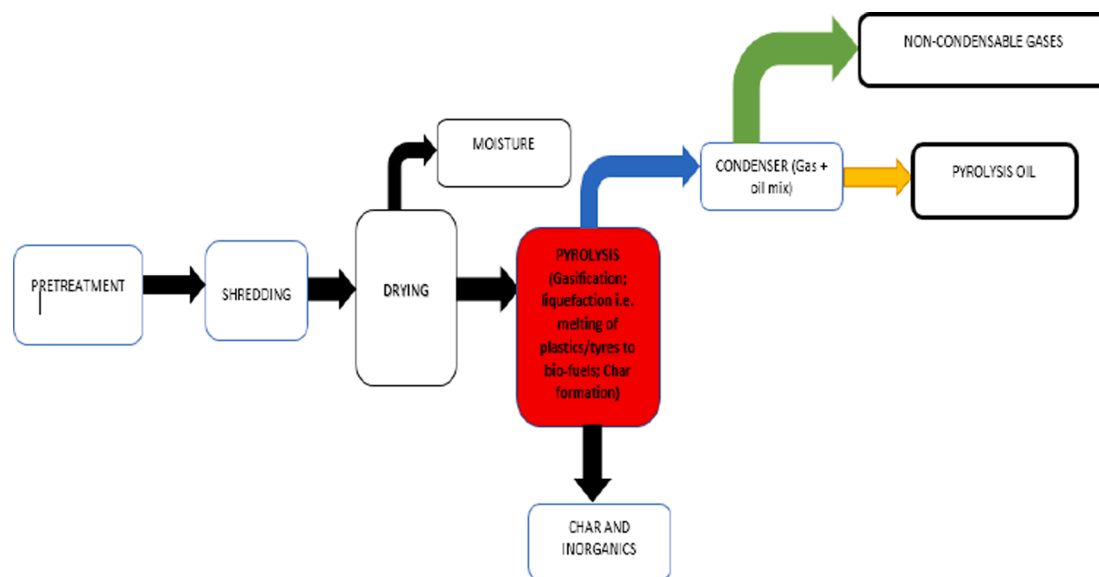

Fig. 1. Steps involved in processing waste tyres and plastics to biofuels.

[5–7]. Several researches have been carried out on blending pyrolyzed tyre oils with diesel fuels for use in CI engines. Pyrolyzed waste tyre oil is usually blended with about 88% diesel fuels without further modification, however, pre-treatment measures, such as desulphurisation, moisture removal/vacuum distillation are essential [8–11].

Nabi et al. [1] demonstrated that the specific fuel consumption (SFC) of B10 (10 percent pyrolyzed waste tyre oil/90 percent diesel fuel) was comparable to that of diesel fuel at 100 percent load, however, for B20-50 waste tyre/diesel fuel blends, the SFCs were higher with lower BTEs. Murugan et al. [3] pyrolyzed waste tyre oil/diesel fuel-blend in a direct injection (DI) diesel engine; lower BTEs, higher HRR, longer ignition delays and peak pressure were recorded for increased PTO in the diesel fuel thus, giving 22% NO<sub>x</sub> reduction, poor smoke quality, HCs and CO. Murugan et al. [4] observed similar combustion, emission and performance characteristics of a single-cylinder air cooled direct ignition engine operated with high and low percentage of blended distilled waste tyre pyrolytic oil/diesel and standard diesel.

The emission and performance characteristics of a turbocharged, 4-cylinder, intercooled, 4 S, 2.0 L Nissan diesel automotive engine operating on 5% vol waste tyre pyrolyzed fuel and diesel blend were determined. The BTE and BSFC for both fuels, were found to be nearly equal at full load [6]. In a recent study, 5% dibutyl-maleate (DBM) was blended with waste tyre pyrolytic oil/diesel and the results showed low NO<sub>x</sub> CO, CO<sub>2</sub> and HC emissions. Wang et al. [8] pyrolyzed waste tyres in a lab-scale fixed bed reactor at various reaction temperatures and blended the oils obtained with diesel fuels in various proportions. When the oils were tested in a CI-engine, an increase in the amount of waste tyre pyrolytic oil in the diesel fuels, resulted in low engine performance, hence, they recommended heating at higher pyrolysis-temperatures for improved results.

Some draw backs associated with the use of waste tyre pyrolytic oils in diesel engines include, low BTEs and high NO<sub>x</sub> emissions, caused by the presence of water, sulphur and other heavier components which ought to be removed before mixing them with standard fuels. Therefore, there is need to optimize the blends towards abating these short comings.

Plastics are generally non-biodegradable polymers which contain mainly hydrogen, and carbon. Hence, plastic wastes from municipal and industrial sources, contribute immensely to the problem of waste management [12–14]. Globally, about 130 million tonnes of plastics are manufactured yearly with 78 million tonnes sourced from petroleum. Also, 78% of all plastic wastes constitute thermoplastics; the remaining

is from thermosets. However, the inclusion of epoxy resins and polyurethanes in plastics, makes thermoset-recycling herculean [15].

Plastic wastes can be broken down through pyrolysis to give solids (small amount), liquids, and gases. The product quality from pyrolysis depends on the waste plastic-type and process parameters (residence time, temperature, and catalyst) [16,17]. Depending on the conditions of pyrolysis, the average oil yield of waste plastics ranges from 45 to 50% [15] with about 82 wt% yield. There are also proposals that the pyrolysis oil can be valorised and distilled into fractions of different boiling points [14,18]. The quality of pyrolysis oil can be improved by hydro-catalytic treatment. Catalytic conversion of plastic wastes often occurs at lower pyrolysis temperature and reaction time thus, giving a comparative increase in fuel yield and quality with respect to diesel fuel [19–22]. Anup et al. [23] also concluded that a petrol engine operating on waste plastic pyrolysis oil, can give up to 50% BTE of that obtained with diesel standard fuel.

The most common and frequently consumed plastics, include, High density polyethylene (HDPE), Low density polyethylene (LDPE), polypropylene (PP), polystyrene (PS), poly(vinyl chloride) (PVC) and PE terephthalate which constitute environmental nuisance when not adequately disposed, hence, the objective of this research is to harvest the best plastic-type that will augment the lapses of the ordinary waste tyre oils and thus improve the fuel properties of the blends in terms of performance, combustion and emission characteristics when compared with those of conventional diesel fuels. This aspect of research, has not been given full consideration and focus by other published literature. Therefore, the research aims at optimizing the waste tyre oils of different plastic and diesel oil blends, in order to compare their performance with those of standard diesel fuel. Prior blending, several preliminary assessments such as performance, combustion and emission characteristics of High density polyethylene (HDPE), Low density polyethylene (LDPE), polypropylene (PP), polystyrene (PS), and poly (vinyl chloride) (PVC) and PE terephthalate plastic oils, were also conducted in order to establish the properties of the waste tyre oils that will give the best blend for optimum engine performance.

## 2. Method

The car tyres used in this research are (Dunlop tyres) which were cut into different sizes and shapes; thereafter, the fabrics and steel wires were removed. The cut tyres were washed, dried, and fed in a fixed bed reactor unit made of mild steel. The pyrolysis steps are shown in Fig. 1.



Fig. 2. (a) Crude waste tyre pyrolysis oil (b) Distilled waste tyre pyrolysis oil.

The waste tyre was heated externally in a reactor in the absence of air. The reactor design for the pyrolysis experiment is a chamber which is cylindrical in shape with inner and outer diameters of 110 and 115 mm, with height of 300 mm and full insulation. For external heating, 2 kW power was supplied to the reactor. The reaction was carried out at 450–650 °C at a constant heating rate of 5 K/minutes for 120 min residence time of the reactor feedstock. The pyrolytic product(s) which were in form of vapour were transferred to a cooling condenser so as to be collected as liquid fuels. The products obtained from pyrolysis include tyre pyrolysis oil (TPO), pyro-gas, and char. About 4 kg of waste tyre produced 1 kg of tyre pyrolysis oil. The heat energy needed for the process per kilogram of oil produced was about 6.2 MJ/kg.

The stages involved in pyrolysis include gasification (formation of gases); liquefaction of the waste tyres or plastics to bio-oils and char formation.

### 2.1. Improving the crude tyre pyrolysis oil (TPO)

There are three stages involved in the tyre-oil conversion process (a) Moisture removal (b) desulphurisation and (c) Distillation [10]; the pyrolyzed oil from the waste tyres was also subjected to these processes.

During moisture removal, the crude tyre pyrolysis oil was heated at 100 °C in a vessel for about 1 h prior to further chemical treatment. However, the crude tyre oil free from moisture, contained some impurities of sulphur and carbon. A specific volume of H<sub>2</sub>SO<sub>4</sub> was first homogenised with the crude tyre oil and the mixture was carefully agitated for 24 h in order to ensure proper separation of the mix into two distinct layers. The top and bottom layers consisted of a thin mixture and thick sludge respectively. The top layer was carefully collected for further processing in a distillation unit, while the sludge was discarded. The sulphur removed by desulphurisation accounted for about 95.3% of the sulphur in the oil. The desulphurized sample was heated at 1 kW in an enclosed chamber. The vapour leaving the chamber was condensed and the distilled pyrolysis waste tyre oil was collected in a separate glassware. The resulting non-condensable vapours were vented to the atmosphere. The crude pyrolytic tyre oil was distilled at 150–200 °C as seen from literature; samples of the oils recovered via pyrolysis are as shown in Fig. 2a. Nitrogen gas was supplied to create an inert environment for the reactor. 87% of pyrolytic tyre oil (TPO) was distilled to obtain the distilled pyrolytic tyre oil (DPTO) (Fig. 2b), while 3% of TPO was received as pyro gas and 10% as sludge. After the intended modifications (removal of water and sulphur content and other heavier components) were carried out on the pyrolytic tyre oils, the oils were

blended with the waste plastic oils in a diesel engine.

### 2.2. Plastic pyrolysis

Various grades of waste plastics were collected for the purpose of this research. The plastic wastes were thoroughly cleaned with water and detergent to remove the unwanted materials. The cleaned waste plastics were dried and cut into small pieces using scissors, 10 kg of each plastic-type was used for pyrolysis. These plastics were carefully identified and separated into different plastic-types. The plastics considered for thermal pyrolysis include Low density polyethylene (LDPE), polypropylene (PP), poly (vinyl chloride) (PVC), High density polyethylene (HDPE), polyethylene terephthalate (PET) and polystyrene (PS).

The shredded plastics of poly (vinyl chloride) (PVC), Low density polyethylene (LDPE), polypropylene (PP), High density polyethylene (HDPE), polystyrene (PS), and polyethylene terephthalate (PET) were heated at different times while ensuring the reactor was well-cleaned and free of any material prior each test. The reactor was operated at different temperatures and pressures.

The fuel properties illustrated could not give the desired specification of fuels needed to effectively run the diesel engine, hence, in order to abate the poor performance and high emissions, there was need to blend the pyrolytic plastic fuels with those of the distilled tyre oils. Thereafter, the oils were compared with those of the diesel fuels in a diesel engine. The various blends that were carefully selected after series of tests in the diesel engine contained in a latter section.

### 2.3. The fuel-blending process

The test-fuels were blended in a homogenizer, operated at 2000 rpm for about 20 min. The homogenization was done at applicable speeds in order to obtain the apt fuel-blends; the fuel-blends were then compared to diesel fuels. Series of analyses were conducted on the different grades of pyrolytic plastic fuels on vol./vol. basis, with the pyrolytic tyre fuels. Thereafter, they were blended with the pyrolytic tyre fuels (of different proportions by volume) in order to ascertain the best fuels that will give apt properties that are comparable with those of standard diesel fuels, in terms of better emission, performance and combustion characteristics. Based on the preliminary tests conducted in trials of five (5) runs; the result of the best test fuels are as follows: PET/DTO (42.5/57.5 v/v) -A, HDPE/DTO (40.3/59.7 v/v) - B, PVC/DTO (46.1/53.9 v/v) - C, LDPE/DTO (39.6/60.4 v/v) - D, PP/DTO (38.2/61.8 v/v)- E, PS/ DTO (44.7/ 55.3 v/v) -F.

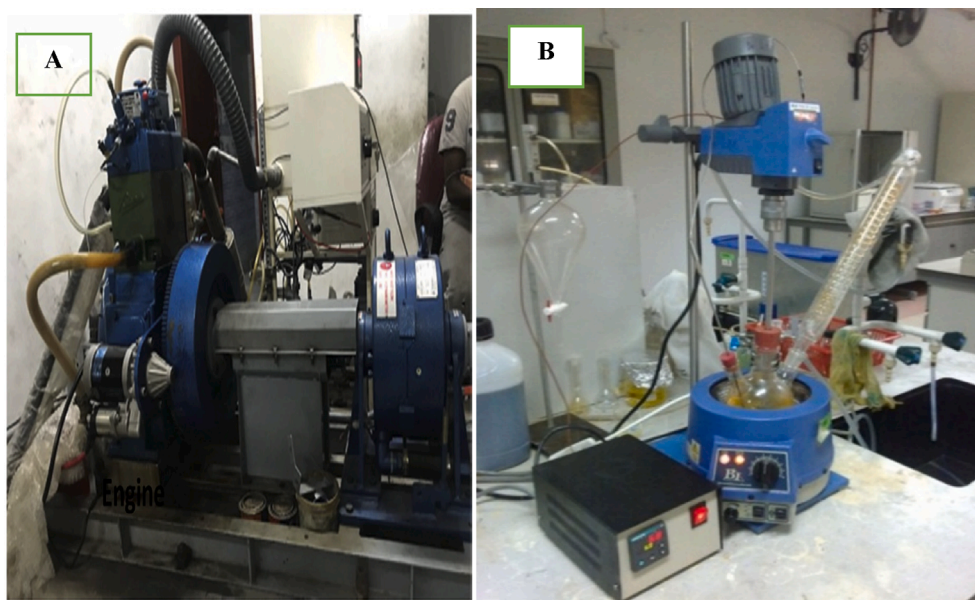

Fig. 3. (a) Test engine (b) Experimental set-up for WPO. The experimental set – up of pyrolyzed tyre oil is illustrated in the supplementary section (S1).

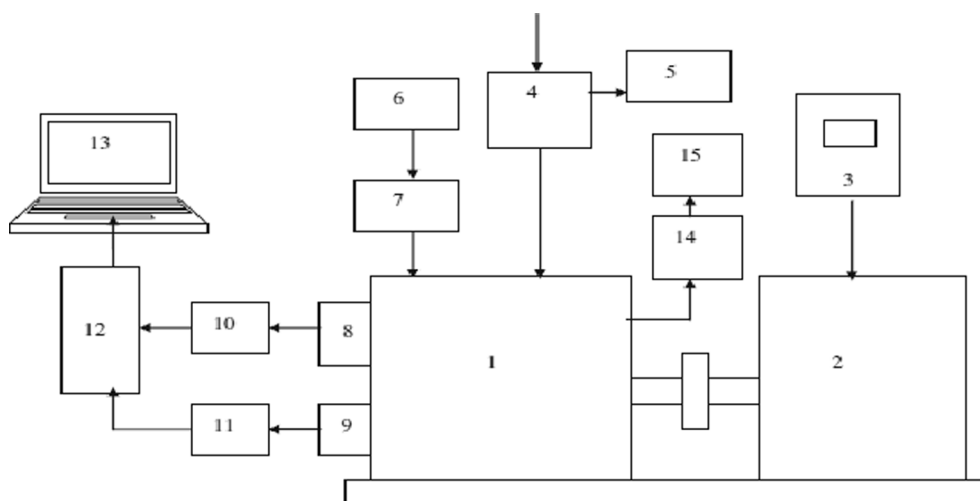

Fig. 4. Test engine. [1]- Kirloskar, TAF 1 model Engine; [2]- An Alternator; [3]- Dynamometer; [4]- Air box; [5]- Manometer; [6]- Fuel tank; [7]- Fuel measurement flask; [8]- Pickup Pressure; [9]- TDC sensor; [10]- Amplifier; [11]- TDC amplifier circuit; [12]- A/D card; [13]- Computer; [14]- Gas analyser; [15]- Smoke meter.

Table 1  
Engine specifications.

Engine type	Kirloskar, TAF 1 model
Number of cylinders	1
Piston	Shallow bowl-in-type
Bore, mm	87.5
Combustion chamber	Hemispherical open type
Needle lift, mm	0.25
Connecting rod length, mm	220
Cone angle °	110
Swept volume, cm <sup>3</sup>	661
Stroke, mm	110
Clearance volume, cm <sup>3</sup>	36.87
Compression ratio	17.5:1
Injection type	Direct injection
Rated power, kW	4.4
Injection duration, °CA	20–30
Rated speed, rpm	1500
Number of nozzle holes	3
Injection timing, °CA bTDC	23
Injection pressure, bar	210

The experimental set-up is as shown in Fig. 3. The test engine, Kirloskar, TAF 1 model is illustrated in Fig. 4; Table 1 gives the engine specification. The Engine was run on diesel fuel for about 15 min, thereafter, the engine was evacuated and the blends were used to fuel

Table 2  
Engine instrument details.

Instrument	Quantity measured	Measuring techniques
5-kVA AC alternator (1500 rpm/ 220V electrical dynamometer)	Load	Strain gauge type load cell
AVL Di-gas 444 exhaust gas analyser	CO HC NOx	NDIR FID CLD
AVL 437C smoke meter	Smoke capacity	NDIR
Stop watch, Electronic weighing scale,	Fuel consumption rate	Digital counter/ Load cell

NDIR- Non-dispersive infra-red; FID- Flame ionization detector; CLD- Chemiluminescence detector.



**Table 3**  
Instrument uncertainties.

Name of instrument	Measured quantity	Accuracy	Range	Uncertainties (%)
Stop watch	Time	±0.6 s	–	±0.2%
AVL Di-gas 444 analyser	HC	±10 ppm	0–20000 ppm	±0.1%
	NOx	±10 ppm	0–5000 ppm	±0.5%
	CO	±0.03%	0–10% vol.	±0.3%
Burette	Fuel quantity	±0.1 cc	0–1000 cc	±1.0%
AVL 437C smoke meter	Smoke opacity	±0.1%	0–10 FSN	±1.0%
Speed sensor	Engine speed	±10 ppm	0–10,000 rpm	±0.1%
Crank angle encoder			720 × 0.5 °CA	0.5 °CA
Pressure transducer			0–250 bar	<±0.02 FSO

the engine and run for about 30 min. The procedure was repeated for all blends. The engine was run at several engine loads based on the SAE J1515 MAR88 standard in order to obtain the engine combustion, performance and emission data. Engine tests were carried out at brake mean effective pressures (bmepp) of 1.3, 2.6, 3.9 and 5.3 bar which correspond to 25, 50, 75 and 100% loads. The Kirloskar, TAF 1 model diesel engine properties were checked by means of a controller connected through a personal computer to the engine test-bed. An AVL Di-gas 444 exhaust gas analyser was used to measure the emission properties. The gas analyser specifications are as shown in Table 2 and the instrumentation is specified in Table 3.

### 3. Results and discussion

#### 3.1. Properties of oils/fuel yields from pyrolysis of waste tyre and plastic fuels tested

##### 3.1.1. Products from waste tyre pyrolysis

Based on the quantity of products received per kilogram of pyrolyzed waste tyre, 0.56 kg of the entire product received was waste tyre oil, 0.33 kg was the weight of the residue/char, 0.10 kg of pyro gas was produced while 0.01 kg of moisture was also recovered. Hence, considering the amount or weight of oil per kg of waste tyre used, the percentage yield of the products from waste tyre pyrolysis are 0.56 kg oil/kg waste tyre (56%), 0.33 kg char/kg waste tyre (33%), 0.10 kg (10%) gas/kg waste tyre and 0.01 kg (1%) moisture/kg waste tyre. This further informs that the most dominant product of the waste tyre pyrolysis is waste tyre oil. The method of calculation can be seen in the supplementary section (S2).

##### 3.1.2. Products from waste plastic pyrolysis

The oil and gas yields from the pyrolysis of waste plastics is illustrated in Table 4; the results were obtained by following the procedures established in refs. [17–22], while taking into consideration, the type of reactor used and the temperature conditions (380–520 °C). PS gave the highest oil yield (93.3%) while PVC gave the lowest oil yield (15.7%). The high oil yield from polystyrene may be due it having the weakest

**Table 4**  
Pyrolysis/oil yield of plastics.

Types of plastics	Reactor	Temp. °C	Press.	Duration	Oil wt. % yield	Gas yield	Solid wt.%	Method used.
PET	–	500	1 atm.	–	55.91	26.1	17.99	[17]
HDPE	Semi- batch	400	–	–	84.1	14.9	1.00	[18]
PVC	Vacuum batch	520	–	–	74.71	0.22	25.07	[19]
LDPE	Pressurized batch	425	–	60	91.2	7.8	1	[20]
PP	Batch	380	–	–	83.5	5.5	11	[21]
PS	Semi- batch	400	–	–	93.2	4.8	2	[22]

binding forces that hold the molecules together within its molecular structure, when it is subjected to heat [22,27]. In decreasing order of oil yield, the results are as follows: PS > LPDE > HDPE > PP > PET > PVC.

#### 3.1.3. Properties of the unblended waste plastic and distilled tyre oil

**3.1.3.1. Densities, calorific values and cetane numbers and water content of the oils.** The densities of the oils are in the following order of increasing densities; HDPE (791) < PET(797) < PP(799) < PVC(800) < LDPE(805) < PS(807), < DTO (808) kg/m<sup>3</sup>; PS is the second most dense oil, while DTO is the densest, the densities of PET and PS corroborate the findings of refs. [17] and [22] respectively. The calorific values of the fuels show that PS has the highest calorific value (42,000 MJ/kg) owing to the weaker intermolecular forces binding the molecules of the plastics together relative to that of the LDPE whose calorific value is 41,700 MJ/kg as shown in Table 5. For the cetane number of the fuels, PS, PP and PVC had similar cetane number of 53 as compared to 54 for diesel fuel, while others had cetane numbers less than 53, this is in line with the findings in refs. [21,28]. All plastics considered had water contents in the range of 304–790 with the lowest being 304 for DTO and the highest value is 790 for PET. The water content of the plastic oils is indicative of the reason PS and DTO had the closest calorific values amongst all plastic oils, hence giving a clue to their relative properties and the advantage they will offer if blended.

**3.1.3.2. Flash point, acid number, kinematic viscosities and pour points of the oils.** The flash point of an oil is a measure of the temperature at which the oil goes into vapour phase when in contact with an igniting source. All the oils had comparative flash points ranging from 52 to 55 °C, this justifies the findings of ref. [28], with PS having the highest flashpoint amongst all the waste plastic oils, although, its flash point was found to be 3 °C less than the flash point (57 °C) of the conventional diesel fuel. Acid number is a function of the resistance of an oil to oxidation; the lower the acid value, the better the oil's stability. Again, the acid value of the waste plastic oils, range from 0 to 21 mg KOH/g oil, with that of PS and DTO being the lowest (i.e. 5 mg KOH/g oil). Oils of higher acid values have the tendencies to go rancid earlier than oils with lower acid values. Based on the recorded kinematic viscosities (i.e. ratios of viscosities/densities) in Table 5, the ratio of the viscosities to densities of PET, HDPE, PP, PS, and DTO are lower relative to those of PVC, LDPE, and diesel with kinematic viscosities of 2.1, 2.4, and 2.62 respectively, hence, less dense oils are less viscous relative to denser oils which makes the former able to flow easily relative to the latter. Pour point is a measure of the lowest temperature at which an oil will flow. The pour points of the fuels were found to be in the following increasing order of magnitude: PVC (–5 °C) < diesel fuel (–40C) < HDPE(–20C) < PS(–1), < PTE–LDPE–PP(10C)each < DTO(2 °C).

**3.1.3.3. Ash content, aromatics and carbon content.** The ash contents of all the oils have relationships with their burning potentials, as oils with less ash will burn almost completely with less residue. The ash content of PS is the lowest amongst all the WPOs, however, this value is lower than that of the diesel oil which is < 0.001. For the aromatic contents of the oils, PS had the closest aromatic content with respect to that of the diesel fuel, with their values being 29.2 and 29.5 respectively; the implication

**Table 5**  
Properties of waste plastic fuels, Distilled tyre oil and diesel fuels.

Parameter	Method	PET	HDPE	PVC	LDPE	PP	PS	DTO	Diesel
Density(kg/m <sup>3</sup> )	ASTM D4052	797	791	800	805	799	807	808	811
Calorific value(MJ/kg)	ASTM D240	41,880	41,790	41,850	41,700	41,500	42,000	41,900	42,000
Cetane number	D613-84	51	52	53	51	53	53	52	54
Water content (mg/g)	ASTM D6304	790	756	762	456	474	366	304	65
Flash point	ASTM D93	55	53	52	54	53	55	54	57
Acid number (mg KOH/g)	IP 139	21	15	9	6	11	5	5	0
Kinematic viscosity @ 40	D445-04E02	1.198	1.955	2.1	2.4	1.86	1.92	1.77	2.62
Ash content	IP 391	0.106	0.104	0.106	0.092	0.098	0.081	0.111	<0.001
Aromatic content (%)	IP 391	35.5	20.4	22.6	30.4	39.3	29.2	35.1	29.5
Pour point	D97-05A	1	-2	-5	1	1	-1	2	-4
Carbon content (wt.%)	ASTM D5291	87.9	86.00	86.14	87.27	86.71	86.44	87.98	86.57
Hydrogen content (wt.%)	ASTM D5291	8.5	9.5	9.7	8.9	10.03	10.00	8.65	13.39
Oxygen content (wt.%)	ASTM D5622	1.3	2.1	2.8	2.7	1.5	1.8	0.6	0.05
Sulphur content (wt.%)	ASTM D5453	0.155	0.102	0.125	0.092	0.098	0.084	0.102	0.0014
Nitrogen content (mg/kg)	ASTM D4530	620	527	476	368	411	428	387	44
Carbon residue (wt.%)	ASTM D4530	2.03	1.36	1.98	2.39	2.41	1.98	1.65	<0.01
LHV (MJ/kg)	ASTM D240	38.3	39.5	38.8	39.8	40.1	41.8	42.0	42.9

**Table 6**  
Properties of waste plastic fuels/Distilled tyre oil blends and diesel fuels.

Parameter	Method	PET/DTO	HDPE/DTO	PVC/DTO	LDPE/DTO	PP/DTO	PS/DTO	Diesel
Density	ASTM D4052	803	800	809	804	803	811	811
Calorific value(MJ/kg)	ASTM D240	41,980	41,890	41,950	41,800	41,600	42,000	42,000
Cetane number	D613-84	52	51	52	50	52	54	54
Water content (mg/g)	ASTM D6304	590	256	161	156	174	106	65
Flash point	ASTM D93	55	53	52	54	53	55	57
Acid number (mg KOH/g)	IP 139	11	12	7	5	9	4	0
Kinematic viscosity @ 40	D445-04E02	1.90	2.01	2.0	2.0	1.96	1.99	2.62
Ash content	IP 391	0.102	0.014	0.100	0.009	0.008	0.001	<0.001
Aromatic content (%)	IP 391	34.5	20.4	24.6	29.4	31.3	29.3	29.5
Pour point	D97-05A	1	-2	-4	2	-1	-1	-4
Carbon content (wt.%)	ASTM D5291	85.9	86.00	86.14	85.27	85.71	85.44	86.57
Hydrogen content (wt.%)	ASTM D5291	9.5	10.5	11.7	12.9	11.03	11.01	13.39
Oxygen content (wt.%)	ASTM D5622	1.3	1.1	1.3	1.2	1.1	0.8	0.05
Sulphur content (wt.%)	ASTM D5453	0.155	0.10	0.105	0.012	0.038	0.011	0.0014
Nitrogen content (mg/kg)	ASTM D4530	120	127	106	108	101	92	44
Carbon residue (wt.%)	ASTM D4530	2.03	1.36	1.98	2.39	2.41	1.98	<0.01
LHV (MJ/kg)	ASTM D240	34.3	40.5	39.8	39.8	41.1	42.1	42.9

is that higher or lower than 29.5–29.5% aromatics will affect the combustion characteristics of the fuels obtained. Based on the estimated carbon content of the fuels, all the fuels had similar/near carbon contents which are in the range of 86 – 87.98, with HDPE (86) and DTO (87.98) having the lowest and highest carbon contents, respectively. According to Fakhrohoseini and Dastanian [17], most fuels have carbon

contents in the range of 85–88%.

**3.1.3.4. Gaseous emissions and low heating values of the fuels.** For the gaseous products, all the tested fuels gave hydrogen emissions in the range of 8.5 wt%–13.39 wt%, with PET and diesel oil giving the lowest and highest hydrogen emission, respectively, this justifies the findings of

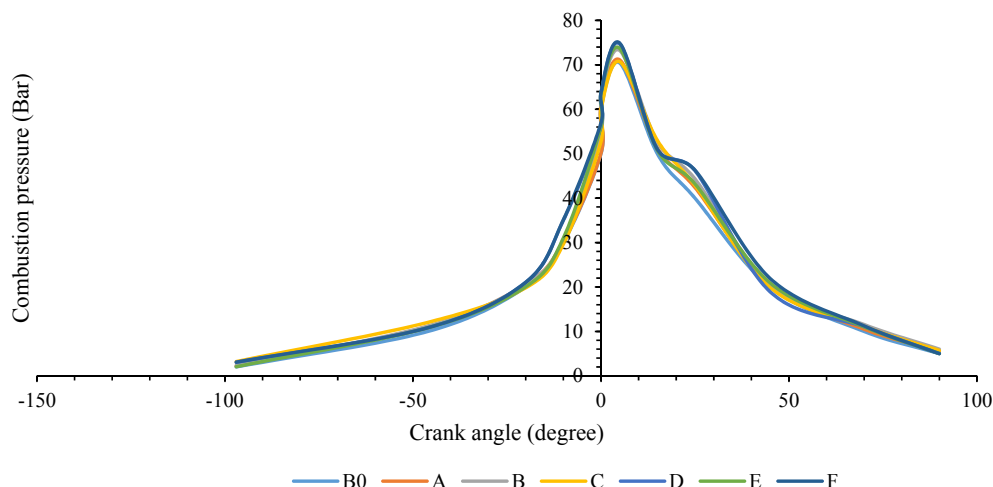

**Fig. 5.** Cylinder Peak pressure.

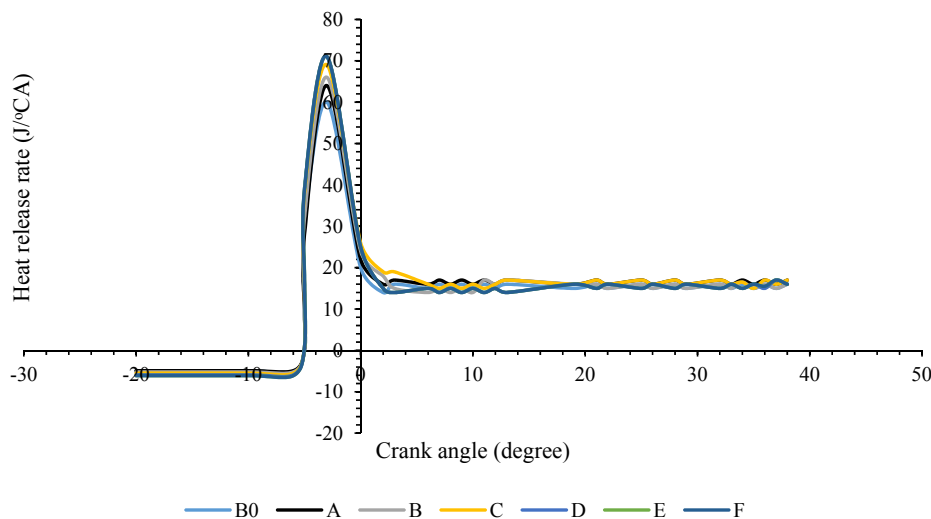

Fig. 6. Heat release rate versus Crank angle degree.

Kodera et al. [28]. Since PS gave the highest hydrogen of about 10%, it then suggests that considerations can be given to this plastic source for hydrogen generation, because formic acid as a potential hydrogen source contains about 4% hydrogen. Oxygen emissions for the fuels were found to be low and are in the range of 6.05 wt% (diesel fuels) to 2.8 (PVC oil). Considering the amount of sulphur in the fuels, it is clearly evident that the PS and diesel fuels have the lowest sulphur contents amongst all the fuels. The implication is that both fuels have better combustion properties relative to other fuels. Based on the estimated emission factors, nitrogen emission is lowest (i.e., 44 mg/kg) for the diesel fuel, however, amongst all the waste plastic fuels, PS gave the lowest  $N_2$  emission of 387 mg/kg. The carbon residues collected after obtaining the oils from pyrolysis are all low thus, giving an indication of low amount of wastes. The obtained carbon residues are in the following increasing order of magnitude  $< 0.01(\text{Diesel}) < 1.65(\text{DTO})$

$$< 1.36(\text{HDPE}) < 1.98(\text{PVC} - \text{PS}) < 2.03(\text{PET}) < 2.39(\text{LDPE}) \\ < 2.41\text{wt}\%(PP),$$

these findings corroborates the results obtained by Bhakta et al. [9] and Khan et al. [13]. Considering the heating values of all the fuels, PS has the closest LHV (42.0 MJ/kg) to that of the diesel fuel (42.9 MJ/kg), which thus attests to the reason for their high combustion properties relative to other fuels.

The Properties of waste plastic fuels/Distilled tyre oil blends and diesel fuels are shown in Table 6.

### 3.2. Combustion characteristics

#### 3.2.1. Cylinder peak pressure

Cylinder pressure variation with the crank angle is vital in determining the quantifiable information available as regards progressive combustion in an engine. Viscosity is also an important property to look out for prior fuel evaporation and combustion. The lower the viscosity, the better the air-fuel interaction. The variation in in-cylinder pressure versus crank angle for diesel and the fuel-blends is as shown in Fig. 5. According to the works of Ankit et al. [23] and Wei-Cheng et al. [8], at elevated loads, temperature also increased with respect to pressure, which can lead to higher evaporation rate and better combustion of the DTO and WTO respectively. The cylinder peak pressure for diesel is 70.04 bar, whereas, those of the oil-blends are: PET/DTO- 71.1 bar, HDPE/DTO - 73.21 bar, PVC/DTO- 70.68 bar, LDPE/ DTO- 74.68 bar, PP/DTO- 73.68 bar and PS/DTO- 74.88 bar respectively. Tan et al. [10] reported that, they observed similar peak cylinder pressures for some tested fuels. Higher cylinder pressures in the blends were obtained as

compared to those of the diesel fuel due to the faster evaporation of waste plastic oil in the fuel-blends inside the cylinder leading to the absorption of heat from the chamber. When ignition delay is longer at full load, it tends to increase the pressure of the waste plastic oil in the blends compared to the diesel fuels; this delay period represents the premixed combustion. Conversely, high-octane fuel exhibits this behaviour especially in high compression ratio engines. Thus, efficient compression is very crucial. In a compression ignition engine, the peak pressure usually is a function of the combustion rate at the preliminary stages, which is controlled by the quantity of fuel taking part in the uncontrolled combustion phase governed by the ignition delay period. The cylinder pressure increased from 3.07 bar at  $-97^\circ\text{C}$  and peaked at 74.88 bar when the temperature was  $5^\circ\text{C}$  as seen for sample F; lower peak pressures were obtained for other fuel blends with the lowest being those of samples A and C. Based on the findings of Khan et al. [13] this might be due to higher viscosity and lower calorific value of the fuel sample, which in turn caused changes in the rate of evaporation, penetration and atomization of the test-fuels which subsequently affected the cylinder pressure.

#### 3.3. Heat release rate (HRR)

The HRR curve helps to determine the amount of heat energy which can be transformed into valuable work during the burning of fuel. The information regarding the combustion process inside the engine, can be extracted by the evaluation of the HRR curve. The HRRs of the engine running on the blended fuels and diesel fuel at 100% load, for different crank angles is as illustrated in Fig. 6. The rate of combustion inside the engine can be calculated from the HRR based on Eq. (1):

$$\text{Heat Release Rate} = \left(\frac{r}{r-1}\right)p \left(\frac{dV}{d\theta}\right) + \left(\frac{1}{r-1}\right)V \left(\frac{dP}{d\theta}\right) \quad (1)$$

From Eq. (1), the combustion products were assumed to be ideal gases; thus, dissociation of combustion products and wall heat transfer were neglected.  $dv$  and  $dp$  are the changes in cylinder volume and cylinder pressure at  $\theta$  degrees rotation of the engine's crank shaft. This rapid increase in the heat release rate is an indication of the period of commencement of combustion. The HRR increased rapidly after the process of combustion as a result of burning of fuel that was stored in the combustion chamber throughout the ignition delay period. The higher cetane number of the fuel-blends enhanced the rapid diffusion of the fuels thus bypassing the longer pre-mix combustion phase. Reports from Murugan et al. [2,3], show that cetane number is a function of viscosity, which can affect the calorific value of different fuel blends at varying

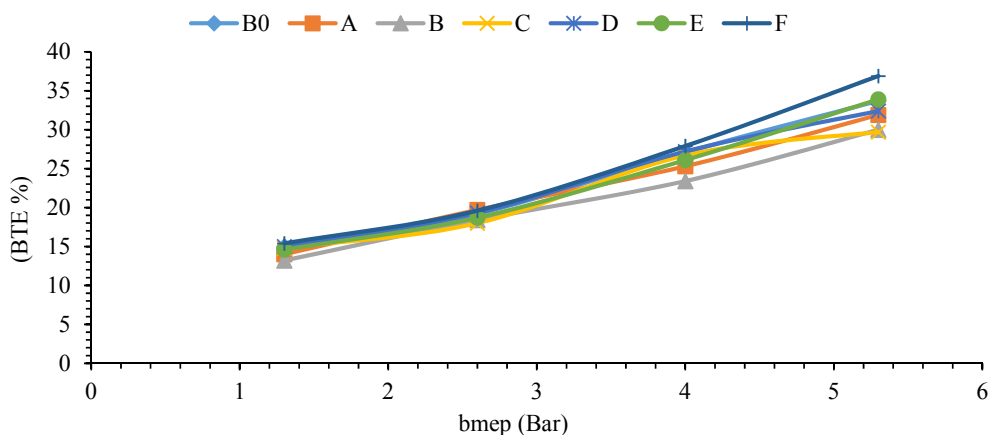

Fig. 7. BTE versus Engine load.

viscosities; this is in line with the findings of this study where lower cetane numbers correspond to higher viscosities as obtained for the unblended PS (CN = 53, kinematic viscosity = 1.92) and DTO (CN = 52, kinematic viscosity = 1.77) oils, with respect to those of the PS-DTO oil blend whose cetane number and viscosity are 54 and 1.99 respectively. The HRR curves of the blends show decline curves for the different fuel-blends as compared to those of standard diesel fuel. This is due to the shorter delay of the fuel-blends, which in turn affects the peak pressure and HRR of the pre-mix burning phase of the fuels. The high calorific values and viscosities of the fuel-blends also contribute to the decline in heat release rate. Stage one is the start-of-ignition, where the HRR drops at a certain point and this occurs as a result of the ignition of the fuel-air mixture available during the ignition delay period. At stage two, it continues from the end of stage one through to the end of the combustion process. Martínez et al. [12] asserted that the peak HRR for some tested fuels were almost identical at low engine loads, whereas, at high engine loads, they observed that those of the waste tyre oil and its blends compared to that of the diesel fuel, showed that the peak HRR of diesel was slightly higher than those of DTO and its blends. The diesel fuel with HRR  $60 \text{ J}/^\circ\text{CA}$  shows low HRR at the preliminary stage which then induces longer combustion duration. The HRR for the blends are: PET/DTO-  $64 \text{ J}/^\circ\text{CA}$ , HDPE/DTO -  $66 \text{ J}/^\circ\text{CA}$ , PVC/DTO-  $69 \text{ J}/^\circ\text{CA}$ , LDPE/DTO-  $71 \text{ J}/^\circ\text{CA}$ , PP/DTO-  $71 \text{ J}/^\circ\text{CA}$  and PS/DTO-  $71 \text{ J}/^\circ\text{CA}$ , these results corroborate the findings of refs. [7,12,24]. The maximum heat released for the different fuel blends is higher relative to that of the diesel fuel. It can be observed that in the blends, high heat release occurred during the premixed combustion phase. Nabi et al. [1] and Ankit et al. [23] pointed out that the HRR of DTO and WPO fuels were higher compared to that

obtained for conventional diesel which they allotted to be due to low viscosity and better spray characteristics. Although, their study does not bother on blended WTO, however, the same trend was observed for the variation of the HRR of the blended fuels relative to that of the diesel fuel. Fig. 6 shows that the HRR is higher in the blends. Higher HRRs correspond to increases in the exhaust gas temperatures.

### 3.3.1. Brake thermal efficiency (BTE)

BTE explains the modes of operation of transformation of heat to mechanical work. In this study, the BTE increases progressively with load. According to Oztop et al. [11] and Liu et al. [22], high air/fuel mixing, high calorific value of fuels, causes high BTE in fuels. Fig. 7 shows the variation of BTE with engine load for all the test-fuels. Data for supplementary file of BTE for the unblended fuels is illustrated in Table S3. Some of the blends (PP/DTO- 33.9% and PS/DTO- 36.9%) gave higher efficiencies compared to the efficiency recorded for the diesel fuel, whereas, others (PET/DTO- 31.9%, HDPE/DTO - 30%, PVC/DTO-29.7%, LDPE/DTO- 32.4%) show low BTEs, this is evident in the fact that more energy is needed to crack the heavier hydrocarbon chains present in the blends. The addition of distilled tyre oil (DTO) to the blends improved the BTE and decreased the densities of the fuel-blends thereby improving their spray atomization with faster fuel vaporization which are responsible for their higher BTEs. Research has shown that the addition of DTO, which is usually characterized by low cetane number, increases the ignition-delay time of the fuel-blends during the process of combustion [24,25], thus promoting fuel-air mixing and thus improving the BTE since efficient air-fuel mixing is vital for the high performance of an engine. From Fig. 7, the PP/DTO- 33.9%, and (PS/DTO)- 36.9%

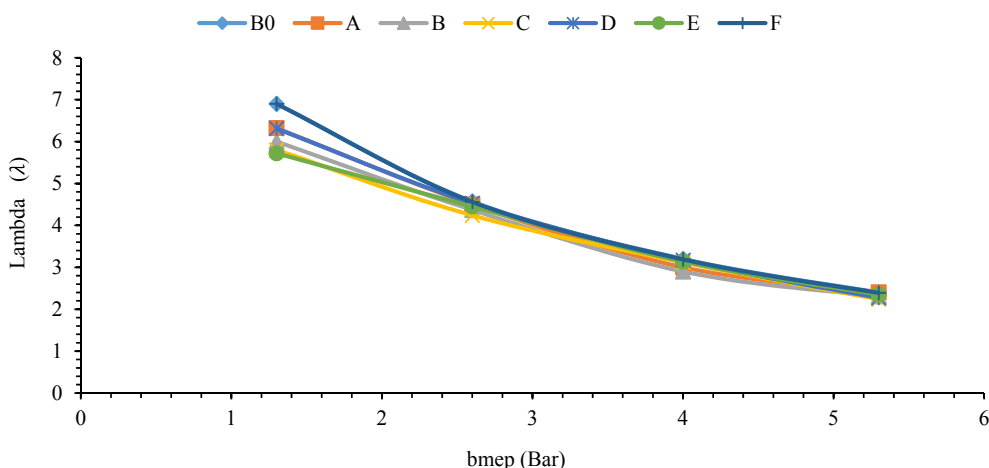

Fig. 8. Variation of lambda with engine load.



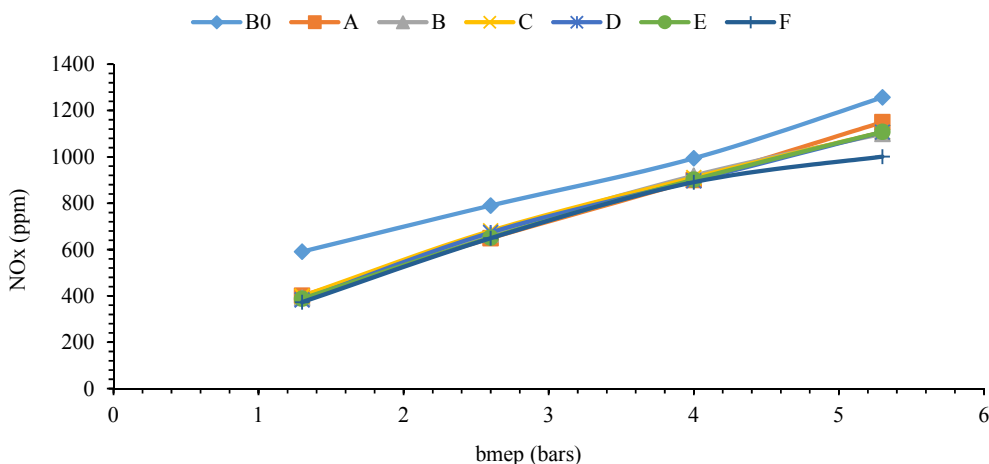

Fig. 9. Variation of NOx with load.

blends delivered better performance than the standard diesel fuel, while, PET/DTO- 31.9%, HDPE/DTO – 30%, PVC/DTO– 29.7% and LDPE/ DTO 32.4% gave lower BTEs than that of the diesel fuel, this is in line with results in refs. [17,29]. It is clear that the BTE of some of the other blends are higher than that of the diesel fuel. This occurred due to the exhaust gas temperature (EGT) and the HRR that are marginally lower for the blends compared to those of the diesel fuel, thus leading to lower heat losses and higher BTEs in the case of the blended fuels.

### 3.3.2. Air-fuel ratio

Air – fuel ratio plays a vital role in the emission and combustion characteristics of CI engines [9,16]; this agrees with the findings of this study, where at varying air–fuel ratios, the BTEs of all the fuels increased while the resulting emissions decreased. To guarantee combustion process, certain quantities of air and fuel needs to go into the combustion chamber. When all the fuel is burnt in the exhaust gas, there will be no quantities of unburnt fuel, this process is called complete combustion, however, in real life situations, complete combustion is hardly feasible hence, what is attainable may be near complete combustion. Fig. 8 illustrates the variations of the air–fuel equivalence ratio ( $\lambda$ ) at various engine loads. ( $\lambda$ ) can be defined as,

$$\lambda = \frac{A/F}{(A/F)_{stoich}} \quad (2)$$

The overall air–fuel ratio is defined as A/F, where  $(A/F)_{stoich}$  is the stoichiometric Air–fuel ratio. Depending on the value of lambda, an engine’s air–fuel mixture may be rich ( $\lambda < 1$ ), lean ( $\lambda > 1$ ) or stoichiometric (ideal) ( $\lambda = 1$ ) air–fuel mixture. As  $\lambda$  increases, the leaner the air–fuel mixture becomes, otherwise, it becomes rich. Therefore, the higher the concentration of DTO in the WTO, the leaner the mixture is. CI engines always run on lean mixtures due to the nature of the combustion process. The engine runs on leaner air–fuel mix when fuelled with the blends (DTO in WTO) compared to the diesel fuel. The engine performance in terms of fuel consumption and power is solely dependent on air–fuel ratio. According to Williams et al. [14] most of the modern diesel engines run on fuels with lambda > 1. Based on the findings in this study, the lambda values range from 2.39 to 6.9 which also corroborates that assertion.

### 3.3.3. NOx emissions

One of the mechanisms that causes the formation of NOx formation in CI engines are prompt and fuel-bound nitrogen. Atmospheric (molecular) nitrogen is one of the sources of NOx formation during combustion of fuels [7]. NOx formed through the high temperature oxidation of nitrogen ( $N_2$ ) in the combustion chamber is referred to as thermal NOx. NOx formation in diesel engine is driven by air/fuel ratio, in-cylinder temperature, residence time and oxygen concentration for the reaction to occur [12]. Generally, several authors have reported an

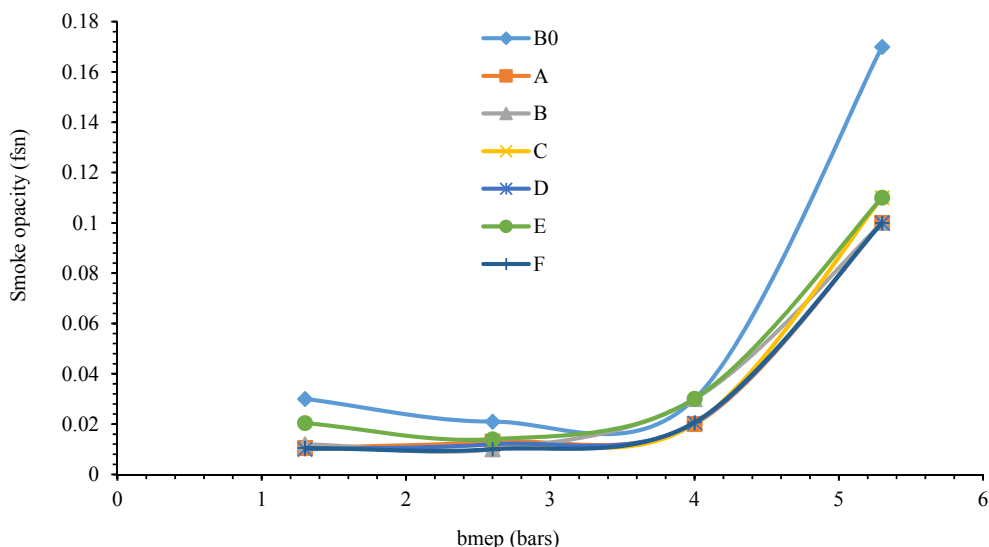

Fig. 10. Variation of smoke with load.

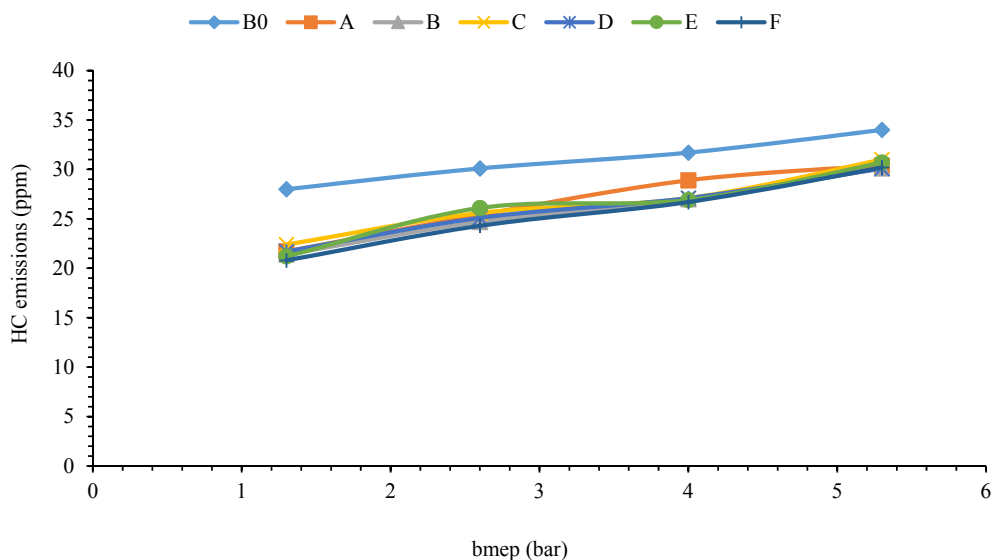

Fig. 11. Variation of HC with load.

increase in NO<sub>x</sub> emission with the use of TPO compared to diesel. NO<sub>x</sub> variation can be explained on the basis of temperature and injection timing. Advanced injection-timing leads to high ignition delay duration of the premixed phase, and residence time which result in higher in-cylinder temperature and NO<sub>x</sub> emission as documented in ref. [19], however, in this study, the NO<sub>x</sub> emissions were lower owing to the improved properties of the fuels aided by blending. Furthermore, high oxygen content permits fuel to premix completely during ignition delay which results in more heat released during the premix-burn phase, and this is thus responsible for an increase in NO<sub>x</sub> emissions, hence the reason for the higher NO<sub>x</sub> emissions recorded in ref. [19] relative to those observed for the blended fuels. According to Wamankar and Murugan [31], advancing the injection timing leads to higher NO<sub>x</sub> emissions for fuels, owing to high in-cylinder temperature and rapid combustion. Higher adiabatic flame temperatures, increase the formation of NO<sub>x</sub>. Lower H/C ratio, and more aromatic content result in higher adiabatic flame temperature for engines operated with TPO fuel, thus resulting in higher NO<sub>x</sub> emissions; the implication of this is that, for all the blended fuels, the reason for the low NO<sub>x</sub> emissions of the PS/DTO relative to others, is that, the other fuels experienced a higher adiabatic flame temperature due to their higher aromatic contents which in turn led to their higher NO<sub>x</sub> emissions with respect to PS/DTO. The oxides of nitrogen in the emissions contain nitric oxide (NO) and nitrogen dioxide (NO<sub>2</sub>). Consequently, NO<sub>x</sub> development depends upon the oxygen content of the fuel and chamber temperature, whereas, its formation depends on the residence time, in-cylinder temperature and oxygen concentration of the reaction. Fig. 9 shows the compared NO<sub>x</sub> emissions at different bmep. The NO<sub>x</sub> emissions increased for the diesel fuel (B0) but were lower for all the fuel-blends even at increased engine loads due to: oxygen availability in the blends, fast rate of combustion, and the amount of heat generated. In addition, the drop in NO<sub>x</sub> outflow for the fuel-blends occurred as a result of a reduction in peak pressure and low calorific value of the blends. Short ignition delays of the blends promote premixed combustion which may also be the reason for lower NO<sub>x</sub>-emissions.

### 3.3.4. Smoke opacity

Smoke comprises of solid soot particles suspended in exhaust gas. Dirty/cloudy smoke is released due to deficiencies in combustion during overwhelming engine loads. During the process of combustion, the rich mixture of fuel could not be oxidized as a result of lack of oxygen leading to incomplete combustion and poor atomization (Fig. 10), thus generating dirty smoke and particulate matter, which in turn reduced the net

engine power. The oxygen contents of the fuel-blends promote the oxidation of fuel molecule during the process of combustion which in turn leads to complete combustion as well as cleaner smoke-release. The smoke qualities of the fuel-blends are lower than that of the diesel fuel. Addition of DTO to WPO in CI diesel engine improved on the quality of the smoke released from the exhaust and this can be attributed to the availability of premixed and homogeneous air-fuel mix/charge inside the engine prior combustion which gives rapid flame propagation and better combustion. Rapid flame propagation, low carbon content in the blends, higher combustion temperature and extended duration of combustion are other causes for high smoke quality of the blends. Again, sample blend F gave the best smoke quality owing to its very low opacity.

### 3.3.5. Hydrocarbon (HC) emissions

The unburnt HC emissions are as a result of incomplete combustion, caused by the incomplete mixing of air and fuel. The HC emissions for all the fuel-blends, were found to be lower than those of the diesel fuel [30]. Murugan et al. [4] demonstrated that an increase in HC emissions for DTO fuel was due to the occurrence of unsaturated HCs, which did not breakdown during the combustion process. Williams et al. [14] also stated that the DTO fuel -spray does not properly spread into the combustion chamber, thus leading to existence of unburnt gaseous HCs on the inner walls of the cylinders and crevice volumes, thus causing incomplete combustion. İlkılıç and Ayınd [32] likened the low cetane number of DTO to high ignition delay. In contrast to the general finding, some authors observed a decrease in HC emissions for DTO blended fuels; this may be due to the nature of the different components of the blends in the fuel-mixtures. The variation of hydrocarbon emissions across the engine load is illustrated in Fig. 11. HC emissions are most times high for waste plastic oil (WPO). The HC emissions increased for the WPO due to the presence of unsaturated HCs that were resilient to conversion during the combustion process [24,25]. However, with the addition of DTO, the HC emissions decreased for the fuel-blends relative to that of the diesel fuel. High unburnt HCs can be attributed to low combustion efficiency. From the results, it was noticed that the HCs emitted for the diesel oil are higher than those of the fuel-blends. This is due to the non-availability of oxygen in the diesel fuels. Koc and Abdullah [16] and Ahmad [21] have pointed out the values of unburned hydrocarbon emission from DTO and WPO in diesel engine as less than those of diesel fuel. İlkılıç and Ayınd et al. [32] confirmed that most of the biodiesel blends show significant decrease in total unburned hydrocarbon emissions in the exhaust of diesel engines in their review

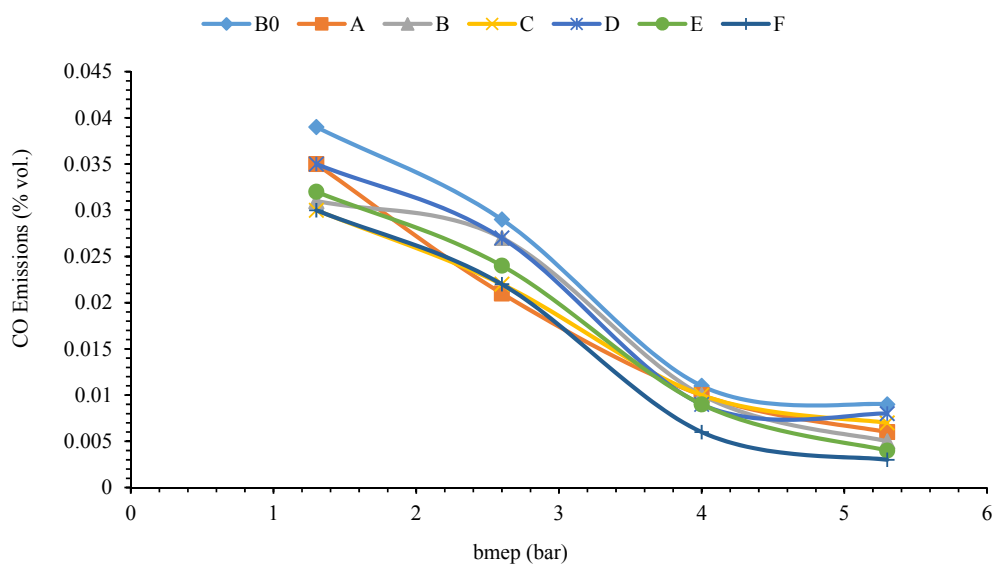

Fig. 12. Variation of CO with load.

article.

### 3.3.6. CO emissions

CO emissions are attributed to incomplete combustion caused by lack of oxygen. Its variation with engine load is as illustrated in Fig. 12. As the load increases, CO becomes low for all fuels; this resulted from the addition of DTO at high temperatures and loads which helped to enhance CO oxidation to CO<sub>2</sub>.

Generally, an increase in engine-speed leads to a decrease in CO emissions; nevertheless, an excessive increase in engine speed may lead to higher CO emissions, at this point a lower combustion flame temperature confines CO oxidation into carbon dioxide [15]. The higher heat release rate of WPO during the time of retarded injection, results in high combustion temperature and higher oxidation of CO molecules. At higher engine loads, the absence of oxygenated components in WPO leads to incomplete combustion of carbon molecules. Thus, blending the DTO with WPO enhanced complete combustion due to the higher amount of available oxygen [26,27] with resultant increase in octane rating [28] and volatility [29]. The improvement in fuel injection timing, can reduce the CO emissions to about 16–18%, which is primarily due to a more rapid oxidation between carbon and oxygen molecules [33]; this also corroborates the findings in this study.

## 4. Conclusion

In other to minimize the usage of fossil fuels, fuel properties such as density, Cetane number, pour point, flash point, and viscosity of pyrolyzed waste tyre/plastics and standard diesel fuel (Bo) were determined and compared in terms of engine performance, combustion and exhaust emissions. The fuels considered were obtained from High density polyethylene (HDPE), Low density polyethylene (LDPE), polypropylene (PP), polystyrene (PS), and poly (vinyl chloride) (PVC) and PE terephthalate, and blended with distilled waste tyre oil in different proportions in order to ascertain their usage as alternate fuels in a CI diesel engine. Based on the findings, it was seen that fuel properties of the fuel-blends compared favourably with those of the diesel fuel as adjudged by the EN 590 Diesel Fuel Standard chart. The engine was able to run with different proportions of 100% waste tyre/plastic blends; however, over all, sample F gave the best results. The Unburned hydrocarbons, NOx, Smoke-dirtiness and CO emissions of the fuel-blends were considerably lower with higher brake thermal efficiency compared to those of the diesel fuel.

## Declaration of Competing Interest

The authors declare that they have no known competing financial interests or personal relationships that could have appeared to influence the work reported in this paper.

## Appendix A. Supplementary data

Supplementary data to this article can be found online at <https://doi.org/10.1016/j.fuel.2021.120801>.

## References

- [1] Nabi ASMR, Masud MH, Alam QMI. Purification of pyrolysed tyre oil (Tyre Pyrolytic Oil) and its use in diesel engine. *IOSR J Eng* 2014;4:1–8.
- [2] Murugan S, Ramaswamy MC, Nagarajan G. The use of tyre pyrolysis oil in diesel engines. *Waste Manag* 2008;28(12):2743–9.
- [3] Murugan S, Ramaswamy MC, Nagarajan G. A comparative study on the performance, emission and combustion studies of a DI diesel engine using distilled tyre pyrolysis oil–diesel blends. *Fuel* 2008;87(10–11):2111–21.
- [4] Murugan S, Ramaswamy MC, Nagarajan G. Performance, emission and combustion studies of a DI diesel engine using Distilled Tyre pyrolysis oil-diesel blends. *Fuel Proc Technol* 2008;89(2):152–9.
- [5] Martínez JD, Fernandez JR, Valdepenas JS, Murillo R, García T. Performance and emissions of an automotive diesel engine using a tyre pyrolysis liquid blend. *Fuel* 2014;115.
- [6] Ayanoglu A, Yumrutas R. Production of gasoline and diesel like fuels from waste tyre oil by using catalytic pyrolysis. *Energy* 2016;103:456–68.
- [7] Murugan S, Ramaswamy MC, Nagarajan G. A comparative study on the performance, emission and combustion studies of a DI diesel engine using distilled tyre pyrolysis oil-diesel blends. *Fuel* 2008;87(10–11):2111–21.
- [8] Wei-Cheng W, Chi-Jeng B, Chi-Tung L, Prakash S. Alternative fuel produced from thermal pyrolysis of waste tyres and its use in a DI diesel engine. *Appl Therm Eng* 2016;93:330–8.
- [9] Bhakta M, Pandya M, Patel HM, Patel TM, Rathod GP. Performance & emission studies of diesel engine using blends of diesel, tyre pyrolysis oil and dibutyl maleate. *Int J Sci Res Develop* 2014;2(03):2014.
- [10] Tan P, Zhao J, Hu Z, Lou D, Du A, Du D. Effects of fuel properties on exhaust emissions from diesel engines. *J Fuel Chem Technol* 2013;41(3):347–55.
- [11] Öztop H, Varol Y, Altun S, Firat M. Using gasoline-like fuel obtained from waste automobile tires in a spark-ignited engine. *Energy Sour Part A Recovery Util Environ Eff* 2014;36:1468–75.
- [12] Martínez JD, Puy N, Murillo R, García T, Navarro MV, Mastral AM. waste tyre pyrolysis—a review. *Renewable Sustainable Energy Rev* 2013;23:179–213.
- [13] Khan MZH, Sultana M, Al-Mamun MR, Hasan MR. Pyrolytic waste plastic oil and its diesel blend: fuel characterization. *J Environ Public Health* 2016:1–6. Article ID 2016.
- [14] Williams PT, Cunliffe AM, Bottrill RP, Brindle AJ, Dhir KR, Limbachiya CM, Paine AK. The potential of pyrolysis for recycling used tires. In: *Recycling and Reuse of Used Tires*. Thomas Telford Publishing; 2001. p. 187–202.
- [15] Vihar R, Seljak T, Opresnik SR, Katrasnik T. Combustion characteristics of tyre pyrolysis oil in turbo charged compression ignition engine. *Fuel* 2015;150:226–35.

- [16] Koc AB, Abdullah M. Performance of a 4-cylinder diesel engine running on tyre oil-biodiesel-diesel blend. *Fuel Process Technol* 2014;118:264–9.
- [17] Fakhrhoseini SM, Dastanian M. Predicting pyrolysis products of PE, PP, and PET using NRTL activity coefficient model. *Hindawi Publishing Corporation* 2013:1–5.
- [18] Michael PA. Plastic waste total in MSW Society of the Plastic Industry. 2010.
- [19] López A, de Marco I, Caballero BM, Laresgoiti MF, Adrados A. Dechlorination of fuels in pyrolysis of PVC containing plastic wastes. *Fuel Process Technol* 2011;92(2):253–60.
- [20] Bagri R, Williams PT. Catalytic pyrolysis of polyethylene. *J Anal Appl Pyrol* 2002;63(1):29–41.
- [21] Ahmad I, Khan MI, Khan H, Ishaq M, Tariq R, Gul K, et al. Pyrolysis study of polypropylene and polyethylene into premium oil products. *Int J Green Energy* 2015;12(7):663–71.
- [22] Liu Y, Qian J, Wang J. Pyrolysis of polystyrene waste in a fluidized-bed reactor to obtain styrene monomer and gasoline fraction. *Fuel Process Technol* 2000;63(1):45–55.
- [23] Ankit V, Aditya R, Quraishi MA, Jeewan VT, Chandrabhan V. Engine fuel production from waste plastic pyrolysis (WPO) and performance evaluation in a CI engine with diesel blend. *J Mater Environ Sci* 2018;9(6):1712–21.
- [24] Williams PT, Stanley E. Analysis of products from the pyrolysis and liquefaction of single plastics and waste plastic mixtures. *Resour Conserv Recycl* 2007;51:754–69.
- [25] Panda AK, Singh RK, Mishra DK. Thermolysis of waste plastics to liquid fuel. A suitable method for plastic waste management and manufacture of value added products—a world prospective. *Renew Sustain Energy Rev* 2010;14:233–48.
- [26] Aguado J, Serrano DP, Escola JM. Fuels from waste plastics by thermal and catalytic processes: a review. *Ind Eng Chem Res* 2008;47(21):7982–92.
- [27] Mani M, Nagarajan G. Influence of injection timing on performance, emission and combustion characteristics of a DI diesel engine running on waste plastic oil. *Energy* 2009;34(10):1617–23.
- [28] Kodera Y, Ishihara Y, Kuroki T. Novel process for recycling waste plastics to fuel gas using a moving-bed reactor. *Energy Fuels* 2006;20(1):155–8.
- [29] Murugan S, Ramaswamy MC, Nagarajan G. Performance, emission and combustion studies of a DI diesel engine using distilled tyre pyrolysis oil– diesel blends. *Fuel Process Technol* 2007;15:45–53.
- [30] Arvanitoyannis S, Tserkezou P. Cereal waste management: treatment methods and potential uses of treated waste. *Waste Manage Food Ind* 2008:629–702.
- [31] Wamankar AK, Murugan S. Combustion, performance and emission characteristics of a diesel engine with internal jet piston using carbon black- water-diesel emulsion. *Energy* 2015;91:1030–7.
- [32] İlkiliç C, Aydın H. Fuel production from waste vehicle tires by catalytic pyrolysis and its application in a diesel engine. *Fuel Process Technol* 2011;92:1129–35.
- [33] Frigo S, Gentili R, Seggiani M, Puccini M. Diesel fuel by scrap-tyre thermal-mechanical pyrolysis. *SAE Int J Fuels Lubr* 2013;6.