



Building Integrated Solar Thermal (BIST) Technologies and Their Applications: A Review of Structural Design and Architectural Integration

Xingxing Zhang¹, Jingchun Shen¹, Llewellyn Tang¹, Tong Yang¹, Liang Xia¹, Zehui Hong¹, Luying Wang¹, Yupeng Wu², Yong Shi¹, Peng Xu³ and Shengchun Liu⁴

¹Department of Architecture and Built Environment, University of Nottingham, Ningbo, China

²Department of Architecture and Built Environment, University of Nottingham, UK

³Beijing Key Lab of Heating, Gas Supply, Ventilating and Air Conditioning Engineering, Beijing University of Civil Engineering and Architecture, China

⁴Key Laboratory of Refrigeration Technology, Tianjin University of Commerce, China

Abstract

Solar energy has enormous potential to meet the majority of present world energy demand by effective integration with local building components. One of the most promising technologies is building integrated solar thermal (BIST) technology. This paper presents a review of the available literature covering various types of BIST technologies and their applications in terms of structural design and architectural integration. The review covers detailed description of BIST systems using air, hydraulic (water/heat pipe/refrigerant) and phase changing materials (PCM) as the working medium. The fundamental structure of BIST and the various specific structures of available BIST in the literature are described. Design criteria and practical operation conditions of BIST systems are illustrated. The state of pilot projects is also fully depicted. Current barriers and future development opportunities are therefore concluded. Based on the thorough review, it is clear that BIST is very promising devices with considerable energy saving prospective and building integration feasibility. This review shall facilitate the development of solar driven service for buildings and help the corresponding saving in fossil fuel consumption and the reduction in carbon emission.

Keywords: Building integrated solar thermal; Design criteria; Operation; Application

Introduction

In order to achieve the global carbon emission target, the high fraction of locally available renewable energy sources in energy mix will become necessary in addition to a significantly reduced energy demand. Solar energy is one of the most important renewable sources locally available for use in building heating, cooling, hot water supply and power production. Truly building integrated solar thermal (BIST) systems can be a potential solution towards the enhanced energy efficiency and reduced operational cost in contemporary built environment.

According to the vision plan issued by European Solar Thermal Technology Platform (ESTTP), by 2030 up to 50% of the low and medium temperature heat will be delivered through solar thermal [1]. However currently, the solar thermal systems are mostly applied to generate hot water in small-scale plants. And when it comes to applications in space heating, large-scale plants in urban heating networks, the insufficient suitable-and-oriented roof of most buildings may dictate solar thermal implementation. For a wide market penetration, it is therefore necessary to develop new solar collectors with feasibility to be integrated with building components. Such requirement opens up a large-and-new market segment for the BIST system, especially for district or city-level energy supply in the future.

BIST is defined as the “multifunctional energy facade” that differs from conventional solar panels in that it offers a wide range of solutions in architectural design features (i.e., colour, texture, and shape), exceptional applicability and safety in construction, as well as additional energy production. It has flexible functions of buildings’ heating/cooling, hot water supply, power generation and simultaneously improvement of the insulation and overall appearance of buildings. This facade based BIST technologies would boost the building energy efficiency and literally turn the envelope into an independent energy

plant, creating the possibility of solar-thermal deployment in high-rise buildings.

Working Principle of Typical BIST System

The typical BIST system is schematically shown in Figure 1. The system normally comprises a group of modular BIST collectors that receive the solar irradiation and convert it into heat energy, whereas the heating/cooling circuits could be further based on the integration of a heat pump cycle, a package of absorption chiller, a modular thermal storage and a system controller. In case of some unsatisfied weather conditions, a backup/auxiliary heating system (e.g., boiler) is also integrated to guarantee the normal operation of system.

In the typical BIST system, the overall energy source is derived from solar heat, which is completely absorbed by the modular BIST collectors. This part of heat is then transferred into the circulated working medium and transported to the preliminary heat storage unit, within which heat transfer between the heat pump refrigerant and the circulating working medium will occur. This interaction will decrease the temperature of circulating medium, which enables the circulating medium absorbing heat in the facades for next circumstance.

Meanwhile in the heat pump cycle (compressor-condenser-

***Corresponding author:** Zhang X and Tang L, Department of Architecture and Built Environment, University of Nottingham Ningbo, China, E-mail: Xingxing.Zhang@nottingham.edu.cn; Llewellyn.Tang@nottingham.edu.cn

Received June 02, 2015; Accepted August 25, 2015; Published September 02, 2015

Citation: Zhang X, Shen J, Tang L, Yang T, Xia L, et al. (2015) Building Integrated Solar Thermal (BIST) Technologies and Their Applications: A Review of Structural Design and Architectural Integration. J Fundam Renewable Energy Appl 5: 182. doi:10.4172/20904541.1000182

Copyright: © 2015 Zhang X, et al. This is an open-access article distributed under the terms of the Creative Commons Attribution License, which permits unrestricted use, distribution, and reproduction in any medium, provided the original author and source are credited.

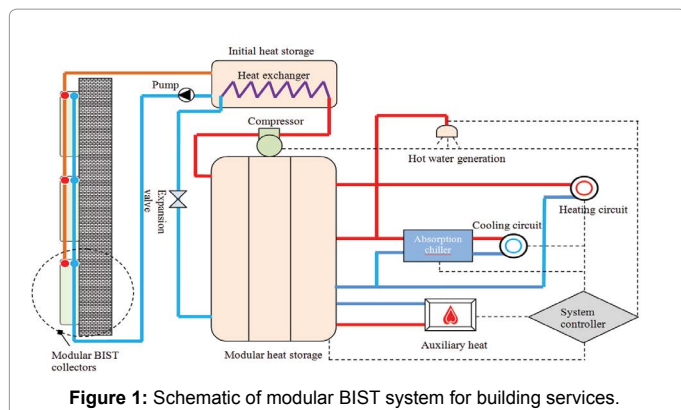

Figure 1: Schematic of modular BIST system for building services.

expansion valve-evaporator), the liquid refrigerant will be vaporized in the heat exchanger, which, driven by the compressor, will be subsequently converted into higher-temperature-and-pressure, supersaturated vapour, and further releases heat energy into the tank water via the coil exchanger (condenser of the heat pump cycle), leading to the temperature rise of the tank water. Also, the heat transfer process within the coil exchanger will result in condensation of the supersaturated vapour, which will be downgraded into lower-temperature-and-pressure liquid refrigerant after passing through the expansion valve. This refrigerant will undergo the evaporation process within the heat exchanger in the initial heat storage again, thus completing the heat pump operation. When the water temperature in the tank accumulates to a certain level, i.e., 45°C, then water can be directly supplied for utilization or under-floor heating system. For the cooling purpose, an additional appliance of absorption chillers should be coupled with.

Category of BIST Technologies

The BISTs can be classified into air-, hydraulic- (water/heat pipe/refrigerant) and PCM-based types according to the heat transfer medium. Air based type is characterized by lower cost, but lower efficiency due to the air's relatively lower thermal mass. This system usually uses the collected solar heat to pre-heat the intake air for the purpose of building ventilation and space heating. Hydraulic-based BISTs are most commonly used building integrated solar thermal devices that enable the effective collection of the striking solar radiation and conversion of it into the heat for the purpose of hot water production and space heating. The PCM-based type is usually operated in combination with air, water or other hydraulic measures that enable storing parts of the collected heat during the solar-radiation-rich period, and releasing them to the passing fluids (air, water, or others) during the solar-radiation-poor period, in order to achieve a longer period of BIST operation. In this aspect, the heat transfer medium based classification was adopted and mainly illustrated as follows:

Air-based BIST technology

Air-based solar thermal systems use air as the working fluid for absorbing and transferring solar energy. It can directly heat a room or pre-heat the air passing through a heat recovery ventilator or an air coil of an air-source heat pump. It is a promising solar thermal technology with the main advantages of: anti-freezing and anti-boiling operation, non-corrosive medium property, and low cost and simple structure. Therefore, no damage caused by leakage, stagnation condition and frost problems needs to be dealt with, offering a possibility of reliable and

cost-effective solutions even at a low irradiation level.

But air has a relatively low heat capacity, resulting in higher mass or volumetric flows and poor thermal removal effectiveness for BIST systems. In other words, more occupancy space is necessary in building components to fit air-handling equipment (ducts and fans) compared to that in the hydraulic-based system. And higher parasitic power consumption and acoustic problems are also worthy of attention. Generally, air-based BIST system could be simply delivered from single channel and double channels, as shown in Figure 2. The air-based solar thermal facade could be formulated by incorporating an air gap between the back surface of glazing covers (or PV panels, external sheet, construction mass) and the building fabric (facade, glazing or roof). In practical application, air based BIST in space heating systems is usually operated with fixed airflow rates, thus the outlet temperature varies along with the change of solar irradiation in a day. This is because if it runs at a fixed outlet temperature by varying the flow rate, both heat removal factor and collector performance would be low [2-4]. When air circulation is combined within photovoltaic (PV) modules, effectiveness for PV cooling would be very low once the air temperature is above 20 °C [3,4].

Water-based BIST technology

Water is the most suitable heat transfer medium for solar thermal technology owing to its high thermal capacity and thermal conductivity, and low viscosity and cost. Besides, it allows easy storage of solar heat gains, and is suitable for direct domestic hot water production and indirect space heating. However, water is corrosive in nature (especially at high temperature) as well as freezing and scaling based, which poses a challenge in the design tubing and plumbing. Though glycol/water mixture has been widely adapted to lower freezing risk, it is still worthy of attention with water pressure difference at different BIST levels (heights). And more measures should be taken into consideration of an envelope structure, accessibility and 8 protection of water leakage. Figure 3 demonstrates different water-based BIST structures.

The water-based BIST can be mainly divided into two modes

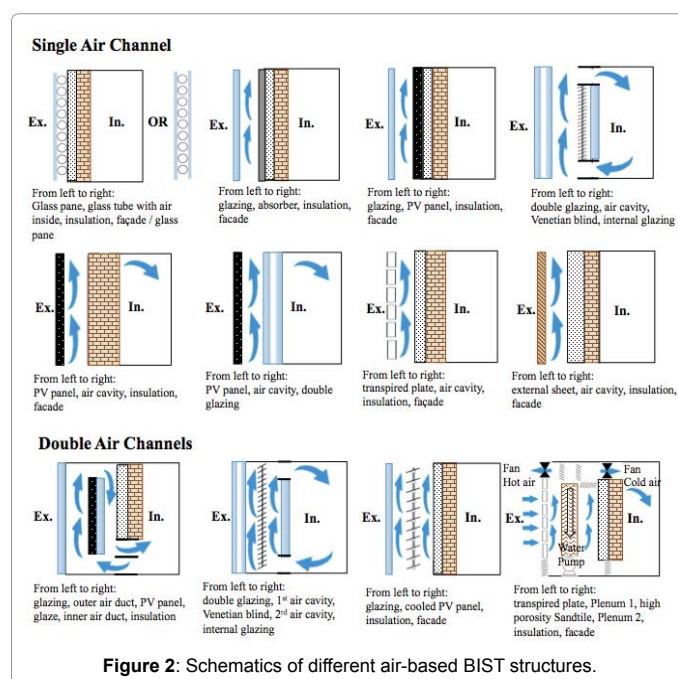
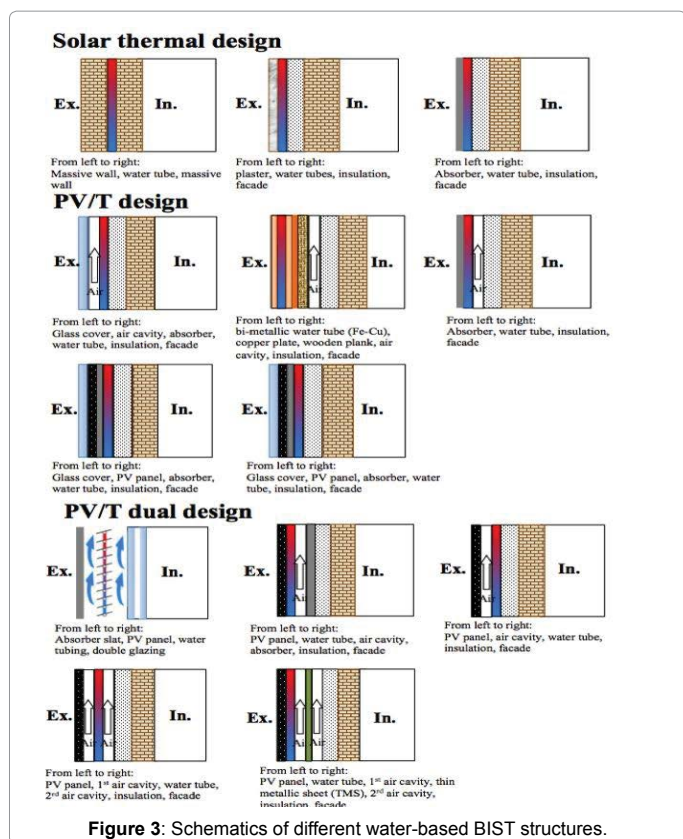

Figure 2: Schematics of different air-based BIST structures.



of arrangement: single water channel and multiple flow channels (integrated air and water flow). The former structural arrangements are evolved from the mechanism of the passive solar heating, which often provide the solutions to hot water purpose. The latter structural arrangements are normally formulated by incorporating additional air gap between the PV module (absorber, water flow tubes) and the building fabric. As a result, air could be delivered from above, below or on both sides of the water tubes. With the help of electrical or mechanical equipment, these designs can provide the solutions to the inversed thermo-siphon phenomena and the uncertainty of heat transfer. In some cases, the PV module acts as the thermal absorber (named PV/thermal design) and the water flow channels could be round, rectangle and other irregular geometries. The water-based PV/thermal designs take advantages of both electricity production and heat extraction. At present, the technical drawback of the traditional PV panels lies in the relatively low electrical efficiency in the range 6 to 18%. PVs' electrical efficiency varies in an inversely linear trend with the PV cells' surface temperature, leading to around 0.5% efficiency declining per degree rise in cells' temperature. The water-based PV/Thermal designs are therefore developed to control the temperature of the PV cells, increase the corresponding electrical efficiency during practical operation, and meanwhile make advanced utilization of the waste PV heat [5,6]. Usually, the multiple water flow channel structure is designed for the end-users who have multiple demands in hot air, space heating, agriculture/herb drying or increased ventilation, and electricity generation.

Refrigerant-based BIST technology

Compared to water, refrigerant has properties of lower boiling/freezing, lower viscosity, and higher thermal capacity, which therefore enables to efficiently transfer a larger amount of heat even with a

small amount. In the indirect heat-pump based BIST system, the thermal collector also works as a heat-pump evaporator, which could respond more quickly to the absorption of solar heat even in the poor weather conditions than other BIST types [6-8]. In terms of the refrigerant types, Chlorofluorocarbons (CFC) are the most commonly-applied heat-transfer fluids due to the properties of stability, non-inflammability and non-corrosivity. But CFC has high Ozone Depletion Potential (ODP) and Global Warming Potential (GWP). As a result, the hydrochlorofluorocarbons (HCFC) take the place. Recently, natural fluids, such as propane (R-290), butane (R-600), isobutane (R-600a), propylene (R-600), ammonia (R-717) and carbon dioxide (R-744) have been considered as long-term heat transfer fluid with great environmentally behaviour at a very low or near zero ODP and GWP [3].

In terms of refrigerant types, Chlorofluorocarbon (CFC) refrigerants are more commonly used as heat transfer fluids owing to properties of stability, non-inflammability, and non-corrodity. But CFC has high Ozone Depletion Potential (ODP) and Global Warming Potential (GWP). As a result, the hydrochlorofluorocarbons (HCFC) then takes the place. Recently, natural fluids, such as propane (R-290), butane (R-600), isobutane (R-600a), propylene (R-600), ammonia (R-717) and carbon dioxide (R-744) have been considered as long-term heat transfer fluid with great environmentally behaviour at a very low or near zero ODP and GWP [3].

Refrigerant as the working fluid is more prevalent in the application of PV/thermal system coupled with the heat pump [8]. From the simulation results, it can be found that a lower evaporation temperature was associated with a higher system efficiency because a lower evaporation temperature leads to a lower surface temperature of absorbers for solar cells to override the limitation of electricity generating efficiency, meanwhile the heated refrigerant can be further re-utilized for thermal production with increasing the coefficient of performance (COP) of heat pumps [8].

The heat pipe as a core ensures the advantages as one-directional, two-phase thermosyphons, very low hydraulic resistance, constant liquid flow and isothermal heat absorbing surface. The heat pipe technology has significant development in the evacuated tube collector (ETC) with two basic types of single tube and double tubes. Because of the major drawback of a fragile glass cover, the sole utilization of heat pipe has been introduced to alleviate this problem [9]. And it has been currently brought forward as an individual heat transfer component into the design of BIST systems.

Because of the special characteristics of heat pipe technology, it has been identified that the heat-pipe based BIST system presents a great potential with attractive merits of light weight, easy assembling/installation, high versatility, good scalability, and excellent adaptability to the building design [10]. Currently, there are mainly three types of heat pipes applied in BIST systems, including conventional straight heat pipe, loop heat pipe, and micro-channel heat pipe [11-13] as shown in Figure 4. In practice, as a potential heat transfer medium applied in BIST systems, the heat pipe has to overcome the limitations in on-site assembly requiring higher vacuum degree, and manufacture cost owing to labour intensive processing, meanwhile the difficulties in maintenance and replacement.

PCM-based facade BIST technology

Thermal energy can be generally classified two phases of sensible and latent heat. PCM, because of its higher energy storage density and

BIST Type	Advantages	Disadvantages
Air	Anti-freezing or anti-boiling, and non-corrosive; Low cost; Simple structure;	Low heat capacity; Potential leakage and noise; Lower efficiency; Large mass or volume; High in heat loss.
Water	Nontoxic; High in specific heat; Cost effective; Perform well in cold climates; Almost constant energy collected; Smaller storage volume;	Potential mineral deposits; Possible leakage, freezing, corrosion and overheating; Unstable heat removal effectiveness.
Refrigerant	Small fluid volume; Quick response to solar heat under different weather conditions; Lower vaporization latent heat; Stable performance; High efficiency; Re-utilization	High cost; Unbalanced liquid distribution; Need to consider environmental behavior Requirement of recharging refrigerant.
Heat pipe	Compact and super high heat exchange ability; Low in hydraulic and thermal resistances; Constant liquid flow Isothermal heat absorbing surface Versatility, scalability, and adaptability of the design Small weight Easy assembling and installing	High cost; High degree in vacuum processing; Difficulty in maintenance and replacement
PCM	Improvement in thermal comfort and building envelop; Diversity in building integration;	Difficult to operate; Complex behaviour; Diverse affection factors; Sensitive heat injection;

Table 1: The characteristic comparison of BIST in terms of heat transfer medium

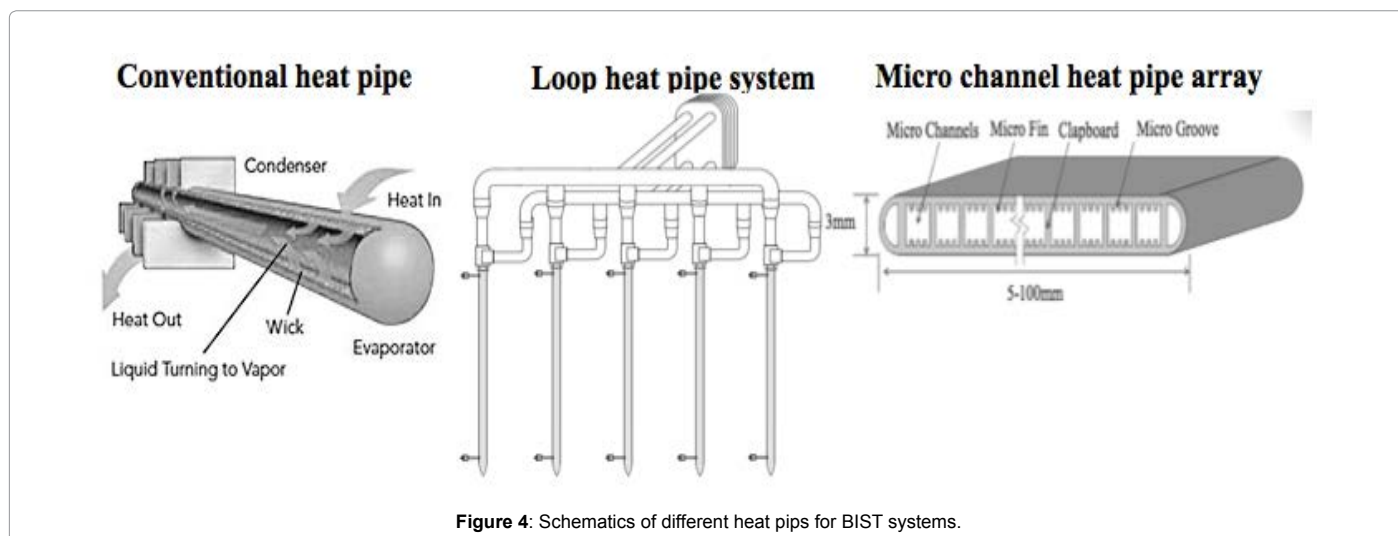

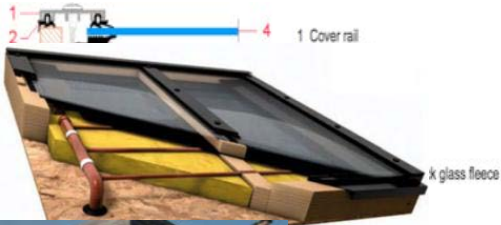

Figure 4: Schematics of different heat pipes for BIST systems.

thermostatic fusion, is particularly attractive in the BIST application due to the two-phase heat transfer process [14]. In recent years, a new technique has been proposed to use the PCM slurry as pumpable heat transfer fluids and as heat storage systems [15-17]. Through microencapsulating and isolating PCM from its surroundings and the carrier fluid, the PCM is less likely to hamper the heat transfer process [18]. Microencapsulated PCM slurry, semi-clathrate hydrate slurry, shape-stabilized PCM slurry and PCM emulsions are the common approaches to form the heat transfer fluids in a range of melting temperature from 0°C to 20 °C [19]. These potentials allow the increase of system energy efficiency, and the reduction of pipe size and collector area, moreover save pumping power consumption due to less quantity of

heat transfer fluids [19]. But till now, more applications of PCM [20-25] have been found in the BIST system for the function of thermal storage with the characteristics of a great thermal energy storage capacity, a high heat transfer property and a positive phase change temperatures. Although the heat transfer of PCM is quite complicated, it has broad prospects for the practical application in the future. Therefore, it still needs more intensive investigation for its function as a heat transfer fluid.

General comparison of different SFT technologies

In general, a comprehensive feature including the advantages and disadvantages of each heat transfer medium based BIST technologies

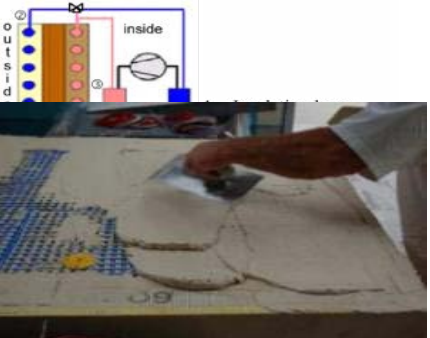
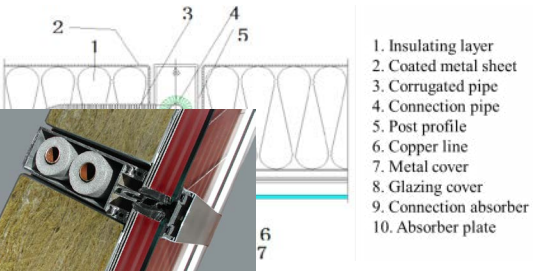
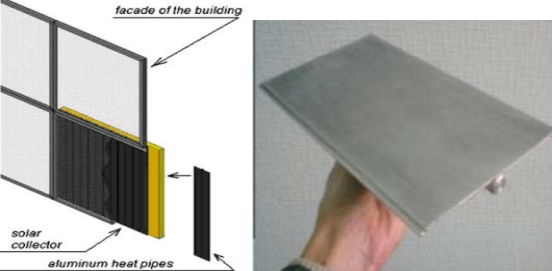
Schematic structure	Description
<p>Wall-based BIST</p> 	<p>“AKS Doma Flex” is a glazed flat plate system and its distinct feature locates in the aluminum absorbers that equipped with a highly selective coating and laser-welded copper pipes that guarantee optimum performance. The wood or aluminum collector frame provides a very high level of freedom in both size and shape as either the facade solutions or the high durable and stable installation for building [31]</p>
	<p>“H+S MegaSlate II” is a glazed flat plate system characterized by both the thickness of 38mm and gluing technique that eases the integration into the building skin and provide a new level of freedom in the field of glazed flat plates. The glazing is glued to the collector structure with the same technique used to glue double-glazing, and the gap is filled with argon gas, which helps reduce heat losses. But no freedom is available in module shape and size, nor in absorber or glazing surface texture/colour [32].</p>
	<p>The unglazed BIST system is composed of a cost effective facade collector coupled to a reversible heat pump for heating/cooling of high-rise buildings. It works as a low temperature solar collector as well as an atmospheric heat exchanger and a night time heat-dissipater to boost the heating/cooling efficiency of the system. The active wall element is a low temperature unglazed solar collector with a capillary mat embedded in the finishing layer of the external insulation of the building. This cost effective solution allows installing the external insulation and the active facade in the same step. A glycol solution circulates in the capillary tubes to transfer heat to the heated room via the storage and the heat pump [33].</p>
	<p>The building integrated solar thermal facade system is fully integrated into an aluminium glass facade and represents the building shell. This kind of BIST consists of a typical glass, thermal absorber, soft connections, pipes with the mullion, insulation and thermal metal panel [34].</p>
	<p>The aluminium profiled heat pipe solar collector consists with the extruded aluminium alloy with heat pipes of original cross-sectional profile and wide fins and longitudinal grooves. The flat absorber plate can be composed of several fins, and the opposite end of heat pipe serves as a heat sink surface. When it's integrated with building, number of heat pipes and their length is optional and can be replaced anytime [35].</p>

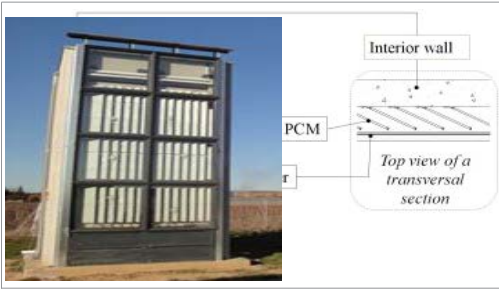

In this BIST system, macro-encapsulated PCM panels are installed inside the air chamber of a ventilated facade. It has multiple operation modes as mechanical or natural ventilation mode. The use of the PCM not only increases the solar energy absorption capacity during winter but it uses as a cold storage system during warm periods to improve the thermal behaviour of the whole building [36].

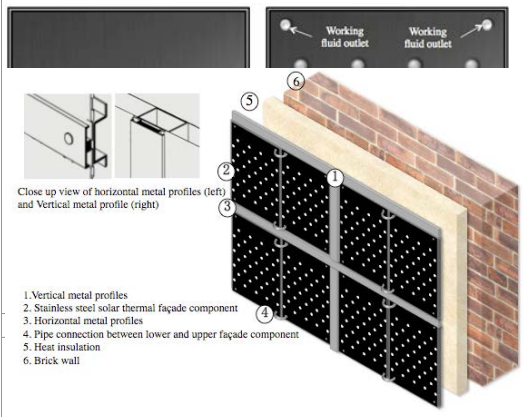

Close up view of horizontal metal profiles (left) and vertical metal profile (right)

1. Vertical metal profiles
2. Stainless steel solar thermal façade component
3. Horizontal metal profiles
4. Pipe connection between lower and upper façade component
5. Heat insulation
6. Brick wall

The thermal absorber [37] is only 5mm wide and is made up by two parallel thin flat-plate metal sheets, one of which is extruded by machinery mould to formulate arrays of mini corrugations, while the other sheet remains smooth for attaching the building wall. A laser-welding technology is applied to join them together, forming up the built-in turbulent flow channels. Such unique compact structure engenders not only high heat transfer capacity but also convenience in rapid assembly and installation. If several absorbers are connected together as a complete larger area of building façade, the question of the connecting arrangement will arise. Therefore, a flexible connection arrangement scheme is proposed through two sets of inlet and outlet around the four corners of the flat plate panel. Basically, there are three kind of arrangements as parallel, series and combined.

Window-based BIST



This new glazing integrated transparent BIST based on low-cost window technology will allow heat generation, visual contact to the exterior and provide solar and glare control in the same time. In summer, this BIST will be used as a heat source for solar cooling systems. The approach is to integrate apertures with angular selective transmittance into the absorber of a solar thermal collector, which is integrated in the transparent part of the facade. These apertures will selectively shield the direct irradiation of the sun (coming from directions with higher solar altitude angles) while retaining visibility through the window horizontally or downwards [38].



This a new vacuum tube solar air collector for facade integration in high-rise buildings bases on many advantages of the heat transfer medium, air like in common building installations. The vacuum insulation of the tubes is responsible for a good thermal efficiency at high operating temperatures and low irradiation. The heat transfer medium, air has an intrinsic fail-safe behaviour without leakage, frost, and stagnation problems, which offers the possibility of reliable, efficient and cost-effective solutions [39].

Balcony-based BIST

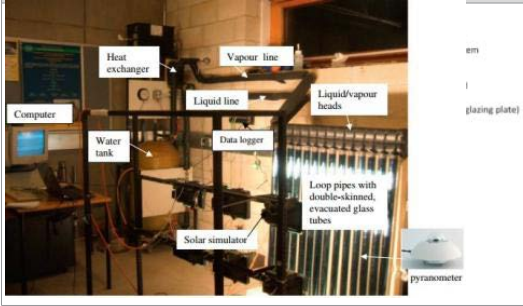

This facade-based solar water heating system employs a modular panel incorporating a unique loop heat pipe (LHP). The outdoor part is a modular panel which receive solar irradiation and convert it into the heat carried by the vaporised heat pipe working fluid, whereas the indoor part is the combination of a flat-plate heat exchanger, a hot water tank, a circulating pump and water piping connections, which raises the temperature of the circulated water by absorbing heat from the heat pipe vapour, resulting in the condensation of the vapour at the exchanger [40].

	<p>WAF's solar balcony is a special version of the BIST. With this design, the facade elements are directly integrated into the front of the balcony. All pipes are placed behind special cover plates. In this way, the visual appearance of the front of the balcony is not compromised [26].</p>
--	---

Sunshield-based BIST

	<p>Ritter XL applies the evacuated tubes with semi-transparent Compound Parabolic Concentrating (CPC) mirrors integrated into facade elements for heating and sun shading. It makes up with the aluminium frame, a borosilicate glass, selective absorber, a CPC mirror, the stainless steel and copper pipes. Because of the absorber form of the evacuated tube, the number and size of the collector is optional and flexible to be customised for solar shading design for building [41].</p>
--	---

Roof-based BIST

<p>wooden frame, open to diffusion insulation, 55 mm SKYTECH-absorber special solar glass with anti-reflective coating (optional) profil system, screwless covered tube connections freely positionable</p>	<p>“VarioSol E Collector System” is a glazed flat plate system using a unique SKYTECH absorber technology, which is made by roll-folding technology connects absorber sheet and tube over the entire circumference leading an optimised heat transfer to the fluid inside. The thin collectors can be simply mounted onto flat roof rather than modified original building structure, providing an optimum solution for building renovation [42].</p>
---	---

<p>glass fixing profile glass support rail glazing double-sided adhesive tape glazing glass support rail absorber aluminium foil thermal insulation</p>	<p>“Genersys” is a flat plate collector consisting of a one-piece forged metal casing, where solar glass is fixed by means of a frame made from non-corrosive aluminium profile. The stamped Al-Mg sheet absorber fins with high-selective conversion layer span the copper pipe meander. The series connected collectors ensures the good options for the building integration as construction or integration elements into sloping roof, stand on flat roof and building façade [43].</p>
---	---

<ol style="list-style-type: none"> 1 Glass fixing profile 2 Sealing 3 Lateral thermal insulation 4 Frame 5 Glazing 6 Glass support rail 7 Absorber 8 Thermal insulation 9 Rear panel 	<p>“COBRA Evo.” is a kind of flat-plate collectors. Then principal design highlights are the highly selectively coated copper absorber plate, which converts most of heat radiation from the sun to the absorber plate, as well as the consistently lasered copper serpentine coil, which makes both the arches and the manifolds thermally active. In virtue of these technologies, the system provides excellent operating performance even under unreasonable climate conditions. In addition, there is a large range of mounting accessories for roof-mounted, stand on flat roof and building façade [44].</p>
---	---

	<p>“QUICK STEP Solar Thermie” is an innovative, low efficiency, unglazed system for roofs. If the system is integrated into the standard Rheinzink QUICK STEP roof covering system, the module look exactly like the traditional non active ones without any field positioning and dimensioning issues [45].</p>
	<p>“Atmova roof tile” is a copper tile or facade component. The working principle is that collecting thermal energy from the ambient air, wind, and rain as well as any available solar radiation and then fed via the pipe system with its heat-transporting fluid to the heat pump. After that the heat pump converts this energy into usable heat for heating and the hot water supply that flows directly into a hot water storage tank and which can be used for immediate consumption. The high-energy yield (500 W/m² and COP> 3.5) with the long lifetime of the system guarantee the above-average economic benefit of the system [46].</p>
	<p>“TECU Solar System” is an innovative integrated copper roof system. The heats transfer fluid in the copper path of collector, capturing the solar heat to produce thermal energy. Because the whole collector is positioned integrally with roof system, therefore it is fully protected from external intrusions and completely invisible [47].</p>
	<p>“SolTech Sigma” is a specially developed tile more transparent active energy roofs. Underneath the glass tiles, the specially developed liquid based absorber modules harvest the energy from the sun, and the generated solar energy ends up in a specific storage tank that is connected to the building’s central heating system [48].</p>

Table 2: Prototypes of different innovative BIST technologies.

can be summarized in Table 1. And further selections of these BIST technologies should be carried out depending on different application scenarios.

BIST Structural Design in Terms of Architectural Element

The basic structure of BIST is originally derived from the conventional solar thermal collectors, as shown in Figure 5, which includes three fundamental configurations as glazed or unglazed flat-plate and evacuate tube shapes. The flat-plate BIST usually compromises a glazing cover (optional), a fluid-cooling thermal absorber, an insulation layer (optional) and the supporting enclosure, whilst the cylinder BIST normally consists of evacuated tubes with fluid-cooling

thermal absorbers inside. The overall BIST system also has a storage tank and additional mechanical devices, such as fans, pumps, complex controllers or other auxiliary devices to redistribute solar energy.

However, the specific structures of the BIST systems are various when they serve as different building elements in practice. This section provides the generally discussion about the typical BIST designs in terms of the architectural element.

Typical BIST structures in terms of architectural elements

Wall-based BIST technology: Figure 6 gives a schematic structure of a sample wall-based BIST, mainly composed with a series of weatherboarding, a connection metal sheet, a group of copper heat-

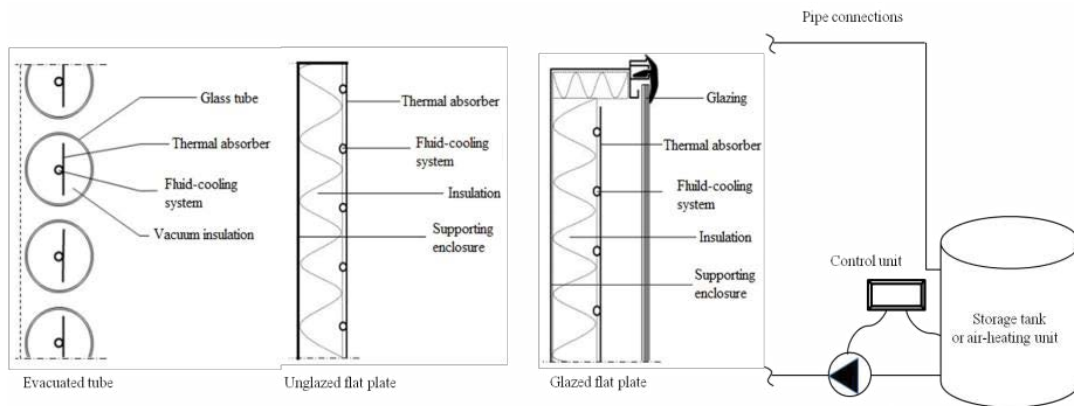

Figure 5: Integration constrains for BIST (non-exhaustive).

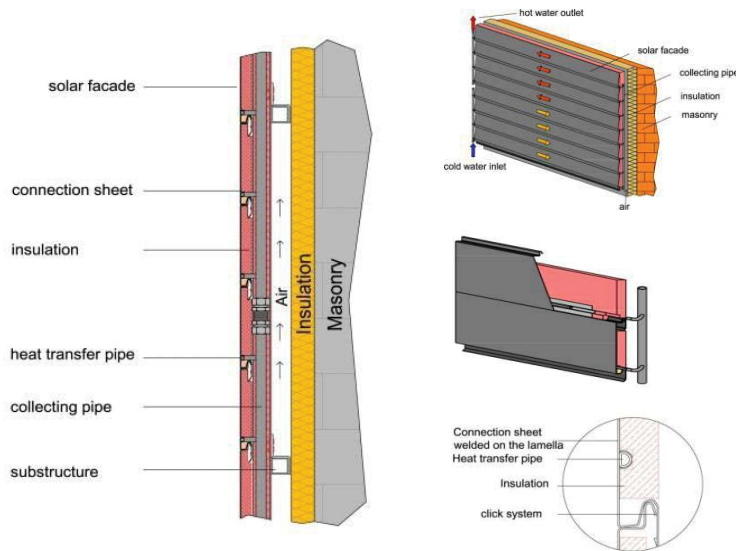

Figure 6: Schematics of BISTs as different building envelope parts with typical examples.

transfer pipe and an insulation layer. The connection metal sheet and the copper pipe are welded into a piece of weatherboarding, which ensures optimum heat transfer performance. A polyurethane (PUR) insulation is usually used at the back of panel to minimise convective heat losses, especially PUR foam is selected to avoid air cavities between the pipe and the insulation. In addition, mineral wool around 50mm in thickness is used for collecting pipes insulation. The coating of the weatherboarding consists of a special solar varnish with an excellent absorption and emission, being extremely weather resistant as well. All the weatherboarding pieces are assembled via the mounting clicks, enabling an easy self-assembly approach. The working principle of such BIST is as same as the conventional solar thermal collectors. Solar energy is optimally converted into thermal energy owing to the selective solar varnish coating. A heat transfer medium, such as a water-glycol mixture, passes through the solar circuit behind the facade elements to transfer heat directly from the absorber. The absorbed heat is further transferred to the heat storage system by a heat exchanger.

Window-based BIST technology: A sample of the semi-transparent

solar thermal window is illustrated in Figure 7. It is a double glazed unit fixed in the window frames with multifunction as glazing system for insulation, natural lighting, domestic hot water and heating and/or air conditioning [27]. This solar thermal window comprises two layers of glass panes, a certain volume of argon filling, a group of -shape profiled thermal absorbers, a copper serpentine pipe with working fluid and aluminium strips. During operation, the solar flux through such window is divided mainly into three parts according to the seasons: (1) directly intercepted by the front part of solar absorber lamellas, which is almost constant all over the year; (2) second part is reflected by the reflectors strips on the back side of the horizontal lamella; (3) final part corresponds to other solar radiation passing on through the glazing unit. The obtained energy is then transferred by water circulation to a thermal exchanger in a storage tank and the hydraulic connections fitted in the frames. Because the solar window composes itself directly into the building envelop, it contributes as well to the thermal and phonic insulation. Apart from the thermal contributions, it can also favours on passive solar heat gain and day lighting supplies in winter

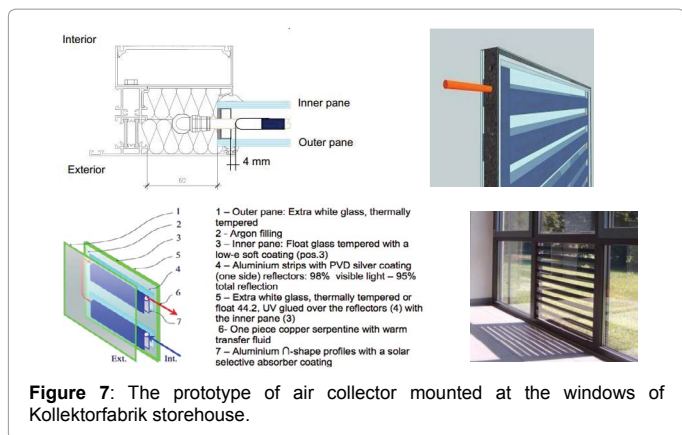

Figure 7: The prototype of air collector mounted at the windows of Kollektorfabrik storehouse.

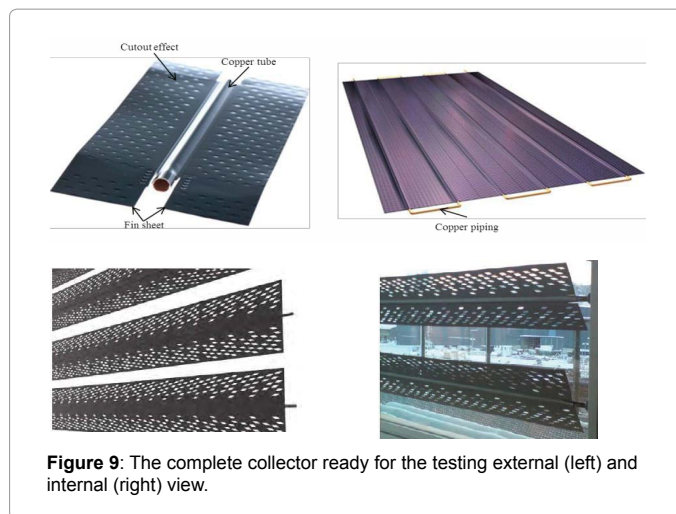

Figure 9: The complete collector ready for the testing external (left) and internal (right) view.

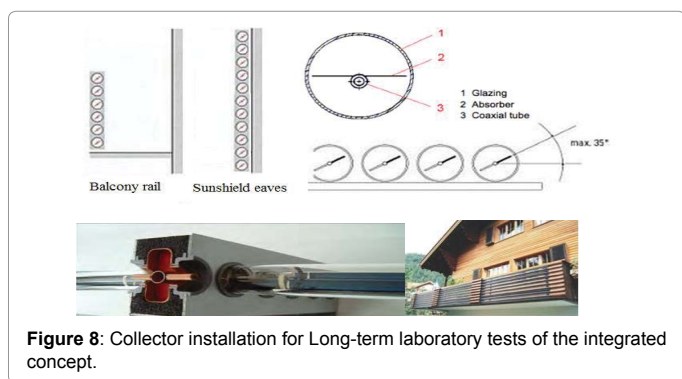

Figure 8: Collector installation for Long-term laboratory tests of the integrated concept.

whereas solar shading and day lighting diffuse in summer.

Balcony -based BIST technology: Figure 8 presents a group of evacuated tubes in a parallel module. Each tube is composed of individual glass tube, a black or black-tube thermal absorber with fluid-cooling system, surrounded by a vacuum interior space. The high-level vacuum insulation minimises the heat losses from the system, enabling such BIST a thermally effective solution. The standard arrangement is a field of several glass tubes with manifold tubes at top and bottom. The tubes are standardized products with easy joining while the number of paralleled tubes can be flexible according to the heat demand or construction size. But the structure and external appearance of the evacuated tubes limit their integration possibilities into the envelope to some extent, but applications like balcony rails or eaves, corridors are promising [28].

Sunshield-based BIST technology: Figure 9 shows a kind of solar thermal absorber strip that is made of aluminium with a metallicly joined copper tube. Resulting from a combination of highly specialised surface, good fin efficiency and excellent heat-transfer properties, this BIST has a high performance. The special rhombic shape of pipe allows a turbulent flow and increased heat-transferring area to increase heat transfer to the heating medium. The flexible size makes the absorbers in either serial or parallel flow as desire. This kind of BIST has specific applications in the Nordic regions within glass, in southern hemisphere without glass [29].

Roof-based BIST technology: Figure 10 shows a sample of the unglazed BIST roof system. Two corrugated stainless steel sheets are welded together to form a thermal absorber with the cushion structure

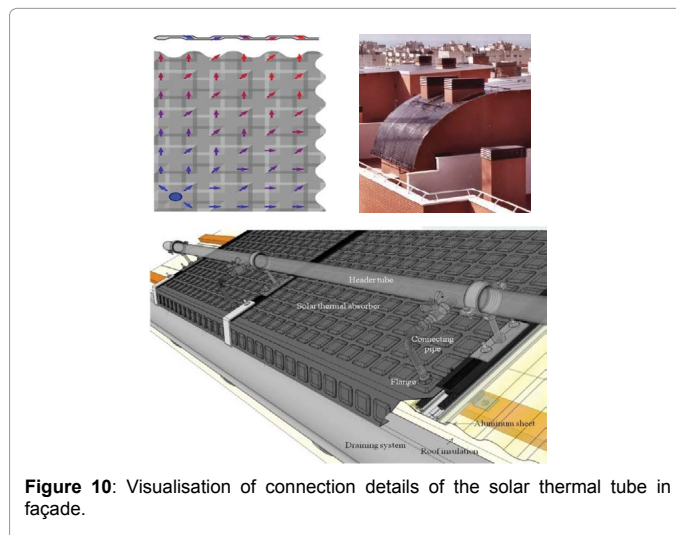

Figure 10: Visualisation of connection details of the solar thermal tube in façade.

upon the rubber roof insulation. The peculiar structure also enables various types of integration on all types of roof profiles, even curved ones. Because of the selective black surface, the roof-based BIST possesses high absorption capacity and low emissivity equal to the flat plate collectors but with a reduced price, and the operating temperatures are between 30 and 50 °C. Compared to previous mentioned BIST, roof-based one has a perfect waterproof quality owing to the self-draining aluminum profiles beneath the solar thermal absorber, which is used to evacuate any possible water infiltration and fix the corrugated BIST on the roof. Its applications covers large-scale hot water pre-heating, swimming pool heating, preheating of heat pumps systems and seasonal storage [30].

Overview of different BIST structures in terms of architectural elements

An overview of the structural design of currently available BIST systems is presented in Table 2 in terms of different architectural elements.

Design Criteria for BIST Technology

Design standards

Generally, the building envelope should provide protection from external conditions, such as solar irradiation, temperature, humidity, precipitation and wind, in order to achieve a pleasant indoor thermal comfort. Therefore, it is vital to take consideration of technical issues, i.e. efficiency, effectiveness, safety, durability and flexibility, together with constructive and formal issues at the early design stage of a BIST system [49].

Regarding as the construction component, there are statutory instruments, directives and standards for the facade application. In European, the currently available standards are: (1) the *Regulation 305/2011* that defines the essential requirements of building construction products placed on the market for an economically reasonable life cycle; (2) *European Technical Approval Guidelines (ETAG)* that seriously address the technical requirements for building components; (3) *Construction Products Directive (CPD)* and *Construction Products Regulation (CPR)* that give the upper and lower limit figures relating to the construction products; (4) *Directive on the Energy Performance of Buildings (EPBD)* that specifies the detailed requirements for building, with extensive impacts to selection and application of a range of construction products. On the whole, BIST is fundamental to possess the construction, hydraulic and hygiene characteristics (listed in Figure 11). In terms of the function, shielding, comfort maintaining and communication availability are the items to be addressed; In terms of the construction concern, protection from external intrusions, load-bearing capability, prevention of thermal bridge and moisture condensation, mechanical stress, stability, energy efficiency, thermal reservation, safety in use, provision to material volume expansion, as well as fitting with other envelop materials are the factors to be considered; In terms of hydraulic concern, prevention from the water leakage, and balance to the hydraulic pressure difference should be considered; And in terms of hygienic concern, health, environmental adaptability should be the issues to be addressed [50]. The common BIST components are relatively heavier than the conventional facade components, therefore risk assessment and management should be particularly addressed for achieving the safe installation. The standards addressing the BIST safety issues are: (1) the *Micro-generation Installation Standard MIS 3001 (Issue 1.5)* and (2) *EST CE131, Solar water heating systems – guidance for professionals – conventional models* [51].

Architectural consideration

A great deal of work has been thoroughly conducted in the technical assessment of BIST systems, such as configuration design, absorber material, paint and coatings, and connection methods etc. [4]. However, the considerations of functional, constructive and formal requirement play a marginal role in the BIST design. It can be briefly articulated into wall-, window-, balcony- and roof-based envelope parts with typical schematic structures illustrated in Figure 12. The advantages and disadvantages of various BIST applications, in terms of functional, constructive and aesthetic aspects, are listed in Table 3.

On basis of the analyses in Table 3, when looking the features for each BIST type from functional, constructive and aesthetic points of view, some conclusions can be made as below. Firstly, the opaque facade is usually composed of multi-layers with functions of external protection and insulation. Such features exactly offset the limitations of flat-plate BIST, which is less flexible in translucency and module

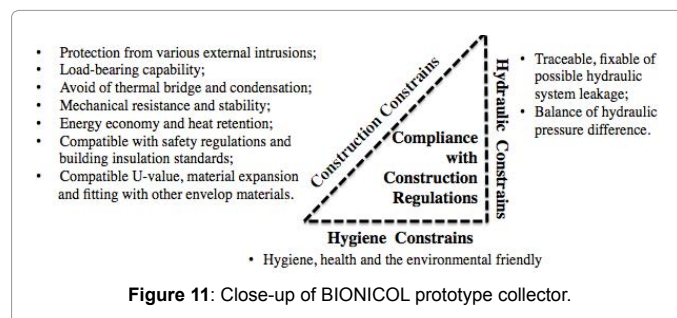

Figure 11: Close-up of BIONICOL prototype collector.

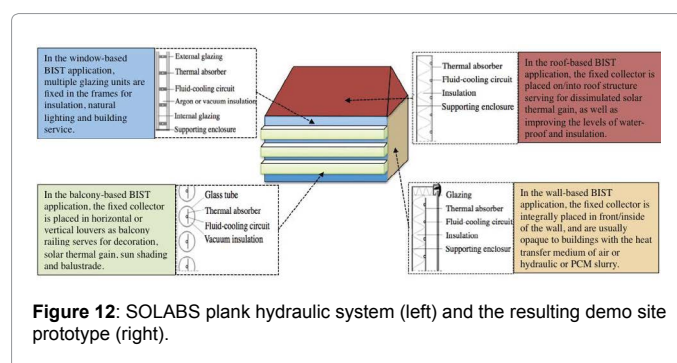

Figure 12: SOLABS plank hydraulic system (left) and the resulting demo site prototype (right).

thickness. Therefore, the wall-based BIST application is especially common in a renovation project as a cladding element with further insulation and protections of weather and mechanical stress. Secondly, the transparent and translucent window-based application concerns more on daylight transmission, outdoor visual relation and partial sun shading. In such case, the light-weighted glazed/unglazed collector or evacuated tubes are recommended to integrate with glazing in an alternating or interlaced pattern to have partial sun shading, or create a dummy effect. Thirdly, the evacuated tube shows more promising applications in the balcony-based integration for its lightweight, higher efficiency and convenience in assembly and pipe connections. Finally, roof has the great popularity for the installation of BIST systems. It gives the superiority in dissimulating solar collector, higher solar thermal yield, and convenient installation methods.

Operation Conditions of BIST Systems

The proper control of operational conditions, such as temperature and flow rates, is usually an important factor for the performance enhancement of BIST systems [52]. Solar radiation is not the significant affecting factor for the efficiency of air based solar collectors [53], whilst the airflow distribution and the upward heat loss caused by the ambient wind and the approach velocity have considered closely affecting the operation performance of air-based BIST system. Gunnewiek et al. [54] studied the airflow distribution on the face of an unglazed solar thermal collector in a computational fluid dynamics (CFD) model at a constant wind speed of 5 m/s. The wind was found to reinforce the factors producing outflows, and the recommended minimum average suction velocity required to avoid such outflow were given for four operating conditions. Fleck et al. [55] experimentally studied the effects of the ambient wind on working performance in regard of wind direction, speed and fluctuation intensity on an unglazed solar collector. The measurements indicated that a high magnitude of turbulence dominated the near wall, and the maximum collector

Envelop part	Advantages	Disadvantages
<p>Wall-based</p> 	<ul style="list-style-type: none"> • An economical and high efficient solution to embed an active solar collector in the finishing layer of the external insulation; • Lessen climate disturbance of original facade unit; • Improving thermal insulation of the building; • Offset against the cost of conventional facade. • Most solar collecting area; • Simplify in the piping arrangement; • Well suited for superimpose in an existing building; • High grade of pre-fabrication possible; 	<ul style="list-style-type: none"> • Renewable energy components require high demands in self quality, material expansions compatible and installation due to totally external exposure; • More costs for outdoors' cleaning and maintenance; • Risk of condensation and thermal frost within insulation; • Cold bridge and acoustic problems at a penetration hole; • Additional imposed static/wind that require additional fixed structures.
<p>Window-based</p> 	<ul style="list-style-type: none"> • If the renewable energy component is placed within a cavity of glazing unite, it has no reduced life expectancy; • Regulating the visual relations inside/outside and the supply of fresh air / daylight and passive solar gains; • High grade of pre-fabrication possible; 	<ul style="list-style-type: none"> • Low light transmission through renewable energy components; • Additional moveable shading in clear vision area is necessary; • Have risks in reducing life expectancy caused by water leakage, or thermal breakage and expansion under high temperature.
<p>Balcony/ Sunshield-based</p> 	<ul style="list-style-type: none"> • Optimum overall shading with full room height visions allows an adequate daylight distribution; • Energy output independent for orientation and solar angle for the vacuum tube collector; • Easy cleaning and maintenance; • Making solar energy visible; • Well suited for superimpose in existing building; • High grade of pre-fabrication; • Offset against the cost of shading. 	<ul style="list-style-type: none"> • Renewable energy component requires high demands in both quality and installation due to totally external exposure for both overall performance and safety aspect; • Additional moveable shading in clear vision area is necessary; • Additional support structure is needed.
<p>Roof-based</p> 	<ul style="list-style-type: none"> • Simplify in the piping arrangement; • Lessen climate disturbance of original roof structure; • Improving the roof's thermal insulation; • Less costs for outdoors' installation, cleaning and maintenance. 	<ul style="list-style-type: none"> • Additional imposed static, wind, snow load that require additional fixed structures and load assessments; • Have risks in reducing life expectancy caused by water leakage or thermal breakage and expansion under high temperature.

Table 3: Characteristics of BIST integration with building.

efficiency occurred at the wind speeds between 1 and 2 m/s instead of non-wind speeds. Kumar et al. [56] conducted a two-year field study focusing on the relation between wind induced convective heat transfer and upward heat losses in unglazed collectors. The estimated wind heat transfer coefficient has been found to correlate to the wind speed by linear regression and power regression. Shukla et al. [57] reported that the increasing in wind velocity (below 2 m/s) increases collector efficiency; but as the wind velocity exceeding 7m/s, effects on efficiency becomes negligible.

For the hydraulic-based BIST system, mass-flow rate is considered as a variable for the extraction of maximum exergy, which can lead to

identification of inefficient parts and optimum operating conditions. Although the present control methods that regulate the outlet temperature of the collector field by suitable adjusting the working fluid flow may ensure a smooth operation [58], but the reported experimental results were usually around 3% for the maximum exergetic efficiency. Badescu et al. [52] implemented a direct optimal control method in a detailed collector model with realistic meteorological data. The proposed operation at a properly defined constant mass-flow rate may be necessarily associated to the maximum exergy extraction, but it required a priori knowledge of meteorological data time series. A lot of analyses were presented in a general simulation model for the optimal design and operating parameters of solar collectors [59]. Apart from

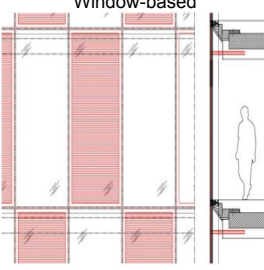
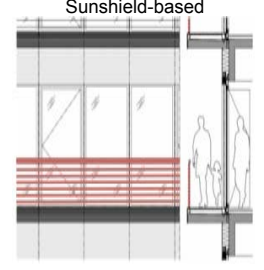
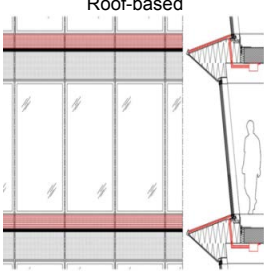
forementioned assumptions either assuming a constant overall heat loss coefficient or considering the fluid inlet temperature equals to the ambient temperature, Jafarkazemi et al. [60] both compared and evaluated the energetic and exergetic performance of a flat plate solar collector. Based on the theoretical results, it was obvious that energy and exergy efficiencies have conflicting behaviours in many cases. Designing the system with inlet water temperature approximately 40°C more than the ambient temperature as well as a lower flow rate can enhance the maximum energy and exergy efficiency close to 80% and 8%, whereas thickening back insulation over 5 cm has little effect on both energy and exergy performances.

High temperature is detrimental to the reliability, durability and safety during operation. Normally, well-insulated glazed flat-plate collectors achieve maximum stagnation temperatures of 160–200°C, evacuated tube collectors 200–300°C [60]. Solar overheating problem may occur within BIST systems for a number of reasons, such as oversized capacity, no way of dumping the excess heat, low pitched solar collectors, switching on the electric backup immersion heater for long periods etc. But it's basically because the hot water being produced is far greater than the actual demand [61, 62]. Fan et al. [63] elucidated the relation between operating conditions, such as flow rates and properties of working fluid and heat transfer condition in a glazed solar collector. The decreased flow rate and decreased content of glycol in the glycol/water mixture were discovered to lead a growing risk of overheating in the upper part of the collector panel. The magnitude of the stagnation temperature for any solar collector depends on the solar insolation level and the ambient air temperature [64], therefore many approaches have been tried to avoid the overheating of both solar absorbers and the BIST system. Except for the simply approaches like utilizing high temperature tolerant components, venting or shading absorbers, a more intelligent method is to purposely degrade the optical performance. The relevant techniques are optical switches based on scattering layers, thermotropic layers and temperature varied particle solubility fluids [65]. In order to block the direct light into the collector, a prismatic structure based solar thermal collector was proposed under the principle of switchable total reflection. The experimental study indicated that the maximum temperature inside the collector can be regulated by thermal evaporation or manual regulation of the switching fluid level near the prisms, and there was a strong light reducing effect around noon with less sensitivity

for seasonal changes [66]. On the other side, the enhancement of heat transfer using oscillatory which flows to prevent the overheating phenomenon is another way to degrade thermal performance from a solar thermal system aspect [67]. The preliminary estimations showed a dramatic heat transfer enhancement using oscillatory flows compared with the forced convection of heat by standard unidirectional flows. Furthermore, Harrison et al. [64] proposed a summary and overview of stagnation control from both the collector level and the system level approaches as listed in Table 4. To optimise the performance of the latent heat storage in solar air heating system, Arkar et al. [68] studied the relations among PCM melting temperatures, air flow-rate by the thermal storage of solar air heating system. Based on the transient conduction-dominated numerical model, the optimal air flow-rate of 40m³/h- m² was suggested.

BIST Pilot Project Application

Practical applications

This section summarises the pilot projects within the scope of the successful BIST building integration. The pilot projects are further expected to give an outlook of current and possible future combinations of solar thermal technologies with the passive building design concept towards green building or net zero energy buildings. Table 5 presents a list of representative BIST incorporated projects at a current stage, which is based on various types of buildings. Detailed descriptions are given in each project.





Critical analysis





The above mentioned BIST devices has created a considerable energy saving prospective, and endorses an innovative solar thermal approach for building integration with efficient and durable devices, variable choices of colour and texture and mature processing techniques. The pilot BIST projects show how the synergic collaboration between manufacturers and researchers can be. Diverse directions with miscellaneous motives have led to a lot of different BIST building integration variations. The core element of a BIST system in the above buildings has exhibited a high energy capacity, and the end users therefore benefit of an attractive pay-back time on their investment.



However, the shortfalls in current BIST systems are primarily:





Stagnation Control Scheme	Protects Collectors?	Protects System Components?	Fail-safe Operation?	Cost Impact?	Performance or durability Impact?
Drain-back or drain-down	No	Yes	Yes (must be installed to drain completely if also used for freeze protection)	Pumping power consumption may be increased	Collector loop open to atmosphere may increase corrosion or fouling
Control based (e.g., night heat rejection, recirculation etc.)	Yes	Yes	No. (requires active control and pumping)	Not for hardware. (additional pump use & potential energy loss)	May result in available energy being dumped at night
Steam Back	Not always	Not always	Yes (careful design and placement of system components required)	Expansion tank may have to be oversized	Potential thermal shock/scalding on restart
Collector Venting (Integral to collector)	Yes (if carefully designed)	Yes (if carefully designed)	Yes (for thermally activated versions)	Modest hardware cost	May experience small performance penalty if not carefully implemented
Heat Waster on Collector loop	Yes	Yes	Some designs operate passively - others require power or pumps, fans etc.	Significant hardware cost	If powered may require aux. generators or PV
Heat pipe control (Evacuated-tube collector)	No	Yes	Yes (for thermally activated versions)	Modest Hardware cost	System may be inoperable for remainder of day

Table 4: Summary and overview of some collector and system level approaches to stagnation control.

Category 1: Family house & apartment cases		
No. 1 "Home for life" concept house, Aarhus, Denmark		
<p>This project dissimulates BIST within the roof to form a kind of active house with a living area of 190 m². The total solar collecting area of 6.7m² is integrated in the lowest part of the roof surface with an auxiliary heat pump system, which directly supply 50-60% of the yearly household hot water heating demand as well as a supplement for downwards room heating.</p>	 <p>Picture source: VKR Holding A/S</p>	Picture
No.2 House J, single family house, Nenzing, Austria		
<p>This project exhibits the building integration issue between dummy elements and the glazed flat plate collectors. A dark blue cladding is chosen as finishing to best cope with the imposed dark blue appearance of 12 m² solar collectors mounted on the south facade. Due to the use of similar collector size fitting with the modular rhythm of standard cladding, and the same types of jointing, the homogeneity of colour size and jointing makes two parts of facade component acceptable.</p>	 <p>Picture source: Domasolar</p>	
No.3 Row dwelling I-Box concept building, Tromsø, Norway		
<p>The whole design is paid considerable attention to various building materials, forms, and colours of the architectural composition of envelope without an abrupt BIST appearance. Each 5 m² BIST system is whole integrated with each residential units.</p>	 <p>Picture source: Viessmann</p>	
No.4 Sunny woods, apartment house, Zürich-Höngg, Switzerland		
<p>The whole BIST application is natural and plain in the integration design with simple accessible external connections. The solar-tube collectors act as a transparent baluster for the balcony, while the valuable sunshine can be stored through windows into a stone flooring.</p>	 <p>Picture source: solaripedia</p>	
No. 5 Jadarhus ISOBO Aktiv, Sandnes, Norway		

<p>The BIST looks like mosaic tiles inserted in the timber roof of the traditional rafter construction with a total living area of 178 m² and an annual heat demand of 44kWh/m². The solar collectors make up an area of 8 m² as the roof surface for 90% of hot water preparation and 95% of space heating.</p>	 <p>Picture source: Jadarhus AS</p>	
<p>No. 6 2-flat penthouse in Vienna, Austria</p> <p>As a project of sustainable renovation, this ingenious BIST application with two direct flow vacuum tube collectors of 2.88 m² is installed at the roof terrace area as an innovative, modern, solar pergola. It has multi-functions as hot water production, sun shading and pergola. This project exhibits a special case of building integration from the overall architectural concept.</p>	 <p>Picture source: Viessmann</p>	
<p>No. 7 Sun house, Tyrol, Austria</p> <p>There are two groups of inclination installations in this project as on the roof with 45° inclination for a maximum yield in the summer, and in the facade with 70° inclination for a maximum yield in the winter. Therefore it shows a good exhibition for both the solar thermal collectors and the photovoltaic modules perfectly adapting into the house.</p>	 <p>Picture source: SIKO SOLAR GmbH</p>	
<p>No. 8 KOMBISOL® house, Tyrol, Austria</p> <p>This BIST application shows a perfect example of cladding façade by 70m² solar collectors and the thermal mass storage by concrete. The whole solar thermal façade can provide needed energy for hot water preparation and space heating with an additional geothermal heat pump. When there is excess energy from the solar thermal collectors, it can be not only stored in the ground collectors but also in the concrete core of the house, which enables a comfortable and warm climate in winter and also a cooling function in summer.</p>	 <p>Picture source: SIKO SOLAR GmbH</p>	

<p>No. 9 Passive house Caldonazzi, Austria</p>	
<p>25% BIST installation is mixed with 75% insulated windows on the south facing façade to realize the energy concept of minimization heat loss from good insulation, passive solar energy and energy from solar collectors. The solar system with 17m² solar collectors is a combined system for both hot water preparation and space heating. It was calculated that the building cost was 1.4 Euro/m² in all.</p>	<p style="text-align: right; font-size: small;">Picture source: AEE INTEC</p>  <p style="text-align: center;">Picture source: AEE INTEC</p>
<p>No. 10 Passive house Rudshagen, Oslo, Norway</p> <p>This project utilizes the high performance polymer collectors (19.5 m²) in the south facing facade of the "solar house" to satisfy both space heating and domestic hot water preparation, which is 61 kWh/m²/year in total heat demand. This BIST application is benefit from lightweight collectors for easy domestic installation.</p>	 <p style="text-align: center;">Picture source: Aventa AS</p>
<p>No. 11 Petersbergenstrasse, Austria</p> <p>This project exhibits us a case of prefabricated BIST system to streamline installation. The 50 m² wall based glazed flat plate solar collectors has been erected 10° southwest oriented for DHW preparation and space heating. These pre-manufactured fields are made by fixing the wooden back wall of the collector to the timber frames with only about 10 steel angles for the fixation, which causes almost no effect on thermal bridges.</p>	<p>Picture source: AEE INTEC</p> 
<p>Category 2: Commercial & public building cases</p>	
<p>No. 12 Alpiner Stützpunkt Schiestlhaus of the Austria Tourist Club, Austria</p>	

<p>This project is a special utilization of BIST system for the first large mountain refuge building with the capacity to accommodate 70 people. The specialty lies in the upper south-facing facade designed as an energy-facade system for the generation of thermal energy. Through the heat exchanger, the solar collector transfers heat to three buffer storage tanks with a total capacity of 2,000 litres. Besides, both a rape oil operated unit and a solid fuel range can also load heat into the buffer storage tanks.</p>	 <p>Photo: DI Wilhelm Hofbauer/ Treberspurg & Partner Architekten</p>
<p>No. 13 Retrofitted Office Building in Ljubljana, Slovenia</p>	
<p>This is a detail designed retrofitting project with BIST application. The air heating vacuum tube collectors replace the balustrade on the fifth floor, while the transparent solar thermal collectors are attached to the stairwell. Both collector areas face almost south, the solar collectors 15° towards east and the air-heating tubes 15° towards west. Both components are developed to be a substitute for the building skin as well as the thermally activated building system of 100 m² office space with fluid at temperatures above 35 °C during the heating season.</p>	 <p>[55]</p>
<p>No. 14 HQ, AKS DOMA Solartechnik</p>	
<p>This project realizes the neutral CO₂ energy supply for the 470 m² offices and the 1,380 m² production hall through the BIST application. The total 80m² BIST system provides the whole heating through a wall heating and a floor heating operated with very low flow temperature, which offers ideal conditions for the operation of the solar thermal plant.</p>	 <p>Picture source: AEE INTEC</p>
<p>No. 15 Hotel Jezerka, Czech Republic</p>	
<p>This BIST application pays special consideration to the horizontal installation with 236m² solar collectors in the south facing balconies for heating tap water and swimming pools. These collectors were designed as handrails of balconies, or as flat roofs where vertical collectors would be overloaded by wind. The price of each collector was € 364.8 with total solar gain of 120 000 kWh/year</p>	 <p>Photo: Thermosolar</p>
<p>No. 16 Environmental Research Station Schneefernerhaus - UFS, Germany</p>	

This retrofitting project with BIST system is located at Germany's highest mountain from a stone building into a research station. With adding additional thermal insulation, 100m² solar collectors were integrated in the building facade as well for both DHW preparation and space heating. The related water based heat distribution consists with floor heating and radiators, while heat pumps and electricity are set for auxiliary heating. The price of each collector was € 943 with total solar gain of 60 000 kWh/year.



Photo: Fraunhofer ISE (Fraunhofer Institute for Solar Energy Systems)

No. 17 Granby Hospital, Granby (Quebec) / Canada

This application is one of the few air-based BIST systems. The transpired solar fresh air heating system in this hospital is specially designed to satisfy the demand of large amounts of fresh air. The solar system is aesthetically presented with 82 m²-curved facades to provide 8160 m³/h to the space below. The working principle is that the perforated metal absorber draws in heated fresh air off the surface of south-facing walls, where it is then distributed throughout the building as pre-heated ventilation air. Overall, the system owns operating efficiencies up to 70% with total payback's within 5 years with energy savings about 149.1GJ.

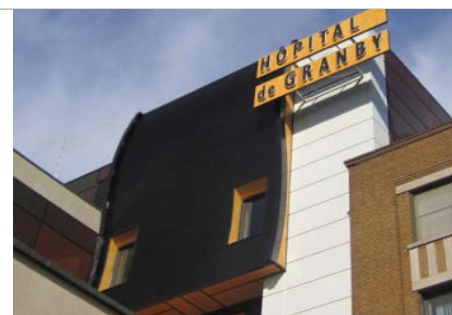

Photo: Matrix Energy

No. 18 Social housing in Paris, France

This is the first social house building with BIST application. The new multifunctional semitransparent collector encapsulated into a double skin facade, which weights 45kg, offers complete privacy from the passengers commuting nearby, ensures light penetrating into the back of room, as well restricts the noise flow. Besides, the solar panel captures solar energy to produce enough power to meet 40% of the domestic hot water needs providing 44% of domestic hot water needs.





Photo:ROBIN SUN

No. 19 The Bellona Building, Oslo, Norway

This building is constructed of in situ concrete with facades in plaster and glass. The installation shapes of solar collectors serve as the self-shading facade and cover large parts of the south-facing wall. There are windows on the inward-facing part and 240 solar collectors on the outward-facing part. Owing to good insulation, excellent window, minimized thermal bridge and low air leakage factor, solar collectors and geothermal heat pump can cover all the heating demand.



Photo: Finn Staale Feldberg

<p>No. 20 School building in Geis, Switzerland</p> <p>This is another successful prefabricated BIST application. Because of early design phase intervention, designers paid considerable attention to the facade design, layout, size and the fixed modular dimensions of the solar collectors. The total 63 m² collector field fully respects the rhythm of window openings and the colour of both window frame and concrete bricks, showing a convincing result.</p>	 <p>Photo: Schweizer-metallbau</p>
<p>No.21 The centre d'exploitation des Routes Nationales (CeRN), Bursins, Switzerland</p>	
<p>In the south-facing facade, a large area of stainless steel unglazed metal collectors is utilized as multifunctional facade claddings for floor heating, hot water production and an excellent corrosion-resistant building element as well. This BIST application harmonized all the active and non-active panels with stainless steel elements of same dimension and appearance, therefore they fit the modular demands of the building. The active solar panels weigh about 10 kg/m², an important consideration for easy assembly.</p>	 <p>Photo: Energie Solaire SA</p>

(1) most concepts of absorber parts in the BIST are directly inherited from the conventional solar thermal collectors, which exist instability under long term weather exposure, difficulty in both on-site assembly and practical application and complexity in fluid channel structure resulting in the bulk volume and fragile for the BIST application; (2) most BIST design that only functions as a structural cladding element of glass curtain-wall, rooftop, or traditional wall surface; (3) limited considerations are given to the irregular geometry, colour and texture design leading to boring building appealing; (4) lack of building related studies in terms of lighting pollution, acoustic effect, structural load and thermal performance etc. Typical strategies can be assigned to dissimulation into building envelope, special placement and modular building component design. Furthermore, it can be found that the majority of new building projects are solar house or passive house, while those renovation projects provide a new direction of multi-functional transformation instead of sole repairing. More focuses have been put on threatening resource shortage, comfort living environment as well as position architectures themselves in the former niche. It is worthy of mention that as an innovative choice of multifunctional building envelope, BIST has superiority in good insulation, ability of capturing solar heat and high compactness, which fully satisfies the current boom branch of green buildings and zero energy buildings.

Conclusion

This paper presents an overall review of the currently available BIST systems and their applications by emphasizing on structural design and architectural integration. Different BIST systems in terms of the working medium, i.e., air, hydraulic (water/heat pipe/refrigerant) and PCM, are fully described. The fundamental structure of BIST derived from the conventional solar thermal collectors includes three basic configurations as glazed or unglazed flat-plate and evacuate tube shapes. However, the specific structures of the BIST systems are various when they serve as different building elements in practice. Some design criteria including efficiency, safety, durability and flexibility, and constructive issues at the early design stage of a BIST system are introduced. The practical operation conditions of BIST systems are also discussed. There are many advantages by using the BIST systems, whose aesthetics and building envelope characteristics can match that of existing building products and therefore hasten their adoption to buildings. These systems can also provide substantial savings to the building or home owners from reduced heating, maintenance and repair costs.

Through the comprehensive literature review looking into the BIST structural design and their architectural integrations, the assessment indicates a promising future for considerable energy saving with a potentially broad market. However, there are still barriers existing in those systems: (1) most concepts of absorber parts stayed

in the conventional solar thermal system. When applied as a BIST component, it has to face the instability under a long term weather exposure, difficulty in both on-site assembly and practical application, complexity in fluid channel structure resulting in the bulk volume and fragile as multi-function building facade; (2) most BIST design that only functions as a structural cladding element of glass curtain-wall, rooftop, or traditional wall surface; (3) limited considerations are given to the irregular geometry, colour and texture design leading to boring building appealing; (4) lack of building related studies in terms of lighting pollution, acoustic effect, structural load, thermal performance and types of jointing etc.

To break through above limitations and achieve a broader market deployment, new BIST technologies are still desired to emerge urgently. Further appropriate recommendation for the related research development in terms of structural design and architectural integration would be: (1) integration of structural and finish materials together to work as true building material; (2) compulsory structural/rigidity test for the BIST serving as a load bearing structural element; (3) development of light-weight and long-life polymer materials to replace the current promising materials, like metal, glass and ceramic, to minimize loads on existing architectural structure; (4) integration of BIST design into architectural or life-cycle design tools (such as BIM - building information modelling) to quickly assess the appropriate structure and integration method of a BIST system for building.

This review shall facilitate the development of solar driven, distributed (or centralised) service for buildings, which would lead to the corresponding saving in fossil fuel consumption and the reduction in carbon emission.

Acknowledgement

The authors would acknowledge our sincere appreciation to the financial supports from the Ningbo Natural Science Foundation (2015A610039).

Reference

1. ESTTP European Solar Thermal Technology Platform (2009) Solar Heating and Cooling for a Sustainable Energy Future in Europe. European Solar Thermal Technology Platform.
2. Kalogirou SA (2004) Solar thermal collectors and applications. *Progress in Energy and Combustion Sci* 30: 231–295.
3. Shukla R, Sumathy K, Erickson P, Gong J (2013) Recent advances in the solar water heating systems: A review. *Renew Sustain Energy Rev*: 173–90.
4. Zhang X, Shen J, Lu Y, He W, Xu P, et al. (2015) Active Solar Thermal Facades (ASTFs): From concept, application to research questions. *Renew Sustain Energy Rev* 50: 32–63.
5. Tripanagnostopoulos Y (2007) Aspects and improvements of hybrid photovoltaic/thermal solar energy systems. *Solar energy* 81: 1117–1131.
6. Zhang X, Zhao X, Smith S, Xu J, Yu X, et al. (2012) Review of R&D Progress and Practical Application of the Solar Photovoltaic/Thermal (PV/T) Technologies. *Renew Sustain Energy Rev* 16: 599–617.
7. Chen Xi, Hongxing Y, Lin Lu, et al. (2011) Experimental studies on a ground coupled heat pump with solar thermal collectors for space heating. *Energy* 36: 5292–5300.
8. Zhao X, Zhang X, Riffat S, et al. (2011) Theoretical investigation of a novel PV/e roof module for heat pump operation. *Energy Convers Manag* 52: 603–614.
9. Chen K, Oh SJ, Kim NJ, Lee YJ, Chun WG (2010) Fabrication and testing of a non-glass vacuum-tube collector for solar energy utilization. *Energy* 35: 2674–2680.
10. Zhang X, Zhao X, Shen J, et al. (2014) Dynamic performance of a Solar Photovoltaic/Loop-heat-pipe Heat Pump Water Heating System. *Appl Energy* 114: 335–352.
11. Boris R, Sergii K, Rostyslav M, Olga A, Andrii R (2013) Solar Collector Based on Heat Pipes for Building Facades. *Smart Innovation, Systems and Technologies* [Internet]. Berlin, Heidelberg: Springer Berlin Heidelberg: 119–126.
12. He W, Hong X, Zhao X, Zhang X, Shen J, et al. (2015) Operational performance of a novel heat pump assisted solar facade loop-heat-pipe water heating system. *Appl Energy* 146: 371–382.
13. Deng Y, Zhao Y, Wang W, Quan Z, Wang L, et al. (2013) Experimental investigation of performance for the novel flat plate solar collector with micro-channel heat pipe array (MHPA-FPC). *Appl Thermal Engg* 54: 440–449.
14. Zhao CY, Lu W, Tian Y (2010) Heat transfer enhancement for thermal energy storage using metal foams embedded within phase change materials (PCMs). *Solar energy* 84:1402–1412.
15. Delgado M, Lázaro A, Mazo J, Marín JM, Zalba B (2012) Experimental analysis of a microencapsulated PCM slurry as thermal storage system and as heat transfer fluid in laminar flow. *Appl Thermal Engg* 36: 370–377.
16. Zhang Y, Wang S, Rao Z, Xie J (2011) Experiment on heat storage characteristic of microencapsulated phase change material slurry. *Solar Energy Materials and Solar Cells* 95:2726–2733.
17. Qiu Z, Zhao X, Peng Li, et al. (2015) Theoretical investigation of the energy performance of a novel MPCM (Microencapsulated Phase Change Material) slurry based PV/T module. *Energy* 87: 686–698.
18. Alvarado JL, Marsh C, Sohn C, Phetteplace G, Newell T (2007) Thermal performance of microencapsulated phase change material slurry in turbulent flow under constant heat flux. *Int J Heat Mass Transfer* 50: 1938–1952.
19. Youssef Z, Delahaye A, Huang L, Trinquet F, Fournaison L, et al. (2013) State of the art on phase change material slurries. *Energy Convers Manag* 65:120–132.
20. Tyagi VV, Buddhi D (2007) PCM thermal storage in buildings: A state of art. *Renew and Sustain Energy Rev* 11:1146–1166.
21. Koschenz M, Lehmann B (2004) Development of a thermally activated ceiling panel with PCM for application in lightweight and retrofitted buildings. *Energy and Buildings* 36: 567–578.
22. De Gracia A, Navarro L, Castell A, Ruiz-Pardo Á, Álvarez S, et al. (2013) Experimental study of a ventilated facade with PCM during winter period. *Energy and Buildings* 58: 324–332.
23. Saman W, Bruno F, Halawa E (2005) Thermal performance of PCM thermal storage unit for a roof integrated solar heating system. *Solar energy* 78: 341–349.
24. Diarce G, Urresti A, García-Romero A, Delgado A, Erkoreka A, et al. (2013) Ventilated active facades with PCM. *Appl Energy* 109: 530–537.
25. Rodriguez-Ubinas E, Ruiz-Valero L, Vega S, Neila J (2012) Applications of Phase Change Material in highly energy-efficient houses. *Energy and Buildings* 50:49–62.
26. <http://www.waf.at/>
27. <http://www.robinsun.com/>
28. <http://www.schweizer-energie.ch/html/index.html>
29. <http://en.solar.com/ProductApplicationAreas/SunstripStripsforcollectors/tabid/307/Default.aspx>
30. <http://www.energie-solaire.com/>
31. <http://www.domasolar.com/>
32. <http://www.hssolar.ch/>
33. <http://www.cost-effective-renewables.eu/publications.php?type=brochure>
34. <http://www.heliopan.info/Galerie/>
35. Rassamakin B, Khairnasov S, Zaripov V, Rassamakin A, Alforova O (2013) Aluminum heat pipes applied in solar collectors. *Solar Energy* 94:145–154.
36. PG. Prototype for transparent thermal collector for window integration (2011) European Community Seventh Framework Programme. Seventh framework programme cooperation - theme 4: D3.1.2.
37. Xu P, Zhang X, Shen J, et al. (2015) Parallel experimental study of a novel super-thin thermal absorber based photovoltaic/thermal (PV/T) system against conventional photovoltaic (PV) system. *Energy Reports* 1: 30–35.

38. Probst MCM (2008) Architectural integration and design of solar thermal systems. PhD thesis of école polytechnique fédérale de lausanne.
39. <http://www.cost-effective-renewables.eu/>
40. Wang Z, Duan Z, Zhao X, Chen M (2012) Dynamic performance of a facade-based solar loop heat pipe water heating system. *Solar Energy* 86:1632–1647.
41. <http://ritter-xl-solar.com/en/home/>
42. <http://www.winklersolar.com/>
43. <http://www.genersys-solar.com/>
44. <http://www.soltop.ch/de/home.html>
45. <http://www.rheinzink.ch/>
46. <http://www.atmova.ch/vorteile00.html>
47. http://www.kme.com/en/product_lines_intended_for_alternative_energies
48. <http://soltechenergy.se/>
49. <http://solarthermalworld.org/sites/gstec/files/standardisation.pdf>
50. Roecker C, Munari M, de Chambrier E, Schueler A, Scartezini JL (2009) *Facade Integration of Solar Thermal Collectors: A Breakthrough*. Berlin, Heidelberg: Springer Berlin Heidelberg: 337–341.
51. Ridal J, Garvin S, Chambers F, Travers J (2010) Risk assessment of structural impacts on buildings of solar hot water collectors and photovoltaic tiles and panels – final report [Internet].
52. Badescu V (2007) Optimal control of flow in solar collectors for maximum exergy extraction. *Int J Heat Mass Transfer* 50: 4311–4322.
53. Leon MA, Kumar S (2007) Mathematical modeling and thermal performance analysis of unglazed transpired solar collectors. *Solar energy* 81: 62–75.
54. Gunnewiek LH, Hollands KGT, Brundrett E (2002) Effect of wind on flow distribution in unglazed transpired-plate collectors. *Solar energy* 72: 317–325.
55. Fleck BA, Meier RM, Matović MD (2002) A field study of the wind effects on the performance of an unglazed transpired solar collector. *Solar energy* 73: 209–216.
56. Kumar R, Rosen MA (2011) A critical review of photovoltaic–thermal solar collectors for air heating. *Appl Energy* 88: 3603–3614.
57. Shukla A, Nkwetta DN, Cho YJ, Stevenson V, Jones P (2012) A state of art review on the performance of transpired solar collector. *Renew Sustain Energy Rev* 16: 3975–3985.
58. Meaburn A, Hughes FM (1996) A simple predictive controller for use on large scale arrays of parabolic trough collectors. *Solar energy* 56: 583–595.
59. Farahat S, Sarhaddi F, Ajam H (2009) Exergetic optimization of flat plate solar collectors. *Renew Energy* 34:1169–1174.
60. Jafarkazemi F, Ahmadifard E (2013) Energetic and exergetic evaluation of flat plate solar collectors. *Renew Energy* 56:55–63.
61. Akhtar N, Mullick SC (1999) Approximate method for computation of glass cover temperature and top heat-loss coefficient of solar collectors with single glazing. *Solar energy* 66: 349–354.
62. Mahdjuri F (1999) Solar collector with temperature limitation using shape memory metal. *Renew Energy* 16: 611–617.
63. Fan J, Shah LJ, Furbo S (2007) Flow distribution in a solar collector panel with horizontally inclined absorber strips. *Solar energy* 81:1501–1511.
64. Harrison S, Cruickshank CA (2012) A review of strategies for the control of high temperature stagnation in solar collectors and systems. *Energy Procedia* 30: 793–804.
65. <http://www.google.co.uk/patents/US4270517>
66. Slaman M, Griessen R (2009) Solar collector overheating protection. *Solar energy* 83: 982–987.
67. Lambert AA, Cuevas S, del Río JA (2006) Enhanced heat transfer using oscillatory flows in solar collectors. *Solar energy* 80:1296–1302.
68. Arkar C, Medved S (2015) Optimization of latent heat storage in solar air heating system with vacuum tube air solar collector. *Solar energy* 19:10–20.
69. Giovanardi A (2012) *Integrated solar thermal facade component for building energy retrofit*. PhD thesis of Doctoral School in Environmental Engineering, UNIVERSITÀ DEGLI STUDI DI TRENTO in collaboration with EURAC RESEARCH.
70. Payakaruk T, Terdtoon P, Ritthidech S (2000) Correlations to predict heat transfer characteristics of an inclined closed two-phase thermosyphon at normal operating conditions. *Appl Thermal Engg* 20:781–790.
71. <http://www.bionicol.eu/>
72. Munari Probst MC, Roecker C (2007) Towards an improved architectural quality of building integrated solar thermal systems (BIST). *Solar Energy* 81: 1104–1116.
73. Musall I, Weiss T, Voss K, Lenoir A, Donn M, et al. (2011) *Net Zero Energy Solar Buildings: An Overview and Analysis on Worldwide Building Projects*. IEA Solar Heating & Cooling Programme.
74. Switzerland EPPA (2012) *Integrated Concepts - Construction Aspects*. European Community Seventh Framework Programme. Seventh framework programme cooperation - theme 4: d4.1.2.
75. <http://projects.iea-shc.org/task39/projects/default.aspx>

Citation: Zhang X, Shen J, Tang L, Yang T, Xia L, et al. (2015) Building Integrated Solar Thermal (BIST) Technologies and Their Applications: A Review of Structural Design and Architectural Integration. *J Fundam Renewable Energy Appl* 5: 182. doi:10.4172/20904541.1000182

Submit your next manuscript and get advantages of OMICS Group submissions

Unique features:

- User friendly/feasible website-translation of your paper to 50 world's leading languages
- Audio Version of published paper
- Digital articles to share and explore

Special features:

- 350 Open Access Journals
- 30,000 editorial team
- 21 days rapid review process
- Quality and quick editorial, review and publication processing
- Indexing at PubMed (partial), Scopus, DOAJ, EBSCO, Index Copernicus and Google Scholar etc
- Sharing Option: Social Networking Enabled
- Authors, Reviewers and Editors rewarded with online Scientific Credits
- Better discount for your subsequent articles

Submit your manuscript at: www.omicsonline.org/submit