

Moto-Compressor coupling failure:

API 10% separation margin to
calculated or to real critical
torsional speeds?



TURBOMACHINERY & PUMP SYMPOSIA

DECEMBER 14-16, 2021



TEXAS A&M
UNIVERSITY



TURBOMACHINERY LABORATORY
TEXAS A&M ENGINEERING EXPERIMENT STATION



Dr. Pablo Bellocq, Rotating Equipment Specialist at TotalEnergies. He graduated as mechanical engineer and PhD in power and propulsion. Before joining TotalEnergies he worked for Safran Helicopter Engines, CAF (railway systems) and UTE (Uruguayan power gen/distribution corp.)



Dr. Alain Gelin, Rotating Equipment Expert at TotalEnergies. He graduated as mechanical engineer and PhD in rotodynamics. Before joining TotalEnergies he worked for Thermodyn as R&D and testing technical leader.



Edouard THIBAUT, Electrical Expert at TotalEnergies. He graduated as electrical engineer. Before joining TotalEnergies, he worked for Alstom and then Converteam.

This case study will present the failure of the LS coupling of a variable speed moto compressor, due to a resonance of the first critical torsional speed while running at Minimum Operating Speed. The path followed for the investigation and to define design modifications will be presented, followed by a discussion and lessons learned about separation margins to torsional critical speeds on variable speed trains with disc type couplings.

Failed Compression train

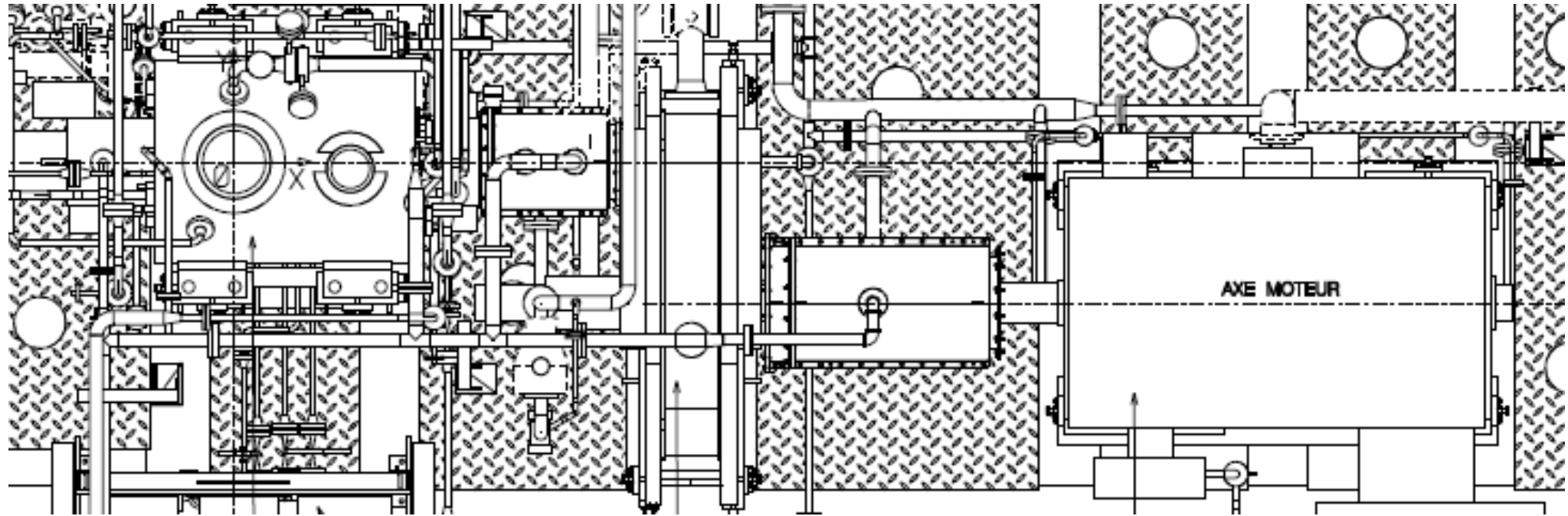

Centrifugal compressor

5 impellers, \varnothing ~300mm

9500 – 14255 RPM

LP gas MW = 32;

10 BarA to 40 BarA

50000 kg/h

HS coupling

Disc type

LS coupling

Disc type

Speed increaser

Ratio = 9.038

Double helical gear

Electric motor (induction)

4 pole, VFD driven

~2 MW

Train speed range LS

1050 – 1580 RPM



Failed Compression train

By design, the train 1st torsional critical speed was 15.75 Hz = 10% lower than the min operating speed (1050 rpm = 17.5 Hz) to comply with API separation margin requirement.

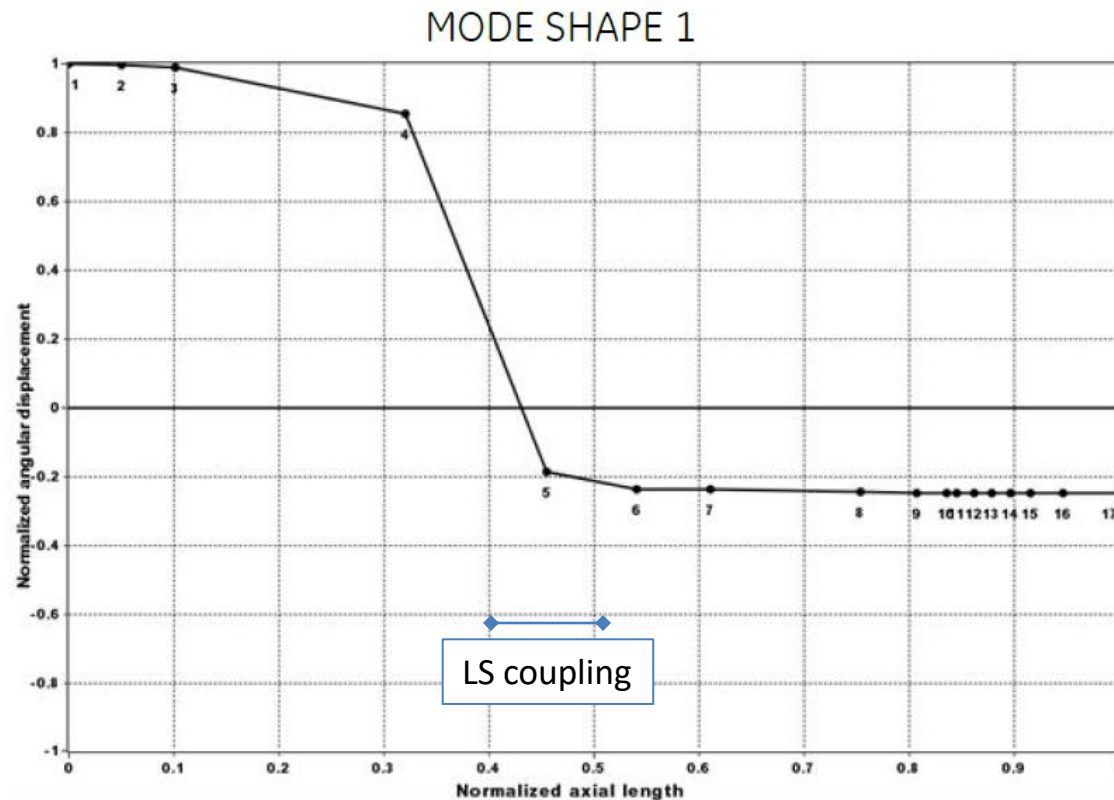

JACOBI Method
Mode Shape 1 : 15.8 Hz - 945 rpm

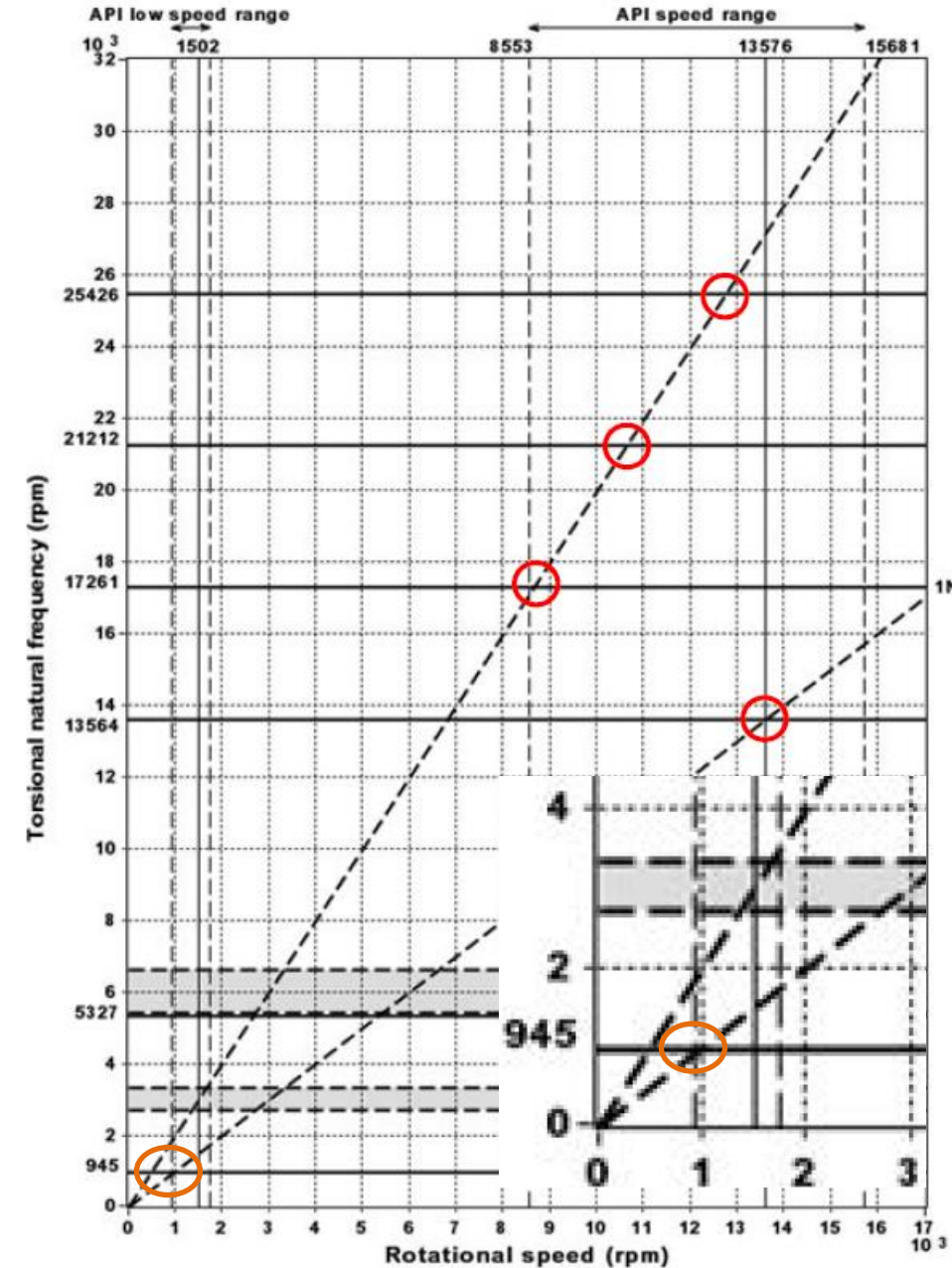

Timeline of events (2020)

1st Feb started dynamic commissioning of the train

3rd Feb: torque/speed started oscillating up to +/-1,5% and tripped by speed protection

4th Feb: After start up, loud noise was noticed at min speed (1050rpm)

4-6th Feb: Reviewed torsional analysis, gearbox critical speed maps and load to stabilize the pinion

Design effort was done to have the first torsional critical speed at min speed -10%

6th Feb: 6 min run with accelerometers on GB bearings (~17Hz peak observed on LS side)

Torsional critical speed suspected (even if predicted at 15.75 Hz)

7th-16th Feb: GB opened and inspected. Alignment check. Nothing found that may justify the noise.

17th Feb: Run of motor with GB only (HS coupling not installed) => NO NOISE

18th Feb: Run with complete train and NOISE came back.

4th March: ADRE arrived to site and runs were recorded 4th, 5th and 7th March from Min to max speed.

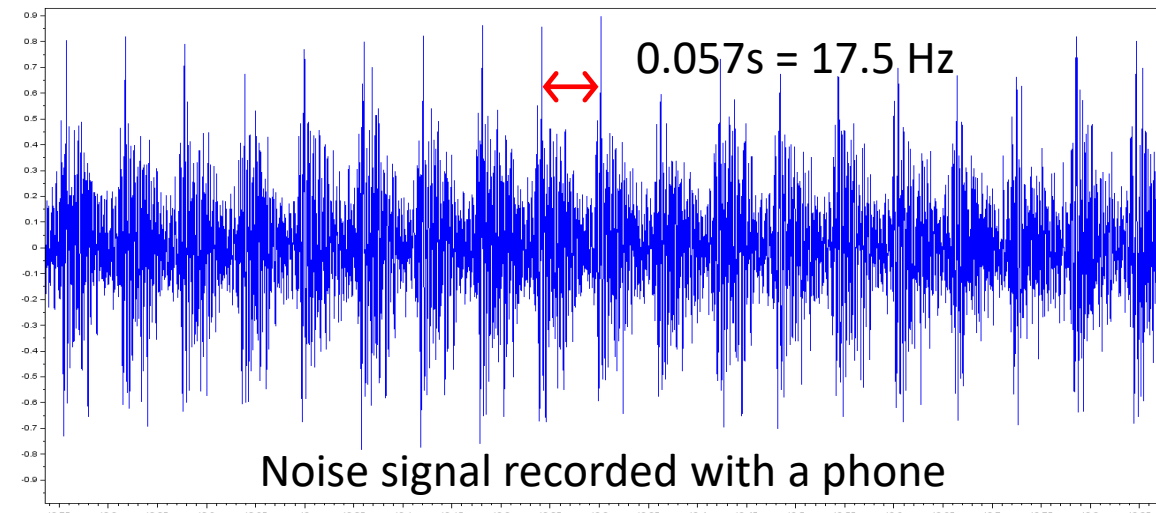
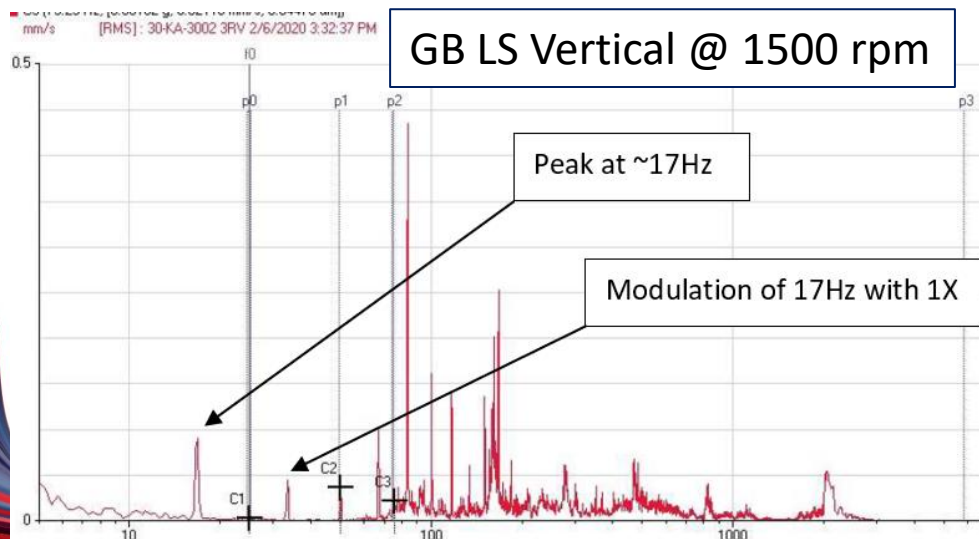

Timeline of events

Low speed, GB, Drive end X probe

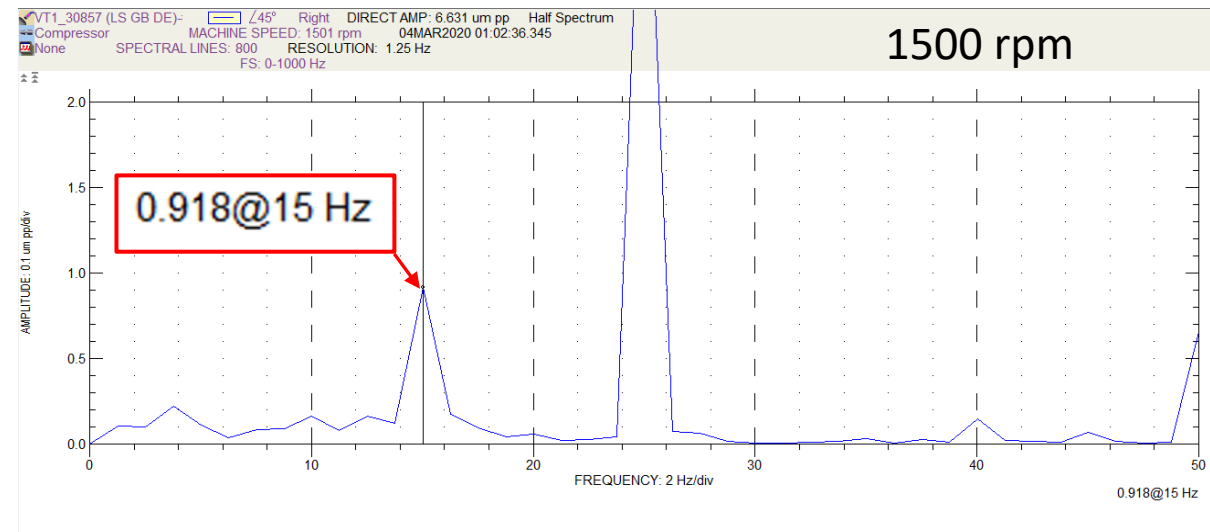
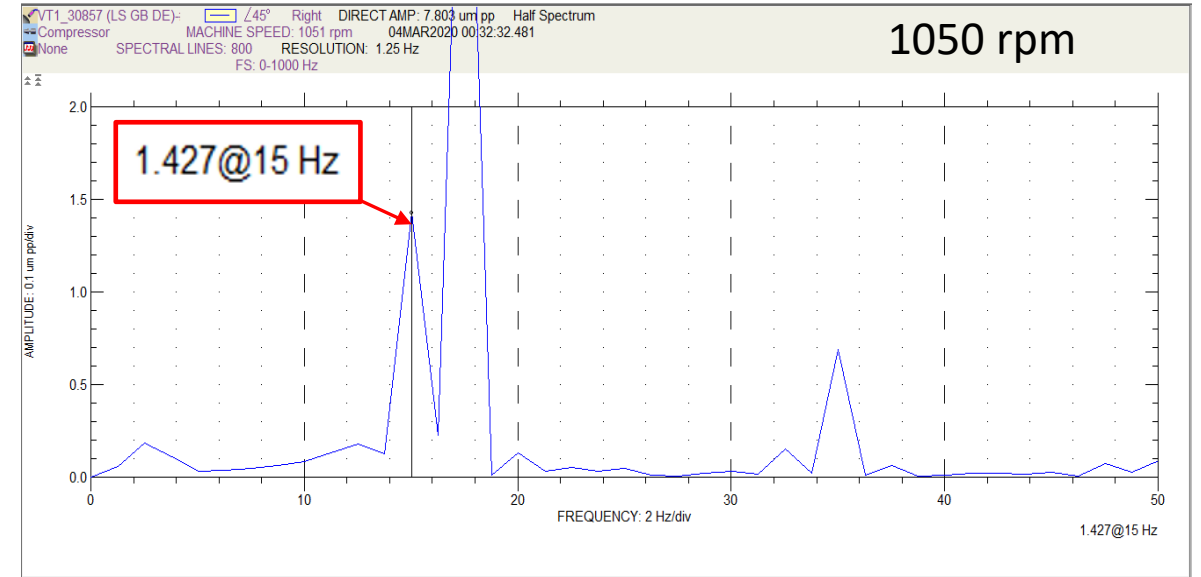
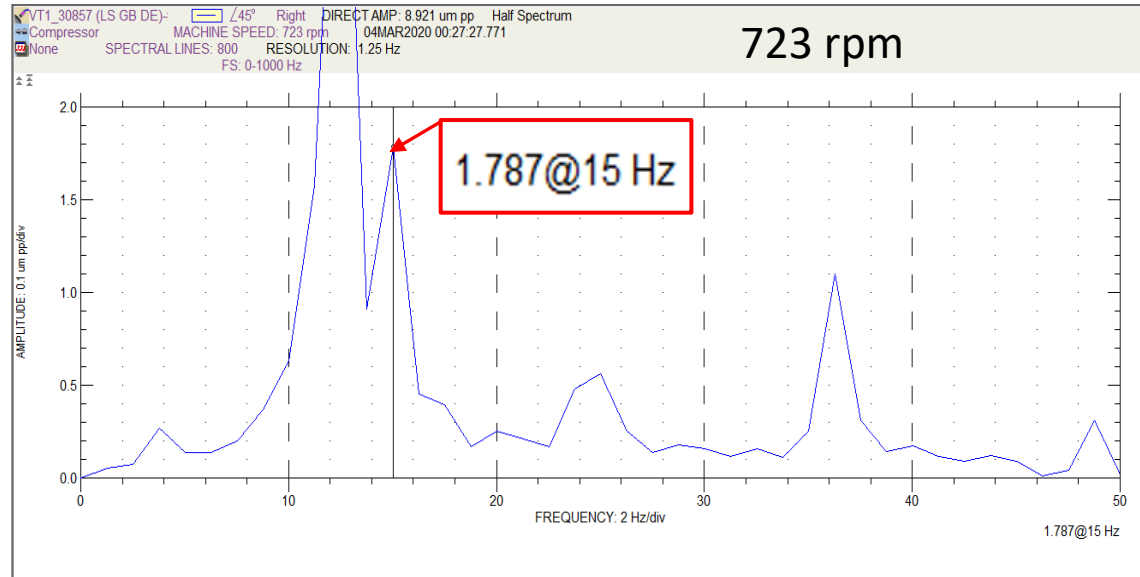

Timeline of events

A total of 133 minutes of operation at 1050 rpm were done in between 1st Feb and 7th March
8th March: Noise disappeared. Site personnel believed the issue was solved and left unit in service.
11th March: LS coupling failed

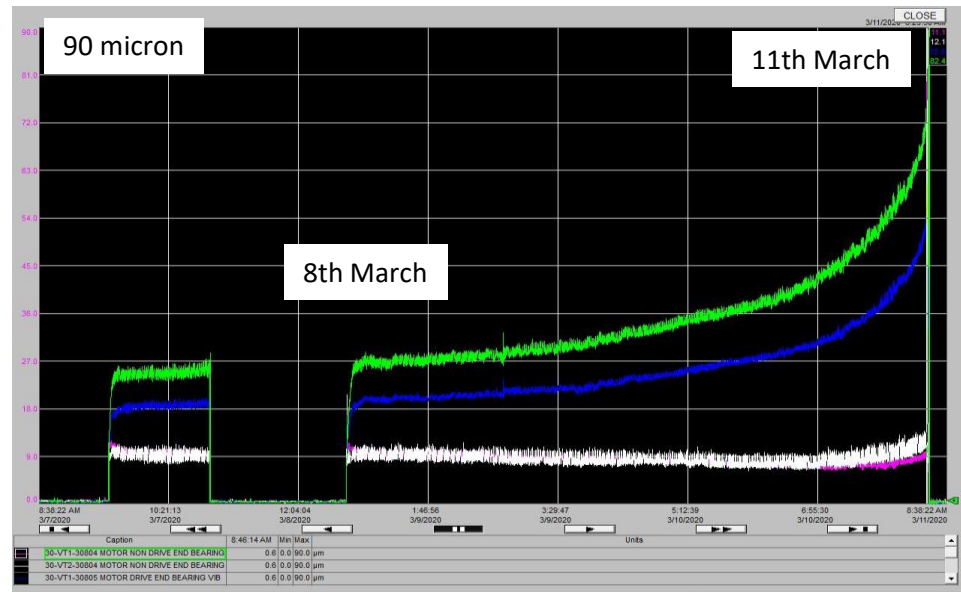

Motor vibrations (micron p-p)

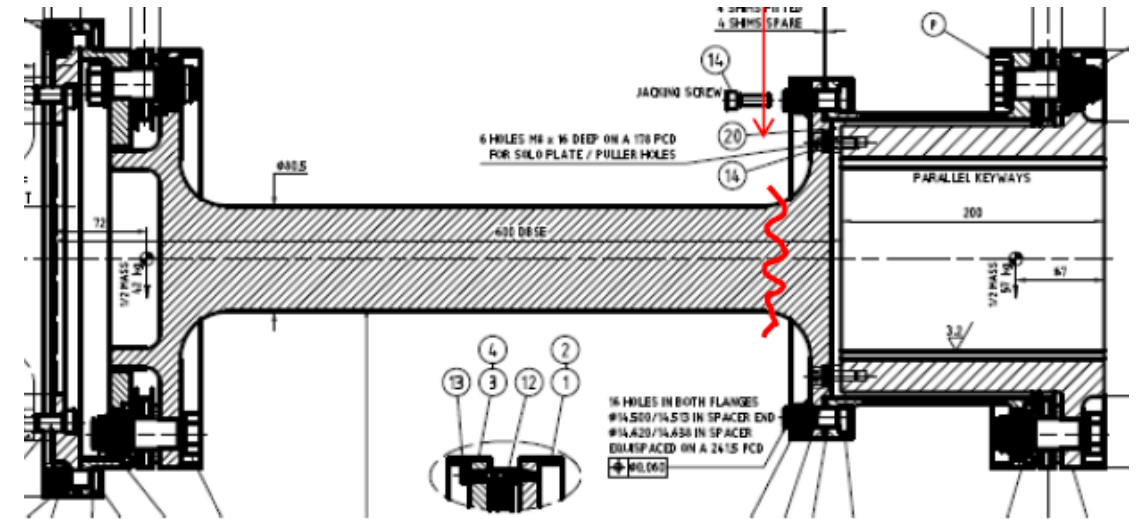

Timeline of events

15th March: Covid-19 restrictions started in Europe.



Train repair 12th March - 29th April

- Replaced all damaged structural elements and piping.
- Replaced main electric motor
- Full GB inspection
- Replacement of both couplings
- Package Alignment

Root Cause Analysis

Tried to bring material for high frequency monitoring of voltage and current but was not possible within Covid-19 Context.

Tried to bring material for strain gauge instrumentation of LS coupling but not possible within Covid-19 context.

Managed to send the failed coupling to a local lab.

- 2nd April: first set of results available
- 22nd April: second set of results available

Lab main findings

- Failure by fatigue
- Coupling had cracks in longitudinal direction
 - not operational stress => pre-existing cracks
- 20% difference in material properties: motor vs GB side
 - Heat treatment? high residual stresses?

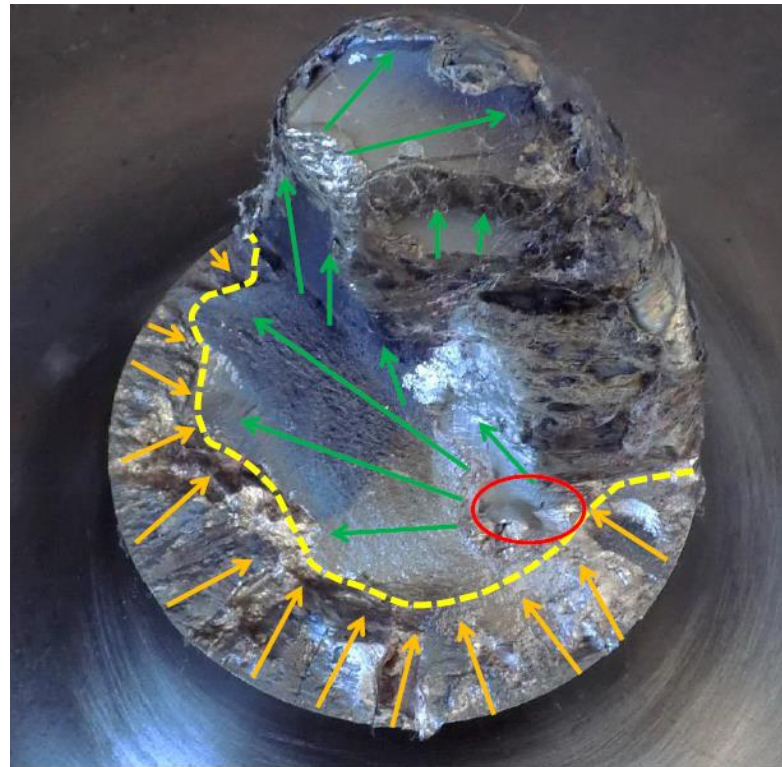

Lab main findings

- Failure by fatigue
- Coupling had cracks in longitudinal direction
 - not operational stress => pre-existing cracks
- 20% difference in material properties: motor vs GB side
 - **Heat treatment? high residual stresses?**
- Multi branched cracks starting from “craters” covered with phosphate crystals + Sulphur residues
- Multi branched cracks up to 200 microns depth also found on Motor side.
 - **Surface attacked with Sulphur during phosphating process?**

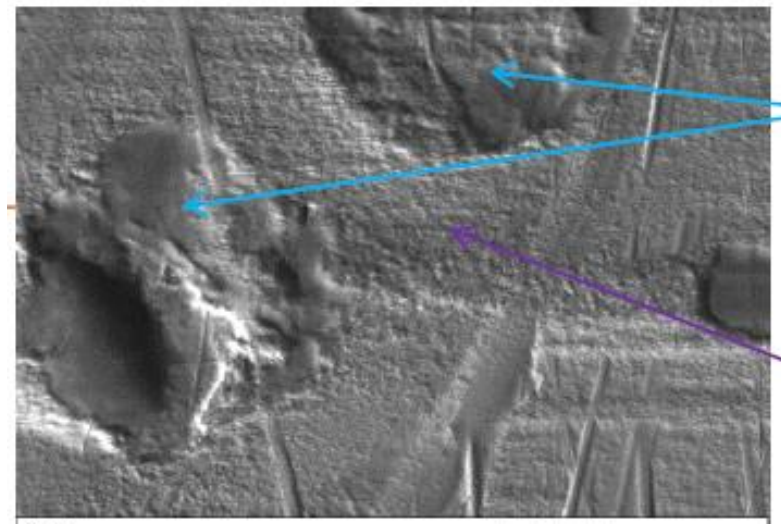
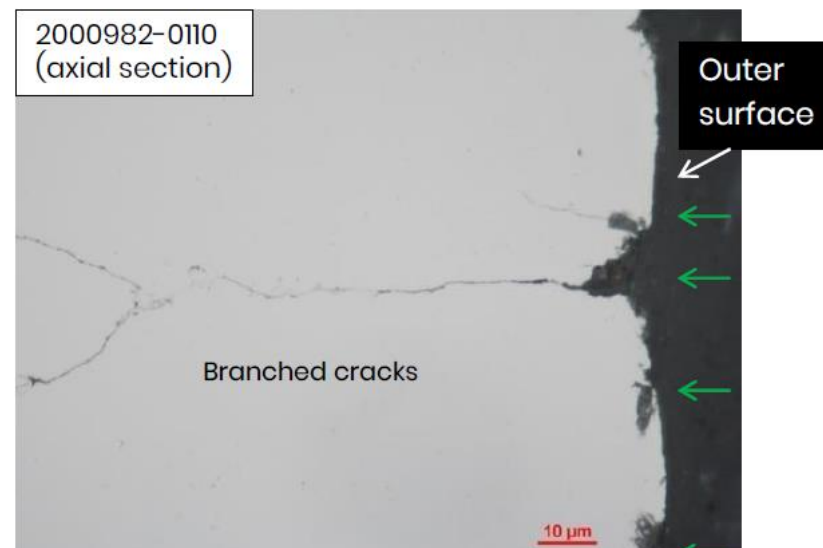

Lab main findings

- Failure by fatigue
- Coupling had cracks in longitudinal direction
 - not operational stress => pre-existing cracks
- 20% difference in material properties: motor vs GB side
 - Heat treatment? high residual stresses?
- Multi branched cracks starting from “craters” covered with phosphate crystals + Sulphur residues
- Multi branched cracks up to 200 microns depth also found on Motor side.
 - Surface attacked with Sulphur during phosphating process?

Stress Corrosion Fatigue initiated cracks

+

Torsional critical speed at min operating speed ???

Condition of the spare coupling ???

Way forward

- 30th April: Package run with spare LS coupling “as it was” with min speed increased to 1150 rpm (100 rpm higher than original minimum operating speed)
 - Peak observed at 17,5 Hz, possibly torsional critical speed.
- 1st May-12th May: Removed coupling, machined out 1mm in radius to the spacer and re-installed.
 - Stiffness should reduce by 9%
 - Expected shift in torsional critical speed was $17,5 * \text{sqrt}(0,91) = 16,75 \text{ Hz} = 1005 \text{ rpm}$

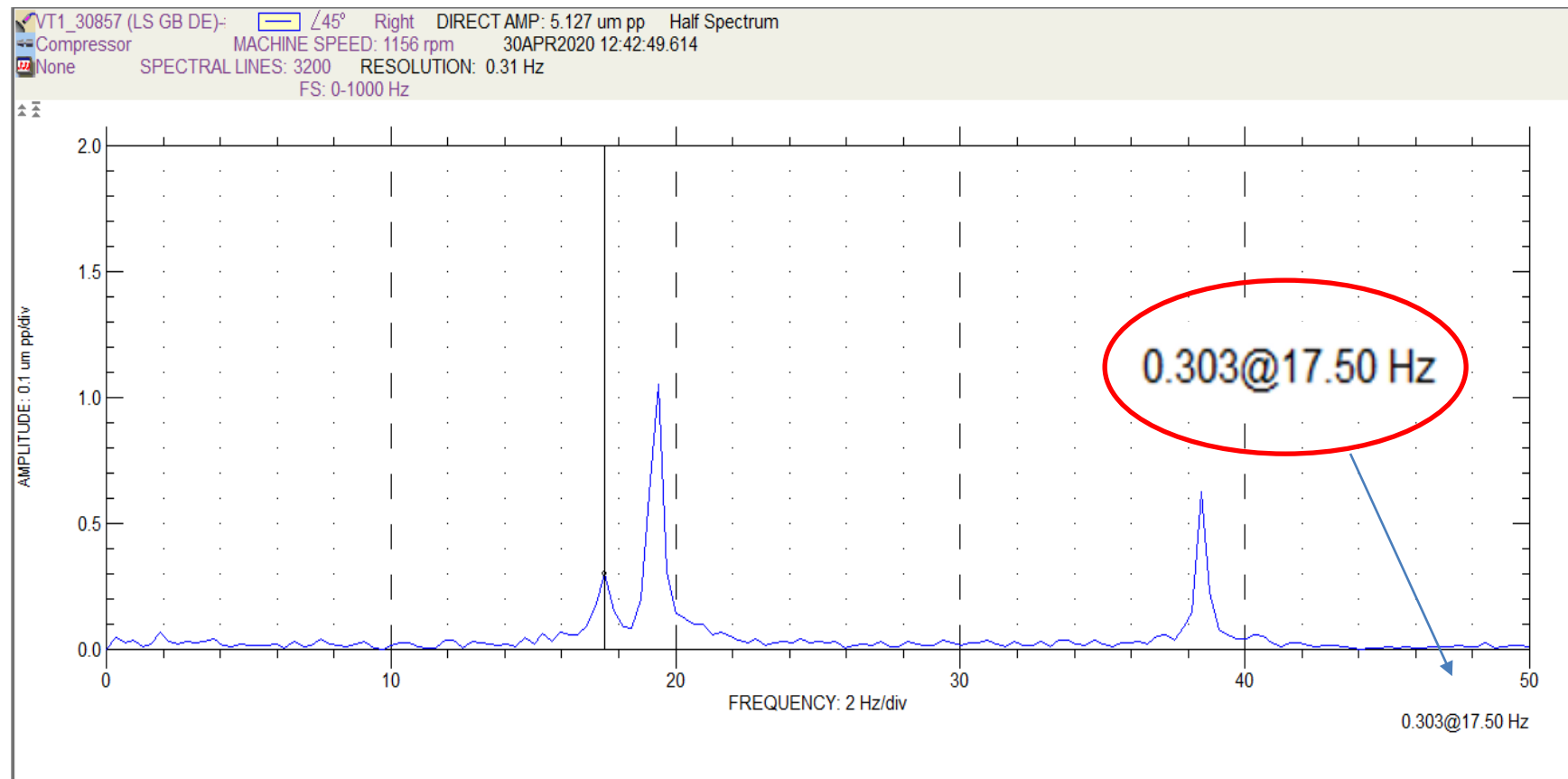

Way forward

- 30th April: Package run with spare LS coupling “as it was” with min speed increased to 1150 rpm (100 rpm higher than original minimum operating speed)
 - Peak observed at 17,5 Hz, possibly torsional critical speed.
- 1st May-12th May: Removed coupling, machined out 1mm in radius to the spacer and re-installed.
 - Stiffness should reduce by 9%
 - Expected shift in torsional critical speed was $17,5 * \text{sqrt}(0,91) = 16,75 \text{ Hz} = 1005 \text{ rpm}$
- 13th May Run the package with the machined coupling. **Shift of critical speed as per expectation**

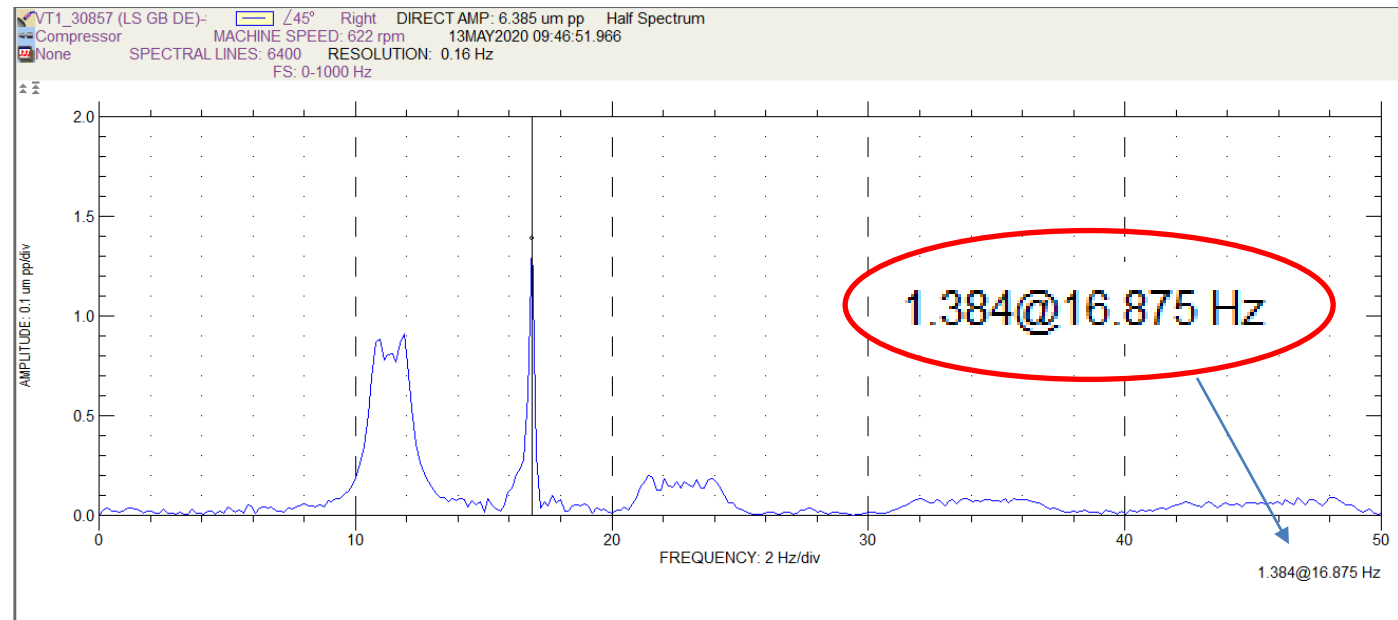

The package has been in service with increased min speed and modified LS coupling since 13th May 2020 with no further issues

Way forward

- As backup, in May 2020, two new couplings were ordered to 2 different suppliers.
 - Within Covid-19 context it was risky to have only one order to one manufacturing location
- Torsional stiffness tests were done on both couplings
 - Same static rig with optic deflection measurements
 - Both couplings had a quoted stiffness of **0,55 MNm/rad** on drawing

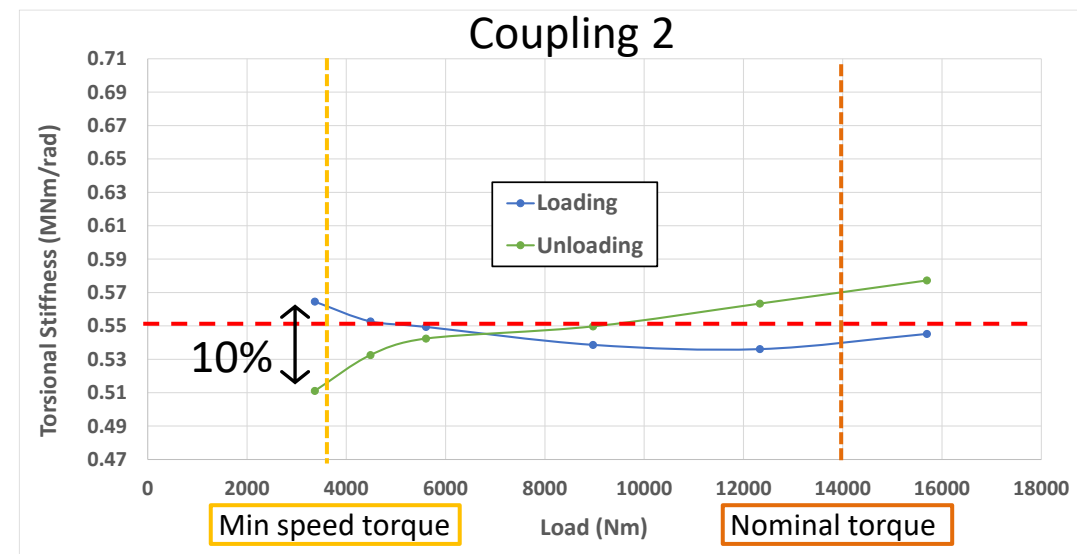
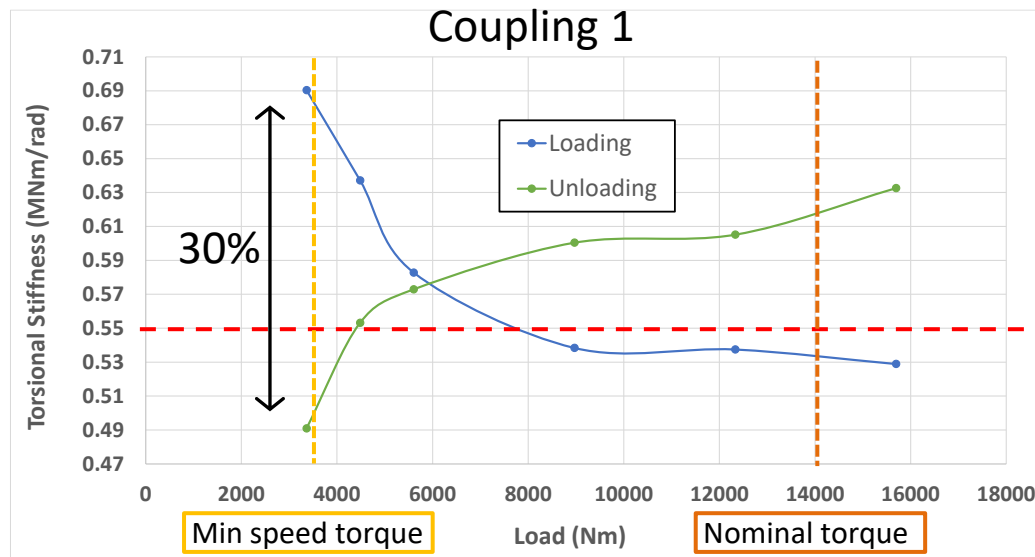

10% change in torsional stiffness = ~5% change in 1st torsional critical speed
30% change in torsional stiffness = ~15% change in 1st torsional critical speed

30% change in torsional stiffness on a $\varnothing 78\text{mm}/450\text{ mm}$ long bar shaft
what to expect on stiff spacers ???

VFD & torsional excitations

VFD can generate integer and non-integer harmonic currents which can induce torque fluctuations into the rotor

Control loops can also generate torque fluctuations at various frequencies (scalar vs vectorial control)

Electrical mitigations can be:

- Output inverter sine filter
- Pre-calculated PWM pattern to eliminate target frequencies
- Adequate design and tuning of control loops

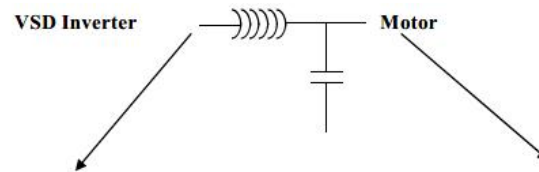
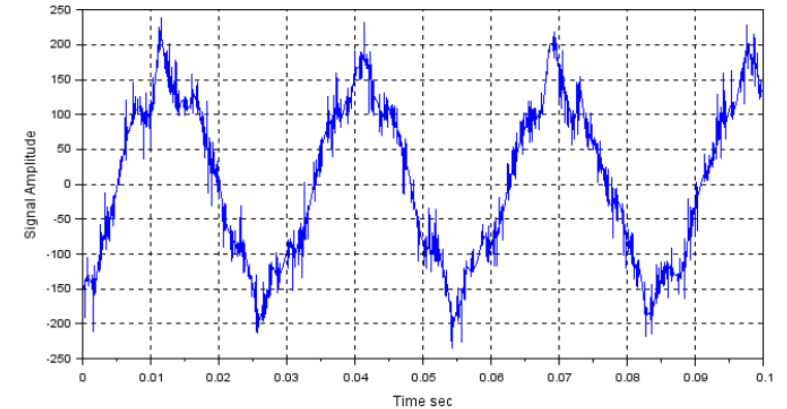

$$\begin{cases} \cos(\alpha_1) - \cos(\alpha_2) + \cos(\alpha_3) = \frac{\pi * M}{4} \\ \cos(5 * \alpha_1) - \cos(5 * \alpha_2) + \cos(5 * \alpha_3) = 0 \\ \cos(7 * \alpha_1) - \cos(7 * \alpha_2) + \cos(7 * \alpha_3) = 0 \end{cases}$$

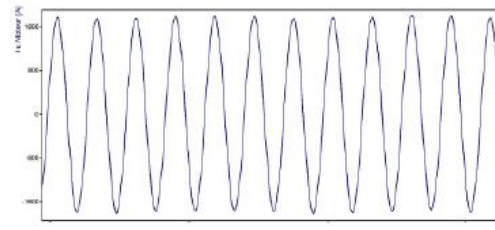
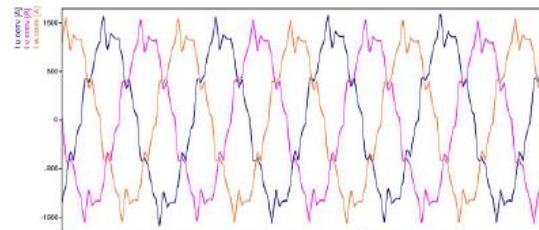

Current

Current

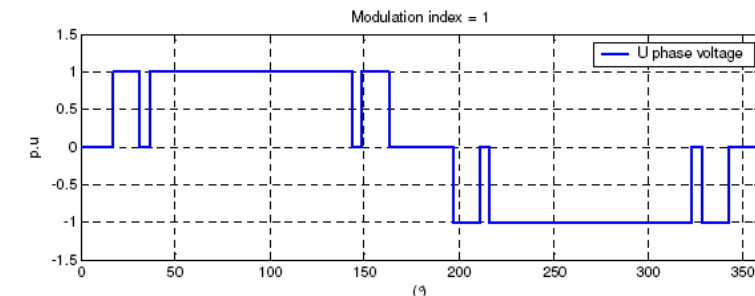

Disussion/Lessons Learned

- Predicted vs real torsional natural frequencies can differ by more than 10% (especially with flex disc couplings).
 - Recommended paper covering this subject: Q. Wang, T. D. Feese, B. Pettinato, *“Torsional natural frequencies: Measurement vs. prediction”*, 42nd Turbomachinery Symposium, 2013 Houston, Texas.
- **10% separation margin to calculated speeds may not be enough to ensure a safe design.**
- Torsional stiffness for disc couplings is not a constant value, as commonly stated in coupling drawings and used in torsional analyses.
 - Recommended paper covering this subject: *“Revisiting Torsional Stiffness of Flexible Disc Couplings”*, Altra Industrial Motion.
- When design efforts are done to ensure a separation margin, a detailed study is required including coupling stiffness calculations at various operating conditions, coupling testing, string test with strain gauges on coupling and taking larger separation margins 15-20-25%?
- Diaphragm type couplings can be considered as an alternative to reduce stiffness uncertainty coming from disk type couplings and impacting torsional natural frequencies.
- Radial probes can give indications of torsional issues, in shaft-lines with gearboxes.

Disussion/Lessons Learned

For packages driven by VSDs, the design of the electric system is to be verified during string tests and commissioning by means of electrical power analysis and FFT on:

- Current, Voltage
- Power, Torque and Speed

High frequency electrical power analysis is needed to properly support the tuning of the VFD during commissioning.

