



## AntVideoRecord: Autonomous system to capture the locomotor activity of leafcutter ants



J.A. Sabattini <sup>a,\*</sup>, J.M. Reta <sup>b</sup>, L.A. Bugnon <sup>c</sup>, J.I. Cerrudo <sup>b</sup>, R.A. Sabattini <sup>a</sup>, A. Peñalva <sup>b</sup>, M. Bollazzi <sup>d</sup>, M.O. Paz <sup>e</sup>, F. Sturniolo <sup>c</sup>

<sup>a</sup> National Council for Scientific and Technical Research (CONICET), Chair of Ecology of Agricultural Systems, Faculty of Agronomy Sciences, National University of Entre Ríos (FCA-UNER), Route No. 11 km 10,5 Oro Verde, Entre Ríos, Argentina

<sup>b</sup> Electronic and 3D Prototyping Laboratory, Faculty of Engineer, National University of Entre Ríos, Argentina

<sup>c</sup> Research Institute for Signals, Systems and Computational Intelligence (UNL - CONICET), Argentina

<sup>d</sup> Entomología, Facultad de Agronomía, Universidad de la República, Uruguay

<sup>e</sup> Electronic Engineer. Development and Independent Professional, Entre Ríos, Argentina

### ARTICLE INFO

#### Article history:

Received 20 July 2021

Received in revised form 10 January 2022

Accepted 27 January 2022

#### Keywords:

Embedded systems

Survival camera

Animal behavior

Continuous monitoring

### ABSTRACT

The leafcutter ants (LCA) are considered plague in a great part of the American continent, causing great damage in production fields. Knowing the locomotion and foraging rhythm in LCA on a continuous basis would imply a significant advance for ecological studies, fundamentally of animal behavior. However, studying the forage rhythm of LCA in the field involves a significant human effort. This also adds a risk of subjective results due to the operator fatigue. In this work a new development named 'AntVideoRecord' is proposed to address this issue. This device is a low-cost autonomous system that records videos of the LCA path in a fixed position. The device can be easily reproduced using the freely accessible source code provided. The evaluation of this novel device was successful because it has exceeded all the basic requirements in the field: record continuously for at least seven days, withstand high and low temperatures, capture acceptable videos during the day and night, and have a simple configuration protocol by mobile devices and laptops. It was possible to confirm the correct operation of the device, being able to record more than 1900 h in the field at different climate conditions and times of the day.

© 2022 The Author(s). Published by Elsevier Ltd. This is an open access article under the CC BY-NC-ND license (<http://creativecommons.org/licenses/by-nc-nd/4.0/>).

### Specifications table

Hardware name	AntVRecord (AntVideoRecord)
Subject area	<ul style="list-style-type: none"> <li>• Biological Sciences</li> <li>• Environmental, Planetary and Agricultural Sciences</li> </ul>
Hardware type	<ul style="list-style-type: none"> <li>• Imaging tools</li> <li>• Field measurements and sensors</li> <li>• Electrical engineering and computer science</li> </ul>

(continued on next page)

\* Corresponding author.

E-mail address: [julian.sabattini@fca.uner.edu.ar](mailto:julian.sabattini@fca.uner.edu.ar) (J.A. Sabattini).

(continued)

Hardware name	AntVRecord (AntVideoRecord)
Closest commercial analog	No commercial analog is available.
Open source license	GNU General Public License (GPL)
Cost of hardware	< \$200 USD
Source file repository	<a href="https://doi.org/10.5281/zenodo.5825882">https://doi.org/10.5281/zenodo.5825882</a>

## Hardware in context

Species of *Atta* and *Acromyrmex* (*Formicidae: Myrmicinae*), well known as leaf-cutting ants (LCA) are an ecological key-stone group in tropical ecosystems. They have a mutualistic relationship with *basidiomycete* fungi belonging to two genera (*Agaricaceae: Leucocoprinae*), *Leucoagaricus* and *Leucocoprinus*. Their activities as herbivores and soil-modifiers have major environmental effects in natural ecosystems [1]. However, a contrasting scenario occurs in human-inhabited areas, where some LCA species appear to take advantage of anthropogenic landscape alterations and become some of the most problematic pests in neotropical agricultural and pastoral systems [2]. In cultivated systems, the use of chemical fertilizers can promote and increase the attack of LCA because they prefer plants that have high concentrations of nutrients which favour the growth of symbiotic fungi, which alter their growth [3]. It is thus necessary to understand the responses of LCA species to anthropogenic environments, and to discriminate between the response to human intervention, and responses to climatic changes and episodic events at various spatial and temporal scales [4]. In natural environments, bottom-up and top-down forces preclude the proliferation of a given species. However, there is an urgent need to understand the ecological mechanisms that underlie the distribution of LCA, their abundance and dispersal [5].

LCA transport fruits and seeds [6] and can be severe defoliators [7], thus they can have an important effect on tropical forest regeneration [8,9,10]. For this reason, it is important to be able to define proper economic damage thresholds in an Integrated Pest Management (IPM). The IPM involves various types of control methods based on economical, ecological and social parameters to keep the pest population below the economic injury level. This includes the knowledge of pest culture and pests, quantification of population density of the pests and their natural enemies, decision-making regarding control and the judicious selection and application of suitable methods to reduce the pest populations. Perhaps the most challenging issue regarding LCA is their behaviour complexity and multidimensional nature, requiring an interdisciplinary approach involving biologists and socioeconomic scientists. Although extensive literature has grown in relation to some of these topics, much of it is scattered and unavailable to the scientific community. Thus, novel tools are required to record more reliable data.

Counting LCA is commonly used to assess herbivory rates [11], foraging behavior [12], activity and mobility over time [13], bait effects [14], and seed dispersion, among other variables. A single nest may contain several million workers [15,16], making it difficult to record the activity of ants on the foraging trails. The traditional way to count foraging LCA is through manual observation of the number of ants that pass through a fixed point over a period [12,17–25]. This method can produce bias between samples due to factors such as the researcher's experience, attention, concentration and fatigue, especially when the number of ants is high.

The use of automatic monitoring systems has become widespread in the last 20 years in several fields. Very recently there have been significant advances in the automated tracking of social insects [26–30]. Modern ant counting studies use conventional video cameras and the videos are manually analyzed in slow motion, or eventually using the few freely available software available so far. 'AntCounter' is a free access system that counts the number of ants that walk in and out of the nest using an image processing algorithm [31]. However, these solutions use commercial video recorders, which cannot be used continuously in time because of battery and storage limitations. New electronics technologies have allowed numerous developments with fast prototyping. The availability of the Raspberry Pi, an inexpensive, tiny and relatively powerful computer board, provides a great building block to facilitate research and various application developments [32].

The aim of this work is to present the technological development called AntVideoRecord (AntVRecord), an innovative, precise, simple to manufacture and use tool. The purpose of this device is to monitor the locomotion and foraging rhythm of LCA in a continuous and autonomous way, on varying field conditions. This will help to obtain a better picture of the ant's behavior in the field and in the laboratory. It can also be used as an applied agronomic application technology, as a decision criterion for sustainable IPM.

## Material and methods

The AntVRecord development was based on three fundamental steps: a) definition of the input variables and output requirements of the product, b) the general design of the system that includes the physical support, design and adaptation of existing hardware, and development of the graphical user interface and c) validation tests.

*Definition of the input variables and output requirements of the design*

The central issue is the absence of a tool to record and store videos in the field, with capacity of several hours of continuous work. Therefore, the requirement of this new tool is to store videos on a physical support (e.g. Pendrive) for at least seven days in a continuous regime (Fig. 1). The equipment must withstand low and high temperatures, such as extreme humidity conditions, even rain. It requires a passive lighting source (IR led) or eventually active (cold light) to capture activity at night. This lightning system should turn on automatically when natural lighting conditions are unfavorable.

The device should be simple to use in the field. The steps to follow are: locate the video capture site with foraging trails, place the equipment support system, mount the power system, mount the AntVRecord and configure the software to start recording. LED identifiers should be used to check on the following equipment conditions: On (static red light), Recording (green light flashing) and Error (yellow light flashing, if any).

The user is required to perform a simple configuration through a graphical interface that was developed for this purpose. This configuration includes the video capturing period and the duration of each video chunk. It should be done using a smartphone, tablet or notebook via Bluetooth, or even remotely if the AntVRecord has access to an internet connection. To ensure power in a long recording session, the power system uses gel batteries with solar panels. For this reason, the device must be sufficiently economical in the use of energy. In addition, it is desirable that materials will be inexpensive, highly available in the market, and easy to assemble and configure.

*General design of the system*

*Mechanical design*

The environmental conditions in which the equipment will be exposed presents a risk of high humidity and heat. For this reason, a watertight support had to be manufactured to prevent damage in the electronic components. Three models were developed and evaluated on field conditions. A first model was based on the manufacture and printing of a rectangular support using 3D printing using ABS and PET-G as modeling materials (Fig. 2). It has four attachment points using metal rods at each end at the top. The indication for the user of LED lights is on one of its sides, as well as the energy input. At the other end, a retractable lid is placed to protect the video storage system. This model presented difficulties to withstand environmental conditions in the field such as rain and conditions of intense heat during the summer. In addition, it was difficult to obtain an image plane perpendicular to the forage trail, as the number of support points does not allow modifications.

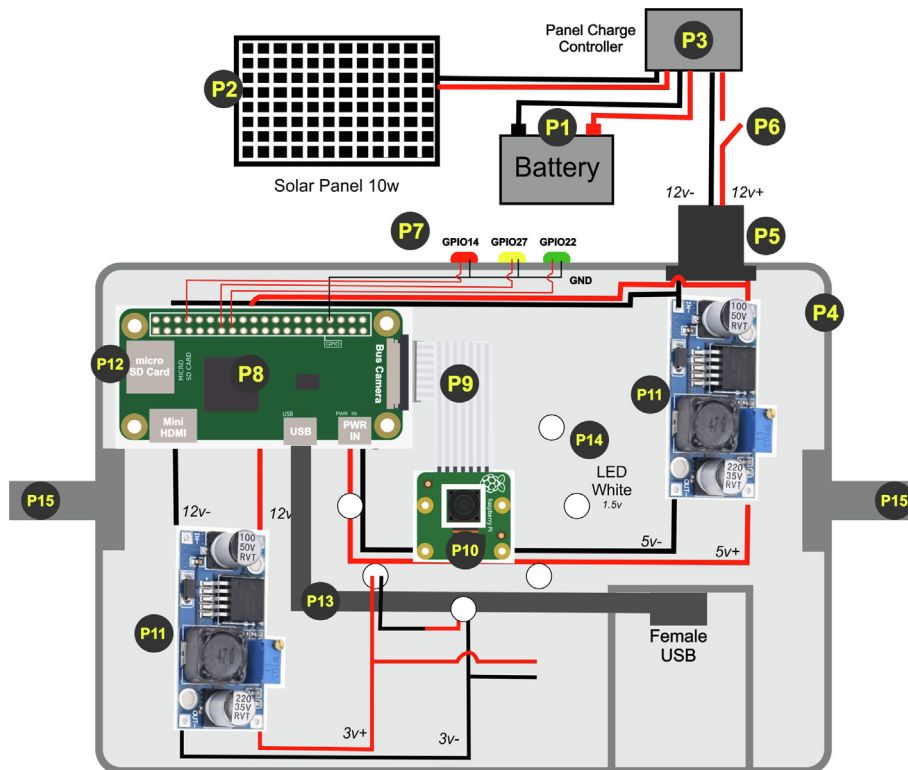

**Fig.1.** Overview of the AntVRecord mechanical design and electronic component. The parts are detailed in Section 4 (Bill of materials).



Fig. 2. Design of the physical support of the initial AntVRecord model.

A second design of the physical structure was printed in 3D. It has more movement freedom and an anchor point using a smooth metal rod with a diameter of 10 mm (Fig. 3). This design allows the change of the camera orientation according to the landscape. At one end it has a threaded cap where the storage is inserted. It presents a greater internal volume that reduces the electronic overheating when ambient temperature is high. Also, it did not present symptoms of moisture damage. However, it was found that the fulcrum became less rigid when there was high ambient humidity, generating unwanted movements by the effect of the wind. Moreover, it required smaller electronic plates, which imply the use of tools that may not be available to many of the target users, requiring higher manufacturing cost. This design took approximately six days to be printed in home 3D printer (See Design Files in [Supplementary Data](#)).

The final version of the model was based on an adaptation of a waterproof dustproof IP65 ABS plastic box (Fig. 4). It is a very simple shape which can be adapted from several products in the market or it can be printed with ease. To change the storage device, only a few screws must be removed from the cover. The device proved to be waterproof in our tests. However, this condition could be improved with a 3D printed structure with a watertight lid. Two bolts used to secure the equipment were placed on the box and glued with sealant. A rectangular cutout was made at the bottom of the box to hold the video capture camera module. Also, eight five-millimeter diameter circles were cut for the lighting system. On the sides, the indicator LEDs were incorporated. The box is fastened with two points of support to the ground, adding stability during the video capture, while allowing the vertical mobility to adjust the recording area. The width of the box (15 cm) coincides with the maximum width of the studied LCA trails. In summary, the box has a simple assembly and facilitates the eventual component replacement.

#### Electronic design

The core of the AntVRecord is a Raspberry Pi Zero W (RPiW), a low-cost single-board computer (Raspberry Pi Foundation, Cambridge, United Kingdom), with the addition of a Raspberry Pi Camera, and other low-cost electronic components (Fig. 5). The RPiW has a small footprint (65 mm × 30 mm) with a 1 GHz BCM2835 single-core processor with 512 MB RAM. The RPiW has a Linux operating system and can be configured as a desktop computer by connecting it via the HDMI and USB ports to an external monitor, keyboard and mouse. Its embedded Wi-Fi and Bluetooth cards allow wireless access to the system, which provides a convenient way to monitor the AntVRecord in the field using a mobile device (e.g. ensure the camera is working properly before deployment). All recorded data and preinstalled software are stored on a microSDXC card. An 8 MegaPixel Raspberry Pi camera module v2 fitted with a 110 lens (Blue Robotics, Torrance, USA) is connected to the RPiW via its FPC connector. This way it can capture high-definition video and digital still images.

The system is powered by a 12 V gel battery, providing a total capacity of 25,000 mAh. A 5 V 3A Step-Up/Down regulator is placed between the output of the battery pack and the input of RPiW to increase or decrease the power as needed to ensure 5 V tension. The energy recharging is carried out with a 20w polycrystalline solar panel with a nominal charge of 1.24 Ah that gives autonomy to the system. In addition, an automatic voltage regulator was incorporated between the solar panel and the gel battery to avoid spike damage.



**Fig. 3.** AntVRecord design with various degrees of freedom.

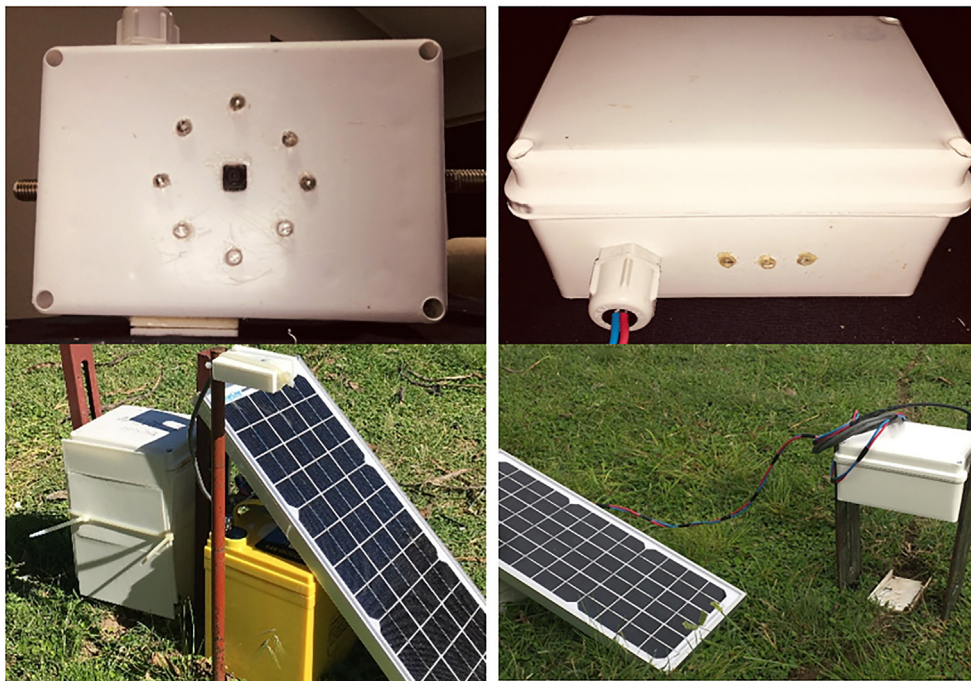

**Fig 4.** Design of the AntVRecord with two support points using conventional manufacturing hardware.

The lighting system relates to a light sensor in a series circuit, so that the light is switched on when natural lighting is scarce. The lighting system can be passive or active. In the first case, 850 nm infrared led diodes are used, thus no visible light will be observed on the ground at night. Active light can also be adapted by means of connected white led lights of 5 mm diameter.

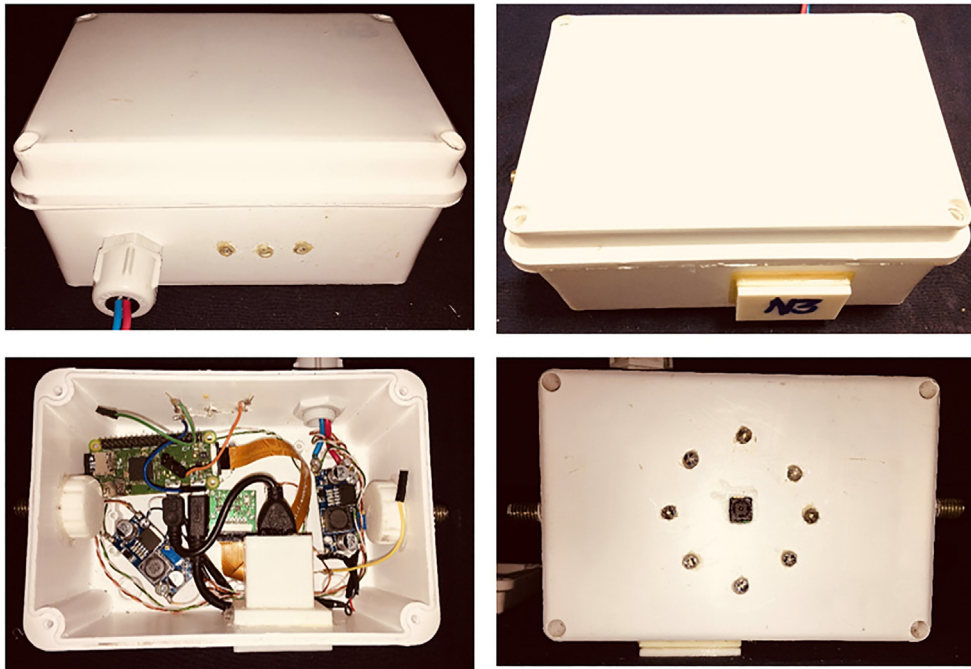

Fig. 5. Waterproof IP65 box with electronic component installed.

#### Design of the graphical user interface: AntProject

The AntVRecord is operational through a graphical interface designed for the Linux operating system (OS) of the RPiW. The OS is a Raspbian Buster desktop distribution [33], which have the minimum installed software, leaving free space for video recording processes and storage. OS and the developed graphical interface are stored in the microSDXC, however, for the entire video recording and storage system, a 2.0 pen drive connected to the Mini-USB port of the RPiW is used. The operating system is loaded manually on a Mini-SD memory card and subsequently performed the installation of AntVRecord OS through a graphical interface. It is connected to the internet through the integrated Wi-Fi card to carry out a complete update of the OS.

For the configuration of the information recording and storage system, a graphical interface called AntProject was developed<sup>1</sup>. It can be accessed by remote desktop using the VNC Viewer plug-in through a bluetooth connection through mobile phones, tablets or laptops. The communication system requires the installation of Blueteman<sup>2</sup>, a GTK + Bluetooth Manager designed to provide a simple yet effective means for controlling the BlueZ API and simplifying Bluetooth tasks, such as connecting to or creating Bluetooth networks and pairing. It is lightweight, easy to use, Python based, and GPL licensed. If a Wi-Fi connection is available, it can be associated as a client. Thus, the VNC Viewer server can be used remotely, being able to edit all the AntProject configuration from a cabinet without being present at the equipment installation site. This functionality is very useful to check the available storage space or verify the camera's health.

The AntProject<sup>3</sup> is a graphical interface in continuous development. Currently it allows configuration of the recording mode, time and capture area to optimize the storage cost (Fig. 6). Operational mode settings and acquisition of data from the camera sensor are controlled in Python using the well-documented picamera library [34]. The AntProject must be cloned and installed on the Raspbian Desktop). It can then be opened with a direct access called AP through the terminal console. First, the date and time must be set before recording. The default configuration will be a recording of six 30-minute videos with the maximum capture area of the lens, in a resolution of  $640 \times 480$  pixels. Records will be saved in mp4 format, which compresses audio and video. Configuration parameters can be modified in the following ranges: duration time (HH: MM: SS), number of videos (0–99999), video resolution (640x480, 1280x720, 1640x1232 and 1920x1080 pixel), encoding format (.h264 or .mp4), desktop video capture display (full screen, or at a certain scale of the window, 10%–10x-, 20%–20x- or 30%–30x-) and the capture area.

In all cases, it is possible to have a preview of the recording to adjust the desired capture area. Once the configuration stage is done, the play button is pressed, and the videos will automatically be recorded in the storage system. Externally, the green LED light will begin to flash indicating its correct operation. The yellow LED light will begin to flash in case of finding an error with the file writing. In that case, the user must check the configuration and connection of the pendrive. At the

<sup>1</sup> Available at <https://doi.org/10.5281/zenodo.5825882>

<sup>2</sup> Available at <https://github.com/blueteman-project/blueteman>

<sup>3</sup> Available at [https://www.github.com/fd-sturniolo/ant\\_project](https://www.github.com/fd-sturniolo/ant_project)

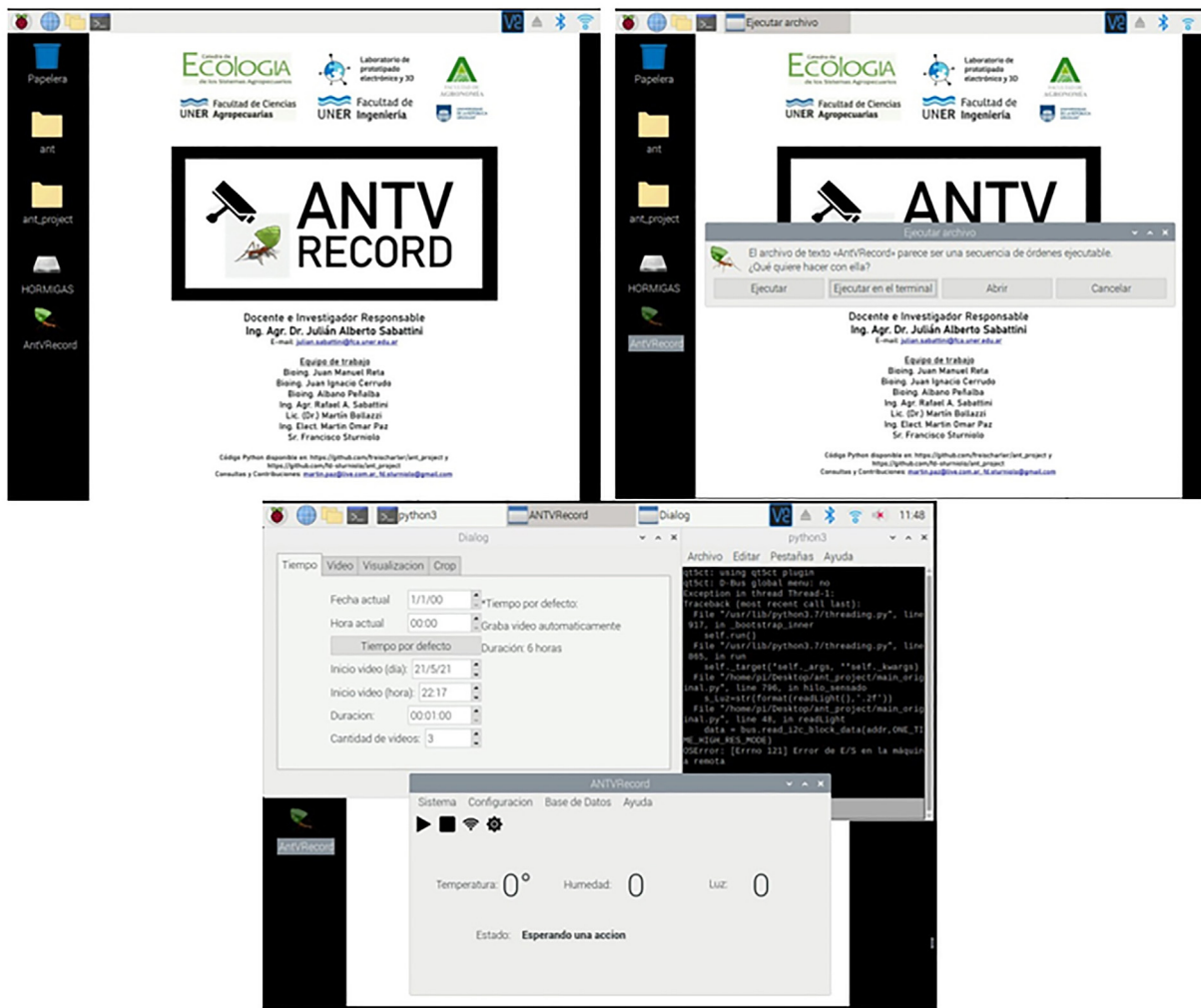

Fig. 6. Raspberry Pi desktop with installation and opening of AntVRecord OS.

end of the recording, the user must safely remove the pendrive using the remote desktop and save the files on their computer. In Section 7, the number of videos with different resolutions and lengths of recording that can be stored on a standard pendrive is detailed.

**Design files**

*Design files summary*

Design filename	File type	Open source license	Location of the file
AntVRecord overview	Figure (jpg)	CC BY-SA	<a href="https://doi.org/10.5281/zenodo.5825882">https://doi.org/10.5281/zenodo.5825882</a>
Electronic Circuit	Figure (jpg)	CC BY-SA	<a href="https://doi.org/10.5281/zenodo.5825882">https://doi.org/10.5281/zenodo.5825882</a>
Components placement	Figure (jpg)	CC BY-SA	<a href="https://doi.org/10.5281/zenodo.5825882">https://doi.org/10.5281/zenodo.5825882</a>
Ant_Project_scripts	Zip	CC BY-SA	<a href="https://doi.org/10.5281/zenodo.5825882">https://doi.org/10.5281/zenodo.5825882</a>

**Bill of materials**

Designator	Component	Number	Cost per unit -currency	Total cost - currency	Source of materials	Material type
P1	Battery Gel 12 V 26AH	1	\$54.99 USD	\$54.99 USD	Amazon	Other
P2	Polycrystalline Solar Panel High Efficiency 10 W 12 V	1	\$31.99 USD	\$31.99 USD	Amazon	Other
P3	Phoenician Energy 10A Solar Charge Controller 12 V/24 V Auto, Solar Panel Charge Controller	1	\$8.97 USD	\$8.97 USD	Amazon	Other
P4	Waterproof Dustproof IP65 ABS plastic junction box universal Electric (150 mm × 100 mm × 100 mm)	1	\$6.80 USD	\$6.80 USD	Amazon	Other
P5	6.5 mm cable gland plastic waterproof IP65 adjustable	1	\$0.45 USD	\$0.45 USD	Amazon	Other
P6	ON/OFF Rocker Switch waterproof IP65 12 V 10A	1	\$1.23 USD	\$1.23 USD	eBay	Other
P7	LED Light Emitting Diode Diffused 5 mm (Red, Yellow and Green)	3	\$0.06 USD	\$0.18 USD	Amazon	Other
P8	Raspberry Pi Zero WH with 40PIN Pre-Soldered GPIO Headers, Built-in WiFi and Bluetooth	1	\$22.99 USD	\$22.99 USD	Amazon	Other
P9	FFC Cable Flex Cable 15Pin to 22Pin 16CM Ribbon Cable for Raspberry Pi Zero/Zero W	1	\$8.99 USD	\$8.99 USD	Amazon	Other
P10	Raspberry Pi camera module v2-8 Megapixel, 1080p	1	\$37.38 USD	\$37.38 USD	eBay	Other
P11	36 V a 5 V 3A Step-Down regulator	2	\$4.92 USD	\$9.84 USD	eBay	Other
P12	16 GB MicroSD memory card	1	\$5.52 USD	\$5.52 USD	eBay	Other
P13	Micro USB Male to Female OTG	1	\$1.97 USD	\$1.97 USD	eBay	Other
P14	LED Light Emitting Diode Diffused 5 mm (Whitte)	8	\$0.06 USD	\$0.48 USD	Amazon	Other
P15	M8-1.25x22 mm metric bolt Class 8.8 HEX	2	\$0.07 USD	\$0.14 USD	Amazon	Other
-	Electronic Components	-	\$10.00 USD	\$10.00 USD	Amazon, eBay, Mercado Libre	Other

**Build instructions***Assembling the physical support.*

1. Take the Waterproof Dustproof IP65 ABS plastic box (P4) and make an 8 mm × 8 mm square cut in the center. Insert the Raspberry camera (P10). Assemble the chamber and seal with silicone glue.
2. Make eight 4.8 mm circular cuts at a radius of 25 mm of the center. Insert the lighting system with LEDs (P14) with silicone sealant to prevent the entry of moisture.
3. On each side, make two 10 mm circular cuts of two glue the metric bolts (P15) with the threads facing out of the box. The AntvRecrord is then secured with nuts to each side.
4. On one side, make a 6 mm circular cut to insert the gland plastic waterproof IP65 adjustable cable (P5). On the same side, make three cuts to place the LED Light Emitting Diode Diffused Red, Yellow and Green (P7). Then seal with silicone from both sides.
5. Optionally, a support printed in ABS can be made for the USB Female connector with a cover (Fig. 5). This is useful to extract the pendrive without having to remove the four fixing screws from the box. The installation of the waterproof IP65 12 V 10A ON / OFF Rocker Switch (P6) on the sides of the box is also optional.



*Assembling the electronic circuit.*

1. Assemble the power system: connect the cables from the solar panel (P2) and the gel battery (P1) to the solar voltage regulator (P3). Pay attention to the polarity.
2. Solder the input cables of the power system to each voltage regulator (P11) in the IN+ and IN- position according to the corresponding polarity. Do the same with the egress ones (OUT +, OUT-). With a flat screwdriver, turn the upper screw to modify the output voltage until it reaches the desired one, measured with a multimeter. For the RPiW the output voltage must be 5.2v, while for the lighting system 3.0v. To carry out this operation, you must temporarily connect the power system, and then configure the voltage regulators.
3. Join the voltage regulator cables coming out for the RPiW with a mini USB male plug and connect it to the PWR IN. An alternative is to feed power through the GPIO, with pins 2 (+) and 4 (GND).
4. Make the series connection of two White LED diodes (P14) joining anode with cathode of each one. This way, you will assemble four series pairs that you must connect them in parallel with each other, that is, anode with anode of each pair, and cathode with cathode of each pair. Once the connection is finished, connect with the output cables of the other voltage regulator (P11).
5. Once the video camera (P10) is inserted, use the cable (P9) to connect it with the RPiW (P8)
6. The Red, Yellow and Green LEDs (P7) must connect the anode in parallel to pin 34 (GND). The Red connects to the GPIO14 (pin 8), Yellow GPIO27 (pin 13) and the Green GPIO22 (pin 15).
7. Connect the Mini USB to USB Female OTG Cable, and insert a 2.0 pendrive

**Operation instructions**

This section describes how to set the AntVRecord to start recording and how to adjust the video settings (resolution, duration, area capture, among others). For these instructions, you need to have the AntVRecord started and have access to the AntVRecord OS, either remotely via VNC Viewer connections or on site.

*Installing the software suite*

Setting up the software requires both a computer and the AntVRecord. It is assumed here that the computer uses a recent version of the Microsoft Windows operating system. Using a computer with a different OS is possible but it is not documented here. It is also assumed that the PC has internet access. In the following list, steps 1–6 are performed on the Windows computer, and steps 7–14 are performed on the AntVRecord itself. For all these steps, it is recommended to power the AntVRecord via the power USB port of the RPiW using an external power supply.

1. Take the microSD card (P12) and connect it to your computer.
2. Format the microSD card (you can use freely available software such as SD Card Formatter).
3. Download the image (.img) file 'Raspbian Buster with Desktop' from the Raspberry Pi website.<sup>4</sup>
4. Install the Raspbian image to the microSD card using Raspberry Pi Imager.
5. Once Raspbian is installed on the microSD card it will appear on the computer as two separate drives, boot and root.
6. Eject the microSD card from the computer and insert it in the AntVRecord's Raspberry Pi.
7. Connect a mouse, keyboard and monitor to the Raspberry Pi and turn the power on. This step will require a micro-USB to USB adapter, a USB hub, and a mini-HDMI to HDMI adapter. The Raspberry Pi will boot and the graphical interface of Raspbian will appear on the monitor.
8. Upon the first start, a window will appear with instructions to configure the OS. Follow all the instructions to set up the country, password, wifi connection, and updates.
9. If not already done, connect to your Wifi network using the Wifi icon at the top right of the screen.
10. Open a terminal window and type the following commands:
  - (a) Ensure the OS is up to date:

```
sudo apt-get update && sudo apt-get upgrade
```

- (b) Install Python 3:

```
sudo apt-get install python3
```

- (c) Enable camera, SSH connection service, VNC Server from Raspberry PI configuration menu on desktop startup.
- (d) Install Remotely Access Raspberry Pi Via Bluetooth (SSH / VNC) via terminal and then reboot:

```
sudo apt install network-manager-gnome blueman
```

<sup>4</sup> <https://www.raspberrypi.org/downloads/raspbian/>

- (e) When restarting click on the recently installed Bluetooth icon, then Local Service, Services, check the Network Access Point (NAP) option and then assign an IP route for connection via VNC Windows (ejm IP Address: 10.20.30. # #). Then click on Bluetooth Devices and search for the device you want to pair. It is recommended to pair all the devices that will be used for recording, at least one laptop, tablet and smartphone. In Windows it is recommended to install the VNC Viewer application as well as in the tables or smartphone by Google Play or AppStore. In the first case, enable and pair bluetooth with AntVRecord, and then right click on the Bluetooth icon, Join a Personal Area Network, then select the device, right click and Connect Using Access Point. After that, in the VNC Viewer application enter the previously configured IP address, and then it will ask for User and Password. It is recommended to change it from the Raspberry environment in the configuration section.

Restart the Raspberry Pi to apply all the changes.

#### Installing AntVRecord OS

1. Once Raspbian has restarted, open a terminal windows and type:
 

```
cd Desktop
git clone https://www.github.com/fd-sturniolo/ant\_project
```
2. Install the necessary library for the operation AntVRecord OS, open a terminal Windows and type:
 

```
sudo apt-get install python3-pyqt5
sudo apt-get install python3-rpi.gpio
sudo apt install python3-smbus
sudo pip3 install Adafruit_DHT
pip3 install tomlkit
```
3. Move the shortcut AntVRecord contained in the 'ant\_project' folder to the Raspbian desktop. Open AntVRecord OS using "terminal mode" (Fig. 6).

#### Using AntVRecord OS

1. Select the configuration icon, this will open a "Time" configuration tab (Fig. 7a)
2. In the "Time" section the date and time must be initially set, then click on "default time". The default configuration will start the video one minute after the settled configuration, with 12 videos of 30 min duration. All these parameters can be modified according to user requirements.
3. In the "Video" section (Fig. 7b) you can configure the desired recording resolution and video file conversion (.mp4 by default).
4. The "Visualization" section is developed to observe through the remote desktop, what the Raspberry Pi Camera is recording. To do this, "View" must be checked and then the image captured by the camera is shown (Fig. 7c). This way you can calibrate in the field if the recording area is correct. Also, you can leave the video display on the Desktop to observe the video capture in real time.
5. In the last section, "Crop", it is possible to trim the recording area. To do this, click on "View" and then select from 0 to 1 (in width and height) the cropping percentage for the desired video resolution. Also, the location of the cropping area can be changed ("pos x" and "pos y"). To test the final configuration, it is suggested to click on "View" as changes are made.
6. Once the configuration is acceptable, click on "Ok".
7. To start the recording, click on the Play button, and you will see that the configuration previously made will be obtained in the terminal console (Fig. 8)

### Validation and characterization

Eight AntVRecord devices were built and installed in five sites in central Argentina and one in southern Uruguay from November 2019 to June 2021, as part of a research project to study foraging rhythms of LCA. Table 1 details the tests performed at each site using the different video resolutions and storage requirements. At the beginning, the power system was with 7Ah gel batteries, but the duration was less than 36 h. With the modification of the 26Ah battery, a continuous duration of 26 days was achieved, considering days of full illumination, with clouds, and even in the middle of rain. Therefore, it exceeded the initial requirements for energy stability. On the other hand, there were no signs of dampness and water ingress inside the watertight box that could damage the electronics in any of the designs expressed in previous sections. Example frames are observed during the day (Fig. 9a) and at night (Fig. 9b) at the Oro Verde Site (Entre Ríos, Argentina) on *Acromyr-mex lundi* with the lighting system active.

For all deployments, the devices were configured to record video files during daylight and night, at 30 frames per second and at two resolutions: 640 × 480 pixels and 1200 × 720 pixels. The minimum and maximum duration of video recordings collected per deployment were 15 h (PNA La Esmeralda) and 854 h (School of Agronomy, UNER), respectively. This variability was associated with the hardware and software validation and testing process. Video files are compressed by the camera board during acquisition in native format (.h264) and then they are converted to (.mp4). In all cases, the devices were still

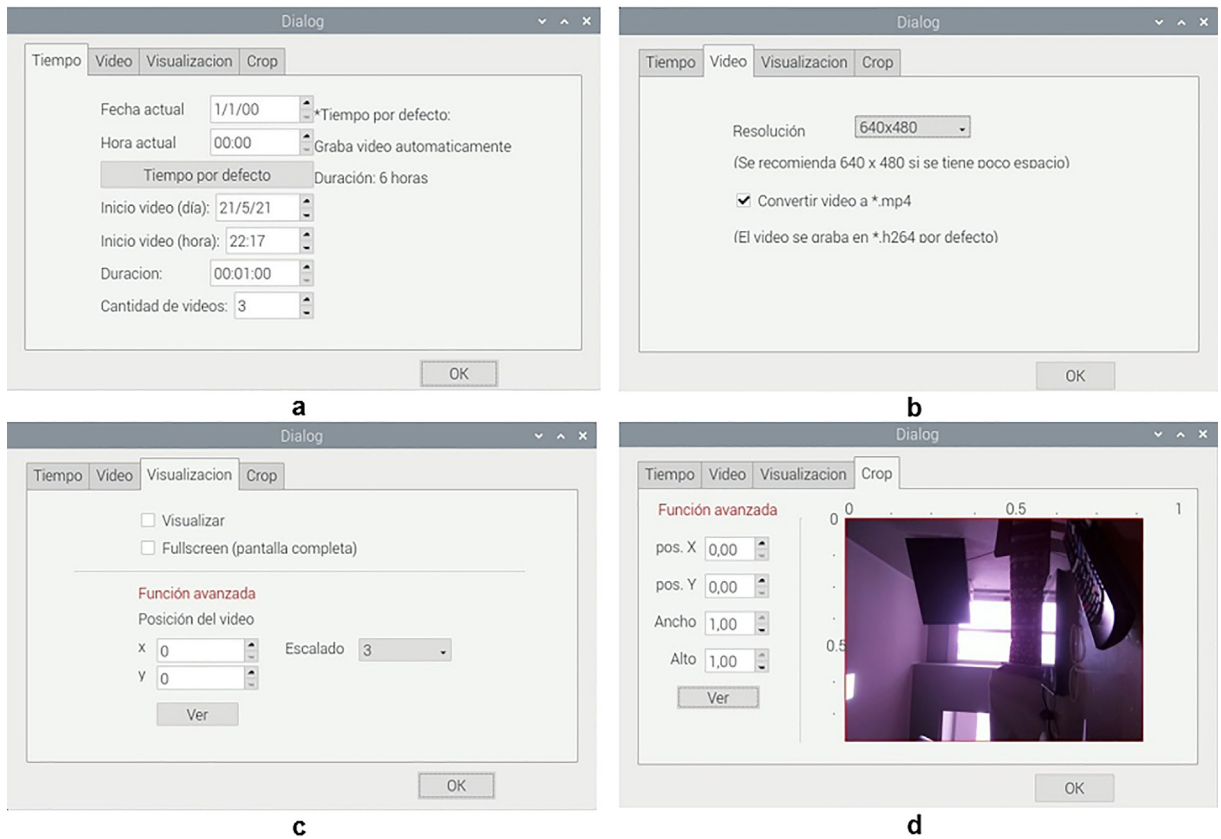

Fig. 7. Pantallas de configuración del AntVRecord OS.

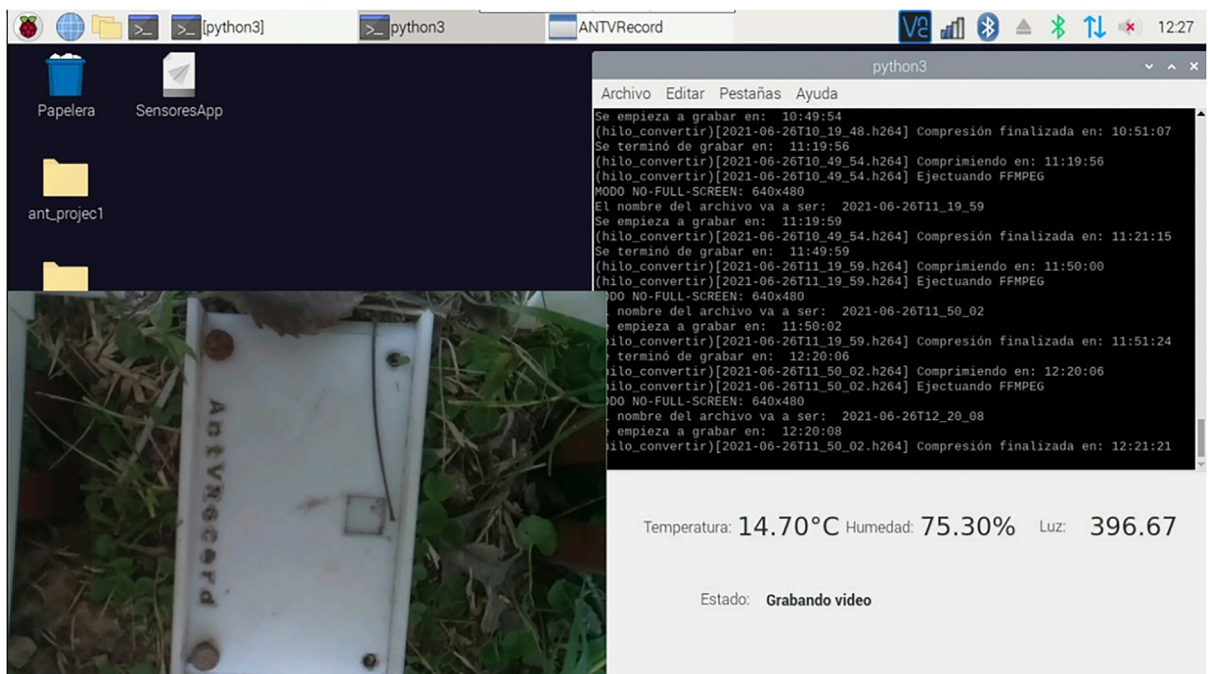
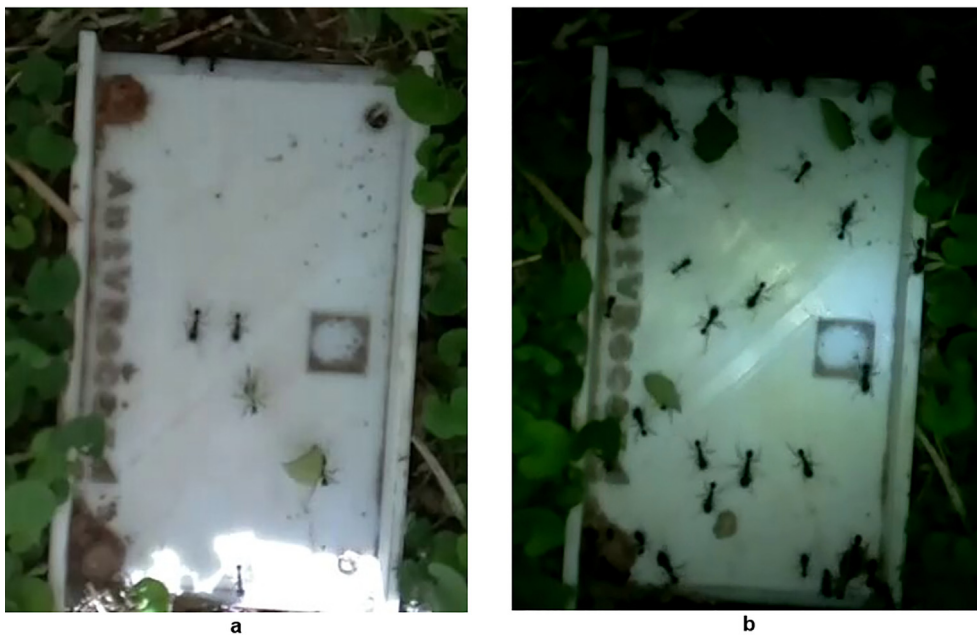

Fig. 8. Example of a configuration screen taking a video capture in the field.

**Table 1**  
Deployments of the AntVRecord in the field.

Field trial	Location/Ant specie	AntVRecord ID	Deployment date	Videos total length (hours)	Video resolution	Per-video length (hours)	Required storage
1	1-Protected Natural Area El Caraya (Feliciano, Entre Ríos) <i>Atta vollenweideri</i>	AntVRec_01	2019-06-02	36	640x480	60 min (36 files)	20.1 GB ( $\pm 558$ MB. $h^{-1}$ )
2	2-Protected Natural Area La Esmeralda (Las Garzas, Entre Ríos) <i>Atta vollenweideri</i>	AntVRec_02	2019-11-09	52	640x480	30 min (104 files)	23.4 GB ( $\pm 450$ MB. $h^{-1}$ )
3	2- Protected Natural Area La Esmeralda (Las Garzas, Entre Ríos) <i>Atta vollenweideri</i>	AntVRec_02	2020-01-09	15	1280x720	15 min (60 files)	15.9 GB ( $\pm 1.06$ GB. $h^{-1}$ )
4	3-3° Febrero Field (Las Garzas, Entre Ríos) <i>Atta vollenweideri</i>	AntVRec_02	2020-01-11	25	1280x720	60 min (25 files)	29.7 GB ( $\pm 1.15$ GB. $h^{-1}$ )
5	2- Protected Natural Area La Esmeralda (Las Garzas, Entre Ríos) <i>Acromyrmex lundi</i>	AntVRec03 & 04	2020-03-30	66.7	640x480	50 min (80 files)	19.6 GB ( $\pm 290$ MB. $h^{-1}$ )
6	2- Protected Natural Area La Esmeralda (Las Garzas, Entre Ríos) <i>Acromyrmex lundi</i>	AntVRec04 & 05	2020-04-04	94	1280x720	30 min (188 files)	55.7 GB ( $\pm 592$ MB. $h^{-1}$ )
7	4- School of Agronomy National University of Entre Ríos (Oro Verde, Entre Ríos) <i>Acromyrmex lundi</i>	AntVRec06 & 07	2020-11-23	230	640x480	60 min (230 files)	76.8 GB ( $\pm 334$ MB. $h^{-1}$ )
8	4- School of Agronomy National University of Entre Ríos (Oro Verde, Entre Ríos) <i>Acromyrmex lundi</i>	AntVRec07	2021-02-22 to 2021-06-23	854	640x480	60 min (854 files)	235.4 GB ( $\pm 276$ MB. $h^{-1}$ )
9	4- School of Agronomy National University of Entre Ríos (Oro Verde, Entre Ríos) <i>Acromyrmex heyeri</i>	AntVRec08	2021-03-04 to 2021-03-27	550	640x480	60 min (550 files)	211.2 GB ( $\pm 384$ MB. $h^{-1}$ )

**Fig. 9.** Example of video capture in the field for *Acromyrmex lundi* in Oro Verde (Entre Ríos, Argentina) during the day (a) and at night (b) using an active lighting system.

powered and running when retrieved after 4 days, indicating that they were not battery limited. However, their memory cards (16 Gb) were full. Using larger memory cards would increase the maximum deployment duration and the quality of video data recorded. The resolution of the AntVRecord videos acquired during the nine deployments allowed us to successfully count and identify leafcutter ants in the field using specific software observing particularly novel behaviors.

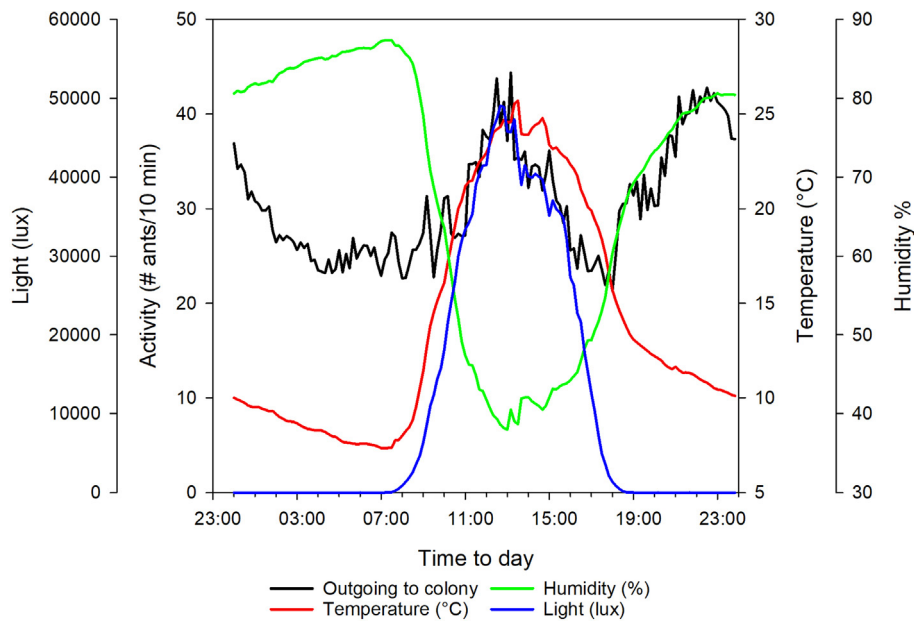

**Fig. 10.** Locomotion rhythms autumn of *Acromyrmex lundi* in Mesopotamia Argentina and its relationship with meteorological variables: temperature, humidity and light.

In summary, in this work we presented the AntVRecord device, an autonomous camera system that allows video capture of the locomotor behavior of LCA over longer time periods than most recording systems currently available on the market. The design is simple, easy to build, and inexpensive (less than 200 USD). It has been used successfully to monitor the locomotor and foraging activity of LCAs in their natural environment, without interfering with their natural behavior. As an illustrative example of the field application, a recent study wants to know the locomotion and forage rhythms of *Acromyrmex lundi*, a frequent LCA in Argentine Mesopotamia (AntVRec 7, Table 1). For study, the AntVideoRecord was used as a video capture device, obtaining more than 150 days of recorded data from March 2021 to the present. The videos were collected weekly and stored in a large storage device in the cloud. This data was later processed using a specific software developed for this purpose. Fig. 10 shows the average locomotion rhythms of the LCAs leaving the colony during the fall, based on 36 days of recording. Two activity peaks are observed: one during the morning, and the other at midnight. In addition, a positive relationship was established between locomotor activity with temperature and light intensity, but negative with humidity. These preliminary field results show that the design is reliable for the LCA behavior monitoring, making it a device that certainly will improve the knowledge in ecological science. Thanks to the flexibility of the Raspberry Pi board, the design is versatile, and it can easily be extended to fulfill specific needs such as adding external lights or sensors (e.g. pressure, temperature or radiation). Advances in technology, along with the increasing popularity of open-source systems and software, allow researchers to build sophisticated research instruments at lower costs. This contribution to the ethology of LCAs can be used for other areas of biology, or it can be adapted based on requirements. This also encourages citizen science initiatives that have the potential to improve and expand ongoing research by scientists [35].

### Declaration of Competing Interest

The authors declare that they have no known competing financial interests or personal relationships that could have appeared to influence the work reported in this paper.

### Acknowledgements

We thank the companies that allowed us to carry out the necessary tests for the development. This work is supported by UNER-PID No. 2233 «Ecological study of the forage rhythms of leafcutter ants in natural and anthropic environments to Mesopotamia Argentina» granted by Julian Sabattini and supported by ANII-FMV 156057 granted to Martin Bollazzi.

### Appendix A. Supplementary data

Supplementary data to this article can be found online at <https://doi.org/10.1016/j.ohx.2022.e00270>.

## References

- [1] B. Hölldobler, E.O. Wilson, *The Superorganism: the beauty, elegance and strangeness of insect societies*, W.W. Norton and Company, New York, 2009.
- [2] C.M. Blanton, J.J. Ewel, Leaf-cutting ant herbivory in successional and agricultural tropical ecosystems, *Ecology* 66 (3) (1985) 861–869.
- [3] C.W. Berish, Leaf-cutting ants (*Atta cephalotes*) select nitrogen-rich forage, *Am. Midl. Nat.* 115 (1986) 268–276.
- [4] J. Montoya-Lerma, C. Giraldo-Echeverri, I. Armbrrecht, A. Farji-Brener, Z. Calle, Leaf-cutting ants revisited: Towards rational management and control, *Internat. J. Pest Manage.* 58 (2012) 225–247.
- [5] R.S. Camargo, L.C. Forti, J.F.S. Lopes, N.S. Nagamoto, Studies on leaf-cutting ants, *Acromyrmex* spp. (Formicidae, Attini): behavior, reproduction and control, in: S.G. Pandalai (Ed.), *Recent Developments in Entomology Research*, Research Signpost, Kerala, 2006, pp. 161–182.
- [6] A.G. Farji Brener, J.F. Silva, Leaf-cutter ants' (*Atta laevigata*) aid to the establishment success of *Tapirira velutinifolia* (Anacardiaceae) seedlings in a parkland savanna, *J. Trop. Ecol.* 12 (1996) 163–168.
- [7] H.L. Vasconcelos, J.M. Cherrett, Leaf-cutting ants and early forest regeneration in central Amazonia: effects of herbivory on tree seedling establishment, *J. Trop. Ecol.* 13 (1997) 357–370.
- [8] A.G. Farji Brener, A. Illes, Do leaf-cutting ant nests make bottom up gaps in neotropical rain forests? A critical review of the evidence, *Ecol. Lett.* 3 (3) (2000) 219–227.
- [9] P. Moutinho, D.C. Nepstad, E.A. Davidson, Influence of leaf-cutting ant nests on secondary forest growth and soil properties in Amazonia, *Ecology* 84 (5) (2003) 1265–1276.
- [10] A.G. Farji-Brener, The effect of abandoned leaf-cutting ant nests on plant assemblage composition in a tropical rainforest of Costa Rica, *Ecoscience* 12 (4) (2005) 554–560.
- [11] H. Herz, W. Beyschlag, B. Hölldobler, Herbivory rate of leaf-cutting ants in a tropical moist forest in Panama at the population and ecosystem scales, *Biotropica* 39 (4) (2007) 482–488.
- [12] R. Wirth, W. Beyschlag, R.J. Ryel, B. Hölldobler, Annual foraging of the leaf-cutting ant *Atta colombica* in a semideciduous rain forest in Panama, *J. Trop. Ecol.* 13 (1997) 741–757.
- [13] C.B. Yackulic, O.T. Lewis, Temporal variation in foraging activity and efficiency and the role of hitchhiking behaviour in the leaf-cutting ant, *Atta cephalotes*, *Entomol. Exp. Appl.* 125 (2) (2007) 125–134.
- [14] E.H. Varón Devia, Distribution and foraging by the leaf-cutting ant, *Atta cephalotes* L., in coffee plantations with different types of management and landscape contexts, and alternatives to insecticides for its control, Ph.D. Thesis (2006) 130 pp.
- [15] N.A. Weber, *Gardening ants, the attines*, Memoirs of the American Philosophical Society, Philadelphia, 1972.
- [16] B. Hölldobler, E.O. Wilson (Eds.), *The Ants*, Springer Berlin Heidelberg, Berlin, Heidelberg, 1990.
- [17] E.S. Hodgson, An ecological study of the behavior of the leaf-cutting ant *Atta cephalotes*, *Ecology* 36 (1955) 293–304.
- [18] J.M. Cherrett, The foraging behaviour of *Atta cephalotes* L. (Hymenoptera: Formicidae), I: Foraging pattern and plant species attacked in tropical rain forest, *J. Anim. Ecol.* 37 (1968) 387–403.
- [19] T. Lewis, G.V. Pollard, G.C. Dibley, Micro-environmental factors affecting diel patterns of foraging in the leaf-cutting ant *Atta cephalotes* (L.) (Formicidae: Attini), *J. Anim. Ecol.* 43 (1) (1974) 143, <https://doi.org/10.2307/3163>.
- [20] J.F.A. Traniello, Foraging strategies of ants, *Annu. Rev. Entomol.* 34 (1989) 191–210.
- [21] H.L. Vasconcelos, H.G. Fowler, Foraging and fungal substrate selection by leaf-cutting ants, in: R.K. Vander Meer, K. Jaffe, A. Cedeno (Eds.) *Applied myrmecology, a world perspective*, Westview Press, Boulder, CO, 1990, pp. 410–419.
- [22] I.R. Leal, P.S. Oliveira, Foraging ecology of attine ants in a Neotropical savanna: seasonal use of fungal substrate in the cerrado vegetation of Brazil, *Insect. Soc.* 47 (4) (2000) 376–382.
- [23] P. Urbas, M.V. Araújo Jr., I.R. Leal, R. Wirth, Cutting more from cut forests: Edge effects on foraging and herbivory of leaf-cutting ants in Brazil, *Biotropica* 39 (4) (2007) 489–495.
- [24] P.S.D. Silva, I.R. Leal, R. Wirth, F.P.L. Melo, M. Tabarelli, Leaf-cutting ants alter seedling assemblages across second-growth stands of Brazilian Atlantic forest, *J. Trop. Ecol.* 28 (4) (2012) 361–368.
- [25] P.W. Kooij, J. Liberti, K. Giampoudakis, M. Schiøtt, J.J. Boomsma, Differences in forage-acquisition and fungal enzyme activity contribute to niche segregation in Panamanian leaf-cutting ants, *PLoS ONE* 9 (4) (2014) 9, e94284.
- [26] T. Balch Z. Khan M. Veloso Automatically and Analyzing the Behavior of Live Insect Colonies, in (Agents-2001), ACM 521 528
- [27] M. Egerstedt T. Balch F. Dellaert F. Delmotte Z. Khan What are the ants doing? Vision-based tracking and reconstruction of control programs 2005 Barcelona, Spain
- [28] J. Cho, J. Choi, M. Qiao, M. Ji, H. Kim, K. Uhm, T. Chon, Automatic identification of whiteflies, aphids and thrips in greenhouse based on image analysis, *International Journal of, Math. Comput. Simul* 1 (2007) 47–53.
- [29] N. Razin, J.-P. Eckmann, O. Feinerman, Desert ants achieve reliable recruitment across noisy interactions, *J. R. Soc. Interface* 10 (82) (2013) 20130079, <https://doi.org/10.1098/rsif.2013.0079>.
- [30] M. Shen, P. Szyszka, O. Deussen, C.G. Galizia, D. Merhof, Automated tracking and analysis of behavior in restrained insects, *J. Neurosci. Methods* 239 (2015) 194–205.
- [31] S. Bustamante, A.R. Amarillo-Suárez, AntCounter Software: Counting Leaf-Cutting Ants Was never so Precise, fast and Easy, *Journal of Insect Behavior* 29 (2016) 262–272.
- [32] X. Zhong, Y. Liang, Raspberry Pi: An Effective vehicle in teaching the internet of things in computer science and engineering, *Electronics* 5 (2016) 56.
- [33] Raspberry Pi Foundation. Raspbian. <https://www.raspberrypi.org/downloads/raspbian/>, 2021
- [34] D. Jones. Picamera. <https://picamera.readthedocs.io/en/release-1.13/>, 2015.
- [35] S. Gorgopa. Citizen Science Data Quality: Harnessing the Power of Recreational SCUBA Divers for Rockfish (*Sebastes* spp.) Conservation. M.Sc. thesis, University of Victoria, (September), 2018.



**Sabattini Julian** I am a young scientific researcher and university professor studying the behavior of leaf cutter ants in South America. I live in Argentina, I work at the National Council for Scientific and Technical Research and at the National University of Entre Rios. I am an Agronomist Engineer, Forest Resources Specialist and Doctor of Engineering. I am 31 years old and my passion is innovation and knowledge discovery. I am currently developing technologies and developments that simplify the study of the social behavior of insects. The main objective is to improve the estimates made so far by using engineering as a central resource for the solution.