

Shafts of technological machines with combined supports

S. Z. Yunusov^{1*}, S. N. Kenjayev¹, and Sh. A. Makhmudova²

¹Tashkent State Transport University, Tashkent, Uzbekistan

²Branch of the Russian State University named after I.M. Gubkin in Tashkent, Tashkent, Uzbekistan

Abstract. This article discusses experimental studies of a saw cylinder (SC) composite shaft with combined support. We proposed a new design of the support that provides a reduction in the shaft. The article considers the influence of changing the parameters of the elastic element of the support of the composite shaft (CS) of the SC using the ANSYS software, calculates and analyzes the reaction forces of the supports for different parameters of the elastic elements, and also considers the effect on the stresses of the system, as well as the results of experimental and comparative tests in production conditions on the SC of the cotton gin machines with a composite bearing, where the parameters of the elastic element differ from each other by different elasticity. The fiberization process took place according to the established technological parameters. The experimental and standard SC models were compared during the experiment.

1 Theoretical-calculation part

1.1 Introduction

In world practice, special attention is paid to developing new models of equipment and technology for ginning medium-staple varieties of raw cotton. At the same time, the implementation of targeted scientific research on the development of highly efficient designs of the working bodies of the main technological machine of the saw gin cotton mills, the creation of methods for calculating the parameters and motion modes, which allow a significant increase in the productivity of ginning. Numerous studies are devoted to the study of the technological process of ginning, the development of new working bodies, and gin units, optimization of technological, kinematic, dynamic, and other parameters of gins. In the Republic of Uzbekistan, large-scale measures are being taken to develop highly efficient equipment and technologies for the primary processing of raw cotton, ensuring the production of high-quality products [1].

As a result of research conducted in the world on the technology and technique of ginning of raw cotton, several scientific results have been obtained, including saw gins of the brand MY-171 (China), 4DP130, 5DP-130, DR-119, DPZ-180, Lummus-super 128,

*Corresponding author: ysz1979@gmail.com

Herdwick-Etter with air removal of fiber, the USA and the Republic of Uzbekistan were created, calculation methods were developed massive SCs (Kostroma Textile Academy, Institute of Mechanical Engineering, Russia), the laws of oscillatory movements of the working bodies of technological cotton processing machines were obtained (Ivanovo Textile Academy, Russia), the patterns of evaporation inside the material (raw cotton) during heat drying were established (Texas Tech University, USA), methods for calculating machines for the primary processing of cotton (TITLP, "Pakhtasanoat Ilmiy Markazi" JSC, Uzbekistan) [2].

Formulation of the problem. An analysis of previous research shows that developing a new saw gin support design is relevant.

Development of a new design of the shaft support, which reduces the vibration of the shaft parallel to the displacement of the axis of the shaft along the vertical with an asymmetric arrangement of masses on the shaft along its length. Vibration damping of rotating shafts with a composite elastic element of the proposed support design, the parameters of the elastic element are selected in proportion to the distance from the point of influence of the external load to the support, the design of the composite shaft is described [3-5].

The technological parameters of the system, acting on the shaft structure, cause internal forces (stresses) and deformations in them or qualitative changes that affect the durability. The reasons leading to such consequences are called influences [6].

When calculating shaft structures for the effects of technological loads, it is allowed to set them as equivalent loads. Design parameters P technological loads. From the point of view of the reliability of the influence of technological loads on the reaction forces arising on the supports, deformation, they have not been sufficiently studied. Sometimes, in addition to external influences, that is, the technological loads of the system, the internal influences of the system are distinguished. Internal influences result from the interaction of the structure with the technological process, a manifestation of feedback, confirming the action of one of the basic system principles [7].

The classification of impacts is the basis for their modeling and control of the reliability of design structures, the description of which is carried out using mathematical models. Mathematical models reflect the relationship between various features and factors on which the system's operation depends. When choosing a mathematical midsection, the causes of stresses in the system is analyzed. For the effectiveness of the analysis, we pay attention to the classification of the impact of technological loads on systems, which consists of a composite shaft with elastic elements on supports.

By origin, technological loads are divided into direct and indirect. Technological loads that have a power character are usually called direct loads. The direct load is independent of the properties or response of the structure. Indirect loads (corrosion, obsolescence, durability, elastic element parameters, etc.) affect structures through durability. Depending on the duration of action and changes over time, permanent and temporary (long-term, short-term, special) loads are distinguished [8].

Constant loads act on the structure during the entire service life without changing its value, direction, and position. Permanent loads include the own weight of the structure. In addition, the forces from prestressing remain in the structure [8].

Loads that change values or positions at different points in time are called temporary loads. Loads that act on the system structure for a certain period.

We were tasked with calculating the reaction of the proposed shaft design with elastic bearing supports. The problem was solved using the ANSYS program.

1.2 Significance of the system

Analysis of structures in the ANSYS system. To analyze and solve the problem of using methods, object modeling simplifies the process, but at the same time is the most time-consuming step. In mechanics, based on mathematical models, the geometric parameters of a model or object are specified, and the influences of input parameters (material properties, conditions, and technological load) are determined.

1. Building a mathematical model of a specific design (geometry, boundary conditions) or importing them from CAD systems.

2. Studying the response of a structure to various physical influences, such as the impact of various loads, temperatures, and electromagnetic fields, solving problems of fluid and gas mechanics.

3. Optimization of the construction geometry.

To solve a problem using ANSYS, the following steps must be taken: problem setting and model development; obtaining results with variations of input parameters; analysis of results taking into account changes in input parameters. The ANSYS program can present the results as graphs or tables. In the ANSYS system, depending on the type of solution chosen, as well as depending on the type of problem, the following parameters are determined: choice of method for solving the resulting systems of equations; setting the solution parameters (load step, number of steps, integration step, number of defined eigenforms, etc.); setting the accuracy of the solution; setting parameters for writing results to a file, etc.

To correctly specify the specification of a solution, it is necessary to know the properties of the solutions of the analyzed problems.

Construction of a calculation model for the proposed saw gin composite shaft design.

1.3 Methodology and calculation

We present the design (approximate view) of the proposed saw gin shaft with combined support (Fig. 1.) and take the following system parameters as input:

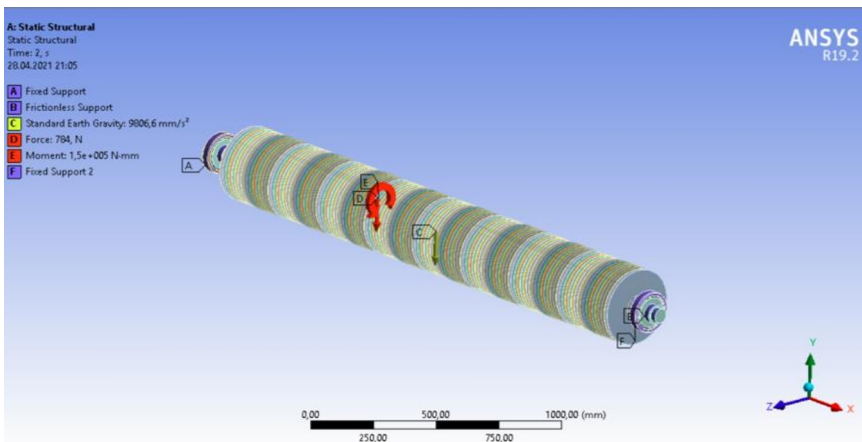

Fig. 1. General view of the proposed saw gin shaft with combined support in the ANSYS systems.

The following system data were used in the calculations.

$$F=784\text{N}; M=150\text{ Nm}; F_m=m_1g+m_2g; m_1=141.2\text{ kg}; m_2=59\text{ kg}.$$

$$\text{Shaft: } st-3, E=2 \cdot 10^{11}; \mu=0.3; \rho=7850\text{ kg/m}^3.$$

$$\text{Gasket: Aluminum 9, } E=7 \cdot 10^{10}; \mu=0.34; \rho=2698\text{ kg/m}^3.$$

$$\text{Rubber: Hk 7-106, } E=7 \cdot 10^7; \mu=0.45; \rho=1200\text{ kg/m}^3. L=2300\text{mm}; AD=898.95\text{mm}$$

We are interested in the question of how changes in the parameters of the elastic element of the support will affect the calculated loads arising in the system. In solving the mathematical model of the compound shaft of the gin SC, the geometric parameters (rubber thickness) of the elastic element changed. At the same time, two models were considered, the thickness of the elastic element in the supports varied, and the system of cumulative acting forces remained unchanged.

1.4 Experimental results

Calculated values of a system with an elastic element of composite shaft support. Consider the first calculation model; this is when the thickness of the elastic element on support A is greater than the thickness of the elastic element on support B. We will analyze the results of the calculation using graphs (Fig. 2.a.). The results are summarized in Table 1.

Table 1. The thickness of the elastic element in the ratio $A \geq B$

№	A	B	x		y	
			R _A	R _B	R _A	R _B
1	0	0	22.85	-22.85	1188	902
2	0.5	0.25	8.9764	-8.9764	1147.3	943.01
3	0.75	0.5	9.9344	-9.9344	1152.6	936.15
4	1	0.75	10.853	-10.853	1158.1	929.84
5	1.25	1	11.795	-11.795	1163.7	923.2
6	1.5	1.25	12.751	-12.751	1170.1	917.3

Continuation of table No. 1.

№	z		Total	
	R _A	R _B	R _A	R _B
1	-0.38492	0.38487	1188.2	902.29
2	-0.23695	0.23795	1167.8	943.24
3	-0.20703	0.20703	1147.4	936.21
4	0.089145	0.089158	1152.6	929.9
5	0.12914	0.028714	1158.2	923.89
6	0.25667	0.27567	1163.8	918.02

Tables A and B in mm, R_A, and R_B in N.

In the second calculation model, we changed the value of the thickness of the elastic element on the supports proportionally; that is, the thickness of the elastic element on support B is greater than the thickness of the elastic element on support A. The results are summarized in Table 2.

We will analyze the obtained calculation results using graphs (Fig. 2.b.).

Table 2. The thickness of the elastic element in the ratio $B \geq A$

№	A	B	x		y	
			R _A	R _B	R _A	R _B
1	0	0	22.85	-22.85	1188	902
2	0.25	0.5	3.1874	-3.1874	1190.2	899.04
3	0.5	0.75	9.245	-9.245	1175	913.74
4	0.75	1	13.373	-13.373	1168.7	919.49
5	1	1.25	17.501	-17.501	1162.4	925.24
6	1.25	1.5	21.629	-21.629	1156.1	930.99

Continuation of table No. 2.

№	z		Total	
	R _A	R _B	R _A	R _B
1	-0.38492	0.38487	1188.2	902.29
2	-0.23881	0.23881	1190.2	899.04
3	-0.22037	0.22037	1175	913.79
4	-0.22879	0.22878	1168.8	919.59
5	-0.23721	0.23719	1162.6	925.39
6	-0.24563	0.2456	1156.4	931.19

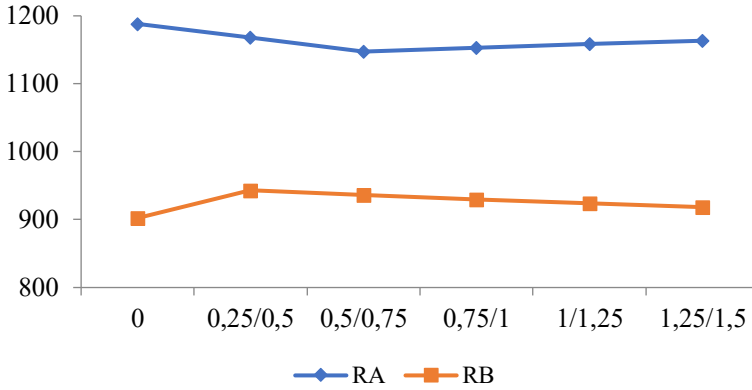

a) when A ≥ B

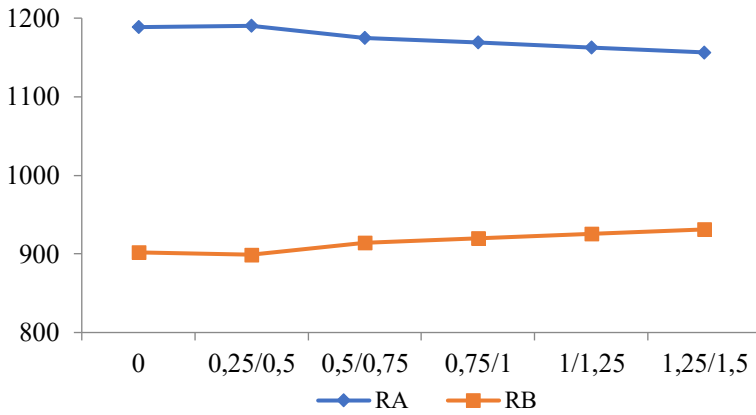

b) when B ≥ A

Fig. 2. Graphic dependences of the change in reaction forces on the supports of the SC shaft on the variation in the thickness of the elastic element

We were also interested in the question of the effect of changing the parameters of the elastic element of the combined support on the stresses arising in the shaft, in particular, deformation, elastic deformation, and stresses of the system (table 3).

Table 3. The thickness of the elastic element in the ratio $A \geq B$ and $B \geq A$

№	A	B	Total Deformation ($10^{(-6)}$)		
			min	max	avg
The thickness of the elastic element in the ratio $A \geq B$					
1	0.5	0.25	4.65	1800	859
2	0.75	0.5	6.42	1600	802
3	1	0.75	2.18	1410	755
4	1.25	1	-0.0511	1310	707
5	1.5	1.25	-1.28	1120	651
The thickness of the elastic element in the ratio $B \geq A$					
1	0.25	0.5	3.65	1300	651
2	0.5	0.75	2.42	1400	703
3	0.75	1	1.18	1510	755
4	1	1.25	-0.0511	1610	807
5	1.25	1.5	-1.28	1720	859

Continuation of table No. 3.

№	Equivalent Elastic Strain ($10^{(-6)}$)			Equivalent Stress - (10^6)		
	min	max	avg	min	max	avg
The thickness of the elastic element in the ratio $A \geq B$						
1	0.05895	963000	279000	0.000205	562	198
2	0.0481	256000	254000	0.000973	465	166
3	0.0818	158000	229000	0.000980	364	153
4	0.0855	147000	204000	0.001053	278	139
5	0.09811	130000	178000	0.00109	205	112
The thickness of the elastic element in the ratio $B \geq A$						
1	0.0115	559000	279000	0.000802	17.7	8.83
2	0.0986	508000	254000	0.000859	105	52.3
3	0.0818	458000	229000	0.000916	191	95.7
4	0.0649	407000	204000	0.000973	278	139
5	0.0481	357000	178000	0.00103	365	183

In Tables A and B in mm, Total Deformation in m, Equivalent Elastic Strain m/m, Equivalent Stress in Pa.

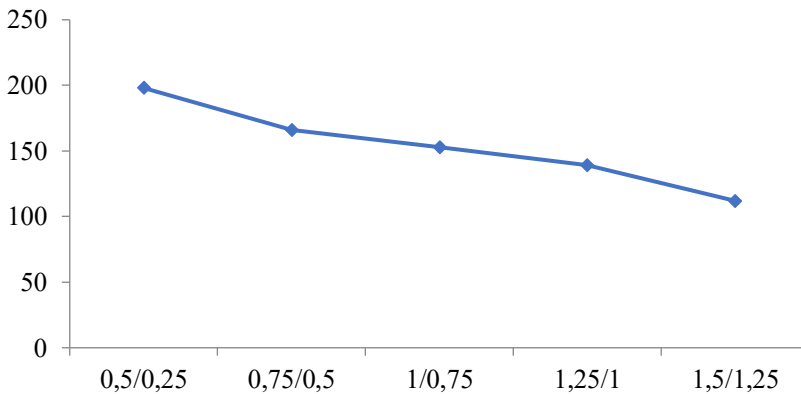

a) when $A \geq B$

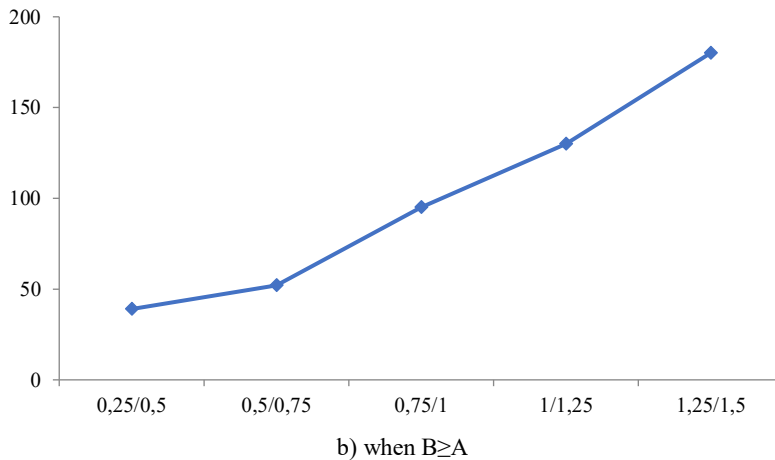

Fig. 3. Graphical dependences of the system voltage change on the variation elastic element thickness

Analysis of the received data. When analyzing the results obtained, it was found that the thickness of the elastic element located on the supports also affects the stresses of the entire system. Of course, the thickness of the elastic element also affects the values of the balancing forces on the supports (reaction forces). The graphs (Fig. 2, a) show, with a greater thickness of the elastic element at point A, than at point B, the magnitude of the reaction forces at the support at point B decreases R_B from 943.24 N to 918.02 N, and vice versa (Fig. 2,b) where the parameters of the elastic element at point B are greater than at point A, respectively, R_B increases from 899.04 N to 931.19 N.

These dependencies, that is, the influence of the elastic element parameter on the reaction forces arising in the system, are directly proportional to the total loads of the system. From the tabular data and graphic dependencies, the following can be noted, if the thickness of the elastic element at point A is greater than at point B in Fig.3.a. system stress decreases from $198 \cdot 10^6$ to $112 \cdot 10^6$. Accordingly, if the thickness of the elastic element at point B is greater than at point A Fig. 3.b. system stress increases from $8,83 \cdot 10^6$ to $183 \cdot 10^6$. By changing the parameters of the elastic element, it is possible to determine the influence of the parameters of the elastic element of the composite shaft support on the resulting system stresses.

2 Practical and experimental part

2.1 Introduction

The disadvantage of the existing supports as part of any mechanisms and machines is the direct transmission of the oscillations of the rotating shafts in the machine bodies and mechanisms on the bodies themselves, which leads to an increase in the vibration noise of the corresponding machines and mechanisms. In addition, the design does not allow parallel displacement of the shaft axis with vertical deformations of the supports at a non-symmetrical arrangement of masses on the shaft; that is, the center of mass of the shaft is not located in the middle along the length of the shaft. This leads to a violation of the movement of the machine due to a violation of technological gaps.

The reliability of shaft bearings depends on dynamic loads [9] to determine which simplifications were made. The section method was used in the calculations, where the

supports were considered in several segments. The resulting equation was solved by the finite element method, where the dynamic characteristics of rolling bearings were evaluated, the analysis was carried out, and the results were compared. When calculating the system for dynamic loads, the input factors' parameters varied. From the results obtained after the calculations, it can be argued that the rigidity in the vertical direction is greater than the rigidity in the horizontal direction. It can also be noted that they are directly proportional to the shaft revolutions. With the help of the results obtained, it is possible to reason about the trajectory of loads and the dynamic conditions of the shaft and bearing system.

Changes in the rigidity of the technological system affect the accuracy of manufacturing and operation of rotating elements (shaft), control of the technological load does not fully ensure the accuracy of manufacturing and operation of the system. It is known that changes in the rigidity of the technological system affect the accuracy of the shaft, while it is necessary to control the load on the system. In [10], the authors propose a method for calculating the load required for the shaft manufacture, where deviations were taken into account, i.e., shaft design accuracy. Elastic movements control the load during manufacture; an automatic control system supports the calculated load. The equations for calculating elastic displacements depending on the rigidity of the technological system are recommended, which are given as a separate control system.

In recent years, many scientists have been working towards improving methods for calculating the dynamic loads of rotating elements of machine units; in [11], the dependences of technological resistance, particularly the bending moment of a steel shaft, are given. The friction force is measured experimentally under conditions of a whole steel shaft of different sections (diameter), using mathematical tools and the trajectory equation. Accordingly, the curve was obtained by approximation. The author claims that, according to experimental data, the diameter of the shaft section (i.e., the smaller the bending radius) is proportional to the pressure between the center and the surface of the shaft. The positive load between the center and the surface of the shaft is proportional to the coefficient of curvature. The positive pressure in the center and surface of the shaft is proportional to the coefficient of curvature. Using the method of simplification and approximation, the formula for the frictional resistance of steel composite shafts in the state of complex bending was obtained, contributing to the calculation of the frictional resistance in complex bending. In contrast, the average calculation error following the well-known requirements is 5%.

In [12], the authors investigated the kinematic-working scheme of the SC and the results of studying the effect of the technological load on the bending of the SC shaft, a method for calculating the deflection and technological parameters (clearances), in particular, between the SC saws and the grate, which should be set in accordance technological regulations. The process of bending oscillations of the SC of a fiber separator is considered, the design of which consists of steel saws and aluminum spacers sequentially mounted on a steel shaft. When calculating the coefficients of internal concentrations of forces, use the method of sections, and consider the shaft as a hinged beam. This calculation model is close to the maximum for rotating shafts of technological machines.

There is a displacement of the shaft support in the direction from the center to the inner end; this occurs due to the deformation of the shaft and bearing [12]. In the calculations, it should be taken into account that the load distribution occurs along the length of the shaft, as well as the properties of the elastic element of the composite bearing. It is known that the design of the compound shaft also affects the stresses on the compound shaft and also affects the loads transmitted to disks, pulleys, gears, and other parts. Structural and technological parameters affect the load distribution in the contact zones of the system under study, leading to significant difficulties in mathematical calculations.

Several works have been devoted to studying the rigidity of ball bearings. R.V.Atstupinas, V.S.Bochkov, V.F.Zhuravlev, M.P.Kovalev, S.A.Kharlamov, A.K.Yavlensky [13-18].

The elastic properties of ball bearings as a factor affecting the accuracy of machines and devices are the subject of research in the works of L.V.Novikov, V.A.Pavlov, V.A. Nikitin [19-25].

We have proposed a new support design that reduces shaft vibration by parallel displacement of the shaft axis vertically at the asymmetrical arrangement of masses on the shaft along its length [4].

The SC of the genie is designed to capture the fibers of the fly fibers with the teeth of the saw blades, tear them off from the seeds, and carry them out through the slotted gaps in the grate to the air-removing device. In addition, simultaneously with the separation of the fiber, the SC, coming into contact with the raw roller on the arc of the capture of the fiber into the working chamber, rotates it, which creates conditions for the constant supply of fresh air to the saw blades.

The following basic technological requirements for the SC have been established: the SC must have a high gripping ability to ensure the specified performance and uninterrupted rotation of the raw roller, and the saw blades must be rigidly fixed to the shaft of the SC and not change their position during operation. When the cylinder rotates, the saws pass strictly in the center of the slotted gap between the grates. One side of the SC shaft is closed with a safety sleeve, and the other is connected to the motor shaft through a semi-rigid coupling. Along the entire working length of the shaft, a groove is milled, including the saw blade's tongue, which protects the saw from turning. In the middle of the working length of the saw shaft, a fixing washer is mounted, from which saw blades are placed on both sides [2].

The structure of which is shown in Fig. 4.

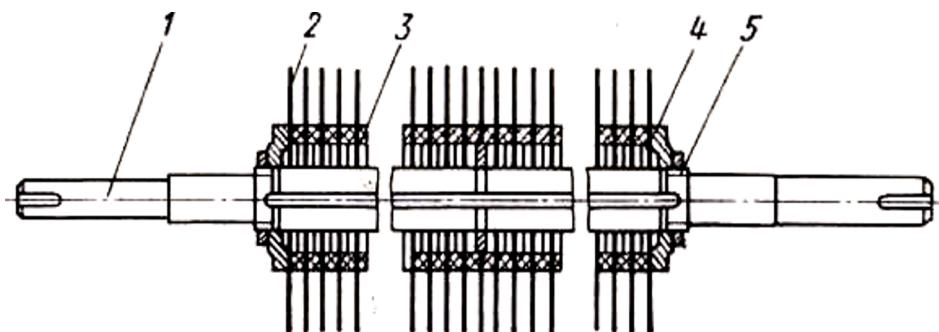

Fig. 4. General view of the genie SC: 1 is saw shaft, 2 is saw blades, 3 is saw spacers, 4 is washers, 5 is clamp nuts (right and left).

2.2 Methodology and experience

For experimental and comparative tests under production conditions, the SC with a composite bearing is installed on one of the saw gins, where the parameters of the elastic element differ from each other by different elasticity. The fiberization process took place according to the established technological parameters. The experimental and standard SC models were compared during the experiment.

Product quality determinations were made using approved standard procedures, i.e., the total amount of impurities in the fiber was compared with the results of fiber yield and seed hairiness. At the same time, it was noticed that the service life of the SC shaft bearings of

the experimental model (by reducing the loads applied to the bearings during operation) is increased by 4÷4.5 times compared to the existing design.

The difference in the thickness of the elastic element, set for the case when the system of forces acting on the SC shaft is not symmetrical on a bearing base, ensures smooth operation of the SC by reducing the bending and vibration of the shafts, in which the elastic element is used thicker for the section with a large tension on the shaft and vice versa. In the process of ginning raw cotton, the fiber's total amount of impurities affects the product's quality. As a result of the experiments, a decrease in the number of impurities in the fiber composition was observed. The existing SC bearing has reduced shaft deflection and increased vibration, which affects machine performance and product quality. Eliminating shaft bending and vibration has a positive effect on machine performance. In addition, the damping of the reaction forces arising in the supports acting bearings, due to the elastic element, positively affects system performance. The quality of the manufactured product will improve, and the service life of the bearing and shaft will increase. The recommended design of the bearing support is shown in Figure 5.

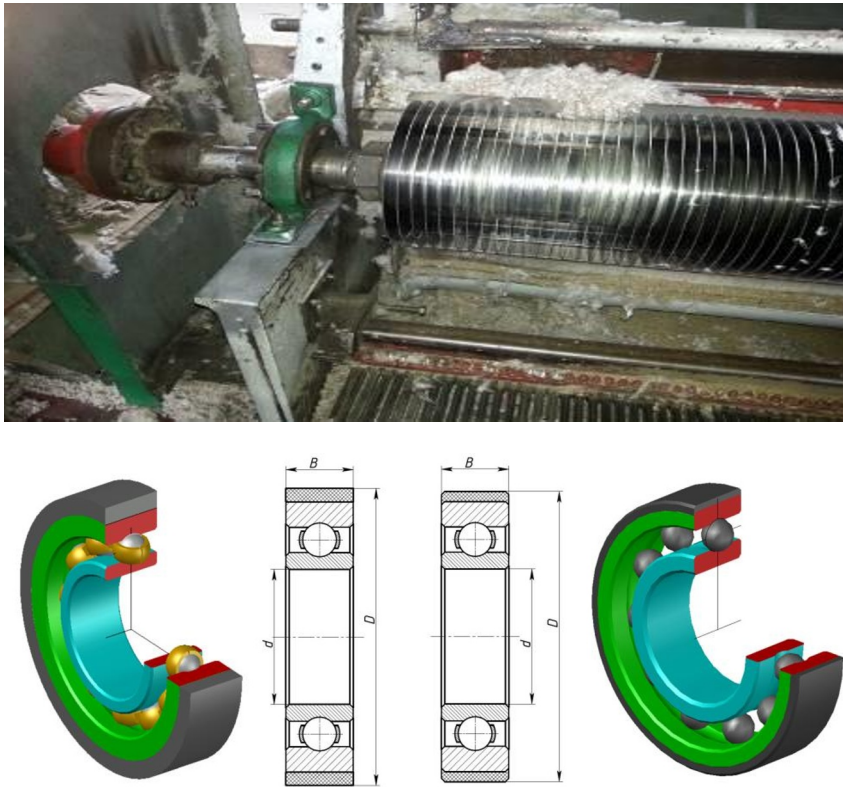

Fig. 5. Prototype of a bearing with an elastic element: (2 different thicknesses) mounted on the SC shaft.

2.3 Experimental results

In the laboratory of the cotton gin, the quality of the fiber obtained from the ginning process with the recommended compound shaft was determined.

Experimental studies were carried out at the cotton ginning enterprise at "Namangan to'qimachi klaster" LLC cotton processing plant; the results are presented in table 1. During the experiment, the following was established:

- high efficiency of the new experimental model of the compound shaft of the SC;
- improving the possibility of processing parts (shaft, bearing, bearing shell, saw in a grinding machine).

Table 4. Results of comparable experiments in ginning enterprise at "Namangan to'qimachi klaster" LLC

Readings available	Cotton gin in the factory	Experimental model cotton gin
Incoming cotton raw material		
Moisture contents, %	11.9	11.9
The amount of pollution is mass fraction, %	8.5	7.5
Mechanical damage, %	3.2	2.5
Accumulation of impurities in the fiber, %	3.7	3.7
Fiber yield, %	31	31
Semen hairiness, %	11.8	12.8

The experiments were carried out in triplicate based on a proven existing methodology, in which the thickness of the elastic element was changed; the parameters are shown in table 4. The arithmetic mean values are taken in the table 5.

Table 5. Arithmetic mean parameters of the value of the elastic element

No	Elastic element thickness at point A	Elastic element thickness at point B
1	0.25 mm	0.5 mm
2	0.5 mm	0.75 mm
3	0.75 mm	1 mm

3 General conclusions

1. The analysis of the results showed that the total amount of impurities in the fiber decreased, the fiber yield and the pubescence of the seed seeds, and the mechanical damage decreased when using the recommended designs of the SC shaft support, this, in turn, shows an increase in the fiber yield, in addition, during experimental studies, it was determined that due to the elastic element, the characteristics of the SC shaft supports and casing parts, in particular, the service life of the bearings on the SC shafts is increased.

2. Table 1 shows the results of experimental studies and quality indicators after determining the quality of the fiber. Analysis of the results showed that the total amount of impurities in the fiber decreased, fiber yield and seed hairiness by 0.3%, and mechanical damage decreased by 0.2% when using the recommended designs of the SC shaft support, this, in turn, shows an increase in fiber yield by 0.4%, in addition during experimental studies it was determined that due to the elastic element, the characteristics of the SC shaft supports and casing parts, in particular, the service life of the bearings on the SC shafts, increased by 4 ÷ 4.5 times compared to with the existing option. The service life of saws is increased by 2 times when assembling a saw machine with a belt element mounted on the supporting base of the SC shaft. The total economic effect from the introduction of the proposed design amounted to 82.95 million sums.

According to the conclusion and proposal of the commission, it was recommended to introduce the grinding machine's new design bearings.

References

1. Djurayev A., Yunusov S., Mirzaumidov A. Research to improve the design of the node of the saw cylinder gin. *International journal of advanced research in science, engineering and technology*, Vol. 6(6), (2019)
2. Djurayev A., Yunusov S., Mirzaumidov A. Development of an effective design and calculation for the bending of a gin saw cylinder. *International Journal of Advanced Science and Technology*, Vol. 29(4), pp. 1371-1390. (2020).
3. Agzamov M., Yunusov S., Gafurov J. On the technological development of cotton primary processing, using a new drying-purifying unit. In *IOP Conference Series: Materials Science and Engineering*, Vol. 254(8), (2017)
4. Yunusov S., Agzamov M., Kamolov N., Pardayev Kh. Influence Of Ginning For Paddle Roll Speed Raw Roller Saw Gin. *Test Engineering and Management*. pp. 3908 – 3917 (2020).
5. Juraev A., Magrupov A., Yunusov S., Mirzaumidov A., Makhmudova Sh. UZ IAP 06790 Patent of the Republic of Uzbekistan. Supports for vibration damping of rotating shafts, (2022).
6. Yunusov S., Sultonov A., Rakhmatov M., Bobomurotov T., Agzamov M., (2021). / Results of studies on extending the time operation of gin and linter grates. In *E3S Web Conf*. Vol. 304, (2021)
7. Murodov O.J., Djuraev A., Narmatov, E.A. Analysis of the vibrations of a console column made on a base with non-line protection in gin. *Journal of Physics: Conference Series*, Vol. 1889(4), (2021)
8. V.V.Gurin, V.M.Zamiatin, A.M.Popov. Machine parts and design basics. Proc. for universities. Tomsk: Publishing House of the Tomsk Polytechnic University, p.427, (2010)
9. Yang H., Li, J., Li, X., Calculation of the Dynamic Characteristics of Ship's Aft Stern Tube Bearing Considering Journal Deflection. *Polish Maritime Research*, Vol. 27(1), pp. 107-115. (2020)
10. Marcinkevičius A.H., Vilnius Gediminas. Automatic control of longitudinal form accuracy of a shaft at grinding. *Technical University, Basanavičius 28, 03224 Vilnius, Lithuania*.
11. Liu Y., Li J., Wang T., Ding Y., Wang G. Study on the friction resistance calculation method of a flexible shaft of wire rope based on genetic algorithm. pp. 2836-2844 (2021).
12. Birger I. A. Calculation for the strength of machine parts: Directory/№ 4th ed., M.: Mashinostroenie, p. 640. (1993).
13. Atstupinas V.R. Investigation of the radial stiffness of rolling bearings, taking into account their manufacture. *Vibrotechnics*, Vilnos, №. 4 (13) (1970)
14. Bochkov V.S. Static of angular contact bearings. *Proceedings of the Institute / VNIPP*, 1966, No. 3, pp. 94-110. (1966).
15. Zhuravlev V.F. The problem of equilibrium of a non-ideal ball bearing". // *Solid State Mechanics*, №. 4, pp. 72-77 (1970).
16. Kovalev M.P. Supports and suspensions of gyroscopic devices. M.: Mechanical engineering, 287, pp. (1970).
17. Kharlamov S.A. On the rigidity of a radial-thrust bearing with axial interference. *Mechanics and Engineering*, № 5, pp. 139-141. (1962).
18. Yavlensky A.K., Yavlensky K.N., Theory of dynamics and diagnostics of rolling friction systems. Leningrad University Publishing House, pp. 184. (1978).

19. Novikov L.V. Determination of natural frequencies of oscillations of an electric motor associated with the nonlinear elasticity of bearings, *Mechanics and Engineering*, № 6, pp. 84-90. (1961).
20. Pavlov V.A. *Fundamentals of design and calculation of gyroscopic instruments*, L.: Shipbuilding, p. 408. (1967).
21. Nikitin E.A. *Gyroscopic systems. Elements of gyroscopic devices*. Moscow: Higher school, p.472. (1972).
22. O. Toirov and N. Tursunov. Development of production technology of rolling stock cast parts, *E3S Web of Conferences*, Vol. 264, p. 05013 (2021).
23. O. Toirov, N. Tursunov, Sh. Alimukhamedov, and L. Kuchkorov. Improvement of the out-of-furnace steel treatment technology for improving its mechanical properties, *E3S Web of Conferences*, Vol. 365, p. 05002 (2023).
24. L. Kuchkorov, Sh. Alimukhamedov, N. Tursunov, and O. Toirov. Effect of different additives on the physical and mechanical properties of liquid-glass core mixtures, *E3S Web of Conferences* Vol. 365, p. 05009 (2023).
25. Turakulov M., Tursunov N., and Alimukhamedov S. Development of technology for manufacturing molding and core mixtures for obtaining synthetic cast iron. In *E3S Web of Conferences*, Vol. 365, p. 05006 (2023).