

Characterization of machine tools and measurement system for micromilling

Andrea Abeni ^{*}, Matteo Lancini, Aldo Attanasio

Department of Mechanical and Industrial Engineering, University of Brescia, Italy

ARTICLE INFO

Keywords:

Micromilling
Machine tool performance test
Tool run-out
Force analysis
Modal analysis

ABSTRACT

Technological progress has led to increased demand for small components with tiny features, which cannot be achieved through conventional machining. Industrial application of processes based on microcutting is limited by some issues concerning the geometrical scale. The process performance is significantly affected by milling machine, tool holder, tool, workpiece material microstructure, workpiece fixtures, and process parameters. At present, an ultimate micromachining assessment procedure is not available. This study aims to propose and conduct an experiment on a testing procedure for micromilling. The set up to be implemented and the output to be considered are defined and described. Three major stages are identified: estimation of the effective bandwidth of the load cell–tool holder system, the milling machine natural frequency measurement, and micromilling test execution. The entire procedure is performed, and its robustness is demonstrated.

Copyright © 2019 Tianjin University. Publishing Service by Elsevier B.V. on behalf of KeAi Communications Co., Ltd. This is an open access article under the CC BY-NC-ND license (<http://creativecommons.org/licenses/by-nc-nd/4.0/>).

1. Introduction

In the last decades, micromilling has been very successful in various industrial fields, such as biomedical, medical, electronic, military, and aerospace.¹ The possibility to obtain small-scale features with high accuracy and versatility facilitates the extensive use of microcutting. The size effect results in increased cutting forces and consequent relevant tool wear.² Micromilling is affected by several factors, such as tool run-out,³ burr formation, and ploughing.⁴ Numerous studies investigated workpiece material microstructure, process parameter optimization, and thermal stability.^{5–7} Controlling all these aspects is crucial to achieve high-quality products and economic efficiency. The influence of these aspects on the process must be estimated and limited to a certain degree to ensure robust micromachining.

Finite element (FE) simulation is typically implemented to determine the chip formation mechanism and the specific cutting force increase. Thepsonthi et al.⁸ proposed a 3D FE model to simulate full-immersion milling on Ti-6Al-4V titanium alloy. The model was utilized to study the influence of increasing tool edge radius due to wear on the process performance. Cutting forces, cutting temperature, chip flow, and burr formation were strongly affected by the tool wear. Attanasio et al.⁹ investigated the tool run-out effects on thin-wall milling and included them in a 3D FE model. The process quality alteration due to tool run-out phenomenon was evidenced from the experiment and

the simulation. Control and optimization of milling machine performance are crucial to achieve adequate micromachining processes. In this context, high productivity and elevated cutting speed are ensured by high spindle rotational speed. Tool run-out and vibration intensity are affected by cutting dynamics. Shi et al.¹⁰ investigated the influence of milling machine structure on micromilling in terms of roughness. The analysis was performed to identify the natural frequencies of the machine tool and compare them with tooth passing frequency. The effects of the spindle high-speed must be considered in engineering of a cutting force acquisition system. As discussed in Ref.,¹¹ a limited load cell bandwidth can distort the measured signals. If harmonic vibration overlaps the natural frequency of the instrument, then the measured cutting force would be amplified. Despite relevant research efforts over the last years, a standard for testing micromilling performance remains lacking. Garbellini et al.¹² pointed out that although several standards and guidelines have been defined for macroscale machining, they appear inadequate to be downscaled unless appropriate adjustments are made. In the following sections, an assessment procedure for evaluating the performance of a micromilling process is proposed. First, the dynamic performance of the load measurement system was determined through an experimental modal analysis. A similar procedure was employed to compute the relevant natural vibration frequencies of the milling machine. Once the acquired cutting forces were considered reliable, the signal was utilized as a quality index. The surface quality was also found to be suitable for evaluating the instrument and process performance of a milling machine when micromilling features were realized. An experiment was conducted to test the procedure on a nano-precision milling machine.

^{*} Corresponding author.

E-mail addresses: a.abeni004@unibs.it (A. Abeni), matteo.lancini@unibs.it (M. Lancini), aldo.attanasio@unibs.it (A. Attanasio).

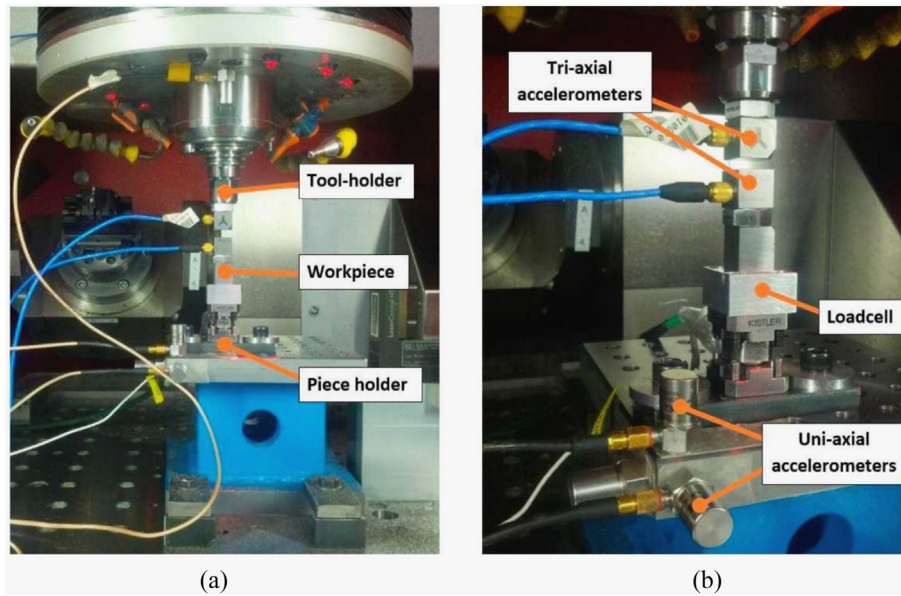

Fig. 1. Test setup: (a) workspace area with the tool holder and the piece holder; and (b) the load cell and the piezo-accelerometers.

2. Assessment procedure for micromilling machine performance

The proposed procedure provides appropriate information for setting micromilling tests to estimate the performance of a microcutting process. This section describes the features of the milling machine, tool holder, tool, force measurement apparatus, and workpiece and the process parameters.

The output to be considered as a process quality index is also defined.

2.1. Equipment definition

The guidelines were developed specifically for ultra-precision milling machine but can also be applied to conventional milling machine and custom-built milling machine. The tool must be a microend mill characterized by a diameter lower than 1 mm. Tool run-out should be limited using a chuck tool holder with precision collets instead of other types of holder.

In addition to the standard milling machine equipment, the assessment procedure requires a data acquisition system for forces. The cutting forces are indispensable data to understand the cutting dynamics and estimate tool run-out. Developing a reliable measurement system is challenging due to several issues. The load cell must have an accuracy of at least 0.01 N. The load cell sampling rate must be chosen as the best possible trade-off between acceptable file size and acquisition quality. Aliasing must be avoided by setting sufficiently high sampling rate.

The positioning of the sensor is certainly not insignificant. Smith et al.¹³ developed a torque measurement system built onto a milling machine. The rotating systems increase the inertia of the measurement system and have a limited frequency bandwidth that is dependent on each tool holder used. A similar condition could distort force signals and must be absolutely avoided. Table dynamometers are commonly used to measure milling forces. In this configuration, the workpiece is mounted on the top of the dynamometer, which is clamped to a milling machine table.¹⁴

Some piezo-accelerometers are necessary to complete the machine modal analysis. The standard identified pattern is shown in Fig. 1(a). A

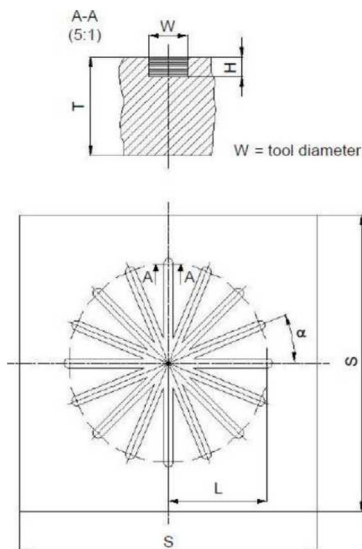

Fig. 2. Proposed feature: (a) 2D view and (b) 3D view.

Table 1
Study case description.

Milling machine	Kern Pyramid Nano©
Load cell	Kistler© 9317C
Triaxial piezo-accelerometers	356A15 PCB© fixed by Dytran® high-strength magnetic fixture
Monoaxial piezo-accelerometers	736 Wilcoxon©
Impact hammer	086c03 PCB©
Tool	Mitsubishi© two-flutes end-mill
Tool diameter (nominal)	200 μm
Sample material	Ti-6Al-4V alloy with fully lamellar microstructure

triaxial piezo-accelerometer must be placed on the tool holder by using a suitable and high-strength fixture (Fig. 1(b)). Another triaxial accelerometer must be placed on the top of steel block simulating the piece to be held, positioned on the force sensor, and fixed on the piece holder. A third accelerometer must be placed on the machine frame. To provide redundant data should be useful to minimize mode measurement errors. This condition could be obtained with six additional uniaxial accelerometers; three accelerometers should be fixed to the piece holder in orthogonal configuration and the other three should be fixed on the machine frame by using thin adhesive tape in orthogonal configuration.

The accelerometers and the load cells are all connected to a data acquisition device, which is an integrated system for signal conditioning and analogic-to-digital conversion. The natural vibration frequencies of the system should be determined through several techniques. A modal analysis must be performed on the micro milling machine and the load cell. An impact hammer is also required to conduct the test.

2.2. Assessment steps

The machine must be tested after a warm-up phase and characterized through experimental modal analysis to identify frequencies of mode shapes involving vibrations of the load cell, the tool, and the piece holder. A specific micromilling operation is then executed on appropriate workpiece samples.

The first phase consists of identifying the modal parameters of the load cell. The natural frequency of the sensor is declared and certified by the manufacturer. Nevertheless, characterization must be performed due to the influence of constraints on the dynamic behavior of the sensor. Detection can be obtained through impact tests and measurement of output forces in each direction. First, only the load cell, without the workpiece and brackets, must be hit to validate the procedure. The identified natural frequencies can be compared with the value declared by the manufacturer.

Once the procedure can be considered reliable, the entire system comprising a dynamometer fixed on the machining center, workpiece, and brackets must be tested with the same methodology (Fig. 1(a)). The frequency response of the force sensing system is influenced by

the stiffness and the mass of each component. The constraints decrease the dominant mode and bandwidth.

The force measurement system can be considered reliable if the bandwidth remains larger than the maximum tooth passing frequency.

A maximum spindle rotational speed n_{MAX} can be identified using Eq. (1):

$$n_{MAX} = \frac{f_n \cdot 60}{z} \text{ [RPM]} \quad (1)$$

where f_n is the natural frequency [Hz], and z is the number of tool flutes.

Once the force signals should be considered reliable, machine dynamics will be characterized. The mechanical structure¹⁵ and the control system of the milling machine¹⁶ are usually optimized during the design phase and validated experimentally to reduce the influence of vibrations during milling on the final product. The techniques used for validation mainly focus on vibrations affecting the tool due to their relevance to the process. As suggested by Altintas et al.,¹⁷ such vibrations could be predicted through numerical simulation of the machine body up to the tool holder and coupled with an experimental modal analysis of the tool performed independently from the machine itself.

Numerical simulation would require a complete solid model of the machine, and material properties to be assigned to its elements: the actual results of the simulation would largely depend on the accuracy of these data. A complete experimental solution in which the tool is tested directly in its working configuration is preferred to provide a simpler approach to validation.

Considering that the dimensions of the tools used for micromachining are comparable with those of most accelerometers and the high-speed rotation of the spindle, Gagnol et al.¹⁸ suggested using laser distance sensors or laser Doppler vibrometry.

Zaghbani et al.¹⁹ proposed an easier approach of applying contact sensors to the nonrotating parts of the machine combined with operational modal analysis.

Given that this study aims to propose a standard procedure for evaluating machine performance and not to simulate and optimize dynamic behavior. The procedure was also simplified, focusing on the identification of natural frequencies only and neglecting damping and modal mass estimation.

An impact hammer was used to hit the piece holder.

The frequency response function (FRF) of each acceleration signal must be computed to detect the natural frequencies of vibrations involved in the tool holder and piece holder with the force signal of the impact hammer as reference.

The most relevant peaks can be identified by picking. This technique is prone to operator-induced errors; as such, the procedure should be repeated several times to further confirm the selection, and each result must be compared with one another using the Modal Assurance

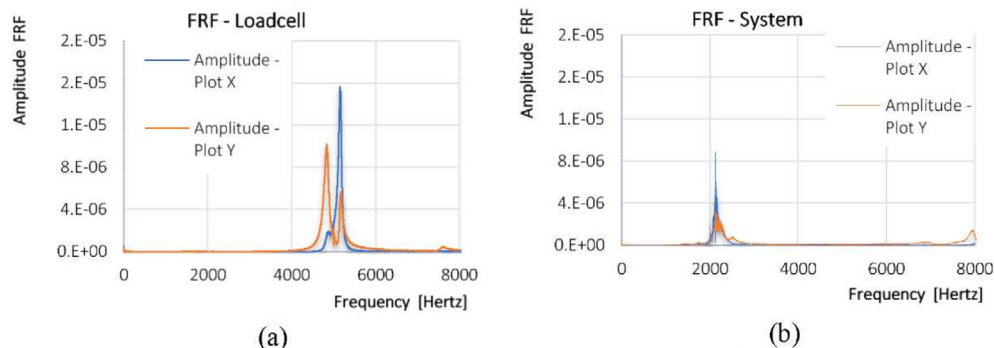

Fig. 3. FRF (units in 1/kg) analysis of natural frequency test on (a) a load cell and (b) the entire system.

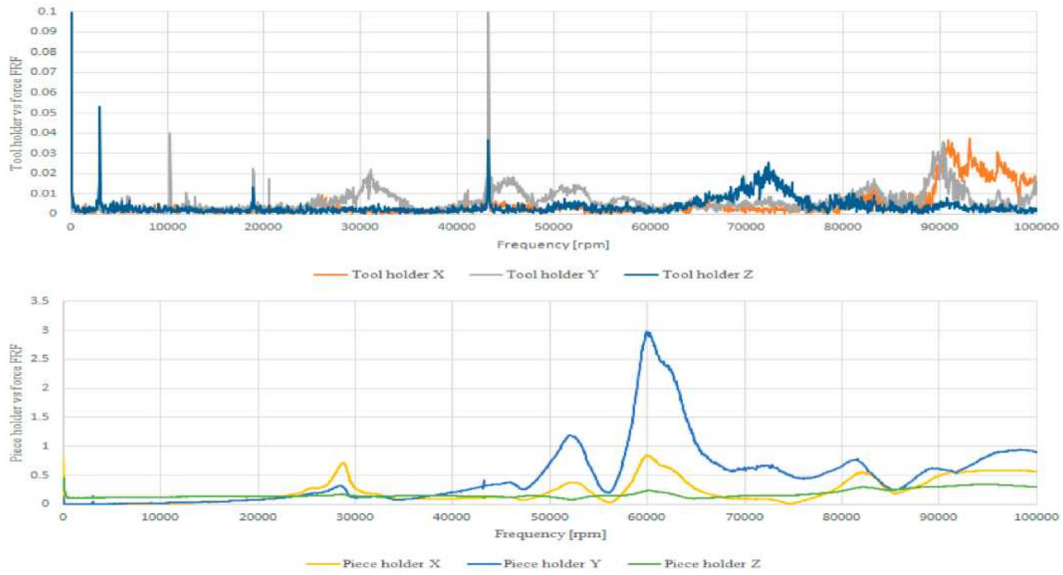

Fig. 4. FRFs of vibrations on the tool holder (upper) and piece holder (lower) recorded during an impact hammer hit on the piece holder.

Criterion (MAC) matrix²⁰ considering only the frequencies identified by the majority of the tests.

Finally, a cutting test must be performed to verify machine performance in terms of final product quality. This procedure suggests realizing a 2D feature, which is directly machined on the top flat surface of a slab workpiece.

Micromilling is applied to realize components with tiny features, such as microfluidic systems or fuel cells; in this regard, the geometry is designed as multiple microslots. In particular, the feature is composed of 16 microslots, performed on 360°.

The cut is realized by moving the tool from the surface center of the sample in the radial direction (Fig. 2). The shape is easy to produce, and performing measurements can be effortless.

The length (*L*) of the feature should be 10 times greater than the tool diameter. The depth of the channels (*H*) should be standardized by setting its value equal to the tool radius and obtained through 10 constant passes (i.e., $ap = 1/10H$).

The minimum dimensions of the sample are set as follows to avoid undesired boundary effects:

- minimum side length $S = 3 \times L$;
- minimum sample thickness $T = 10 \times \text{tool diameter}$ or $T > 5 \text{ mm}$.

Process parameters (cutting speed v_c , axial depth of cut ap , and feed per tooth) must be chosen according to the tool maker guidelines to avoid ploughing regime during cutting.

During microslotting, cutting forces must be measured through a tri-axial force sensor for analysis of force peak values.

The measured force components should be composed through Eq. (2) for calculating cutting force F_c acting on the tool cutting edges.

$$F_c = \sqrt{F_x^2 + F_y^2 + F_z^2} \tag{2}$$

In the microscale, tool run-out strongly affects the process, and force on the two cutting edges should be separately investigated to highlight the presence of this phenomenon. General surface integrity and burr dimensions must be measured on the inner and outer sides of the microchannels. Dimensions, burr dimensions, and cutting force peaks (for each cutting edge of the tool) related to microchannels must be

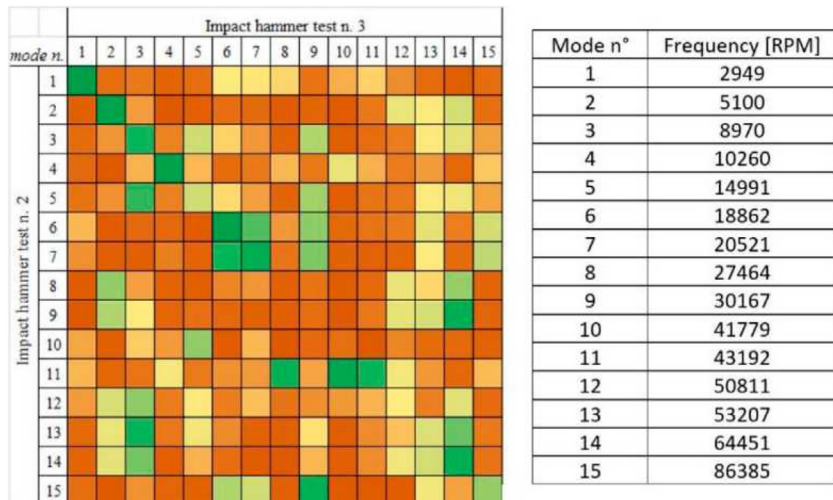

Fig. 5. MAC matrix between two repetitions.

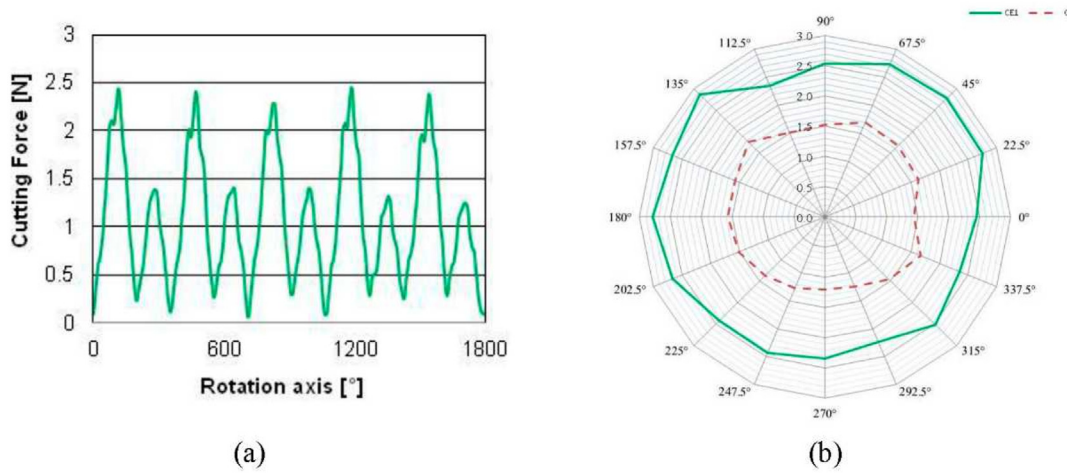

Fig. 6. Actual cutting force (a) on 5 mill-rounds with tool run-out effect (b) versus milling direction.

plotted in a Kiviati chart to show a possible relation with milling direction.

3. Experimental validation

An experimental case was implemented to test the described procedure through analysis of milling machine performance. The general overview of the milling machine type and the involved equipment is summarized in Table 1.

3.1. Load cell bandwidth analysis

The natural frequency of the load cell declared by the manufacturer for the x and y directions is equal to 5000 Hz. The sensor was hit three times by the impact hammer, and load data were acquired through a National Instrument cDAQ-9174 with National Instrument 9215 board (BNC type). The sampling frequency was set to 50 kHz. In Fig. 3(a), the FRF shows a peak around the natural frequency of the load cell. The effective natural frequency was identified as 5156 Hz for F_x and 4991 Hz for F_y , consistent with the declared data. The entire system (dynamometer fixed on machining center, workpiece and brackets) was then tested with the same methodology. A smaller bandwidth is the result of the dominant mode decrease at 2145 Hz for F_x and 2192 Hz for F_y . Fig. 3(b) shows the decrease in the bandwidth.

The maximum spindle speed n_{max} for two-flute tool determined by Eq. (1) is 64,350 RPM, which is higher than the maximum spindle speed of the milling machine (i.e., 50,000 RPM).

3.2. Dynamic characterization of milling machine

After a warm-up phase, the milling machine was excited using an impact hammer applied manually to the piece holder. Force sensor and accelerometers were synchronously used for recording. The FRF of each acceleration signal was computed using the force signal of the impact hammer as reference to detect the natural frequencies of vibrations involving the tool holder and the piece holder. FRF was estimated using the H3 FRF mode available in Labview©.

The results of the analysis are presented in Fig. 4, where only a subset of the recorded quantities is shown to improve clarity. The force applied is limited to avoid damage to the piece holder, and vibration transmission between the two elements is low, leading to low amplitude of the tool holder response signals. A cross examination hitting the tool holder instead of the workpiece holder was not performed to avoid damage to the machine.

All frequencies are reported in their revolutions per minute (rpm) equivalents to simplify data interpretation. Both charts display resonance peaks in frequency ranges, and the peaks could be excited during vibration; in particular, the ranges around 43,000, 53,000, 83,000, and 90,000 rpm show peaks in both charts.

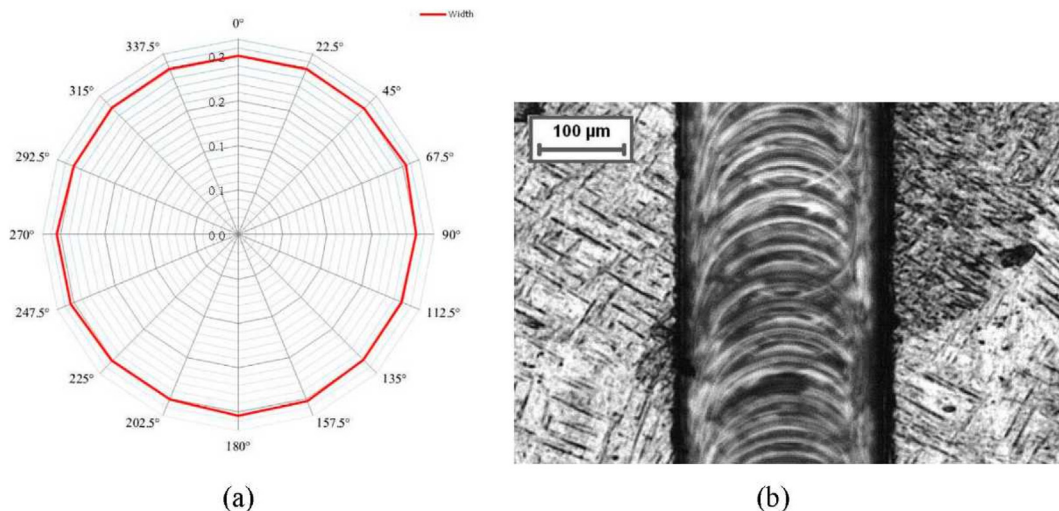

Fig. 7. (a) Milling direction versus microchannel width (b) burrs on performed feature.

As stated previously, the peak-picking identification of the resonant frequencies was confirmed by repeating the tests five times and by using the MAC matrix to compare the results with only the frequencies detected by the majority of the tests. An example of comparison is shown in Fig. 5. A good correlation between the two tests can be assessed based on the matrix diagonal up to the seventh frequency identified, whereas the 8th, 9th, and 10th frequencies show an incorrect identification. All other comparisons led to similar results. This procedure is necessary because of the following: peak picking is operator dependent; and the excitation force used is limited compared with the size of the machine structure, making the result sensitive to ambient vibrations unrelated to the test performed. Given these considerations, the frequency ranges that could induce higher vibrations if excited, being present in all the FRF analysis performed, should be from 40,000 rpm to 50,000 rpm and from 90,000 rpm to 100,000 rpm.

3.3. Micromilling test

The third procedure was performed by cutting the 2D feature described in Section 2.2. Process parameters were chosen according to the tool datasheet and previous modal analysis to stress the machine around its previously determined natural frequency. The feed rate was set to 1170 mm/min and the spindle speed to 45,000 rpm. The selected spindle speed generates forces with frequency components within the range of the frequencies of the measured vibrations modes.

As indicated in Table 1, the nominal tool diameter is 200 μm . The channel depth (H), which is equal to the tool diameter, was obtained through 10 constant passes with a depth of cut of 20 μm each one.

During micromilling, cutting force was acquired through the load cell. Fig. 6(a) shows a cutting force chart, indicating how the process is affected by the tool run-out and determining unbalanced loads on the cutting edges. The same behavior was observed for each step and for each channel (Fig. 6(b)). The Kiviat graph shows how the feed direction does not significantly affect the cutting force. Even if close to the natural frequencies of the system, the cutting speed does not influence the process stability. In fact, no relevant vibrations were found from the force signal (Fig. 6(a)).

Fig. 7(a) presents the Kiviat chart of the width of the microchannels. Width is quite constant along every direction. The measured average width is equal to $202 \pm 2 \mu\text{m}$. Given that the actual tool diameter is equal to 189 μm , the presence of tool run-out effect, which increases the actual width of the channels, could be confirmed.

Constant burrs were observed for each microchannel, regardless of the milling direction. Typical burrs (Fig. 7(b)) are wider on the outer side. Burr dimension was measured by using an optical coordinate measuring machine made by Mitutoyo (Quick Scope QS200Z). The average value is equal to 16 μm .

4. Conclusions

This paper reports guidelines for a standard testing procedure used to verify the performance of a micromilling system (i.e., milling machine, tool, tool holder, material, and process parameters). The proposed feature was realized through consecutive passes. Cutting force, channel geometry, and burr dimensions were considered as the main outputs.

The procedure was tested and validated on an Ultra-precision CNC Machining Center (Kern Pyramid Nano). A Ti-6Al-4V alloy sample was

utilized during the milling test. A 200 μm diameter two-flute flat end-mill was used during the test, and the process parameters were chosen according to previous modal analysis of the milling machine with the tool datasheet.

The milling machine structure and its equipment can be considered adequate for micromilling. The installed load measurement system is suitable for standard micromachining application. Good results in terms of vibrations were observed from the force signal even if the test was run with cutting speed that matched with the resonance frequency. The cutting force is independent from the working direction. Force analysis and channel width measurements revealed the presence of tool run-out during the test. In general, limited burr dimensions were observed, confirming the good quality of the final feature. The procedure can be considered reliable and suitable for checking the status of a milling machine and related measurement system. Possible machine issues can be identified and corrected. Furthermore, the test allows the identification of the best range of spindle speed to limit machine vibration and load cell resonance. The final goal is the workpiece final quality improvement.

References

- Dornfeld D, Mina S, Takeuchi Y. Recent advances in mechanical micromachining. *CIRP Annals Manufacturing Technology* 2006;55(2):745-68.
- Altintas Y, Jin X. Mechanics of micro-milling with round edge tools. *CIRP Annals Manufacturing Technology* 2011;60(1):77-80.
- Attanasio A. Tool run-out measurement in micro milling. *Micromachines* 2017;8(7):221.
- Park SS, Malekian M. Mechanistic modelling and accurate measurement of micro end milling forces. *CIRP Annals Manufacturing Technology* 2009;58(1):49-52.
- Masuzawa T. State of the art of micromachining. *CIRP Annals Manufacturing Technology* 2000;49(2):473-88.
- Dhanorker A, Ozel T. Meso/micro scale milling for micro-manufacturing. *International Journal of Mechatronics and Manufacturing Systems* 2008;1(1):23-42.
- Camara MA, Campos Rubio JC, Abrao AM, et al. State of the art on micro milling of materials, a review. *Journal of Materials Science & Technology* 2012;28(8):673-85.
- Thepsonthi T, Ozel T. 3-D finite element process simulation of micro-end milling Ti-6Al-4V titanium alloy: experimental validations on chip flow and tool wear. *J Mater Process Technol* 2015;221:128-45.
- Attanasio A, Abeni A, Ozel T, et al. Finite element simulation of high speed micro milling in the presence of tool run-out with experimental validations. *Int J Adv Manuf Technol* 2019;100(1-4):25-35.
- Shi Y, Von Wagner U, Mahr F, et al. Influence of the machine structure on micro milling process. *PAMM* 2009;9(1):701-2.
- Park SS, Malekian M. Mechanistic modeling and accurate measurement of micro end milling forces. *CIRP Annals Manufacturing Technology* 2009;58(1):49-52.
- Garbellini A, Lancini M, Attanasio A, et al. Testing procedure for evaluating the performance of a micro-milling process. *Proceedings of the 8th International Conference on Leading Edge Manufacturing in 21st Century*. LEM; 2015.
- Smith DA, Smith S, Tlustý J. High performance milling torque sensor. *ASME Journal of Manufacturing Science* 1998;120(3):504-10.
- Park SS, Altintas Y. Dynamic compensation of spindle integrated force sensors with Kalman filter. *J Dyn Sys, Meas, Control* 2004;126(3):443-52.
- Lee SW, Mayor R, Ni J. Dynamic analysis of a mesoscale machine tool. *J Manuf Sci Eng* 2006;128(1):194-203.
- Kalinski KJ, Galewski MA. Chatter vibration surveillance by the optimal-linear spindle speed control. *Mech Syst Signal Process* 2011;25(1):369-383.
- Ozasahin O, Altintas Y. Prediction of frequency response function (FRF) of asymmetric tools from the analytical coupling of spindle and beam models of holder and tool. *Int J Machine Tools & Manufacture* 2005;92:31-40.
- Gagnol V, Le T, Ray P. Modal identification of spindle-tool unit in high-speed machining. *Mech Syst Sig Proc* 2011;25(7):2388-98.
- Zaghibani I, Songmene V. Estimation of machine-tool dynamic parameters during machining operation through operational modal analysis. *Int J Mach Tools & Manuf* 2009;49(12-13):947-57.
- Fotsch D, Ewins DJ. Application of MAC in the frequency domain. *Proceedings of the International Modal Analysis Conference, Vol. 2.* ; 2000. p. 1225-31.