



Contents lists available at ScienceDirect

Journal of Rock Mechanics and Geotechnical Engineering

journal homepage: www.rockgeotech.org

Full length article

Brillouin optical time-domain analysis for geotechnical monitoring



L. Zeni^{a,b,*}, L. Picarelli^c, B. Avolio^c, A. Coscetta^a, R. Papa^c, G. Zeni^b, C. Di Maio^d,
R. Vassallo^d, A. Minardo^a

^a *DIII, Second University of Naples, Aversa, Italy*^b *Institute for Electromagnetic Sensing of the Environment (IREA), National Research Council, Napoli, Italy*^c *DICDEA, Second University of Naples, Aversa, Italy*^d *School of Engineering, University of Basilicata, Potenza, Italy*

ARTICLE INFO

Article history:

Received 30 November 2014

Received in revised form

8 January 2015

Accepted 26 January 2015

Available online 9 May 2015

Keywords:

Brillouin optical time-domain analysis (BOTDA)

Tunnel engineering

Deformation

Distributed monitoring

Health diagnosis

ABSTRACT

In this paper, we show some recent experimental applications of Brillouin optical time-domain analysis (BOTDA) based sensors for geotechnical monitoring. In particular, how these sensors can be applied to detecting early movements of soil slopes by the direct embedding of suitable fiber cables in the ground is presented. Furthermore, the same technology can be used to realize innovative inclinometers, as well as smart foundation anchors.

© 2015 Institute of Rock and Soil Mechanics, Chinese Academy of Sciences. Production and hosting by Elsevier B.V. All rights reserved.

1. Introduction

Distributed fiber-optic strain sensors have great potentialities in the field of geotechnical monitoring (Dewynter et al., 2009; Olivares et al., 2009; Iten, 2011; Minardo et al., 2014). By integrating a single fiber-optic cable into soil or a geotechnical work, a large number of accurate, spatially resolved data can be obtained. The Brillouin optical time-domain analysis (BOTDA) method allows for strain measurements in the microstrain range, with a typical spatial resolution of 1 m and a maximum sensing range of 50 km. This means that thousands of “strain gauges” along a single cable connected to structures, embedded in soil or grouted into boreholes, for example, can provide information about the current state of the object under supervision. The objects can include geological and civil structures, such as a construction site, a tunnel, a landslide prone area, or a pipeline. It is evident that such a technology implies a benefit for placing fiber-optic cables anywhere possible on construction sites and in the green field (Minardo et al., 2012).

This paper summarizes some results of experiments carried out by research staff at Second University of Naples. In particular, after a

brief description of the sensor technology, three applications of the BOTDA technology in the geotechnical field will be described: (a) slope monitoring by optical fibers embedded into the soil; (b) detection of soil movement by use of an optical fiber based inclinometer; (c) monitoring of a ground anchor by use of an embedded optical fiber.

2. Principle of operation of BOTDA

The experimental results reported in this paper have been conducted exploiting stimulated Brillouin scattering (Boyd, 2008) in single-mode optical fibers. In brief, two counter-propagating light-waves exchange energy along the fiber, in a measure depending on their frequency offset. If the offset falls within a specific range, the radiation at higher frequency (pump wave) transfers energy to that at lower frequency (Stokes wave). The sensing principle is based on the fact that the frequency difference at which the maximum amplification of the Stokes wave occurs, known as Brillouin frequency shift (BFS), varies depending on the mechanical and thermal states of the fiber. In particular, the BFS increases with both temperature and strain. Spatial resolution, i.e. the ability to measure deformation and temperature changes in a distributed way, can be achieved through the use of a pulsed pump beam: in this way, the interaction takes place along successive sections of the fiber as the pump pulse propagates down the sensing cable. By recording the intensity of the Stokes radiation as a function of time, the Brillouin gain can be traced in each section. The measurement of the Brillouin gain as a function of time and frequency allows the entire profile of

* Corresponding author. Tel.: +39 0815010269.

E-mail address: luigi.zeni@unina2.it (L. Zeni).

Peer review under responsibility of Institute of Rock and Soil Mechanics, Chinese Academy of Sciences.

1674-7755 © 2015 Institute of Rock and Soil Mechanics, Chinese Academy of Sciences. Production and hosting by Elsevier B.V. All rights reserved.

<http://dx.doi.org/10.1016/j.jrmge.2015.01.008>

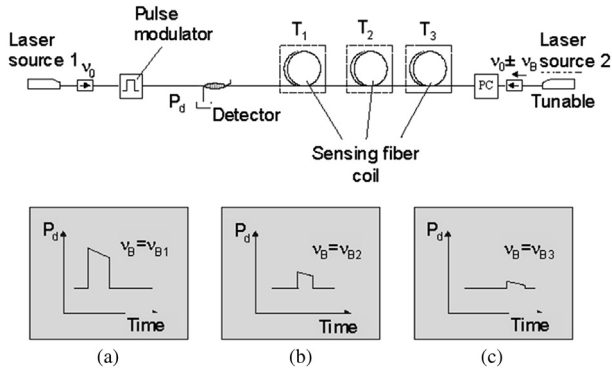

Fig. 1. Basic configuration for BOTDA: (a), (b) and (c) show the waveform of optical power at detector (P_d), acquired when the frequency offset between the two lasers is tuned to the Brillouin frequency shift ν_B of fiber coils 1, 2 and 3, placed at temperatures T_1 , T_2 and T_3 , respectively.

Brillouin shift along the fiber to be obtained, which in turn can be translated in terms of deformation or temperature through the use of appropriate calibration coefficients.

Fig. 1 shows the basic configuration employed for BOTDA. The pulsed and continuous wave (CW) beams are generated by two separated sources having lasing frequencies ν_0 and $\nu_0 \pm \nu_B$, shifted by a definite quantity in the range of the Brillouin frequency shift of the sensing fiber. Fig. 1 shows that the amplification of the Stokes beam occurs at those locations where the frequency offset with the crossing pulse matches the local Brillouin frequency shift, which in turn is related to the temperature (or strain) of the analyzed fiber coil. More in general, Brillouin time-domain signals are acquired in BOTDA systems for a range of frequency offsets, so as to get a full picture of the Brillouin frequency shift at each location.

3. Experiments on small-scale model slopes

The main requirements of monitoring systems in areas susceptible to sudden and rapid landslides should be the following: (a) a cheap and reliable instrumentation; (b) continuous monitoring in

time and space; (c) low probability of error to avoid false or missed alarms.

For their ability to measure strain with spatial continuity, optical fibers are particularly attractive. For this reason, we decided to check their performance in the monitoring of slopes in loose unsaturated granular soils susceptible to catastrophic rainfall-induced flowslides. The basic idea is that a sensing fiber buried in the soil can detect the deformation due to ongoing volumetric and/or shear strains induced by the decrease in suction, which can be interpreted as a warning of incoming failure. The capability of the fiber to provide distributed strain readings should allow to detect ongoing deformation at any point of even very long slope sections. This is a fundamental advantage with respect to conventional monitoring devices (topographic readings, inclinometers, etc.) which can provide information only at specific points. The low cost of fibers is another relevant advantage.

This simple idea suggested an experimental program to test this new kind of sensors in small-scale model slopes subjected to artificial rainfall. The slopes are made of volcanic ash laid down into a flume imposing the same porosity as in the field. The water infiltration induced by artificial rain causes an increase in the water content and a decrease in suction and, consequently, volumetric and shear strains; this mechanical process can lead to slope failure. The basic equipment for monitoring includes tensiometers, pore pressure transducers, laser displacement transducers, electrical moisture probes (TDRs) and video-cameras (see Fig. 2). For the present application the flume was tilted with an inclination of 40° , and equipped with tensiometers, displacement sensors and optical fibers. The latter was a tight-buffer standard single-mode fiber for telecommunications having an overall diameter of $900 \mu\text{m}$. The optical fiber sensor was buried into the ground along two alignments parallel to each other (Fig. 2). The model slopes, as a proof of principle, have been made up with volcanic ashes taken from the site of Cervinara, Italy, where field monitoring is being carried out (Pirone et al., 2012). The slope has a length of 1.35 m, thickness of 10 cm, initial water content ranging between 43% and 50%, and porosity close to the field value (70%–76%).

In the experiment, a system of anchoring constituted by small plastic grids glued every 20 cm at the fiber was adopted, as shown

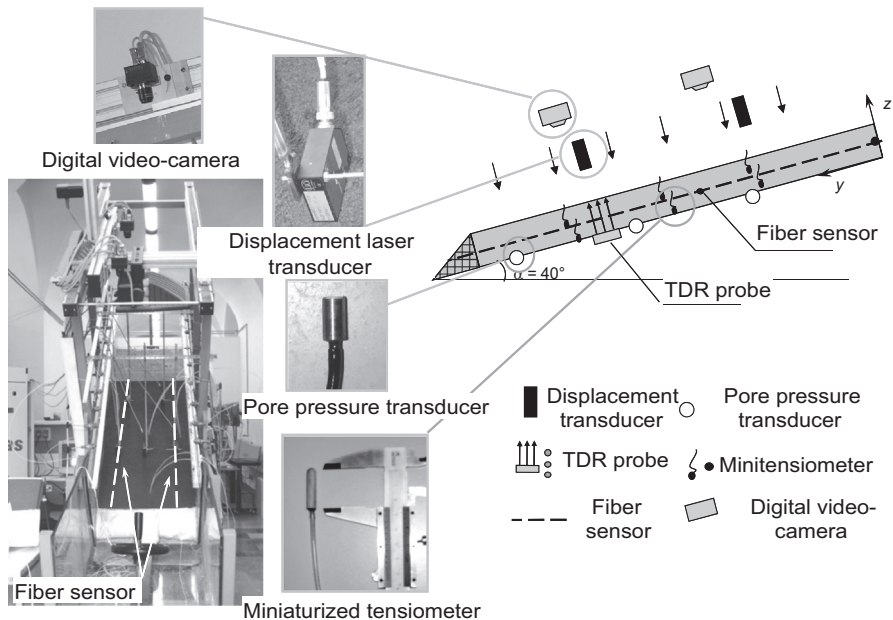

Fig. 2. The instrumented flume.

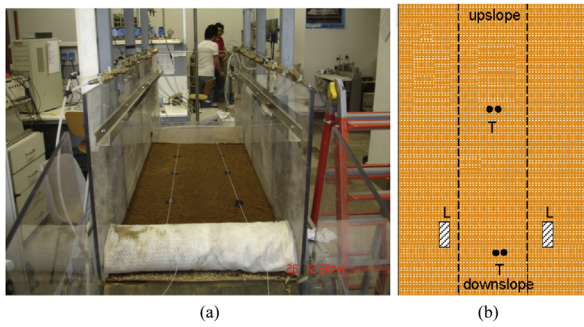

Fig. 3. (a) Sensing fiber anchored to the soil deposit. (b) Position of the tensiometers (T) and displacement sensors (L).

in Fig. 3a. Fig. 3b shows the position of the tensiometers and of the laser displacement sensors.

The readings of the optical fiber sensor are reported in Fig. 4. The increase in Brillouin frequency shift from the initial profile ($t = 0$), which reveals a state of stress due to accumulated strains during a first test stage not reported here, to the latest one ($t = 47$ min), is about 200 MHz. This corresponds to a deformation of about 0.4%. The collapse of the slope occurs after 50 min. Readings recorded after failure ($t > t_f$) show that the Brillouin frequency shift returns to its initial value.

For the sake of comparison, the readings of the tensiometers and displacement sensors are reported in Figs. 5a and b, respectively. As it can be seen from Fig. 5, the soil is completely saturated at surface before any settlement begins, while the saturation of the deep layer is complete only when a vertical displacement of the soil of a few millimeters is recorded. On the other hand, the optical fiber sensors, being deployed in order to detect the soil sliding, start measuring a significant tensile strain when the early signs of the slope sliding occur.

4. Optical fiber inclinometer

An inclinometer based on BOTDA has been devised and realized. Its main characteristics can be summarized as follows: (a) measurement of three-dimensional (3D) deformation of soil; (b) continuous monitoring from a remote site and multiplexing capability; (c) self-compensation against temperature variations; (d) displacement sensitivity as high as 1 mm over 1 m; (e) safe operation up to overall displacements as large as 15 cm over 1 m, the limit being posed just by the breaking of the sensing optical fiber.

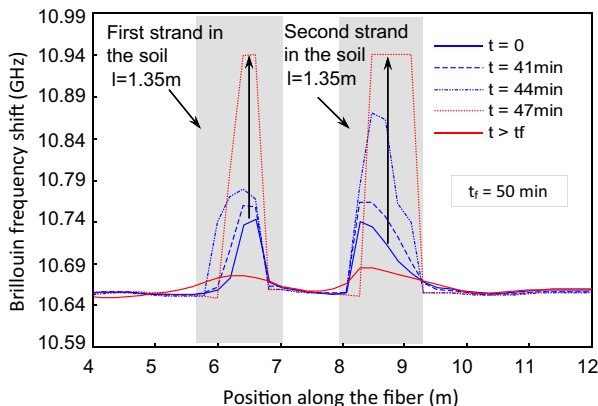

Fig. 4. Temporal sequences of the Brillouin shift along the fiber.

It should be emphasized that the above characteristics are not fulfilled by traditional inclinometers which usually require periodic inspections for interrogation, and become useless if the displacement reaches values as large as to prevent the sliding of the measuring head along the inclinometer tube itself (a few centimeters of movement across a narrow slip plane).

The optical fiber inclinometer is realized by epoxy-gluing four equally spaced fibers along the surface of a PVC pipe for its entire length, as shown in Fig. 6.

The pipe is 50 mm in diameter, and 3.2 mm in thickness, while its overall length is 750 cm, achieved by connecting three pipe sections of 250 cm. The measurement of the strain profiles along the fibers allows the reconstruction of the 3D deformation of the pipe and, consequently, the movements of the soil where the pipe is embedded (Lenke et al., 2011).

In order to assess the validity of the proposed approach, several laboratory tests were performed on the inclinometer tube before on-site installation. Fig. 7a shows the selection of the results achieved during the laboratory tests. In detail, we show the vertical displacement along a 180 cm-long pipe, with identical cross-section of the pipe used on-site, subjected to prescribed displacement at one end and fixed on the other end. The displacements retrieved by the optical fiber sensor using a Brillouin shift sensitivity to strain of 417 MHz/% and a spatial resolution of 20 cm, are compared to the ones provided by eight dial gauges distributed along the pipe. It is seen that the agreement is remarkably good. In particular, the maximum deviation between the dial gauge and optical fiber displacement was about 4 mm, while the standard deviation of the measurement error was about 1 mm. Note that the observed discrepancy is coherent with an error analysis of the displacement. In fact, assuming a strain uncertainty $\sigma_\epsilon = 100 \mu\epsilon$, we can calculate the standard deviation of the displacement simply by

$$\sigma_v = \frac{\sqrt{1/3 \Delta z \sigma_\epsilon^2 L^3}}{D} \approx 1.2 \text{ mm}$$

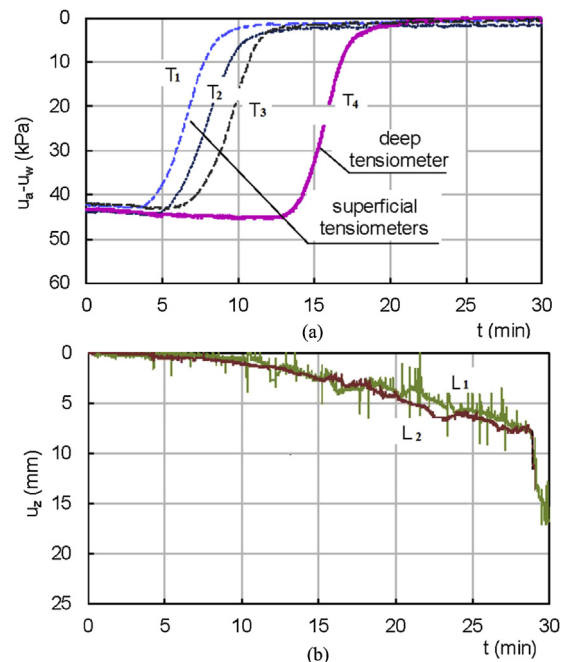

Fig. 5. (a) Suction $u_a - u_w$, where u_a and u_w are the air pressure and the pore water pressure, respectively. (b) Vertical displacement u_z .

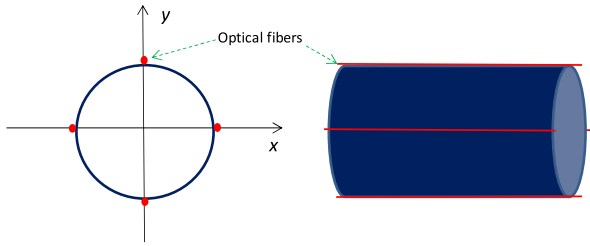

Fig. 6. The optical fiber inclinometer tube.

where L and D represent the pipe length and diameter, respectively; Δz is the spatial resolution. This equation shows that the variance of displacement grows with the pipe length, thus the proposed method may suffer from inaccuracies for relatively long pipes.

In regard to on-site measurement results, the selected test site was an area, located in Basilicata Region, Italy, subjected to slow soil movements and already instrumented with traditional inclinometer tubes. The test site is depicted in Fig. 8, where the positions of the traditional inclinometers and the fiber optic one are shown, as well.

The optical fiber inclinometer was installed in a 750 cm deep borehole which was then filled with grout. After allowing the grout cure for one month, a first measurement was performed as a reference in order to eliminate all the strain induced by the installation procedure.

The subsequent measurements allow the detection of any soil movements. Fig. 9 shows the obtained results. Despite its limited length, the fiber optical inclinometer exhibits a sufficient accuracy in detecting the maximum pipe displacement at the ground surface.

5. A “smart” foundation anchor

For this experiment, a smart foundation anchor was devised and realized. The main objective of this activity was to improve the understanding of the anchor’s load bearing behavior, as the performance of the anchor is limited by the efficiency of load transfer from the anchor tendon to the soil via the grout (Iten, 2011).

In brief, the anchor was equipped with an optical fiber epoxy-glued inside the steel tendon. The optical fiber was disposed in a loop configuration so as to have both ends available for BOTDA

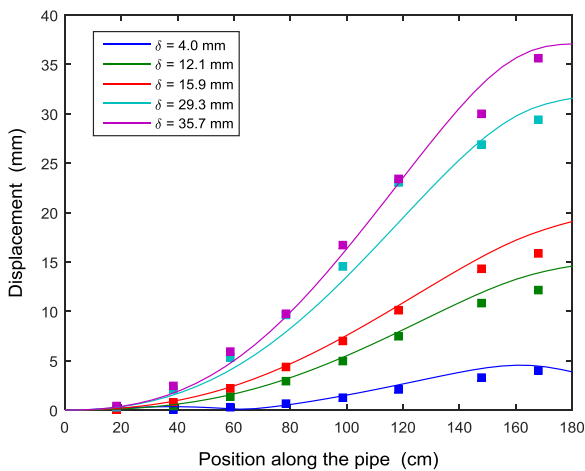

Fig. 7. Comparison between the displacements provided by the optical fiber sensor (solid lines) and the ones provided by the dial gauges (squares). δ represents the maximum displacement applied at the free end.



Fig. 8. Test site in Basilicata Region, Italy. S9F: fiber optic inclinometer; I9B, I9C: traditional inclinometers.

distributed strain measurements. A special optical fiber cable with 3.2 mm outer diameter, produced by Brugg Kabel AG, was selected for the tests (V1 cable).

After realization, the anchor was field-installed in Campania Region, Italy. Distributed strain measurements were taken at each loading step. The results are summarized in Figs. 10 and 11. Note that the symmetrical appearance of the various strain profiles is due to the fact that the same fiber was running twice along the cable. We observe a number of significant features: (a) the strain decreases linearly from the ground level, vanishing at the deepest end of the cable: this means that the whole cable length is involved in transferring the pullout force into the soil; (b) at larger displacement steps, the strain profile propagates behind the fixation point due to slippage of the glass fiber inside the protection; (c) comparing Figs. 10 and 11, it is seen that there is a significant residual strain along the fiber at the end of the pullout test: for example, during the unloading phase a load of 100 kN produces a maximum strain of about 1000 $\mu\epsilon$, equivalent to the strain observed during the loading phase for a load of 350 kN.

6. Conclusions

Different applications of BOTDA based optical fiber distributed sensors to geotechnical monitoring have been reported. Laboratory

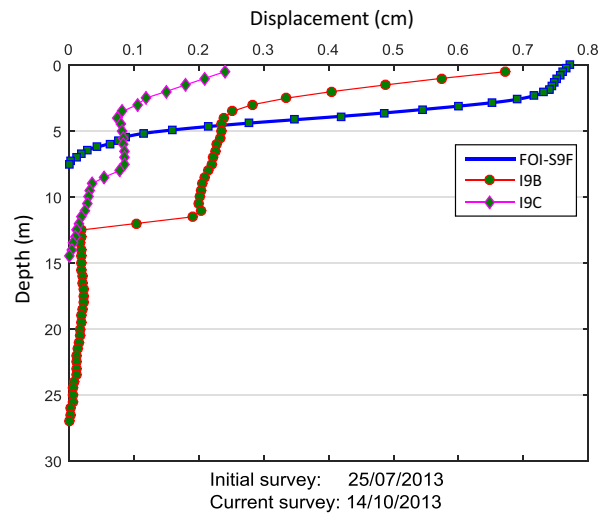

Fig. 9. Displacement of the optical fiber inclinometer (FOI-S9F) as a function of depth, and comparison with the readings of two traditional inclinometers: the I9B (depth: 27 m) and the I9C (depth: 15 m) (after Minardo et al., 2014).

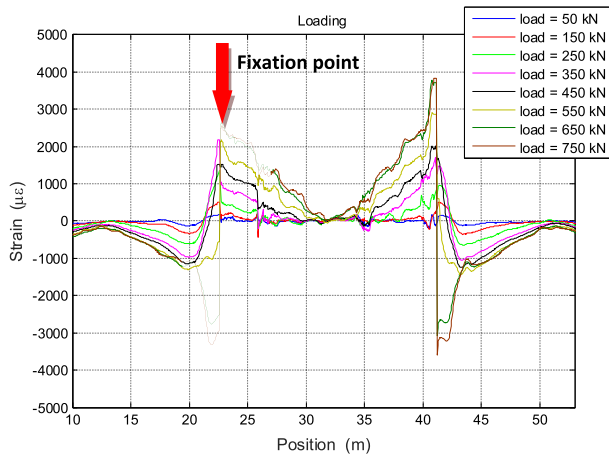

Fig. 10. Strain measurements during the loading phase.

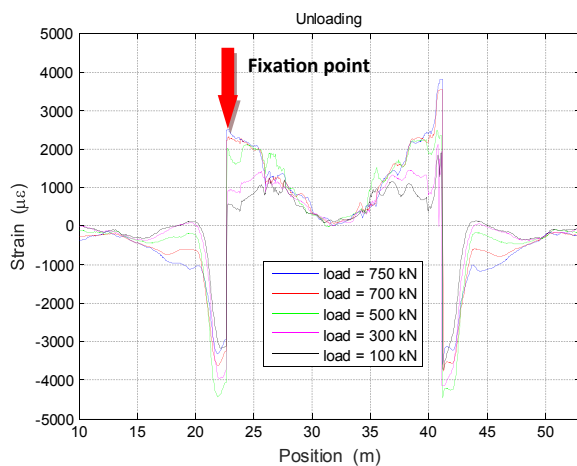

Fig. 11. Strain measurements during the unloading phase.

and field tests have shown the great potentialities of such sensors in monitoring and analyzing soil slopes and foundations. The main limitations of the proposed technology in geotechnical monitoring are essentially the lack of standardized procedures for sensing cables installation in large areas, the difficulty in data interpretation and accurate modeling of ground/sensor interaction.

Conflict of interest

The authors wish to confirm that there are no known conflicts of interest associated with this publication and there has been no

significant financial support for this work that could have influenced its outcome.

Acknowledgments

It is gratefully noted that the project is supported by grant from MIUR – PON01 1525 – MONICA.

References

- Boyd RW. *Nonlinear optics*. 3rd ed. Waltham, Massachusetts, USA: Academic Press; 2008.
- Dewynter V, Rougeault S, Magne S, Ferdinand P, Vallon F, Avallone L, Vacher E, De Broissia M, Ch Canepa, Poulain A. Brillouin optical fiber distributed sensor for settlement monitoring while tunneling the metro line 3 in Cairo, Egypt. In: Proceedings of the SPIE 7503, 20th International Conference on Optical Fiber Sensors, 75035M; 2009. <http://dx.doi.org/10.1117/12.835376>.
- Iten M. *Novel applications of distributed fiber-optic sensing in geotechnical engineering*. Zurich, Switzerland: vdf Hochschulverlag AG; 2011.
- Lenke P, Wendt M, Krebber K, Glözl R. Highly sensitive fiber optic inclinometer: easy to transport and easy to install. In: Proceedings of the SPIE 7753, 21st International Conference on Optical Fiber Sensors, 775352; 2011. <http://dx.doi.org/10.1117/12.884695>.
- Minardo A, Bernini R, Amato L, Zeni L. Bridge monitoring using Brillouin fiber-optic sensors. *IEEE Sensor Journal* 2012;12(1):145–50.
- Minardo A, Picarelli L, Avolio B, Coscetta A, Papa R, Zeni G, Di Maio C, Vassallo R, Zeni L. Fiber optic based inclinometer for remote monitoring of landslides: on site comparison with traditional inclinometers. In: Proceedings of International Geoscience and Remote Sensing Symposium (IGARSS 2014) / 35th Canadian Symposium on Remote Sensing (35th CSRS), Québec City, Québec, Canada; 2014. p. 4078–81.
- Olivares L, Damiano E, Picarelli L, Greco R, Bernini R, Minardo A, Zeni L. An instrumented flume for investigation of the mechanics of rainfall-induced landslides in unsaturated granular soils. *Geotechnical Testing Journal* 2009;32(2):108–18.
- Pirone M, Damiano E, Picarelli L, Olivares L, Urciuoli G. Groundwater-atmosphere interaction in unsaturated pyroclastic slopes at two sites in Italy. *Rivista Italiana di Geotecnica* 2012;3:29–49.



Luigi Zeni is full professor of electronics and photonics at the Second University of Naples and president of the Research Consortium on Advanced Remote Sensing Systems – CO.RI.S.T.A. (www.corista.eu). He has been, from 2001 to 2012, vice-director of the Department of Information Engineering. He took his degree in Electronic Engineering, summa cum laude, from University of Naples in 1988 and his Ph.D. in Electronics and Computer Science in 1992. He worked at TU-Delft (NL) as a visiting scientist. He has been national coordinator of PRIN projects, scientific coordinator of research contracts with public and private institutions and responsible for projects funded within the 7th FP of the EU. He has been member of the Management Committee of the COST 299 “Optical fibers

for new challenges facing the information society” and of the COST TD1001 “Novel and Reliable Optical Fiber Sensor Systems for Future Security and Safety Applications”. His main research interests include optical fiber sensors for distributed measurements of deformation and temperature, optoelectronic integrated sensors and biosensors. He is author of about 120 papers published in international journals, 120 publications at international conferences and 10 patents. He is also founder of the Spin-Off company OPTOSENSING dealing with structural and environmental monitoring by optical fiber sensors.