

# We are IntechOpen, the world's leading publisher of Open Access books Built by scientists, for scientists

5,000

Open access books available

125,000

International authors and editors

140M

Downloads

Our authors are among the

154

Countries delivered to

TOP 1%

most cited scientists

12.2%

Contributors from top 500 universities



WEB OF SCIENCE™

Selection of our books indexed in the Book Citation Index  
in Web of Science™ Core Collection (BKCI)

Interested in publishing with us?  
Contact [book.department@intechopen.com](mailto:book.department@intechopen.com)

Numbers displayed above are based on latest data collected.  
For more information visit [www.intechopen.com](http://www.intechopen.com)



## Design, Management and Control of Logistic Distribution Systems

Riccardo Manzini <sup>\*(‡)</sup> and Rita Gamberini<sup>\*\*</sup>

<sup>\*</sup> *Department of Industrial Mechanical Plants, University of Bologna*

<sup>\*\*</sup> *Department of Engineering Sciences and Methods,  
University of Modena and Reggio Emilia  
Italy*

### 1. Introduction

Nowadays global and extended markets have to process and manage increasingly differentiated products, with shorter life cycles, low volumes and reducing customer delivery times. Moreover several managers frequently have to find effective answers to one of the following very critical questions: in which kind of facility plant and in which country is it most profitable to manufacture and/or to store a specific mix of products? What transportation modes best serve customer points of demand, which can be located worldwide? Which is the best storage capacity of a warehousing system or a distribution center (DC)? Which is the most suitable safety stock level for each item of a company's product mix? Consequently logistics is assuming more and more importance and influence in strategic and operational decisions of managers of modern companies operating worldwide.

The Council of Logistics Management defines logistics as "the part of supply chain process that plans, implements and controls the efficient, effective flow and storage of goods, services, and related information from the point of origin to the point of consumption in order to meet customers' requirements". Supply Chain Management (SCM) can be defined as "the integration of key business processes from end-user through original suppliers, that provides product, service, and information that add value for customers and other stakeholders" (Lambert et al., 1998). In accordance with these definitions and with the previously introduced variable and critical operating context, Figure 1 illustrates a significant conceptual framework of SCM proposed by Cooper et al. (1997) and discussed by Lambert et al. (1998). Supply chain business processes are integrated with functional entities and management components that are common elements across all supply chains (SCs) and determine how they are managed and structured. Not only back-end and its traditional

---

<sup>‡</sup> corresponding author: riccardo.manzini@unibo.it

stand-alone modelling is addressed, but the front-end beyond the factory door is also addressed through information sharing among suppliers, supplier's suppliers, customers, and customers' customers.

In the modern competitive business environment the effective integration and optimization of the planning, design, management and control activities in SCs are one of the most critical issues facing managers of industrial and service companies, which have to operate in strongly changing operating conditions, where flexibility, i.e. the ability to rapidly adapt to changes occurring in the system environment, is the most important strategic issue affecting the company success.

As a consequence the focus of SCM is on improving external integration known as "channel integration" (Vokurka & Lummus, 2000), and the main goal is the optimization of the whole chain, not via the sum of individual efficiency maximums, but maximising the entire system thanks to a balanced distribution of the risks between all the actors.

The modelling activity of production and logistic systems is a very important research area and material flows are the main critical bottleneck of the whole chain performance. For this reason in the last decade the great development of research studies on SCM has found that new, effective supporting decisions models and techniques are required. In particular a large amount of literature studies (Sule 2001, Manzini et al. 2006, Manzini et al. 2007a, b, Gebennini et al. 2007) deal with facility management and facility location (FL) decisions, e.g. the identification of the best locations for a pool of different logistic facilities (suppliers, production plants and distribution centers) with consequent minimization of global investment, production and distribution costs. FL and demand allocation models and methods object of this chapter are strongly associated with the effective management and control of global multi-echelon production and distribution networks.

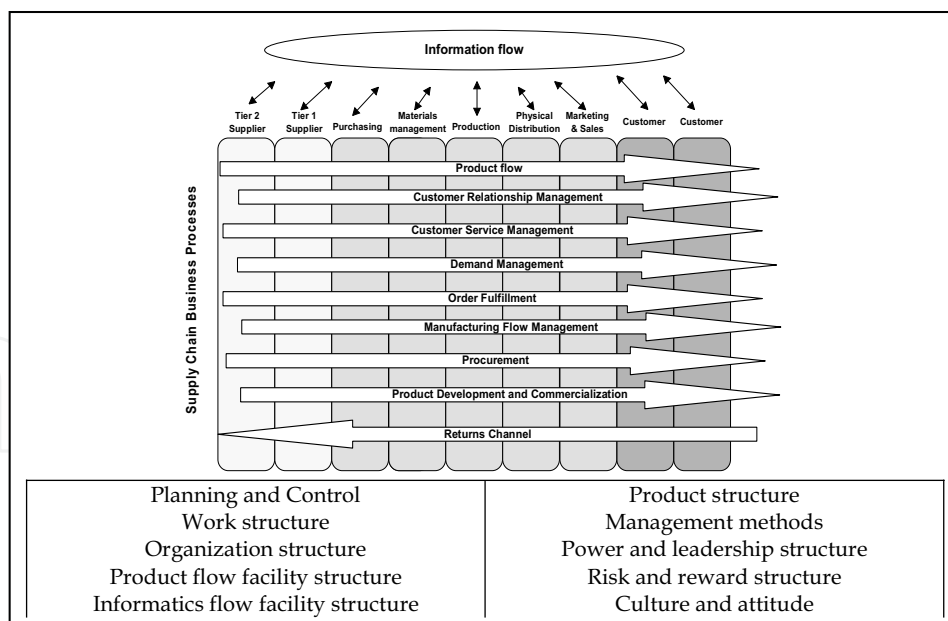

Figure 1. Supply Chain Management (SCM) framework and components

A few studies propose operational models and methods for the optimization of SCs, focusing on the effectiveness of the global system, i.e. the whole chain, and the determination of a global optimum. The purpose of this chapter is the definition of new perspectives for the effective planning, design, management, and control of multi-stage distribution system by the introduction of a new conceptual framework and an operational supporting decision platform. This framework is not theoretical, but deals with the tangible Production Distribution Logistic System Design (PDSD) problem and the optimization of logistic flow within the system. As a consequence the proposed optimization models have been applied to real case studies or to multi-scenarios experimental analysis, and the obtained results are properly discussed.

The remainder of this chapter is organized as follows: Section 2 presents and discusses principal literature studies on SC planning and design. Section 3 presents and describes the conceptual framework proposed by the authors for providing an effective solutions to the PDSD problem. Section 4 presents mixed integer programming models and a case study for the so called static design of a logistic network. Similarly Section 5 and 6 discuss about the fulfillment system design problem and the dynamic facility location. Finally, Section 7 concludes with directions for future research.

## 2. Review of the literature

In recent years hundreds of studies have been carried out on various logistics topics, e.g. enterprise resource planning (ERP), warehousing, transportation, e-commerce, etc. These studies follow the well-known definition of SC: "it consists of supplier/vendors, manufacturers, distributors, and retailers interconnected by transportation, information and financial infrastructure. The objective is to provide value to the end consumer in terms of products and services, and for each channel participant to garner a profit in doing so" (Shain & Robinson, 2002). As a consequence SCM is the act of optimizing all activities through the supply chain (Chan & Chan 2005).

Literature contributions in SC planning and management discriminate between the strategic level on the one hand, and the tactical and operational levels on the other (Shen 2005, Manzini et al. 2007b). The strategic level deals with the configuration of the logistic network in which the number, location, capacity, and technology of the system facilities are decided. The most important tactical and operational decisions are inventory management decisions and distribution decisions within the SC, e.g. deciding the aggregate quantities and material flows for purchasing, processing, and distribution of products. Shen (2005) affirms that in order to achieve important costs savings, many companies have realized that the generic SC should be optimized as a whole, i.e. the major cost factors that impact on the performance of the chain should be considered jointly in the decision model. Even though several studies have proposed innovative models and methods to support logistic decision making concerning what to produce, where, when, how, and for which customer, etc., as yet no effective and low cost tools have been developed capable of integrating logistic problems and decision making at different levels as a support for management in industrial and service companies. Recent studies of Manzini et al. (2007b), Monfared & Yang (2007), and Samaranayake & Toncich (2007) introduce the first basis for the definition and development

of effective supporting decision tools which integrates these three different levels of planning. In particular the tool proposed by Manzini et al. (2007b) is based on an original conceptual framework described in next section. In logistics and SCM the high level of significance of the generic FL problem can be obtained by taking of simultaneous decisions regarding design, management, and control of a distribution network:

1. location of new supply facilities in a given set of demand points. The demand points correspond to existing customer locations;
2. allocation of demand flows to available or new suppliers;
3. configuration of the transportation network for supplying demand needs: i.e. the design of paths from suppliers to customers and simultaneously the management of routes and vehicles.

The problem of finding the best of many possible locations can be solved by several qualitative and efficiency site selection techniques, e.g. ranking procedures and economic models (Byunghak & Cheol-Han 2003). These techniques are still largely influenced by subjective and personal opinions (Love et al. 1988, Sule 2001). Consequently, the problems of an effective location analysis are generally and traditionally categorized into one broad classes of quantitative and quite effective methods described in Table 1 (Love et al. 1988, Sule 2001, Manzini et al. 2007a).

In particular the location allocation is the problem to determine the optimal location for each of the  $m$  new facilities and the optimal allocation of existing facility requirements to the new facilities so that all requirements are satisfied, that is, when the set of existing facility locations and their requirements are known. Literature presents several models and approaches to treating location of facilities and allocation of demand points simultaneously. In particular, Love et al. (1988) discuss the following site-selection LAP models: set-covering (and set-partitioning models); single-stage, single-commodity distribution model; and two-stage, multi-commodity distribution model which deals with the design for supply chains composed of production plants, DCs, and customers. The LAP models consider various aspects of practical importance such as production and delivery lead times, penalty cost for unfulfilled demand, and response times different customers are willing to tolerate (Manzini et al. 2007a, b). Passing to the NLP one of the most critical decision deals with the selection of specific paths from different nodes in the available network.

So-called "dynamic location models" consider a multi-period operating context where the demand varies between different time periods. This configuration of the problem aims to answer three important questions. Firstly, *where* i.e. the best places to locate the available facilities. Secondly, *what* size i.e. which is the best capacity to assign to the generic logistic facility. Thirdly, *when* i.e. with regard to a specific location, which periods of time demand a certain amount of production capacity. Recent studies on FL are presented by Snyder (2006), Keskin & Uster (2007) and Hinojosa et al. (2008). ReVelle et al. (2008) present a taxonomy of the broad field of facility location modelling.

Class of location problems/ models	Description	Examples and references
Single facility minimum location problems	optimal location of a single facility designed to serve a pool of existing customers	see Francis et al. (1992)
Multiple facility location problems (MFLP)	optimal location of multiple facilities capable of serving the customers in the same or in different ways.	p-Median problem (p-MP), p-Centre problem (p-CP), uncapacitated facility location problem (UFLP), capacitated facility location problem (CFLP), quadratic assignment problem (QAP), and plant layout problem
Facility location allocation problem (LAP)	several facilities have to be located and flows between the new facilities and the existing facilities (i.e. demand points) have to be determined. The LAP is an MFLP with unknown allocation of demand to the available facilities.	see Love et al. (1988), Manzini et al. (2007a,b)
Network location problem (NLP)	a LAP where the network (routes, distances, travel times, etc.) have to be constructed and configured.	see Sule et al. (1988), Manzini et al. (2007b)
Extensions classes of NLP and LAP	Tours development problem. Vehicle routing problem (e.g. assignment procedures for the travelling salesman problem and the truck routing problem). Dynamic location models. Multi-period dynamic facility location problem. Integrated distribution network design problem (decisions regarding locations, allocation, routing and inventory).	see Sule et al. (1988), Ambrosino and Scutellà (2005), Gebennini et al. (2007), Manzini et al. (2007b).

Table 1. Main classes of facility locations in logistics.

### 3. A PDSO conceptual framework

Limited research has been carried out into solving the supply chain problems from a "system" point of view, where the purpose is to design an integrated model for supply chains. The authors propose an original conceptual framework which is illustrated in Fig.2 and is based on the integration of three different planning levels (Manzini et al. 2007b):

- A. *Strategic planning*. This level refers to a long term planning horizon (e.g. 3-5 years) and to the strategic problem of designing and configuring a generic multi stage supply chain. Management decisions deal with the determination of the number of facilities, geographical locations, storage capacity, and allocation of customer demand (Manzini

et al. 2006). The proposed supporting decisions approach to the strategic planning is based on a *static network design* as illustrated in Section 4.

- B. *Tactical planning*. This level refers to both long and short term planning horizons and deals with the determination of the best fulfillment policies and material flows in a supply chain, modelled as a multi-echelon inventory distribution system. The proposed supporting decisions approach is specifically based on the application of *simulation* and *multi-scenario what-if analysis* as illustrated in Section 5.
- C. *Operational planning*. It refers to long and short term planning horizons. In fact, the main limit of the modelling approach based on the static network design is based on the absence of time dependency for problem parameters and variables. A period *dynamic network design* differs from the static problem by introducing the variable time according to the determination of the number of logistic facilities, geographical locations, storage capacities, and daily allocation of customer demand to retailers (i.e. distribution centers or production plants). The very short planning horizon is typical of a logistic requirement planning (LRP), i.e. a tool comparable to the well-known material requirement planning (MRP) and capable of planning and managing the daily material flows throughout the logistic chain.

	Decisions	Planning horizon	Unit period of time	Problem classification	Objective	Modeling & Supporting decision methods
(A) Strategic planning Static Network Design	Number of facilities, locations, storage capacity, allocation of demand	long term e.g. 3-5 years	Single period (e.g. 3-5 years)	<i>Location allocation problem (LAP) &amp; Network location problem (NLP)</i>	Network definition, cost minimization - profit maximization	Mixed integer programming
(B) Tactical planning Fulfillment system Design & Management	Lead time, service level (LS), safety stock (SS)	long term and/or short term (e.g. week, day)	Multi period (e.g. day)	<i>Multi-echelon inventory distribution fulfillment system</i>	Determination of fulfillment policies, material flow management, control of the bull-whip effect	Dynamic modeling & simulation
(C) Operational planning (logistic requirement) Dynamic Network Management	(A) + Allocation of demand of customers (retailers) to retailers (distribution centers and/or production plants)	short term	Multi period (e.g. day)	<i>Dynamic location allocation problem (LAP)</i>	Logistic requirement planning (LRP)	Mixed integer programming & simulation

Figure 2. Conceptual framework for the Production Distribution Logistic System Design problem

Next three sections presents effective models for approaching to the previously described planning levels for the optimization of a multi-echelon production distribution system.

#### 4. Static network design

An effective mathematical formulation of the static (i.e. not time dependent) network design problem is based on the LAP (Manzini et al. 2006, 2007a, 2007b). The objective is to configure the distribution network by minimizing a cost function and maximizing profit. LAP belongs to the NP-hard complexity class of decision problems, and the generic occurrence requires the simultaneous determination of the number of logistic facilities (e.g. production plants, warehousing systems, and distribution centers), their locations, and the assignment of customer demand to them.

Fig. 3 exemplifies a distribution system whose configuration can be object of a LAP. The generic occurrence of a LAP is usually made of several entities (i.e. facilities). Fig. 4 illustrates an example of a worldwide distribution of a large number of customers within a company logistic network. In particular the generic dot represents a demand point and its colour is related to the amount of demand during a period of time  $T$  (e.g. one year). The colour of the geographic area relates to the average unit cost of transportation from a central depot located in Ohio.

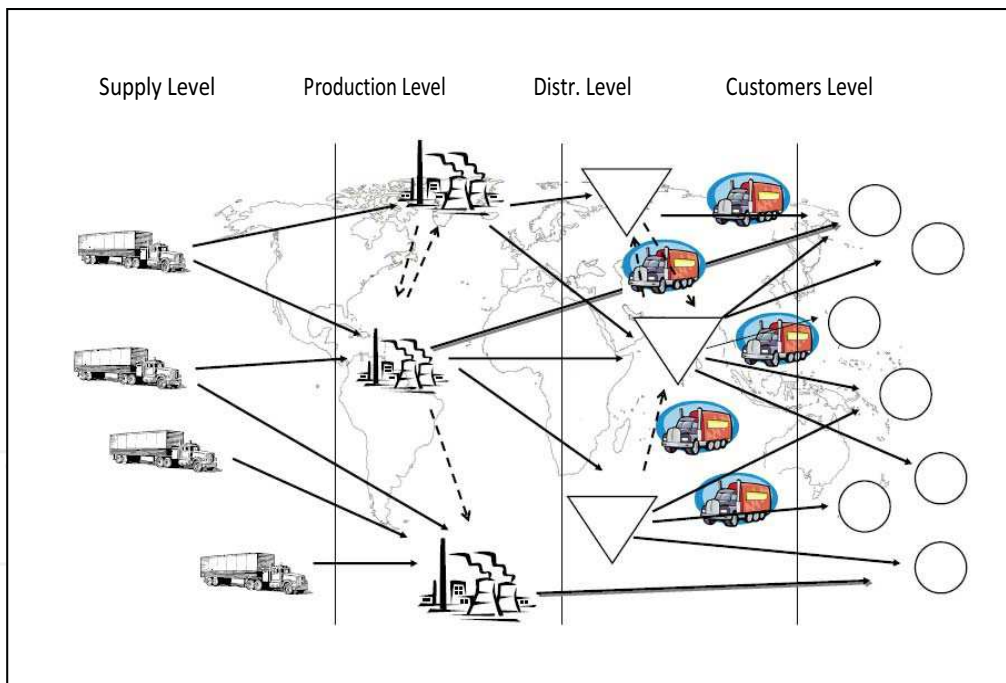

Figure 3. Multi-stage distribution system



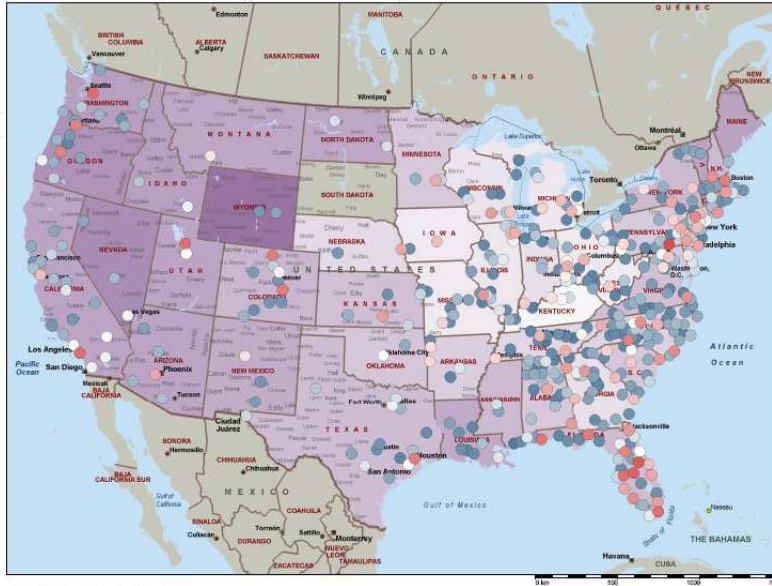

Figure 4. Exemplifying distribution of points of demand

#### 4.1 Single commodity 2-stage model (SC2S)

The following static model has been developed by the authors for the design of a 2-stage logistic network which involves three different levels of facilities (i.e. types of nodes): a production plant which can be identified by a central distribution center (CDC), a set of regional distribution centers (RDCs), and a group of customers which represent the points of demand.

This model controls the distribution customers lead times ( $t_{kl}$  where  $k$  is a generic RDC and  $l$  is the generic demand point, i.e. customer) introducing a maximum admissible delivery delay, called  $T_R$ . In particular it is possible to measure and optimize three different portions of customers demand:

1. part of demand delivered within lead time  $T_l$  (defined for customer  $l$ ), i.e.  $t_{kl} < T_l$ ;
2. part of demand not delivered within  $T_l$  but within the admissible delivery delay, i.e.  $t_{kl} < T_l + T_R$ ;
3. part of demand not delivered because the delay is not admissible, i.e.  $t_{kl} > T_l + T_R$ .

The objective function is defined as follows:

$$\Phi_{SC2S} = \underbrace{\sum_{k=1}^K c'_k x'_k d'_k}_{C(CDC-RDC)} + \underbrace{\sum_{k=1}^K \sum_{l=1}^L c'_{kl} x_{kl} d_{kl}}_{C(RDC-Demand)} + \underbrace{\sum_{k=1}^K \sum_{l=1}^L A(c_{kl} x_{kl}^{in} d_{kl})}_{C_{DELAY}} + \underbrace{\sum_{k=1}^K \sum_{l=1}^L Bx_{kl}^{out}}_{C_{UNDELIVERED}} + \underbrace{\sum_{k=1}^K (f_k z_k + v_k x'_k)}_{C_{RDC}} \quad (1)$$

The mixed integer linear model is:

$$\min\{\Phi_{SC2S}\}$$

subject to:

$$x'_k = \sum_{l=1}^L [x_{kl} + x_{kl}^{in} + x_{kl}^{out}] \quad (2)$$

$$\sum_{k=1}^K [x_{kl} + x_{kl}^{in} + x_{kl}^{out}] = D_l \quad (3)$$

$$\sum_{l=1}^L y_{kl} \leq pz_k \quad (4)$$

$$\sum_{k=1}^K y_{kl} = 1 \quad (5)$$

$$x_{kl} + x_{kl}^{in} \leq D_l y_{kl} \quad (6)$$

$$x_{kl} = 0 \quad \text{if} \quad t_{kl} > T_l \quad (7)$$

$$\left. \begin{array}{l} x_{kl}^{in} = 0 \\ y_{kl} = 0 \end{array} \right\} \quad \text{if} \quad t_{kl} > T_l + T_R \quad (8)$$

$$\left\{ \begin{array}{l} x_{kl} \geq 0 \\ x_{kl}^{in} \geq 0 \\ x_{kl}^{out} \geq 0 \end{array} \right. \quad (9)$$

$$z_k, y_{kl} \in \{0,1\} \quad (10)$$

where

$k = 1, \dots, K$

$l = 1, \dots, L$

$c'_k$

transportation unit cost from the CDC to the RDC  $k$ ;

$x'_k$

product quantity from the CDC to the RDC  $k$ ;

$d'_k$

distance from the CDC to the RDC  $k$ ;

$c_{kl}$

transportation unit cost from the RDC  $k$  to the point of demand  $l$ ;

$x_{kl}$

product quantity from the RDC  $k$  to the point of demand  $l$ ;

$d_{kl}$

distance from the RDC  $k$  to the point of demand  $l$ ;

$x_{kl}^{in}$

product quantity delivered with an admissible delay from the RDC  $k$  to the point of demand  $l$ ;

RDC belonging to the second level of the generic logistic network;

demand point belonging to the third level of the network;

$x_{kl}^{out}$	product quantity (from the RDC $k$ to the point of demand $l$ ) not delivered because it does not respect the maximum admissible delay;
$y_{kl}$	1 if the RDC $k$ supplies the point of demand $l$ . 0 otherwise;
$z_k$	1 if the RDC $k$ is selected by the solution of the problem; 0 otherwise;
$f_k$	fixed cost to operate using the RDC $k$ ;
$v_k$	variable cost (based on the product quantity flow) for the RDC $k$ ;
$D_l$	demand from the point of demand $l$ ;
$t_{kl}$	delivery time from the RDC $k$ to the point of demand $l$ ;
$T_l$	delivery time required by the point of demand $l$ ;
$p$	maximum number of points of demand supplied by a generic RDC;
$A$	additional delivery unit cost for product delivered with an admissible delay;
$B$	penalty unit cost for units of product not delivered because they do not respect the admissible delay;
$T_R$	admissible delivery delay.

The objective function is composed of five different addends:

1.  $C(CDC-RDC)$ . It is the global transportation cost from the first level (CDC) to second level (RDCs);
2.  $C(RDC-Demand)$ . It is the global transportation cost from the second level to the third level (points of demands);
3.  $C(DELAY)$ . It measures the cost for the product quantities in delivery delay but delivered during admissible delay time  $T_R$ ;
4.  $C(UNDELIVERED)$ . It is a penalty cost associated with product quantities (from the RDCs to the points of demand) not delivered because they failed to respect the delay time  $T_R$ ;
5.  $C(RDC)$ . It is the cost associated with the management of the set of RDCs.

#### 4.2 Single commodity 3-stage model (SC3S)

The previously described mixed integer programming model has also been modified in order to take into account the product levels and related flows and costs, which were previously neglected. The following presents the adopted objective function which quantifies also the transportation cost from the production level to the CDC.

$$\begin{aligned}
 \Phi_{SC3S} = & \underbrace{\sum_{i=1}^I \sum_{j=1}^J c''_{ij} x''_{ij} d''_{ij}}_{C(PRODUCTION-CDC)} + \underbrace{\sum_{j=1}^J \sum_{k=1}^K c'_{jk} x'_{jk} d'_{jk}}_{C(CDC-RDC)} + \underbrace{\sum_{k=1}^K \sum_{l=1}^L c_{kl} x_{kl} d_{kl}}_{C(RDC-Demand)} + \\
 & + \underbrace{\sum_{j=1}^J [f_j w_j + v_j \sum_{i=1}^I x''_{ij}]}_{C_{CDC}} + \underbrace{\sum_{k=1}^K [f_k z_k + v_k \sum_{j=1}^J x'_{jk}]}_{C_{RDC}} + \\
 & + \underbrace{\sum_{k=1}^K \sum_{l=1}^L A c_{kl} x_{kl}^{in} d_{kl}}_{C_{DELAY}} + \underbrace{\sum_{k=1}^K \sum_{l=1}^L B x_{kl}^{out}}_{C_{UNDELIVERED}} \quad (11)
 \end{aligned}$$

The new set of constraints introduced by this model have now been omitted because they are very similar to those previously discussed.

New symbols introduced by this model are:

- $i = 1, \dots, I$  production plant;  
 $j = 1, \dots, J$  central distribution center CDC;  
 $c''_{ij}$  transportation unit cost from the production plant  $i$  to the CDC  $j$ ;  
 $x''_{ij}$  product quantity from the production plant  $i$  to the CDC  $j$ ;  
 $d''_{ij}$  distance from the production plant  $i$  to the CDC  $j$ ;  
 $c'_{jk}$  transportation unit cost from the CDC  $j$  to the RDC  $k$ ;  
 $x'_{jk}$  product quantity from the CDC  $j$  to the RDC  $k$ ;  
 $d'_{jk}$  distance from the CDC  $j$  to the RDC  $k$ ;  
 $f_j$  fixed operating cost using the CDC  $j$ ;  
 $v_j$  variable cost (based on the product quantity flow) for the CDC  $j$ ;  
 $w_j$  1 if the CDC  $j$  is selected by the solution of the problem; 0 otherwise.

The following new addends have been introduced into the objective function:

6.  $C(\text{PRODUCTION-CDC})$ . It represents the global cost for the distribution of products from the first level to the CDCs level;
7.  $C_{\text{CDC}}$  measures the cost associated with the management of the set of CDCs.

#### 4.3 Multi commodity 3-stage model (MC3S)

This model differs from previously illustrated because it is a multi commodity model: several different products can be simultaneously involved for supporting strategic decisions on network configuration. The objective function is:

$$\begin{aligned}
 \Phi_{\text{MC3S}} = & \underbrace{\sum_{m=1}^M \sum_{i=1}^I \sum_{j=1}^J c''_{mij} x''_{mij} d''_{mij}}_{C(\text{PRODUCTION-CDC})} + \underbrace{\sum_{m=1}^M \sum_{j=1}^J \sum_{k=1}^K c'_{mjk} x'_{mjk} d'_{mjk}}_{C(\text{CDC-RDC})} + \\
 & + \underbrace{\sum_{m=1}^M \sum_{k=1}^K \sum_{l=1}^L c_{mkl} x_{mkl} d_{mkl}}_{C(\text{RDC-Demand})} + \underbrace{\sum_{j=1}^J [f_j w_j + v_j \sum_{m=1}^M \sum_{i=1}^I x''_{mij}]}_{C_{\text{CDC}}} + \underbrace{\sum_{k=1}^K [f_k z_k + v_k \sum_{m=1}^M \sum_{j=1}^J x'_{mjk}]}_{C_{\text{RDC}}} + \\
 & + \underbrace{\sum_{m=1}^M \sum_{k=1}^K \sum_{l=1}^L A c_{mkl} x_{mkl}^{\text{in}} d_{mkl}}_{C_{\text{DELAY}}} + \underbrace{\sum_{m=1}^M \sum_{k=1}^K \sum_{l=1}^L B x_{mkl}^{\text{out}}}_{C_{\text{UNDELIVERED}}}
 \end{aligned} \quad (12)$$

New symbols introduced by this model are:

- $m = 1, \dots, M$  product family;  
 $c''_{mij}$  transportation unit cost from the production plant  $i$  to the CDC  $j$  for the family  $m$ ;  
 $x''_{mij}$  product quantity from the production plant  $i$  to the CDC  $j$  for the family  $m$ ;  
 $d''_{mij}$  distance from the production plant  $i$  to the CDC  $j$  for the family  $m$ ;  
 $c'_{mjk}$ ,  $x'_{mjk}$ ,  $d'_{mjk}$ ,  $c_{mkl}$ ,  $x_{mkl}$ ,  $d_{mkl}$ , etc. are similar to  $c'_{jk}$ ,  $x'_{jk}$ ,  $d'_{jk}$ ,  $c_{kl}$ ,  $x_{kl}$ ,  $d_{kl}$ , etc., which were introduced in the previous objective function (12), but they refer to the generic family of products  $m$ .

#### 4.4 Strategic planning. Case study

This section presents the results obtained by the application of previously illustrated mixed integer linear location allocation models to the rationalization and optimization of the logistic network for the distribution of components in a leading electronics Italian company (this case study is deeply presented in Manzini et al. 2006).

Figure 5 illustrates the network configuration made of 4 levels (production level, central DC level, RDC level and customer level) and 3 stages (production plants-CDC, CDC-RDCs and RDCs-Customers). The model does not consider multiple periods of time according to a long-term strategic design and planning of the network.

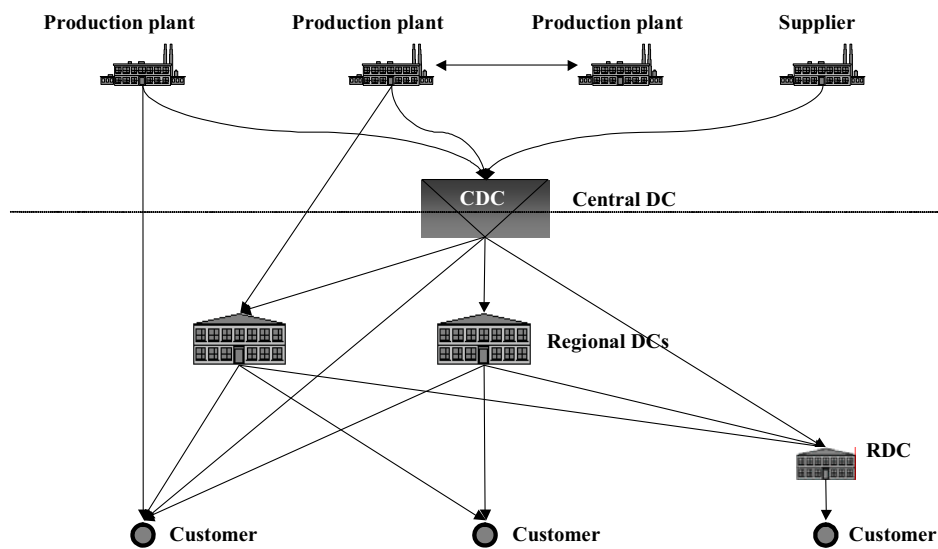

Figure 5. Strategic planning. Network configuration in the case study

The products number several thousands and their demand is strongly fragmented; nevertheless in a first approximation the products' mix has been reduced to a single product according to types of products which are very small and so similar that their individual quantities are unimportant. Then the model of the system does not consider multiple periods of time according to a long-term strategic design and planning. Furthermore this aggregated demand of products assumes a constant trend during a year. Finally more than 90% of the delivered products passed and passes through the CDC. As a consequence the flow of products along the system can be simply measured in tons and for the system design and optimization it is possible to apply the single commodity models illustrated above by omitting the production level in the SC2S model. Fig.6 presents the location of a pool of DCs and a set of exemplifying points of demand according to the projection of longitude and latitude values into Cartesian coordinates, useful for the determination of the distance between two generic locations.

The model illustrated in Section 4.1 has been applied to optimize the so-called "actual" network (i.e. to minimize the global logistic cost function in the original configuration of the

system, also called “AS-IS”, before the optimization study) for different values of  $T_R$ . Fig.7 presents the actual/AS-IS configuration of the system, which is compared with the best system configuration obtained by the application of the linear model when  $T_R$  is equal to 0. Fig.8 presents the results obtained when  $T_R$  is optimized (the optimal value is 9). Finally Fig.9 compares the actual configuration of the network with the best one distinguishing the different kinds of logistic costs of objective function (1): the global cost reduction is approximately 4.22% (about € 200000 per year) of the actual annual cost.

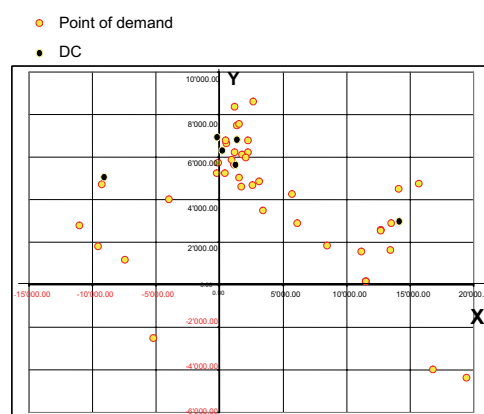

Figure 6. Points of demand and DCs in Cartesian coordinates

a) Actual configuration (5 DCs + CDC)      b) Best Configuration (3 DCs + CDC)

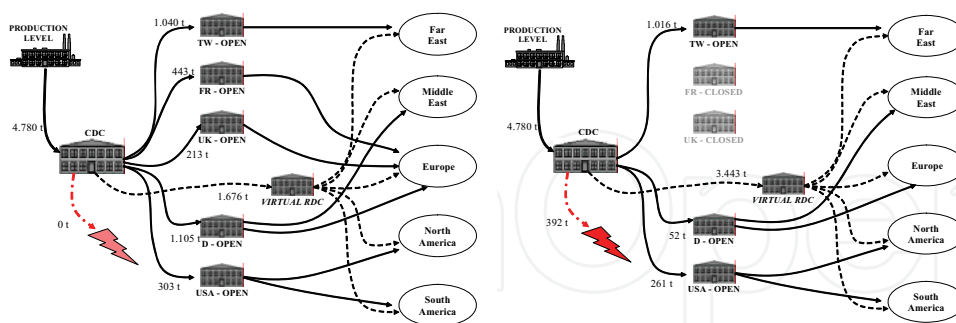

Figure 7. a) Actual configuration, b) Best configuration when  $T_R=0$

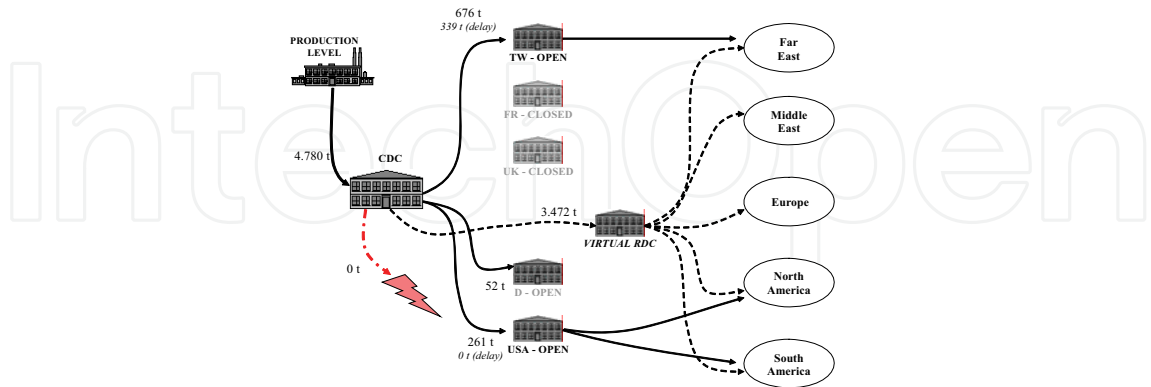

Figure 8. Best configuration when TR=9

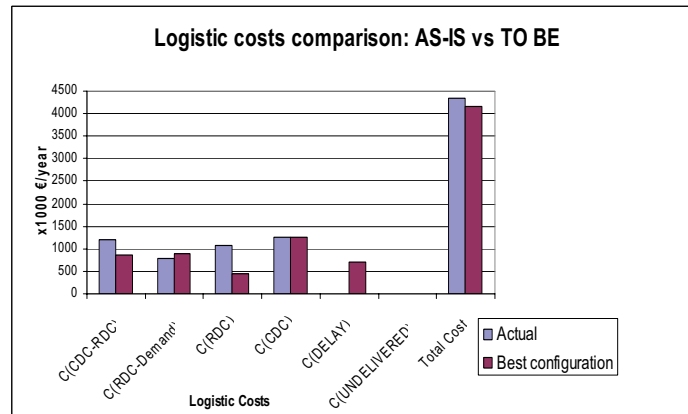

Figure 9. Logistic costs comparison AS-IS vs best configuration.

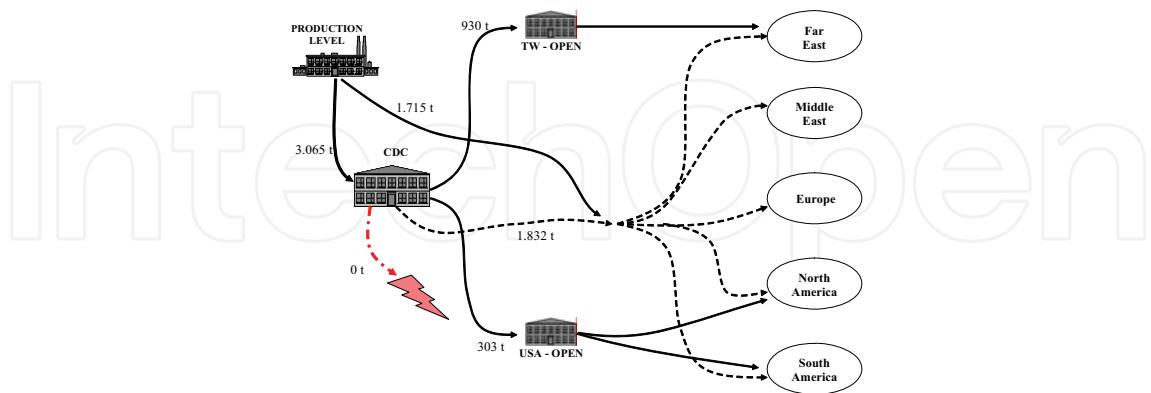

Figure 10. SC3S solution, when TR=9

Fig.10 shows the solution to the SC3S problem found by the linear programming solver MPL (Mathematical Programming Language by Maximal Software Inc.) introducing the production level. This solution cannot be compared directly with the solution produced by the SC2S because the second one does not quantify transportation costs from the production level. In particular, the opportunity to supply products directly from the production level to the point of demand strongly reduces the storage quantities located in the CDC. This opportunity is modelled by the introduction of a virtual DC (virtual RDC in figures 7 and 8). The previously illustrated multi-commodity model (the MC3L) is capable of distinguishing and quantifying the flows of different product families. By applying the model to the case study where  $M = 9$ ,  $I = 7$ ,  $J = 8$ ,  $K = 13$  and  $L = 351$ , the solution presented in fig. 11 is obtained. It is based on 3 DCs:

- i. a “virtual DC” through which products flow virtually and directly from production level to customers’ level;
  - ii. a CDC, which is capable of supplying customer demand directly (e.g. Europe) through the “virtual RDC”;
  - iii. 2 RDCs: TW supplies the Far East, while USA supplies North and South America.
- This result shows that the MC3L model is effective for rapid strategic and long-term design of a complex logistic network.

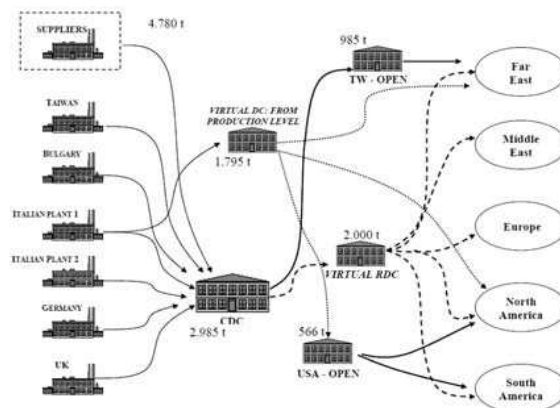

Figure 11. Multi-commodity model

## 5. Fulfillment system design

Being strategic and tactical, this level refers to both long and short term planning horizons. Therefore, the solution to the problem deals with the determination of the best fulfillment policies and material flows in a SC, modelled as a multi-echelon inventory distribution system. The decisional approach is specifically based on the application of simulation and multi-scenario what-if analysis.

The literature largely discusses the application of simulation and stochastic modelling to support the design and management of SCs (Chan & Chan 2005, 2006, Manzini et al. 2005b, Ng et al. 2003, Santoso et al. 2005). Simulation can model complex real systems incorporating many non-deterministic factors, such as uncertainty in demand, lead times,



number of facility locations, assignment of customer demand, etc. In particular, thanks to a what-if approach, simulation models can provide a thorough understanding of the dynamic behaviours of a system as well as assisting evaluation of different operational strategies.

The modelling approach of this planning level is dynamic, i.e. multi-period. So the modelled unit period of time can be the day. Every actor in the chain is modelled as a dynamic entity whose behaviour is deterministic or stochastic.

By using the dynamic modelling of the distribution system, management can implement different fulfillment strategies. In particular, the reorder strategy for the generic stock point (i.e. facility) of the distribution network can be either push or pull, e.g. a supplier can push materials to a distribution center which supplies retailers in accordance to a pull or push strategy.

**5.1 Case study. A multi-echelon 3-stage system**

Fig.12 exemplifies a 3-stage divergent system where each stockpoint has a unique supplier but it may deliver material to multiple other stockpoints. In particular stockpoint 0 is supplied by several external sources (e.g. production facilities), and the “end stockpoints” are the entities that deliver materials directly to final customers (whose demand can be stochastic). All products are supplied via the network in order to satisfy customer demand.

Fig.13 illustrates the well known reorder policy usually adopted for the determination of the reorder quantity of a retailer (or a DC) in a period of time  $t_i$ . This quantity is defined by the following equation:

$$q_i = S - I(t_i) \tag{13}$$

where

$t_i$   $i^{th}$  reviewing period (i.e. unit period of time);

$I(t_i)$  on-hand inventory in time  $t_i$ ;

$t_l$  identifies the variable lead time of the generic replenishment (Fig.13).

This is the order-up-to  $(S,s)$  replenishment policy whose several contributions in the literature confirm its effectiveness because it is a parametric rule which can be easily applied to represent different fulfillment policies such as the periodic review rule, the fixed order quantity rule, the economic order quantity (EOQ), etc.

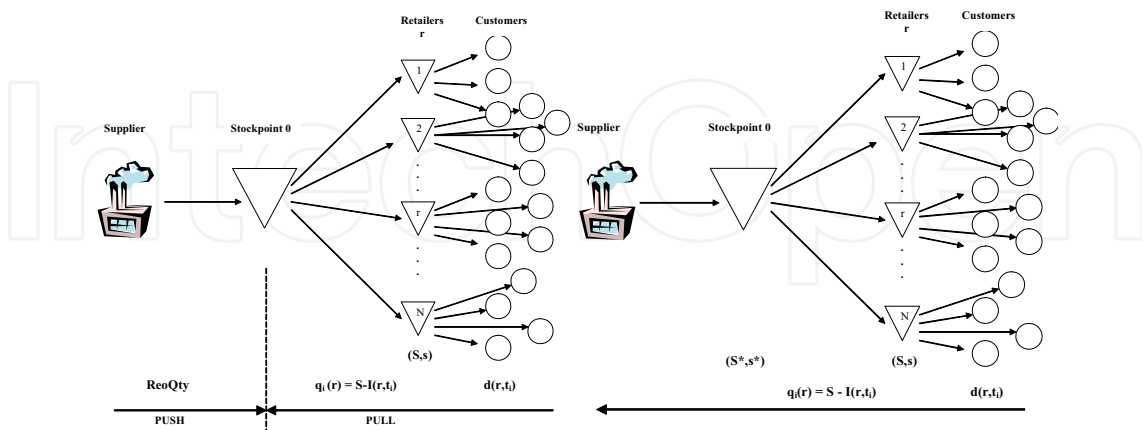

Figure 12. A 3-stage divergent system. Push-pull vs pull-pull strategies

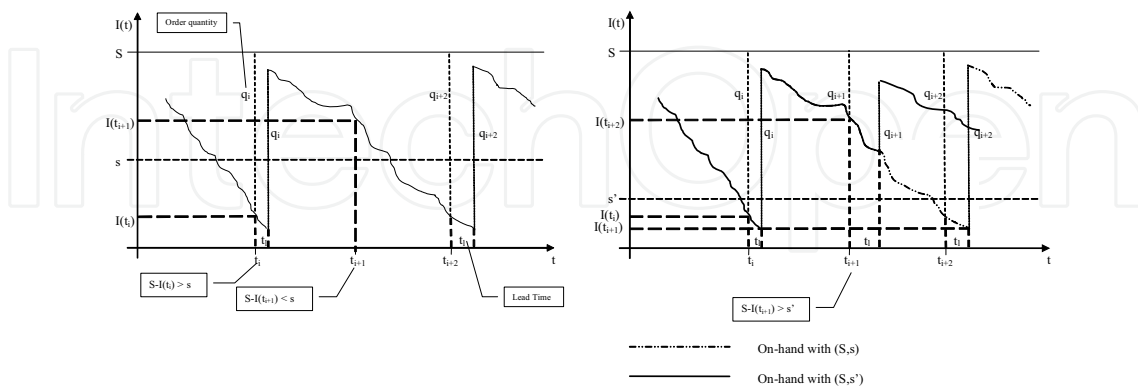

Figure 13. (S,s) policy.  $s' < s$

The following figures present some of the results obtained from a what-if analysis conducted on the simulation of several hypothetical scenarios in order to identify some effective guidelines for designing new Demand/Supply Chain. These results also illustrate the application of some statistical techniques to the management of the performance data in accordance with the proposed framework previously illustrated. In particular, Fig.14 presents the trend of some performance indexes ( $LS_1$ ,  $LSCent$ ,  $LStot$ , etc.) introduced to support the validation of a fulfillment model by identifying the warm-up period (equal to 500 time periods) and the right number of repetitions (equal to 10 and in agreement with a confidence interval equal to 0.95) for each simulation run. More details are reported in Manzini et al. (2005a).

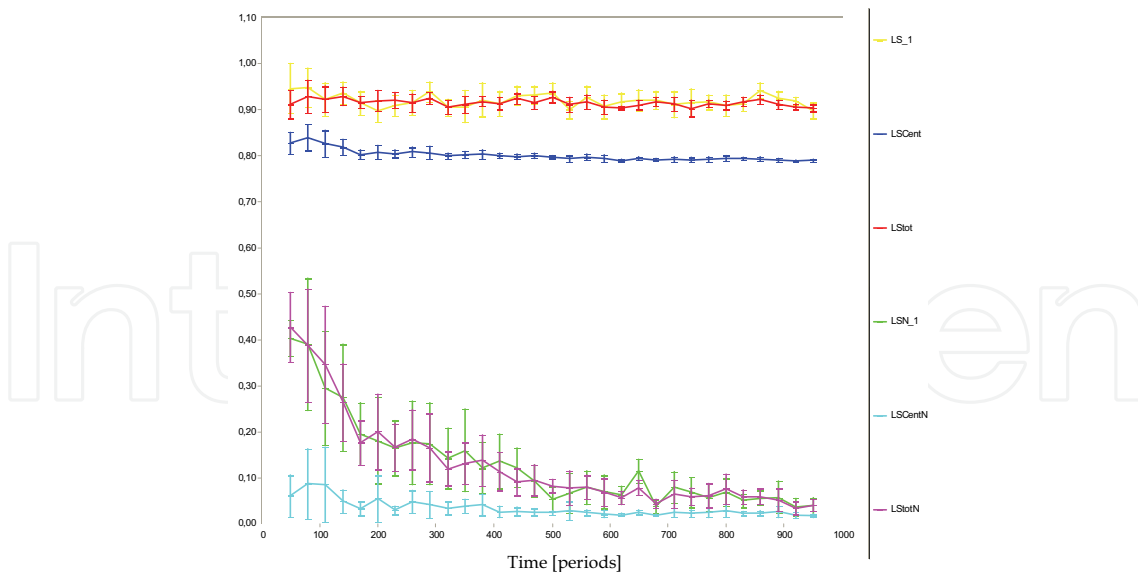

Figure 14. Validation analysis. Warm-up periods

Fig.15 illustrates the results of a factorial analysis (in particular an ANOVA analysis) for an exemplifying performance index  $Perf1(r=1, T=500)$  defined as follows:

$$Perf1(r, T) = \frac{LS_1(r, T)}{CUnil_r(T)} \tag{14}$$

where

- $r$  retailer;
- $T$  planning period;
- $LS_1(r, T)$  retailer service level, defined as the ratio between the whole amount of quantity delivered  $S(r, T)$  and the total amount of demand  $D(r, T)$  from all customers to  $r$ ;
- $CUnil_r(T)$  retailer unit cost.

In particular the retailer unit cost is defined as the ratio between the global cost for the retailer and the global economic value of the requested demand:

$$CUnil_r(T) = \frac{Ctot_r(T)}{\sum_{t_i} d(r, t_i) \cdot UnitPrice_r} \tag{15}$$

where

- $Ctot_r(T)$  global cost for the retailer in period  $T$ ;
- $d(r, t_i)$  customers demand in unit period of time  $t_i$  for retailer  $r$ ;
- $UnitPrice_r$  price of product for retailer  $r$ .

As a consequence the value of  $Perf1(r=1, T=500)$  measures the relationship between the generic service level (defined for a retailer- $r$ ) and the related logistic unit cost.

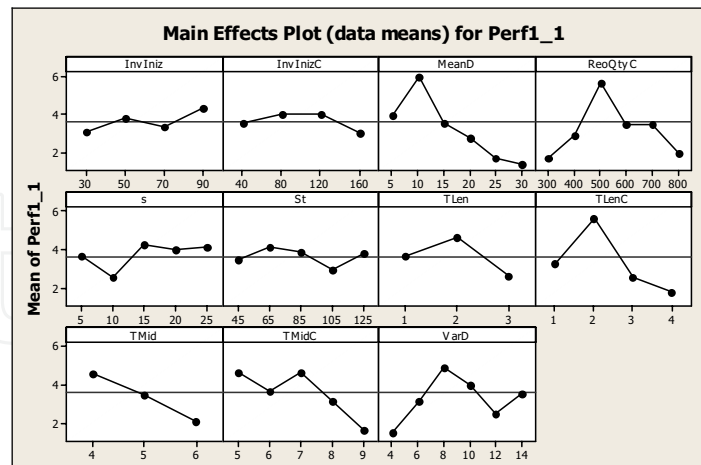

Figure 15. ANOVA Analysis.

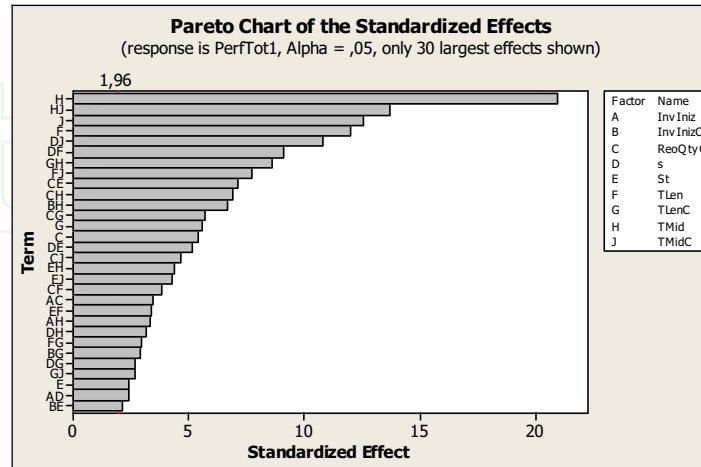

Figure 16. Pareto chart of the standardized effects

By the multi-level factorial analysis it is possible to identify the existence of significant increasing/decreasing (or decreasing/increasing) trends, the existence of optimal values and combinations of values for system performance optimization. Fig. 16 illustrates the Pareto Chart of the Standardized effects obtained by a  $2^k$  factorial analysis conducted on another performance index. The collection of several campaigns of factorial analysis support the identification of the most critical factors and combinations of factors affecting the system performance.

## 6. Network management and dynamic facility location

This planning level is simultaneously both tactical and operational, and refers to long and short term planning horizons. In fact, the main limit of the modelling approach based on the static LAP is based on the absence of time dependency for problem parameters and variables. The multi-period dynamic LAP differs from the static problem by introducing the variable time according to the determination of the number of logistic facilities, geographical locations, storage capacities, and daily allocation of customer demand to retailers (i.e. distribution centers or production plants). The very short planning horizon is typical of a logistic requirement planning (LRP), i.e. a tool comparable to the well-known material requirement planning (MRP) and capable of planning and managing the daily material flows throughout the logistic chain.

### 6.1 Multi period single commodity 2-stage model (SCMP2S)

An original and illustrative mathematical formulation of the dynamic LAP has recently been developed by Manzini et al. (2007a) and is now discussed: it is a multi period single commodity two stages (SCMP2S) linear model based on the application of mixed integer programming. The logistic network is composed of two stages that involve the levels introduced and discussed in section 3.1. The cost-based objective function  $\Phi_{SCMP2S}$  is:

$$\begin{aligned}
\Phi_{SCMP2S} = & \underbrace{\sum_{k=1}^K \left( c'_k d'_k \sum_{t=1}^T x'_{kt} \right)}_{C(CDC-RDC)} + \underbrace{\sum_{k=1}^K \sum_{l=1}^L \left[ c_{kl} d_{kl} \sum_{t=1}^T (x_{klt} + x_{klt}^{delay}) \right]}_{C(RDC-Demand)+C_{DELAY}} + \underbrace{\sum_{k=1}^K \sum_{t=1}^T c^p x'_{kt}}_{C_{PROD}} + \underbrace{\sum_{k=1}^K \sum_{t=1}^T c^s I_{kt}}_{C_{STORAGE}} \\
& + \underbrace{\sum_{k=1}^K f_k z_k + \sum_{k=1}^K \sum_{t=1}^T v_k x'_{kt}}_{C_{RDC}} + \underbrace{W \cdot \sum_{k=1}^K \sum_{l=1}^L \sum_{t=1}^T S_{klt}}_{C_{STOCK-OUT}} \quad (16)
\end{aligned}$$

The linear model is :

$$\min \{ \Phi_{SCMP2S} \}$$

subject to

$$P_t \leq C_t^P \quad (17)$$

$$P_{t-t^{prod}} = \sum_{k=1}^K x'_{kt} \quad (18)$$

$$I_{k,t-1} - I_{k,t} + x'_{k,t-t_k^{deliv}} = \sum_{l=1}^L x_{klt} + \sum_{l=1}^L S_{kl,t-1} \quad (19)$$

$$I_{kt} \leq D_{tot} \cdot z_k \quad (20)$$

$$x_{klt} + S_{klt} = D_{l,(t+t_{kl}^{ev})} y_{kl,(t+t_{kl}^{ev})} \quad (21)$$

$$x_{klt}^{delay} = S_{kl,t-1} \quad (22)$$

$$\sum_{l=1}^L x_{klt}^{delay} \leq D_{tot} \cdot z_k \quad (23)$$

$$\sum_{l=1}^L y_{klt} \leq p \cdot z_k \quad (24)$$

$$\sum_{k=1}^K y_{klt} = 1 \cdot D_{kl}^{NNull} \quad (25)$$

$$t_{kl}^{ev} y_{klt} \leq T_l \quad (26)$$

$$I_{k0} = I_k^{begin} \quad (27)$$

$$S_{kl0} = S_{kt}^{begin} \quad (28)$$

$$S_{klT} = 0 \quad (29)$$

$$x_{klt} \geq 0 \quad (30)$$

$$x'_{kt} \geq 0 \quad (31)$$

$$S_{klt} \geq 0 \quad (32)$$

$$I_{kt} \geq 0 \quad (33)$$

$$z_k, y_{klt} \in \{0,1\} \quad (34)$$

where

- $k = 1, \dots, K$  RDC belonging to the second level of the logistic network;  
 $l = 1, \dots, L$  demand point belonging to the third level of the network;  
 $t = 1, \dots, T$  unit period of time along the planning horizon  $T$ ;  
 $x'_{kt}$  product quantity from the CDC to the RDC  $k$  in  $t$ ;  
 $x_{klt}$  on time delivery quantity i.e. product quantity from the RDC  $k$  to the point of demand  $l$  in  $t$ ;  
 $S_{klt}$  product quantity not delivered from the RDC  $k$  to the point of demand  $l$  in  $t$ . The admissible period of delay is one unit of time: consequently, this quantity must be delivered in the period  $t + 1$ ;  
 $x_{klt}^{delay}$  delayed product quantity delivered late from the RDC  $k$  to the point of demand  $l$  in  $t$ . The value of this variable corresponds to  $S_{kl,t-1}$ ;  
 $I_{kt}$  storage quantity in the RDC  $k$  at the end of the period  $t$ ;  
 $P_t$  production quantity in time period  $t$ . It is available after the lead time  $lt^{prod}$ ;  
 $y_{klt}$  1 if the RDC  $k$  supplies the point of demand  $l$  in  $t$ . 0 otherwise;  
 $z_k$  1 if the RDC  $k$  belongs to the distribution network. 0 otherwise;  
 $c'_k$  unit cost of transportation from the CDC to the RDC  $k$ ;  
 $d'_k$  distance from the CDC to the RDC  $k$ ;  
 $c_{kl}$  unit cost of transportation from the RDC  $k$  to the point of demand  $l$ ;  
 $d_{kl}$  distance from the RDC  $k$  to the point of demand  $l$ ;  
 $W$  additional unit cost of stock-out;  
 $c^p$  unit production cost;  
 $c^s$  unit inventory cost which refers to  $t$ . If  $t$  is one week, the cost is the weekly unit storage cost;  
 $f_k$  fixed operative cost of the RCD  $k$ ;

- $v_k$  variable unit (i.e. for each unit of product) cost based on the product quantity which flows through the RDC  $k$ ;
- $D_{lt}$  demand from the point of demand  $l$  in the time period  $t$ ;
- $S_{kl}^{begin}$  starting stock-out at the beginning ( $t = 0$ ) of the horizon of time  $T$ ;
- $I_k^{begin}$  starting storage quantity in RDC  $k$ ;
- $p$  maximum number of points of demand supplied by a generic RDC in any time period;

$$D_{tot} = \sum_{l=1}^L \sum_{t=1}^T D_{lt} \quad \text{total amount of customer demand during the planning horizon } T;$$

- $C_t^P$  production capacity available in  $t$ ;
- $D_{lt}^{NNull}$  1 if demand from the customer  $l$  in  $t$  is not null. 0 otherwise;
- $T_l$  delivery time required by the point of demand  $l$ ;
- $I_t^{prod}$  production lead time;
- $t_k^{deliv}$  delivery lead time from the CDC to the generic RDC  $k$ ;
- $t_{kl}^{ev}$  delivery lead time from the RDC  $k$  to the point of demand  $l$ .

The objective function is composed of various contributions:

1.  $C(CDC-RDC)$ . It measures the total cost of transportation from the first level (CDC) to the second level (RDCs);
2.  $C(RDC-Demand)$ , i.e. the total cost of transportation from the second level (RDCs) to the third level (points of demand);
3.  $C_{PROD}$ , i.e. the total production cost;
4.  $C_{STORAGE}$ , i.e. the total storage cost;
5.  $C_{RDC}$ , first addend: total amount of fixed costs for the available RDCs;
6.  $C_{RDC}$ , second addend: total amount of variable costs for the available RDCs;
7.  $C_{STOCK-OUT}$ , i.e. the total amount of extra stock-out cost. The parameter  $W$  is a large number so that solutions capable of respecting the customer delivery due dates can be proposed.

The more significant constraints are expounded as follows:

- (19) guarantees the conservation of logistic flows to each facility in each period of time  $t$ ;
- (21) states that the product quantity from the RDC  $k$  to the point of demand  $l$  is delivered according to a lead time  $t_{kl}^{ev}$  in order to satisfy the demand of period  $t + t_{kl}^{ev}$ . Stock-outs are backlogged and supplied in the following period;
- (25) guarantees the individual sourcing requirement: if the demand of node  $l$  in  $t$  is not null ( $D_{lt}^{NNull} = 1$ ), only one RDC must serve the point of demand  $l$ ; otherwise ( $D_{lt}^{NNull} = 0$ ) the point of demand  $l$  is not assigned to any facilities;
- (26) ensures that a demand node is only assigned to an RDC if it is possible to carry out the order by the customer delivery due date.

The result of this problem formulation is explained in Fig. 2 (*Decisions* section): daily allocation of logistic requirements, i.e. determination of number of facilities, locations, storage capacities, and allocation of demand of customers (retailers) to retailers (DCs and/or production plants).

## 6.2 Multi-period model with safety stock optimization

The following model extends and improves the previous one by including the optimization of safety stock (SS) at each facility that belongs to the logistic network. The SS is the minimal level of inventory (storage quantity) that a company seeks to have on hand at any unit of time  $t$  in accordance to the uncertainty of customer demand. In particular the SS level depends on the following main factors (Persona et al., 2007):

- customer service level. High levels ask for great quantities of SS levels;
- number and locations of points of demand which are allocated to production/distribution facilities;
- variance of demand at each facility.

The proposed model do not consider deterministic values of customer demand and this choice strongly increases the complexity of the decision problem. In particular, a recursive solving procedure has been properly developed and illustrated by Gebennini et al. (2007).

The new problem formulation is based on a non-linear analytical model capable of optimizing the SS levels within the distribution system, utilizing the notation introduced for the SCMP2S and in the following lines:

$\theta_{kl}$  assumes value 1 if the RDC  $k$  supplies the point of demand  $l$  in any unit time  $t$  which belongs to  $T$ . 0 otherwise;

$\sigma_l^2$  variance of demand at the point of demand  $l$ ;

$\hat{k}$  safety factor to control customer service level;

$\hat{\sigma}_{kl} = t_{kl}^{cov} \cdot \sigma_l$  combined variance at the RDC  $k$  serving the point of demand  $l$ .

The proposed analytical model of LAP with safety stock is:

$$\begin{aligned} \text{Min} \sum_{k=1}^K \left( c'_k d'_k \sum_{t=1}^T x'_{kt} \right) + \sum_{k=1}^K \sum_{l=1}^L \left[ c_{kl} d_{kl} \sum_{t=1}^T (x_{klt} + x_{klt}^{delay}) \right] + \sum_{k=1}^K \sum_{t=1}^T c^p x'_{kt} + \\ + \sum_{k=1}^K \sum_{t=1}^T c^s I_{kt} + \sum_{k=1}^K f_k z_k + \sum_{k=1}^K \sum_{t=1}^T v_k x'_{kt} + \sum_{k=1}^K c^s \cdot \hat{k} \sqrt{\sum_{l=1}^L \sigma_{kl}^2 \cdot \theta_{kl}} + W \cdot \sum_{k=1}^K \sum_{l=1}^L \sum_{t=1}^T S_{klt} \end{aligned} \quad (35)$$

subject to:

$$P_t \leq C_t^P \quad (36)$$

$$P_{t-t^{prod}} = \sum_{k=1}^K x'_{kt} \quad (37)$$

$$I_{k,t-1} - I_{k,t} + x'_{k,t-t^{deliv}} = \sum_{l=1}^L x_{klt} + \sum_{l=1}^L S_{kl,t-1} \quad (38)$$

$$I_{kt} \leq D_{tot} \cdot z_k \quad (39)$$



$$x_{klt} + S_{klt} = D_{l,(t+t_{kl}^{ev})} y_{kl,(t+t_{kl}^{ev})} \quad (40)$$

$$x_{klt}^{delay} = S_{kl,t-1} \quad (41)$$

$$\sum_{l=1}^L x_{klt}^{delay} \leq D_{tot} \cdot z_k \quad (42)$$

$$\sum_{l=1}^L y_{klt} \leq p \cdot z_k \quad (43)$$

$$\sum_{k=1}^K y_{klt} = 1 \cdot D_{kl}^{Null} \quad (44)$$

$$t_{kl}^{ev} y_{klt} \leq T_l \quad (45)$$

$$\sum_{t=1}^T y_{klt} \leq \theta_{kl} \cdot T \quad (46)$$

$$I_{k0} = I_k^{begin} \quad (47)$$

$$S_{kl0} = S_{kl}^{begin} \quad (48)$$

$$S_{klT} = 0 \quad (49)$$

$$x_{klt} \geq 0, x'_{klt} \geq 0 \quad (50)$$

$$x_{klt}^{delay} \geq 0 \quad (51)$$

$$S_{klt} \geq 0 \quad (52)$$

$$I_{kt} \geq 0 \quad (53)$$

$$z_k, y_{klt}, Q_{kl} \in \{0,1\} \quad (54)$$

The objective function (35) minimizes the total network costs, composed of different contributions: transportation cost from the CDC to the RDCs, transportation cost from the RDCs to the points of demand, total production cost, total inventory cost including safety stock costs, fixed and variable costs associated respectively with the location of new facilities and with their working, and finally the total amount of extra stock-out cost.

Eq. (35) includes a non-linear term which represents the SS cost for the generic facility  $k$  in accordance with the following equation which quantifies a contribution to the determination of the variance of demand cumulated in  $k$  and generated by the customer  $l$ :

$$\hat{\sigma}_{kl}^2 = t_{kl}^{ev} \cdot \sigma_l^2 \quad (55)$$

Gebennini et al. (2007) illustrate a recursive procedure based on a linearization of Eq. (35) for the determination of an admissible solution to the non-linear model.

### 6.3 Case study. Multi-period model with SS

The proposed model illustrated in Section 6.2 has been applied to the optimization of the logistic network of the Italian electronics company object of the case study introduced in Section 4. A first scenario of interest, called AS-IS, refers to the availability of the whole set of actual RDCs. It has been used for a comparison with new network configurations based on the optimization of the logistic system (TO-BE scenario).

The obtained optimal solution establishes strategic and operational results such as the number and configuration of RDCs to keep open and the allocation of customer requests to the available RDCs. It is made up of only three RDCs: in Taiwan, USA and Germany. Direct shipments from the CDC to customers are suggested: South Europe, Middle East, North Africa are served directly from Italy. The allocation of demand to each RDC affects the SS levels that depend on both the total demand variance and the service level the company wants to guarantee. Table 2 presents the SS level maintained at each RDC which belongs to the network in the obtained solution: scenarios AS-IS and TO-BE are compared and a

RDC	Safety Stock [tons]			$\Delta\%$
	AS-IS	TO-BE		
Dummy	19	26,5		39%
USA	6,9	6,6		-4%
FR	6,1	closed		-
UK	3,3	closed		-
D	9,7	1,7		-82%
TW	9,1	8,7		-4%
<b>Total SS</b>	<b>54,1</b>	<b>43,6</b>		<b>-19%</b>

Table 2. Safety stock level for RDCs

reduction of the total amount of SSs is achieved by the application of the optimizing procedure. Other tactical results obtained for each time period within the planning horizon  $T$  concern the product flows between CDC and RDCs, the product flows between RDCs and points of demand, the operational inventory levels and the production levels.

Table 3 presents the cost savings obtained by the reduction of the number of RDCs in accordance to the TO-BE system configuration. In particular the obtained savings do not affect negatively the customer service level that is supposed to be constant: the value of  $\hat{k}$  is assumed equal to 2 (i.e. the customer service level is 0.95).

<i>Costs of logistics</i>	$\Delta$ %
Transportation cost (CDC-RDCs)	-48%
Transportation cost (RDCs-points of demand)	34%
<b>Total transportation cost</b>	<b>-9%</b>
<b>Cost of RDCs</b>	<b>-44%</b>
<b>Inventory holding cost</b>	<b>-19%</b>
<b>Safety stock cost</b>	<b>-19%</b>
<b>Total cost of logistics</b>	<b>-11%</b>

Table 3. Logistic cost comparison: AS-IS vs TO-BE

Finally Table 4 presents the percentage of variation in all the cost terms of the objective function (except for the production cost, unchanged in all simulated scenarios) by passing from  $\hat{k}=1$  to  $\hat{k}=3$ , i.e. by incrementing the customer service level, in case of an higher unit inventory cost that makes total inventory holding cost more significant (total inventory holding cost is now 11% of transportation cost if  $\hat{k}=1$ , and 21% if  $\hat{k}=3$ ).

<i>Costs of logistics</i>	$\Delta$ %
Transportation cost (CDC-RDCs)	2.0%
Transportation cost (RDCs-points of demand)	-0.3%
<b>Total transportation cost</b>	<b>0.3%</b>
<b>Cost of RDCs</b>	<b>0.0%</b>
<b>Inventory holding cost</b>	<b>95.9%</b>
<b>Safety stock cost</b>	<b>200.0%</b>
<b>Total cost of logistics</b>	<b>10.7%</b>

Table 4. Logistic costs variations when  $\hat{k}$  passes from 1 to 3.

## 7. Conclusions and further research

This chapter presents original analytical models and supporting decision tools for the optimization of multi-echelon production distribution systems. In particular strategic models and methods have been discussed, applied and compared to tactical and operational approaches and applications. Nowadays industrial and service companies need effective and reliable supporting decision tools for the rapid planning, design, and execution of new production system from a strategic, tactical and operational point of view.

The literature continuously presents original models for product, process, and system design but these models are rarely based on integrated and system-oriented approaches, so future studies need to integrate simultaneous contributions from industrial management, OR, statistics, and IT sciences.

The size of the generic problem rapidly exceeds the computational limits of problem mathematical formulations and the need for local optimization decisions needs to be bypassed by using a reliable, efficient and global cost-based solutions that could be effective for the whole system. For this purpose Manzini et al. (2007b) introduce a supporting decision platform for the simultaneous design and management of a SC system (i.e. a production distribution network). The proposed platform represents the first step towards developing an expert system capable of supporting the integration of planning, design, management, control and optimization activities in a flexible production distribution

system. The proposed tool is composed of strongly interrelated different decision modules. They are based on the application of both optimal mathematical formulations and simulation modelling which are capable of considering stochastic production and distribution processes such as transportation, logistic costing, customer demand, etc.

Further research is needed to develop supporting methodologies for the simultaneous design of products, process, and production distribution systems. How can the global economic impact of the introduction of a new product, a process (e.g. a manufacturing or an assembly technology) or a production system (e.g. flexible manufacturing system) be measured?

Furthermore industrial applications are achieved because the well known computational experiments proposed by several optimal or heuristic approaches in the literature suffer from the limitation of not being comprehensive and/or being unrealistic.

In particular further research on SC and production system planning should follow the direction traced by the development of ERP systems e.g. by providing more affective planning and optimization modules for multi-echelon production/distribution systems.

Finally, further research could take place to develop and apply supporting decision models capable of considering product recovery activities for the purpose of recycling, re-manufacturing, and reuse. These activities are an integral part of reverse logistics and management of product returns. In fact, scarce attention has been paid to how SC decisions and actions will affect other aspects of human life, such as the environment, social justice, and sustainability of natural resources.

## 8. References

- Ambrosino, D. & Scutellà, M.G. (2005). Distribution network design: new problems and related models. *European Journal of Operational Research*, Vol.165, 610-624, ISSN: 0377-2217.
- Byunghak, L. & Cheol-Han, K. (2003) A methodology for designing multi-echelon logistics networks using mathematical approach. *International Journal of Industrial Engineering: Theory Applications and Practice*, Vol.10, 360-366, ISSN: 1072-4761.
- Chan, F.T.S; Chan, H.K. (2005). The future trend on system-wide modelling in supply chain studies. *International Journal of Advanced Manufacturing Technology*, Vol.25, No.7-8, 820-832, ISSN: 0305-0483.
- Chan F.T.S & Chan H.K. (2006). A simulation study with quantity flexibility in a supply chain subjected to uncertainties. *International Journal of Computer Integrated Manufacturing*. Vol.19, No.2, 148-160, ISSN: 0951-192X.
- Cooper, M.C.; Lambert, D.M. & Pagh, J.D. (1997). Supply chain management: more than a new name for logistics. *The International Journal of Logistics Management*, Vol. 8, No. 2, 1-13, ISSN: 0957-4093
- Francis, R.L.; McGinnis, L.F. & White, J.A. (1992). *Facility Layout and Location: an analytical approach*, Prentice Hall, ISBN: 0132992310, New Jersey.
- Gebennini, E.; Gamberini, R.; Manzini, R. & Mora, C. (2007). Multi-period location allocation problem with safety stock optimization, *Proceedings of the 19<sup>th</sup> International Conference on Production Research*, ISBN: 978-956-310-751-7 , Valparaiso, Chile, August 2007.
- Hinojosa, Y; Kalcsics, J.; Nickel, S.; Puerto, J. & Velten S. (2008). Dynamic supply chain design with inventory. *Computers & Operations Research*, Vol.35, 373-391. ISSN: 0305-0548
- Jacobsen, S.K. (1990). Multiperiod capacitated location models. In: *Discrete Location Theory*, P.D. Mirchandani and R.L. Francis (Ed.), 173-208, John Wiley & Sons, ISBN: 0471892335 , New York.

- Keskin, B.B. & Uster, H. (2007). Meta-heuristic approaches with memory and evolution for a multi-product production/distribution system design problem. *European Journal of Operational Research*, Vol.182, 663-683. ISSN: 0377-2217.
- Lambert, D.M.; Cooper, M.C. & Pagh, J.D. (1998). Supply chain management: implementation issue and research opportunities. *International Journal of Logistics Management*, Vol. 9, No. 2, 1-18, ISSN: 0957-4093
- Love, R.F.; Morris, J.G. & Wesolowsky, G.O. (1988). *Facilities Location. Models & Methods*, North-Holland, ISBN: 0444010319, New York.
- Manzini, R.; Ferrari, E.; Persona, A. & Regattieri, A. (2005a). An expert system for the design of a multi-echelon inventory/distribution fulfillment system. *Proceedings of the 18<sup>th</sup> International Conference on Production Research*, ISBN: 88-87030-96-0, Salerno, Italy, August 2005.
- Manzini R.; Ferrari E.; Gamberi M.; Persona A. and Regattieri A. (2005b) Simulation performance in the optimization of the supply chain. *International Journal of Operations & Production Management*. Vol.16, No.2, 127-144, ISSN: 0144-3577.
- Manzini, R.; Gamberi, M. & Regattieri, A. (2006). Applying mixed integer programming to the design of a distribution logistic network. *International Journal of Industrial Engineering: Theory Applications and Practice*, Vol. 13, No. 2, 207-218, ISSN 1072-4761.
- Manzini, R. & Gebennini E. (2007a). Optimization models for the dynamic facility location and allocation problem. *International Journal of Production Research*. DOI: 10.1080/00207540600847418, ISSN 1366-588X online.
- Manzini, R.; Gamberi, M.; Gebennini, E. & Regattieri, A. (2007b). An integrated approach to the design and management of supply chain system. *International Journal of Advanced Manufacturing Technology*. DOI: 10.1007/s00170-007-0997-9, ISSN: 0305-0483.
- Monfared, M. A. S. & Yang, J. B. (2007). Design of integrated manufacturing planning, scheduling and control systems: a new framework for automation. *International Journal of Advanced Manufacturing Technology*, Vol.33, 545-559. ISSN: 0305-0483.
- Ng, W.K.; Piplani, R. & Viswanathan, S. (2003). Simulation workbook for analyzing multi-echelon supply chains. *Integrated Manufacturing Systems*. Vol.14, No.5, 449-457, ISSN: 0957-6061.
- Persona, A.; Battini D.; Manzini R. & Pareschi, A. (2007) Optimal safety stock levels of subassemblies and manufacturing components. *International Journal of Production Economics*, Vol. 110, No.1-2, 147-159. ISSN: 0925-5273.
- ReVelle, C.S.; Eiselt, H.A. & Daskin, M.S. (2008). A bibliography for some fundamental problem categories in discrete location science. *European Journal of Operational Research*, Vol.184, 817-848. ISSN: 0377-2217.
- Sahin, F. & Robinson, E. (2002). Flow coordination and information sharing in supply chains: review implications and directions for further research. *Decision Sciences*. Vol.33, No.4, 505-536, ISSN: 0011-7315.
- Samaranayake, P. & Toncich, D. (2007). Integration of production planning, project management and logistic systems for supply chain management. *International Journal of Production Research*, Vol.45, No.22, 5417-5447.
- Santoso T.; Ahmed S.; Goetschalckx M. & Shapiro A. (2005). A stochastic programming approach for supply chain network design under uncertainty. *European Journal of Operational Research*, Vol.167, 96-115, ISSN: 0377-2217.
- Shen, Z-J M. (2005). A multi-commodity supply chain design problem. *IIE Transaction* Vol.37, 753-762, ISSN: 0740-817X.
- Snyder, L.V. (2006). Facility location under uncertainty: a review. *IIE Transactions*, Vol. 38, 537-554. ISSN: 0740-817X.
- Sule, D. R. (2001). *Logistics of Facility Location and Allocation*, Marcel Dekker Inc., ISBN: 0824704932, New York.
- Vokurka, R. & Lummus, R. (2000). The role of just-in-time in supply chain management. *International Journal of Logistics Management*, Vol. 11, No. 1, 89-97, ISSN: 0957-4093



## **Supply Chain**

Edited by Vedran Kordic

ISBN 978-3-902613-22-6

Hard cover, 568 pages

**Publisher** I-Tech Education and Publishing

**Published online** 01, February, 2008

**Published in print edition** February, 2008

Traditionally supply chain management has meant factories, assembly lines, warehouses, transportation vehicles, and time sheets. Modern supply chain management is a highly complex, multidimensional problem set with virtually endless number of variables for optimization. An Internet enabled supply chain may have just-in-time delivery, precise inventory visibility, and up-to-the-minute distribution-tracking capabilities. Technology advances have enabled supply chains to become strategic weapons that can help avoid disasters, lower costs, and make money. From internal enterprise processes to external business transactions with suppliers, transporters, channels and end-users marks the wide range of challenges researchers have to handle. The aim of this book is at revealing and illustrating this diversity in terms of scientific and theoretical fundamentals, prevailing concepts as well as current practical applications.

### **How to reference**

In order to correctly reference this scholarly work, feel free to copy and paste the following:

Riccardo Manzini and Rita Gamberini (2008). Design, Management and Control of Logistic Distribution Systems, Supply Chain, Vedran Kordic (Ed.), ISBN: 978-3-902613-22-6, InTech, Available from: [http://www.intechopen.com/books/supply\\_chain/design\\_\\_management\\_and\\_control\\_of\\_logistic\\_distribution\\_systems](http://www.intechopen.com/books/supply_chain/design__management_and_control_of_logistic_distribution_systems)

**INTECH**  
open science | open minds

### **InTech Europe**

University Campus STeP Ri  
Slavka Krautzeka 83/A  
51000 Rijeka, Croatia  
Phone: +385 (51) 770 447  
Fax: +385 (51) 686 166  
[www.intechopen.com](http://www.intechopen.com)

### **InTech China**

Unit 405, Office Block, Hotel Equatorial Shanghai  
No.65, Yan An Road (West), Shanghai, 200040, China  
中国上海市延安西路65号上海国际贵都大饭店办公楼405单元  
Phone: +86-21-62489820  
Fax: +86-21-62489821

© 2008 The Author(s). Licensee IntechOpen. This chapter is distributed under the terms of the [Creative Commons Attribution-NonCommercial-ShareAlike-3.0 License](https://creativecommons.org/licenses/by-nc-sa/3.0/), which permits use, distribution and reproduction for non-commercial purposes, provided the original is properly cited and derivative works building on this content are distributed under the same license.

IntechOpen

IntechOpen