

Research Article

Open Access

Salvatore Brischetto*, Alessandro Ciano, and Carlo Giovanni Ferro

A multipurpose modular drone with adjustable arms produced via the FDM additive manufacturing process

DOI 10.1515/cls-2016-0016

Received May 20, 2016; accepted May 21, 2016

Abstract: The present paper shows an innovative multi-rotor Unmanned Aerial Vehicle (UAV) which is able to easily and quickly change its configuration. In order to satisfy this feature, the principal structure is made of an universal plate, combined with a circular ring, to create a rail guide able to host the arms, in a variable number from 3 to 8, and the legs. The arms are adjustable and contain all the avionic and motor drivers to connect the main structure with each electric motor. The unique arm design, defined as all-in-one, allows classical single rotor configurations, double rotor configurations and amphibious configurations including inflatable elements positioned at the bottom of the arms. The proposed multi-rotor system is inexpensive because of the few universal pieces needed to compose the platform which allows the creation of a kit. This modular kit allows to have a modular drone with different configurations. Such configurations are distinguished among them for the number of arms, number of legs, number of rotors and motors, and landing capability. Another innovation feature is the introduction of the 3D printing technology to produce all the structural elements. In this manner, all the pieces are designed to be produced via the Fused Deposition Modelling (FDM) technology using desktop 3D printers. Therefore, an universal, dynamic and economic multi-rotor UAV has been developed.

Keywords: Unmanned Aerial Vehicle; multi-rotor; adjustable box shaped arms; 3D printing; Fusion Deposition Modelling

*Corresponding Author: **Salvatore Brischetto:** Department of Mechanical and Aerospace Engineering, Politecnico di Torino, corso Duca degli Abruzzi, 24, 10129 Torino, Italy; Email: salvatore.brischetto@polito.it; Tel: +39.011.090.6813; Fax: +39.011.090.6899

Alessandro Ciano, Carlo Giovanni Ferro: Department of Mechanical and Aerospace Engineering, Politecnico di Torino, Turin, Italy



© 2016 S. Brischetto *et al.*, published by De Gruyter Open. This work is licensed under the Creative Commons Attribution-NonCommercial-NoDerivs 3.0 License.

1 Introduction

The use of drones or Unmanned Aerial Vehicles (UAVs) in commercial and industrial applications has an enormous and unexplored potential which could completely change the society and the industry [1], [2]. Nowadays, aerospace research is developing new UAVs that can solve the so called 3D problems (Dangerous, Dirty and Dull problems) [3] as the drones showed in [4]-[7]. The idea proposed in [8] is an innovative and cost-effective solution to help the end-user (photographers, film-makers, surveillance agencies and so on) in the applications of drones in their fields. Therefore, a universal, dynamic and low-cost platform has been designed. One of the innovative proposed solutions is the central plate able to fit a variable number of arms and legs. Such adjustable arms allow different configuration layouts. They are designed to be a *plug-and-play* system which self-contains avionic, motors and propellers to independently work when connected to the main frame. For this main reason, the described arms are defined as all-in-one. The idea allows an optimization of the production process because several configurations can be obtained simply changing the number and type of arms and components.

In the literature and on market, several types of multi-rotor are proposed. They show different configurations depending on the number of arms and rotors and on the amphibious capabilities. Although some solutions are interesting, e.g., the recharging system in [9], different drones must be purchased for different mission profiles and subsequently applications. A dynamic and universal multi-copter as the one here presented could be proposed as a self-building kit composed by 8 parts also comprising an universal central plate and a variable number of all-in-one arms. The possible configurations vary from 3 to 8 arms. There is the possibility of a single rotor per arm, double rotors per arm or the amphibious configuration with a rotor at the top of the arm and an inflatable element at the bottom of the arm able to allow a landing on open water or the shock absorption for hard landings. Moreover, the



Figure 1: Top and bottom view of the classic excopter configuration.

arms are also telescopic and adjustable. They can be extended in the case of hexacopters and octocopters to avoid the contact between the propellers without changing the propeller dimensions. In this way, a single UAV is able to accomplish different missions. One of the main aim of the present work is the use of the 3D printing for UAV applications. The task is to have a low-cost flying vehicle that everyone can produce taking advantages from the mechanical properties and the low mass density of FDM parts [10]. For this reason, all the pieces are designed for the Fused Deposition Modelling (FDM) additive manufacturing [11], [12].

The proposed kit is made by only 8 different pieces which are combined together in various numbers and positions to complete a multi-copter able to satisfy all the missions under 2 kilograms of maximum take-off weight. This choice has been taken to comply with the UAV national regimentation [13] due to the increasing perception among the population of the risk connected with drones [14].

The production of only 8 different pieces with a FDM printer is low-cost. In particular, if this feature will be translated in large scale, the advantages from the economical point of view will be more clear. The materials have been selected from the FDM literature: the PLA (PolyLactic Acid) [15], [16] and the ABS (Acrylonitrile Butadiene Styrene) [17], [18]. Both materials have several advantages

and disadvantages. ABS is lighter with higher performance requirements. PLA is easier to be printed and it is a 100% biodegradable material. This last feature could make the described drone platform as completely eco-green. Figure 1 gives a top and a bottom view of one of the several possible drone configurations: a six arm UAV with single propeller for each arm. A first prototype made of PLA and full 3D printed via the FDM technology has been exhibited at the Salone Internazionale del Libro di Torino [19] using the name PoliDrone.

1.1 UAV literature overview

On the market, there are several types of multi-rotor UAV. They differ for configurations, type of missions, dimensions and employed materials. An interesting patent is that indicated in [20] where the drone is constituted by a central perforated circular frame without arms. Motors and propellers are variable in number and they can be positioned in several holes to obtain different configurations. This solution is interesting but the proposed drone is not modular, it has not any arms, and it does not allow the amphibious configuration. The Lily drone [21] has a curved cover structure similar to the present drone but it is a simply quadrotor flying camera able to follow the detector in order to make high-quality videos. On the web site marketwired.com [22], a eight arm multi-rotor for different purposes is presented. However, it is not able to change directly and easily its layout after the purchase. The patent [23] proposes a circular plate connected to an external ring by three sticks where the rotors can be positioned in a variable number but only in a predisposal order. Moreover, the external ring, where the rotors are placed, creates an aerodynamical interference needing more powerful motors. A drone with three arms and two rotors for each arm is proposed in the patent [24]. This structure allows the inclination of the plane where the three arms are located, but it has a restricted flexibility. A similar application can be found in the patent [25] where a quadrotor structure, which can be positioned at different angles, is proposed. This structure has a restricted flexibility too. All the technical solutions described above do not exhibit modular capabilities and, in particular, they do not allow the use of the drone in a flexible manner. Moreover, these solutions are neither multipurpose nor amphibious, and they do not have full protection and interchangeability of payload. All these features are typical of the innovative drone proposed in the present paper. The patent [26] describes a multi-rotor drone with foldable handles for easy transport. The attachment system is constituted by

a hinge that allows the arm to assume the flight position or the rest position when the UAV is not used. An appropriate hook allows to lock the arms in the desired position. On the web site of the magazine "Volo Sportivo" [27], a modular multi-rotor drone is shown. It starts from a basic single rotor unit which can be connected to other single rotor units depending on the proposed mission. In particular, the coupling between the various base units is via appropriate magnets. However, the technical solutions described above have the major drawback of not allowing different configurations from those provided and, in particular, they do not allow the amphibian configuration. Furthermore, these solutions have not absolute and total modularity for all their elements (structural, avionics and electrical parts) and they require electronic and system knowledge bases to be able to properly assemble the available elements.

There are also drones which are capable of landing on uneven surfaces, an example of such drones is proposed in the patent [28] where the structural fixed part of a quadrotor drone allows the shock absorptions. In the patent [29], the drone structure is constituted by two counter-rotating motors having a protective structure to improve the safety in the case of emergency landings. However, the technical solutions described above exclude the modularity and they do not allow the amphibious configurations. Moreover, they are not multipurpose solutions and they do not provide absolute protection and interchangeability of the payload.

A further interesting application concerns the amphibious drones. Examples of such amphibious configurations are described in the patent [30], they are able to fly and to move in the water as a sort of submarine. It moves in the air and in the water thanks to the variation of the inclination of the head, arms and the relative ends. This amphibious drone has a fixed configuration with three rotors and three arms, and it allows movements in the water. This drone is also equipped with a parachute in case of emergency. An other amphibious application is described in the patent [31] where the drone is equipped for both the flight and the flotation. On the website indicated in [32], a quadcopter drone is presented, it is able to take off from a ship and it provides assistance to persons at sea. This drone is equipped with a number of life buoys positioned below and around the main structure, and it appears to be as a large transportable life-saving buoy. On the website indicated in [33], the quadcopter "LOTUS" is presented. It is able to ditch and move on the water thanks to fixed floatings on the four sides; these fixed elements can constitute a problem for the aerodynamic and stability. Moreover, it does not have any protection for emergency landings.

However, the technical solutions described above exclude the modularity because a modular drone usually loses the insulation and watertight characteristics of the structure. Such solutions are not multipurpose and they have not a variable number of rotors and motors.

None of the prior technical solutions considered and commented above solve the problem of providing a main universal structure able to accommodate a variable number of arms arranged in different positions with the possibility of including for each arm a single rotor, double rotors or rotor + inflatable element. Moreover, none of the prior technical solutions solve the problem of providing a modular drone capable of landing on different surfaces comprising rough terrains and water, avoiding structural, avionic, electric and propulsive damages. Finally, none of the prior technical solutions solve the problem of providing a multi-function and multipurpose drone able to carry a generic payload which can be represented, for example, by a classical or a thermal camera or by any other sensor or element depending on the specific task to fulfill. At present, despite the considerable technological developments and the variety of uses, it remains difficult to choose the right multi-rotor for a given mission. A great problem is often the necessity to purchase a new platform to accomplish several missions different from those for which the drone was initially bought. Important features are the possibility to easily and quickly change the configuration and also the possibility to consider amphibious drones which can be stabilized in the water or can be protected from possible emergency landings on the mainland. These drones must also be equipped for the insulation of the avionics, propulsion unit and payload from the external severe environment.

2 Architecture of the drone

The most important feature of this innovative UAV is its modularity which gives to the user a structure composed by a kit of only eight different components. The core of the modularity is the central plate, shown in Figure 2, with enumerate holes organised in couples where the tightenings of the arms are placed. The instructions for the different configurations are detailed in Table 1. The first column indicates the chosen number of arms (from 3 to 8) for classic, double rotors (X or Y) and amphibious (A) configurations, the second column gives the holes of the central plate to be used. For each defined number of arms, three different configurations are possible: single rotor at the top of the arms, double rotor mode with a rotor at the top of the arms and a second rotor at the bottom of the arms, am-

Table 1: Number of arms and numeration of the holes to use for the several possible configurations.

Number of arms (Configurations)	Numeration for holes of the central plate
3 (3 - A3 - Y6)	5 - 12 - 19
4 (4 - A4 - X8)	1 - 7 - 12 - 17
6 (6 - A6 - X12)	1 - 5 - 9 - 12 - 15 - 19
8 (8 - A8 - X16)	1 - 4 - 7 - 11 - 12 - 13 - 17 - 20

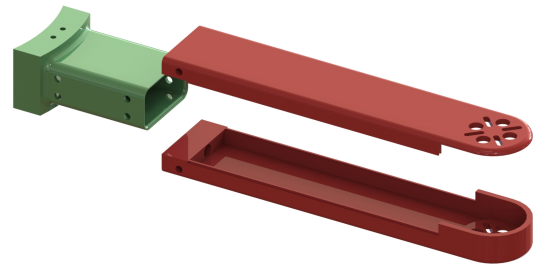

Figure 4: Box shaped arm and telescopic mechanism.

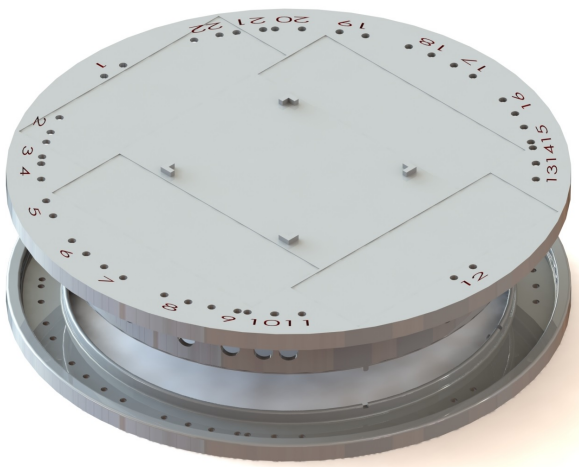

Figure 2: Central plate and ring with numeration of the holes.

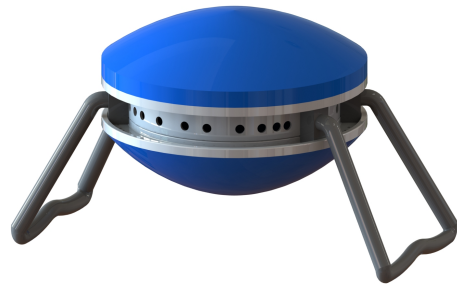

Figure 5: Description of the cover systems used for the drone.

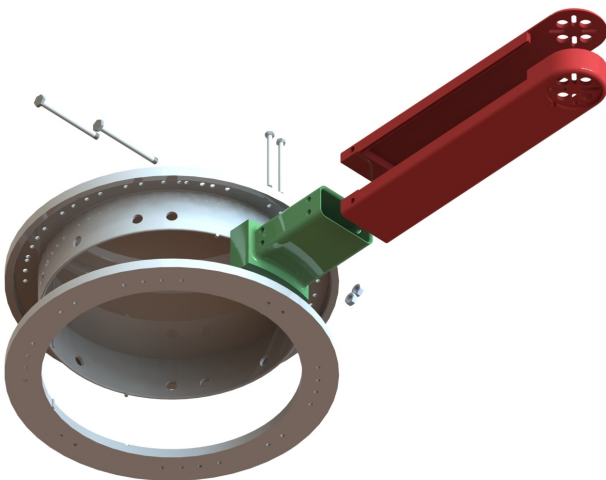

Figure 3: Assembling procedure for the different drone components.

prohibited with a rotor at the top of the arms and an inflatable element at the bottom of the arms. The plate described in Figure 2 has the upper side used to house the main

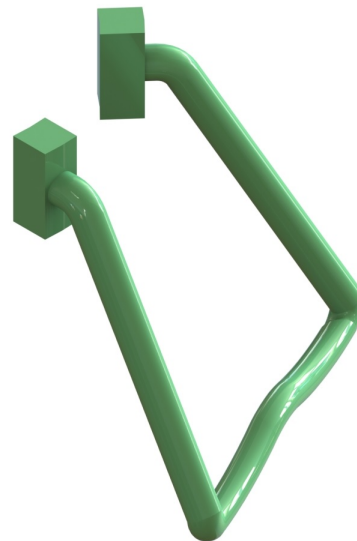

Figure 6: Detailed description of the leg to include in the rail.

electronics such as the Flight Control Unit (FCU), batteries, GPS antenna, gyroscopes and other avionic systems. The ring is used to close the plate to create a rail where the arms and legs are located. The ring has the same numeration used for the circular plate (see Figure 2). Figure 3

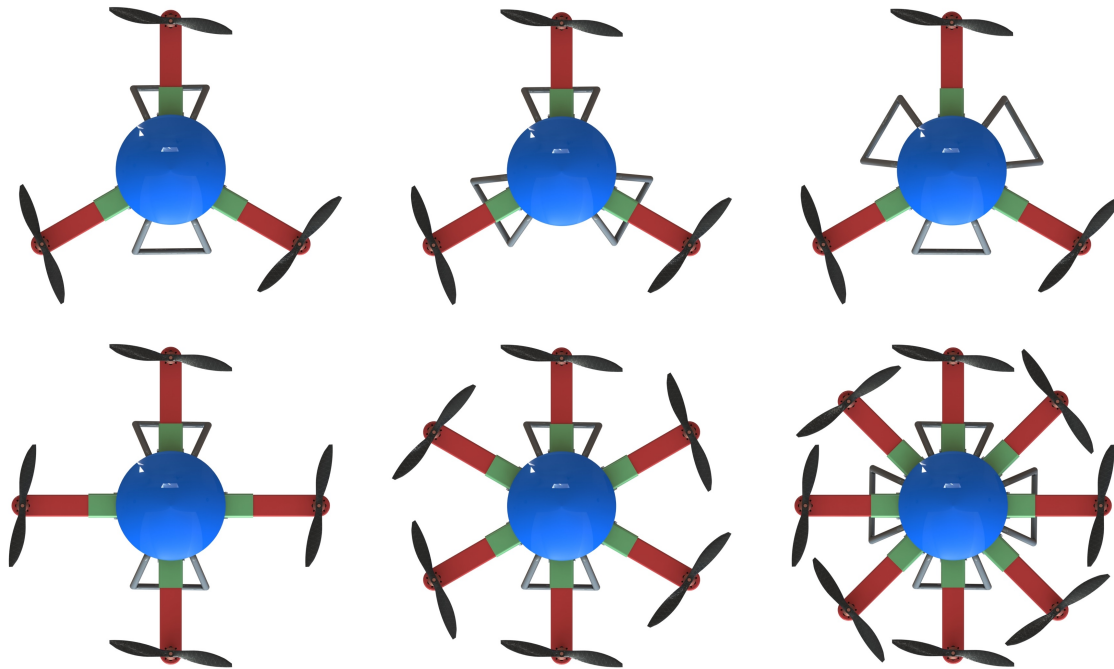

Figure 7: Several leg inclusions depending on the chosen configuration.

shows the assembling procedure for the circular plate, the ring, the supports and the box shaped arms. Figure 4 explains in details how the box shaped arm is composed. It is made by two single parts, the top one and the bottom one, which create a box able to host all the necessary electronics and avionics for the chosen configuration. The arm goes inside the connector and then in the rail. In Figures 3 and 4, it is also explained the telescopic mechanism of the arms which are adjustable in length. As shown in Figure 5, the cover is made by two curved structures. The top cover has the function of protecting the main electronics and reducing the multi-rotor aerodynamic drag. The bottom cover has three major functions: payload protection, aerodynamic improving and allow the structure to float in case of ditching. Figure 6 shows the employed leg. It is designed to be directly included in the rail giving the possibility to the user to choose the number and the position of legs. Figure 7 shows several possibilities for the positioning of the legs depending on the chosen drone configuration.

All the parts of the kit are designed to be produced via a desktop 3D printer. Therefore, the maximum size must be inscribed in a 250 millimeters square [34]. These 8 pieces can be combined in various numbers and positions to complete a specific configuration:

1. Basic pieces (one in all configurations):
 - Central plate

- Ring
- Top cover
- Bottom cover

2. Variable number pieces (in the same number of the chosen arms):

- Connector
- Top box arm
- Bottom box arm

3. Legs (two or more depending on the drone configuration).

In the cases of 3, 4, 6 and 8 arm drone configurations, the basic pieces do not change while the number of connectors, top and bottom box arms are equal to the number of chosen total arms.

A similar classification can also be made for the electronic and propulsive elements:

1. Basic electronics/avionics (one in all configurations):

- Flight Control Unit
- Batteries
- Gyroscopes
- GPS antenna

2. Variable number of electronics/avionics (based on the number of the chosen arms):

- Motor



Figure 8: Electronic and avionic elements in the arm for the single rotor configurations.

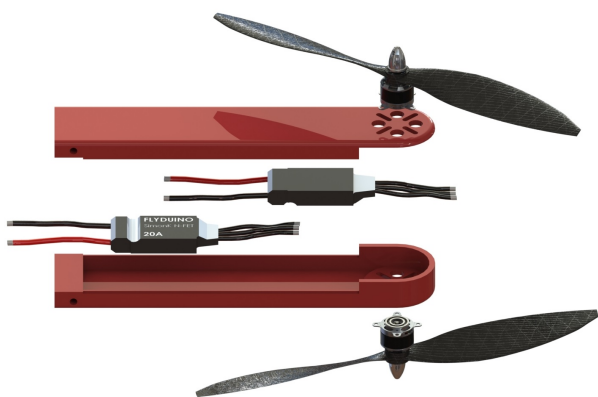

Figure 9: Electronic and avionic elements in the arm for the double rotor configurations.

- Propeller
- Electronic Speed Controller (ESC)

Combining the electronics, it is possible to create different configurations, with attention for the amphibious ones. In these last cases, an inflatable element is added in place of the second motor creating an assistance for the stability of the platform in case of ditching or a protection in case of emergency landing.

The following list shows how to combine the various electronics/avionics in each arm for the different configurations:

1. Single rotor configuration as shown in Figure 8:
 - 1 Motor per arm
 - 1 Propeller per arm
 - 1 ESC per arm
2. Double rotor configuration as shown in Figure 9:
 - 2 Motors per arm
 - 2 Propellers per arm

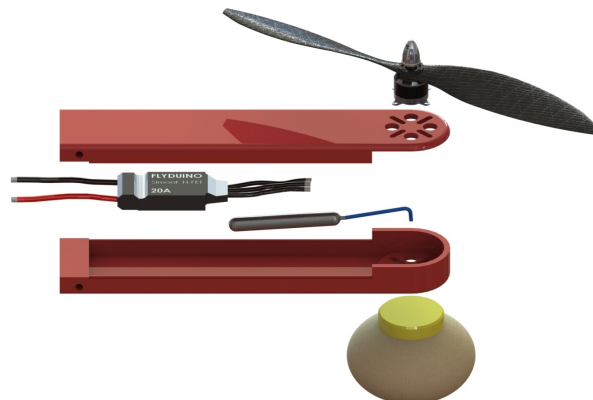

Figure 10: Electronic and avionic elements in the arm for the amphibious configurations.

- 2 ESC per arm

3. Inflatable configuration as shown in Figure 10:

- 1 Motor per arm
- 1 Propeller per arm
- 1 ESC per arm
- 1 Inflatable element per arm
- 1 CO₂ cartridge per arm

The proposed design is innovative for the simplicity of its 8 pieces kit which allows 12 different multi-rotor configurations. Figures 11, 12 and 13 show some of the possible layouts which differ for number of arms, number of rotors per arm and amphibious characteristics. The current developments are dedicated to an onboard Artificial Intelligence (AI) which will autonomously recognize the configuration and adjust the right control and navigation parameters by itself relieving the final user from the possibility of error.

3 3D Printing and FDM technology

Additive Manufacturing is a well-known technology patented firstly in 1984 [35] by the French scientist Alain Le Mehaute. Its distinctive concept is adding material with different methods (powder, wire and so on) instead of subtracting from a raw part. It has been widely introduced in the preliminary and concept design phase thanks to the reduced production cost and realization time of the prototype. In the last years, this technique has been considered also for low scale mass production due to some advantages [12]. Firstly, this technique allows the construction of so-called evolutive shapes: structures of com-



(a) Classic trirotor

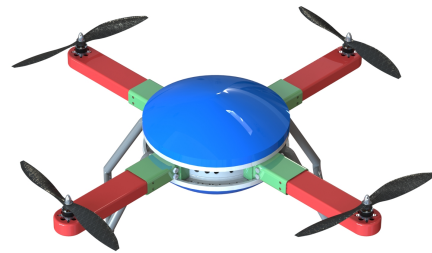

(b) Classic quadrotor



(c) Classic hexarotor

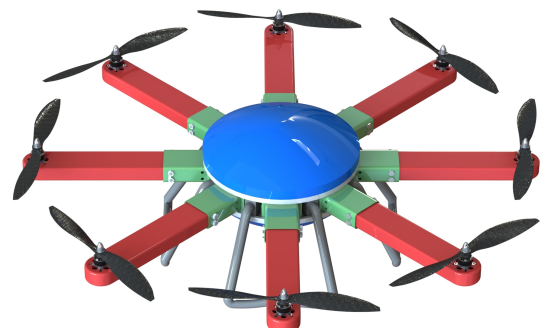

(d) Classic octorotor

Figure 11: Multirotor configurations with single rotor for each arm.



(a) Double Y6 trirotor



(b) Double X8 quadrotor



(c) Double X12 hexarotor

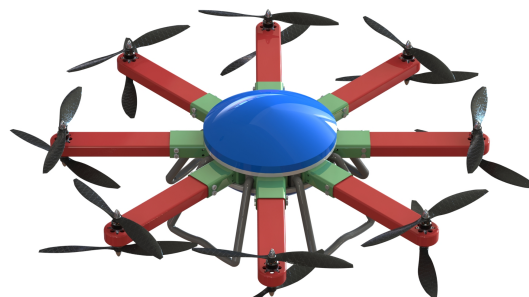

(d) Double X16 octorotor

Figure 12: Multirotor configurations with double rotor for each arm.

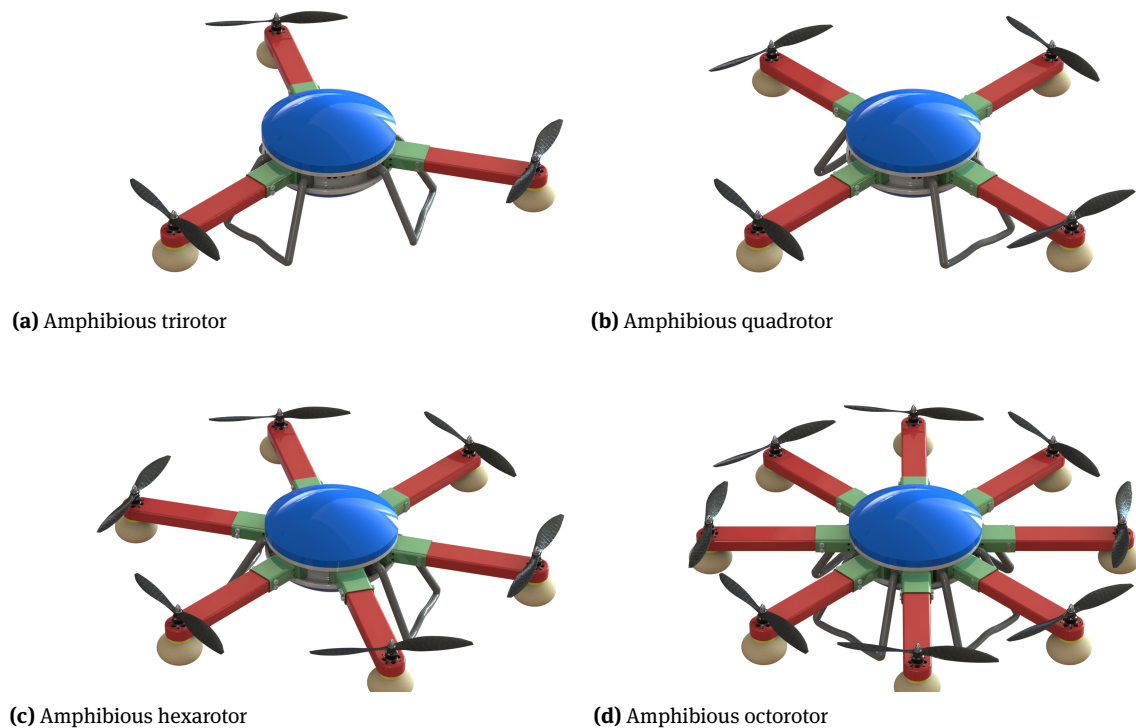

Figure 13: Multirotor configurations with amphibious characteristics and inflatable elements.

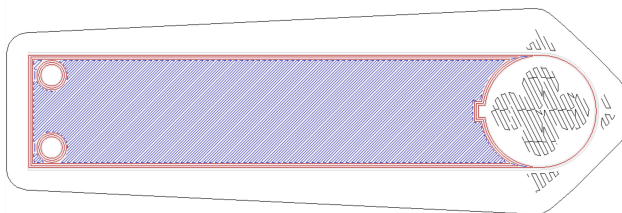

Figure 14: CAM view of the bottom part of the arm with perimeter beads in red, support in black and infill in blue.

plex design that are impossible or difficult to build with traditional milling or machining [36]. Evolutive shapes are usually the result of a topological optimization. Therefore, important mass savings or increasing in the structure mechanical properties are obtained using this resource as reported in [11]. The present work has the ambitious aim to introduce the Desktop 3D Printers, using the FDM technology, in the UAV field. In [37], the authors demonstrated that the process was characterizable as four sigma taking some boundaries of acceptance for mechanical and dimensional behaviour.

FDM is a process which semi-melts a polymeric filament of ABS, PLA or NYLON [38], [39] and then extrudes

it in a XY plane producing a raster of solid material. After a layer is printed, the plate or the extruder moves axially and re-starts the construction process of the next layer. It is clear that with this technique complex shapes are easy to be manufactured with a minimal or no post processing. An anisotropic behaviour is introduced due to the slicing [40]. The manufacturing process starts from a CAD file, where the exact surfaces and volumes are tessellated by a triangulation known as STL (STereo Lithography interface format). This first approximation reduces the quality of the parts [41], [42] with an acceptable error if it is comprised in the order of accuracy of the extrusion process ($\approx 0.5\text{mm}$). With this interface format, the part can be passed as an input at the CAM (Computer Aided Manufacturing) Software [43] (called Slic3r in the present case). This software generates from the STL the sequence of layers and then the machining instructions [44]. The layer height can be varied from 0.1mm to 0.3mm. For each layer, a path is designed and electrical inputs are given to the motor to move the extruder in the XY plane to build rasters with different properties such as width, angle or density. An example of the CAM output for the bottom arm is shown in Figure 14. In this figure, it can be seen that two boundary perimeters (in red) have been designed while the internal core (in blue) is printed in a criss-cross structure with an angle equals

Table 2: FDM parameters selected for the construction of the drone prototype.

Parameters	Value
Layer height [mm]	0.3
Contour number	3
Infill density[%]	80
Angle threshold for support [deg]	10

to 45 degrees. The support structure has been inserted to sustain surfaces and it is reported in black. This support did not start from the platform. Criss-cross filling has been chosen to obtain an orthotropic material: in-plane (directions x and y) parts will have the same mechanical properties. Along the third axis (z direction) properties will be different due to the layered building process. The machine parameters selected for the construction of the UAV are given in Table 2. A layer height of 0.3mm has been chosen as optimum compromise between the accuracy and the printing time. In fact a higher layer value means less accurate curved profiles. This value does not affect aerodynamic features, so it has been considered acceptable. Curved and complicated sections in the plane benefit of the double contour. It exactly follows the STL profile and reproduces the part without the approximation already described for the z direction. Further improvements will be introduced changing the layer height locally during the manufacturing process to improve the quality of the layered structures.

A wide selection of materials are available on market, the most used in Desktop 3D Printers are PLA and ABS. The second material is a very common plastic one which is famous for LEGO® industries. The Desktop 3D Printers are usually used for conceptual prototypes and they are not usually used for design and projects. Thanks to the characterization proposed in [37] and [45], it is possible to use such printers for structural components with promising results. The first flying prototype of Polidrone [8], [19] was designed to be manufactured with PLA filament. This work is the first step towards the design-for-additive approach: thanks to the lesson learned on the dimensional capability performance, new models will be released that will introduce more complex layouts with the aim to produce lighter and efficient structures. On the technical side, hybrid filaments (nylon-carbon) are in program to be tested as reported by the literature [46], [47].

4 Preliminary draft of a four arm configuration

In this section a preliminary draft is proposed. A four arm drone with single rotor per arm is considered as basic configuration [48]. Further configurations will be analyzed in order to obtain a optimization method to find the best configuration for the 12 drone possibilities described in the previous sections. One of the most important parameter is the employed material. The most common choices are PLA or ABS, with different percentages of filling in layered structures. Table 3 shows the weight of each component, when they are made in ABS or in PLA, considering two different percentages of filling (80% and 100%). The last row also gives the total weight of the drone without electronic, avionic and propulsive elements. The volume is known for each element (the number of elements is also known) and the mass density depends on the filling percentage. Using these new information, it is possible to calculate the weight of each element. One of the most important element, due to its dimension, is the central circular plate. Changing the filling percentage, the weight variation of this element can be up to 40 grams. For the classical quadrotor, the following elements must be considered:

- 1 Central circular plate
- 1 Ring
- 1 Top cover
- 1 Bottom cover
- 2 Legs
- 4 Connectors
- 4 Top arms
- 4 Bottom arms

The first column of Table 3 must be multiplied for the number of elements described above. From the above description, it is clear how the number of elements is fundamental in the mass estimation. For example, the change of the density of the material for box shaped arms and relative connectors may lead to a difference up to 40 grams. Taking into account that the configurations varies from 3 to 8 arm there is a global mass variation between 120 and 320 grams.

Taking into account previous studies [49], an infill value of 80% was chosen as the best compromise between mass savings and structural performances. The preliminary design has been conducted using the simulation software eCalc [50] in order to obtain a qualitative evaluation of the flight electronics and avionics. According to the authors, accuracy of this simulator is about 15% for the weight and the electronic system properties.

Table 3: Partial and total weights for the basic configuration of the drone with four arms and four rotors.

Component	Volume [cm ³]	100% PLA [g]	100% ABS [g]	80% PLA [g]	80% ABS [g]
Ring	44.21	56.15	46.43	47.73	39.46
Circular plate	102.32	129.95	107.44	110.46	91.32
Top cover	94.24	119.68	98.95	101.73	84.10
Bottom cover	76.21	96.79	80.02	82.27	68.02
Top arm	27.79	35.29	29.18	30.00	24.80
Bottom arm	32.02	40.67	33.62	34.57	28.58
Connector	27.21	34.55	28.57	29.37	24.28
Leg	60.98	77.45	64.03	65.83	54.42
Tot. Basic config.	787.10	999.62	826.46	849.68	702.49

Table 4: Flight time and thrust-to-weight ratio in relation with the propeller diameter.

Propeller diameter [inch]	13	11	9
Minimum flight time [min]	10.66	10.50	9.62
Minimum mixed flight time [min]	21.60	20.50	17.68
Medium hovering flight time [min]	27.48	25.70	21.74
thrust-to-weight ratio	7.76	6.72	5.65

The most relevant data are shown in Table 4 for a drone in ABS. Different values are proposed changing the propeller diameter. When the diameter increases, the requested revolutions per minute reduces, and consequently the requested power decreases too. Another important factor is the thrust-to-weight ratio. It measures the manoeuvrability of the multicopter: higher values mean faster maneuvers. For this reason, a bigger propeller diameter is useful. A direct consequence of this consideration is the implementation of the adjustable arms in order to avoid the use of smaller propeller diameters in the configurations with 6 or 8 arms.

5 Main characteristics and applications

The proposed UAV contains different innovative ideas. One of them is the kit including only 8 different pieces to compose 12 different configurations. Moreover, the design of

the arms allows to autonomously configure the drones by the user without any specific knowledge of mechanics, electronics or flight control management. Regarding the safety, this vehicle is the first in its category which introduces active measures of damage control using inflatable elements. Therefore, it is ready to fulfill the stringent requirements to fly in critical areas or over groups of persons. This feature allows also the water landing with an increased stability on waves due to the bottom cover design. Moreover, the use of biodegradable materials, such as PLA, together with innovative technologies makes the PoliDrone a lighter UAV and reduces its environment impact. PoliDrone will be tested at Politecnico di Torino as a multipurpose platform for different applications, such as:

- Agriculture (NDVI photogrammetry, control of lands, cultivations and so on)
- Oil and gas applications (inspection of pipelines, air quality in refinery and so on)
- Security (police operations, monitoring, surveillance)
- SAR (search and rescue operations), fire prevention and so on
- Journalism
- Research (volcanos monitoring)
- Recreational activities

6 Conclusions

In this work, the preliminary and innovative design of a multipurpose and modular drone or UAV has been presented and discussed starting from the idea of an universal platform which allows 12 different configurations. In the design approach of the structure, a concurrent process has been adopted to optimize the shape of the parts. The

used technology allows mass savings and structural performance optimizations. An innovative solution is represented by the arms of the UAV. They are defined as all-in-one allowing the vehicle to be used by everyone taking advantages from the Flight Control Unit which self-recognizes the configuration and adapts the flight management system. Further developments will be in the direction of introducing innovative materials for FDM such as carbon fiber composites and the integration of the electronics in the structure by means of conductive filaments directly embedded in the arms.

Acknowledgement: The authors would like to show their gratitude to all the members of the PoliDrone team for their constant support and work.

References

- [1] B. Rao, A.G. Gopi and R. Maione, The societal impact of commercial drones, *Technology in Society*, 45, 83–90, 2016.
- [2] The Drone Economy Moves Beyond Science Fiction, *Forbes, US*, 2015.
- [3] A. Reg, Unmanned Aircraft Systems, *John Wiley and Sons Publication*, London, 2010.
- [4] I.L. Turner, M.D. Harley and C.D. Drummond, UAVs for coastal surveying, *Coastal Engineering*, 114, 19–24, 2016.
- [5] J. Gago, C. Douthe, R.E. Coopman, P.P. Gallego, M. Ribas-Carbo, J. Flexas, J. Escalona and H. Medrano, UAVs challenge to assess water stress for sustainable agriculture, *Agricultural Water Management*, 153, 9–19, 2015.
- [6] D. Ventura, M. Bruno, G.J. Lasinio, A. Belluscio and G. Ardiszone, A low-cost drone based application for identifying and mapping of coastal fish nursery grounds, *Estuarine, Coastal and Shelf Science*, 171, 85–98, 2016.
- [7] J. Zhang, J. Hu, J. Lian, Z. Fan, X. Ouyang and W. Ye, Seeing the forest from drones: testing the potential of lightweight drones as a tool for long-term forest monitoring, *Biological Conservation*, 198, 60–69, 2016.
- [8] S. Brischetto, A. Ciano and A. Raviola, Patent application for industrial invention, *A multipurpose modular drone with adjustable arms*, registered on 5th November 2015 with temporary number 102015000069620.
- [9] A.B. Junaid, Y. Lee and Y. Kim, Design and implementation of autonomous wireless charging station for rotary-wing UAVs, *Aerospace Science and Technology*, 54, 253–266, 2016.
- [10] C.G. Ferro, R. Grassi, C. Seclì and P. Maggiore, Additive Manufacturing Offers New Opportunities in UAV Research, *48th CIRP Conference on Manufacturing Systems 2015*, Procedia CIRP Vol. 4, 1004–1010, 2016.
- [11] B. Vayre, F. Vignat and F. Villeneuve, Designing for Additive Manufacturing, *45th CIRP Conference on Manufacturing Systems 2012*, Procedia CIRP Vol. 3, 632–637, 2012.
- [12] W. Gao, Y. Zhang, D. Ramanujan, K. Ramani, Y. Chen, C.B. Williams, C.C.L. Wang, Y.C. Shin, S. Zhanga and P.D. Zavattieri, The status, challenges, and future of additive manufacturing in engineering, *Computer-Aided Design*, Procedia CIRP, 69, 65–89, 2015.
- [13] Remotely Piloted Aerial Vehicles Issue 2, *Italian rules for Civil UAV and RPV, ENAC, Italy*, 2016.
- [14] R. Clarke and L.B. Moses, The regulation of civilian drones' impacts on public safety, *Computer Law and Security Review*, 30, 263–285, 2014.
- [15] Z. Ortega, M.E. Alemán, A.N. Benítez and M.D. Monzón, Theoretical–experimental evaluation of different biomaterials for parts obtaining by fused deposition modeling, *Measurement*, 89, 137–144, 2016.
- [16] B. Wittbrodt and J.M. Pearce, The effects of PLA color on material properties of 3-D printed components, *Additive Manufacturing*, 8, 110–116, 2015.
- [17] S. Ahn, M. Montero, D. Odell, S. Roundy and P. Wright, Anisotropic material properties of fused deposition modeling ABS, *Rapid Prototyping*, 8, 248–257, 2002.
- [18] D. Croccolo, M. De Agostinis and G. Olmi, Experimental characterization and analytical modelling of the mechanical behaviour of fused deposition processed parts made of ABS-M30, *Computational Materials Science*, 79, 506–518, 2013.
- [19] XXIX Salone Internazionale del Libro, Torino, 12-16 maggio 2016, www.salonelibro.it, accessed on 3rd May 2016.
- [20] Patent for industrial invention, WO2015036907A1, *An improved drone structure*.
- [21] Lily camera, <https://www.lily.camera>, accessed on 3rd May 2016.
- [22] Multirotor by service-drone.com, <http://www.marketwired.com/press-release/multirotor-service-drone-market-leading-developments-in-may-2014-1915272.htm>, accessed on 3rd May 2016.
- [23] Patent for industrial invention, RU2550909C1, *Multirotor convertible pilotless helicopter*.
- [24] Patent for industrial invention, DE102009033821A1, *Aircraft i.e. flight drone, has support arm structure coupled with hull such that support arm structure is movable relative to hull for condition and/or position regulation of aircraft, where hull is stabilized in perpendicular position*.
- [25] Patent for industrial invention, DE102005014949A1, *Multi-rotor helicopter e.g. reconnaissance drone for urban areas, has support frame divided into at least two groups of structures mechanically connected together as such that electrical connection between groups is possible*.
- [26] Patent for industrial invention, KR101456035B1, *The rotor arm device of multi-rotor type drone*.
- [27] Volo Sportivo, Magazine, <http://www.volosportivo.com/2013/07/22/network-drone-flying/>, accessed on 3rd June 2015.
- [28] Patent for industrial invention, FR2995875A1, *Frame for e.g. quadri-rotor type drone, has set of arms, rigidification unit fixed on face of frame, and absorption unit arranged for absorption of shocks is fixed on face of frame opposed to face receiving rigidification unit*.
- [29] Patent for industrial invention, WO2004113166A1, *Gyropter having increased safety*.
- [30] Patent for industrial invention, FR2937306A1, *Amphibious gyropendular drone for use in e.g. defense application, has safety device arranged in periphery of propulsion device for assuring floatability of drone, and upper propulsion device for maintaining drone in air during levitation*.
- [31] Patent for industrial invention, US2013206915A1, *Vertical take-off and landing multimodal, multienvironment, gyropendular*

- craft with compensatory propulsion and fluidic gradient collimation.*
- [32] Personal Drones, <http://www.personal-drones.net/pars-a-rescue-multirotor-drone-that-will-save-lives/>, accessed on 3rd May 2016.
- [33] Diy Drones, <http://diydrone.com/profiles/blogs/x-uav-quadcopter-frame-called-lotus>, accessed on 3rd May 2016.
- [34] T.T. Wohlers, Additive Manufacturing and 3D Printing State of the Industry, Annual Worldwide Progress Report, Wohlers Report, *Wohlers Associates*, Fort Collins Colorado, 2013.
- [35] Patent for industrial invention, FR2567668, *Dispositif pour realiser un modele de piece industrielle*.
- [36] C.G. Ferro, A. Mazza, D. Belmonte, C. Seclì and P. Maggiore, A comparison between 3D Printing and Milling process for a Spar Cap Fitting (wing-fuselage) of UAV Aircraft, *Accepted Abstract for 10th CIRP Conference on Intelligent Computation in Manufacturing Engineering*, 2016.
- [37] C.G. Ferro, S. Brischetto, R. Torre and P. Maggiore, Characterization of ABS specimens produced via the 3D printing technology for drone structural components, *Curved and Layered Structures*, 3, 172–188, 2016.
- [38] P. Dudek, FDM 3D printing technology in manufacturing composite elements, *Archives of Metallurgy and Materials*, 58, 1415–1418, 2013.
- [39] R. Singh and S. Singh, Development of nylon based FDM filament for rapid tooling application, *The Institution of Engineers*, 95, 103–108, 2014.
- [40] S. Raut, V. Kumar, S. Jatti, N.K. Khedkar and T.P. Singh, Investigation of the Effect of Built Orientation on Mechanical Properties and Total Cost of FDM Parts, *3rd International Conference on Materials Processing and Characterisation*, *Procedia Materials Science*, 6, 1625–1630, 2014.
- [41] C.C. Kai, G.G.K. Jacob and T. Mei, Interface between CAD and rapid prototyping systems, *The International Journal of Advanced Manufacturing Technology*, 13, 566–570, 1997.
- [42] K.V. Wong and A. Hernandez, A review of additive manufacturing, *A International Scholarly Research Network, ISRN Mechanical Engineering, Volume 2012, Article ID 208760*, 2012.
- [43] K. Lee, Principles of CAD/CAM/CAE Systems, *Addison-Wesley Longman Publishing Co., Inc.*, Boston, MA, USA 1999.
- [44] A. Ranellucci, Reprap/Slic3r and the future of 3D printing, *Low-cost 3D printings*, ICTP, 75–82, 2013.
- [45] R. Torre, Caratterizzazione materiali e verifiche strutturali per drone multifunzione e multirottore prodotto mediante tecniche di stampaggio 3D, *Master degree thesis in Aerospace Engineering discussed at the Politecnico di Torino*, Turin, Italy, 2016.
- [46] F. Ning, W. Cong, J. Qiu, J. Wei and S. Wang, Additive manufacturing of carbon fiber reinforced thermoplastic composites using fused deposition modeling, *Composites Part B*, 80, 369–378, 2015.
- [47] H.L. Tekinalp, V. Kunc, G.M. Velez-Garcia, C.E. Duty, L.J. Love, A.K. Naskar, C.A. Blue and S. Ozcan, Highly oriented carbon fiber-polymer composites via additive manufacturing, *Composites Science and Technology*, 105, 144–150, 2012.
- [48] M. Mecca, Studio di fattibilità riguardante l'installazione di cella fotovoltaica su un drone, *Bachelor degree thesis in Aerospace Engineering discussed at the Politecnico di Torino*, Turin, Italy, 2016.
- [49] M. Pincini, Caratterizzazione sperimentale di proprietà meccaniche di componenti costruiti mediante fused deposition modeling, *Bachelor degree thesis in Aerospace Engineering discussed at the Politecnico di Torino*, Turin, Italy, 2015.
- [50] Calc, xcopterCalc for Multicopter, www.ecalc.ch, accessed on December 2015.