

Enhancing GMPLS Signaling Protocol for Encompassing Quality of Transmission (QoT) in All-Optical Networks

Filippo Cugini, Nicola Sambo, Nicola Andriolli, Alessio Giorgetti, Luca Valcarengi, Piero Castoldi, Esther Le Rouzic, and Julien Poirrier

Abstract—In this paper, quality of transmission (QoT)-aware lightpath provisioning schemes for transparent optical networks are proposed and assessed. The main idea is to overcome lightpath blocking due to excessive physical impairments (i.e., unacceptable QoT) by means of successive lightpath set up attempts performed by generalized multiprotocol label switching (GMPLS) signaling protocol along alternate routes. The schemes are enabled by the introduction into current GMPLS signaling protocol [i.e., resource reservation protocol with traffic engineering (RSVP-TE)] of extensions which encompass the QoT parameters that characterize the optical layer. Differently from previous approaches, the proposed GMPLS-based schemes are still distributed but they do not imply the introduction of additional extensions into the routing protocol (e.g., OSPF-TE).

The QoT-aware provisioning schemes are first validated by simulations performed on a WDM mesh network. Results show that only few successive set up attempts are required to complete the lightpath establishment. In addition, an experimental demonstration where the proposed RSVP-TE extensions are implemented in the control plane of a transparent metro network is reported showing that impairment-aware lightpath provisioning is achieved on a time scale of few milliseconds.

Index Terms—Crankback, generalized multiprotocol label switching (GMPLS), optical transparent networks, physical impairments, provisioning, resource reservation protocol with traffic engineering (RSVP-TE).

I. INTRODUCTION

CURRENTLY, the end-to-end lightpath provisioning over transparent optical networks (i.e., networks without electronic regeneration at intermediate nodes) is based on generalized multiprotocol label switching (GMPLS) protocols and it assumes that every route, eligible by the routing protocol, is characterized by a satisfactory optical signal quality [i.e., quality of transmission (QoT)]. Indeed the GMPLS protocol suite

does not include any information related to QoT parameters [1]. Thus, transparent optical networks must be planned on a worst-case scenario, i.e., on longest paths, and only transparent networks of limited size are practically achievable. In this study we focus on fully transparent optical networks and the case of translucent networks (i.e., networks composed of transparent nodes equipped with possibly shared regenerators) is left for further detailed investigations [2]. A possible approach for enhancing the GMPLS protocol suite to encompass QoT parameters has been first proposed in [3]. This approach, namely the routing approach (RA), is based on the extension of the GMPLS routing protocol, e.g., the open shortest path first with traffic engineering extensions (OSPF-TE). RA requires additional extensions to flood QoT parameters. Moreover, RA requires, besides the presence of a traffic engineering database (TED) to store bandwidth information, the presence of an additional database in every network node, which is here referred to as QoT parameter database (QPD). The purpose of QPD is to maintain up-to-date local and remote information on QoT parameters concerning each link of the transparent network. Local information (i.e., QoT parameters of the local node and of the attached links) is obtained and included in the QPD by resorting to automatic monitoring and/or management systems [4]. Remote QoT parameters are obtained by exploiting the routing protocol flooding mechanism. In this way, when a request for a new lightpath arrives, the constraint shortest path first (CSPF) algorithm, by resorting to both TED and QPD, is capable of computing a route satisfying both QoS (e.g., bandwidth) and QoT constraints [5]. The main advantage of RA is that it is fully distributed and potentially able to compute effective Traffic Engineering solutions (i.e., engineering lightpath provisioning from both QoS and QoT viewpoints). However, RA suffers from several potential drawbacks. In particular, RA may heavily suffer from QPD inconsistency, scalability and convergence problems particularly in case of frequent link parameter changes [6] or upon failure occurrence. Yet, even though only few paths in a large network have to be avoided because of their unacceptable QoT, each node should manage QoT parameters coming from the whole transparent network. As a consequence, to avoid few impaired routes such as the longest paths, the routing protocol must continuously disseminate all the relevant QoT parameters. Moreover, a multiconstrained path computation is required for achieving both optimal QoS and QoT. This might heavily impact the load of the node's processing unit

Manuscript received November 13, 2007; revised February 6, 2008. Current version published December 19, 2008. This work was supported by the BONE-project ("Building the Future Optical Network in Europe"), a Network of Excellence supported by the European Commission under the 7th ICT-Framework Programme.

F. Cugini is with the Consorzio Nazionale Interuniversitario per le Telecomunicazioni (CNIT), Pisa 56124, Italy.

N. Sambo, N. Andriolli, A. Giorgetti, L. Valcarengi, and P. Castoldi are with the Scuola Superiore Sant'Anna, Pisa 56124, Italy.

E. Le Rouzic and J. Poirrier are with France Telecom RD, Lannion 22113, France.

Color versions of one or more of the figures in this paper are available online at <http://ieeexplore.ieee.org>.

Digital Object Identifier 10.1109/JLT.2008.925674

(CPU), determining large computation time and delaying the lightpath establishment [7]. Therefore, the potential advantages provided by RA seem not to counterbalance the introduced drawbacks. The attempt to standardize RA stopped in 2005 after the informational IETF RFC 4054 [8] without achieving any significant proposal or IETF Internet draft for related OSPF-TE extensions.

In this paper, expanding upon [9], [10] we present a different approach, hereafter addressed as signaling approach (SA), to encompass QoT parameters in the GMPLS protocol suite. SA is based on the enhancement of the GMPLS signaling protocol, e.g., resource reservation protocol with traffic engineering extensions (RSVP-TE). In SA, lightpath routes from source to destination are dynamically computed by exploiting the standard OSPF-TE extensions, i.e., without taking into account QoT parameters. Only during lightpath establishment, the lightpath QoT is dynamically computed through the signaling protocol. QoT is evaluated through an optical signal to noise ratio (OSNR)-based model. The proposed scheme, besides being distributed, does not require extensions to the routing protocol, thus avoiding additional convergence and scalability problems.

In this study, the SA is first assessed through simulations. Results show that, even in the presence of routes not guaranteeing acceptable QoT, the proposed approach successfully establishes lightpaths within few alternate routing set up attempts.

In addition, a laboratory experimental demonstration, in which QoT is evaluated through an equivalent distance (ED)-based model, is reported in the paper. The testbed deploys the proposed GMPLS extensions and demonstrates how the proposed approach can rapidly detect, during the signaling phase, whether lightpaths cannot be set up because of unacceptable QoT.

II. PROPOSED GMPLS SIGNALING APPROACH

The signaling approach (SA) is based on the dynamic estimation of QoT during the signaling phase of the lightpath set up. No extensions are introduced into the OSPF-TE routing protocol which elaborates routes by ignoring QoT parameters. The RSVP-TE signaling protocol is extended to collect the QoT parameter values characterizing every traversed photonic crossconnect (PXC) and fiber link from source to destination.

Five different SA schemes are proposed to collect either cumulated path or individual link QoT information. All SA schemes exploit a novel *QoT Parameter (QP) RSVP-TE subobject* containing the array of supported QoT parameters. Each parameter is carried in a two byte field [Fig. 1(a)].

In the first SA scheme, called *signaling approach with path feedback information (SAP)*, the standard RSVP-TE Path message is extended with a new *Path QoT Parameter (PQP)* object. The PQP object contains a PQP header (4 bytes) and a single QP subobject to account for QoT information cumulated along the path [Fig. 1(b)]. The source PXC, upon CSPF computation, generates an RSVP-TE Path message extended with a PQP object containing the QP subobject that describes the array of QoT parameters of the transmitting interface and of its outgoing link. Every traversed node, before propagating the message, updates the PQP object by modifying the QP subobject

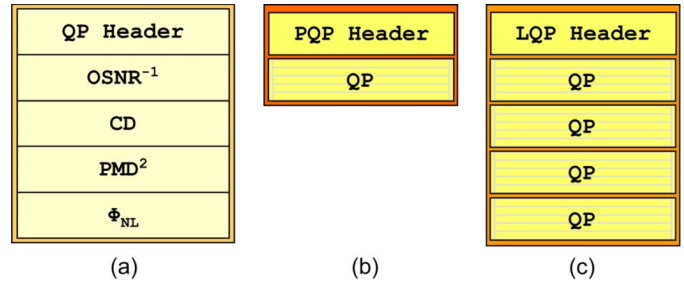

Fig. 1. RSVP-TE novel objects: (a) QP subobject, (b) PQP object, and (c) LQP object.

information. In particular, the updated QP subobject parameter values are obtained by combining the received parameter values with the local intra-node and outgoing link parameter values. Admission control at the destination node compares the overall cumulated values with parameter thresholds. If all the cumulated parameters are within the acceptable range, the lightpath set up request is accepted and an RSVP-TE Resv message is sent back to the source node. Otherwise the lightpath request is rejected and an RSVP-TE PathErr message is sent back to the source node. In this case a small cache memory called history table (HT) is used at the source node to temporarily store, for the duration of the current lightpath set up request, the discovered rejected routes, similarly to RSVP-TE crankback [11]. If the request is rejected, further set up attempts along alternate routes are triggered. The main difference between the crankback and the proposed scheme is the following. In the former, there is a specific point of failure, such as a network link with no available bandwidth which is avoided by the alternate routing. In the latter, there could be no unique point of failure (i.e., impairment effects could be associated with the whole path or with a specific link or node). Alternate routes are computed by selecting equal-cost link-disjoint routes. If no equal-cost link-disjoint routes are available, the maximally link-disjoint one is selected. Successive signaling set up attempts, however, may also fail, excessively delaying the lightpath establishment process.

The second proposed SA scheme is referred to as *signaling approach with path feedback information and history table of rejected routes (SAP-HR)*. SAP-HR extends the SAP scheme by collecting at the source node the history of all previously rejected routes. In SAP-HR, the locally managed HT is not discarded after the successful lightpath establishment. This is allowed also in crankback, where it is an implementation decision whether HT is discarded immediately upon a successful LSP establishment or retained for a longer period. In SAP-HR, HT information is retained until a proper local timeout has expired. HT information is then exploited by successive requests to exclude from the lightpath set up attempts (i.e., no signaling is triggered) routes that previously showed an unacceptable QoT.

The third alternative SA scheme is referred to as *signaling approach with path feedback information and history table of rejected and accepted routes (SAP-HRA)*. SAP-HRA further expands the SAP-HR scheme by collecting in HT not only the previously rejected routes (as in crankback and SAP-HR), but also

the previously accepted routes. In this way, if CSPF identifies the availability of multiple equal cost (shortest) routes, the ones that previously showed unacceptable QoT are excluded while the ones that showed acceptable QoT are first selected for attempting the lightpath establishment.

The fourth alternative SA scheme is referred to as *signaling approach with link feedback information (SAL)*. SAL is proposed to collect individual link information to be used for the estimation of the lightpath QoT. In SAL, instead of resorting to the PQP object, the RSVP-TE Path message is extended with the new RSVP-TE object called *link QoT parameter (LQP)* object [Fig. 1(c)]. In addition, a locally managed *QoT parameter database (QPD)* is present at each node. LQP contains an LQP header (4 bytes) and a vector of QP subobjects, one for each traversed link. Indeed, every traversed node, before propagating the Path message, updates the LQP object by appending the QP subobject describing its own local parameter values (i.e., intra-node and outgoing link parameters). Admission control at the destination node first computes all the collected parameters, and then compares the computed values with given parameter thresholds. As in SAP, if all the computed parameters are within the acceptable range, the path set up request is accepted and an RSVP-TE Resv message is sent back to the source node, otherwise the request is rejected, an RSVP-TE PathErr message is sent back to the source node, and further set up attempts are triggered. In SAL, both the RSVP-TE Resv and PathErr messages are extended with the LQP object containing all the collected QP subobjects describing the traversed route. In this way, each traversed node is able to potentially store, in its local QPD, the QoT parameters of all network links, retrieved by resorting to every transit signaling message carrying QP subobjects. QPD entries are discarded after a local timeout has expired. QPD is then used at the source node to provide a prediction of the cumulated QoT parameters along the computed path. If the predicted value is outside the acceptable range, then the computed path is excluded (i.e., no signaling is triggered) and a different path is considered. On the contrary, if the predicted QoT parameter value is within the acceptable range, the source node starts the signaling phase. Thus, QPD is used similarly to the History Table in SAP-HR. The main difference is that QPD stores individual link information and it is potentially able to be filled more rapidly than HT. Indeed, QPD also stores all the additional individual link information carried by every transit RSVP-TE signaling message. As well as HT, QPD might be incomplete or not up-to-date, thus set up attempts along computed paths might still be rejected due to unacceptable QoT. In this case, as in the previously described SA schemes, further set up attempts following alternative maximally link-disjoint paths are triggered.

The fifth proposed SA scheme is referred to as *signaling approach with link feedback information and preference on acceptable routes (SAL-A)*. SAL-A extends the SAL scheme by exploiting the QPD database not only to exclude routes with excessive physical impairments, but also to provide a preference to routes that show acceptable QoT. Thus, if CSPF computes multiple equal cost (shortest) routes, those that in the QPD database show unacceptable QoT are excluded and those that show acceptable QoT are first selected for attempting the lightpath establishment.

III. QoT PARAMETER OBJECTS AND IMPAIRMENT MODELING

The five proposed SA schemes require an array of QoT parameters (included in the QP subobject) describing either the overall path or the individual link QoT information. Depending on the network scenario, different QoT parameters can be specified with the related methods to compute their cumulated effects [1].

In some cases, such as transparent metro mesh networks based on optical ethernet connections and passive devices (e.g., PXC with no in-line optical amplification), a unique parameter called equivalent distance (ED) could be used in the QP subobject as representative of all detrimental effects due to physical impairments [8]. ED values describing link QoT are cumulated to determine the lightpath feasibility upon comparison to a maximum distance (*MD*) threshold (e.g., $MD = 10$ km for optical ethernet connections based on 1000BaseLX interfaces, $MD = 100$ km for some 1000BaseZX interfaces). In other cases, such as transparent WDM mesh networks deploying active devices (e.g., EDFA) and 10 Gbps optical transponders, even though the utilization of the single ED parameter could be a possible solution to determine the lightpath feasibility (as described in [8]), other approaches potentially allow to better estimate the QoT. In the literature, several models [12]–[22] have been proposed to be utilized in a QoT-aware *distributed* control plane. In this paper, we focus on how to enhance GMPLS control plane with QoT parameters without aiming at discerning the optimal impairment model. Among the available models, all applicable to the proposed SA schemes, in this paper we consider a model similar to the one proposed in [22], [23]. The model peculiarity is to account for some nonlinear effects, i.e., self-phase modulation (SPM), through the nonlinear phase shift parameter denoted by ϕ_{NL} [24]. In our model, optical signal to noise ratio (OSNR) represents the QoT. Beside noise, the modeled impairments are polarization mode dispersion (PMD), chromatic dispersion (CD), and self phase modulation (SPM). All modeled impairments are, respectively, represented by four parameters [carried in the QP subobjects; see Fig. 1(a)] that cumulate linearly: $1/OSNR$, PMD^2 , CD , and ϕ_{NL} .

The admission control at the destination node accepts the lightpath establishment if

- i) cumulated PMD value is within the acceptable range (e.g., below $PMD_{MAX} = 10$ ps);
- ii) cumulated ϕ_{NL} value is within the acceptable range (e.g., below $\phi_{NLMAX} = 1$ rad);
- iii) cumulated OSNR value is above the $OSNR_{th}$ threshold. $OSNR_{th}$ is obtained from the $OSNR_{min}$ value determined by the cumulated CD and ϕ_{NL} values and from the margins specified to account for non modeled impairments (i.e., $OSNR_{th} = OSNR_{min} + Margins$). In particular, $OSNR_{min}$ specifies the minimum OSNR value required by the receiver to obtain a bit error rate (BER) equal to 10^{-3} before FEC (forward error correction codes implemented in the receiver) in presence of given values of CD and ϕ_{NL} . Fig. 2 shows some of the $OSNR_{min}$ values that have been experimentally obtained to derive, through polynomial interpolation, the $OSNR_{min}$ values to be used in the model for any value of CD and ϕ_{NL}

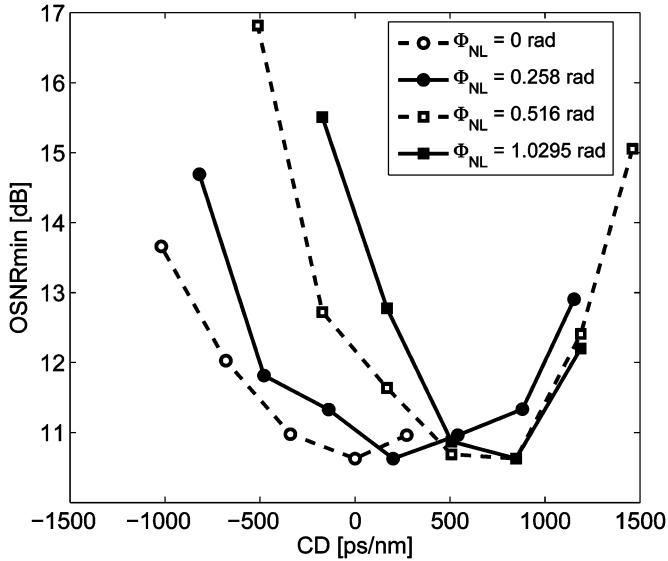

Fig. 2. Minimum required measured OSNR as a function of residual CD and nonlinear phase ϕ_{NL} .

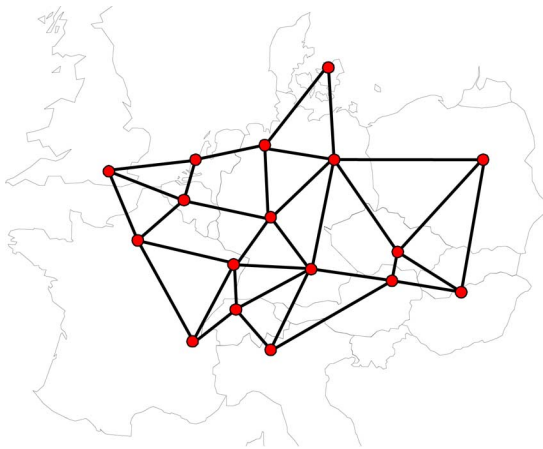

Fig. 3. Network topology.

within the domain of validity of the interpolation. In order to assure the reliability of the model, worst-case margins (e.g., 6 dB) are considered to account for non modeled impairments such as polarization dependant loss, filtering, crosstalk, system ageing and fluctuation, and other non linear effects.

IV. SIGNALING APPROACH NUMERICAL RESULTS

The performance of the five SA schemes are evaluated by means of a C++ event-driven simulator considering the aforementioned OSNR-based model applied to a transparent WDM backbone network. Fig. 3 shows the considered Pan-European topology with 33 bidirectional links, 40 wavelengths per link, 17 PXC's equipped with WDM transponders at 10 Gb/s and a network diameter $D = 5$. Each link consists of a succession of spans with variable length. Each span length is between 61 km and 95 km (resulting from a modeled fiber infrastructure representative of France Telecom infrastructure) and it consists of a single mode fiber (SMF), a dispersion compensating fiber

(DCF) and a double stage amplifier. The PXC architecture introduces two different internal losses, for added/dropped and for pass through channels. PXC outgoing channel powers are equalized. All parameters (QoT and others) utilized in the simulations are shown in Table I.

The considered WDM network represents a realistic worst-case scenario where a large amount of routes present unacceptable QoT. However, at least two link-disjoint paths between any node pair guarantee acceptable QoT. Fig. 4 shows the percentage of shortest routes characterized by unacceptable QoT as a function of the node pair distance in terms of number of hops. In particular, data are expressed with the reference to the network diameter D . Data show that more than 60% of shortest routes traversing D hops are rejected because of unacceptable QoT.

As in the default crankback implementation, in case of unacceptable route, the alternate route is computed and then triggered by the source node and not by an intermediate node. This choice is supported by Fig. 5, in which the amount of alternative routes with acceptable QoT is evaluated as a function of the distance in hops (j) from the path computing node to the source node. In particular, the case of $j = 0$ indicates the amount of all alternate routes with acceptable QoT computed by the source node, while the case of $j = 4$ refers to the amount of all alternate routes with acceptable QoT computed by the penultimate hop node. As expected, Fig. 5 clearly shows that the maximum likelihood to identify a route with acceptable QoT is obtained in case of alternate routing performed by the source node, i.e., $j = 0$. Computation from intermediate nodes potentially reduces set-up delay but it increases rejection probability. For this reason in this paper, all proposed SA schemes, as well as the default configuration of RSVP crankback, are based on alternate routing and successive lightpath set up attempts triggered just by the source node and not by intermediate nodes.

Dynamic behavior of SA schemes has been evaluated by dynamically generating lightpath requests following a Poisson process, and uniformly distributed among each source-destination node pair. All simulation plots include the confidence interval at 95% confidence level.

Figs. 6–10 show the performance of the five proposed SA schemes in terms of percentage of established lightpaths within n set up attempts along alternate routes as a function of the generated lightpath requests. The plotted results are obtained by averaging 100 randomly generated sequences of lightpath requests. The percentage of established lightpaths is computed with a fixed 100 requests observation window. In this set of results, network load is kept limited (a value of 100 Erlang is considered) to have lightpath rejection due exclusively to unacceptable QoT. Results show that all SA schemes successfully establish a percentage of lightpaths higher than 98% at the first set up attempt ($n = 1$). Moreover, apart from SAP, all SA schemes highlight similar performance at the second set up attempt ($n = 2$) and, despite the different implementation complexity, they all guarantee the lightpath establishment within the third set up attempt ($n = 3$). Fig. 6 shows the performance of the SAP scheme. Constant percentages of established lightpaths are achieved for increasing number of lightpath requests because the HT is immediately discarded upon

TABLE I
SIMULATION PARAMETERS

	Parameter	Value	Unit
Fiber SMF	α (attenuation)	0.23	dB/km
	D (dispersion parameter)	17.1	ps/(nm·km)
	D_p (PMD parameter)	0.1-0.35	ps/ $\sqrt{\text{km}}$
	n_2 (non-linear index coefficient)	$2.6 \cdot 10^{-20}$	m^2/W
	A_{eff} (effective area)	80	μm^2
Fiber DCF	α (attenuation)	0.6	dB/km
	D (dispersion parameter)	-92	ps/(nm·km)
	D_p (PMD parameter)	0.19	ps/ $\sqrt{\text{km}}$
	n_2 (non-linear index coefficient)	$3 \cdot 10^{-20}$	m^2/W
	A_{eff} (effective area)	20	μm^2
Amplifier	n_{sp} (spontaneous emission factor)	1.58	
	G (gain)	22	dB
PXC	Add/drop internal loss	14	dB
	Pass through internal loss	18	dB

	Parameter	Value	Unit
Other	Channel power at the beginning of each span	1	dBm
	Signal bit rate (including FEC)	10.7	Gb/s
	C band	1527-1565	nm
	Number of channels	40	
	Modulation Format	NRZ	
	Optical Bandwidth B_o	40	GHz
	Electrical bandwidth B_e	7	GHz
	Margins	PDL	1.5
Filtering		1	dB
Crosstalk		0.5	dB
Aging and fluctuations		2	dB
Other non linear effects		1	dB
Total		6	dB

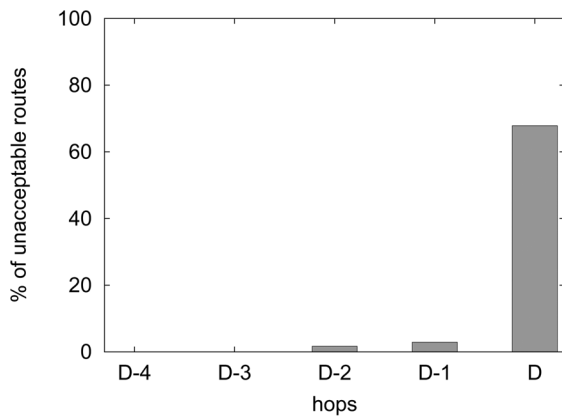

Fig. 4. Percentage of routes with unacceptable QoT as a function of the distance in hops with respect to the network diameter D .

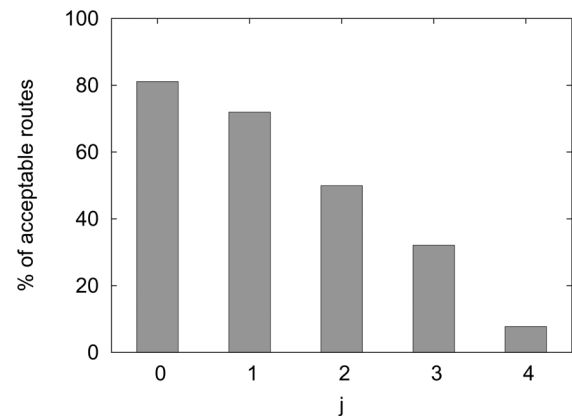

Fig. 5. Percentage of routes with acceptable QoT as a function of the distance in hops j of the path computing node from the source node.

successful lightpath establishment. Figs. 7–10 show the performance of SAP-HR, SAP-HRA, SAL and SAL-A schemes, respectively. Results show that, thanks to the information stored in either HT or QPD, the percentage of established lightpaths already at the first set up attempt increases with the amount of generated requests. The comparison between SAP and SAL schemes (specifically between SAP-HR and SAL and between SAP-HRA and SAL-A) highlights that the percentage increase achieved by the latter is only slightly higher compared to the increase achieved by the former. Detailed analysis on simulation results clarifies that only a minor number of lightpath requests takes advantage of the additional information provided by the LQP objects (and the QPD databases). The reason is that routes rejected because of excessive impairments are mainly the

ones related to lightpath requests between the farthest nodes, which typically traverse at least D hops. When such a request arrives the first time, in case of SAP-HR, no HT entries are already available for that request and signaling attempts on routes not yet explored are required. Similarly, in case of SAL, QPD can hardly provide any useful information because it typically does not contain information for all traversed links yet. As for SAP, signaling attempts on routes not yet fully explored are required. During signaling attempts, both SAP and SAL schemes collect useful parameters that typically exploit in a similar way for successive requests between the same node pair. Thus, the SAP scheme exploiting the lightweight PQP object is able to provide nearly the same good performance as the SAL scheme which is based on individual link information.

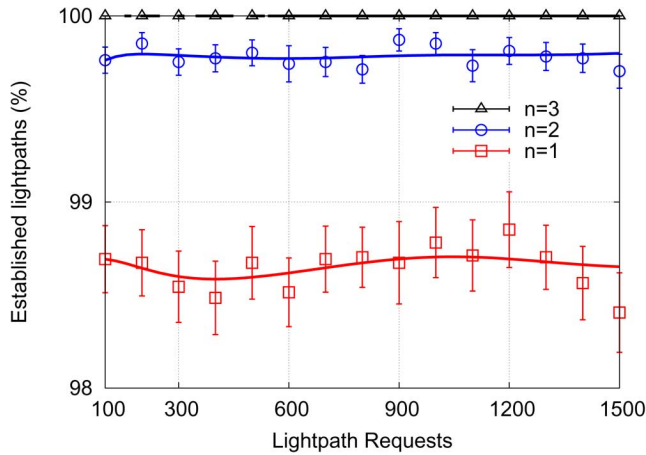

Fig. 6. Percentage of established lightpaths as a function of lightpath requests with SAP scheme.

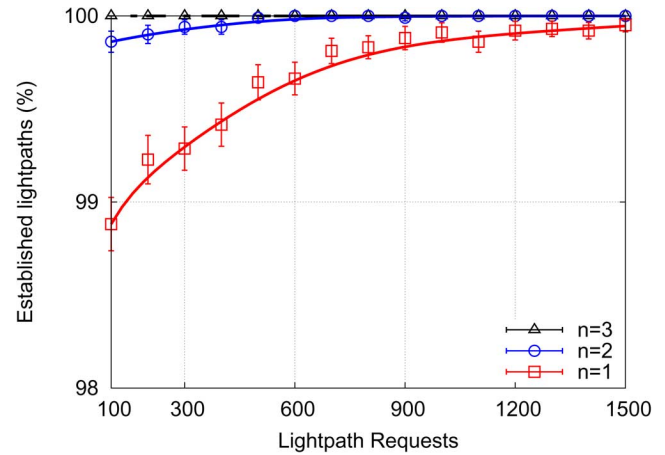

Fig. 9. Percentage of established lightpaths as a function of lightpath requests with SAL scheme.

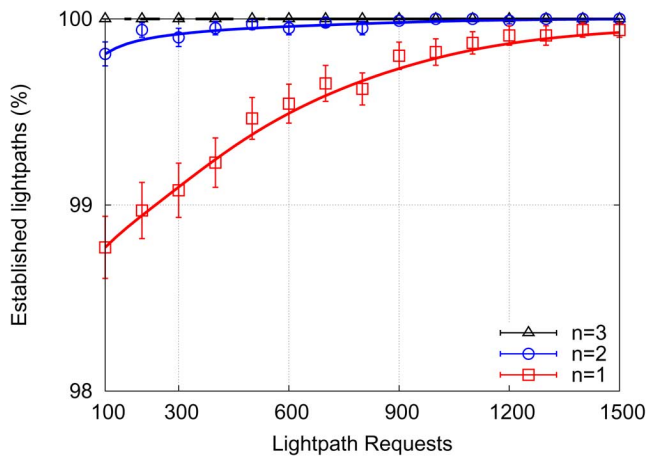

Fig. 7. Percentage of established lightpaths as a function of lightpath requests with SAP-HR scheme.

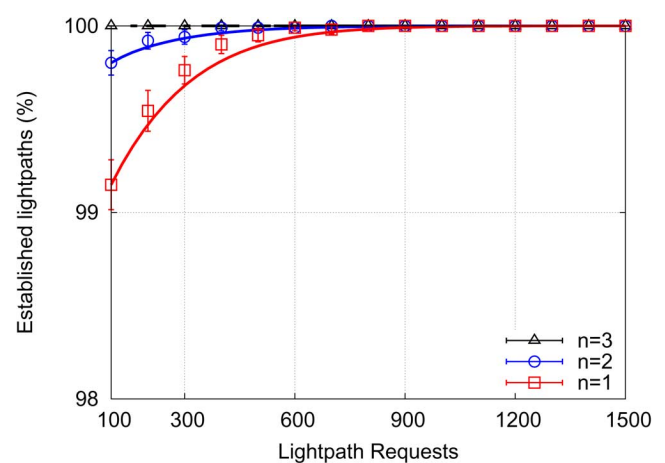

Fig. 10. Percentage of established lightpaths as a function of lightpath requests with SAL-A scheme.

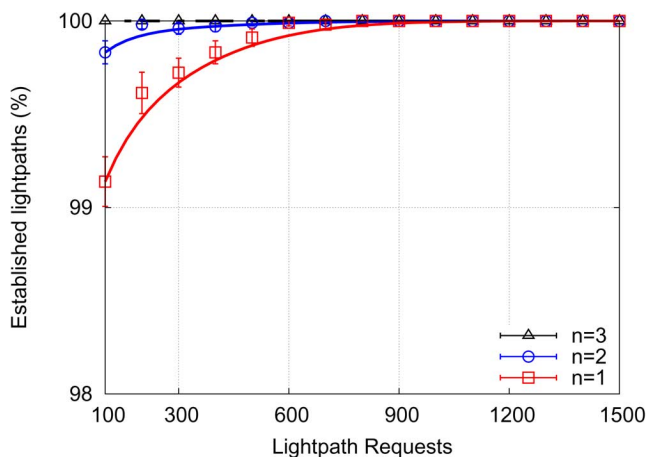

Fig. 8. Percentage of established lightpaths as a function of lightpath requests with SAP-HRA scheme.

Additional considerations can be obtained by the comparison between the percentage of lightpath requests established at the first set up attempt in case of SA schemes exploiting information on rejected routes only (i.e., SAP-HR and SAL) and SA schemes exploiting also information on already accepted routes

(i.e., SAP-HRA and SAL-A). Results show that the percentage increase achieved by the latter is significantly higher than the increase experienced by the former. Indeed, results show that SAP-HRA and SAL-A perform almost the same, limiting the amount of attempts per request along unexplored routes and rapidly achieving the successful lightpath establishment already at the first set up attempt.

In SAP schemes the length of every standard RSVP-TE message has been increased of just 12 bytes (4 bytes for the PQP header and 8 bytes for the four cumulated parameter values). In SAL schemes, the increase in the RSVP-TE message length is proportional to the number of traversed links. In the considered simulations it has been measured in up to 50 bytes (current typical length of RSVP-TE Path messages is in the range between 200 and 300 bytes). As expected, the size of HT and QPD databases remains very limited. In the considered Pan-European WDM network scenario, all HTs remain significantly below the 200 entries while QPD includes up to 33 QP subobjects (33 links).

Figs. 11–15 show the performance of the SA schemes in terms of blocking probability as a function of the network load. Each simulation instance consists of 1500 lightpath requests.

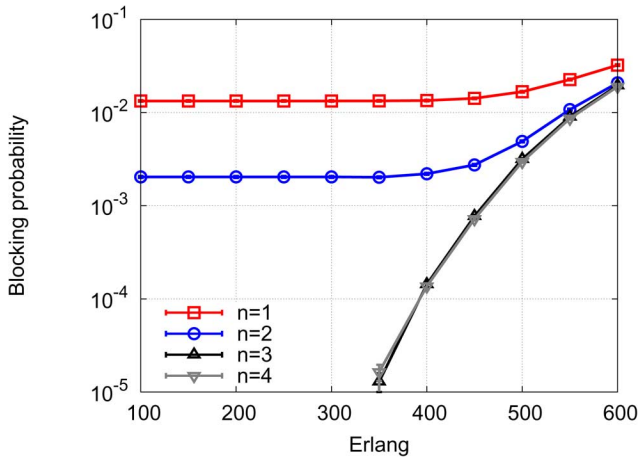

Fig. 11. Blocking probability as a function of the network load with SAP scheme.

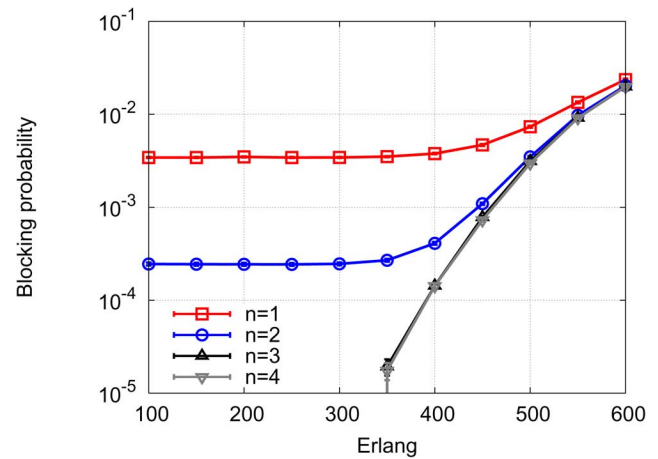

Fig. 14. Blocking probability as a function of the network load with SAL scheme.

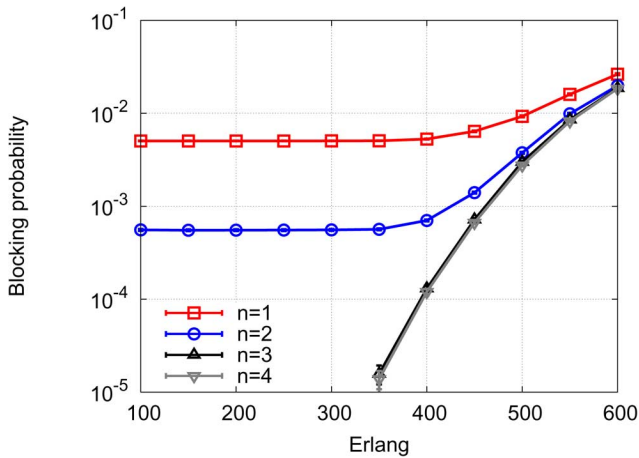

Fig. 12. Blocking probability as a function of the network load with SAP-HR scheme.

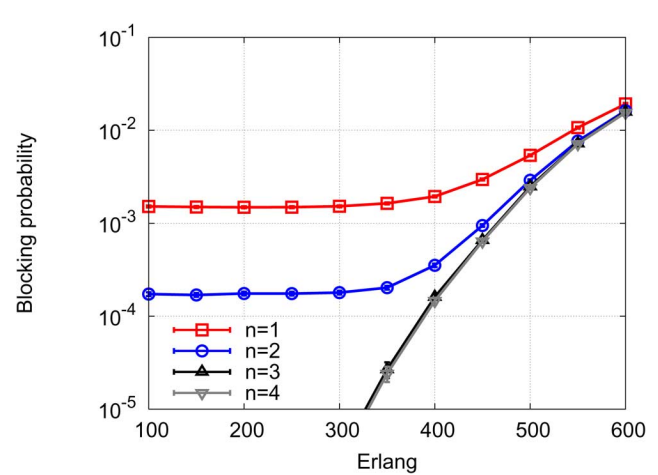

Fig. 15. Blocking probability as a function of the network load with SAL-A scheme.

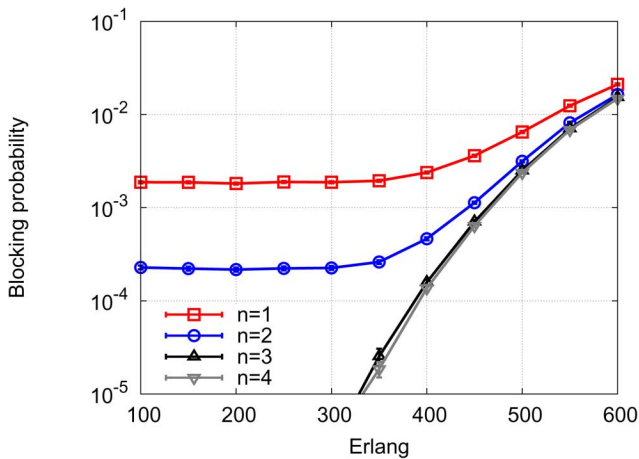

Fig. 13. Blocking probability as a function of the network load with SAP-HRA scheme.

Each request can exploit up to n set up attempts. Simulations with n values from 1 to 4 are considered.

Results show that, in case of low network load, the blocking probability is constant because it is only determined by unac-

ceptable QoT. On the contrary, at high network load, the lack of bandwidth resources contributes to increase the blocking probability. At high network load, although paths longer than the shortest routes may be selected because of lack of available bandwidth, all SA schemes are capable of establishing light-paths typically within $n = 3$ set up attempts. Indeed, the difference is negligible in all SA schemes between the curves obtained considering a maximum number of set up attempts equal to $n = 3$ and $n = 4$.

Fig. 16 summarizes the results shown in Figs. 11–15 reporting the curves obtained with $n = 1$ and $n = 3$ set up attempts. The comparison among the five SA schemes in case of a maximum number of set up attempts limited to just $n = 1$ confirms the aforementioned observations. In particular, SAP experiences the highest blocking probability while SAL-A provides the best performance. Results also show the good performance of SAP-HRA, obtaining just a slightly higher blocking probability compared to SAL-A. This confirms that just a minor improvement is provided by the SAL-A capability to store individual information collected resorting to every transit QP sub-object.

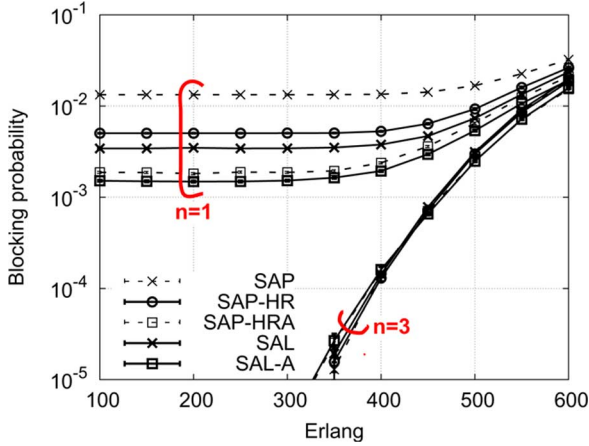

Fig. 16. Blocking probability as a function of the network load within $n = 1, 3$ setup attempts.

The comparison among the five SA schemes in case of a maximum number of set up attempts equal to $n = 3$ proves that, despite the different implementation complexity, all SA schemes typically guarantee the lightpath establishment within the third set up attempt.

All the aforementioned results show that the enhancement of management of QoT parameters using the proposed SA schemes guarantees high performance, thus avoiding the flooding of extra-information (unnecessary for most of connections as shown in Fig. 4) and the extension of the routing protocol, which characterize RA.

In the considered simulations, for simplicity, network nodes do not introduce different QoT parameters depending on the traversed interfaces and ports. However, the presence of different intra-node physical impairments represents an extremely critical situation if handled with RA. Instead, SA and in particular the SAP scheme, has the potential of efficiently handling this scenario without scalability problems.

A further advantage of the proposed SA schemes compared to RA refers to its robustness in case of frequently changing parameters. Indeed, a significant drawback of RA relates to frequent changes in parameter values which involve mainly source and destination information exchange, e.g., equalization procedure which requires output power and related OSNR feedback between transmitting and receiving interfaces [6]. This type of situations can be easily managed by the proposed signaling approach by exploiting the continuous RSVP-TE refresh message exchange along the route. Indeed, RSVP-TE is a soft state protocol which maintains the lightpath active through the exchange between source and destination of RSVP-TE Path and Resv refresh messages (default refresh period: 45 seconds). Periodic RSVP-TE refresh messages could be easily exploited to keep the QoT parameters updated. In particular, upon lightpath establishment, QP subobjects could include QoT parameters directly measured by monitoring systems (thanks to OSNR monitoring or channel power monitoring, for example, or direct QoT measurement thanks to BER measurements). In this way, the GMPLS control plane resorts to updated information and detects impairment changes.

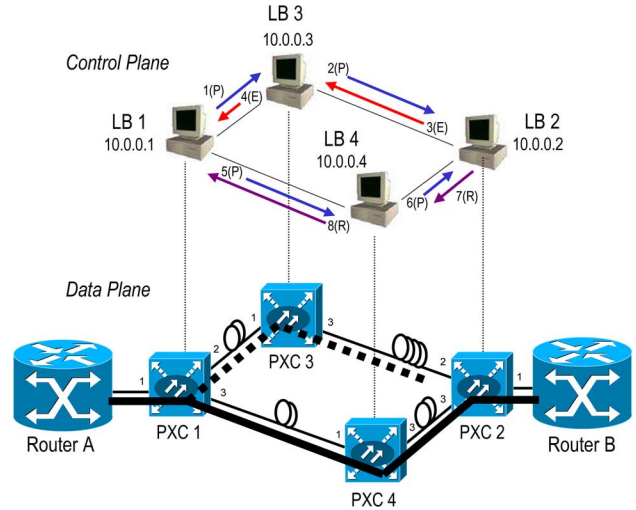

Fig. 17. Testbed implementing SA.

Salvadori *et al.* in [25] independently provided additional simulation results to demonstrate the good behavior of the SAP scheme compared to RA in case of dynamic impairment conditions. Moreover they confirmed that, also with different topologies and a different physical impairment model, a value of up to three signaling attempts is sufficient to successfully complete the lightpath establishment.

V. SIGNALING APPROACH EXPERIMENTAL IMPLEMENTATION

The testbed, in which the SA is implemented (specifically the SAP scheme), is shown in Fig. 17. It reproduces a portion of a typical Metro network where two edge routers (A and B) are connected through a transparent network of four PXC. Edge routers are equipped with optical Ethernet interfaces (1000BaseLX) whose maximum span reach is equal to 10 km (i.e., $MD = 10$ km). In this testbed we consider the ED as the only relevant QoT parameter.

PXC1 and PXC2 are used by router A and B, respectively, to dynamically set up optical connections within the transparent network. Every link between PXC is 3 km long except for PXC3-PXC2 link which is 6 km long. Linux boxes (LB) are employed to serve as control plane nodes of each PXC. RSVP-TE messages extended with the QQP object are exchanged among the LBs on the out-of-band Ethernet control plane. The protocol software is coded in C programming language and it is based on standard *Libpcap* and *Libnet* libraries.

The SAP scheme allows also to take into account intra-node information without causing scalability problems because of the absence of flooding, (e.g., for PXC1 we estimate $ED = 1$ km between port 1 and 2, $ED = 1.5$ km between port 1 and 3, etc.). Every node also maintains a local QPD database containing the QoT information, i.e., ED, describing the attached links, e.g., LB3 maintains information for the internal PXC3 QoT parameters and for links PXC1-PXC3 and PXC3-PXC2.

A connection request is generated at source router A to destination router B and is handled by PXC1. Two link disjoint paths (solid and dashed lines respectively) are available between PXC1 and PXC2 passing through either PXC3 or PXC4. Because OSPF protocol has not been extended (the source node is

No. .	Time	Source	Destination	Protocol	Info
3	2.876711	10.0.0.1	10.0.0.3	RSVP	PATH Message. SESSION: IPv4,
4	2.883147	10.0.0.3	10.0.0.2	RSVP	PATH Message. SESSION: IPv4,
5	2.889287	10.0.0.2	10.0.0.3	RSVP	PATH ERROR Message. SESSION:
6	2.892644	10.0.0.3	10.0.0.1	RSVP	PATH ERROR Message. SESSION:
7	2.898569	10.0.0.1	10.0.0.4	RSVP	PATH Message. SESSION: IPv4,
8	2.902485	10.0.0.4	10.0.0.2	RSVP	PATH Message. SESSION: IPv4,
9	2.909444	10.0.0.2	10.0.0.4	RSVP	RESV Message. SESSION: IPv4,
10	2.912848	10.0.0.4	10.0.0.1	RSVP	RESV Message. SESSION: IPv4,

Fig. 18. Message exchange.

not aware of QoT parameters), the two possible paths are identical for PXC1. As a worst-case scenario, the PXC1 selects the dashed route passing through PXC3. To set up the lightpath, a RSVP-TE Path message starts from LB1 (message 1(P) in Fig. 17). It contains the proposed PQP object extension which carries, within the QP subobject, the ED information associated to the transmitting interface and the attached link PXC1-PXC3. Because the lightpath is passing through PXC1 (from input port 1 to output port 2) $ED = 1.5$ km has to be considered as well as the 3 km that characterize link PXC1-PXC3. LB3 then updates the accumulated parameter (4.5 km) with its own parameter ($ED = 1$ km introduced by passing through PXC3 input port 1 and output port 3) and with information describing PXC3-PXC2 link (6 km). The message is then propagated to LB2 (2(P) on Fig. 17) which adds to the accumulated value of 11.5 km, the ED introduced by PXC2 (1 km). Admission control module running on LB2 for the GbE interface of router B evaluates the received information (12.5 km) and it decides whether the connection can or cannot be established. The cumulated ED value exceeds the maximum value of $MD = 10$ km that characterizes the receiving interface on PXC2. In this case the lightpath request is rejected and an RSVP-TE PathErr message extended with a novel error code (i.e., QoT Parameter error) is sent back to the source LB1 (messages 3(E) and 4(E) in Fig. 17). As a consequence, LB1 tries to establish the lightpath over the alternate route. RSVP-TE Path message is sent to LB2 passing through LB4 (5(P) and 6(P) in Fig. 17). In this case, the lightpath uses the route marked in solid line for which the collected total $ED = 9$ km. In this case the final equivalent length is within the range of acceptability of the receiver and the connection can be accepted. Confirmation messages (RSVP-TE Resv messages 7(R) and 8(R) in Fig. 17) are sent to LB1 to finalize the lightpath set up.

The complete message exchange is summarized in the log reported in Fig. 18. The RSVP-TE packets show that the previous described lightpath set up procedure is completed in few milliseconds. In another study [26] we measured the time required to complete a RSVP-TE message exchange in a real metropolitan network made by commercial routers. Since that time is only one order of magnitude higher than the value experienced in the local area network ethernet control plane utilized in this paper, we can conclude that the signaling approach does not significantly delay the set up process even when few deprecated routes are first selected.

VI. CONCLUSION

In this study a signaling approach (SA) for incorporating dynamic estimation of the quality of transmission (QoT) into GMPLS protocol suite has been proposed and assessed both numerically and experimentally. The approach is based on proper extensions to the signaling protocol (i.e., RSVP-TE) while no additional extensions are applied to the routing protocol.

In particular, five different SA schemes have been proposed and evaluated. They differ in the amount of QoT parameters collected during the signaling session (i.e., cumulated or individual information) and the way these parameters are used to perform route computations. Numerical results have shown that the proposed SA allows to detect and overcome QoT blocking in transparent WDM network and to successfully complete the lightpath establishment within few set up attempts. The simplest scheme, i.e., SAP, guarantees the lightpath establishment in no more than three set up attempts and it does not require additional databases to store remote QoT parameters. In case of steady-state physical parameters the best performance is achieved by SAP-HRD and SAL-A schemes which can rapidly obtain successful lightpath establishment already at the first set up attempt.

An experimental implementation of the proposed signaling approach has been also presented. The experiment, based on PXCs and on an out-of-band GMPLS control plane, has shown that the proposed SA approach is capable of managing intra-node physical information without scalability problems and has confirmed the feasibility and the good performance in terms of lightpath set up time of the proposed approach.

REFERENCES

- [1] R. Martinez, C. Pinart, F. Cugini, N. Andriolli, L. Valcarengi, P. Castoldi, L. Wosinska, J. Comellas, and G. Junyent, "Challenges and requirements for introducing impairment-awareness into the management and control planes of ASON/GMPLS WDM networks," *IEEE Commun. Mag.*, vol. 44, no. 12, pp. 76–85, Dec. 2006.
- [2] F. Cugini, N. Sambo, N. Andriolli, A. Giorgetti, L. Valcarengi, P. Castoldi, E. L. Rouzic, and J. Poirrier, "GMPLS extensions to encompass shared regenerators in transparent optical networks," in *Proc. Eur. Conf. Opt. Commun., ECOC 2007*, Sep. 2007.
- [3] J. Strand, A. L. Chiu, and R. Tkach, "Issues for routing in the optical layer," *IEEE Commun. Mag.*, vol. 39, no. 2, pp. 81–87, Feb. 2001.
- [4] D. C. Kilper, R. Bach, D. J. Blumenthal, D. Einstein, T. Landolsi, L. Ostar, M. Preiss, and A. E. Willner, "Optical performance monitoring," *J. Lightw. Technol.*, vol. 22, no. 1, pp. 294–304, Jan. 2004.
- [5] M. Ali, D. Elie-Dit-Cosaque, and L. Tancevski, "Enhancements to multiprotocol lambda switch to accommodate transmission impairments," in *Proc. IEEE Global Telecommun. Conf., GLOBECOM 2003*, Dec. 2003.

- [6] A. R. Chraplyvy, J. A. Nagel, and R. W. Tkach, "Equalization in amplified WDM lightwave transmission system," *IEEE Photon. Technol. Lett.*, vol. 4, no. 8, pp. 920–922, Aug. 1992.
- [7] A. Jukan and G. Franzl, "Path selection methods with multiple constraints in service-guaranteed WDM networks," *IEEE/ACM Trans. Networking*, vol. 12, no. 1, pp. 59–72, Feb. 2004.
- [8] J. Strand and A. Chiu, "Impairments and other constraints on optical layer routing," IETF, 2005, RFC 4054.
- [9] F. Cugini, N. Andriolli, L. Valcarenghi, and P. Castoldi, "Physical impairment aware signalling for dynamic lightpath set up," in *Proc. Eur. Conf. Opt. Commun., ECOC 2005*, Sep. 2005.
- [10] N. Sambo, A. Giorgetti, N. Andriolli, F. Cugini, L. Valcarenghi, and P. Castoldi, "GMPLS signalling feedback for encompassing physical impairments in transparent optical networks," in *Proc. IEEE Global Telecommun. Conference, GLOBECOM 2006*, Dec. 2006.
- [11] A. Farrel, A. Satyanarayana, A. Iwata, N. Fujita, and G. Ash, "Crankback signaling extensions for MPLS and GMPLS RSVP-TE," IETF, 2007, RFC 4920.
- [12] D. Penninckx and C. Perret, "New physical analysis of 10-Gb/s transparent optical networks," *IEEE Photon. Technol. Lett.*, vol. 15, no. 5, pp. 778–780, May 2003.
- [13] V. Anagnostopoulos, C. Politi, C. Matrakidis, and A. Stavdas, "Physical layer impairment aware wavelength routing algorithms based on analytically calculated constraints," *Opt. Commun.*, 2007.
- [14] R. Sabella, E. Iannone, M. Listanti, M. Berdusco, and S. Binetti, "Impact of transmission performance on path routing in all-optical transport networks," *J. Lightw. Technol.*, vol. 16, no. 11, pp. 1965–1972, Nov. 1998.
- [15] P. Kulkarni, A. Tzanakaki, C. Machuka, and I. Tomkos, "Benefits of Q-factor based routing in WDM metro networks," in *Proc. Eur. Conf. Opt. Commun., ECOC 2005*, Sep. 2005.
- [16] S. Pachnicke, T. Gravemann, M. Windmann, and E. Voges, "Physically constrained routing in 10-gb/s DWDM networks including fiber nonlinearities and polarization effects," *J. Lightw. Technol.*, vol. 24, no. 9, pp. 3418–3426, Sep. 2006.
- [17] D. Levandovsky, "Wavelength routing based on physical impairments," *Proc. IEEE Opt. Fiber Commun., OFC 2001*, 2001.
- [18] B. Ramamurthy, D. Datta, H. Feng, J. P. Heritage, and B. Mukherjee, "Impact of transmission impairments on the teletraffic performance of wavelength-routed optical networks," *J. Lightw. Technol.*, vol. 17, no. 10, pp. 1713–1723, Oct. 1999.
- [19] X. Yang and B. Ramamurthy, "Dynamic routing in translucent WDM optical networks: The intradomain case," *J. Lightw. Technol.*, vol. 23, no. 3, pp. 955–971, Mar. 2005.
- [20] Y. Huang, J. P. Heritage, and B. Mukherjee, "Connection provisioning with transmission impairment consideration in optical WDM networks with high-speed channels," *J. Lightw. Technol.*, vol. 23, no. 3, pp. 982–993, Mar. 2005.
- [21] Y. Pointurier and F. Heidari, "Reinforcement learning based routing in all-optical networks," in *Proc. Broadnets 2007 Conf.*, Sep. 2007.
- [22] B. Lavigne, F. Leplingard, L. Lorcy, E. Balmeferrezol, J. C. Antona, T. Zami, and D. Bayart, "Method for the determination of a quality of transmission estimator along the lightpaths of partially transparent networks," in *Proc. Eur. Conf. Opt. Commun., ECOC 2007*, Sep. 2007.
- [23] D. Papadimitriou, J. P. Faure, O. Audouin, and R. Appelman, "Non-linear routing impairments in wavelength switched optical networks," Nov. 2001, IETF Internet draft, Draft-Papadimitriou-Ipo-Non-Linear-Routing-Impairm-01.Txt, expired.
- [24] J. C. Antona, S. Bigo, and J. Faure, "Nonlinear cumulated phase as a criterion to assess performance of terrestrial wdm systems," in *Proc. IEEE Opt. Fiber Commun., OFC 2002*, 2002.
- [25] E. Salvadori, Y. Ye, A. Zanardi, H. Woesner, M. Carcagnì, G. Galimberti, G. Martinelli, A. Tanzi, and D. L. Fauci, "A study of connection management approaches for an impairment-aware optical control plane," in *Proc. Opt. Networking Design Modeling, ONDM 2007*, May 2007.
- [26] D. Adami, P. Castoldi, F. Cugini, S. Giordano, and L. Valcarenghi, "Performance evaluation of recovery techniques in a grid oriented metrocore/vesper field trial," in *Proc. Tridentcom 2005*, Feb. 2005.



Filippo Cugini received the M.S. degree in telecommunication engineering from the University of Parma, Italy.

Since 2001, he has been with the National Laboratory of Photonic Networks, Consorzio Nazionale Interuniversitario per le Telecomunicazioni (CNIT), Pisa, Italy. His main research interests include MPLS, GMPLS, and PCE protocols and architectures, survivability in IP over WDM networks, and traffic engineering in grid networking.



Nicola Sambo received the Laurea degree (cum laude) in telecommunication engineering from the University of Pisa, Pisa, Italy, in 2004. He is currently pursuing the Ph.D. degree at Scuola Superiore Sant'Anna, Pisa, Italy, in the Center of Excellence for Information and Communication Engineering (CEIIC). In 2007 he was a visiting student at France Télécom, Lannion.

His research interests include WDM network planning and modeling, QoS and fault tolerance in optical networks, and GMPLS protocol suite for optical networks.

works.



Nicola Andriolli received the Laurea degree in telecommunications engineering from the University of Pisa, Pisa, Italy, in 2002, and the Diploma and Ph.D. degrees from Scuola Superiore Sant'Anna, Pisa, Italy, in 2003 and 2006, respectively.

He was a Visiting Student at Budapest University of Technology and Economics (BUTE), Budapest, Hungary, and the Department of Communications, Optics and Materials of the Technical University of Denmark (COM DTU), Copenhagen, and he was a Visiting Trainee at National Institute of Information

and Communications Technology (NICT), Tokyo, Japan. He is currently a Postdoctoral Fellow with Scuola Superiore Sant'Anna. His research interests include network modeling and simulation, QoS and fault tolerance in optical networks, generalized multiprotocol label switching (GMPLS) architecture, and optical packet switching.



Alessio Giorgetti received the Laurea degree in telecommunications engineering from the University of Pisa, Pisa, Italy, in 2002 and the Ph.D. degree from Scuola Superiore Sant'Anna, Pisa, in 2006.

He was Visiting Scholar with the Centre for Photonic Systems, University of Cambridge, Cambridge, U.K. He is currently a Postdoctoral Fellow with Scuola Superiore, Sant'Anna. His research interests include wavelength-division-multiplexing (WDM) network design, fault tolerance in optical networks, GMPLS control plane for wavelength-routed optical

networks, next-generation Synchronous Digital Hierarchy (SDH) technologies, and WDM-passive optical network (PON) access networks design.



Luca Valcarenghi received the Laurea degree in electronics engineering in 1997 from the Politecnico di Torino, Italy, the M.S. degree in electrical engineering in 1999, and the Ph.D. degree in electrical engineering-telecommunications in 2001, both from the University of Texas at Dallas (UTD).

Between January 2002 and August 2002, he was Research Associate of the Optical Networking Advanced Research (OpNeAR) Lab, University of Texas at Dallas Erik Jonsson School of EE/CS. Since September 2002, he has been an Assistant Professor with the Scuola Superiore Sant'Anna of University Studies and Doctoral

Research of Pisa, Italy. His main research interests are optical networks design, analysis, and optimization; artificial intelligence optimization techniques; communication networks reliability; IP over WDM networking; QoS in network infrastructures for grid computing; and broadband wireless access (802.16).



Piero Castoldi received the Laurea degree (cum laude) in electrical engineering from the University of Bologna, Italy, in 1991 and the Ph.D. degree from the University of Parma, Italy, in 1996.

In 1996 and 1997 and in the summers of 1999 and 2000, he was a Postdoc at the Department of Electrical Engineering, Princeton University, Princeton, NJ. From December 1997 to February 2001, he was an Assistant Professor at the Faculty of Engineering, University of Parma. Since March 2001, he has been an Associate Professor in telecommunications with

the Scuola Superiore Sant'Anna, Pisa, Italy, where he is currently responsible for the networks area. In January and February 2002, he was a Visiting Professor at the University of Texas at Dallas, Richardson. He also collaborates in several projects of the Inter-University National Consortium for Telecommunications (CNIT), and since March 2003, he has been the Director of the CNIT National Photonic Networks Laboratory in Pisa. He has held, as an Instructor, several courses at the undergraduate and graduate level at the University of Parma and at Scuola Superiore Sant'Anna. His scientific activity has covered the area of digital transmission, telecommunication-network performance, and, more recently, provisioning, protection, and switching techniques for the next generation optical networks. He is the author of more than 100 technical papers published in international conferences and journals and of an international book on code division multiple access.

Esther Le Rouzic received the telecommunications degree from Ecole Nationale Supérieure des Télécommunications de Bretagne, France, the M.Sc. degree from the University College London, U.K., in 1996, and the Ph.D. degree in electronics and communications from Ecole Nationale Supérieure des Télécommunications, France, in 1999.

She joined France Telecom R&D, Lannion, in 2000, where she has been working on wavelength division multiplexing (WDM) networks, optical functions, optical transmission, and translucent networks. She is involved in national and European projects dealing with optics and authored about 25 national or international papers or communications.

Julien Poirrier received the Diplôme d'ingénieur in electrical engineering from SUPELEC, France, in 1999, the M.S. degree in electrical engineering from Virginia Tech, Blacksburg, in 2000, and the Ph.D. degree from Université de Rennes, France, in 2007.

In 1999, he started his thesis work on electronic mitigation of polarization mode dispersion at AT&T Research Labs, Red Bank, NJ. In 2000, he joined the Research and Innovation Department, Alcatel, Stuttgart, Germany, where he worked on optical compensation of polarization-mode dispersion. In 2002, he joined the development team of Marconi Ondata, Backnang, Germany, where he was involved with the design and development of flexible, transparent photonic transmission system. Since 2004, he has been with France Telecom RD, Lannion. His current research activities include impairments mitigation, PMD impact, and translucent networks.

Dr. Poirrier is the recipient of the Year 2000 Paul E. Torgersen Graduate Student Research Excellence Award.