

Research Article

Simulation of Processes in Dual Three-Phase System on the Base of Four Inverters with Synchronized Modulation

Valentin Oleschuk,¹ Gabriele Grandi,² and Padmanaban Sanjeevikumar²

¹Institute of Power Engineering, Academy of Sciences of Moldova, 2028 Chishinev, Moldova

²Department of Electrical Engineering, University of Bologna, 40136 Bologna, Italy

Correspondence should be addressed to Valentin Oleschuk, oleschukv@hotmail.com

Received 30 June 2011; Accepted 15 September 2011

Academic Editor: Francesco Profumo

Copyright © 2011 Valentin Oleschuk et al. This is an open access article distributed under the Creative Commons Attribution License, which permits unrestricted use, distribution, and reproduction in any medium, provided the original work is properly cited.

Novel method of space-vector-based pulse-width modulation (PWM) has been disseminated for synchronous control of four inverters feeding six-phase drive on the base of asymmetrical induction motor which has two sets of windings spatially shifted by 30 electrical degrees. Basic schemes of synchronized PWM, applied for control of four separate voltage-source inverters, allow both continuous phase voltages synchronization in the system and required power sharing between DC sources. Detailed MATLAB-based simulations show a behavior of six-phase system with continuous and discontinuous versions of synchronized PWM.

1. Introduction

Multiphase and, in particular, six-phase induction motor drives are a subject of increasing interest in the last years due to some advantages compared with conventional three-phase drives [1–5]. One of the most perspective applications of six-phase induction motor drives lies in the field of high power/high current systems (ship propulsion, locomotive, electrical vehicles, etc.), which are characterized by low switching frequency of power switches.

Recently, novel four-inverter-based topology of dual three-phase drive system with an increased power rating has been proposed, allowing quadrupling the power capability of a single inverter with given voltage and current rating [6]. Figure 1 shows this system structure, consisting of two groups of two inverters, supplying the open-end windings of asymmetrical dual three-phase motor. The induction machine has in this case two sets of winding spatially shifted by 30 electrical degrees.

For electrical drives with increased power and/or current it is necessary to synchronize the output voltage waveforms of converters for elimination of undesirable subharmonics of voltage and current [7–9]. In order to avoid asynchronism of standard versions of space-vector modulation, novel method of synchronized space-vector PWM has been proposed and developed with application to different topologies of power

electronic converters, electric drives, and renewable energy systems [10–17].

So, this paper presents results of detailed MATLAB-based simulation of processes in asymmetrical six-phase drive system on the base of four cascaded voltage-source inverters controlled by algorithms of synchronized space-vector modulation.

2. Peculiarities of the Method of Synchronized Space-Vector PWM

In order to avoid asynchronism of conventional space-vector modulation, novel method of synchronized PWM [10, 11] can be used for control of each inverter in the six-phase (dual three-phase) drive system.

Figures 2 and 3 present basic switching state sequences of standard three-phase voltage-source inverter inside the interval 0° – 90° . They illustrate schematically continuous (Figure 2) and discontinuous (Figure 3) versions of synchronized space-vector PWM.

The upper traces in Figures 2 and 3 are switching state sequences (in accordance with conventional designation [10]) and then control signals for the cathode switches of the phases **a**, **b**, **c** (**x**, **y**, **z**) of each inverter. The lower traces in Figures 2 and 3 show the corresponding quarter wave of

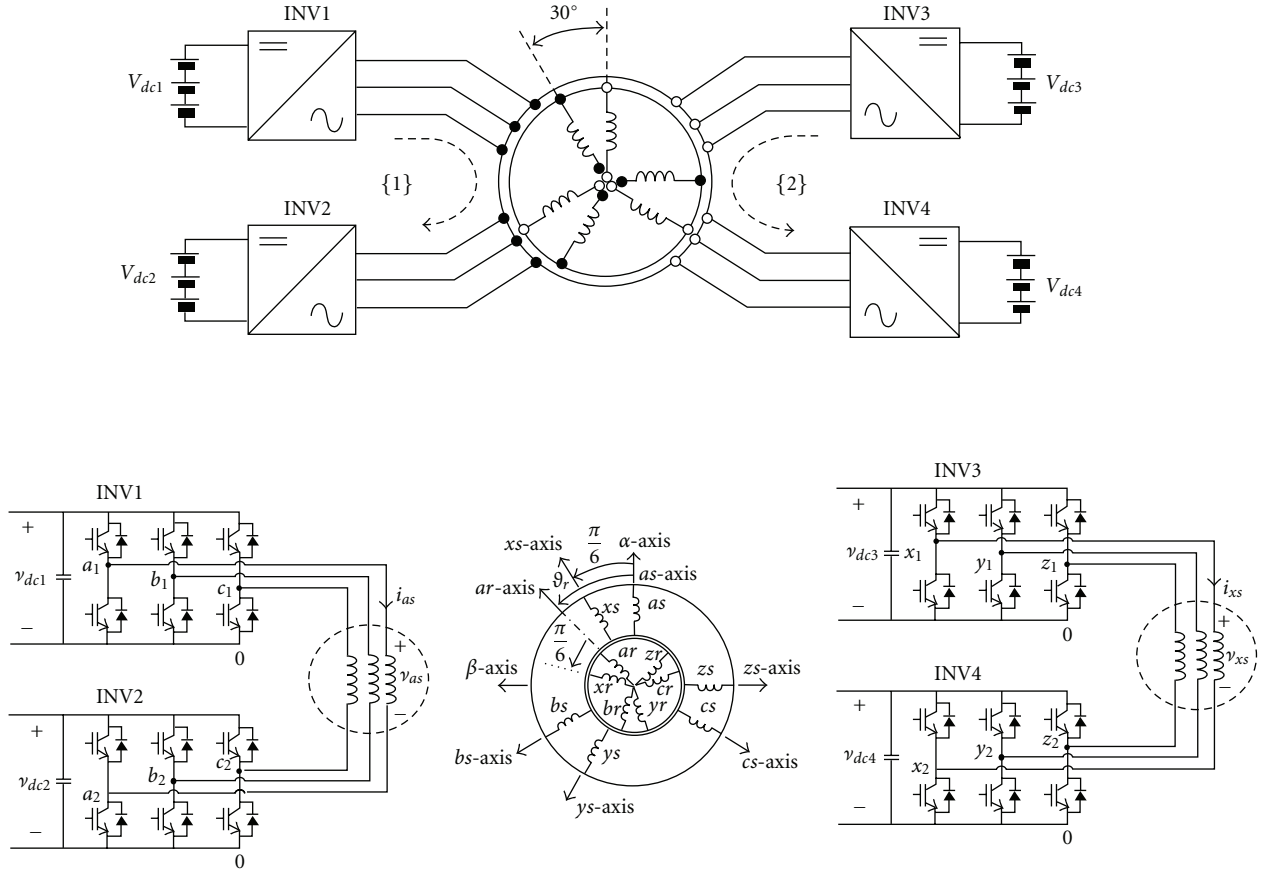

FIGURE 1: Topology of dual three-phase system on the base of four inverters (the first inverter group INV1+INV2 and the second inverter group INV3+ INV4) supplying open-end windings of asymmetrical six-phase induction motor with two sets of winding spatially shifted by 30 electrical degrees.

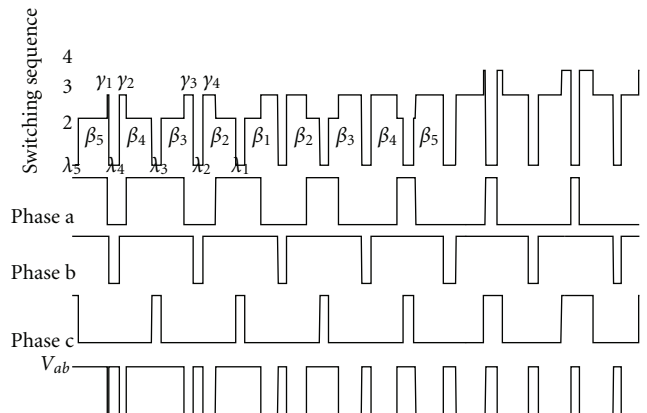

FIGURE 2: Switching state sequence, pole voltages, and line voltage V_{ab} of inverter with continuous synchronized PWM.

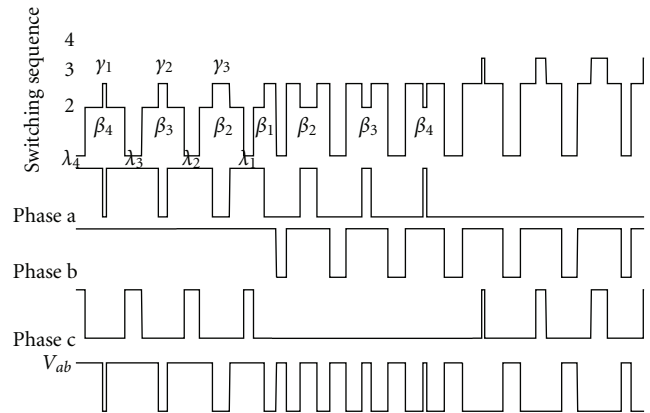

FIGURE 3: Switching state sequence, pole voltages, and line voltage V_{ab} of inverter with discontinuous synchronized PWM.

the line output voltage of inverters. Signals β_j represent total switch-on durations during switching sub interval τ , and signals γ_k are generated on the borders (Figure 2) or in the centers (Figure 3) of the corresponding β . Widths of notches λ_k represent duration of zero sequences (notches) [10, 11].

One of the basic ideas of the method of synchronized PWM is in continuous synchronization of the positions of

all central signals β_1 in the centres of the 60° -clock intervals, and then in symmetrical generation of all other active β -signals around the centres of the 60° -clock intervals. In particular, special signals λ' (λ_5 in Figure 2, λ_4 in Figure 3) with the neighboring β'' (β_5 in Figure 2, β_4 in Figure 3) are formed in the clock points ($0^\circ, 60^\circ, 120^\circ$) of the output curve of inverters with synchronized PWM for this purpose.

TABLE 1: Basic parameters of PWM methods.

Control (modulation) parameter	Conventional schemes of vector PWM	Proposed method of modulation	
Operating and max parameter	Operating & max voltage V and V_m	Operating & maximum fundamental frequency F and F_m	
Modulation index m	V/V_m	F/F_m	
Duration of subcycles	T	τ	
Center of the k -signal	α_k (angles/degr.)	$\tau(k-1)$ (sec)	
Switch-on durations	$T_{\alpha k} = 1.1mT[\sin(60^\circ - \alpha_k) + \sin \alpha_k]$	Algebraic PWM	Trigonometric PWM
	$t_{\alpha k} = 1.1mT \sin \alpha_k$	$\beta_k = \beta_1[1 - A \times (k-1)\tau FK_{Ov1}]$ $\gamma_k = \beta_{i-k+1}[0.5 - 6(i-k)\tau F]K_{Ov2}$	$\beta_k = \beta_1 \times \cos[(k-1)\tau K_{Ov1}]$ $\gamma_k = \beta_{i-k+1}[0.5 - 0.9m(i-k)\tau] K_{Ov2}$
	$t_{bk} = 1.1mT \times \sin(60^\circ - \alpha_k)$	$\beta_k - \gamma_k$	$\beta_k - \gamma_k$
Switch-off states (zero voltage)	$t_{0k} = T - t_{\alpha k} - t_{bk}$	$\lambda_k = \tau - \beta_k$	
Special parameters providing synchronization of the process of PWM		$\beta'' = \beta_1[1 - A \times (K-1)\tau FK_{Ov1}]K_s$ $\lambda' = (\tau - \beta'') \times K_{Ov1}K_s$	$\beta'' = \beta_1 \times \cos[(k-1)\tau K_{Ov1}]K_s$ $\lambda' = (\tau - \beta'') \times K_{Ov1}K_s$

They are reduced simultaneously until close to zero value at the boundary frequencies between control subzones. So, this novel PWM strategy provides continuous symmetrical output voltage control of inverters.

Table 1 presents generalized properties and basic control correlations for the proposed method of synchronized PWM [10]. It is also compared here with conventional asynchronous space-vector modulation.

3. Synchronized PWM in Dual Three-Phase System on the Base of Four Inverters

Control of four three-phase inverters supplying asymmetrical six-phase induction motor has some specific peculiarities.

In particular, these inverters are grouped into two groups with two cascaded inverters in each group, and each inverter group is connected with the corresponding open-end windings of dual three-phase induction motor. Synchronous symmetrical control of the output voltage of each inverter of each inverter group in accordance with algorithms of synchronized PWM provides synchronous symmetrical regulation of voltage in the corresponding induction machine phase windings. Rational phase shifting between output voltage waveforms of the two inverters in each inverter group is equal in this case to one half of the switching interval (subcycle) τ [18].

In the case when the two DC-link voltage sources have the same voltage, the resulting voltage space vectors are equal to the space-vector patterns of conventional three-level inverter [3, 6, 18]. The phase voltage V_{as} of the first group of cascaded inverters with two insulated DC-link sources (Figure 1) is calculated in accordance with (1) [19]:

$$V_{01} = \frac{1}{3}(V_{a1} + V_{b1} + V_{c1} + V_{a2} + V_{b2} + V_{c2}),$$

$$V_{as} = V_{a1} + V_{a2} - V_{01},$$

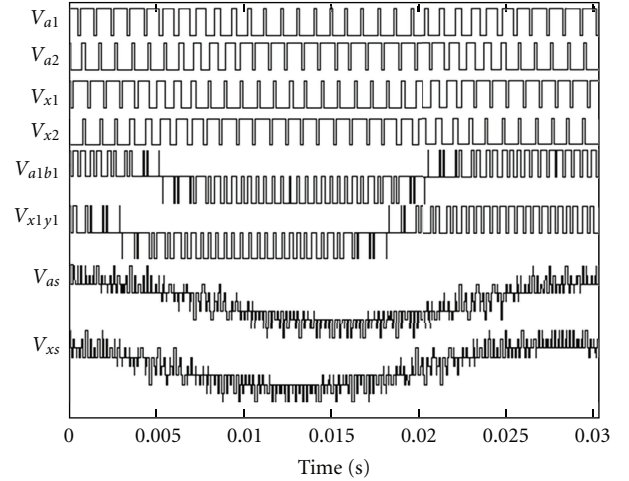

FIGURE 4: Pole voltages V_{a1} , V_{a2} and V_{x1} , V_{x2} , line-to-line voltages V_{a1b1} and V_{x1y1} , and phase voltages V_{as} and V_{xs} of dual three-phase system with continuous synchronized PWM ($F = 35$ Hz, $V_{dc1} = V_{dc2} = V_{dc3} = V_{dc4}$, $m_1 = m_2 = m_3 = m_4 = 0.7$, $F_s = 1$ kHz).

$$V_{02} = \frac{1}{3}(V_{x1} + V_{y1} + V_{z1} + V_{x2} + V_{y2} + V_{z2}),$$

$$V_{xs} = V_{x1} + V_{x2} - V_{02}, \quad (1)$$

where V_{a1} , V_{b1} , V_{c1} , V_{a2} , V_{b2} , V_{c2} and V_{x1} , V_{y1} , V_{z1} , V_{x2} , V_{y2} , V_{z2} are the corresponding pole voltages of each group of three-phase inverters, and V_{01} and V_{02} are the corresponding zero sequence (triplen harmonic components) voltages.

At the same time, control of asymmetrical six-phase induction machines is based on the 30° -phase shift of control and output signals of two above-mentioned groups of four inverters [2, 5]. As an illustration of control of dual three-phase system with synchronized PWM and with equal voltages of all DC sources ($V_{dc1} = V_{dc2} = V_{dc3} = V_{dc4}$), Figures 4–7 present results of MATLAB-based simulations, which include basic voltage waveforms (pole voltages V_{a1} ,

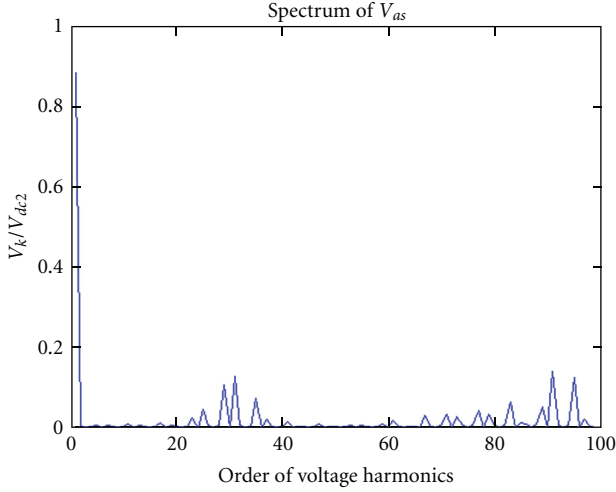

FIGURE 5: Spectrum of the phase voltage V_{as} of the system with continuous synchronized PWM ($F = 35$ Hz, $F_{s1} = 1$ kHz).

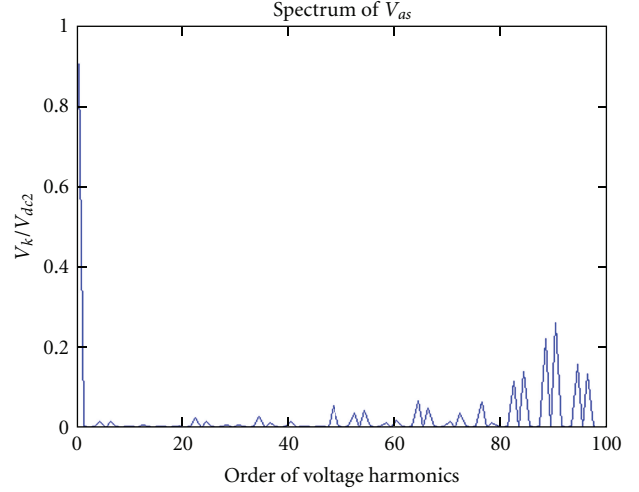

FIGURE 7: Spectrum of the phase voltage V_{as} of the system with discontinuous synchronized PWM ($F = 35$ Hz, $F_{s1} = 1$ kHz).

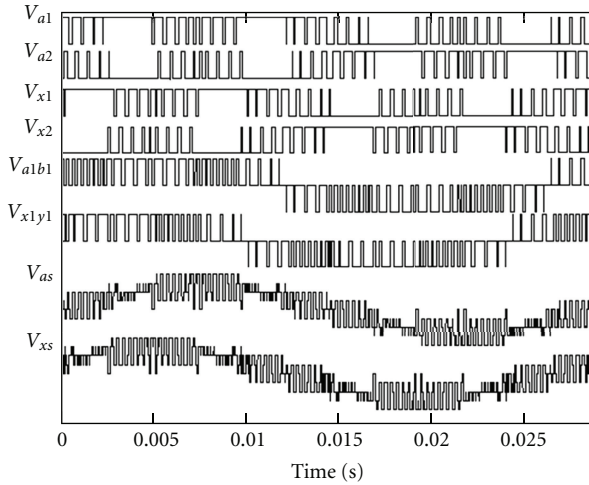

FIGURE 6: Pole voltages V_{a1} , V_{a2} and V_{x1} , V_{x2} , line-to-line voltages V_{a1b1} and V_{x1y1} , and phase voltages V_{as} and V_{xs} of dual three-phase system with discontinuous synchronized PWM ($F = 35$ Hz, $V_{dc1} = V_{dc2} = V_{dc3} = V_{dc4}$, $m_1 = m_2 = m_3 = m_4 = 0.7$, $F_s = 1$ kHz).

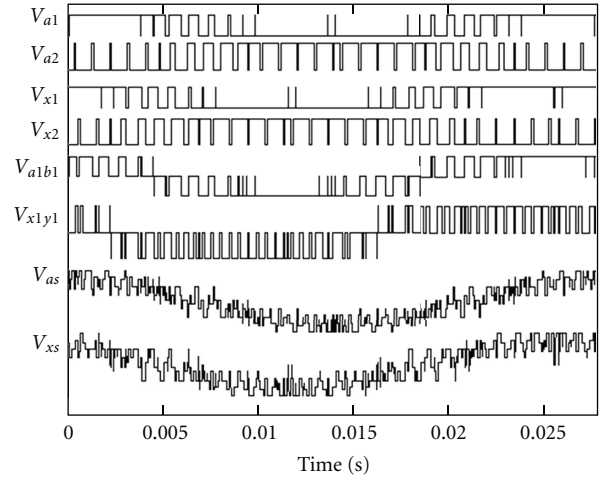

FIGURE 8: Pole voltages V_{a1} , V_{a2} and V_{x1} , V_{x2} , line-to-line voltages V_{a1b1} and V_{x1y1} , and phase voltages V_{as} and V_{xs} of dual three-phase system with continuous synchronized PWM ($F = 35$ Hz, $V_{dc1} = 0.7 V_{dc2}$, $V_{dc3} = 0.7 V_{dc4}$, $V_{dc2} = V_{dc4}$, $m_1 = m_3 = 0.933$, $m_2 = m_4 = 0.7$, $F_s = 1$ kHz).

V_{a2} , V_{x1} , V_{x2} , line-to-line voltages V_{a1b1} , V_{x1y1} , and the phase voltages V_{as} and V_{xs} (with the spectrum of the V_{as} voltage)) of two groups of inverters, controlled by algorithms of continuous (Figures 4 and 5) and discontinuous with the 30°-nonswitching intervals (Figures 6 and 7) synchronized modulation. The fundamental and switching frequencies of each inverter are equal correspondingly to $F = 35$ Hz and $F_s = 1$ kHz, and modulation indices of all inverters are equal to $m_1 = m_2 = m_3 = m_4 = 0.7$ in this case. The phase output voltage of the system has nine levels (like output voltage of three-level neutral-clamped converter) in this control mode. In particular, the presented voltage waveforms have symmetry, and its spectra do not contain even harmonics and subharmonics.

In the case of nonequal DC voltages, if $V_{dc1} \neq V_{dc2}$ and $V_{dc3} \neq V_{dc4}$, but $V_{dc1} = V_{dc3}$ and $V_{dc2} = V_{dc4}$, in order to provide equivalence of the output fundamental voltages (and

also power balancing) of two inverters of each inverter group during scalar V/F control of the system, it is necessary to provide linear correlations between its modulation indices and magnitudes of the DC voltages:

$$\begin{aligned} m_1 V_{dc1} &= m_2 V_{dc2}, \\ m_3 V_{dc3} &= m_4 V_{dc4}, \end{aligned} \quad (2)$$

In particular, for the case when $V_{dc1} = 0.7 V_{dc2}$, $V_{dc3} = 0.7 V_{dc4}$ and $m_2 = m_4 = 0.7$, in accordance with (2) $m_1 = m_3 = 0.93$, and the last value of modulation indices corresponds to overmodulation control mode of the two corresponding inverters. To illustrate the above-mentioned process in dual three-phase drive system on the base of four inverters supplied by four isolated DC sources with different voltages ($V_{dc1} = 0.7 V_{dc2}$, $V_{dc3} = 0.7 V_{dc4}$, $V_{dc2} = V_{dc4}$), Figures 8–11 present results of simulation of this system.

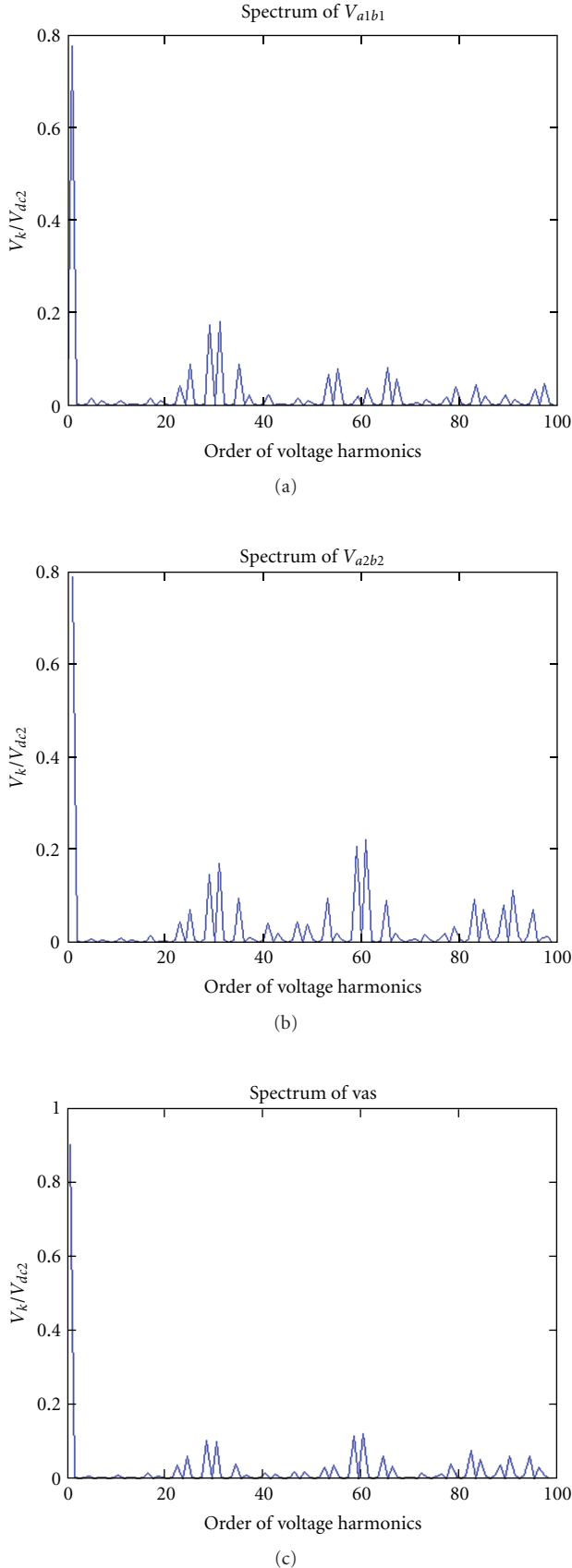

FIGURE 9: Spectra of the V_{a1b1} , V_{a2b2} and V_{as} voltages of the system with continuous synchronized PWM ($F = 35$ Hz, $F_s = 1$ kHz).

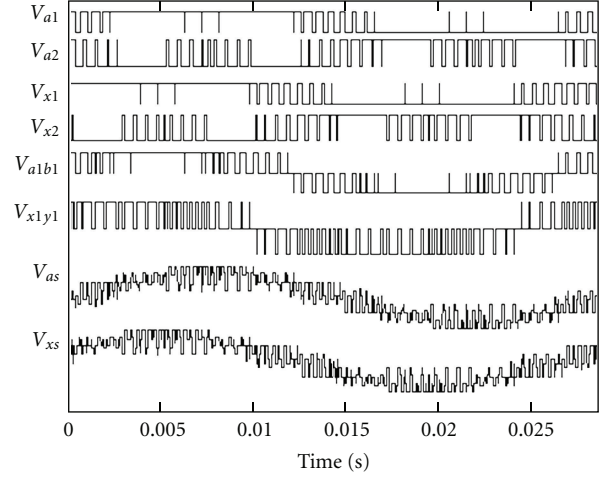

FIGURE 10: Pole voltages V_{a1} , V_{a2} and V_{x1} , V_{x2} , line-to-line voltages V_{a1b1} and V_{x1y1} , and phase voltages V_{as} and V_{xs} of dual three-phase system with discontinuous synchronized PWM ($F = 35$ Hz, $V_{dc1} = 0.7 V_{dc2}$, $V_{dc3} = 0.7 V_{dc4}$, $V_{dc2} = V_{dc4}$, $m_1 = m_3 = 0.933$, $m_2 = m_4 = 0.7$, $F_s = 1$ kHz).

In particular, Figures 8 and 9 show basic voltage waveforms and spectra of the V_{a1b1} , V_{a2b2} and V_{as} voltages for the system controlled by algorithms of continuous synchronized PWM. Figure 10 presents basic voltage waveforms during period of the fundamental frequency for the system with discontinuous synchronized PWM with the 30° -nonswitching intervals, and Figure 11 shows spectra of the line and phase voltages of the first group of cascaded inverters. The fundamental and switching frequencies of each inverter are equal to $F = 35$ Hz and $F_s = 1$ kHz. It is necessary to mention that spectra of the corresponding output voltages of inverters of the second inverter group will have the same nature for the presented control mode.

For dual three-phase drive system on the base of four inverters with nonequal voltages of DC links, in order to provide the rated power ratio P_1/P_2 and P_3/P_4 between four power sources of two groups of cascaded inverters (for scalar V/F control mode), it is necessary to provide the corresponding correlations between magnitudes of DC voltages, modulation indices of four inverters, and the rated power ratio in accordance with (3) [14]:

$$\begin{aligned} \frac{m_1 V_{dc1}}{m_2 V_{dc2}} &= \frac{P_1}{P_2}, \\ \frac{m_3 V_{dc3}}{m_4 V_{dc4}} &= \frac{P_3}{P_4}. \end{aligned} \quad (3)$$

For dual three-phase drive system it is practically important to provide equal power distribution between two groups of inverters feeding asymmetrical six-phase induction motor:

$$P_1 + P_2 = P_3 + P_4. \quad (4)$$

For this case, in accordance with (3), for balancing operation of dual three-phase system it is necessary to provide:

$$m_1 V_{dc1} P_2 + m_2 V_{dc2} P_1 = m_3 V_{dc3} P_4 + m_4 V_{dc4} P_3, \quad (5)$$

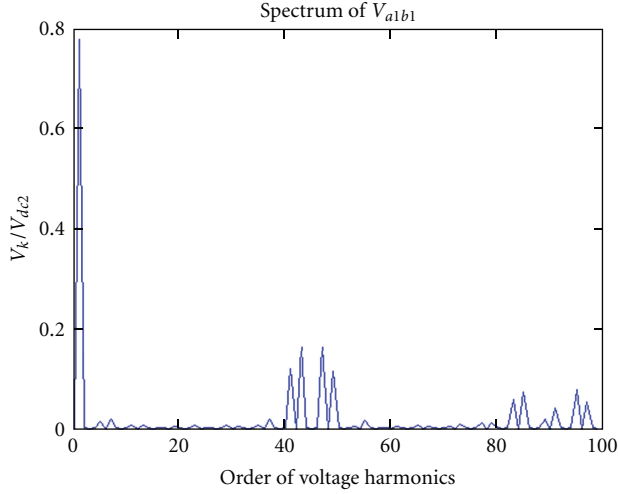

(a)

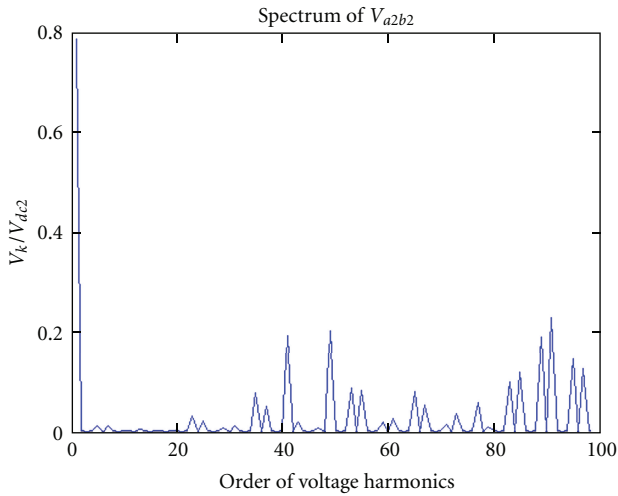

(b)

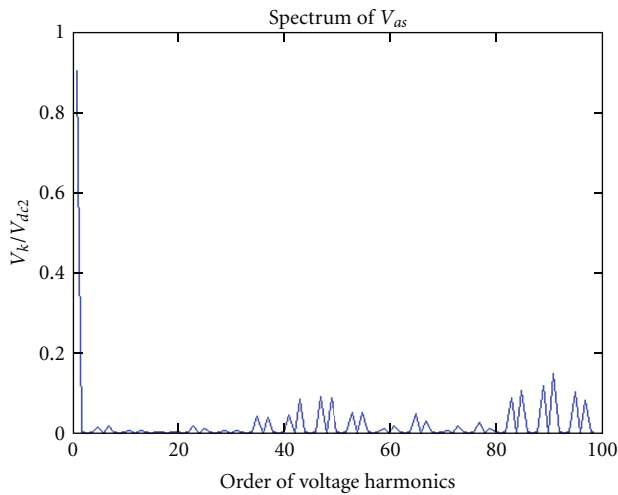

(c)

FIGURE 11: Spectra of the V_{a1b1} , V_{a2b2} and V_{as} voltages of the system with discontinuous synchronized PWM ($F = 35$ Hz, $F_s = 1$ kHz).

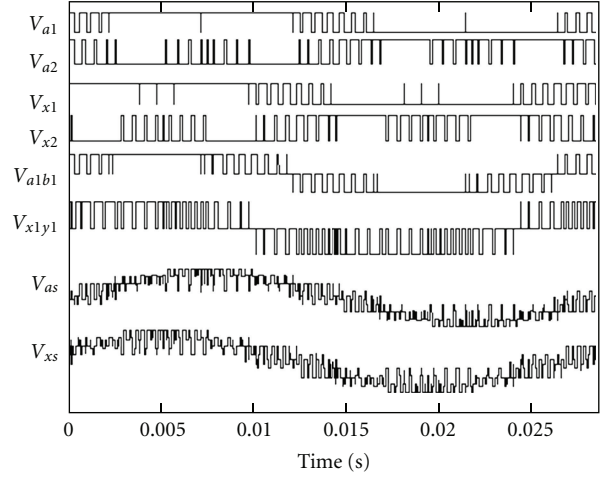

FIGURE 12: Pole voltages V_{a1} , V_{a2} and V_{x1} , V_{x2} , line-to-line voltages V_{a1b1} and V_{x1y1} , and phase voltages V_{as} and V_{xs} of dual three-phase system with discontinuous synchronized PWM ($F = 35$ Hz, $V_{dc1} = 0.8 V_{dc2}$, $V_{dc2} = 0.9 V_{dc4}$, $V_{dc3} = 0.75 V_{dc4}$, $m_1 = 0.97$, $m_2 = 0.777$, $m_3 = 0.933$, $m_4 = 0.7$, $F_s = 1$ kHz).

where corresponding power of each inverter can be described as relative value of the total power of the system.

As an example of balanced operation of the system with four different levels of DC voltages, Figures 12 and 13 present basic voltage waveforms and spectra of the V_{a1b1} , V_{a2b2} , V_{as} and V_{xs} voltages for the dual three-phase system with discontinuous synchronized PWM with the 30° -nonswitching intervals. The fundamental and switching frequencies of each inverter are equal to $F = 35$ Hz and $F_s = 1$ kHz. Relative magnitudes of DC voltages are equal for this case, as parts of the maximum DC-voltage V_{dc4} :

$$V_{dc1} = 0.72 V_{dc4}; \quad V_{dc2} = 0.9 V_{dc4}; \quad V_{dc3} = 0.75 V_{dc4}. \quad (6)$$

Modulation index of the fourth inverter, supplied by the maximum DC-voltage V_{dc4} , is equal to $m_4 = 0.7$. Taking in consideration equal power distribution between the corresponding sources ($P_1 = P_2 = P_3 = P_4$), in accordance with (5), modulation indices of the corresponding inverters are equal to

$$m_1 = 0.97; \quad m_2 = 0.777; \quad m_3 = 0.933. \quad (7)$$

So, in this case control modes of two inverters, of the first and the third, correspond to overmodulation control. The proposed algorithm provides equal magnitudes of the phase fundamental voltages V_{as} and V_{xs} of dual three-phase system (see Figure 13), and, correspondingly, equal power distribution between two sets of three-phase windings of six-phase machine.

The motor phase voltages V_{as} and V_{xs} of six-phase drives on the base of four inverters with both continuous and discontinuous synchronized PWM have symmetry during the whole control range and for any operating conditions (see Figures 4–13), and their spectra do not contain even

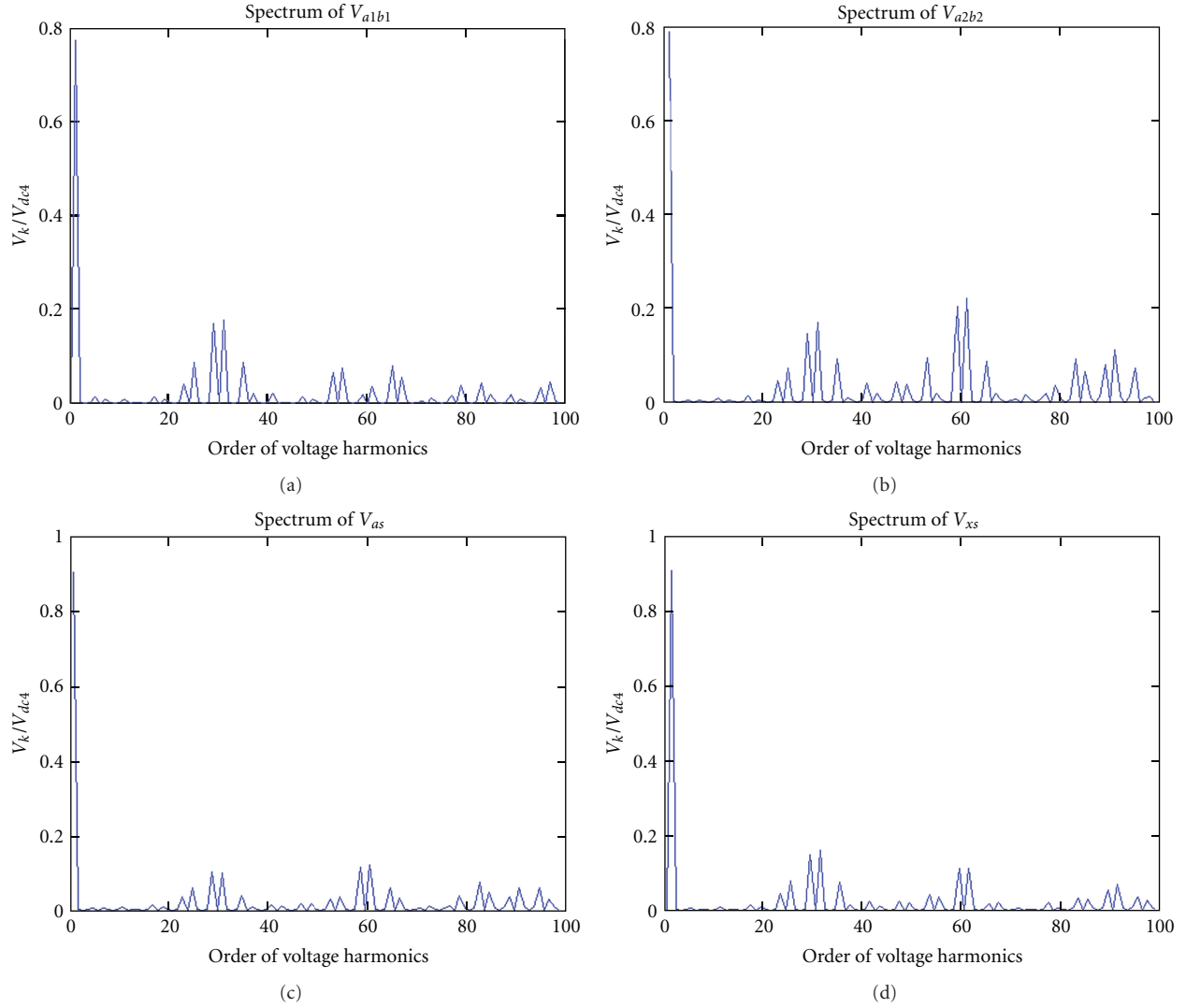

FIGURE 13: Spectra of the V_{a1b1} , V_{a2b2} , V_{as} and V_{xs} voltages of the system with discontinuous synchronized PWM ($F = 35$ Hz, $F_s = 1$ kHz).

harmonics and subharmonics, which is especially important for high power/current systems.

In order to compare characteristics of asymmetrical dual three-phase (six-phase) systems on the base of two inverters ([2], standard topology of the system), and on the base of four inverters (novel topology of six-phase system [6], analyzed in the paper), Figure 14 presents calculation results of Weighted Total Harmonic Distortion factor (WTHD) versus modulation index m for the motor phase voltage V_{as} (averaged values of $WTHD = (1/V_{as1})(\sum_{k=2}^{1000} (V_{as_k}/k)^2)^{0.5}$) for the six-phase drive with continuous (CPWM) and discontinuous (DPWM) schemes of synchronized modulation. In particular, DC-voltage magnitudes are equal in this case for all DC sources, so, modulation indices of all inverters are equal too. Control mode of the drive system corresponds here to standard scalar V/F control, and average switching frequency of each inverter is equal to $F_s = 1$ kHz.

The presented results show that integral spectral characteristics of the phase voltage of six-phase system on the base

of four inverters are much better than of the system on the base of two inverters.

Figure 15 presents results of analysis of spectral composition of the phase voltage V_{as} of dual three-phase system on the base of four inverters with both continuous (CPWM) and discontinuous (DPWM) versions of synchronized PWM for the case of nonequal magnitudes of DC voltages. In particular, for this case $V_{dc1} \neq V_{dc2}$ and $V_{dc3} \neq V_{dc4}$, but $V_{dc1} = V_{dc3}$ and $V_{dc2} = V_{dc4}$. Two basic control modes have been analyzed:

- (1) $V_{dc1} = 0.9 V_{dc2}$, $V_{dc3} = 0.9 V_{dc4}$, $K_{dc} = 0.9$ for this case;
- (2) $V_{dc1} = 0.7 V_{dc2}$, $V_{dc3} = 0.7 V_{dc4}$, $K_{dc} = 0.7$ for this case.

The presented results show that a value of the WTHD factor of the phase voltage of six-phase system on the base of four inverters controlled by algorithms of discontinuous

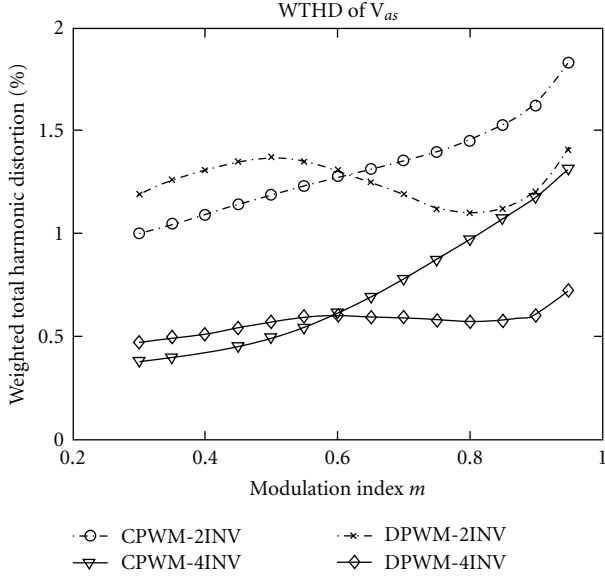

FIGURE 14: Averaged WTHD factor of the phase voltage V_{as} versus modulation index m for six-phase system on the base of two inverters (CPWM-2INV, DPWM-2INV), and for the system on the base of four inverters (CPWM-4INV, DPWM-4INV).

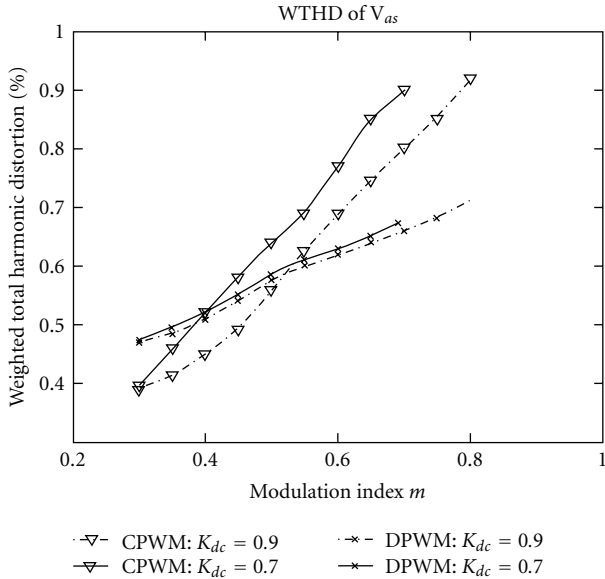

FIGURE 15: Averaged WTHD factor of the phase voltage V_{as} versus modulation index $m = m_2 = m_4$ for the six-phase system on the base of four inverters with nonequal DC voltages.

synchronized PWM is not strongly sensitive to relative magnitudes of DC voltages.

4. Conclusion

Space-vector-based algorithms of synchronized PWM, applied for control of four voltage-source inverters feeding asymmetrical dual three-phase (six-phase) induction motor

with open-end windings, allow continuous synchronization of the phase voltages in the system for any operating conditions. The presented results of MATLAB-based simulations of the system show in details its behavior. In particular, algorithms of continuous and discontinuous synchronized PWM provide voltage synchronization for any ratios (integral or fractional) between the switching and fundamental frequencies, and for any ratios of voltage magnitudes of four DC sources.

The phase voltages of six-phase drives on the basis of four inverters with synchronized PWM have symmetry during the whole control range, including the zone of overmodulation, and their spectra do not contain even harmonics and subharmonics, which is especially important for high power/high current applications.

Simple linear correlations between modulation indices of four three-phase inverters, magnitudes of DC voltages, and required power sharing between inverters provide requiring power balancing between DC sources and equivalence of the phase fundamental voltages of two groups of inverters.

Nomenclature

F :	Fundamental frequency
F_m :	Maximum fundamental frequency
i :	Number of notches inside a half of the clock interval
K_s :	Coefficient of synchronization
K_{ov1} :	The first coefficient of overmodulation
K_{ov2} :	The second coefficient of overmodulation
m_1, m_2, m_3, m_4 :	Modulation indices of four inverters
P_1, P_2, P_3, P_4 :	Power of four DC sources
$V_{dc1}, V_{dc2}, V_{dc3}, V_{dc4}$:	DC-sources voltages
$V_{a1}, V_{b1}, V_{c1}, V_{a2}, V_{b2}, V_{c2}$:	Pole voltages of the first and the second inverters
$V_{x1}, V_{y1}, V_{z1}, V_{x2}, V_{y2}, V_{z2}$:	Pole voltages of the third and fourth inverters
V_{as}, V_{bs}, V_{cs} :	Phase voltages of the first inverter group
V_{xs}, V_{ys}, V_{zs} :	Phase voltages of the second inverter group
$V_{a1b1}, V_{a2b2}, V_{x1y1}, V_{x2y2}$:	Line-to-line voltages of inverters
V_k :	Amplitude of the k -harmonic of voltage
V_0 :	Zero-sequence voltage
WTHD:	Weighted total harmonic distortion factor
β_1 :	Duration of the central active switching signal inside the clock interval
β_j :	Duration of others active switching signals
γ_j :	Duration of the minor part of the active switching signals

- λ_j : Duration of notches
 λ' : Duration of notches, generated at the clock points
 β'' : Duration of the β -signals, neighboring with the λ' notches
 τ : Width of sub cycle (switching interval).

References

- [1] E. Levi, R. Bojoi, F. Profumo, H. A. Toliyat, and S. Williamson, "Multiphase induction motor drives—a technology status review," *IET Electric Power Applications*, vol. 1, no. 4, pp. 489–516, 2007.
- [2] R. Bojoi, F. Farina, F. Profumo, and A. Tenconi, "Dual-three phase induction machine drives control—a survey," *IEEE Transactions on Industry Applications*, vol. 126, no. 4, pp. 420–429, 2006.
- [3] G. Grandi, G. Serra, and A. Tani, "General analysis of multiphase systems based on space vector approach," in *Proceedings of the IEEE-EPE Power Electronics and Motion Control Conference (EPE-PEMC '06)*, pp. 834–840, Portoroz, Slovenia, September 2006.
- [4] E. Levi, "Multiphase electric machines for variable-speed applications," *IEEE Transactions on Industrial Electronics*, vol. 55, no. 5, pp. 1893–1909, 2008.
- [5] V. Oleschuk and G. Griva, "Synchronised space-vector modulation for six-phase automotive drive with controlled switching frequency," *International Review of Electrical Engineering*, vol. 4, no. 1, pp. 50–56, 2009.
- [6] G. Grandi, A. Tani, P. Sanjeevikumar, and D. Ostojic, "Multiphase multi-level AC motor drive based on four three-phase two-level inverters," in *Proceedings of the IEEE International Symposium on Power Electronics, Electrical Drives, Automation and Motion (SPEEDAM '10)*, pp. 1768–1775, Pisa, Italy, June 2010.
- [7] J. Holtz, "Pulsewidth modulation for electronic power conversion," *Proceedings of the IEEE*, vol. 82, no. 8, pp. 1194–1214, 1994.
- [8] N. Mohan, T. M. Undeland, and W. P. Robbins, *Power Electronics*, John Wiley & Sons, 3rd edition, 2003.
- [9] R. K. Jordan, P. Stumpf, P. Bartal, Z. Varga, and I. Nagy, "A novel approach in studying the effects of subharmonics on ultrahigh speed AC motor drives," *IEEE Transactions on Industrial Electronics*, vol. 58, no. 4, pp. 1274–1281, 2011.
- [10] V. Oleschuk and F. Blaabjerg, "Direct synchronized PWM techniques with linear control functions for adjustable speed drives," in *Proceedings of the IEEE Applied Power Electronics Conference (APEC '02)*, pp. 76–82, Dallas, Tex, USA, March 2002.
- [11] V. Oleschuk, F. Blaabjerg, and B. K. Bose, "Analysis and comparison of algebraic and trigonometric methods of synchronous PWM for inverter drives," in *Proceedings of the IEEE Power Electronics Specialists Conference (PESC '02)*, pp. 1439–1444, June 2002.
- [12] V. Oleschuk, R. Bojoi, F. Profumo, A. Tenconi, and A. M. Stankovic, "Multifunctional six-phase motor drives with algorithms of synchronized PWM," in *Proceedings of the IEEE Industrial Electronics Conference (IECON '06)*, pp. 1293–1300, Paris, France, November 2006.
- [13] V. Oleschuk, F. Profumo, and A. Tenconi, "Five-phase inverters with synchronized pulsewidth modulation," *International Review of Electrical Engineering*, vol. 2, no. 2, pp. 123–129, 2007.
- [14] V. Oleschuk, R. Bojoi, G. Griva, and F. Profumo, "Dual inverter-fed traction drive with DC sources power balancing based on synchronized PWM," in *Proceedings of the IEEE International Electrical Machines and Drives Conference (IEMDC '07)*, pp. 260–265, Antalya, Turkey, May 2007.
- [15] V. Oleschuk, F. Profumo, and A. Tenconi, "Analysis of operation of symmetrical dual three-phase converters with hybrid schemes of synchronised PWM," *International Review of Electrical Engineering*, vol. 2, no. 6, pp. 793–802, 2007.
- [16] V. Oleschuk and G. Griva, "Simulation of processes in synchronized cascaded inverters for Photovoltaic application," *International Review of Electrical Engineering*, vol. 4, no. 5, pp. 928–936, 2009.
- [17] V. Oleschuk, G. Griva, and F. Spertino, "Dual neutral-point-clamped converters with synchronized PWM for photovoltaic installations," *International Review of Electrical Engineering*, vol. 5, no. 1, pp. 56–63, 2010.
- [18] H. Stemmler and P. Guggenbach, "Configurations of high-power voltage source inverter drives," in *Proceedings of the European Power Electronics Conference (EPE '93)*, pp. 7–12, September 1993.
- [19] E. G. Shivakumar, K. Gopakumar, S. K. Sinha, A. Pittet, and V. T. Ranganathan, "Space vector PWM control of dual inverter fed open-end winding induction motor drive," in *Proceedings of the IEEE Applied Power Electronics Conference (APEC '01)*, pp. 399–405, March 2001.

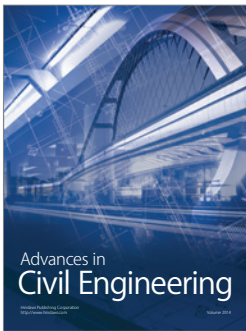
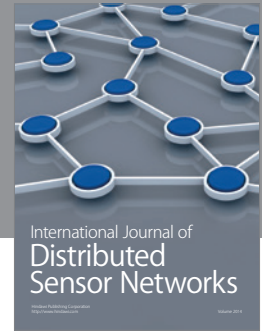
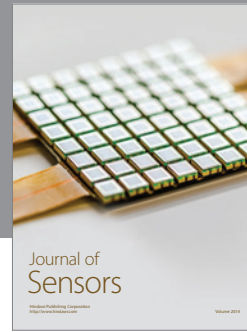
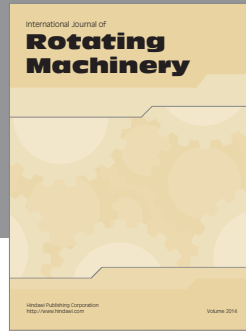

Hindawi

Submit your manuscripts at
<http://www.hindawi.com>

