



Effectiveness of antiscalants in preventing calcium phosphate scaling in reverse osmosis applications

M. Nasir Mangal^{a,b,*}, Sergio G. Salinas-Rodriguez^a, Jos Dusseldorp^c, Antoine J.B. Kemperman^b, Jan C. Schippers^a, Maria D. Kennedy^{a,d}, Walter G.J. van der Meer^{b,c}

^a IHE Delft Institute for Water Education, Water Supply, Sanitation and Environmental Engineering Department, Westvest 7, 2611, AX, Delft, Netherlands

^b University of Twente, Faculty of Science and Technology, P.O. Box 217, 7500, AE, Enschede, Netherlands

^c Oasen Drinkwater, Nieuwe Gouwe O.Z. 3, 2801, SB, Gouda, Netherlands

^d Delft University of Technology, Faculty of Civil Engineering, Stevinweg 1, 2628, CN, Delft, Netherlands

ARTICLE INFO

Keywords:

Calcium phosphate
Scaling
Antiscalant
BWRO
Fouling

ABSTRACT

Antiscalants are well known to prevent the precipitation of carbonate and sulphate scales of calcium in reverse osmosis (RO) applications, but according to literature their inhibitory ability against calcium phosphate is not clear. The objective of this study was to investigate if antiscalants, without acid addition, can prevent calcium phosphate scaling in RO systems. Eight calcium phosphate antiscalants from different manufacturers spanning a range of concentrations were tested in batch (in glass reactors) experiments to inhibit the formation of calcium phosphate in synthetic concentrate corresponding to 85% recovery ($\text{Ca}^{2+} = 765 \text{ mg/L}$, $\text{PO}_4^{3-} = 13\text{--}15 \text{ mg/L}$ and $\text{pH} = 7.6$) of a groundwater RO in the Netherlands. Additionally, once-through lab-scale RO tests were conducted where an RO element was fed with synthetic concentrate and the performance of antiscalants was evaluated from the rate of flux-decline in the RO element. Without antiscalant addition, a substantial flux-decline was observed due to the deposition of amorphous calcium phosphate (ACP) on the RO membrane. The tested antiscalants were unable to inhibit the formation of ACP and were incapable of preventing the deposition of the formed ACP particles, since with each antiscalant, the flux of the RO element decreased at least 15% in a 3-h period. Briefly, the available antiscalants, tested in this study, did not provide acceptable inhibition of calcium phosphate scaling in RO applications.

1. Introduction

With the continuous development of RO technology, its application is not limited to only seawater desalination (ca. $40 \text{ Mm}^3/\text{day}$ worldwide capacity), but RO is also increasingly applied in producing drinking water from (brackish) groundwater and surface water (ca. $28.5 \text{ Mm}^3/\text{day}$ worldwide capacity) as well as in the treatment of secondary wastewater effluent (ca. $8 \text{ Mm}^3/\text{day}$ worldwide capacity) [1]. To reduce the operational costs of RO and its impact on the environment, it is favourable to have the recovery of the RO as high as possible, since the specific energy consumption (kWh/m^3) and the production of concentrate (waste) are both low at high recoveries. However, in brackish water RO (BWRO) applications, RO recovery is generally limited due to membrane scaling. Scaling is the precipitation of sparingly soluble salts at the membrane surface which may occur when the concentration of the salts on the membrane surface exceeds their solubility limits.

Depending on the feed water composition, various compounds can precipitate on the surface of RO membranes such as calcium carbonate, calcium sulphate, barium sulphate, etc. Furthermore, in the RO treatment of wastewater and groundwater containing high phosphate and calcium concentrations, calcium phosphate may also be a problematic compound limiting RO recovery. This study focuses on calcium phosphate scaling in BWRO systems.

Calcium phosphate can exist in various forms such as an amorphous phase, i.e., ACP and in crystalline phases namely, monocalcium phosphate monohydrate ($\text{Ca}(\text{H}_2\text{PO}_4)_2 \cdot \text{H}_2\text{O}$; MCPD) and its anhydrous form, dicalcium phosphate dihydrate ($\text{CaHPO}_4 \cdot 2\text{H}_2\text{O}$; DCPD) and its anhydrous form, β -tricalcium phosphate ($\beta\text{-Ca}_3(\text{PO}_4)_2$; $\beta\text{-TCP}$), hydroxyapatite ($\text{Ca}_5(\text{PO}_4)_3(\text{OH})$; HA) [2]. In RO applications, not all of the mentioned phases could be encountered. For instance, the formation of MCPD, DCPD and their anhydrous forms occur at pH values below 6.5 [2], and therefore their precipitation in RO applications where pH is

* Corresponding author. IHE Delft, Westvest 7, 2611, AX, Delft, Netherlands.

E-mail addresses: m.mangal@un-ihe.org, muhammadnasir8684@gmail.com (M.N. Mangal).

<https://doi.org/10.1016/j.memsci.2021.119090>

Received 5 October 2020; Received in revised form 10 January 2021; Accepted 17 January 2021

Available online 22 January 2021

0376-7388/© 2021 The Authors. Published by Elsevier B.V. This is an open access article under the CC BY license (<http://creativecommons.org/licenses/by/4.0/>).

above 7 is less likely. Additionally, the formation of β -TCP occurs at temperatures above 700 °C [3], thus it cannot be observed in RO systems. The formation of HA, which is the most thermodynamically stable and least soluble phase of calcium phosphate, could occur in the neutral to basic pH range [4]. However, its formation normally is preceded by ACP [5–9] which suggests that HA may not be the first species responsible for flux decline in RO applications.

ACP, as generally agreed, is the first phase of calcium phosphate that forms in the nearly neutral to basic pH range when its solubility is exceeded [10]. Dorozhkin [2] suggested that ACP may not occur as an individual compound of calcium phosphate, but simply as an amorphous precursor and state of other crystalline calcium phosphate species. The stability of ACP can be affected by various factors including but not limited to pH, temperature and presence of other ions [11]. It is reported that at higher pH values until 10–10.5, the life time of ACP increases and becomes more stable, while in the acidic pH range (3–4), ACP has a shorter life time (few minutes) and is transformed to DCPD [4]. LeGeros et al. [12] reported that the formation of ACP was preferred and the conversion of ACP to HA was hindered in the presence of magnesium, ferrous and carbonate. Furthermore, it is reported that in the presence of humic substances, i.e., humic acid, the transformation of ACP to other phases is hindered [13,14]. Based on this information, one may recognize that the formation of ACP is favoured in RO concentrates when high concentrations of calcium and phosphate are present in the feed water. Therefore, the amorphous phase (and not the crystalline phases) of calcium phosphate may be the first compound that could form and cause flux decline in RO processes where pH is above 7.

It is well established that the problem with the crystalline scales, i.e., CaCO_3 , BaSO_4 , CaSO_4 , etc. can be alleviated with the addition of antiscalants to the RO feed [15–17]. However, it is not clear if antiscalants can be effective in preventing flux decline in RO caused by the deposition of ACP particles. In general, the main mechanisms of the antiscalants in preventing scale formation are grouped into three categories: threshold inhibition, crystal distortion, and dispersion [18]. For the antiscalants to be effective against ACP, they should be able to either hinder the formation of ACP particles, i.e., prolonging the induction time due to their threshold inhibition mechanism and/or should not allow the deposition of the formed ACP particles on the RO membranes, i.e., by adsorbing on the particles and reducing their affinity to adhere on the membrane surface due to their dispersion capabilities.

Until now, the role of antiscalants in hindering the formation and deposition of ACP particles on the membrane surface is ambiguous. For instance, Chesters [19] reported that an antiscalant (a blend of phosphonates and carboxylic acids) was effective in preventing calcium phosphate scaling in a waste water re-use plant at 75% recovery with calcium and orthophosphate concentrations of 160 mg/L and 15–25 mg/L in the feed water, respectively. Furthermore, Chesters [19] stated that a small dose (2–5 mg/l) of the mentioned antiscalant can raise the solubility of calcium phosphate 150 times which can eliminate the use of

acids in wastewater RO applications (where calcium phosphate is a major challenge due to high phosphate levels in the feedwater, typically 10–30 mg/l) to control calcium phosphate scaling.

Greenberg et al. [20], on the other hand, reported that antiscalants (including the antiscalant which was a blend of phosphonates and carboxylic acids) were not effective in preventing calcium phosphate precipitation on the RO membrane when fed with a synthetic concentrate solution ($\text{Ca}^{2+} = 330 \text{ mg/L}$, $\text{PO}_4^{3-} = 28 \text{ mg/L}$). In their study, however, experiments were performed using a tubular RO membrane where permeate and concentrate were recycled back to the feed tank. RO pilot studies conducted with concentrate/permeate recirculation are often a matter of debate among researchers for not being representative to the conditions of full scale RO systems because of: (i) the residence time in a recycled system is much longer (in the range of hours) than the residence time (<1 min) of the concentrate in the last stage of full scale RO plants, and (ii) recycling of concentrate back to the feed tank may accelerate the process of scaling as micro(crystals) may be formed. Furthermore, antiscalant manufacturers emphasize that antiscalants may not be as effective in recycled systems as they should be in once-through flow systems (like RO systems) and therefore the performance of antiscalants assessed in recycled systems may not be representative.

From the available literature, one may realize that until now a study to investigate the performance of antiscalants in preventing the formation and deposition of ACP in RO systems using once-through RO experiments with synthetic solutions (where calcium and phosphate are the only precipitating ions) is not available. Additionally, as new antiscalants have been introduced to the market over the years, there is a need for a study to assess the performance of commercially available antiscalants in preventing the deposition of ACP in RO processes.

In this study, the effectiveness of eight antiscalants (dispersants), available for calcium phosphate, from seven different antiscalant manufacturers in preventing the formation and deposition of ACP particles in RO was investigated. A once-through lab-scale RO setup, without recycling the concentrate/permeate back to the feed, was developed to test the performance of the antiscalants. In this study, the following questions are addressed:

- Can ACP particles cause flux decline in RO applications?
- Can antiscalants inhibit the formation of ACP particles?
- If antiscalants are unable to inhibit the formation of ACP particles, can they prevent the deposition of the formed ACP particles in RO systems?

2. Materials and methods

2.1. Batch experiments to study the effectiveness of antiscalants in preventing the formation of ACP

Experiments were performed with synthetic concentrate solutions having the same calcium and orthophosphate concentrations that were present in real RO concentrates of 80 and 85% recoveries in an RO system treating anaerobic groundwater ($\text{Ca}^{2+} = 115 \text{ mg/L}$, $\text{PO}_4^{3-} = 2.1 \text{ mg/L}$ and $\text{pH} = 7.05$) in the Netherlands. More precisely, the synthetic concentrate of 80% recovery contained approximately 575 mg/L of Ca^{2+} , 10.5 mg/L of PO_4^{3-} and had a pH about 7.4, and the synthetic concentrate of 85% recovery contained 767 mg/L of Ca^{2+} , 14 mg/L of PO_4^{3-} , and had a pH of 7.6. The concentration of bicarbonate in the synthetic concentrate solutions was approximately 200 mg/L for the pH adjustment. To prepare the synthetic concentrate solutions, Milli-Q water, with a conductivity <10 $\mu\text{S/cm}$ and total organic carbon (TOC) < 30 $\mu\text{g/L}$, was used. Milli-Q was obtained by treating tap water with the Elix® Advantage system (Merck Millipore). To prepare the synthetic solutions, ACS grade chemicals of $\text{CaCl}_2 \cdot 2\text{H}_2\text{O}$, NaHCO_3 , KH_2PO_4 from Merck were employed.

The scaling tendency, i.e., saturation index (SI) of calcium phosphate in the synthetic concentrate of 80 and 85% recoveries was calculated

Table 1

Properties of the tested antiscalants with their arbitrary names assigned in this study.

Antiscalant name ^a	pH	Specific gravity	Chemical nature
AS-A	6.0–6.4	1.14–1.16	Blend of phosphonates and carboxylic acids
AS-B	4.5–6.5	1.15 ± 0.05	Proprietary acrylic polymer with chelate agent
AS-C	4.0–4.5	1.15	A group of aminophosphonate
AS-D	2.0–3.0	1.22–1.26	Phosphinocarboxylic acid
AS-E	3.0 ± 0.5	1.10 ± 0.05	Information not available
AS-F	3.5	1.16	Polycarboxylate
AS-G	4.5	1.22	Sulfonated Polycarboxylate
AS-H	4.0	1.26	A modified polycarboxylate

^a The actual names of the antiscalants are replaced with the arbitrary names.

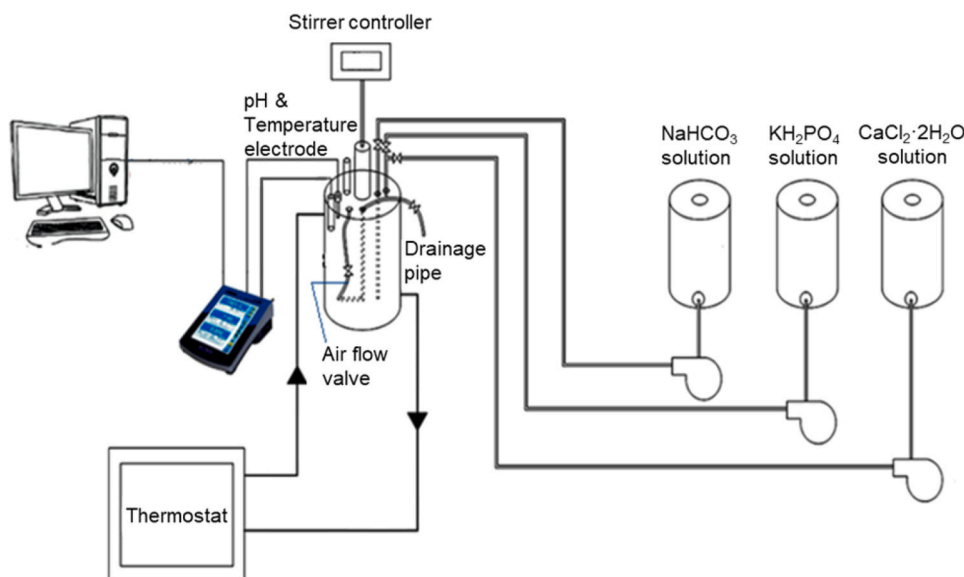

Fig. 1. Batch setup for calcium phosphate scale inhibition studies.

using Visual MINTEQ (version 3.1), Hydranautics IMS-Design (version 2.227.85) and with the projection programs of various antiscalant manufacturers.

In general, the antiscalant dose recommended by the antiscalant suppliers lies in the range between 2 to 5 mg/L in the feed water [21]. In this study, antiscalant doses of 2 mg/L and 5 mg/L in the feed water were tested which corresponded to 13.3 mg/L and 33.3 mg/L in the synthetic concentrate of 85% recovery, respectively. The doses greater than 5 mg/L was not employed, since the maximum antiscalant dose recommended by the antiscalant suppliers was 5 mg/L. In this paper, the actual names of the eight tested antiscalants (dispersant) were replaced with arbitrary names. In Table 1, the arbitrary names of the tested antiscalants with some properties which were shared by the antiscalant suppliers are presented.

2.1.1. Experiments in the applikon glass reactors to study the formation of ACP

To investigate the effect of antiscalants on the formation of ACP, experiments were performed with the synthetic concentrate solutions in an air-tight double wall 3 L Applikon (Delft, Netherlands) glass reactor. A schematic diagram of the experimental setup is illustrated in Fig. 1. The internal diameter and height of the reactor were 12 cm and 24 cm, respectively. The reactor consisted of a mixing controller and a shaft to allow the solution to be stirred at a rate of 150 rpm. A thermostat was employed for maintaining a constant temperature of 20 °C during the test.

To run an experiment, the 3 L reactor was initially half-filled with NaHCO₃ and KH₂PO₄ solutions. Then, the pH was adjusted to the desired value (7.5–7.6) using a 0.1 M NaOH solution or 0.1 M HCl solution. Following this, antiscalant was added to the solution of NaHCO₃ and KH₂PO₄. Afterwards, the remaining half of the reactor was filled with the CaCl₂·2H₂O solution through the fine nozzles located 3 cm from the bottom of the reactor to maintain the uniform distribution of the solution. While adding the CaCl₂·2H₂O solution, the mixture in the reactor was stirred at 150 rpm to allow uniform mixing of the solutions and to avoid the occurrence of any local supersaturated zones.

2.1.1.1. Turbidity measurements to detect the formation of ACP in Applikon glass reactors. To detect the formation of calcium phosphate in the synthetic concentrate solutions, turbidity measurements were conducted using the HACH Turbidimeter (Model 2100AN, USA). The measurements were executed immediately after filling the reactor with

CaCl₂·2H₂O solution, and every 15 min thereafter. For each turbidity measurement, approximately 30 mL of the solution was taken from the reactor. An increase in turbidity from the initial turbidity values (0.08 NTU) of the individual synthetic solutions of CaCl₂·2H₂O, NaHCO₃ and KH₂PO₄ would indicate the formation of precipitates, i.e., calcium phosphate.

At the end of each experiment, the reactor was filled with 0.2 M HCl to dissolve any calcium phosphate particles attached to the reactor. The HCl solution was stirred at 1250 rpm for 30 min. After acid cleaning, the reactor was flushed twice with demineralized water for 10 min.

2.1.1.2. Dead-end filtration tests with 0.45 μm and 100 kDa membrane filters to detect the formation of ACP in Applikon glass reactors. To detect the presence of ACP in the synthetic concentrate solutions in case of no increase in turbidity, the synthetic concentrate solutions were filtered either (i) at constant pressure of 2 bar through 0.45 μm filters (cellulose acetate, Whatman) where the filtration volume was between 1–1.5 L, and/or (ii) at constant flux of 100 L/m²/h through a 100 kDa filter (Polyether sulfone, Merck) where the filtration volume was between 40–50 mL. In the former case, a decrease in flux, whereas in the latter case, an increase in pressure would indicate the presence of formed particles in the synthetic concentrate solutions since no decrease in flux (in the former case) and increase in pressure (in the latter case) would occur when the individual solutions of CaCl₂·2H₂O, NaHCO₃ and KH₂PO₄ were filtered. The retained deposits were then examined by scanning electron microscopy (SEM) (JEOL, JSM-6010LA, Japan). Additionally, the deposits on the filter were analysed with X-ray powder diffraction (XRD) (Bruker D8 Advance) to determine the phase of precipitated calcium phosphate.

2.1.1.3. Particle size measurement. Furthermore, a number of measurements were performed with a Zetasizer-Nano-ZS (Malvern Panalytical) to know the effect of antiscalants on the size of ACP particles, i.e., agglomeration of ACP particles. To measure the particles size of ACP, samples of the synthetic concentrate solution from the Applikon glass reactor were taken immediately after filling the reactor with CaCl₂·2H₂O solution and directly at the end of each experiment (ca. 60 min).

2.2. Lab-scale RO experiments to study the performance of antiscalants in preventing the deposition of ACP in RO applications

To evaluate the performance of antiscalants in preventing ACP

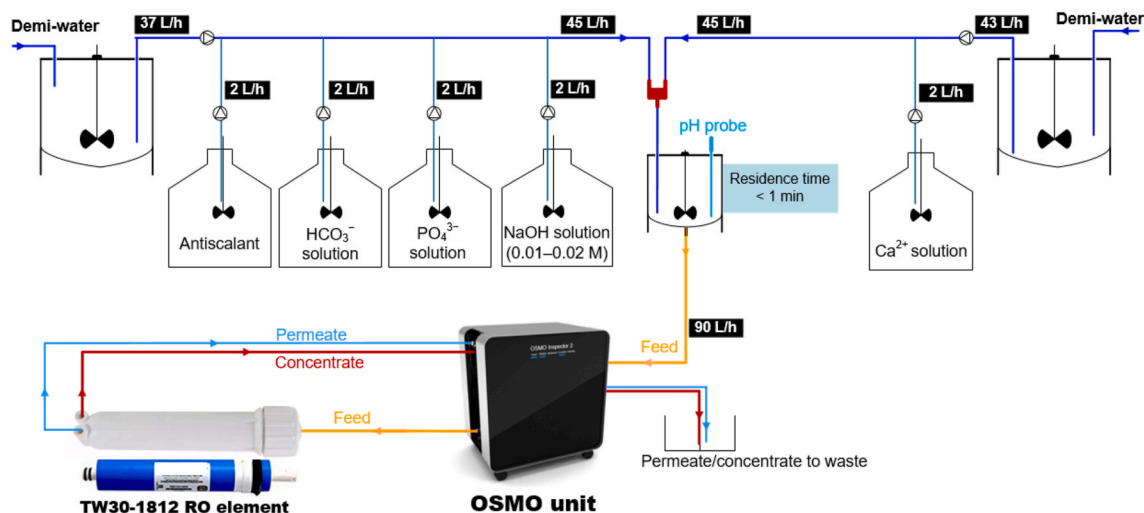

Fig. 2. Once-through lab-scale RO setup for calcium phosphate scale inhibition studies.

deposition in RO systems, a lab-scale RO setup (Fig. 2) was used. In this setup, as illustrated, antiscalant, HCO_3^- , PO_4^{3-} and NaOH were dosed from stock solutions each at 2 L/h to a stream of demineralized-water (demi-water) with a flow rate of 37 L/h, resulting in a final flow rate of 45 L/h. The dosage of NaOH was executed from a 0.01–0.02 M stock solution to adjust the pH of the final solution to 7.6. To another stream of demi-water (with a flow rate of 43 L/h), Ca^{2+} was dosed from the stock solution at 2 L/h, also resulting in a final flow rate of 45 L/h. Both streams were then connected to a single pipe resulting in the final flow rate of 90 L/h which had nearly the same composition of the synthetic concentrate of 85% recovery. The final solution (synthetic concentrate solution) was introduced to a 4 L reactor in which the synthetic concentrate solution was stirred at a rate of 200 rpm with a residence time shorter than 1 min. The residence time of less than 1 min was achieved by maintaining equal flow rates (90 L/h) of the synthetic concentrate solution entering and leaving the reactor and by keeping the volume of the synthetic concentrate solution in the reactor to approximately 1.5 L.

The synthetic solution was fed at a rate of 90 L/h to a TW30-1812-50 RO element (OsmoPure Water Systems) with the use of an OSMO Inspector unit (Convergence Industry B.V., Netherlands). The OSMO unit was equipped with a very sensitive flow meter (with high accuracy) which could measure the permeate flow rate of 2 mL/min (0.12 L/h) to 500 mL/min (30 L/h). The piping and instrumentation diagram (P&ID) of the OSMO unit is shown in Fig. S1. For each experiment, a new RO element was used. In all experiments, the initial recovery of the membrane element was in the range of 5–6% and the permeate flux was between 13–15 $\text{L}/\text{m}^2/\text{h}$. According to the membrane manufacturer, the minimum ratio of the concentrate flow to the permeate flow should not drop below 5. In this study, the concentrate flow was 18 times greater than the permeate flow. The cross flow velocity was in the 10–12 cm/s range. Both permeate and concentrate were directed to the drain. All experiments were carried out at room temperature (20–23 °C).

3. Results and discussion

3.1. Scaling potential of calcium phosphate in the synthetic concentrates of 80 and 85% recoveries

In Table 2, SI values of various phases of calcium phosphate, calculated with Visual MINTEQ, for the synthetic concentrate solutions of 80 and 85% recoveries are presented. As can be seen, all crystalline phases of calcium phosphate, except DCPD, were supersaturated at both 80 and 85% recoveries. The formation of DCPD, as discussed earlier in section 1,

occurs in the acidic pH range and therefore its precipitation in the synthetic concentrate of 80% (pH = 7.4) and 85% (pH = 7.6) recoveries used in this research is not likely. Additionally, the precipitation of β -Tricalcium phosphate in the synthetic concentrate solutions is also not expected since it forms at very high temperatures as mentioned earlier in section 1. This means that octacalcium phosphate and hydroxyapatite are the crystalline calcium phosphate species that might precipitate in the synthetic solutions of 80 and 85% recoveries. Whether these compound(s) and which compound(s) exactly will cause flux-decline in RO, will be addressed shortly in the coming sections. In addition, the program suggested that ACP may form in the synthetic concentrate of 85% recovery as SI was greater than zero, while its formation in the synthetic concentrate of 80% is not likely since the SI value was negative.

Based on the Hydranautics IMS-Design program, calcium phosphate ($\text{Ca}_3(\text{PO}_4)_2$) was supersaturated at both 85 and 80% recoveries and the SI values were 2.1 and 1.7, respectively which suggested that calcium phosphate scaling may occur at the aforementioned recoveries. On the other hand, from the Filmtec technical manual [22], in which the formula of Kubo et al. [23] is mentioned for the determination of the saturation level of calcium phosphate, the calculated SI value of calcium phosphate ($\text{Ca}_3(\text{PO}_4)_2$) for the synthetic concentrate of 80% recovery was -0.25 which suggested that calcium phosphate scaling at the aforementioned recovery is unlikely. Whereas, for the synthetic concentrate of 85% recovery, the SI value with the formula proposed by Kubo et al. [23] was 0.33 which indicated that calcium phosphate scaling may occur at 85% recovery.

According to the projection programs of some antiscalant suppliers, calcium phosphate with the chemical formula $\text{Ca}_3(\text{PO}_4)_2$ was undersaturated at both 85 and 80% recoveries and according to some others, the SI of calcium phosphate was considered in the safe range which meant that calcium phosphate precipitation would not occur at these recoveries. The exact reason for the discrepancies in the SI values given by the projection programs of the antiscalant suppliers is not known but it could be that every program uses a different method to determine the saturation level of calcium phosphate or perhaps the discrepancy comes from the differences in the reported values of solubility products for calcium phosphate in literature. For instance, in the case of ACP, it is challenging to precisely determine its solubility and therefore different solubility products were given by various researchers [11,24].

In brief, at this point, it is not clear whether or not the formation of calcium phosphate, or more precisely, the formation of ACP would occur in the synthetic concentrate of 85 and 80% recoveries due to the differences in the SI levels. The formation of calcium phosphate at both 85 and 80% will be investigated in the coming sections.

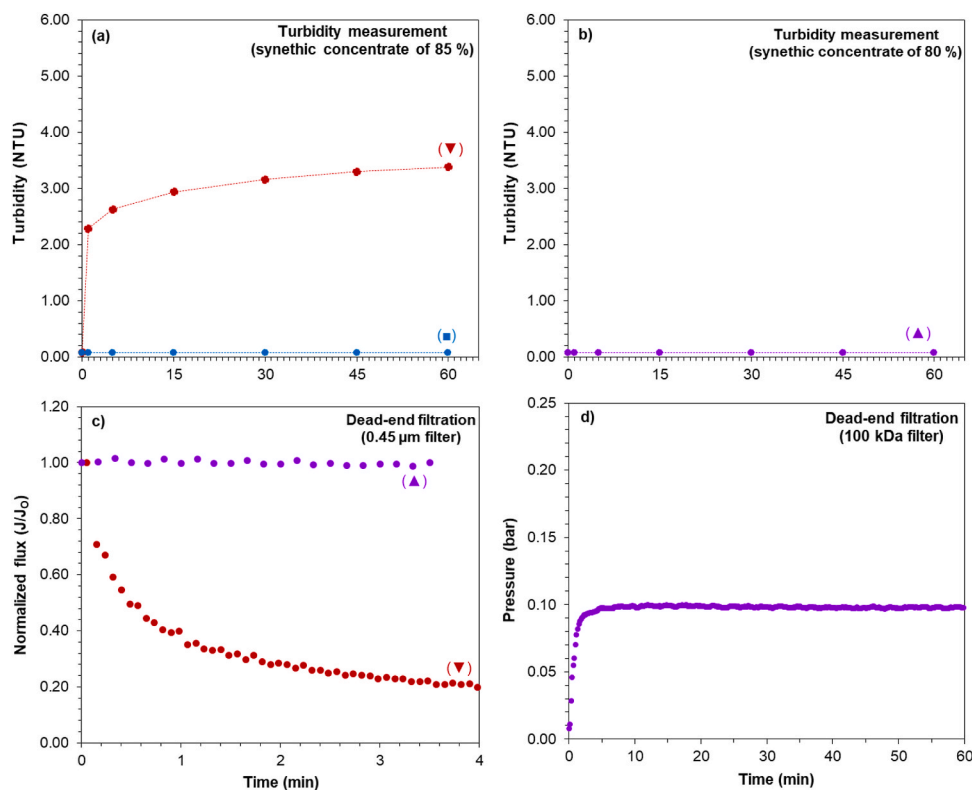

Fig. 3. a) Turbidity values of the (▼) synthetic concentrate of 85%, and (■) synthetic concentrate of 85% (without phosphate), b) turbidity values of the (▲) synthetic concentrate of 80%, c) Normalized flux of the (▼) synthetic concentrate of 85%, and (▲) synthetic concentrate of 80% when each filtered through 0.45 μm filter at constant pressure of 2 bar, and d) pressure to maintain the constant flux of 100 L/m²/h of the synthetic concentrate of 80% when filtered through 100 kDa filter.

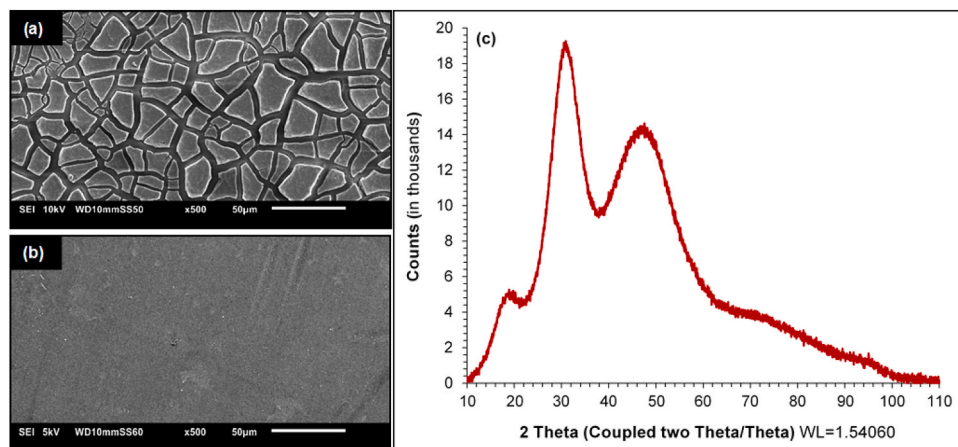

Fig. 4. a) SEM image (500× magnification) of the 0.45 μm filter after filtering the synthetic concentrate of 85% recovery, b) SEM image (500× magnification) of the 100 kDa filter after filtering the synthetic concentrate of 80% recovery, and c) XRD analysis of the retained deposits on the 0.45 μm filter after filtering the synthetic concentrate of 85% recovery.

3.2. Formation of ACP in the synthetic concentrates of 80 and 85% recoveries

In section 3.1, it became difficult to know if calcium phosphate would form in the synthetic concentrates of 80 and 85% recoveries due to the discrepancies in the SI values. In this section, the question “Does calcium phosphate form in the synthetic concentrate of 80 and 85% recoveries, and if it does, which phase(s) of calcium phosphate would form in the synthetic concentrates?” is addressed.

In Fig. 3a, turbidity values of the synthetic concentrate solutions of

85% recovery are shown. As illustrated, the formation of ACP (explained later in Fig. 4a and Fig. 4c) in the synthetic concentrate solution of 85% recovery was immediate. In less than 1 min, the turbidity value of the synthetic concentrate increased from 0.08 NTU to approximately 2.1 NTU which further increased to approximately 3.4 NTU after 60 min. This result showed that ACP was supersaturated at 85% recovery and the projection programs of some antiscalant suppliers underestimated the saturation level (SI < 0) of ACP. It is worth mentioning that the observed increase in turbidity in Fig. 3a was only due to the formation of ACP. Although CaCO₃ was also supersaturated (SI = 0.9) in the synthetic

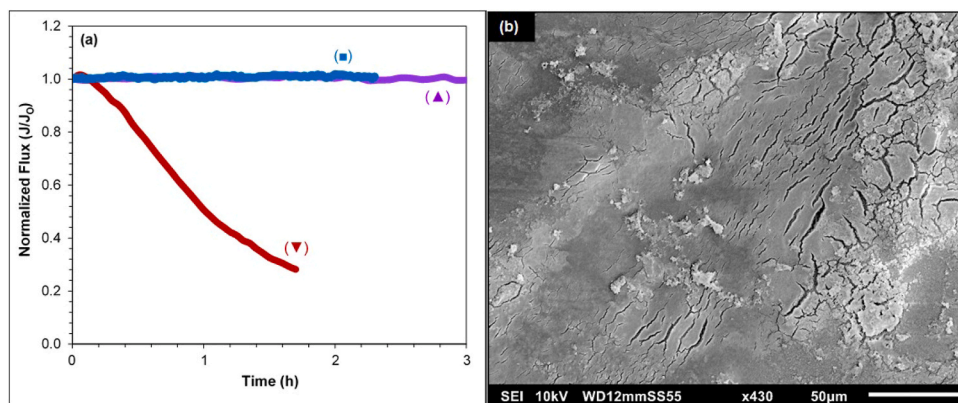

Fig. 5. (a) Normalized flux of the TW30-1812-50 RO element fed with (▼) synthetic concentrate of 85% recovery (with phosphate) without antiscalant addition, (■) synthetic concentrate of 85% recovery in the absence of phosphate and antiscalant, and (▲) synthetic concentrate of 80% recovery (with phosphate) without antiscalant addition, (b) SEM image of the membrane surface of the RO element fouled with the synthetic concentrate of 85% recovery (with phosphate) without antiscalant.

concentrate of 85%, its formation did not occur during the experiment which can be clearly seen from the turbidity values of the synthetic concentrate of 85% recovery in the absence of phosphate (Fig. 3a). The turbidity values of the synthetic concentrate, in the absence of phosphate, did not increase from the initial value of 0.08 NTU during the entire experiment. In addition, pH of the synthetic concentrate of 85% was monitored and no decrease in pH was observed which confirmed that CaCO₃ did not precipitate in the solution and had an induction time of longer than 60 min.

In Fig. 3b, turbidity values of the synthetic concentrate of 80% recovery are shown. As can be seen, turbidity of the synthetic concentrate did not increase in 60 min which suggested that ACP did not form at this recovery. In Fig. 3c, flux of the synthetic concentrate solutions of 80 and 85% recoveries when filtered through 0.45 μm filter at constant pressure of 2 bar is shown. As can be seen, no decrease in flux was observed when 1.4 L of the synthetic concentrate of 80% recovery was filtered which also indicated that ACP did not form in the solution, while flux decreased by about 80% after filtering approximately 0.4 L of the synthetic concentrate of 85% recovery. In Fig. 4a, SEM pictures of the 0.45 μm filter after filtering the synthetic concentrate of 85% is shown. The retained deposits on the 0.45 μm filter were amorphous since crystalline peaks, resembling with the peaks of OCA and HA, were not observed in the XRD analysis as illustrated in Fig. 4c. This indicated that ACP formed first before the formation/precipitation of crystalline phases of calcium phosphate, i.e., octacalcium phosphate and hydroxyapatite. This observation is in agreement to the findings of some researchers [25,26] in applications other than RO.

One may argue that the constant flux with the synthetic concentrate of 80% in Fig. 3c could be due the fact that ACP particles were much smaller than 0.45 μm which possibly were not retained on the filter. However, this was not the case since no increase in pressure was observed when the concentrate of 80% recovery was filtered through a 100 kDa filter (with an average pore size of 10 nm) at constant flux of 100 L/m²/h (Fig. 3d). Furthermore, no particles were observed on the 100 kDa filter in the SEM analysis as illustrated in Fig. 4b which revealed that ACP did not form in the synthetic concentrate of 80% recovery.

3.3. Flux decline in RO applications due to the deposition of ACP particles

In the previous section, it was found that the formation of ACP occurred in the synthetic concentrate of 85% recovery, while it did not form in the synthetic concentrate of 80% recovery. In this section the question “Can ACP particles, in the absence of antiscalants, deposit on the membrane surface and cause flux decline in RO applications?” is addressed with the use of lab-scale RO.

Fig. 5a presents the normalized flux of the TW30-1812-50 RO element when fed (i) with the synthetic concentrate of 85% recovery which contained phosphate ions but no antiscalant, (ii) with the synthetic concentrate of 85% which contained neither phosphate nor

Table 2

SI of calcium phosphate phases for the synthetic concentrates of 80 and 85% recoveries with Visual MINTEQ.

Compound	Formula	R = 80%	R = 85%
ACP	Ca ₃ (PO ₄) ₂	-0.70	0.13
DCPD	CaHPO ₄ ·2H ₂ O(s)	-0.23	-0.07
β-TCP	Ca ₃ (PO ₄) ₂ (beta)	2.97	3.79
OCF	Ca ₄ H(PO ₄) ₃ ·3H ₂ O(s)	2.16	3.15
HA	Ca ₁₀ (PO ₄) ₆ (OH) ₂	11.50	12.94

antiscalant, and (iii) with the synthetic concentrate of 80% recovery which contained phosphate ions but no antiscalant. As can be seen, the normalized flux decreased sharply, i.e., approximately 75% in less than 2 h when the RO element was fed with the synthetic concentrate of 85% recovery which contained phosphate but no antiscalant. The sharp decrease was caused due to the deposition of ACP particles which formed a cake layer on the membrane surface as illustrate in Fig. 5b.

On the other hand, the normalized flux remained constant when the RO element was fed with the synthetic concentrate of 85% recovery (in the absence of phosphate) without antiscalant addition. The purpose of the second experiment (with the synthetic concentrate of 85% in the absence of phosphate) was to verify that the flux decline in the first experiment (with the synthetic concentrate of 85% in the presence of phosphate) was only due to ACP and that calcium carbonate formation/precipitation did not contribute to the observed flux decline. It was expected that the precipitation of calcium carbonate would not occur in the RO element since it was already known from the turbidity measurements (Fig. 3a) and the stable pH throughout the experiment.

Furthermore, as illustrated in Fig. 5a, the normalized flux of the RO element fed with the synthetic concentrate of 80% recovery remained constant for an experimental period of 3 h which is in agreement with the results of the batch experiments (Fig. 3c) where no increase in turbidity was observed. This suggested that ACP may not be an issue at 80% recovery. It is worth mentioning that the experiment was run for a period of 3 h, but if the unit was run for a period longer than a week or even month(s), would other phases of calcium phosphate such as Hydroxyapatite (SI = 11.5) precipitate on the membrane? This is an open question which was not addressed here as it was beyond the scope of this paper. It is, however, difficult to run a once-through experiment with synthetic concentrate for long periods of time since this requires the use of a massive amount of high grade chemicals.

In brief, the results presented in Fig. 5a revealed that ACP particles can deposit on the membrane surface and can cause noticeable flux decline in RO systems.

Table 3

Turbidity of the synthetic concentrate of 85% recovery without antiscalant addition and with 13.3 and 33.3 mg/L of various antiscalants in batch (glass reactor) experiments.

Time (min)	Turbidity (NTU)								
	No AS	AS-A	AS-B	AS-C	AS-D	AS-E	AS-F	AS-G	AS-H
0	0.08	<u>0.08</u>	<u>0.08</u>	<u>0.08</u>	<u>0.08</u>	<u>0.08</u>	<u>0.08</u>	<u>0.08</u>	<u>0.08</u> ^a
1	2.29	<u>1.13</u>	<u>1.53</u>	<u>0.33</u>	<u>0.25</u>	<u>0.34</u>	<u>0.27</u>	<u>0.57</u>	0.12
15	2.94	<u>1.56</u>	<u>1.01</u>	<u>0.69</u>	<u>0.08</u>	<u>0.08</u>	<u>0.09</u>	<u>0.08</u>	0.08
30	3.16	<u>1.97</u>	<u>3.01</u>	<u>2.02</u>	<u>0.79</u>	<u>0.39</u>	<u>0.46</u>	<u>0.66</u>	0.12
45	3.3	<u>4.61</u>	<u>2.57</u>	<u>1.62</u>	<u>0.08</u>	<u>0.08</u>	<u>0.12</u>	<u>0.08</u>	0.08
60	3.38	<u>2.36</u>	<u>3.25</u>	<u>3.13</u>	<u>0.98</u>	<u>0.45</u>	<u>0.53</u>	<u>0.70</u>	0.12
		<u>5.85</u>	<u>3.23</u>	<u>2.26</u>	<u>0.08</u>	<u>0.08</u>	<u>0.18</u>	<u>0.08</u>	0.08
		<u>2.83</u>	<u>3.65</u>	<u>3.66</u>	<u>1.24</u>	<u>0.51</u>	<u>0.61</u>	<u>0.73</u>	0.12
		<u>7.01</u>	<u>3.82</u>	<u>2.91</u>	<u>0.08</u>	<u>0.08</u>	<u>0.26</u>	<u>0.08</u>	0.08
		<u>3.25</u>	<u>4.06</u>	<u>4.23</u>	<u>1.43</u>	<u>0.55</u>	<u>0.66</u>	<u>0.75</u>	0.12
		<u>7.60</u>	<u>4.19</u>	<u>3.60</u>	<u>0.08</u>	<u>0.08</u>	<u>0.39</u>	<u>0.08</u>	0.08

^a A “dashed” underline represents the turbidity value for an antiscalant dose of 13.3 mg/L, while a “solid” underline denotes the turbidity value for an antiscalant dose of 33.3 mg/L.

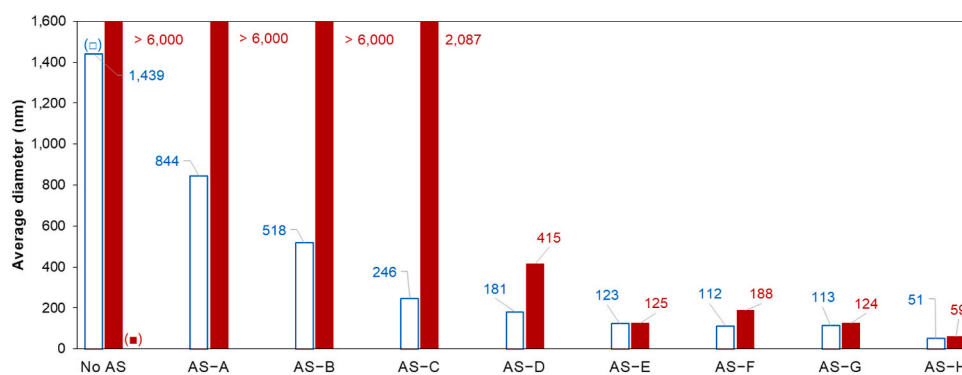

Fig. 6. Size measurement of the ACP particles in the synthetic concentrate of 85% recovery without antiscalant addition and with 13.3 mg/L of various antiscalants at (□) Time < 5 min and (■) Time ≈ 60 min.

3.4. Effectiveness of antiscalants in hindering the formation of ACP particles

In this section, the question “Can antiscalants inhibit the formation of ACP particles in RO applications?” is addressed using the synthetic concentrate of 85% recovery in batch experiments.

In Table 3, turbidity values of the synthetic concentrate of 85% recovery without antiscalant addition and with 13.3 and 33.3 mg/L of various antiscalants are shown. As can be seen, with 13.3 mg/L of each antiscalant, the turbidity values of the synthetic concentrate increased which indicated that the tested antiscalants at the aforementioned concentration were not effective in preventing the formation of ACP. However, the tested antiscalants had an influence on the formation of ACP. For instance, when antiscalant was not present, turbidity of the synthetic concentrate increased from 0.08 NTU to more than 3 NTU in 60 min, while with AS-H, the turbidity of the synthetic concentrate increased slightly and then remained constant. Actually, the AS-H was not able to inhibit the formation of the ACP particles, but was able to prevent their agglomeration which can be clearly seen from Fig. 6. As shown, the average particle size of ACP particles, in the presence of 13.3 mg/L of AS-H, remained approximately 50 nm during the 1-h experimental period. On the other hand, when antiscalant was not added, the average particle size of ACP reached to approximately 1.4 μm in 5 min which further increased to more than 6 μm (exceeding the range of the Zetasizer) in 60 min. This showed that ACP particles agglomerate rapidly over time.

Furthermore, the turbidity values of the synthetic concentrate with 13.3 mg/L of AS-A, AS-D, AS-E, AS-F, AS-G were also lower than those when antiscalant was not used which can be attributed to the fact that

antiscalants suppressed the agglomeration of ACP particles as can be seen from the average particle size measurements presented in Fig. 6. It is also likely that lower turbidity values in the presence of antiscalants might be due to the formation of fewer ACP particles. Surprisingly, with AS-B and AS-C, the turbidity values of the synthetic concentrate were higher than those without antiscalant. One may suggest that the mentioned two antiscalants might have favoured the agglomeration of ACP particles which, however, was not the case as shown in particle size measurements (Fig. 6). It could be that the number of ACP particles formed with AS-B and AS-C were higher than the number formed without antiscalant. Yet, the actual reason for the high turbidity values with the mentioned antiscalants is not known and requires further investigation. This issue was not investigated further in this paper as the objective here was to investigate if (commercially) available antiscalants for calcium phosphate can inhibit the formation of ACP particles. Based on the turbidity and particle size results, it can be concluded that none of the tested antiscalants at a concentration of 13.3 mg/L could inhibit the formation of ACP.

From Fig. 6, it can be observed that some antiscalants had better dispersion capabilities than others. For example, AS-H (a modified polycarboxylate) had the best dispersion capability among all other antiscalants, as the average size of the ACP particles with this antiscalant remained below 0.06 μm throughout the entire experimental period. On the other hand, AS-A (blend of phosphonates and carboxylic acids) and AS-B (proprietary acrylic polymer with chelate agent) exhibited the poorest dispersion capability, as the average particle size of ACP with both antiscalants exceeded 6 μm in 1-h period.

In Table 3, the turbidity values of the synthetic concentrate of 85% recovery in the presence of 33.3 mg/L of various antiscalants are also

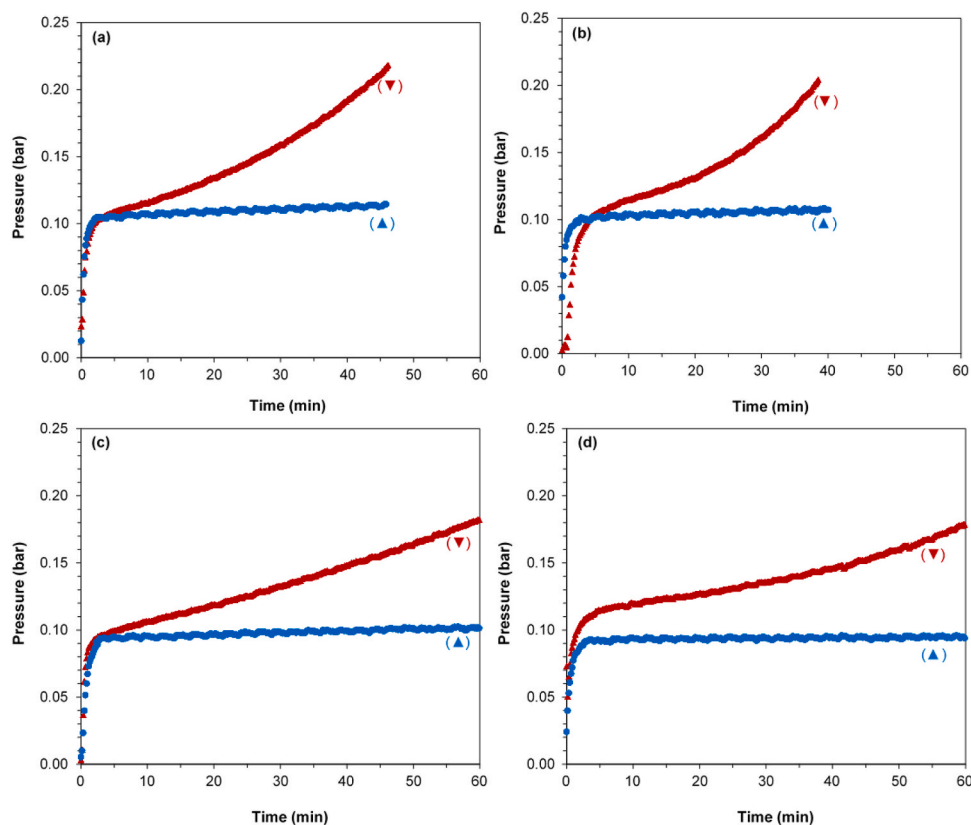

Fig. 7. Filtration at constant flux of $100 \text{ L/m}^2/\text{h}$ through 100 kDa filter of the (\blacktriangledown) synthetic concentrate of 85% recovery (with phosphate) in the presence of 33.3 mg/L of a) AS-D, b) AS-E, c) AS-G, and d) AS-H, and (\blacktriangle) synthetic concentrate of 85% (without phosphate) in the presence of 33.3 mg/L of a) AS-D, b) AS-E, c) AS-G, and d) AS-H.

presented. One can see that the formation of ACP particles was not inhibited even when a higher concentration (than 13.3 mg/L) of each AS-A, AS-B, AS-C and AS-F was used, since turbidity increased with each of the mentioned antiscalants. Interestingly, no increase in turbidity was observed in 1-h period when 33.3 mg/L of each AS-D, AS-E, AS-G and AS-H was added. At first, this result suggested that the formation of ACP particles was inhibited in the presence of 33.3 mg/L of mentioned antiscalants. However, turbidity readings alone were not considered conclusive at this point. It was hypothesized that perhaps the formation of ACP particles occurred in the solution, but their agglomeration was inhibited in the presence of the aforementioned antiscalants and therefore the size of the ACP particles was too small to be detected by turbidity measurements. To verify this, synthetic concentrate solutions, in the presence of antiscalants with no increase in turbidity (Table 3), were initially analysed with the Zetasizer to detect the presence of particles and to determine their size in case they were formed. But, it turned out that the Zetasizer could not provide reliable and conclusive information about the particle size (results not presented), since the measurements didn't meet the quality criteria of the instrument which could be due to the (i) presence of particles with sizes smaller than the detection limit of the Zetasizer ($<0.3 \text{ nm}$), (ii) presence of very few particles in the solution, or (iii) absence of particles in the solution.

In parallel with the size measurements, the synthetic concentrate solutions with no increase in turbidity were filtered immediately, after the first turbidity measurement, through 100 kDa filters at a constant flux of $100 \text{ L/m}^2/\text{h}$ and the increase in pressure to maintain the constant filtration flux was recorded to detect the presence of particles. One can argue that an increase in pressure may not be necessarily attributed to the presence of ACP particles, since the increase in pressure might be caused due to particles which may possibly form from a reaction of

calcium with antiscalant. For this reason, synthetic solutions (without phosphate but with the same concentrations of calcium, bicarbonate and antiscalant that were present in the synthetic concentrate of 85% recovery with no increase in turbidity) were also filtered through 100 kDa filters at a constant flux of $100 \text{ L/m}^2/\text{h}$.

As illustrated in Fig. 7a-d, an increase in pressure was observed when the synthetic concentrate solutions of 85% recovery in the presence of 33.3 mg/L of each AS-D, AS-E, AS-G and AS-H were filtered at constant flux. On the other hand, pressure did not increase when the synthetic solutions (without phosphate) in the presence of each AS-D, AS-E, AS-G and AS-H were filtered at constant flux. This indicated that there was no formation of particles due to calcium-antiscalant reaction and the observed increase in pressure (Fig. 7a-d) was due to ACP particles. Therefore, the mentioned antiscalants with a 33.3 mg/L concentration were unable to inhibit the formation of ACP particles in 1-h period.

Fig. 8 shows the SEM images of the 100 kDa filters from the filtration experiment of Fig. 7. As can be seen, the filter surface was covered with ACP particles when the synthetic concentrate solutions of 85% recovery in the presence of each AS-D, AS-E, AS-G and AS-H were filtered (Fig. 8a-d), while no particles were observed on the filter surface when the synthetic solutions (without phosphate) with each of the mentioned antiscalants were filtered (Fig. 8d-h). This revealed that the formation of ACP particles in the synthetic concentrate of 85% recovery was not inhibited with 33.3 mg/L of AS-D, AS-E, AS-G and AS-H even when no increase in turbidity was observed. The reason for not observing an increase in the turbidity of the synthetic concentrate of 85% recovery could be due to the formation of fewer ACP particles with very small size by the aforementioned antiscalants.

In brief, none of the tested antiscalants could inhibit the formation of ACP particles. But it may not necessarily mean that the formed ACP

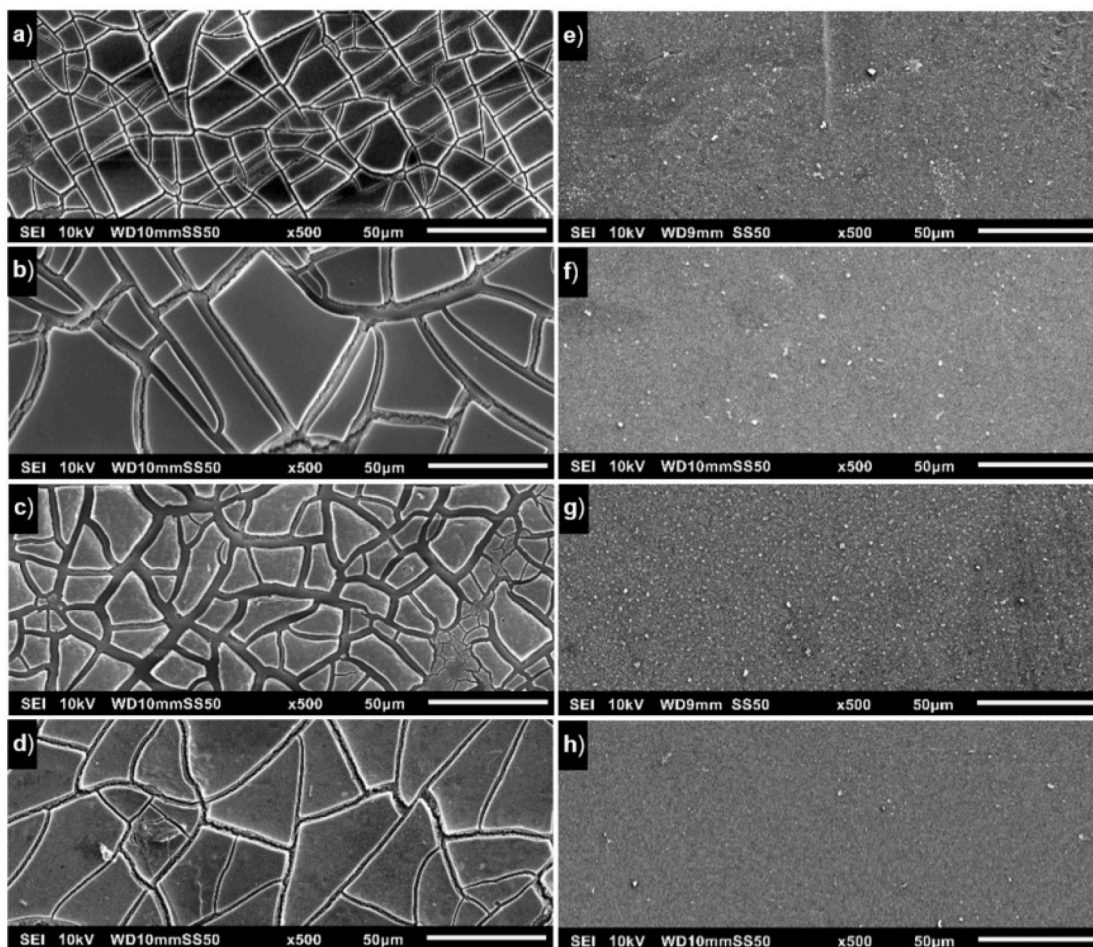

Fig. 8. SEM images (500× magnification) of the 100 kDa filter after filtering the synthetic concentrate of 85% recovery (with phosphate) in the presence of 33 mg/L of a) AS-D, b) AS-E, c) AS-G, and d) AS-H, and filtering the synthetic concentrate of 85% (without phosphate) in the presence of 33 mg/L of e) AS-D, f) AS-E, g) AS-G, and h) AS-H.

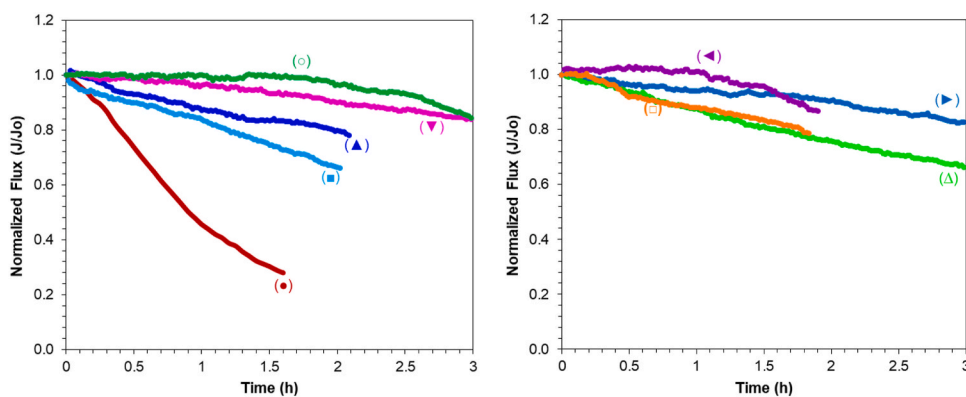

Fig. 9. Normalized flux of the small RO element when fed with the synthetic concentrate of 85% recovery (●) without antiscalant addition, and with 33.3 mg/L of (■) AS-A, (▲) AS-B, (▼) AS-D, (○) AS-E, (□) AS-F, (Δ) AS-C, (►) AS-G, and (◄) AS-H.

particles in the presence of antiscalants would deposit on the membrane surface in RO systems where the filtration mode is not dead-end but cross-flow. It could be that the adsorbed antiscalants (dispersants) on the formed ACP particles may diminish their tendency to deposit on the membrane surface in a cross-flow operation.

3.5. Effectiveness of antiscalants in preventing the deposition of ACP particles in RO applications

In this section the question “Can antiscalants inhibit the deposition of ACP particles on the membrane surface in RO systems?” is addressed using the synthetic concentrate of 85% recovery with the use of the lab-scale RO unit.

In Fig. 9, the normalized flux of the RO element when fed with

Table 4

Initial flux of the small RO element when fed with the synthetic concentrate of 85% recovery without and with the addition of 33.3 mg/L of various antiscalants.

	No AS	AS-A	AS-B	AS-C	AS-D	AS-E	AS-F	AS-G	AS-H
Initial Flux (L/m²/h)	13.9	14.4	14.2	14.4	14.0	14.7	13.7	14.6	13.8

synthetic concentrate of 85% recovery without antiscalant addition and with 33.3 mg/L of various antiscalants is shown. The initial flux for each experiment is presented in Table 4.

As can be seen from Fig. 9, none of the antiscalants could completely prevent the deposition of ACP particles on the membrane surface since the permeate flux decreased in the presence of each antiscalant. However, it is evident that the rate of flux-decline decreased in the presence of antiscalants. Additionally, one can see that some antiscalants had better performance than others in slowing down the flux decline. For instance, the permeate flux decreased by 25% with AS-A, approximately 17% with each AS-B, AS-C and AS-F and about 7% with each AS-D, AS-G and AS-H in 1.5 h, while no decrease was observed with AS-E in the same duration. However, after 3 h of operation, the permeate flux with AS-E decreased by approximately 15%. The possible reasons for some antiscalants performing better than others might be due to (i) the formation of fewer particles (which needed longer time to foul the membrane) in the presence of such antiscalants, and/or (ii) less deposition of the formed particles due to the reduction in the deposition propensity of the particles by the antiscalants.

As with AS-E the normalized flux remained constant in the first 1.5 h of the operation, the antiscalant was tested again in a different once-through lab-scale RO setup (Fig. S1) where the small RO element (TW30-1812-50) was replaced with SEPA CF cell (Sterlitech Corporation, USA) which is recognized by researchers to have similar hydrodynamics to the real RO membranes. In the SEPA CF cell, a membrane sheet of a brackish water RO membrane from Hydranautics (ESPA2-LD-4040) was used. The membrane was fed with the synthetic concentrate of 85% recovery with 33.3 mg/L of AS-E. In this test, the initial recovery and flux were approximately 0.6% and 14.5 L/m²/h, respectively. The cross flow velocity was approximately 0.12 m/s. The result of the test is shown in Fig. S2. As can be seen, the normalized flux of the ESPA2-LD-4040 membrane decreased by approximately 15% in almost 6 h period. This result also showed that AS-E was not effective in preventing the deposition of calcium phosphate particles on the membrane surface.

In brief, the tested antiscalants were not effective in preventing the flux decline caused due to the formation and deposition of ACP particles in RO systems. These results suggest that the formation/deposition of ACP could be a major concern in the application of RO purification of secondary treated wastewater and RO treatment of groundwater at higher recoveries when the solubility of ACP is exceeded and possibly could be the main factor limiting the recovery of the RO. As antiscalants appeared to be ineffective, other measures (e.g., lowering the saturation level) could be implemented to prevent calcium phosphate scaling in RO systems.

4. Conclusions

In this study, the performance of eight antiscalants, without acid addition, in preventing calcium phosphate scaling in RO applications was investigated. The major findings of this study can be summarized as follows:

- The determination of the scaling tendency of calcium phosphate with the use of projection programs was contradictory, since at the same conditions (e.g., temperature, pH, concentrations of calcium and phosphate, etc.), some programs predict high potential of calcium phosphate scaling, while some other predict no scaling tendency at all.
- The amorphous phase and not the crystalline phases of calcium phosphate was responsible for the sharp flux-decline when the RO

element was fed with the synthetic concentrate of 85% recovery ($\text{Ca}^{2+} = 767 \text{ mg/L}$, $\text{PO}_4^{3-} = 13\text{--}15 \text{ mg/L}$ and $\text{pH} = 7.6$).

- A concentration of 13.3 mg/L and 33.3 mg/L of 8 different antiscalants, which is equivalent to the recommended dosing rates of the antiscalant suppliers, was unable to inhibit the formation of amorphous calcium phosphate particles in synthetic RO concentrate, but some antiscalants hindered the agglomeration of the formed particles.
- None of the tested antiscalants (with a 33.3 mg/L concentration) could prevent the deposition of the amorphous calcium phosphate particles on the membrane surface of a TW30-1812-50 RO element in once-through lab-scale RO tests when the RO element (fed with the synthetic concentrate of 85% recovery) was operated at 5–6% recoveries and fluxes in the range of 13–15 L/m²/h. The normalized flux of the RO element with each antiscalant decreased by more than 15% in a 3-h period.

In brief, the (commercially) available antiscalants for calcium phosphate (tested in this study) may not provide acceptable inhibition of calcium phosphate scaling in RO systems.

Author statement

M. Nasir Mangal: Conceptualization, Methodology, Investigation, Visualization, Writing - original draft, Writing - review & editing.

Sergio G. Salinas-Rodriguez: Conceptualization, Resources, Writing - review & editing, Supervision.

Jos Dusseldorp: Conceptualization, Resources, Writing - review & editing, Supervision.

Antoine J.B. Kemperman: Conceptualization, Writing - review & editing, Supervision.

Jan C. Schippers: Conceptualization, Writing - review & editing, Supervision.

Maria D. Kennedy: Conceptualization, review & editing, Writing - review & editing, Funding acquisition, Supervision.

Walter G.J. van der Meer: Conceptualization, Writing - review & editing, Funding acquisition, Supervision.

Declaration of competing interest

The authors declare that they have no known competing financial interests or personal relationships that could have appeared to influence the work reported in this paper.

Acknowledgments

This study was funded by Oasen drinking water company in the Netherlands. We would like to thank the technical expertise of Mr. Ruud Hendriks of the X-Ray facilities of the Department of Materials Science and Engineering of the TU Delft, the Netherlands for his help with the XRD analysis of our samples.

Appendix A. Supplementary data

Supplementary data to this article can be found online at <https://doi.org/10.1016/j.memsci.2021.119090>.

References

- [1] DesalData, Worldwide desalination inventory (MS Excel format), Available from, www.DesalData.com, February 2020.
- [2] S.V. Dorozhkin, Calcium orthophosphates (CaPO₄): occurrence and properties, *Progress in Biomaterials* 5 (2016) 9–70.
- [3] M. Bohner, J. Lemaitre, T.A. Ring, Kinetics of dissolution of β -tricalcium phosphate, *J. Colloid Interface Sci.* 190 (1997) 37–48.
- [4] E.D. Eanes, Amorphous calcium phosphate: thermodynamic and kinetic considerations, in: Z. Amjad (Ed.), *Calcium Phosphates in Biological and Industrial Systems*, Springer US, Boston, MA, 1998, pp. 21–39.
- [5] J.L. Meyer, C.C. Weatherall, Amorphous to crystalline calcium phosphate phase transformation at elevated pH, *J. Colloid Interface Sci.* 89 (1982) 257–267.
- [6] L.J. Brečević, H. Füredi-Milhofer, The transformation of amorphous calcium phosphate into crystalline hydroxyapatite, in: J.W. Mullin (Ed.), *Industrial Crystallization*, Springer US, Boston, MA, 1976, pp. 277–283.
- [7] E.D. Eanes, A.S. Posner, Division of biophysics: kinetics and mechanism of conversion of noncrystalline calcium phosphate to crystalline hydroxyapatite, *Trans. N. Y. Acad. Sci.* 28 (1965) 233–241.
- [8] A.G. Walton, W.J. Bodin, H. Füredi, A. Schwartz, Nucleation of calcium phosphate from solution, *Can. J. Chem.* 45 (1967) 2695–2701.
- [9] J.D. Termine, Mineral chemistry and skeletal biology, *Clin. Orthop. Relat. Res.* 85 (1972) 207–241.
- [10] Z. Amjad, Inhibition of the amorphous calcium phosphate phase transformation reaction by polymeric and non-polymeric inhibitors, *Phosphorus Research Bulletin* 7 (1997) 45–54.
- [11] C. Combes, C. Rey, Amorphous calcium phosphates: synthesis, properties and uses in biomaterials, *Acta Biomater.* 6 (2010) 3362–3378.
- [12] R.Z. LeGeros, D.Q. Mijares, J. Park, X.F. Chang, I. Khairoun, R. Kijowska, R. Dias, J.P. LeGeros, Amorphous calcium phosphates (ACP): formation and stability, *Key Eng. Mater.* 284–286 (2005) 7–10.
- [13] X. Ge, L. Wang, W. Zhang, C.V. Putnis, Molecular understanding of humic acid-limited phosphate precipitation and transformation, *Environ. Sci. Technol.* 54 (2020) 207–215, <https://doi.org/10.1021/acs.est.9b05145>.
- [14] R. Alvarez, L. Evans, P. Milham, M. Wilson, Effects of humic material on the precipitation of calcium phosphate, *Geoderma* 118 (2004) 245–260.
- [15] L.F. Greenlee, F. Testa, D.F. Lawler, B.D. Freeman, P. Moulin, The effect of antiscalant addition on calcium carbonate precipitation for a simplified synthetic brackish water reverse osmosis concentrate, *Water Res.* 44 (2010) 2957–2969.
- [16] F. Rahman, Calcium sulfate precipitation studies with scale inhibitors for reverse osmosis desalination, *Desalination* 319 (2013) 79–84.
- [17] M.A. Salman, G. Al-Nuwaibit, M. Safar, A. Al-Mesri, Performance of physical treatment method and different commercial antiscalants to control scaling deposition in desalination plant, *Desalination* 369 (2015) 18–25.
- [18] E. Darton, Membrane chemical research: centuries apart, *Desalination* 132 (2000) 121–131.
- [19] S.P. Chesters, Innovations in the inhibition and cleaning of reverse osmosis membrane scaling and fouling, *Desalination* 238 (2009) 22–29.
- [20] G. Greenberg, D. Hasson, R. Semiat, Limits of RO recovery imposed by calcium phosphate precipitation, *Desalination* 183 (2005) 273–288.
- [21] Hydranautics, Chemical Treatment for RO and NF, 2013. Technical application bulletin no. 111.
- [22] W.S. Dow, FILMTEC™ Reverse Osmosis Membranes - Technical Manual, Technical Manual, Form, 2010, pp. 1–180.
- [23] S. Kubo, T. Takahashi, H. Morinaga, H. Ueki, Inhibition of calcium phosphate scale on heat exchanger: the relation between laboratory test results and tests on heat transfer surfaces, *Corrosion* 79 (1979) 1979.
- [24] S. Dorozhkin, Amorphous calcium orthophosphates: nature, chemistry and biomedical applications, *Int. J. Mater. Chem.* 2 (2012) 19–46.
- [25] E.D. Eanes, I.H. Gillessen, A.S. Posner, Intermediate states in the precipitation of hydroxyapatite, *Nature* 208 (1965) 365–367.
- [26] T.P. Feenstra, P.L. De Bruyn, The ostwald rule of stages in precipitation from highly supersaturated solutions: a model and its application to the formation of the nonstoichiometric amorphous calcium phosphate precursor phase, *J. Colloid Interface Sci.* 84 (1981) 66–72.