



An integrated approach towards assessing the value of water: A case study on the Zambezi basin

A.Y. Hoekstra*, H.H.G. Savenije and A.K. Chapagain

IHE Delft, P.O. Box 3015, 2601 DA Delft, The Netherlands

Received 23 October 2000; revised 9 May 2001

The aim of this paper is to develop a methodology for assessing the value of water in the different stages in the water cycle. It is hypothesised that if a cubic metre of water provides some benefit in some spot at a certain moment, this cubic metre of water has a certain value not only at that point in space and time, but in its previous stages within the water cycle as well. This means that, while water particles flow from upstream to downstream, water values 'flow' in exactly the opposite direction. The value of water in a certain place is equal to its value *in situ* plus an accumulated value derived from downstream. This value-flow concept is elaborated for the Zambezi basin.

It is found that water produces the smallest direct economic benefits in the upper part of the Zambezi basin. However, water flows in this part of the basin – due to their upstream location – have the highest indirect values. Return flows from the water-using sectors are particularly valuable in the upstream sub-basins. The analysis shows that the value per unit of river water increases if we go from downstream to upstream. Another finding of the study is that percolation of rainwater is generally more valuable than surface runoff. Finally, a plan to export water from the river Zambezi to South Africa is evaluated in terms of its opportunity costs.

The results of this study show that the value-flow concept offers the possibility of accounting for the cyclic nature of water when estimating its value. It is stressed, however, that for the current study many crude assumptions had to be made, so that the exact numbers presented should be regarded with extreme caution. Further research is necessary to provide more precise and validated estimates.

Keywords: modelling, value of water, water policy, Zambezi basin

1. Introduction

Since the International Conference on Water and the Environment, held in Dublin in 1992, it has been generally agreed that water should be recognised as an economic good. The background to this notion is that in many parts of the world clean fresh water is increasingly becoming a scarce resource and it should therefore be valued as such. It is said that water should be allocated to where it produces the greatest benefits. Today, nine years after the Dublin Conference, many questions remain on how to put the idea of considering water as an economic good into practice. One of the bottlenecks in the valuation of water is its particular nature as a renewable resource. Allocation of some water for one particular purpose does not mean that this has now become its final destination. On the contrary, water withdrawn from the water cycle will always return to the water cycle, although it might return somewhere other than where it was withdrawn and although its quality might have changed. Actually, a drop of rain can generate multiple benefits before it is 'lost' to the atmosphere or the ocean. As a result, the value of one drop of water is closely linked to its movement through the water cycle. When moving through the water cycle, the value of a drop of water changes continually.

The aim of this paper is to develop a methodology for assessing the value of water in the different stages in the water cycle. For our case study we have chosen the Zambezi river basin. The underlying hypothesis of the study is that the value of a water particle in a certain place and at a certain point in time is equal to its value *in situ* plus its value in a later stage (downstream). It is presumed that any value of water can be 'transferred' back to where the water came from. In other words, if a cubic metre of water gives some kind of economic benefit or supports some kind of ecological value in some spot at a certain moment, this cubic metre of water has a certain value not only at that point in space and time, but in its previous stages within the water cycle as well. The reasoning is that if the water was not there upstream it would not be downstream either, and thus there would be no economic benefit or ecological value. As a metaphor, one can say that water particles flow from upstream to downstream and that water values flow in exactly the opposite direction.

This paper elaborates the idea of water values flowing from downstream to upstream in a case study concerning the Zambezi basin. It is explicitly not the purpose of this paper to produce precise and validated estimates of all the different values of water in this river basin. We look at the value of water for a limited number of economic sectors and for these sectors we will give very crude estimates only. Thus we consider the value of water in the rain-fed and irrigated agricultural sector and in the domestic, livestock, industrial

* Corresponding author: Tel.: +31 15 215 1828; Fax: +31 15 212 2921;
E-mail: arjen@ihe.nl.

and hydropower sectors, but we do not look at ecological values of water (e.g., the value of water for the functioning of wetlands), option values or existence values.

The paper is organised in the following way. In the next section we will introduce the methodology. First we explain the methodology used to make crude estimates of the values of water in the different parts of the water cycle for the sectors mentioned. We then describe the methodology of translating these values in the upstream direction. In the third section we describe the Zambezi basin and discuss the basic data used. In the fourth section we show some of the results of the water value analysis. In the final section we evaluate the value-flow concept.

2. Methodology

2.1. General

It is assumed that the total value of a water flow or body of water consists of two components: a direct and an indirect value. The direct value refers to the value of the water *in situ*. The indirect value refers to the value of the water in one of its next stages within the water cycle.

If a certain water flow or body has a direct value, the source of that water flow or body has an indirect value. As an example, crop production gives direct value to the water that plants take up from the soil and thus an indirect value to the infiltration water that replenishes the soil. If we continue to trace the origins of the water, we find that crop production also gives an indirect value to rainwater, because infiltration water originally is rainwater. In irrigated agriculture we can attribute an indirect value to the irrigation water as well. If the irrigation water was taken from a river, we can attribute some indirect value to this river too, etc. In the end, all the benefits and values provided by the water in a river basin add to the value of precipitation, the ultimate source of fresh water in any river basin.

2.2. Direct values of water

The general methodology to assess the direct economic value of water can be best explained with the help of the supply and demand curves for water shown in figure 1a. The marginal benefit of water generally decreases if the demanded quantity increases, because the willingness to pay for the first units of water is greater than the willingness to pay for the last units. The marginal cost of water supply as a rule grows with increasing supply, due to greater scarcity. However, the marginal cost will not continue to increase if the costs reach a level at which importing desalinated water becomes more attractive than the use of the last drop of local water.

The area below the demand curve represents the gross economic benefit of the water. The gross economic benefit continues to increase if the water supply grows, but the increase will become less and less the larger the supply (figure 1b). The area below the supply curve represents the total

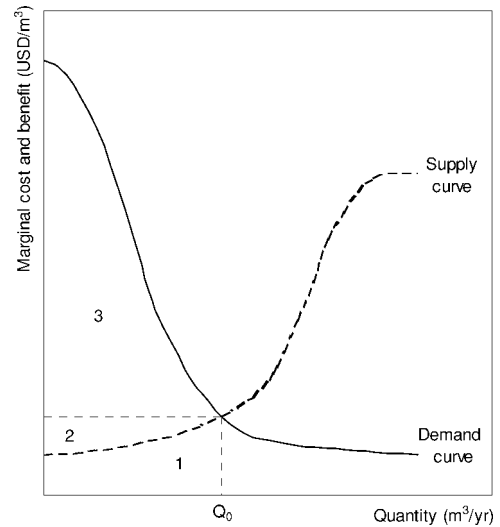

Figure 1a. Supply and demand curve for water.

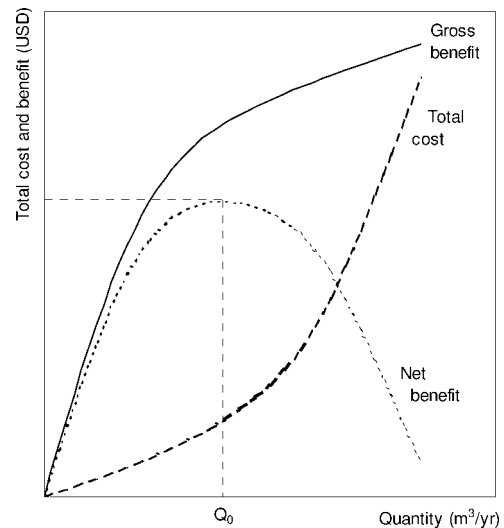

Figure 1b. Total cost and benefit of water.

cost of water supply. The area between the demand and the supply curves represents the total economic value of water. The total net benefit of water is shared between ‘producers’ (the suppliers of the water) and ‘consumers’ (the users of the water). The distribution of the total net benefit over producers and consumers is determined by the price of the water, the amount of money paid by consumers to producers per unit of water. The consumer surplus is the area below the demand curve minus the price of water times the quantity consumed. The producer surplus is equal to the price of water times the quantity produced minus the area below the supply curve.

The net benefit obtained is greatest if the marginal benefit equals the marginal cost. In this case the gross benefit is equal to the area 1 + 2 + 3 (figure 1a), the total cost is equal to area 1 and the net benefit is equal to area 2 + 3. If the price of water is at the so-called equilibrium point – the place where demand and supply curves cross – then area 2 represents the producer surplus and area 3 the consumer surplus.

In practice it often happens that the price of water is lower than the marginal costs, so that demand and supply are beyond the 'optimum'. In this case the consumer surplus is larger than in the optimum case, but the producer surplus is smaller. The net effect is negative (although there can be reasons to prefer this situation, for instance to provide poor people with subsidised water).

In this study we have schematised the supply curve with the following function:

$$MC = \min(a_s \times Q^{1/E_s}, C_{\max}) \quad (1)$$

in which MC represents the marginal cost of water (in USD/m³), Q the quantity of water supplied (in m³/yr), C_{\max} the maximum cost of water (in USD/m³), E_s the price elasticity of supply and a_s a calibration parameter. The maximum cost of water supply is taken as equal to the sum of the costs of desalination and the costs of transport to where the water is needed. For the price elasticity of supply we have assumed a value of 0.2. Parameter a_s has been calibrated for each sector separately, on the basis of 1990 figures for the marginal cost and the quantity supplied. For the demand curve we have assumed:

$$MB = \min(a_d \times Q^{1/E_d}, WTP_{\max}) \quad (2)$$

in which MB represents the marginal benefit of water (in USD/m³), Q the quantity demanded (in m³/yr), WTP_{\max} the maximum willingness to pay (in USD/m³), E_d the price elasticity of demand and a_d a calibration parameter. It should be emphasised that this schematisation of the demand curve is just a crude estimation. In a next phase of this study, the curve will be based on an analysis of the willingness of consumers to pay as a function of their budget. Provisionally we have taken a specific price elasticity per sector as discussed in [1] and a maximum willingness to pay equal to the maximum supply costs. As in the case of the supply curve, the parameter a_d has been calibrated for each sector separately, on the basis of 1990 figures for prices and quantities demanded.

The gross benefit GB of water supply at a certain quantity Q_i can be found through integration of the demand curve. The total cost TC of water supply can be obtained through integration of the marginal cost curve. The consumer surplus CS and the producer surplus PS are then calculated as follows:

$$CS(Q_i) = GB(Q_i) - P \times Q_i, \quad (3)$$

$$PS(Q_i) = P \times Q_i - TC(Q_i), \quad (4)$$

where P stands for the water price charged to the consumer. Finally, the total economic value (or net benefit) of water is calculated as the sum of consumer and producer surplus.

For the assessment of the value of water supply in the domestic, irrigation, livestock and industrial sectors we were able to follow the system described above. For the assessment of the value of rainwater in both rain-fed and irrigated

agriculture and for the assessment of the value of river runoff for hydropower we had to use a more indirect method.

Rainwater does not have a price, nor do farmers incur costs in order to make the rain available, so that it is difficult to obtain demand and supply curves for rainwater. Nevertheless, water is an important input factor in the crop production process and should therefore be valued. The demand for rain can be seen as a 'derived' demand, which means that it depends on the demand for crops. The value of rainwater is in fact a derivative of the value of the crops produced.

We have estimated the value of rainwater in rain-fed agriculture as follows. We started by drawing a *crop* demand curve. This demand curve was then used to assess the gross benefit of crop production. The total costs of crop production were estimated by assuming them to be a fixed percentage (85%) of the gross product of rain-fed agriculture. This gross product – which can be understood as the gross income of farmers – was calculated using the SGVP-method as described in [2]. The standardised gross value of production (SGVP) is defined as:

$$SGVP = \sum_{\text{crop}=1}^{\text{crop}=i} \left(A_i \times Y_i \times \frac{P_i}{P_b} \right) \times P_{\text{world}}, \quad (5)$$

where A_i represents the area planted with crop i (in ha), Y_i the yield of crop i (in kg/ha), P_i the local price of crop i (in local currency/kg), P_b the local price of a reference crop (in local currency/kg) and P_{world} the world market price of the reference crop (in USD/kg). As a reference crop we have chosen maize. The demand for 'maize equivalents' (in kg/yr) is calculated as the SGVP (in USD/yr) divided by the world market price for maize (in USD/kg). This demand for 'maize equivalents' together with the price of maize gives one point of the crop demand curve. The curve is further defined by assuming a certain price elasticity of crop demand and a certain maximum willingness to pay [1]. The net benefit in rain-fed agriculture is equal to the area below the crop demand curve (the gross benefit) minus the total costs of crop production (assumed to be 85% of the SGVP). This net benefit is a measure of the value of the resources used in the production process. Water is one of these resources (input factors), as are – for instance – land, fertiliser, capital and labour. If we suppose that water is the limiting factor, a reduction in water will result in reduced crop production and thus a reduced benefit. In the most extreme case, if there was no rainwater at all, crop production would be zero. For this reason, we have assumed that the total value of rainwater falling on rain-fed croplands is equal to the net benefit in the rain-fed agriculture sector. For the sake of simplicity we have presumed that the total production of crops responds linearly to the amount of possible water uptake by plants.

To estimate the value of rainwater in *irrigated* agriculture we simply assume that the rainwater uptake by plants in the irrigation sector has the same value per unit of water as in the case of rain-fed agriculture.

The assessment of the value of river runoff in the hydropower sector has been approached in the same way as

rain-fed agriculture. We have used a demand curve for energy to estimate the gross benefit from hydroelectric power. The gross product in the hydropower sector is calculated as the total energy production (in GJ/yr) times the energy price (in USD/GJ). It has been assumed that the costs of hydropower production amount to 80% of the gross product.

2.3. The flow of water values from downstream to upstream

To estimate how a direct value of water at some point in the water cycle gives indirect values to the water upstream of this point, we can simply follow the water back along its flow lines. Let us, for instance, consider an irrigation area drawing on ground water. Suppose that the withdrawal is $10 \times 10^6 \text{ m}^3/\text{yr}$, equal to 10% of the natural groundwater recharge. The total direct value of the irrigation water has been estimated at $8 \times 10^6 \text{ USD/yr}$, which means an average value of 0.8 USD/m^3 . Supposing that the groundwater reservoir is only replenished through natural recharge, we can say that this recharge represents an indirect value of at least $8 \times 10^6 \text{ USD/yr}$, which is – given a total recharge of $100 \times 10^6 \text{ m}^3/\text{yr}$ – equal to 0.08 USD/m^3 . We say ‘at least’, because other activities in the basin can add to the value of groundwater recharge as well. Suppose for instance that 90% of the groundwater recharge ultimately reaches the surface and thus contributes to the river flow towards the sea. In the river is a hydropower plant, giving a direct value to the river runoff of $10 \times 10^6 \text{ USD/yr}$. With a river runoff of $450 \times 10^6 \text{ m}^3/\text{yr}$ this means an average river water value of 0.022 USD/m^3 . Ground water contributes 20% to the river runoff, which means that the groundwater outflow has an indirect value of $2 \times 10^6 \text{ USD/yr}$. As groundwater outflow is due to groundwater recharge, we can add the amount of $2 \times 10^6 \text{ USD/yr}$ to the total value of groundwater recharge. Together with the value of $8 \times 10^6 \text{ USD/yr}$ due to irrigation, we now arrive at a new estimate of the value of groundwater recharge: $10 \times 10^6 \text{ USD/yr}$ in total, or 0.1 USD/m^3 on average.

If we follow water back along its flow lines, we will see that all water originates in precipitation. Accordingly, if we systematically transfer values of water in the upstream direction, we will find that the total value of precipitation in a river basin is equal to the sum of all *in situ* values of water in the basin. This makes sense: the total value of precipitation exactly equals the benefits it will generate on its way to the ocean or back into the atmosphere. (However, if part of the precipitation in a river basin is the result of evaporation from the same basin, we can actually attribute part of the value of precipitation to this evaporation. The value of evaporation in turn puts a value on precipitation, thus creating a loop. This will cause a multiplier effect, which we did not take into account in the current study.)

When a set of water flows leaving a water store produces a certain value, this value must be attributed to the inflows into the water store in proportion to their volume (figure 2).

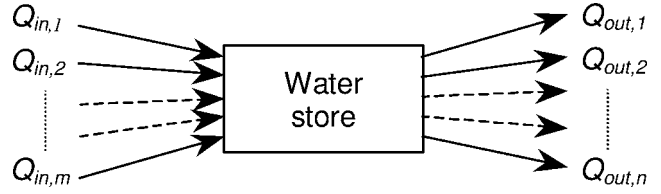

Figure 2. The water balance of a water store.

Applying this general rule, we can calculate the total economic value of a specific water inflow as follows:

$$TV_{in,i} = DV_{in,i} + \frac{Q_{in,i}}{\sum_{j=1}^n Q_{out,j}} \times \sum_{j=1}^n TV_{out,j}. \quad (6)$$

The first component ($DV_{in,i}$) is the direct value of inflow i and the second component refers to the indirect value of this flow. $TV_{out,j}$ refers to the total value of outflow j , $Q_{out,j}$ to the volume of outflow j and $Q_{in,i}$ to the volume of inflow i .

2.4. From the total value to the marginal value of a water flow

The total value of a water flow can be useful information, but people are often more interested in the *marginal* value of water, i.e., the value of the last unit of water. The *average* value per unit of water can easily be calculated by dividing the total value of a water flow (in USD/yr) by its volume (in m^3/yr). However, not all water particles constituting a water flow have the same value, and the marginal value is generally not the same as the average value per unit. The marginal value of a water flow can be estimated by taking out one unit of water from the flow. This can have effects throughout the river basin. As a result, not only the direct benefits of the water flow under consideration might be reduced, but downstream benefits as well. The original total value of the flow TV (including both direct and indirect values) will now be reduced to a smaller value TV^* . The difference between TV and TV^* is the marginal value of the water flow.

Using this method one can, for instance, estimate the marginal value of rainwater, by looking at how the total value of precipitation decreases if the precipitation is slightly reduced. In this way it is possible to estimate how a period of drought lessens the net benefits water will provide. Similarly, one can look at a possible growth in net benefits if precipitation increases.

This method of estimating the marginal value of water can also be useful if one wants to consider the possibility of withdrawing water from a river for export to another basin. The marginal value of the river water is a measure for the opportunity costs of water export, i.e., the benefit foregone in the basin from which the water is exported.

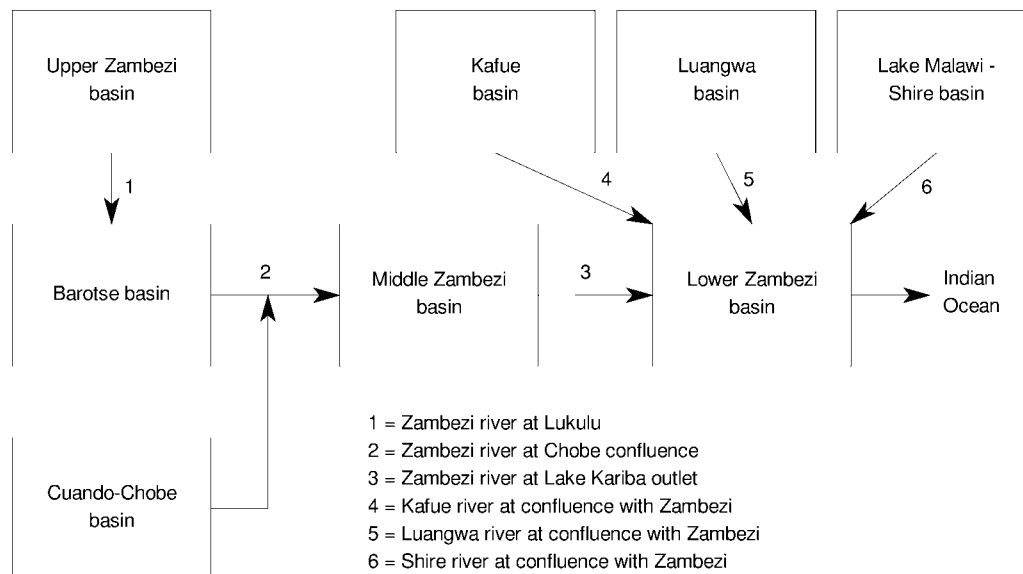

Figure 3. Schematisation of the Zambezi basin into eight sub-basins.

3. The Zambezi basin

3.1. Schematisation

The Zambezi basin in Southern Africa is one of the large international river basins in the world, with an estimated area of about 136×10^6 ha. It contains part of the territory of eight nations: Zambia, Angola, Zimbabwe, Mozambique, Malawi, Tanzania, Namibia and Botswana. In 1994 the total population in the basin was about 25.5 million. The basin has been schematised into eight sub-basins (figure 3). The Zambezi rises in the Upper Zambezi basin and flows via the Barotse, Middle Zambezi and Lower Zambezi basins towards the Indian Ocean. The Cuando-Chobe basin connects to the Middle Zambezi basin at the Chobe confluence, just upstream of the Victoria Falls. The Kafue, Luangwa and Lake Malawi-Shire basins drain into the Lower Zambezi basin. The water cycle has been schematised for each sub-basin as shown in figure 4.

3.2. Data

With respect to economic activities in the Zambezi basin we have chosen to consider the year 1990. We have put these data against the background of an 'average hydrological year'. To obtain quantitative estimates of all separate water flows distinguished (see figures 3 and 4) we have used the output of the AQUA Zambezi Model, a simulation model calibrated on the basis of observed monthly river discharge per sub-basin [3].

The estimated withdrawals from surface and ground water in the Zambezi basin in 1990 are presented in table 1. The return flows to surface water are assumed to be a fixed percentage of the withdrawal: 85% for domestic water supply, 90% for industrial water supply and 30% for livestock water supply. The remaining parts evaporate. The water uptake by plants in agriculture is estimated as shown in table 2. The

irrigation efficiency – defined as the fraction of the withdrawal which actually benefits the crop – was assumed at 35%. This fraction is lost to the atmosphere through transpiration of the plants. It was further assumed that two thirds of the remaining water is lost to the atmosphere due to evaporation during transport. The other one third recharges the ground water.

The 1990 values of crop and livestock production in the Zambezi basin have been based on [4] and are shown in table 3. Basic data on hydropower in the basin have been taken from [5]. Estimates for marginal costs and average prices of water were taken from [3] and are presented in table 4.

4. Results

4.1. Introduction

Based on the data presented in the previous section and the calculation methods described earlier, we have formulated a 'water-value model' for the Zambezi basin. This model calculates, for a chosen year, the direct values of water per sector and sub-basin and describes how these *in situ* values add value to the water flows upstream of where the *in situ* values are generated.

The quantitative estimates that will be given in this section should be regarded with extreme caution, because of the many limitations of the analysis and the assumptions made. The numbers should rather be seen as the outcome of a first crude analysis. As said in the introduction, this paper is primarily meant to explore a new methodology, to look what kind of results can be obtained and to identify the weak points which need to be improved in a next phase. In section 5 we will start the discussion on how to improve the assessment methodology in order to arrive at more precise estimates.

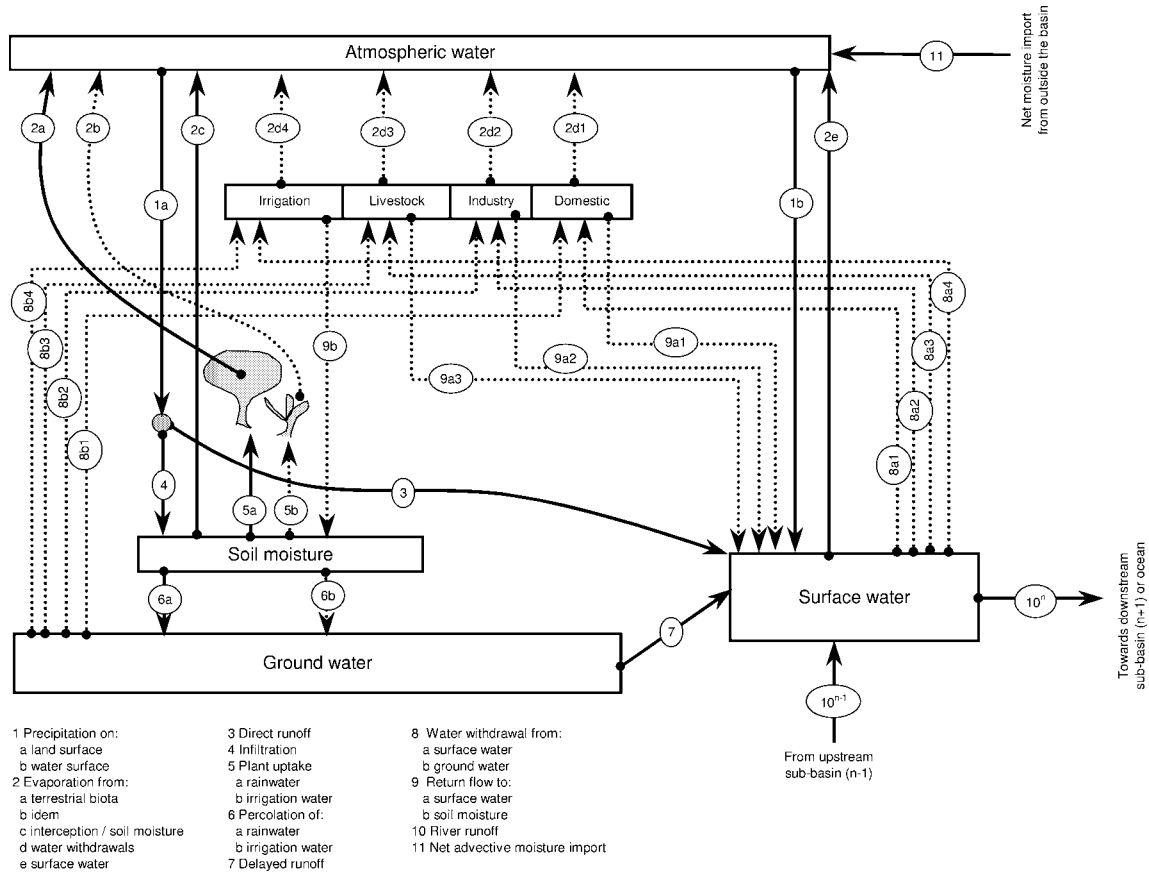

Figure 4. Water flow schematisation within a sub-basin.

Table 1
Water withdrawals (in 10⁶ m³/yr) per sector in the Zambezi basin in 1990.

	Ang.	Nam.	Bots.	Zamb.	Zimb.	Tanz.	Mal.	Moz.	Total
Withdrawal for the domestic sector									
from surface water	5.5	1.8	0.1	147	110	6.4	120	28	420
from ground water	1.5	0	0.1	16	34	3.6	7.1	3.6	66
total	7.1	1.8	0.2	164	144	10	127	32	486
Withdrawal for the irrigation sector									
from surface water	60	0.6	0.4	233	251	0	200	233	978
from ground water	0	1.0	0.3	15	0	0	0.1	0	16
total	60	1.6	0.7	248	251	0	200	233	994
Withdrawal for the livestock sector									
from surface water	1.4	1.7	0	31	53	3.9	11	2.4	106
from ground water	0	0	0.3	0	0	0	0	0	0
total	1.4	1.7	0.3	31	53	3.9	11	2.4	106
Withdrawal for the industrial sector									
from surface water	6.5	1.9	0.4	41	114	0.6	20	0	184
from ground water	0	0	0	61	0	0	0	1.7	63
total	6.5	1.9	0.4	102	114	0.6	20	1.7	247
Total withdrawal									
from surface water	74	6.1	0.8	452	528	11	351	264	1688
from ground water	1.5	1.0	0.7	93	34	3.6	7.2	5.4	146
total	75	7.0	1.5	545	562	14	359	269	1833

Source: [3].

4.2. The total economic value of water in the Zambezi basin

The total economic value of water in the Zambezi basin has been calculated at 2.3×10^9 USD in the year 1990. It was found that agriculture provides the largest contribution

to this total. Irrigated and rain-fed agriculture each contribute a little more than 30%. Domestic water use contributes about 22%, industrial water use 9%, livestock water use 4% and hydropower 3%. As shown in figure 5 the profits from the use of water are not equally divided among

Table 2
Water uptake by plants in rain-fed and irrigated croplands in the Zambezi basin in 1990.

	Unit	Ang.	Nam.	Bots.	Zamb.	Zimb.	Tanz.	Mal.	Moz.	Total
Area of cropland										
rain-fed cropland	10 ³ ha	268	7.4	13	4103	691	179	1957	663	7882
irrigated cropland	10 ³ ha	6.0	0.16	0.07	25	25	–	20	23	99
Uptake of water by plants										
rain-fed cropland	10 ⁶ m ³ /yr	1645	27	50	24920	3585	1154	12616	3896	47894
irrigated cropland	10 ⁶ m ³ /yr	58	1	0	240	220	–	204	222	946
Origin of the water in irrigated lands										
rainwater	%	64	52	52	64	60	–	66	63	63
irrigation water	%	36	48	48	36	40	–	34	37	37

Source: [3].

Table 3
Value of agricultural production in the Zambezi basin in 1990.

	Unit	Ang.	Nam.	Bots.	Zamb.	Zimb.	Tanz.	Mal.	Moz.	Total
Crop production										
Production value in country as a whole ^a	10 ⁶ USD/yr	320	37	13	320	1368	2169	593	529	5350
Fraction of cropland area in Zambezi basin ^b	%	9.5	1.1	3.2	79	26	5.9	100	24	28
Production value within Zambezi basin ^c	10 ⁶ USD/yr	30	0.42	0.42	252	360	128	593	125	1490
rain-fed agriculture ^d	10 ⁶ USD/yr	28	0.38	0.33	239	328	128	584	117	1425
irrigated agriculture ^d	10 ⁶ USD/yr	2.3	0.04	0.09	13	32	0.0	9.2	8.4	65
Livestock production										
Production value in country as a whole ^a	10 ⁶ USD/yr	768	200	249	288	639	1082	159	199	3585
Fraction of livestock in Zambezi basin ^b	%	3.5	5.1	0.8	87	67	2.2	96	14	26
Production value within Zambezi basin ^c	10 ⁶ USD/yr	27	10	1.9	251	428	24	153	28	922

^a Calculated on the basis of country data on production (in kg) and production values (in local currency). Source: [4]. The production values for the different types of crop or livestock have been added using the SGVP-method with maize as a reference in the case of crops and beef as reference in the case of livestock (see section 2.2).

^b Source: [3].

^c Calculated by multiplying the production value in a country as a whole by the fraction produced in the Zambezi basin.

^d Calculated on the basis of the ratio of rain-fed to irrigated area and the ratio of average yield in rain-fed to average yield in irrigated agriculture [3].

Table 4
Estimated marginal costs and prices of water (in USD/m³) in the Zambezi basin in 1990.

	Ang.	Nam.	Bots.	Zamb.	Zimb.	Tanz.	Mal.	Moz.
Marginal cost								
domestic	0.57	0.56	0.54	0.56	0.59	0.59	0.61	0.59
irrigation	0.13	0.13	0.11	0.13	0.15	0.15	0.16	0.15
livestock	0.57	0.56	0.54	0.56	0.59	0.59	0.61	0.59
industry	0.13	0.13	0.11	0.13	0.15	0.15	0.16	0.15
Price								
domestic	0.14	0.14	0.13	0.14	0.15	0.15	0.15	0.15
irrigation	0.03	0.03	0.03	0.03	0.04	0.04	0.04	0.04
livestock	0.14	0.14	0.13	0.14	0.15	0.15	0.15	0.15
industry	0.13	0.13	0.11	0.13	0.15	0.15	0.16	0.15

Source: [3].

producers and consumers. In all sectors, the consumer surplus is larger by far than the producer surplus. In the case of the irrigation sector the producer surplus is even estimated to be negative, as a result of under-pricing of the water. The farmers in this sector survive due to water subsidies from the government. In rain-fed agriculture the producer surplus is relatively large, which can be understood from the fact that rainwater is not paid for.

The total economic value of water in the Zambezi basin is not equally divided over the various sub-basins. About

30% of the total value is generated in the Lake Malawi-Shire basin, 26% in the Lower Zambezi basin, 17% in the Middle Zambezi basin, 10% in the Kafue basin and 7% in the Luangwa basin. The remaining 10% is generated in the three basins furthest upstream. The general picture which appears is that water in the Zambezi basin has the highest direct value in the downstream parts. In the Upper Zambezi, Barotse and Cuando-Chobe basins water provides relatively low direct economic benefits. However, because these basins are situated in the upstream part of the Zambezi basin, wa-

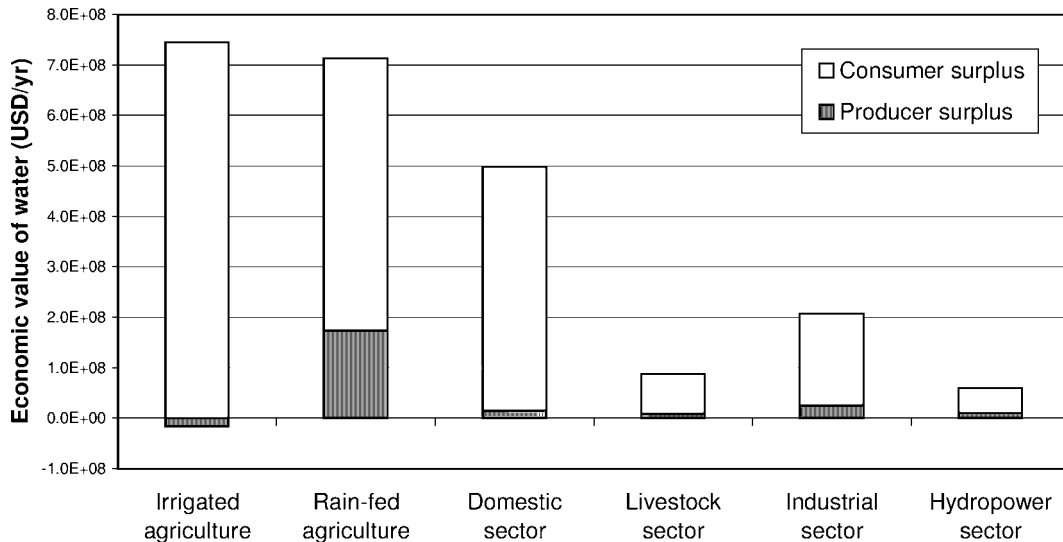

Figure 5. Total economic value of water in various sectors in the Zambezi basin in 1990.

ter here has the highest *indirect* value. In the Upper Zambezi basin, for instance, only one third of the total economic value of precipitation is due to the benefits of the water in the basin itself. The remaining two thirds of this total value derives from use of the water in downstream parts of the Zambezi basin.

4.3. The value of water flows in the Zambezi basin

The value of river runoff

Let us start with considering the economic value of the Zambezi water at its downstream end, where it flows into the Indian Ocean. In the current analysis we have assumed that there is no economic activity in the marine waters which will be affected significantly if the Zambezi outflow into the ocean becomes zero, so the value of the river runoff into the ocean is regarded as zero. If we follow the river in the upstream direction, however, the value of the river water will not remain zero.

River runoff from the Middle Zambezi basin, for instance, has an estimated total economic value of 150×10^6 USD/yr, due to the use of water in the Lower Zambezi basin (figure 6). The total values of river runoff from the Kafue, Luangwa and Lake Malawi-Shire basins are lower, because these basins make a smaller contribution to the total river inflow into the Lower Zambezi basin. However, the value per cubic metre of river runoff is the same for the Middle Zambezi, Kafue, Luangwa and Lake Malawi-Shire basins. This can be understood from the fact that the total value of the river inflows into the Lower Zambezi basin has been equally divided among the four upstream basins which contribute to this total river inflow. If we go further upstream we see that the value per cubic metre of river flow increases.

The *marginal* value (i.e., the value of the last unit) of water in a river is generally less than the *average* value per unit of water. As an illustration we have analysed the marginal value of the river runoff from the Barotse basin and considered the plan to export 3×10^9 m³/yr from the Zambezi

river at Katima Mulilo (Namibia) to South Africa [6,7]. This volume of export will reduce the mean annual river runoff from the Barotse basin by about 8%. Without export, the value of the river runoff from the Barotse basin is estimated at 340×10^6 USD/yr. Export reduces this value by about 5%. From these data one can calculate a marginal value of river runoff of 0.5 dollar cents per cubic metre, which can be regarded as the opportunity cost of exporting water to South Africa. It should be noted that this is a conservative estimate, because not all types of water value have been considered. Additionally, demands for water in the Zambezi basin are likely to increase in the future, so that water will become scarcer and thus more valuable. The analysis shows that the opportunity costs of water export from the basin become lower if one moves the location of withdrawal in a more downstream direction.

The value of rainwater

The total value of precipitation in the Zambezi basin is 2.3×10^9 USD/yr, which is equal to the total economic value of water in the different sectors. With an average rainfall of 875 mm/yr we can then calculate an average value of rainfall in the Zambezi basin of 0.2 dollar cents per cubic metre. This does not mean that the value of precipitation is the same throughout the basin. The average value of rainfall in the Lake Malawi-Shire basin for instance is 0.6 dollar cents per cubic metre. The average value of rainfall over rain-fed croplands in the Zambezi basin is calculated at 1.1 dollar cents per cubic metre. The latter value largely reflects the value of rainwater to rain-fed agriculture, but it also includes a small component referring to the use of the water in later stages of the water cycle.

Model experiments with more or less rainfall show that the *marginal* value of rainfall is much higher than the average value per unit. An increase in precipitation of 1%, for instance, gives an increase in the total economic value of 12%. A decrease in precipitation of 1% gives a decrease in

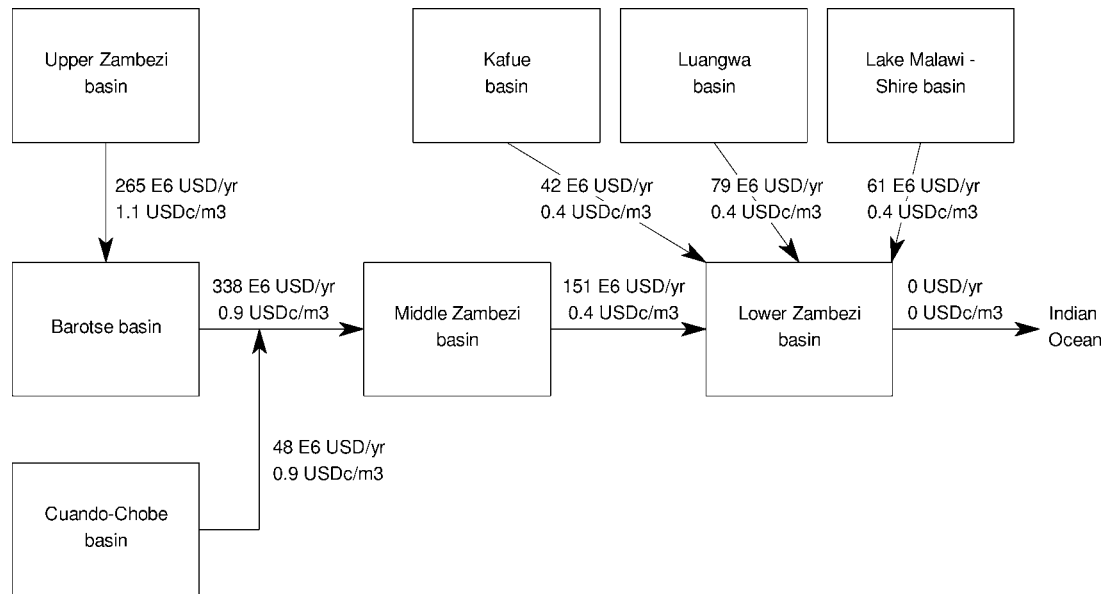

Figure 6. The total value and average value per unit of river runoff per sub-basin in 1990.

the total value of 7%. This means that the marginal value is about 1.8 dollar cents per cubic metre. This high value is due in particular to the high marginal value of precipitation in rain-fed agriculture. Reduced precipitation will directly result in reduced yields and this translates into reduced benefits for both consumers and producers. The second sector contributing to the high marginal value of precipitation is hydropower, which depends directly on the available river flows and thus indirectly on precipitation. In the case of the other sectors reduced precipitation has a much more indirect effect. Water supply costs will increase as a consequence of growing water scarcity, thus resulting in reduced benefits, but this mechanism will become significant only if precipitation is reduced by a much higher percentage than just 1%.

The value of return flows

Water particles withdrawn for domestic, agricultural or industrial use have a value because of their use in these sectors, but they can have some additional value due to the use of these particles later in the water cycle. Return flows to ground or surface water in particular can be valuable. Evaporation is often considered as a loss (although this is not completely correct, because the evaporated water can return as precipitation). From our analysis it appears that return flows contribute up to a few per cent to the total value of a water withdrawal. This contribution decreases if we go further downstream in the basin. As an example this effect is shown in figure 7 for the domestic sector. It is expected that if the use of water in the Zambezi basin intensifies in the future, the value of return flows will increase as well. The data show that investment in reducing evaporation losses will be more effective in the upstream parts of the river basin.

The value of percolation and direct runoff

Another interesting analysis result is that throughout the Zambezi basin the value of one cubic metre of percolation

water appears to be significantly higher than the value of one cubic metre of direct surface runoff. In the Middle Zambezi basin the value of percolation is even three times higher than the value of direct runoff. This is strongly connected to the fact that percolation water follows a longer path on its way towards the ocean than direct surface runoff. Percolation water can be used in between, before it reaches the river stream. Or in other words, there are more possibilities for the indirect (downstream) use of ground water than for the indirect use of surface water. This kind of information can be used to evaluate the effects of land use changes which result in changed percolation conditions, such as urbanisation and de- or reforestation.

5. Discussion

The above analysis has shown that the value-flow concept offers the possibility of accounting for the cyclic nature of water when estimating its value. As such, we think that the concept deserves further elaboration. We have touched upon several possible uses of the methodology. One can address, for instance, questions such as: what is the value of rainwater, how does the value of river water increase if we move from downstream to upstream, what is the value of a return flow, and what are the opportunity costs if we withdraw water from a location? One could also use the method to assess how spatial planning can have different effects on the net benefits of water or how climate change might affect the benefits of water. Equally, the methodology can be used to put the issues of water scarcity (valuable water) and flooding (non-valuable water) in one context. Downstream use of water increases the value of the upstream water. But the presence of downstream risks as a result of flooding puts a negative value on the upstream water. So one should perhaps even be reimbursed, instead of having to pay, if one

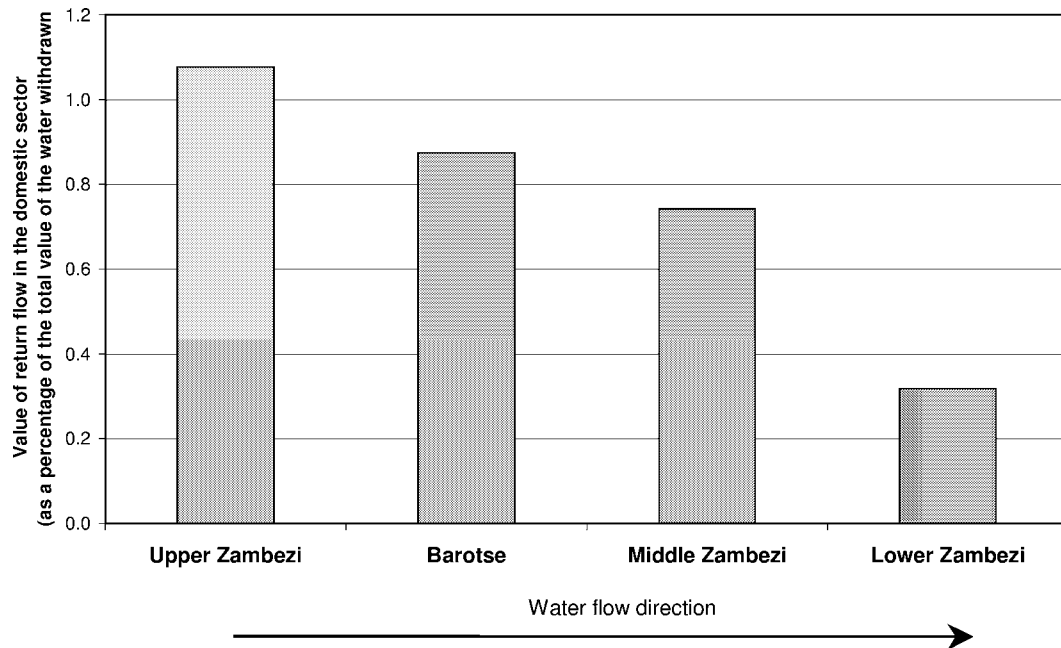

Figure 7. The value of return flows in the domestic sector in 1990 in comparison to the total value of the water withdrawn. The contribution of return flows to the total value of water withdrawals decreases if we move in a downstream direction.

were to use and thus delay the water in the upstream parts of a basin before it leads to flooding in the downstream part. . .

During our research we have come across numerous difficulties in putting the value-flow idea into practice. We solved these difficulties by making crude assumptions. The result is that the outcome of the current analysis should be seen as merely indicative and that the numbers should be regarded with caution. In order to generate more precise and validated value estimates, more research is needed to refine the assumptions and improve the basic data used. One of the most important things to be done is probably to consider how non-economic (e.g., ecological) values of water can be quantified and included in the analysis. Another theme we did not pay attention to is the effect of pollution on the value of water.

A further issue that could be taken up is the temporal resolution used. In the current analysis we have considered annual water flows and values for an average hydrological year. In reality both water flows and water values vary strongly not only during the year, but also between different years. A monthly time step would therefore be more appropriate. However, one then has to account for the time lag between the moment of a downstream benefit and the resulting indirect values of the upstream water flows.

Finally, we think it is important to provide a better empirical basis for the demand and supply curves used. For the sectors where water demand can be seen as a 'derived' demand, it is necessary to study more thoroughly what contribution water actually makes to the production of the final product and thus which value can be attributed to water.

Acknowledgement

This research has been sponsored by the Dutch Government through the ICES-2 programme and the European Union through the IRMA-SPONGE programme. The research is part of the research programmes of Delft Cluster and the Netherlands Centre for River Studies (NCR).

References

- [1] A.K. Chapagain, Exploring methods to assess the value of water: A case study for the Zambezi basin, M.Sc. thesis DEW112, International Institute for Infrastructural, Hydraulic and Environmental Engineering, Delft, The Netherlands (2000).
- [2] D.J. Molden, R. Sakthivadivel, C.J. Perry, C. de Fraiture and W.H. Kloezen, Indicators for comparing performance of irrigated agricultural systems, Research Report 20, International Water Management Institute, Colombo, Sri Lanka (1998).
- [3] A.Y. Hoekstra, *Perspectives on Water: A Model-Based Exploration of the Future* (International Books, Utrecht, The Netherlands, 1998).
- [4] FAO, FAOSTAT: Agriculture data, Food and Agriculture Organization, Rome, Italy (1999).
- [5] SADCC, Simulation of the joint operation of major power plants in the Zambezi basin, Final report, Southern African Development Coordination Conference, Maseru, Lesotho (1990).
- [6] SARDC, IUCN and SADC, State of the environment in Southern Africa, Southern African Research and Documentation Centre, Harare, Zimbabwe, The World Conservation Union, Harare, Zimbabwe, and Southern African Development Community, Maseru, Lesotho (1994).
- [7] M.S. Basson, in: *Water Resource Use in the Zambezi Basin*, Proceedings of a workshop held at Kasane, Botswana, eds. T. Matiza, S. Crafter and P. Dale (IUCN, Gland, Switzerland, 1995) pp. 41–48.