

## THE CARE ACCELERATOR R&D PROGRAMME IN EUROPE\*

O. Napoly, R. Aleksan, A. Devred, CEA/DSM/DAPNIA, Saclay, France, R. Garoby, R. Losito, L. Rinolfi, F. Ruggiero, W. Scandale, D. Schulte, M. Vretenar, CERN, Geneva, Switzerland, H. Mais, D. Proch, DESY, Hamburg, Germany, A. Ghigo, INFN/LNF, Frascati, Italy, V. Palladino, INFN, Napoli, Italy, T. Garvey, F. Richard, LAL, Orsay, France, E. Gschwendtner, University of Geneva, Switzerland, A. Den Ouden, Twente University, Enschede, The Netherlands

### Abstract

CARE, an ambitious and coordinated programme of accelerator research and developments oriented towards high energy physics projects, has been launched in January 2004 by the main European laboratories and the European Commission. This project aims at improving existing infrastructures dedicated to future projects such as linear colliders, upgrades of hadron colliders and high intensity proton drivers. We describe the CARE R&D plans, mostly devoted to advancing the performance of the superconducting technology, both in the fields of RF cavities for electron or proton acceleration and of high field magnets, as well as to developing high intensity electron and proton injectors. We highlight some results and progress obtained so far.

### THE CARE PROJECT

The CARE project is an Integrated Infrastructure Initiative supported by the European Commission (EC) within the 6<sup>th</sup> Framework Programme (FP6). Over the years 2004-2008, it aims at improving existing accelerator infra-structures such as those listed in Table 1. Twenty two contracting laboratories and a large number of associated institutes and industrial partners participate in this integrating effort. The CARE general organisation and participation are available on the CARE web site [1] together with the detailed description of work [2].

### THE CARE OBJECTIVES

The main objective of the CARE project is to generate a structured and integrated European area in the field of accelerator research and related R&D. The programme includes the most advanced scientific and technological developments relevant to accelerator research for Particle Physics. It is articulated around 3 Networking Activities that provide the long-term scientific vision, and 4 Joint Research Activities which integrate scientific and technical developments over several laboratories.

#### Networking Activities

The aim of the Networking Activities is to foster and strengthen European knowledge to evaluate and develop efficient methods to produce intense and high-energy electron, proton, muon and neutrino beams as recommended by the European Committee for Future

\*Work supported by the European Community-Research Infrastructure Activity under the FP6 "Structuring the European Research Area" programme (CARE, contract number RII3-CT-2003-506395).

Accelerators (ECFA). They will establish collaborative and prioritised R&D programs aimed at establishing roadmaps toward the longer-term construction of new facilities of worldwide interest.

Table 1: The main existing infrastructures

Laboratory	Accelerator	Description
CCLRC-RAL	ISIS	Accelerator complex for the neutron and muon facility
CEA	IPHI CryHoLab	High intensity proton injector Hor. <sup>tal</sup> cryogenic test stand
CERN	PS, SPS, LHC CNGS CTF3	Proton accelerator complex Neutrino beam Electron two-beam linac test facility
CNRS-Orsay	NEPAL	Test stand with photo injector Coupler test laboratory
DESY	PETRA, HERA TTF	Electron and proton accelerator complex Electron superconducting linac test facility and FEL
FZR	ELBE	Electron linear accelerator
GSI	SIS, ESR	Heavy-ion accelerator complex
INFN-LNF	DAPHNE	Electron-positron collider
PSI	SINQ	Accelerator complex for the neutron and muon facility

Three Networking Activities span the full duration of the project

- ELAN (Electron Linear Accelerator Network) for electron accelerators and linear colliders;
- BENE (Beams in Europe for Neutrino Experiments) for neutrino and muon beams;
- HHH (High energy High intensity Hadron beams) for hadrons rings and colliders.

#### Joint Research Activities

Four Joint Research Activities aim at developing critical and/or beyond the actual state-of-the-art components and systems to upgrade the infrastructures:

- SRF (Superconducting RF): the development of the superconducting cavity technology for the acceleration of electrons with gradient exceeding 35MV/m and the development of the necessary RF technology;
- PHIN (Charge production with Photo-injectors): the improvement of the technology of photo-injectors, in

particular to match the severe requirements necessary for demonstrating the two-beam acceleration concepts;

- HIPPI (High Intensity Pulsed Proton Injector): the developments of normal and superconducting structures for the acceleration of very high-intensity proton beams as well as challenging beam chopping magnets;
- NED (Next European Dipole): the development and mastering of the Nb<sub>3</sub>Sn technology for reaching very high magnetic fields (>15T) and high current densities (>1500A/mm<sup>2</sup>).

The SRF and PHIN activities are foreseen to end in 2007, HIPPI in 2008, and NED in 2006.

### HIGHLIGHTS OF THE CARE PROJECT

In this section, we highlight some of the progress obtained in the year 2004. A complete review of the first year activity was made at the CARE'04 annual meeting [3] held in November at DESY, and is documented in the CARE Annual Reports [4].

#### Networking Activities

Each Networking Activity has organized several internal meetings and broader workshops where the scientific case and the strategy of the field have been discussed. Highlighting one such event per activity:

- ELAN organized in November at DESY a meeting [3] where the European contributions to the International Linear Collider (ILC) project, in preparation of the first ILC workshop at KEK, were assembled.
- BENE co-organized in May at CERN the workshop "Physics at a Multi MegaWatt Proton Source" [5] which reviewed the parameters of a proton driver for a future neutrino facility.
- HHH organized in November at CERN the workshop "Beam Dynamics in Future Hadron Colliders and Rapidly Cycling High-Intensity Synchrotrons" [6] which reviewed the critical items and possible scenarios for CERN-LHC and GSI-SIS upgrades.

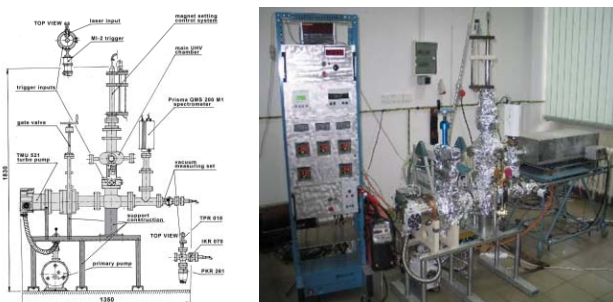

Figure 1: UHV linear-cathode arc stand at IPJ, Swierk

#### The SRF Joint research Activity

- Scientific investigations on coated Niobium films by the vacuum arc method at IPJ-Swierk (see Fig.1) and INFN-Roma have shown that the superconducting properties, i.e.  $J_c$  and  $T_c$ , are the same as in bulk Niobium
- The progress with the preparation of cavities by electropolishing (see Fig. 2) and moderate bake out give

hope that this method results in cavities with accelerating gradients above 30 MV/m and quality factors above  $10^{10}$ .

- RF studies at CNRS-Orsay of two alternative couplers design are complete (see Fig. 3). Prototypes will be built in industry and RF tests are foreseen in spring of 2006.
- The progress in the design of two piezo-tuners, lateral at CEA or axial at INFN-Milano (see Fig.4), will allow the fabrication and RF-tests of tuner prototypes in 2005.

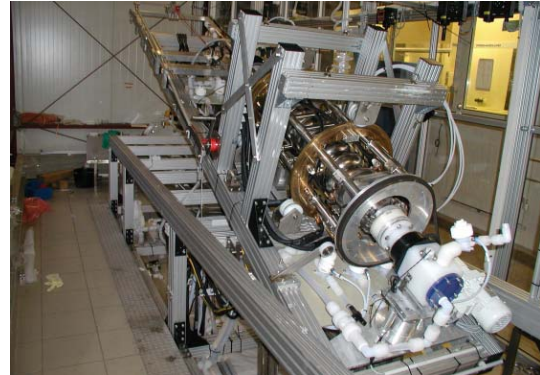

Figure 2: Electropolishing setup at DESY

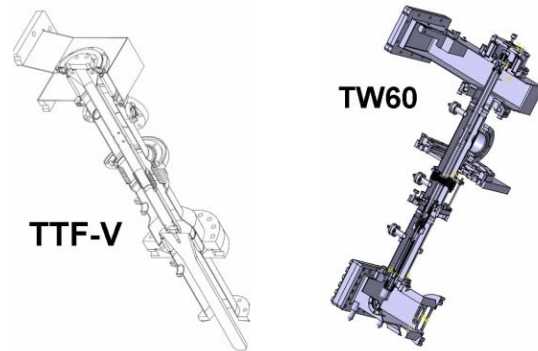

Figure 3: Design of two alternative coupler prototypes

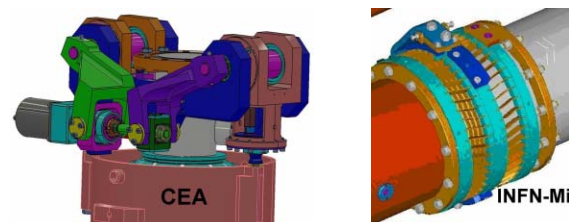

Figure 4: Design of two piezo-electric tuner prototypes

#### The PHIN Joint research Activity

- The characteristics of more than 30 photocathodes, (preparation condition, quantum efficiency, laser wavelength, lifetime, vacuum conditions...) were collected.
- A new superconducting RF gun with 3 1/2 cells has been designed at FZR-ELBE (see Fig.5).
- The demonstration of a high charge (0.5nC) mono-energetic 170 MeV ± 20 MeV electron beam generation in the laser plasma accelerator concept has been achieved at CNRS-LOA (see Fig. 6).
- Experiments on pulse shaping with the acousto-optic modulator (Dazzler) achieved the required square laser pulse characteristics before the amplifier system at INFN.

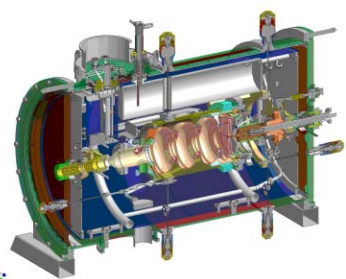

Figure 5: Cryomodule design for the SC-RF gun

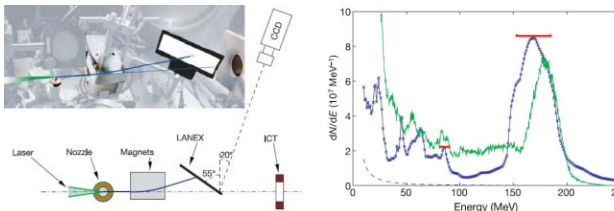

Figure 6: Laser-plasma acceleration: left, experimental setup and, right, data (blue) vs. simulation (green) results

**The Joint research Activity: HIPPI**

- RF studies have been completed and prototypes are in fabrication for a Cross-H DTL at GSI and a Cell Coupled DTL at CERN (see Fig.7).
- A  $\beta=0.47$  elliptical cavity fabricated at INFN-Milano reached 16 MV/m accelerating gradient with  $Q_0 = 5 \cdot 10^9$  at a vertical RF test in CEA-Saclay (see Fig. 8).
- Superconducting spoke resonators and CH prototype cavities, ranging  $\beta=0.1$  to  $\beta=0.35$ , have been designed at FZJ-Jülich, CNRS-Orsay and IAP-Frankfort (see. Fig.9), and fabricated in industry. RF tests have started.
- A multi-laboratory comparison of 3D high intensity linac codes with space charge solvers has been initiated and a benchmarking experiment in the UNILAC DTL at GSI is being prepared.

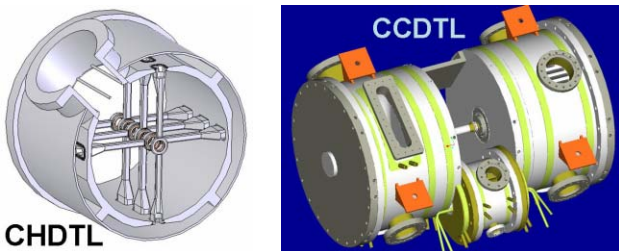

Figure 7: Drift Tube Linac designs

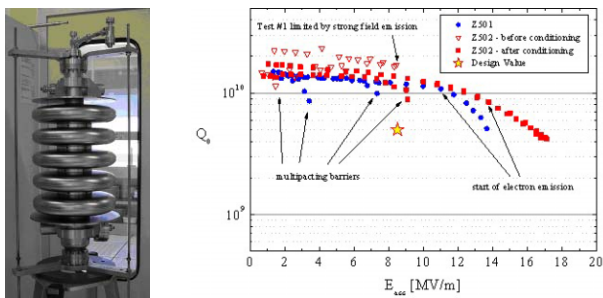

Figure 8: Vertical test of  $\beta=0.47$  elliptical cavity

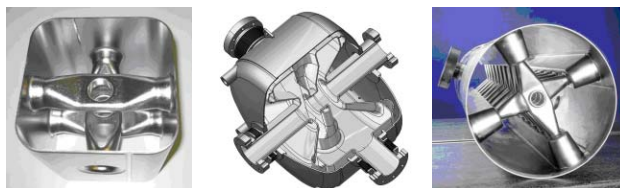

Figure 9: Superconducting spoke resonators (left, FZJ; middle CNRS-Orsay) and CH cavities (right, IAP-FU)

**The Joint research Activity: NED**

- NED and HHH co-organized in March at Archamps the workshop “Accelerator Magnet Superconductors” [7] to review present R&D and define directions of developments in connection with European industries.
- Magnetic designs for large bore and high field dipole magnets have been studied at CERN in order to define the characteristics of Nb<sub>3</sub>Sn strands suitable to reach a 15 T field for two different apertures (see Table 2).
- Two contracts for Nb<sub>3</sub>Sn conductor development have been awarded to Alstom/MSA (France) and SMI (The Netherlands).

Table 2: Nb<sub>3</sub>Sn dipole parameters

Bore [mm]	Design Type	B <sub>0</sub> [T]	Energy [kJ/M]	Max Pres. [MPa]	Outer Diam. [mm]
88	Layer	14.42	1810	148	1004
160	Slot	13.87	3959	129	1734

**CONCLUSION**

The CARE project started successfully a multi-laboratory collaborative effort following the multi-year plan of integrated R&D programmes. Many parts of the programme are synergetic like the tuner and coupler developments between SRF and HIPPI. Driven by particle physics, the CARE project has also strong synergies with other programmes supported by the European Union like EURISOL for nuclear physics, XFEL and EUROFEL for free electron lasers and ITER for fusion research. Dissemination of the acquired knowledge proceeds via the CARE publication repository [8] and the organisation of activity workshops and of the CARE annual meeting.

**REFERENCES**

- [1] <http://esgard.lal.in2p3.fr/Project/Activities/Current/>
- [2] [http://esgard.lal.in2p3.fr/Project/Activities/Current/Overall/CARE\\_Annex1\\_16Jan04.pdf](http://esgard.lal.in2p3.fr/Project/Activities/Current/Overall/CARE_Annex1_16Jan04.pdf)
- [3] <http://care04.desy.de/>
- [4] <http://dphs10.saclay.cea.fr/Doc/Care/care-rapport-index-2005.php>
- [5] <http://physicsatmwatt.web.cern.ch/physicsatmwatt>
- [6] <http://care-hhh.web.cern.ch/CARE-HHH/HHH-2004>
- [7] [http://amt.web.cern.ch/amt/events/workshops/WAMS2004/wams2004\\_index.htm](http://amt.web.cern.ch/amt/events/workshops/WAMS2004/wams2004_index.htm)
- [8] [http://dphs10.saclay.cea.fr/Doc/Care/care\\_index.php](http://dphs10.saclay.cea.fr/Doc/Care/care_index.php)