

# Evaluation of Pneumatic Cylinder Actuators for Hand Prostheses

Bart Peerdeman<sup>\*</sup>, Gerwin Smit<sup>†</sup>, Stefano Stramigioli<sup>\*</sup>,  
Dick Plettenburg<sup>†</sup>, and Sarthak Misra<sup>\*</sup>

**Abstract**—DC motors are currently the preferred actuation method for externally powered hand prostheses. However, they are often heavy and large, which limits the number of actuators that can be integrated into the prosthesis. Alternative actuation methods are being researched, but have not yet found wide application. In this paper, a thin-walled pneumatic cylinder actuator is implemented to move a single-DOF prosthetic hand. Its performance is compared to that of a commercially available DC motor. Both systems are evaluated on speed, responsiveness, and energy capacity. Other properties such as size and mass are also taken into account. While the pneumatic cylinder is capable of high speeds and forces while remaining lightweight, quiet and small, it can prove difficult to control. Improvements to the cylinder design and valve system are recommended, in order to develop the potential of pneumatic cylinder actuators in modern multifunctional hand prostheses.

## I. INTRODUCTION

Modern externally powered prosthetic hands are almost exclusively actuated by DC motors, which are readily commercially available. Unfortunately, these motors generally have a relatively high mass and size. Also, because prosthesis actuation requires high torques, a transmission is required; the associated gear ratios can reduce the motor's speed to below an acceptable level.

Pneumatic actuators are an alternative to DC motors offering a high power-to-mass ratio and convenient energy storage in the form of disposable gas cartridges [1]. In the field of pneumatic prosthesis actuation, two main approaches have been used to some success: pneumatic cylinders, and pneumatic artificial muscles (PAMs) [2]. Recent research in pneumatics for robotic and prosthetic hands often involves PAMs (e.g. [3], [4], [5], [6]), while cylinder actuators are rarely encountered. However, recent research suggests that properly dimensioned pneumatic cylinders offer advantages in mass, size, and power-to-mass ratio when compared to common PAMs [7]. Therefore, further investigation of pneumatic cylinder actuation for modern hand prostheses is desired.

The goal of this paper is to determine whether the pneumatic cylinder actuator can be a viable option for the actuation of prosthetic hands. To this end, a prosthesis test setup is developed, and both a custom pneumatic cylinder and a commercial DC motor are used to actuate it.

The prosthesis to be used in these experiments is the WILMER central pushrod operated hand [8] (Figure 1). The

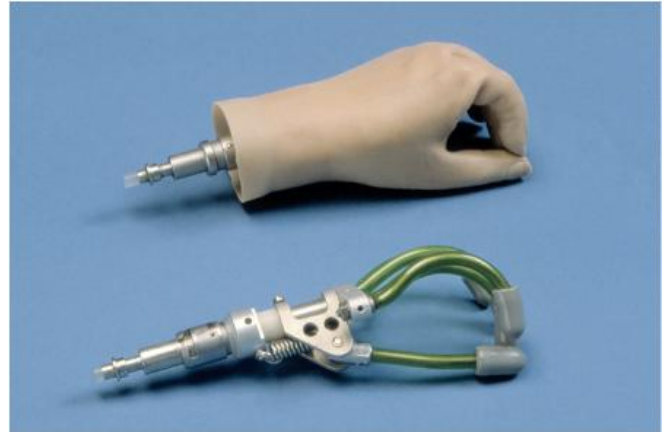

Fig. 1. The WILMER central pushrod operated hand [8], with and without cosmetic sleeve.

hand has a single degree of freedom (DOF) in the thumb base, for opening and closing. The thumb is connected to a spring, which keeps the hand closed when no force is applied.

A list of hand prosthesis requirements has been derived from user needs during activities of daily living [9]. Test metrics for speed, responsiveness and energy storage are based on these requirements, and used to compare the actuators. The result of these tests serve to demonstrate the effectiveness of pneumatic cylinder actuation in modern hand prostheses, and can be used to further improve their design.

In Section II, the test metrics are described. Section III shows the design of the test setup and the specifications of the actuators and accessories. The test results are listed in Section IV, and are discussed in Section V. The paper is concluded in Section VI, and directions for future work are provided.

## II. REQUIREMENTS / TEST METRICS

Based on implementation of the actuators in a hand prosthesis, a list of requirements can be derived. These requirements and the related test metrics are described below.

### A. Speed

The speed of the hand is essential for its acceptance by the user. On average, electrically powered hands currently have closing times between 0.5 s and 1 s [9]. Though the DC motor actuator has a high speed by itself, its relatively low torque requires a significant gear reduction. Also, the pneumatic actuator may need some time to build up sufficient

<sup>\*</sup> MIRA - Institute for Biomedical Technology and Technical Medicine (Control Engineering Group), University of Twente, the Netherlands.

<sup>†</sup> Department of Biomechanical Engineering (Biomechanics and Biorobotics Laboratory), Delft University of Technology, the Netherlands.

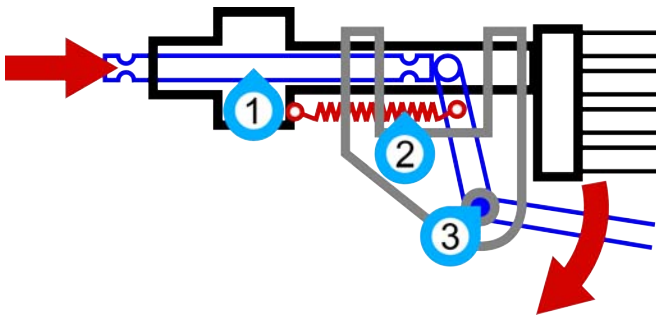

Fig. 2. A sketch of the WILMER hand's internal mechanics, pointing out key components: (1) the pushrod, (2) the spring, and (3) the lever arm. The red arrows indicate the input force and the movement of the mechanism during hand opening.

pressure to exert the necessary force. This metric will be evaluated by measuring the time required to open the hand from full flexion to full extension and back. The return time is important even though the hand is forced closed by its internal spring, as the DC motor will need to actively close the hand due to its non-backdrivable transmission.

### B. Responsiveness

High responsiveness of the actuator means a minimal delay between a command being sent and the start of actual movement. A quick response is important for intuitive control. It will be evaluated by measuring the time from sending the initial activation signal, to the time the change in position of the hand first exceeds the average sensor noise level.

### C. Capacity

The standard energy storage system for DC motors in current myoelectric prostheses is a rechargeable Lithium-Ion (Li-Ion) battery pack, while the pneumatic actuator used here runs on compressed CO<sub>2</sub> cartridges. The prosthesis should be continuously usable during the day. The actuators' respective capacities will be determined by measuring the number of grasp cycles that can be performed with a full battery pack or gas cartridge.

### D. Other metrics

Some metrics, while important to the comparison of the actuation systems, can simply be evaluated by inspection or basic measurements. These are the following: the size and mass of the actuator and any accessories (such as transmission or energy storage), the loudness of the actuator, and any changes in performance while grasping an object.

## III. TEST SETUP

The test setup consists of three main components: the hand prosthesis and its mounting; the DC motor actuation system; and the pneumatic actuation system.

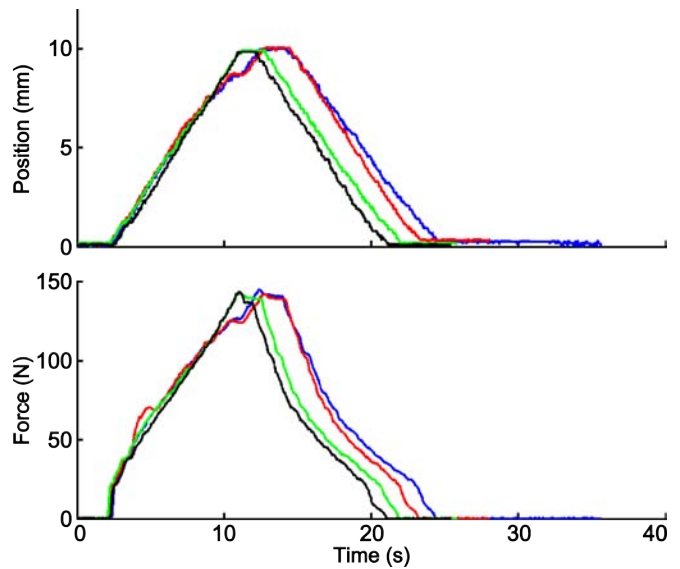

Fig. 3. Results of the preliminary experiment to determine the required force and stroke for actuation of the test setup.

TABLE I  
MAXIMUM AND AVERAGE FORCE AND STROKE VALUES MEASURED IN THE PRELIMINARY EXPERIMENT.

Measurement	1	2	3	4
Maximum force (N)	144.65	141.77	142.33	143.21
Average force (N)	77.53	78.01	72.95	70.61
Maximum stroke (mm)	9.80	9.99	9.76	9.75
Average stroke (mm)	5.63	5.70	5.25	5.04

### A. Hand prosthesis

The mechanics of the WILMER hand can be seen in Figure 2. The hand uses a 'voluntary open' mechanism, which consists of a spring holding the hand closed, and a lever arm connecting the thumb to a pushrod. When the pushrod is pushed, the hand opens, and when the pushrod is released, the spring closes the hand automatically. The hand design exerts a constant force on the actuator while keeping the hand open, which requires the actuation systems to be non-backdrivable.

Two sensors will be attached to the hand during testing, to determine the forces and displacements needed to evaluate the actuators. The actuation force will be measured via a 1-DOF compression force transducer (HBM C9B [10]), fitted between the actuator and the pushrod. The hand position is determined using a linear Hall effect sensor (Allegro A1301 [11]), which measures the distance to a small magnet attached to the force sensor block.

The force and stroke required to actuate the hand were measured in a preliminary experiment. For this experiment, the test setup was connected to a manual spindle, and the hand was moved from fully closed to fully opened and back. The applied force and spindle position were measured; the results can be found in Figure 3 and Table I. For a proper comparison, both actuators should be capable of these forces and strokes.

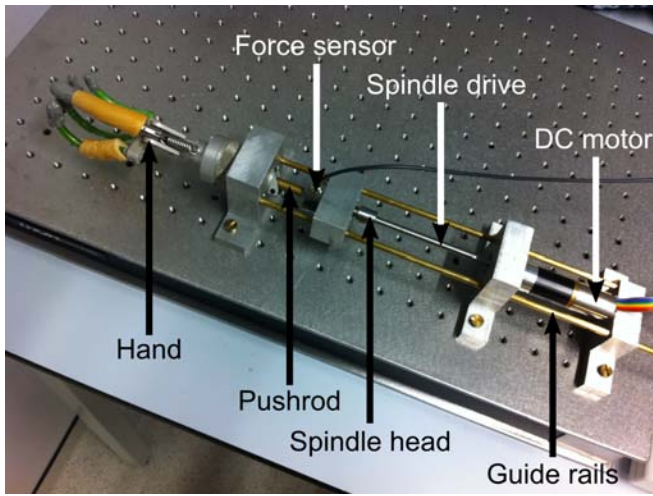

Fig. 4. A picture of the DC motor test setup, indicating relevant systems.

TABLE II

DC MOTOR SPECIFICATIONS FOR SEVERAL MODERN HAND PROSTHESES. (A): MAXON EC 13, (B): MAXON EC-MAX 22, (C): FAULHABER 2224 U 006 SR, (D): FAULHABER 1727 U 006 C.

Motor	A [12]	B [15]	C [14]	D [13]
Output power (W)	6	12	4.55	2.37
No-load speed (rpm)	28300	10800	8200	7800
Speed constant (rpm/V)	4950	1870	1380	1460
Torque constant (mNm/A)	1.93	5.12	6.92	6.53
Maximum efficiency (%)	63	67	82	70
Mass (g)	15	67	46	28
Radius (mm)	6.5	11	11	8.5
Length (mm)	21.4	32	24.2	27

### B. DC motor actuator

The DC motor actuator needs to be representative of the current state of the art in modern hand prosthesis prototypes [12], [13], [14]. These systems feature small brushless DC motors, which are capable of torques around 1-10 mNm, and use planetary gearheads to increase this torque to the level required to actuate the hand. For this test, a Maxon EC-max 22 motor [15] has been chosen. Its specifications can be found in Table II, along with the specifications of other motors used in several modern prosthesis prototypes. While the EC-max 22's mass and weight are above average, its performance is comparable to that of the other motors.

Because the prosthesis is kept closed by a spring, the transmission needs to be non-backdrivable in order to prevent excessive stall torques on the actuator while holding the hand open. A spindle drive has been selected for this purpose. The required input torque ( $\tau_{in}$ ) depends on the output force ( $F_{out}$ ), the spindle pitch ( $p$ ) and transmission efficiency ( $\eta$ ) as follows:

$$\tau_{in} = \frac{F_{out} \cdot p}{2\pi \cdot \eta}$$

For this spindle drive,  $p = 0.002$  and  $\eta = 0.67$ . This leads to a  $\tau_{in}$  of approximately 71.3 mNm. Given that the nominal torque of the motor is approximately 11 mNm, at least a 1:7 gear ratio is required. A 1:14 gear ratio was chosen.

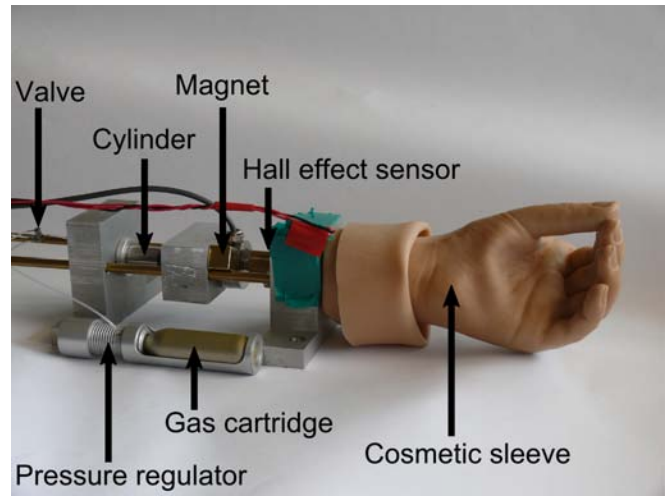

Fig. 5. A picture of the pneumatic actuator test setup, indicating relevant systems.

The DC motor is powered by a commercially available prosthesis battery, the Otto Bock EnergyPack 757B20 [16]. This battery has a capacity of 900 mAh at 7.2V, which represents 23.3 kJ of energy. The work to be done by the actuator to open the hand is an average of 72.5 N acting through a distance of 10 mm, or 0.725 J. Given that hand closure needs to be actuated as well, and that both the battery and motor have a rated efficiency of around 66%, this would allow for approximately 3500 hand opening/closing cycles. The design of the DC motor test setup can be seen in Figure 4.

### C. Pneumatic actuator

The pneumatic actuator assembly consists of the pneumatic cylinder, connective tubing, a valve, and a CO<sub>2</sub> cartridge with pressure regulator. The test setup including the hand prosthesis can be seen in Figure 5, and a pneumatic circuit of the system is shown in Figure 6.

The custom-built cylinder (shown in Figure 7) has been designed to provide an actuation force comparable to that of the DC motor, while minimizing its size and mass. It is 20.2 mm in length, has a radius of 6.5 mm and a mass of 3.04 g. The cylinder is directly connected to the hand prosthesis, without any transmission. The maximum stroke of the pneumatic actuator is 10 mm. The cylinder is made of steel, and has a very thin wall (0.2 mm). The cylinder is operated at a pressure of 1.2 MPa, which has been shown to use the minimum amount of gas per operating cycle [17]. With this pressure, the piston's surface should be at least 121 mm<sup>2</sup> (a radius of 6.2 mm) to provide sufficient force. An O-ring, placed in a groove in the piston, seals the gap between the piston and the cylinder. By choosing a low groove depth, the O-ring will be compressed between the piston and cylinder wall. This provides a tighter seal, but also increases friction. However, because the cylinder is single acting, the O-ring is always pushed in one direction. This allows the O-ring to be uncompressed or 'floating', which minimizes friction. The

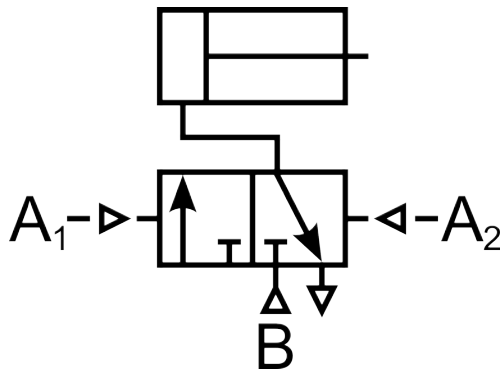

Fig. 6. Pneumatic circuit of the actuator system used in the experiments. Inputs marked with  $A_1$  and  $A_2$  are connected to an external air supply; the input marked with  $B$  is connected to the  $\text{CO}_2$  cartridge and pressure regulator.

piston shaft is made of polychlorotrifluoroethylene (PCTFE), to reduce friction along the cylinder wall and keep the piston mass low.

The actuator is powered by commercially available  $\text{CO}_2$  cartridges, which contain approximately 7.7 grams of  $\text{CO}_2$ . At 20 degrees Celsius and a pressure of 1.2 MPa,  $\text{CO}_2$  has a density of approximately  $23.4 \text{ kg/m}^3$ . When fully extended, the cylinder's volume is  $1250 \text{ mm}^3$ , which at this density requires 29.2 mg of  $\text{CO}_2$  to fill. Assuming no leaking or temperature variations, a 7.7 g cartridge will therefore contain enough  $\text{CO}_2$  for approximately 263 grasping cycles.

The  $\text{CO}_2$  cartridges are housed in a custom pressure regulator [1]. To control the flow of  $\text{CO}_2$  to and from the cylinder a miniature two-way valve is implemented, which for these experiments is actuated by an external air supply. For implementation in an actual hand prosthesis, a solenoid valve will need to be used. To open the hand, the cylinder is pressurized; when the air is vented from the cylinder, the hand prosthesis' spring delivers the force to return the piston to its initial position.

#### D. Experiments

For both actuator types, the following test protocol is used:

- 1) *Initial testing.* First, the hand performs 10 complete open/close cycles. This test is used to evaluate the actuators' speed and responsiveness; both actuators are controlled between the two end positions of the hand by a simple on-off system.
- 2) *Capacity test.* The associated energy capacity is determined differently for each actuator. For the DC motor, current drain is monitored during initial testing; the average current drain is combined with the battery capacity to determine the maximum operating time. For the pneumatic cylinder, a full gas cartridge is connected and the hand is programmed to perform continuous open/close cycles. The time until the hand stops moving is measured.
- 3) *Inspection metrics.* Finally, any metrics that can be evaluated by inspection (Section II-D) are measured.

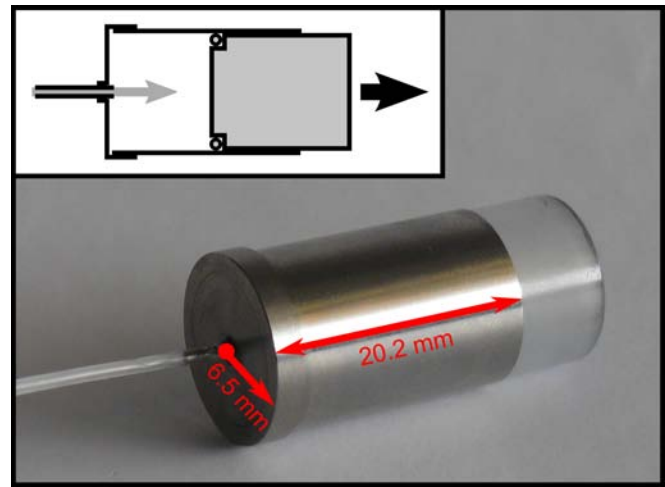

Fig. 7. The thin-walled pneumatic cylinder actuator, specifically designed for prosthesis applications. A cross-section of the cylinder is shown in the top left corner.

Both test setups are controlled and measured using LabVIEW [18].

## IV. RESULTS

In this section, the tests carried out on both actuators are described, and their results are shown.

#### A. DC motor testing

The DC motor testing setup is shown in Figure 4. The setup is connected to a National Instruments ELVIS II data acquisition device (DAQ) [19], which is in turn connected to a PC running a LabVIEW [18] script for control.

1) *Initial testing:* The test results for 10 full open/close cycles can be seen in Figures 8 and 9; average and maximum speed and force values can be found in Table III.

2) *Capacity test:* The Otto Bock EnergyPack 757B20 [16] has a capacity of 900 mAh. During the initial open/close testing, the motor current was 0.675 A on average during opening, and 0.376 A on average during closing. Under this load a fully charged battery lasts for around 108 minutes, or about 2000 open/close cycles.

3) *Inspection metrics:* The size and mass values for modern DC motor actuators can be found in Table II. The size of the Otto Bock EnergyPack is  $70 \times 32 \times 18 \text{ mm}$ , and its mass is 65 g. The sound level of the motor was measured at a distance of 1 meter from the setup. To represent the loudness of the actuator in terms of human sound perception, the measured values have been adjusted by a weighting filter. In this case, A-weighting has been used [20]; the results can be seen in Figure 10.

After initial open/close testing, 10 more open/close cycles were performed, this time with an object to be grasped by the hand. While the object removes the load on the actuator when held, the actuator's overall performance is unaffected. It should also be noted that although the spindle drive provides sufficient force to fully open the hand, some backdriving

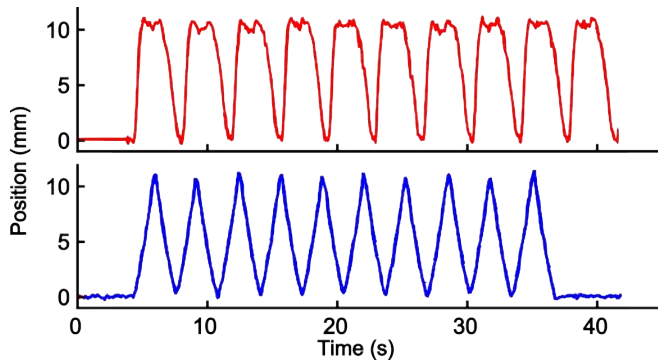

Fig. 8. The pushrod position during 10 open/close cycles of the pneumatic cylinder (red) and the DC motor (blue).

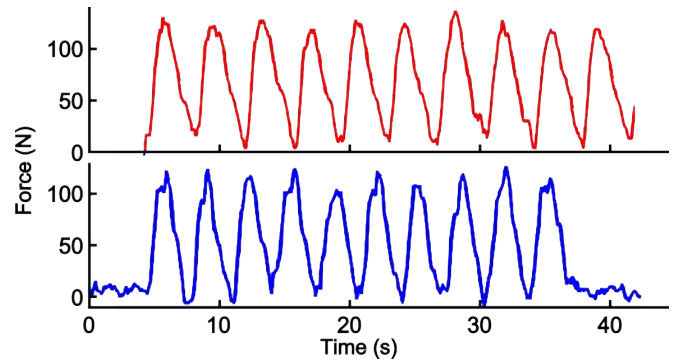

Fig. 9. The actuator force during 10 open/close cycles of the pneumatic cylinder (red) and the DC motor (blue).

TABLE III

COMPARISON OF INITIAL TEST RESULTS FOR THE DC MOTOR AND PNEUMATIC CYLINDER.

Actuator	DC motor	Pneumatic cylinder
Average open/close time (s)	3.03	3.65
Maximum speed (mm/s)	8.57	14.48
Average force (N)	45.1	64.0
Maximum force (N)	125.0	122.2
Capacity (Cycles)	2000	300

was observed when attempting to maintain a fully open hand position.

### B. Pneumatic cylinder testing

The pneumatic actuator test setup is shown in Figure 5. The same DAQ and software are used as with the DC motor tests.

1) *Initial testing:* The results of open/close cycle testing for the pneumatic actuator can be seen in Figures 8 and 9; average and maximum speed and force values can be found in Table III.

2) *Capacity test:* In this experiment, a full gas cartridge was connected, and the hand was programmed to continuously open and close until it was depleted. The cartridge was emptied after completing 300 open/close cycles, which lasted 19 minutes.

3) *Inspection metrics:* The pneumatic cylinder (Figure 7) is 20.2 mm in length, with a radius of 6.5 mm; its overall mass is 3.04 g. The gas cartridges weigh approximately 28.8 g apiece when full, and 21.1 g when empty. They are 66 mm long, with a radius of 8.9 mm. The mass of the pressure regulator is 26.9 g.

As opposed to the DC motor, the speed of the pneumatic actuator is fixed, so only one sound level could be measured; at 1 meter distance, the maximum loudness varied between 40-45 dB. Because the pneumatic actuator relies on the prosthesis' spring for a closing force, grasping an object does not have a significant effect on the force/position characteristics.

## V. DISCUSSION

For each of the metrics listed in Section II, the test results are used to compare the performance of the two actuators.

### A. Speed

The differences in the speed of both actuators can be best evaluated by looking at the characteristics of the hand positions over time. The DC motor operates reliably and constantly at its maximum speed of 8.57 mm/s, both when opening and closing the hand. The pneumatic actuator's top speed is almost twice that of the DC motor, but it suffers from its unidirectional action; while the opening of the hand happens within 0.6 seconds, waiting for the CO<sub>2</sub> to vent from the cylinder and the spring to close the hand takes up to 3 seconds. This can partly be attributed to the two-way valve used in the experiment, which was designed previously for a toddler size prosthetic hand mechanism [17], and is not optimized for its current application.

### B. Responsiveness

After the pneumatic actuator's two-way valve is opened, it takes approximately 0.3 seconds for the pressure in the cylinder to overcome the force of the closing spring, and start to open the hand. In contrast, the DC motor reacts almost immediately to an activation signal. This is a significant advantage, as low activation delays are considered important to prosthesis users [9].

### C. Capacity

The capacity of the Li-Ion-based Otto Bock Energypack was sufficient for 2000 open/close cycles, which is roughly half the number calculated in Section III-B. This discrepancy was likely caused by friction losses in the transmission, which were not taken into account. For the pneumatic system a single CO<sub>2</sub> cartridge has been observed to last for 300 grasping cycles, which slightly exceeds the preliminary calculations in Section III-C.

In [21], the number of active uses of a myoelectric prosthesis was found to be around 41 per hour. With this frequency of operation, the DC motor would be usable for an entire day, while the pneumatic cylinder would have to be replaced at least once.

The most noticeable difference between these two for normal operation is that the Li-Ion battery is rechargeable, while the pneumatic cylinders are disposable. It is easy to

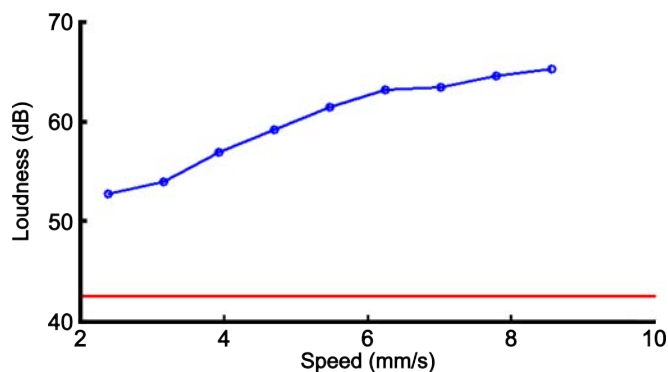

Fig. 10. The A-weighted volume of the DC motor corresponding to various spindle speeds is shown in blue. The volume (in dB) of the pneumatic cylinder is shown in red.

carry a few spare gas canisters around and quick and simple to replace them, while recharging the battery can take several hours. It should be noted that large numbers of these canisters would be required for continuous use of the prosthesis.

#### D. Other metrics

While for this experiment a relatively large and heavy DC motor was chosen (see Table II), other commonly used DC motors are still larger and heavier than the pneumatic cylinder, especially considering the added transmission larger energy storage.

The continuous noise the DC motor generates is much louder than that of the pneumatic actuator, which only produces a hissing sound when venting the cylinder. The sound of escaping CO<sub>2</sub> would also be easier to dampen out or displace when implemented in an actual prosthesis. Grasping an object did not have any effect on either actuator's performance; because the prosthesis contains a voluntary open mechanism, grasping an object does not lead to additional load on the actuators.

## VI. CONCLUSION

For hand prosthesis applications, a thin-walled pneumatic cylinder actuator can compare favorably in performance to commonly used DC motors. The pneumatic cylinder offers equal forces and higher closing speeds, with a mass over 10 times less than the average DC motor. Drawbacks of the current design are a slower return speed and unidirectionality of actuation. To remedy this, the cylinder can be redesigned to enable double action, and the valve design can be optimized for increased gas flow.

The gas cartridges used for pneumatic energy storage are smaller and lighter than their electrical equivalent as well, and though their energy capacity is an order of magnitude less than that of commonly used prosthesis batteries, the prosthesis should last up to 8 hours on a single cartridge.

In general, the low mass, small size, and fast action of a pneumatic cylinder makes it an attractive option for actuation of modern hand prostheses. With an improved cylinder design and the addition of miniature solenoid valves, a

pneumatic system can be created which outperforms current electric devices, enabling lighter and smaller hand prostheses.

## REFERENCES

- [1] D. H. Plettenburg, "Electric versus pneumatic power in hand prostheses for children," *Journal of Medical Engineering & Technology*, vol. 13, no. 1-2, pp. 124-128, 1989.
- [2] F. Daerden and D. Lefeber, "Pneumatic artificial muscles: actuators for robotics and automation," *European journal of Mechanical and Environmental Engineering*, vol. 47, pp. 10-21, 2000.
- [3] Y. Lee and I. Shimoyama, "A skeletal framework artificial hand actuated by pneumatic artificial muscles," in *Proceedings of the IEEE International Conference on Robotics and Automation (ICRA)*, vol. 2, 1999, pp. 926-931 vol.2.
- [4] T. Noritsugu, D. Sasaki, and M. Takaiwa, "Application of artificial rubber muscles to a human friendly robot," in *Proceedings of the IEEE International Conference on Robotics and Automation (ICRA)*, vol. 2, September 2003, pp. 2188-2193, vol.2.
- [5] H. Takeda, N. Tsujiuchi, T. Koizumi, H. Kan, M. Hirano, and Y. Nakamura, *Development of prosthetic arm with pneumatic prosthetic hand and tendon-driven wrist*, 2009, vol. 1.
- [6] Shadow Robot Company. Shadow dextrous hand, featuring air muscles. [Online]. Available: <http://www.shadowrobot.com/hand/>
- [7] D. Plettenburg, "Pneumatic actuators: a comparison of energy-to-mass ratio's," in *Proceedings of the International Conference on Rehabilitation Robotics (ICORR)*, Chicago, USA, July 2005, pp. 545-549.
- [8] Delft Prosthetics. Wilmer quick exchangeable hand prosthesis. [Online]. Available: <http://www.delftprosthetics.com/en/products/exchangeable-hand-prosthesis>
- [9] B. Peerdeman, D. Boere, H. Witteveen, R. Huis in 't Veld, H. Hermens, S. Stramigioli, J. Rietman, P. Veltink, and S. Misra, "Myoelectric forearm prostheses: State of the art from a user requirements perspective," *Journal of Rehabilitation Research & Development (JRRD)*, vol. 48, no. 6, pp. 719-738, July 2011.
- [10] HBM. C9b force transducer. [Online]. Available: <http://www.hbm.com/>
- [11] Allegro MicroSystems, Inc. A1301 continuous-time ratiometric linear hall effect sensor ic. [Online]. Available: <http://www.allegromicro.com>
- [12] C. Light and P. Chappell, "Development of a lightweight and adaptable multiple-axis hand prosthesis," *Medical Engineering and Physics*, vol. 22, pp. 679-684, 2000.
- [13] J. Pons, E. Rocon, R. Ceres, D. Reynaerts, B. Saro, S. Levin, and W. van Moorleghe, "The MANUS-HAND dextrous robotics upper limb prosthesis: Mechanical and manipulation aspects," *Autonomous Robots*, vol. 16, no. 2, pp. 143-163, 2004.
- [14] M. Carrozza, C. Suppo, F. Sebastiani, B. Massa, F. Vecchi, R. Lazarini, M. Cutkosky, and P. Dario, "The SPRING hand: Development of a self-adaptive prosthesis for restoring natural grasping," *Autonomous Robots*, vol. 16, pp. 125-141, 2004.
- [15] Maxon Motor. Ec-max 22. [Online]. Available: <http://www.maxonmotor.com/2988.html>
- [16] Otto Bock. Otto bock energypack 757b20. [Online]. Available: <http://www.ottobock.com>
- [17] D. H. Plettenburg, "A sizzling hand prosthesis. on the design and development of a pneumatically powered hand prosthesis for children," Ph.D. dissertation, Delft University of Technology, The Netherlands, 2002.
- [18] National Instruments. LabVIEW. [Online]. Available: <http://www.ni.com/labview/>
- [19] —. ELVIS II Instrumentation, Design, and Prototyping Platform. [Online]. Available: <http://sine.ni.com/nips/cds/view/p/lang/en/nid/13137>
- [20] *Design response of weighting networks for acoustical measurements*, ANSI S1.42-2001 Std.
- [21] N. Crone, "A comparison of myo-electric and standard prostheses: A case study of a preschool aged congenital amputee," *Canadian Journal of Occupational Therapy*, vol. 53, pp. 217-222, 1986.