

University of Windsor

Scholarship at UWindsor

University of Windsor Faculty of Engineering
Yearbooks

Southwestern Ontario Digital Archive

1994

University of Windsor Faculty of Engineering Yearbook 1993-1994

University of Windsor

Follow this and additional works at: <https://scholar.uwindsor.ca/universitywindsorfacultyengineeringyearbooks>



Part of the [Engineering Commons](#), [Public History Commons](#), and the [Secondary Education Commons](#)

Recommended Citation

University of Windsor, "University of Windsor Faculty of Engineering Yearbook 1993-1994" (1994).
University of Windsor Faculty of Engineering Yearbooks. 13.
<https://scholar.uwindsor.ca/universitywindsorfacultyengineeringyearbooks/13>

This Book is brought to you for free and open access by the Southwestern Ontario Digital Archive at Scholarship at UWindsor. It has been accepted for inclusion in University of Windsor Faculty of Engineering Yearbooks by an authorized administrator of Scholarship at UWindsor. For more information, please contact scholarship@uwindsor.ca.

ENGINEERING

1994



UNIVERSITY OF
WINDSOR

Special Thank's

I would like to give special thanks to; Karol Vudrag, Rod Mabesa, Chris Powell, Louie Saad, George for his modelling, Maricon, John, and Tony, for the cheques, Colene, Tony, Ray, and to all those people who posed for these pictures. I'd also like to thank all of you who paid \$20 in student fees to the Engineering Society to make this book possible (that's everybody!).

I'd like to thank myself, Peter Wilson, on your behalf for compiling this yearbook instead of studying for my exams. Hopefully I'll graduate and not have to come back here and fix-up next year's yearbook.

Outgoing Dean

Dr. G. Monforton served as the Dean of Engineering for the past 4 years. He was the former Head of Civil/Environmental Engineering and will be returning to this department.



The New Dean

It is my pleasure to extend to the graduating class of '94 my best wishes, and those of all the faculty and staff members, for a successful and prosperous future.

Engineers have an important role to play in today's globally competitive economy. Engineers are the originators of most applicable technology. Well educated, qualified and motivated engineers are essential to grasping the opportunities technology provides, while at the same time avoiding the destructive effects that modern technology can have, if not applied expertly and conscientiously.

Canada expects you to apply the knowledge you gained during your education to create wealth, increase competitiveness, and improve the quality of products and services, as well as the quality of life, both nationally and internationally.

I assumed a five year term as the 6th Dean of Engineering at the University of Windsor in July, 1994, as you were on your way to graduation. Although we did not have an opportunity to work together, I look forward to interacting with you in the future. I have many plans to strengthen our ties with industry, enhance undergraduate and graduate programs, offer effective professional and continuing education and develop innovative research and education programs. I encourage you to remain in touch with your alma mater, and welcome your participation in shaping the future of this faculty through your innovative ideas and generous giving of your expertise, time and donations.

I wish you the best as you launch your chosen careers and look forward to hearing from you in the future.

A handwritten signature in black ink, appearing to read 'Hoda A. ElMaraghy'. The signature is fluid and cursive.

Hoda A. ElMaraghy
Dean of Engineering

Associate Dean

It is always a pleasure to reflect on the progress of our engineering students in as much as we have an excellent group of students who most certainly will become the technological and administrative leaders of the future.



While I admit that it is a tough grind to graduate in engineering, your educational development will also prepare you well for a future of learning and adopting yet unknown technology and applying it to a variety of problems which you will be required to resolve. You will find this both emotionally and financially satisfying as you have learned that it is fun to learn and ultimately to use your knowledge in a useful way.

What a great time to be studying and graduating when technology is developing exponentially. The opportunities will be wonderfully exciting and I can only wish for the best for each and every one of our engineering students.

Your network of associates realized while studying here will become an important part of your ultimate success hence I encourage you to nurture these contacts both among your peers as well as the faculty.

My congratulations to all and also to those who took the effort to act as your representatives on various academic and professional committees. I reserve special thanks to the Engineering Society who plan and carry out the events which make life on the campus that much more exciting/memorable.

Cheers

A handwritten signature in black ink that reads "W North".

Dr. W. North

Dr. Van-Minh Huynh



The department of Mechanical Engineering lost one of its most valued professors with the sudden death of Dr. Van-Minh Huynh. He was 49 years old and passed away at work on May 30, 1994. Dr. Huynh is survived by his wife, Dorothy, and his sons, Eric and Nevin.

Perhaps best known to the Mechanical Engineering students for his courses in dynamics, machine dynamics, stress analysis and machine design, Dr. Huynh was also very active in research and in teaching courses on automated inspection and automated machining at the graduate level. His research activities were mostly in the area of vision systems.

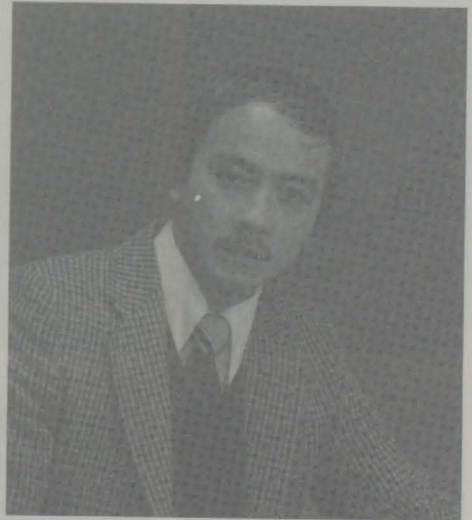

Seven M.A.Sc. students and two Ph.D. students completed their degree requirements under his supervision. Recently, he was supervising four M.A.Sc. students and one Ph.D. student. Dr. Huynh was very active in his research activities having authored or co-authored 15 papers in refereed journals and 15 papers in conferences. Dr. Huynh obtained his B.Eng. degree from McGill University in 1968, and his M.Eng. degree from McMaster University in 1970. After completing his Ph.D. at McMaster University in 1974, he worked briefly at the Institute of Technology, University of Manchester, U.K. After that he worked in industry for White Farm Equipment in Brantford, DOFASCO in Hamilton, and NCR in Waterloo before joining the Department of Mechanical Engineering at the University of Windsor in 1983. He was promoted to Associate Professor in 1986 and to Professor in 1992.



As a valuable contributor to the Department, the Faculty and the University, Dr. Huynh will be sorely missed.

Professors



AHMADI, Majid



ALEXANDER, Philip



BEWTRA, Jatinder



BISWAS, Niharendu



CHEE, Sek P.



CHO



DUTTA, S.P.



GASPAR, Robert



GNYP, Alex



HACKAM, Reuben



HUYNH, V.M.



KWAN



LASKARI, Reza



MACINNIS, Cameron

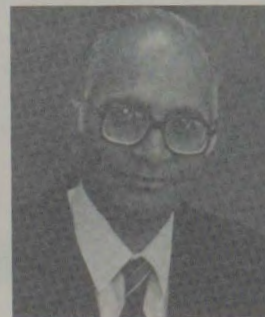

MADAGULA, Murty

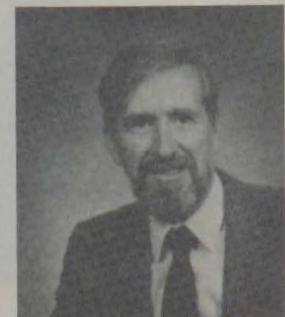

McCORMQUODALE, John



McDONALD, Thomas



MILLER, William

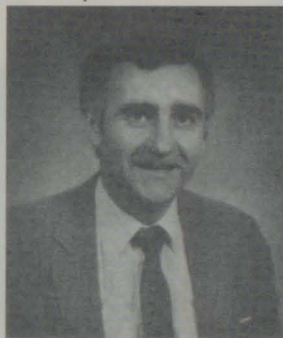

NORTHWOOD, Derek

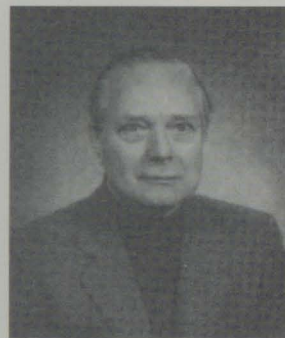

POKLEY, Maurice

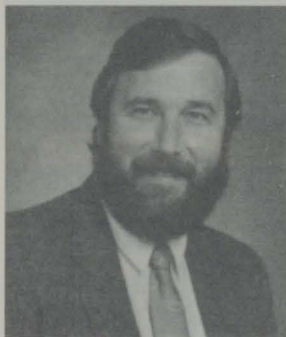

RANKIN, Gary

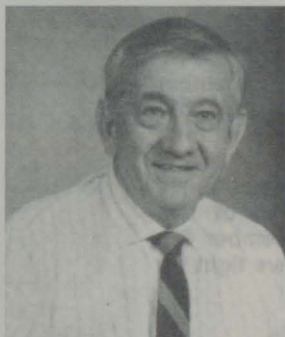

REIF, Zygmunt

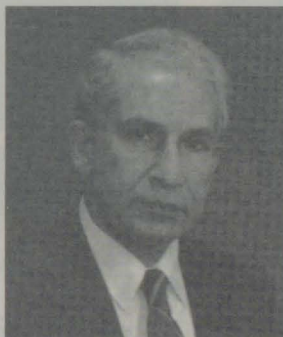

SAYED, Abdel

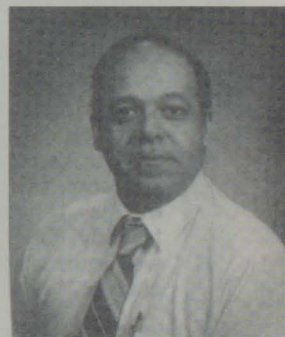

SID-AHMED, Maher

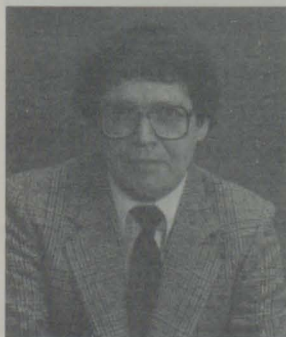

SOLTIS, James

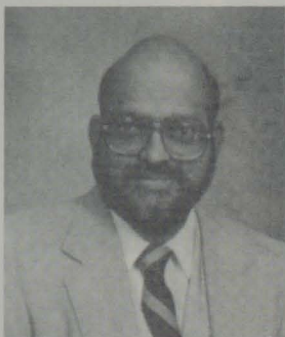

SRIDHAR, Krishnaswamy



STAGER, Robert



TEMPLE, Murray



WATSON, Alan



WATT, Dan



YOUDELIS, William



ZANG, Chow

ABSENT: ABDU, George - ASFOUR, Abdul-Fattah - BUDKOWSKA, Barbara - JULIEN, Graham - KIERKUS, Witold - LABA, Jan - MONTEITH, L (Co-op Coordinator) - ST. PIERRE, Carl



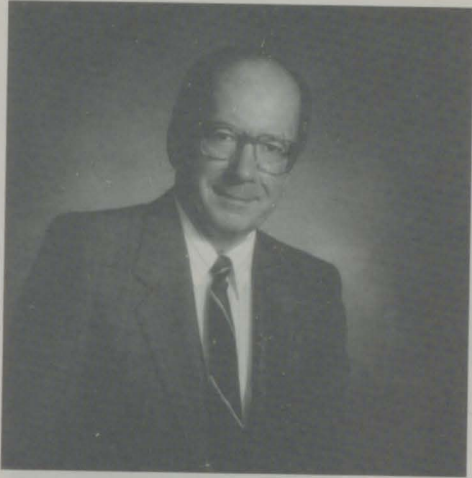

DEPARTMENT HEAD
Dr. M. Temple

Civil & Environmental Engineering

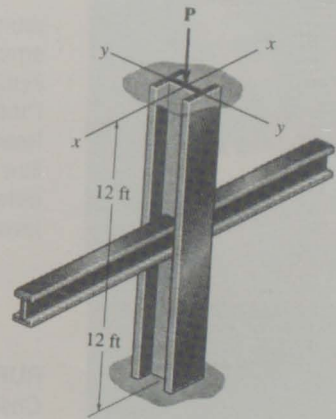

*Reduce
Reuse
Recycle*

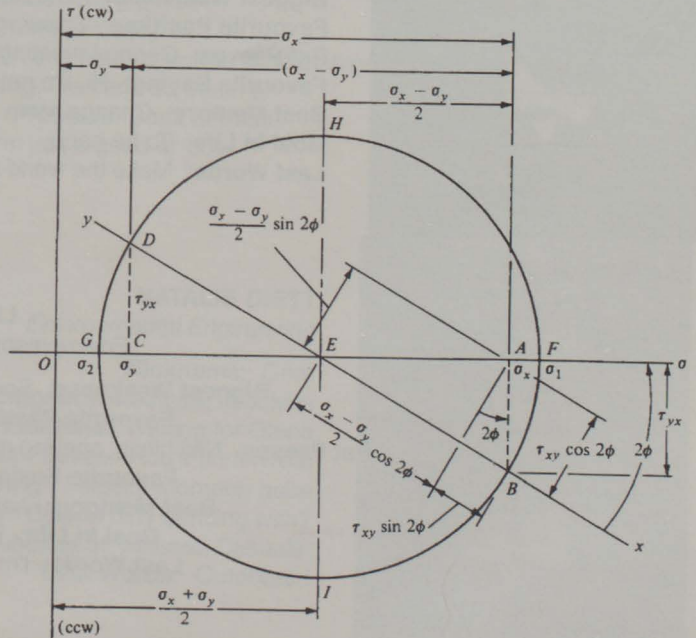

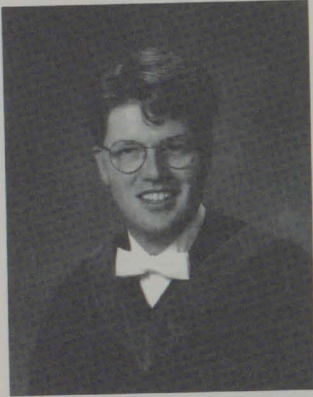

ALLAN BOTHAM

Civil Engineering

Nickname: Big Al

Pet Peeves: Right!

Favourite Saying: I love this class!

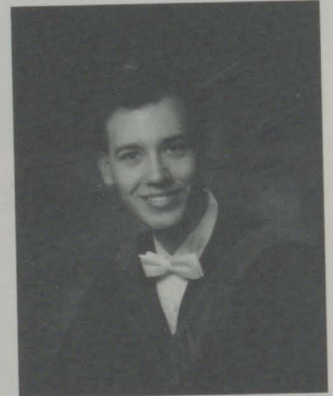

TIM CARDER

Environmental Engineering

Nickname: Timmer

Biggest Weakness: I talk too much!

Favourite Pastime: Louie's sis

Pet Peeves: Organic Chem

Favourite Saying: Fus on it

Best Memory: Sept. 4, 1993

Last Words: Borrow your assignment?

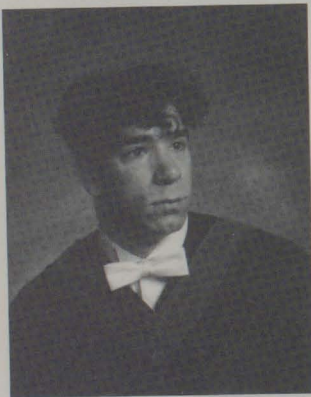

RUPP CARRIVEAU

Civil Engineering

Nickname: Day Friend, Eddie

Biggest Weakness: Flawlessness

Favourite Pastime: Spinning music for friends / Spinning friends for music

Pet Peeves: General meetings / Dennis givin me hell / Kitchen starting fights

Favourite Saying: Hi, I'm not coming to the General Meeting

Best Memory: Change room @ HK, every corn roast, after 3rd year exams

Goal In Life: To be happy

Last Words: Make the world a better place

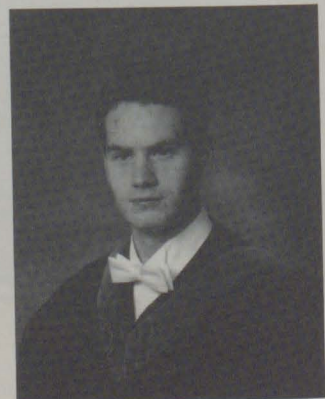

LLOYD CHASE

Environmental Engineering

Biggest Weakness: Southern Comfort

Favourite Pastime: Sleeping

Pet Peeves: Nail biting, spelling my name wrong

Favourite Saying: I reject you

Best Memory: I have no memory!

Goal In Life: Peace on earth

Last Words: I'm outta here . . .

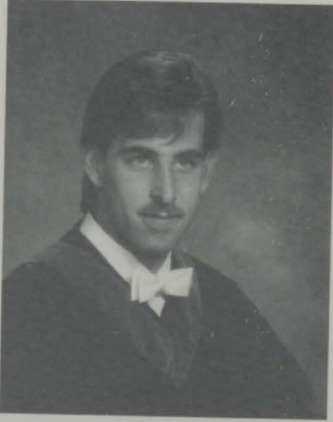

BRAD CULLEN
Civil Engineering

SAMIR DHANVANTARI
Environmental Engineering

Nickname: Psycosmear
Biggest Weakness: My name
Favourite Pasttime: Tennis and Star Trek and Blue Jays
Pet Peeves: Infinite assignments and people who call me "Smear!"
Favourite Saying: I don't know, I don't care!
Best Memory: Charging J. Deimer into a wall
Goal In Life: To retire
Last Words: Live long and prosper and Go Jays!

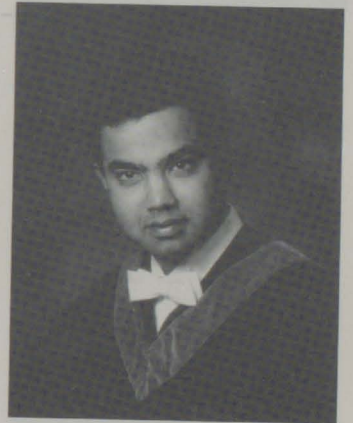

JEFF DIEMER
Environmental Engineering

Nickname: Jeffrey "Dahmer" Diemer
Biggest Weakness: I'm too nice
Favourite Pasttime: Hockey
Pet Peeves: Girl engineering entree scholarships
Favourite Saying: Ya can't do that!
Best Memory: Probie vs. Domi at Faces
Last Words: I'm just a good ol' boy



NATALIE DIETT
Environmental Engineering

Nickname: Gnat
Biggest Weakness: Cookies
Favourite Pasttime: Waiting for Glenn
Pet Peeves: Rod's underwear
Favourite Saying: Folger's moment; babe
Best Memory: Colene dirty dancing with?
Goal In Life: Major shareholder of "Mabesa Casuals"
Last Words: Outahere !



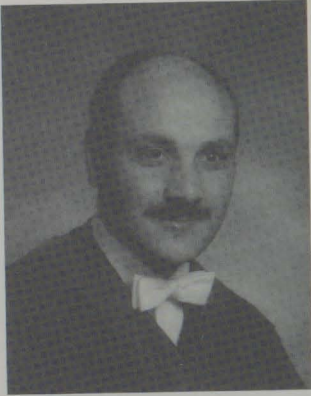

HICHAM H. EL-HAGE
Civil Engineering



SUSAN FASSBIND
Civil Engineering

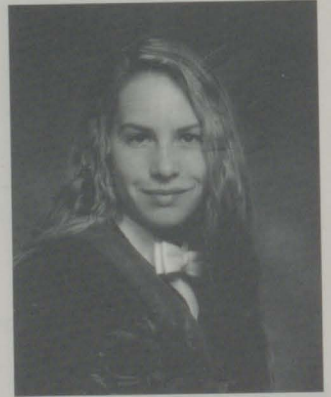

DAWN FLOTTEN
Environmental Engineering

Biggest Weakness: Chocolate

Favourite Pastime: Gossip

Pet Peeves: White pants before May 24 and after Labour Day

Favourite Saying: Blue set of notes / Yellow set of notes

Best Memory: Happy walking into class

Goal In Life: To be happy



VINCE FRANCESCUTTI
Civil Engineering

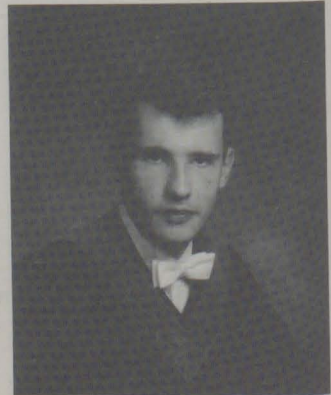



MICHELLE FRENETTE

Environmental Engineering

Biggest Weakness: Blondes

Pet Peeves: Fashion faux-pas

Favourite Saying: 21% oxygen, 79% nitrogen

Best Memory: Society general meeting(s)

Goal In Life: To get a job I love

Last Words: Opps

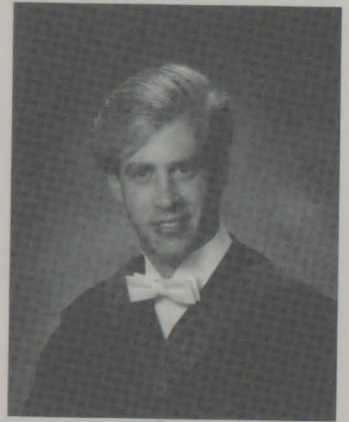

TIM GLOS

Civil Engineering



JILL GRANT

Environmental Engineering

Nickname: Swill / Schmill

Biggest Weakness: General meetings

Favourite Pasttime: Beating up Tim

Pet Peeves: Two-faced people

Favourite Saying: Howdy!

Best Memory: Corn roast in 3rd year

Goal In Life: To always be myself

Last Words: I'm coming back for my masters - jee haw!



JAMIE HAYWARD

Environmental Engineering

Biggest Weakness: Valley of the Dolls

Favourite Pasttime: Drinkin beer and watching hockey

Pet Peeves: Engineering entry scholarships for girls

Favourite Saying: Why do now what you can put off until tommorrow

Best Memory: Probie vs. Domi at Faces

Goal In Life: Seasons tickets to J.L.A.

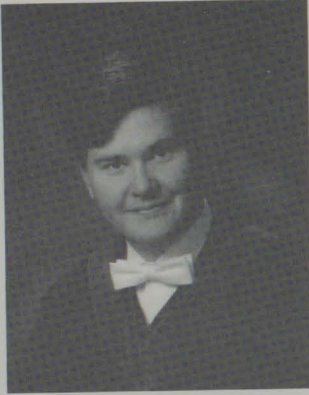

GRANT HILBERS

Environmental Engineering

- Biggest Weakness:** General meetings
Favourite Pasttime: General meetings
Pet Peeves: 8:30 classes
Favourite Saying: Be there or be Samir
Best Memory: Colene's cheeky wit
Goal In Life: Own the world
Last Words: Bye, bye

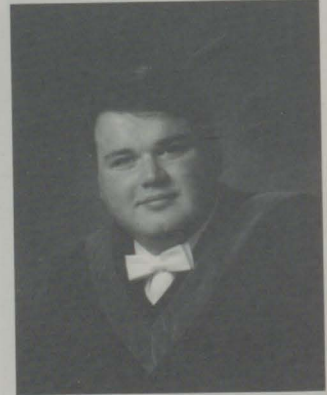

S. JAHNS

Civil Engineering

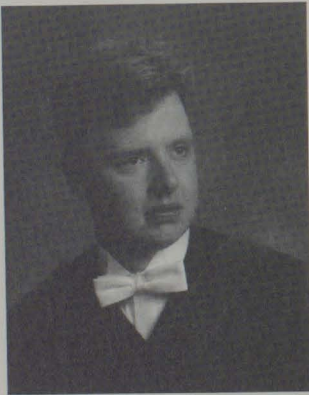

IAN JOHNSTON

Environmental Engineering

DAVID B. KANTERS

Civil Engineering

- Nickname:** AJAX
Biggest Weakness: Prairie Fire
Favourite Pasttime: Pool
Pet Peeves: Lippers!
Favourite Saying: Hey Pencilneck!
Best Memory: Corn Roast 1991 - Like the bus ride
Goal In Life: Construction worker
Last Words: See ya later, Flamer!

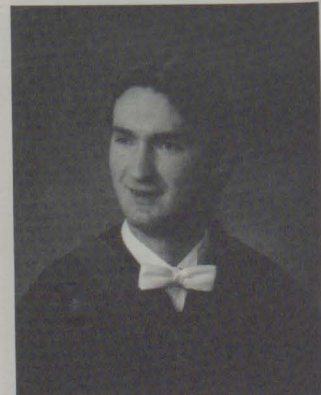



ALAN KITCHEN

Environmental Engineering

Nickname: "Itchin Bitchin" Al Kitchen

Biggest Weakness: Keeping dry

Favourite Pasttime: Bugging Samir

Pet Peeves: Wearing beer

Favourite Saying: Copy now, learn later / Learn it on the exam

Best Memory: Fighting the Rangers at Coddli's

Goal In Life: Equality with women

Last Words: If they want to fail you, they will find a way!

JOE KLYM

Civil Engineering

Biggest Weakness: Blondes

Favourite Pasttime: Fishing

Pet Peeves: SAB

Favourite Saying: Cool!

Best Memory: Not school

Goal In Life: Becoming a pro at whatever

Last Words: See ya!

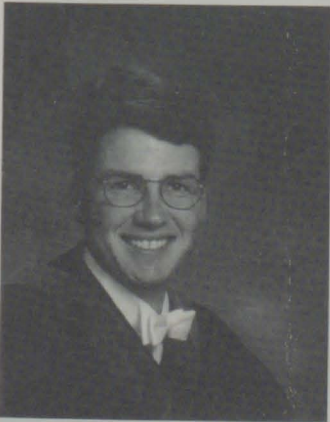
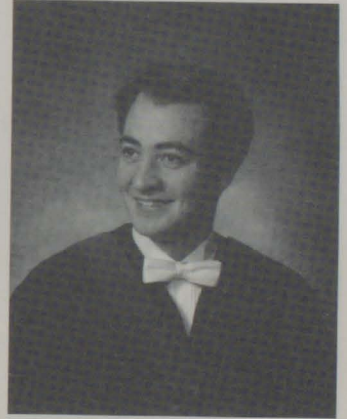

AARON LAW

Environmental Engineering

Biggest Weakness: Turning red

Favourite Pasttime: Avoiding work

Pet Peeves: Blue Jays

Best Memory: Having none

Goal In Life: To retire

LUIGI LECCE

Civil Engineering

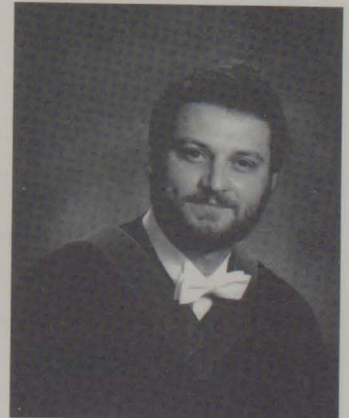



REBECCA MAURE

Environmental Engineering

Nickname: Bekster, Becca

Biggest Weakness: Black Tower

Favourite Pasttime: Punching Rod

Pet Peeves: Users

Favourite Saying: Which way do I go?

Best Memory: Poo Island

Goal In Life: To find one

Last Words: Why?

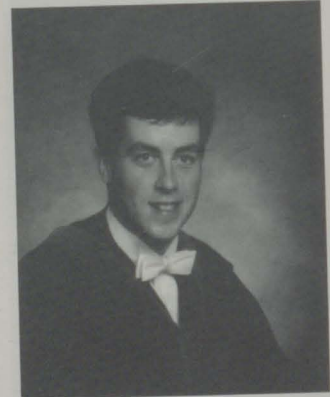

MARK McCLOSKEY

Civil Engineering

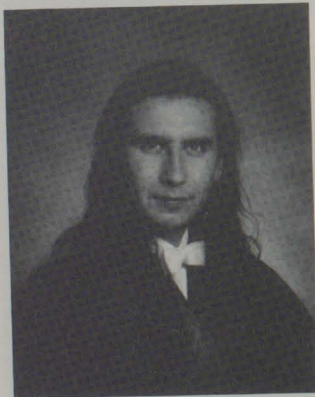

ROB OLIVIER

Civil Engineering

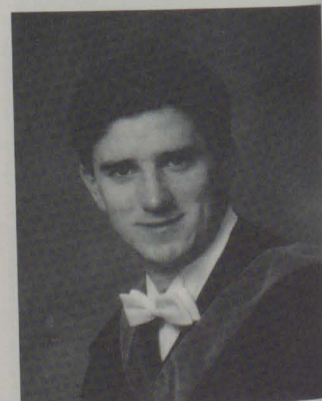

MICHAEL O'MEARA

Environmental Engineering

Nickname: Gameboy

Biggest Weakness: Hockey playoffs / Exams

Favourite Pasttime: Beating Mechanicals at Ball Hockey! Oh Yeah!

Pet Peeves: Islands

Favourite Saying: Oh Yeah!; Learn it on the exam

Best Memory: Probie vs Domi at Faces

Goal In Life: Season tickets at M.L.G.

Last Words: Environmental/Civil 4 games - Mechanicals 2 games in ball hockey



COLENE PINDERA

Environmental Engineering

Nickname: Sinead or Co

Biggest Weakness: "A Curve in the Road"

Favourite Pasttime: "Play" time and punishment

Pet Peeves: Anal people

Favourite Saying: Eat my ass

Best Memory: Algonquin

Goal In Life: To strip for Madonna

Last Words: I want to get off this planet!

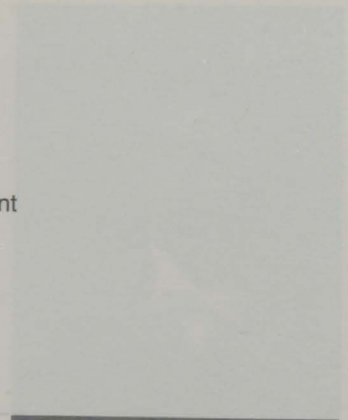

TIFFANY POCOCK

Civil Engineering



DAVID M. RACZ

Environmental Engineering

Nickname: Elvis, The Pit, Hollow Legs, Human Garbage Disposal

Biggest Weakness: Tequila

Favourite Pasttime: Sleeping, eating

Pet Peeves: Calculas, Dynamics, Bird Courses, Ozone

Favourite Saying: Kiss my ass! All of it!

Best Memory: General meetings

Goal In Life: To save the world

Last Words: Are we there yet?

GARETT RICHARDS

Environmental Engineering

Biggest Weakness: Speling

Favourite Pasttime: Fishing

Pet Peeves: People who talk

Favourite Saying: Suck, suck blow is just an expression

Best Memory: Graduating

Goal In Life: Not to come back to school

Last Words: Bye-bye

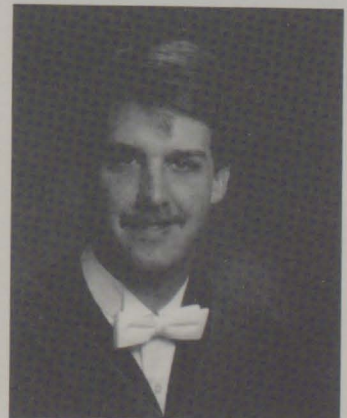

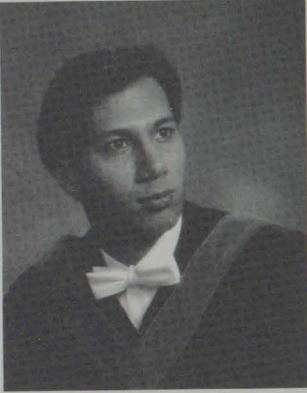

BOB SADRA

Environmental Engineering

- Favourite Pasttime:** Taking trips
Pet Peeves: Loud people
Best Memory: My first trip
Goal In Life: Global domination
Last Words: The spice must flow

DENNIS SCHINCARIOL

Civil Engineering

- Nickname:** Chickencariol (Thanks Stubby)
Biggest Weakness: Molson Canadian and the Canadians
Favourite Pasttime: Watching Riki Lake at Rupp's house
Pet Peeves: Strain gauges, people who don't know how to use straws
Favourite Saying: Habs in 4
Best Memory: D. Medved sleeping in the rushes in the quad
Goal In Life: To break 40 at Beach Grove
Last Words: Civils/Environmentals 3 - Mechanicals 2

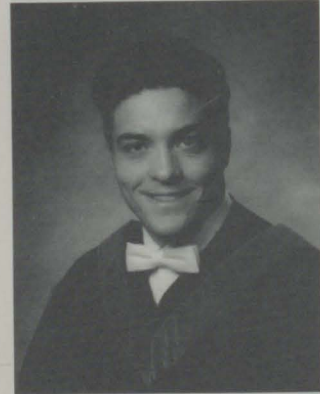

SAM SLEIMAN

Civil Engineering

- Nickname:** The Sleeper
Biggest Weakness: Highlighters
Pet Peeves: Teachers who wake me up during class
Favourite Saying: Is the final exam cumulative?
Best Memory: My calendar of many colours



GREG ST. LOUIS

Civil Engineering

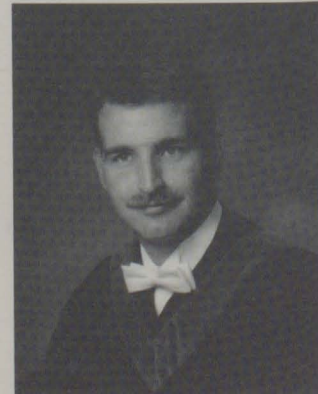



PAUL TERON
Civil Engineering

Nickname: The Russian Bear
Biggest Weakness: Finding one
Favourite Pasttime: Stair racing, sleeping
Pet Peeves: Closed book tests, sticky arms
Favourite Saying: Don't talk to me!
Best Memory: Carriveau's pants on Wyandotte
Goal In Life: To be a guest on Riki Lake
Last Words: Don't do this



E. WOYCHUK
Environmental Engineering

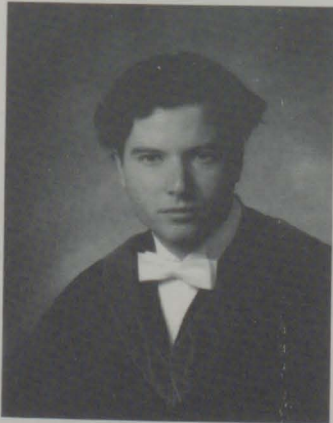

MICHAEL ZIMMER
Civil Engineering

Nickname: Lush; Just kidding mom!
Biggest Weakness: Buzz's Bar & Grill
Favourite Pasttime: Clubbing baby seals
Pet Peeves: Computer Centre
Favourite Saying: What, last call already!
Best Memory: Everything!
Goal In Life: Win lottery
Last Words: Would you like fries with your order!

Electrical Engineering

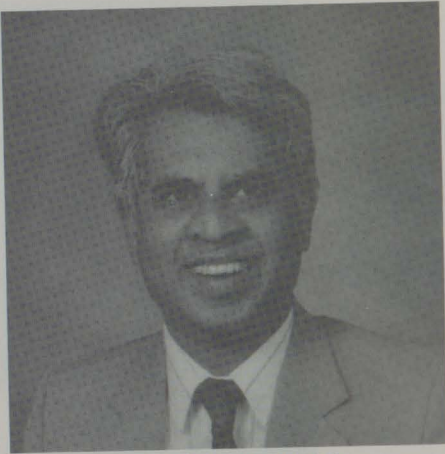

DEPARTMENT HEAD
Dr. G. Raju

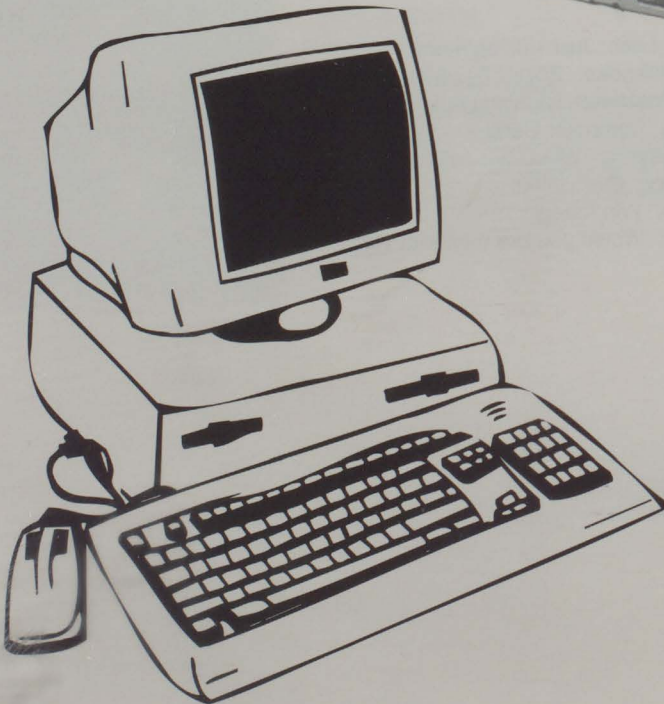
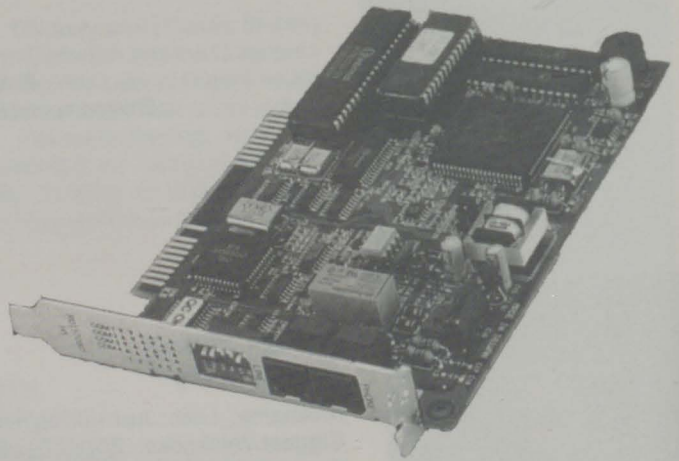

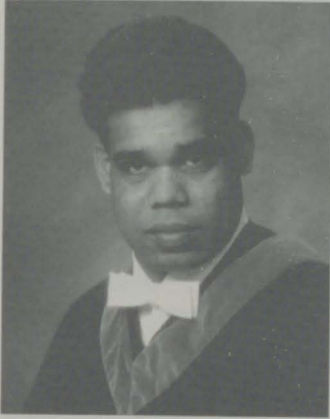

P. ARUMAGAM
Electrical Engineering

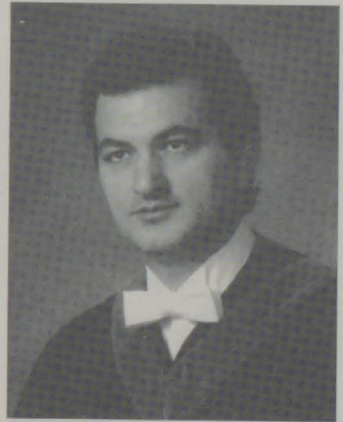

S. BEIRAGHA
Electrical Engineering

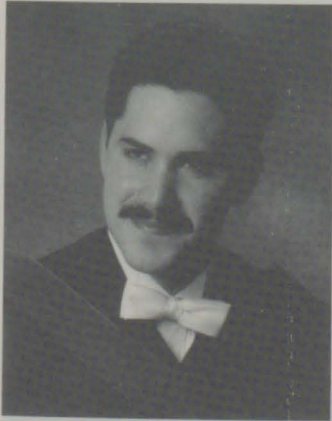

GENO DURONIO
Electrical Engineering

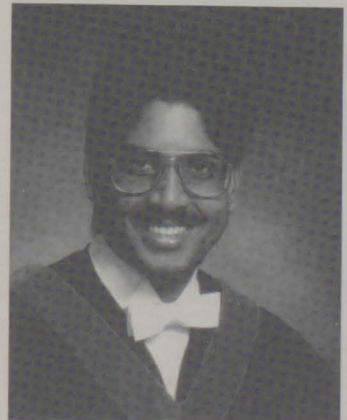

EHAMPARAM
Electrical Engineering

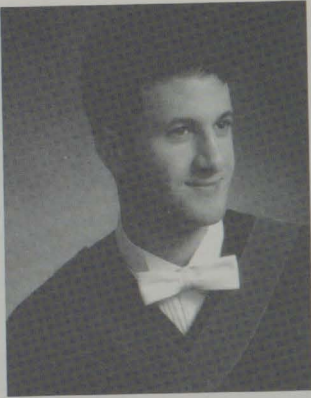

D. FARAH
Electrical Engineering

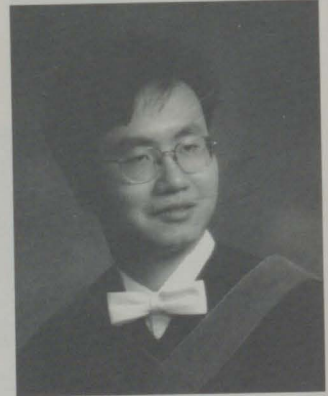

ANDREW LAI
Electrical Engineering

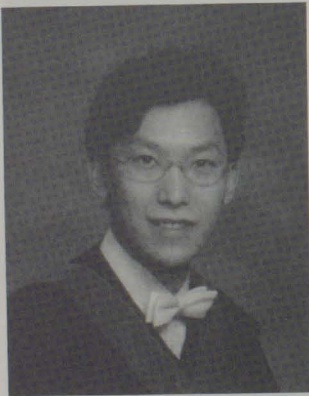

S. LONG
Electrical Engineering

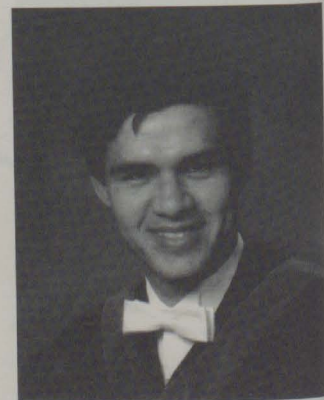

SABASTIEN MAGIEROWSKI
Electrical Engineering

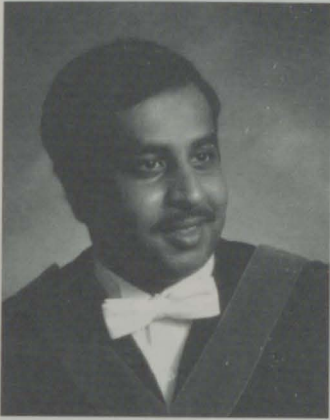

S. MANOHARAN
Electrical Engineering



SENTHOORSELUAM NAVHRATRAN
Electrical Engineering

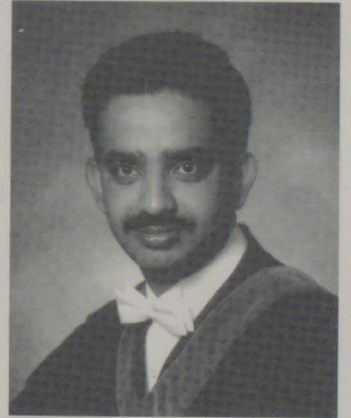

T. SARAVANAMUTHIR
Electrical Engineering

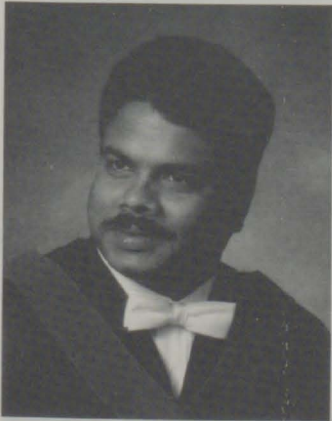

WAYNE SASS
Electrical Engineering

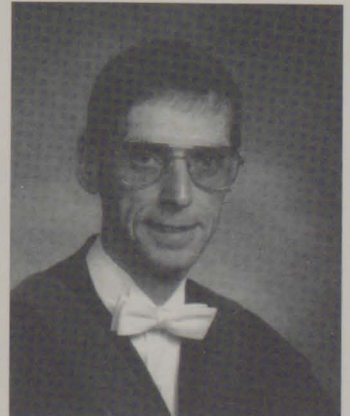

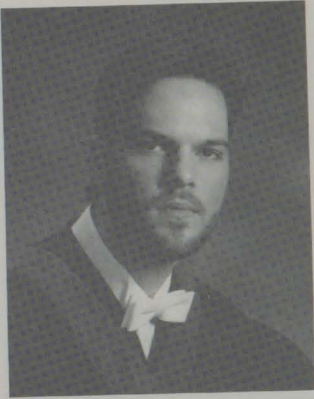

MIKE SINASAC
Electrical Engineering

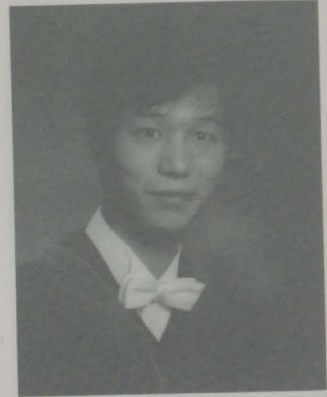

C. SO
Electrical Engineering

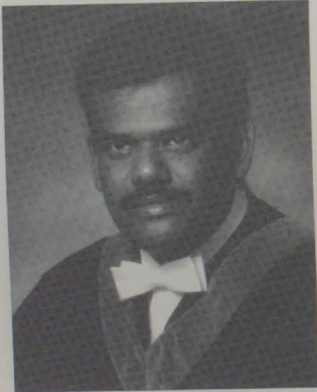

K. THEVAKANTHAN
Electrical Engineering



TEDDY TSANG
Electrical Engineering

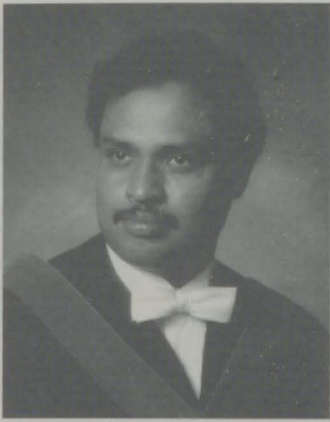

VELAUTHAM VASANTHAN
Electrical Engineering

Industrial Engineering

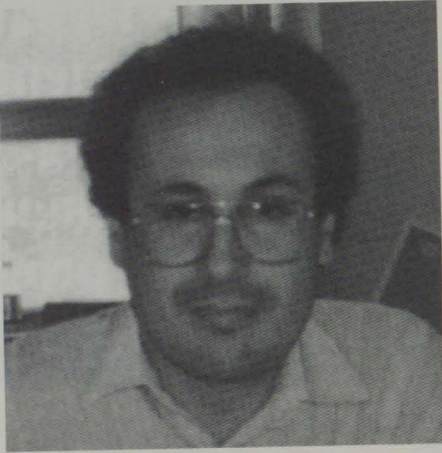

DEPARTMENT HEAD
Dr. Taboun

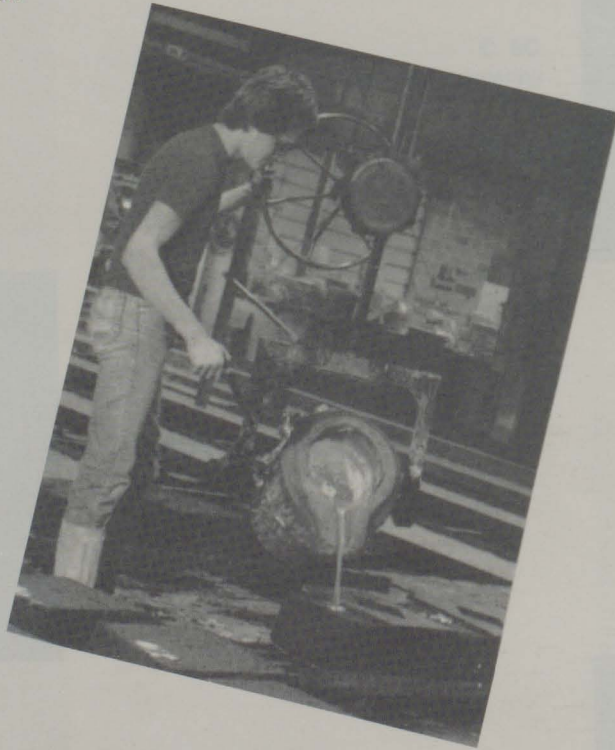

Standard Deviation

$$S = \sqrt{\frac{\sum (x - \bar{x})^2}{n-1}}$$

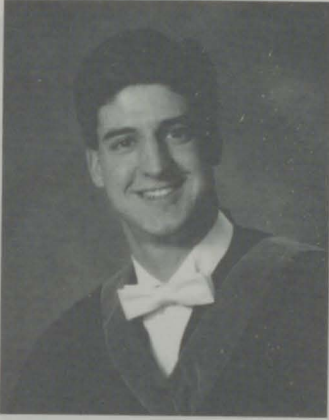

BRIAN BREAULT
Industrial Engineering

SHU SHYAN CHEN
Industrial Engineering

Nickname: Shoe
Favourite Pasttime: Looking for people to talk to
Pet Peeves: The large 4th year. ie. Class size
Favourite Saying: I don't want to do this!
Best Memory: Dave-Magnets World Tour '94 and Guelph!
Goal In Life: To finish what I start
Last Words: It's not what you think it is,
but by the time you find out it's too late



KHALED NASSEREDDINE
Industrial Engineering

Nickname: Loadi
Biggest Weakness: Def Bods
Favourite Pasttime: Soccer
Pet Peeves: Ignorance
Favourite Saying: Nothing is impossible
Best Memory: Meeting Tamina
Goal In Life: Build a castle
Last Words: I would like to get back at some profs.

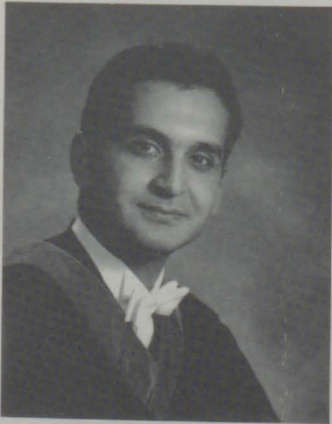

ANDREW SPICER
Industrial Engineering

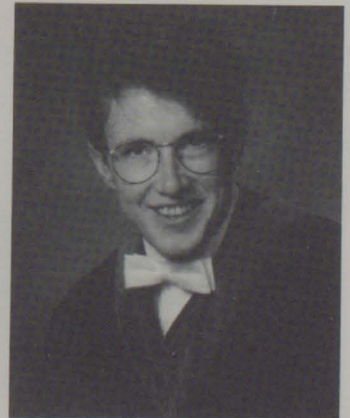

Mechanical & Materials Engineering

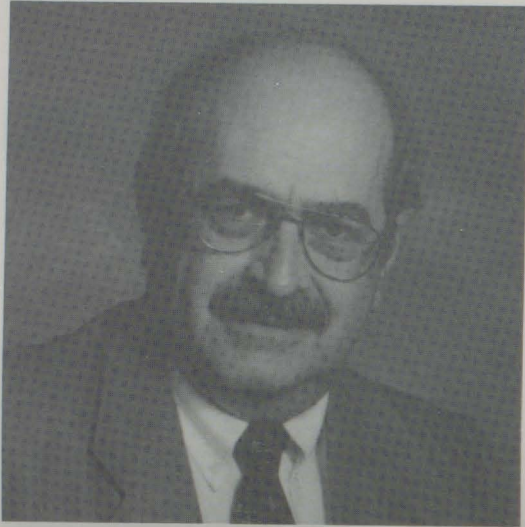

DEPARTMENT HEAD
Dr. N. Wilson

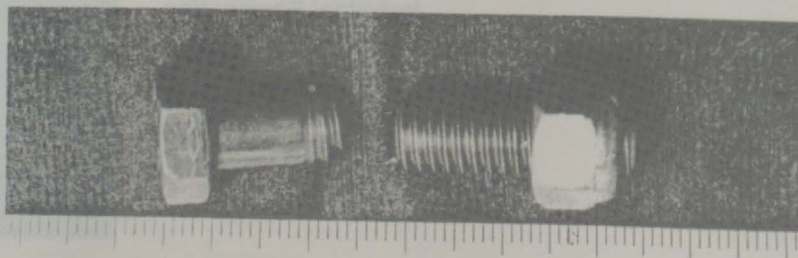
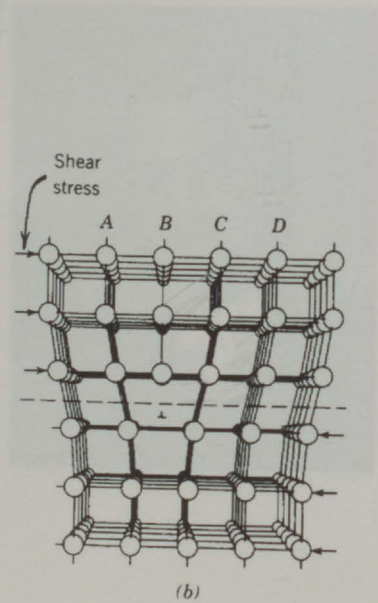
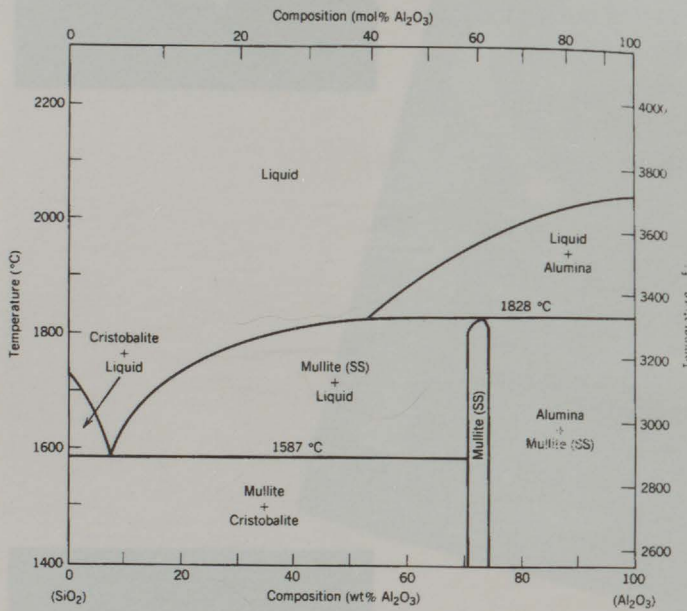
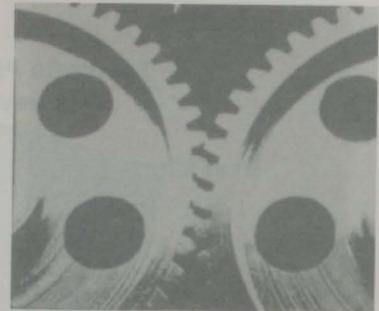



ERIC BAUMGARTNER

Mechanical Engineering

Nickname: Only your girlfriend knows
Biggest Weakness: Studying too much
Favourite Pasttime: Doing extra homework
Favourite Saying: Smokin the pipe
Best Memory: I have only bad memories
Goal In Life: Poverty
Last Words: Go silly

MARCO BELLO

Mechanical Engineering

Nickname: Macro
Biggest Weakness: T & A
Favourite Pasttime: Sports
Pet Peeves: People in front row
Favourite Saying: Euhh!
Best Memory: Helmet boy - Ohio
Goal In Life: Ski the world
Last Words: Next!

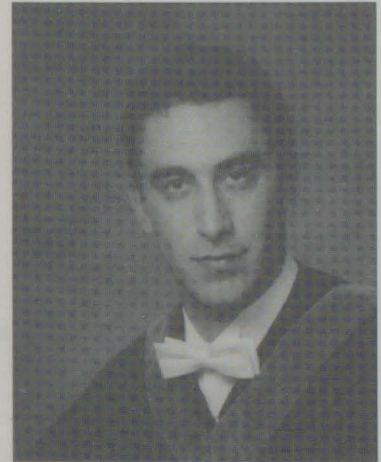

ROGER BORTOLIN

Mechanical Engineering

Nickname: Rohair
Biggest Weakness: Always late for car pool
Favourite Pasttime: Being a slacker
Pet Peeves: Parking
Favourite Saying: Hey slacker!
Best Memory: K.F. cutting up the OLD MAN
Goal In Life: House, car, yacht, etc.
Last Words: I'm outta here!



GLENN BYCZYNSKI

Materials Engineering

Nickname: Gleenard
Biggest Weakness: Special Old
Favourite Pasttime: Nat
Pet Peeves: Getting tickets
Favourite Saying: KAAW! (Cry of the vulture)
Best Memory: Mustang
Goal In Life: Restore the Maverick
Last Words: I wish I was a Mechanical

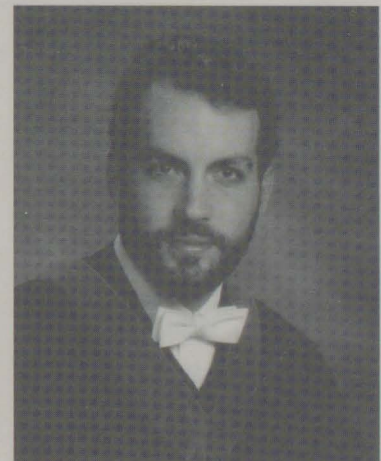



MONICA CHIFOR

Materials Engineering

Nickname: W of U; - "Harmonica"

Biggest Weakness: Tennis

Favourite Pasttime: Beating Rod in tennis

Pet Peeves: Rod beating me

Favourite Saying: It's not fair!

Best Memory: ???New York???

Goal In Life: To drive a Porche

Last Words: Think positively

JAY EDWARDS

Materials Engineering

Nickname: (Dic)tionary

Biggest Weakness: Beer, Rye, Rum

Favourite Pasttime: Pool

Pet Peeves: Thermodynamics

Favourite Saying: What do you want now!

Best Memory: The Night I can't remember

Goal In Life: To get a job and make lots of money

Last Words: Can I have a life now

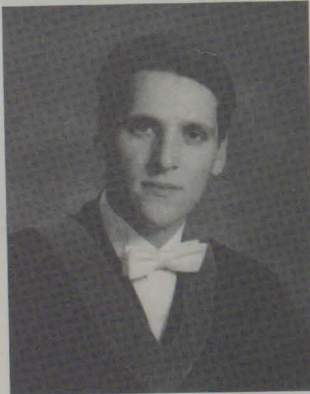
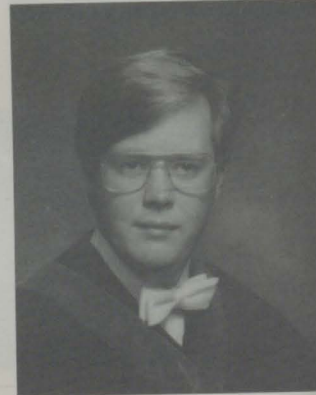

ABEL ELIAS

Mechanical Engineering

Nickname: EEEEEEEEEEE!

Biggest Weakness: Jack Daniels

Favourite Pasttime: Fishing, drinking at Ray's

Pet Peeves: Leather heads (milk man)

Favourite Saying: Pure power

Best Memory: Smokin the pipe

Goal In Life: Welfare

Last Words: Game Over

ERNEST J. EMMANUEL

Mechanical Engineering

Nickname: Babu

Biggest Weakness: Chemistry

Pet Peeves: Pull over by a cop for speeding

Favourite Saying: Oh my God!

Best Memory: 1st year Engineering night

Goal In Life: Own a company

Last Words: Enjoy the school term

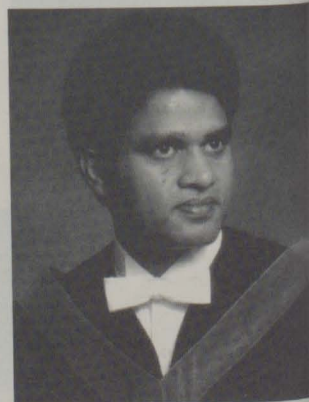



FROG

Mechanical Engineering

Nickname: Chris Franklin
Biggest Weakness: Tall Blondes
Favourite Pasttime: Sports
Pet Peeves: Guys in th front row
Favourite Saying: Sha Right!
Best Memory: Dr. S. Ziller, Zeller & Zoller
Goal In Life: To be CEO of Team Zerox
Last Words: Is it noon already?



KEN FUNG

Mechanical Engineering

Nickname: KFunc1
Biggest Weakness: When the HP48SX doesn't work
Favourite Pasttime: Cycling
Pet Peeves: Pulled over by a cop for speeding
Favourite Saying: I can't get it!
Best Memory: Pub nights!
Goal In Life: To have the most toys!
Last Words: Life's short, play hard!

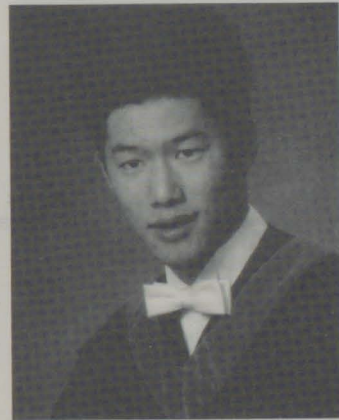

BRAD GAUDETTE

Materials Engineering

Nickname: Vulture
Biggest Weakness: Special Old
Favourite Pasttime: Kitchen raiding
Pet Peeves: Alpas
Favourite Saying: KAAW! (Cry of the vulture)
Best Memory: Blue Mountain
Goal In Life: Go West
Last Words: Scan this

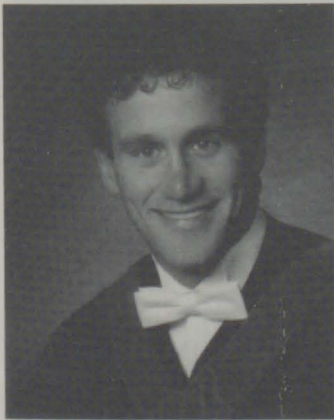

KYLE GREGOIRE

Mechanical Engineering

Nickname: Ky-bosh
Biggest Weakness: Snooze button, Kelly
Favourite Pasttime: Golfing "between" classes
Pet Peeves: Heiner
Favourite Saying: Who's got the assignment done? Skipper!
Best Memory: Should've been Algonquin
Goal In Life: To see Mabesa Casuals on NYSE
Last Words: Did you buy a shirt?

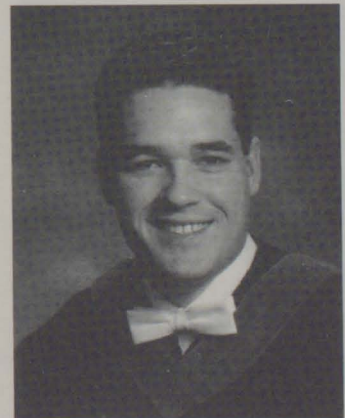



SCOTT GRIFFIN

Mechanical Engineering

Nickname: Brad Randall

Favourite Pasttime: Re-taking classes

Pet Peeves: Associate Deans

Favourite Saying: "Please excuse me, I think I'm going to pass out"

Best Memory: Helmet boy in Ohio

Goal In Life: To graduate

Last Words: Only one more year

PHIL HEIL

Mechanical Engineering

Nickname: Sped

Biggest Weakness: Erica

Favourite Pasttime: Not coming to class!

Pet Peeves: Playing in the band the night before finals

Favourite Saying: Joe, pull your pants up!

Best Memory: All the Corn Roasts

Goal In Life: To truly enjoy baldness!

Last Words: I need a job!

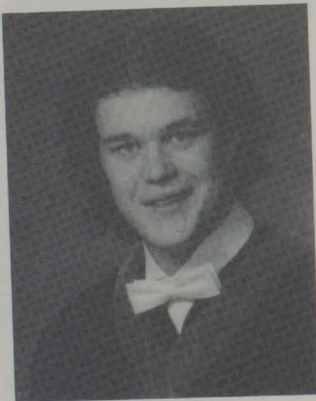
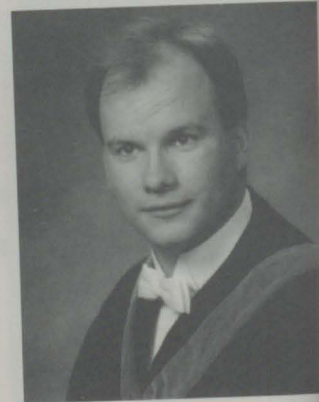

ALF HUNTER

Mechanical Engineering

Nickname: Whatever your mom wants to call me

Biggest Weakness: Abel's mom

Favourite Pasttime: Feeding the horse

Pet Peeves: Gimps who think they know!

Favourite Saying: Do a little dance, make a little love, get down tonight

Best Memory: Bicycle Mayhem

Goal In Life: I have none

Last Words: Bye

JANE INNERD

Materials Engineering

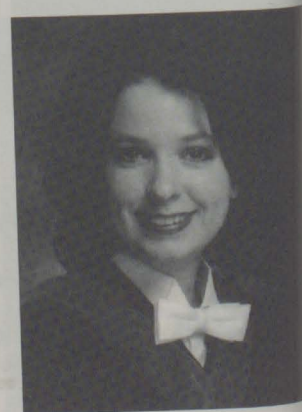

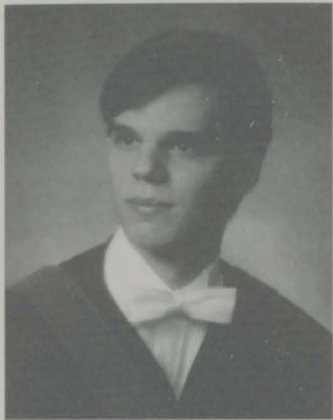

MIKE KOSHULAP
Materials Engineering

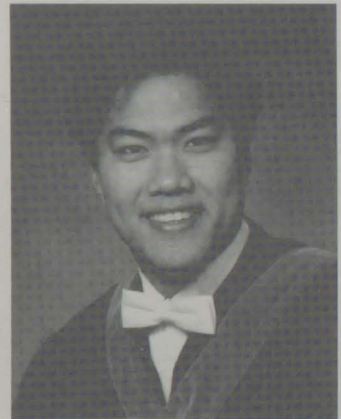

ROD MABESA
Mechanical Engineering

Nickname: Rodney
Biggest Weakness: "OUZO"
Favourite Pasttime: Selling "Mabesa Casual" t-shirts
Pet Peeves: People not giving me their assignment
Favourite Saying: Ooooookay
Best Memory: Losing mine @ 50¢ draft night
Goal In Life: To be a Xerox machine
Last Words: Who's got the assignment

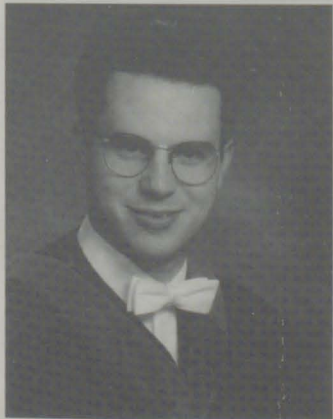

MARK MACDONALD
Mechanical Engineering

Nickname: Marcus
Biggest Weakness: Driving too fast
Favourite Pasttime: Speeding in exotic cars
Pet Peeves: Shitty drivers who get in the way
Favourite Saying: I've lost the will!
Best Memory: Breaking 200 in the Ferrari!
Goal In Life: To have a good time and make money
Last Words: It was a great four years - Enjoy the rest of your life!

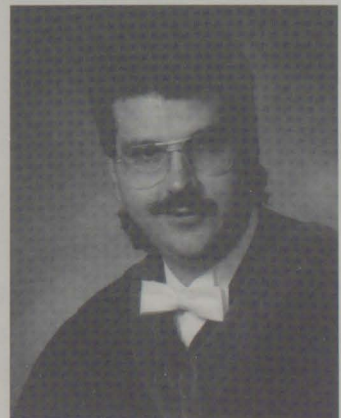

DAVID A. McKENZIE
Mechanical Engineering

Nickname: Angus
Biggest Weakness: Carrying "the bag"
Favourite Pasttime: Feeding "the bag"
Pet Peeves: 1) Peever with Pet
2) Petting and necking with no peeving
Favourite Saying: lim B.A.Sc. = B.F.A.
GPA -> 0
Best Memory: Can't remember (old age)
Goal In Life: Fast cars, faster computers, fastest women
Last Words: I'll take the Geritol with a beer chaser

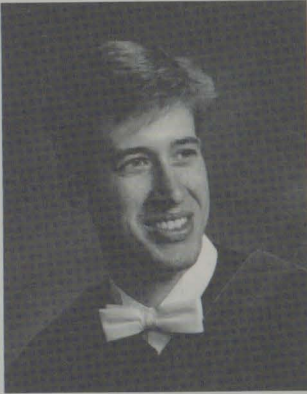

KEN MICHIE

Materials Engineering

Nickname: Chef

Biggest Weakness: Outside curve balls

Favourite Pasttime: Working on Kierkus's Fortran

Pet Peeves: Requirements for B.A.Sc.

Favourite Saying: Blank

Best Memory: Workterms '93, Ottawa '94

Goal In Life: To be head chef at Petratang

Last Words: You can take this fortran & this project and shove it up your . . .

MARGARET ANN MONTGOMERY

Materials Engineering

Nickname: Mugzie

Biggest Weakness: Any food, motorcycles and kayaks

Favourite Pasttime: Telling Dr. Gaspar what I did on my summer vacation

Pet Peeves: People with B.A.'s

Favourite Saying: Can ya handle it?

Best Memory: AGM Ottawa '94

Goal In Life: The sky is the limit, then the universe.

Last Words: May God bless the BASTARDS that come after us!



PETER NAJEM

Mechanical Engineering

Nickname: Lotto

Biggest Weakness: Procrastination

Favourite Pasttime: Slap-n-it

Pet Peeves: Vortex diode upside down

Best Memory: Ottawa and Ohio

Goal In Life: To win the "Lotto 649"

Last Words: I'm out of here!

JOHN PETRYCIA

Mechanical Engineering

Nickname: Hump

Biggest Weakness: Women

Favourite Pasttime: Rebuilding my '69 Vette

Pet Peeves: People with '69 Stangs

Favourite Saying: Fuss on it

Best Memory: Stealing a 40lb. flower pot in Ottawa

Goal In Life: Own the world

Last Words: Good luck everyone

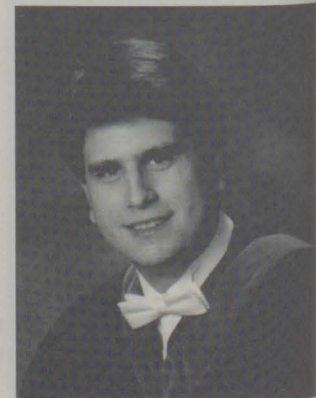



HEINER PHILIPP

Mechanical Engineering

Biggest Weakness: Women

Favourite Pasttime: Women, drink

Pet Peeves: Briefcase

Favourite Saying: F_ck it, it's not due till friday

Best Memory: Driving away from Windsor

Goal In Life: Travel world, get rich

Last Words: Never coming back

ANTHONY PICCHIONI

Mechanical Engineering

Nickname: Iron Man

Biggest Weakness: None (Indestructable)

Favourite Pasttime: Doing homework

Pet Peeves: Dog

Best Memory: Remembering the last thing I did

Last Words: Remember the name

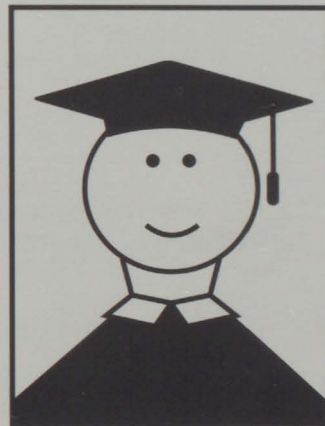

CHRIS POWELL

Mechanical Engineering

Nickname: AKA "Outgoing" president, Sensae (Mario Kart), Crispy

Biggest Weakness: Classes before 3 pm, blondes, brunettes

Favourite Pasttime: Watching cartoons, cruising in the Vette

Pet Peeves: The "Cool" people

F.F. + the Old Man - "Sure we'll all stay an extra half hour

Favourite Saying: I hate this damn course, "Right On!"

Best Memory: Ottawa '94, Talladega/Daytona '93, Enio in Thermal Systems

Goal In Life: Be rich and happy and to find a girl who likes the Stooges

Last Words: You never miss something until it is gone

JOHN PRODAN

Mechanical Engineering

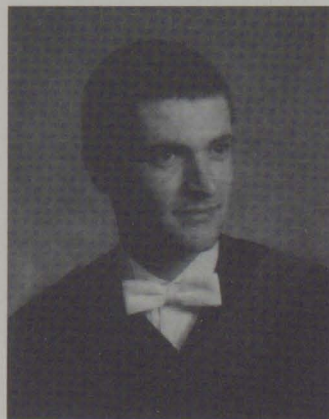

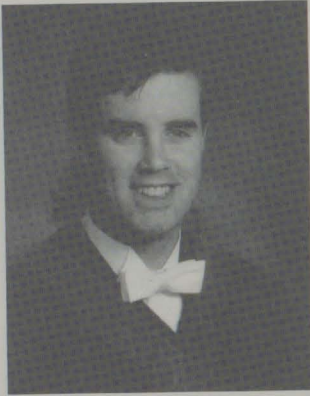

BRAD RANDALL
Mechanical Engineering

Nickname: Scott Griffin
Biggest Weakness: Attending class (or waking up in the morning)
Favourite Pasttime: Carrying the "Wheel"
Pet Peeves: Guy's in the front row
Favourite Saying: Who's got that assignment
Best Memory: Oh, the memories!
Goal In Life: Own a bar
Last Words: Your always welcome in DOVER!!

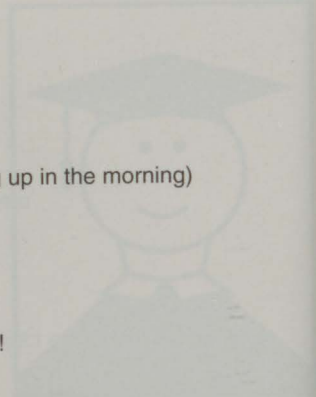

TOM RECCHIA
Mechanical Engineering

Nickname: Yves
Biggest Weakness: I don't have one
Favourite Pasttime: Destroying the Environmentals in ball hockey
Pet Peeves: The Environmental team thinking that they are better than us
Favourite Saying: Hey fruitcake
Best Memory: I can't remember
Goal In Life: Get a job where I can copy and get credit for it
Last Words: You'll never win O'Meara

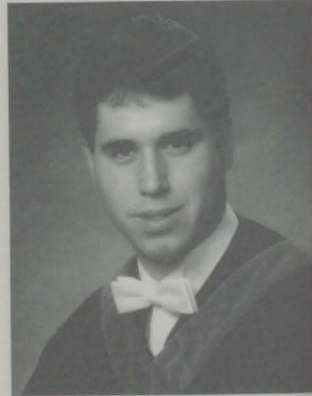

ALFRED RICCI
Mechanical Engineering

Nickname: Moose, Roach, Buddah
Biggest Weakness: Keeping the Gumption
Favourite Pasttime: Tooting in the County
Pet Peeves: Feminists, anal retentive old men
Favourite Saying: I lost the will
Best Memory: Each and every Pub night and Corn Roast
Goal In Life: To make money and be happy
Last Words: It was worth four years of hell

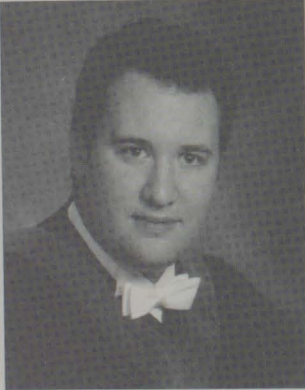

BOB RICHARD
Materials Engineering

Nickname: Barnacle Bob
Biggest Weakness: Cherries
Favourite Pasttime: Veggin with Bic
Pet Peeves: Tiggy Wiggy
Favourite Saying: Hey is anything due today?
Best Memory: Studying on a damn summer saturday
Goal In Life: Prevent son from being engineer
Last Words: Go for it, she was good to me!

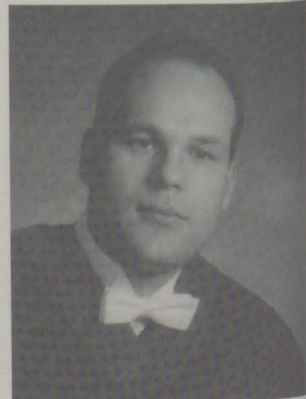



GASPARE RUBINO
Mechanical Engineering

LOUIE SAAD
Mechanical Engineering

Nickname: Eli Zuber
Biggest Weakness: Black nylons
Favourite Pasttime: Yelling Zuber with Phil; Ottawa
Pet Peeves: Exhaust parts delivered to Joe's inlaws, and UPS
Person who stole my bike - All three of them
Favourite Saying: You got me, Boss!
Best Memory: Collingwood, running Tim and Al off the track & walking home
Goal In Life: Get wealthy and share it
Last Words: I do!! (Just kidding)

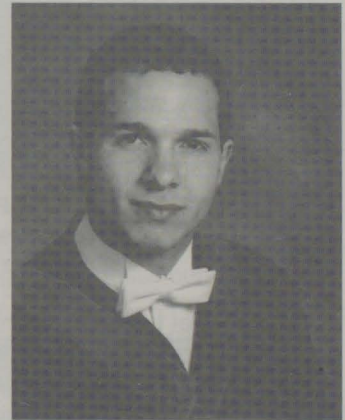

RAY SCRIMGEOUR
Mechanical Engineering

Nickname: Splifmaster
Biggest Weakness: Control Theory II
Favourite Pasttime: Commentating Tetris tournaments and partying at Ray's
Pet Peeves: Briefcase man, people who lip
Favourite Saying: What the hell is happening here!
Best Memory: 5 minutes ago, can't remember anything past that
Goal In Life: Graduating
Last Words: Smokin the pipe



ARDEN STASS
Mechanical Engineering

Nickname: Arden
Favourite Pasttime: Retaking classes
Goal In Life: Become rich and famous

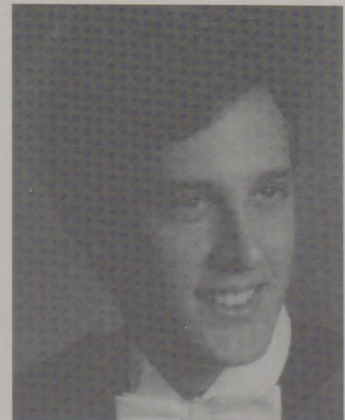



MIKE STEWART
Mechanical Engineering

JOSEPH TANG

Mechanical Engineering

Nickname: Chinaman

Biggest Weakness: Afraid of the "Bag"

Favourite Pasttime: Doing business with Louie

Pet Peeves: Projects, projects, projects and more projects

Favourite Saying: Smoky Ma Ma; "Mine, mine, all mine"

Best Memory: Dave and his "Bag"; Petrytang

Goal In Life: Reaching 1 billion dollars worth of sales in "Petrytang"

Last Words: Thanks for the memories. Keep in touch!

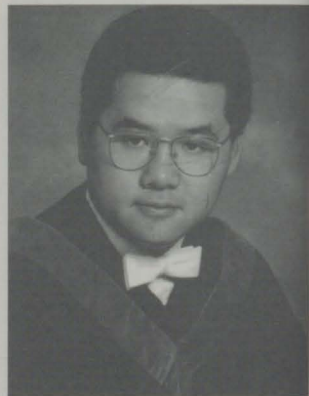

PETER WILSON

Mechanical Engineering

Nickname: Petor

Biggest Weakness: Karol

Favourite Pasttime: Making chocolate chip cookies

Pet Peeves: Can you get your dad to . . .

Favourite Saying: Smile for the camera

Best Memory: Spending afternoon in hospital after skiing

Goal In Life: Be happy

Last Words: *Never, never volunteer to do the yearbook*

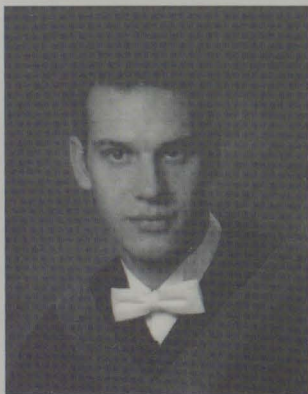

Engineering Society



After losing our office in 236 EH (and many before that) we were given a desk and use of communal space in the CAW Student Centre. Whoopee!

Louie, I know what the sign says, but I didn't want to hurt your feelings



Thanks for the desk, we got a lot of use out of it.

Moving back into Essex Hall made us all feel close again



The Final Awards Banquet '93



Whoopee!!! A bottle of Jack Daniels will make the night pass a little bit faster

Oh look! The first years are getting to know each other, but there's no talking going on.



The infamous Essex Award '93 being held by Brian. The team of four decided to make the Essex Hall lobby glass case into a real live aquarium. But the office secretaries didn't seem much like fish lovers. Oh well! It was still a good idea team!

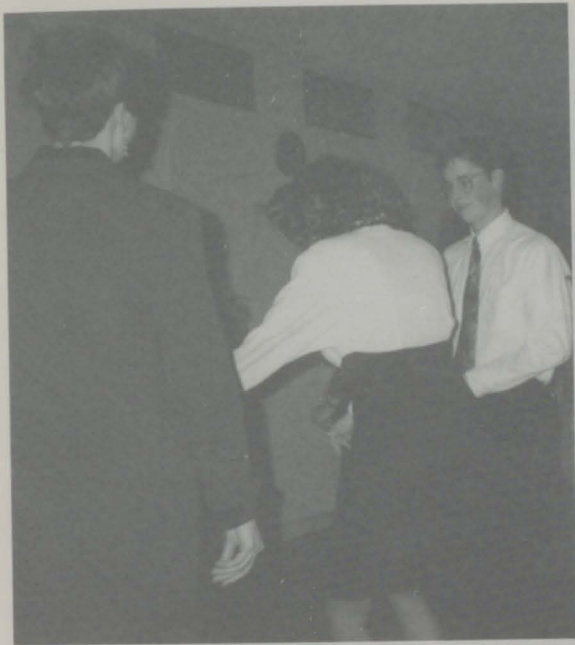

Just stop dancing. You're embarrassing me.

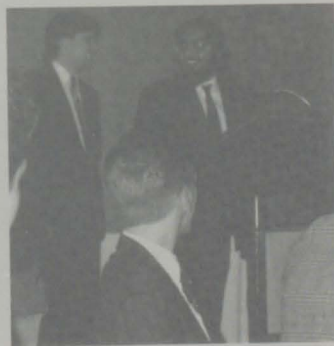

Didn't these two graduate at the turn of the century?



"What a loser"

"I can't believe my eyes"

"I can't stop laughing"



The Final Awards Banquet '94



University of Windsor
Engineering Student Society

FINAL AWARDS BANQUET

March 26, 1994
Fogolar Furlan Club

\$20.00 / person

6:00 p.m. - Cocktails
7:00 p.m. - Dinner



"So when Oscar comes over he'll have a place to stay"



"You mean I actually won something! I'd like to thank . . ."



Hey Lloyd, stay awake, the night is still young"



Don't you guys have something better to do yet?"



While we were smiling for the camera,
Scott was planning his next move



There he is, in for the kill



Froggy found a
bar with more
reasonable
prices

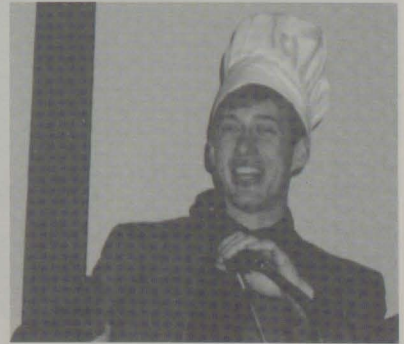

Chef Boy R Dee



Everyone was
friends after two
bottles of wine



Joe and John won loudspeakers for having big mouths



I don't think these guys knew what they were getting into



Glenn thought he could put them to better use



Al and Chris pondered why their repainted dyno didn't win OEC the second time around



Hi!



This year's Essex Award winners decided chickens were better than fish when they planned their attack. It certainly kept the Society president busy with Campus Police

(Brad)²



Hello, I'd like you to meet my date . . .



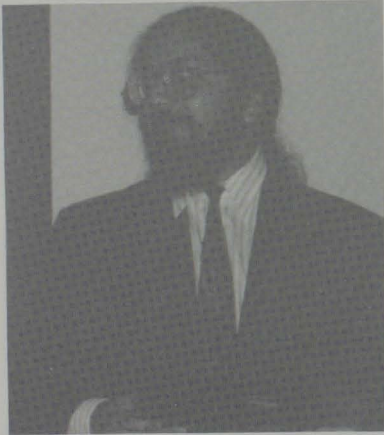

Oldest student in Engineering Award?



They serve Wildcat at the Fogular?



To all the womyn
in our lives

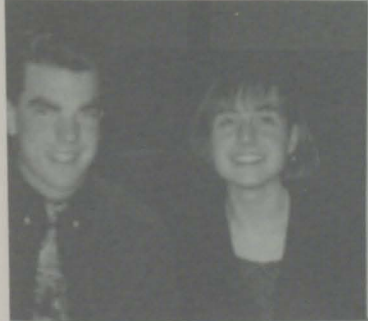

University of Windsor
Engineering Student Society

FINAL AWARDS BANQUET

March 26, 1994
Fogolar Furlan Club

6:00 p.m. - Cocktails
7:00 p.m. - Dinner

\$20.00 / person

4th year toast(ed)!





The chef with his crew



Oh, oh! It looks like an Italian standoff



1994 Grammy Winners



Chris sings Sinatra!



Louie, clean your plate!



Phil's date is playing with her food

"Oh yeah, I screw you all once again on the final"



A Louie Sandwich





HeyJeff!
Smile buddy!



Hey Ricci!
Shake that ass!



"Joe, shut up already,
you're making me
sick!"

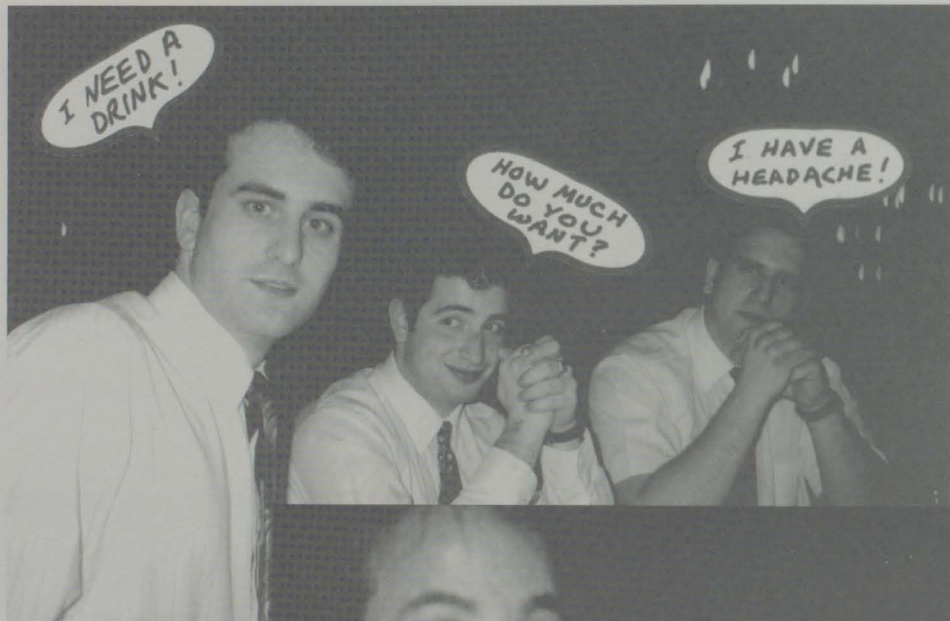

One of the few pictures where Roger is sober



"Come on AI, share with John

General Meetings

This is when we tell you what's going on.



They usually start out like this, in the old Room 305 Essex . . .

. . . or in the Odette Building





... and end up like this,
in the Grad House.

Hey Norm, don't pour
that beer in your ear!



Nice shot, Ray!

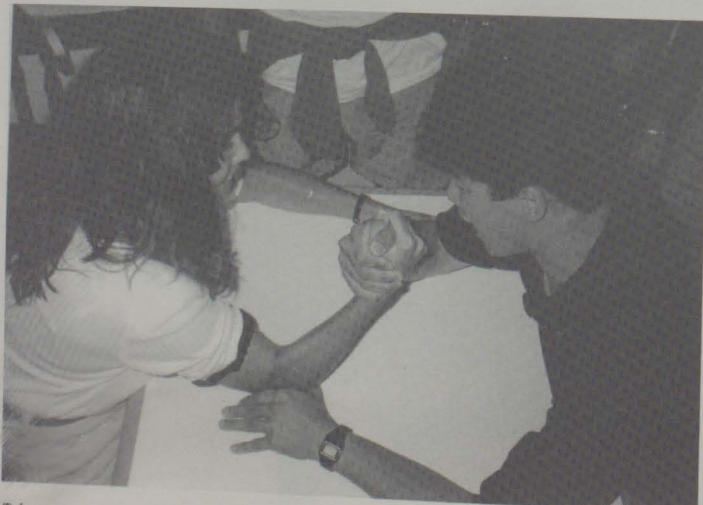

Smile Tim!

Ken and Rebecca decided
to settle a long term grudge.

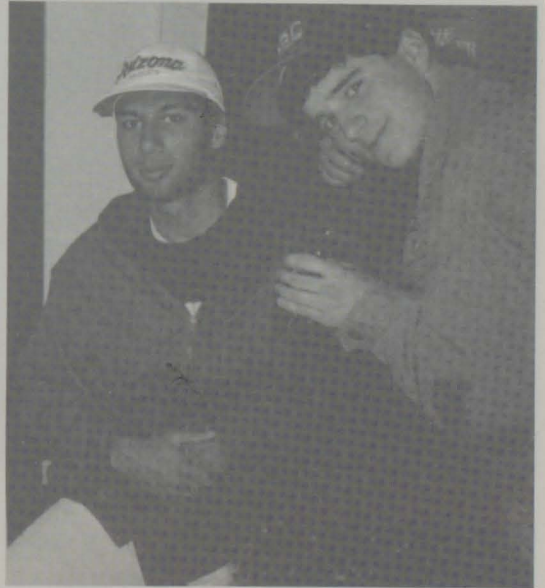



... or at Faces
(Pub Nite too!)

Beav says: "Drink up
while its free!"

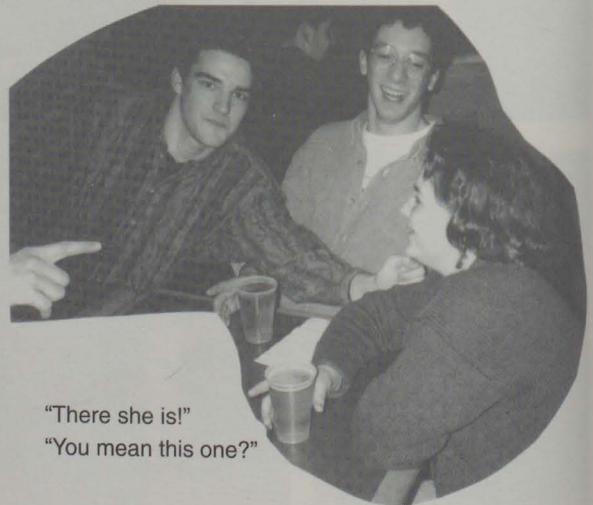

"There she is!"
"You mean this one?"

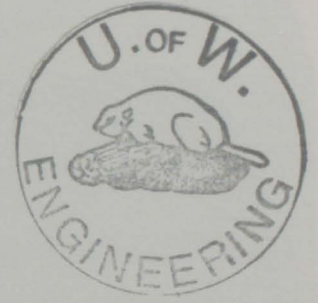

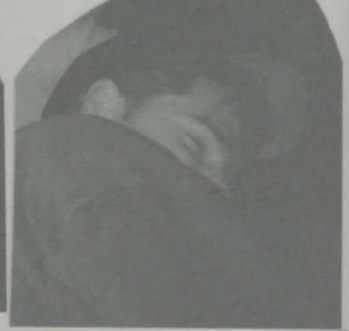



Beav says: "Wow, where'd you guys learn to drink like that?!"

Looking Ahead in Industrial Engineering - Held at U of W

DISTINGUISHED GUEST SPEAKERS



Dr. Fil Salustri
from U of Toronto



Dr. S.K. Kachhal
from U of Michigan



Representative from
Ford Essex Engine



Pete presenting Dr. Kachhal with a plaque in appreciation for speaking



Mark and Maricon

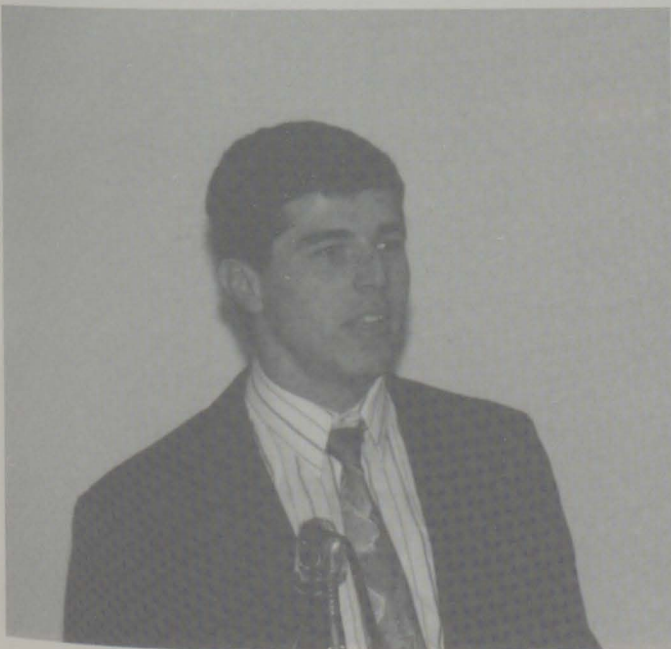

Darwisli, a 1st year student with a few words to say

CCES-26 - Calgary



The alert bunch
from Ryerson



The significant delegate from the U of S

And you're from . . . Quebec, right?





The Quebecers +
a Waterlooian

The nights were filled
with nothing but
mayhem and drinking . . .



A message from the students
at Memorial: "We're really sorry
we stuck you with Heiner."



1. Al decides to have a party in the girl's room

3. . . . and everyone leaves

2. Bruce gets wild . . .



4. Chris says, "To hell with you all" and heads for Daytona!

OEC Competition

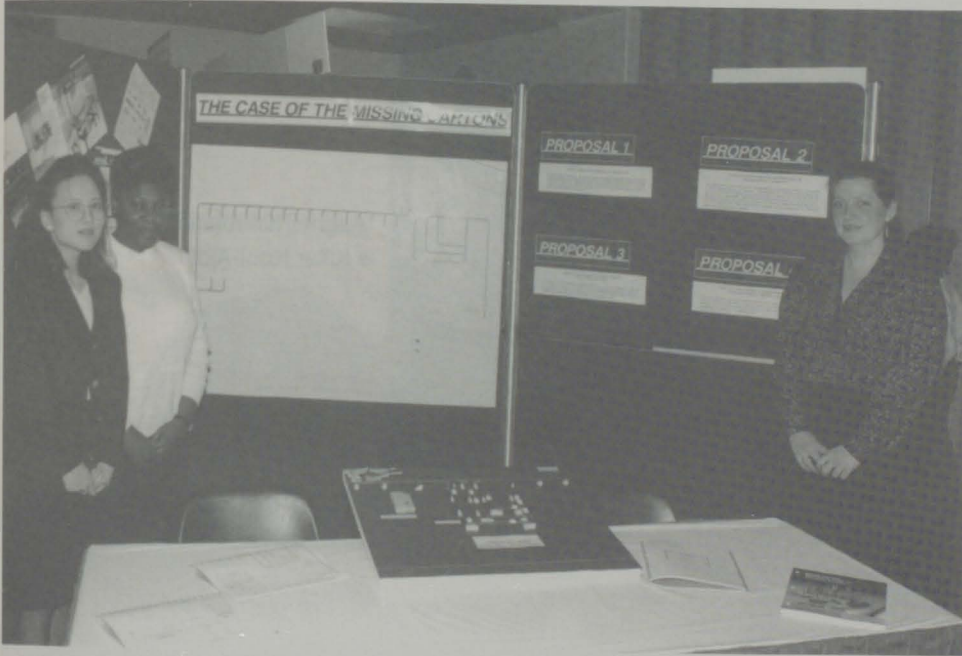

Competitors:
Shu Shyan Chen,
Michelle Spence,
and Laura Thomas



Chris Powell and
Al Ricci;
"You laugh, but this
year it works!"

Conferences



"Aagh! This really is Killer Kool-Aid!"

"Hey Chris, are you awake?"

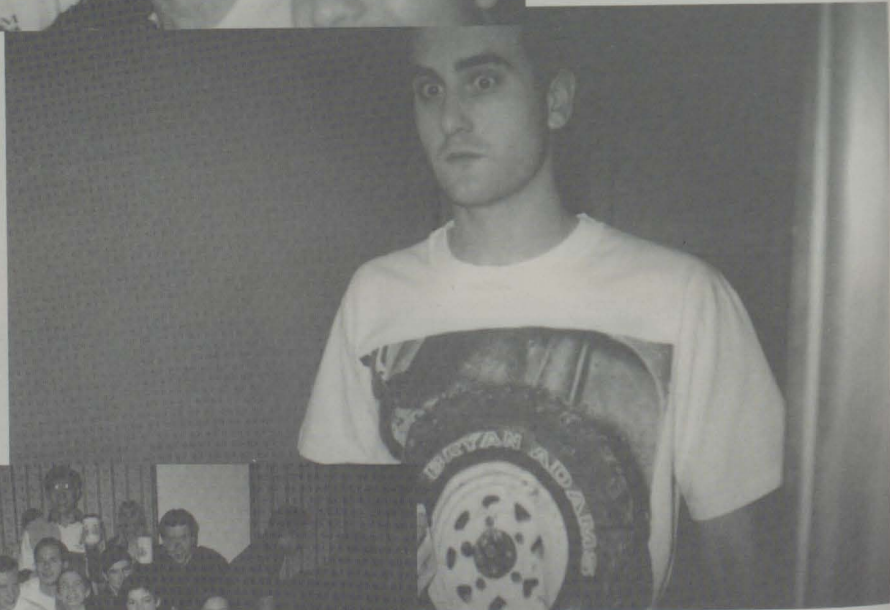

Lou picks up a few women.

Engineering Ski Trip (Mt. Brighton, MI) - Winter 94

Two Bonhommes

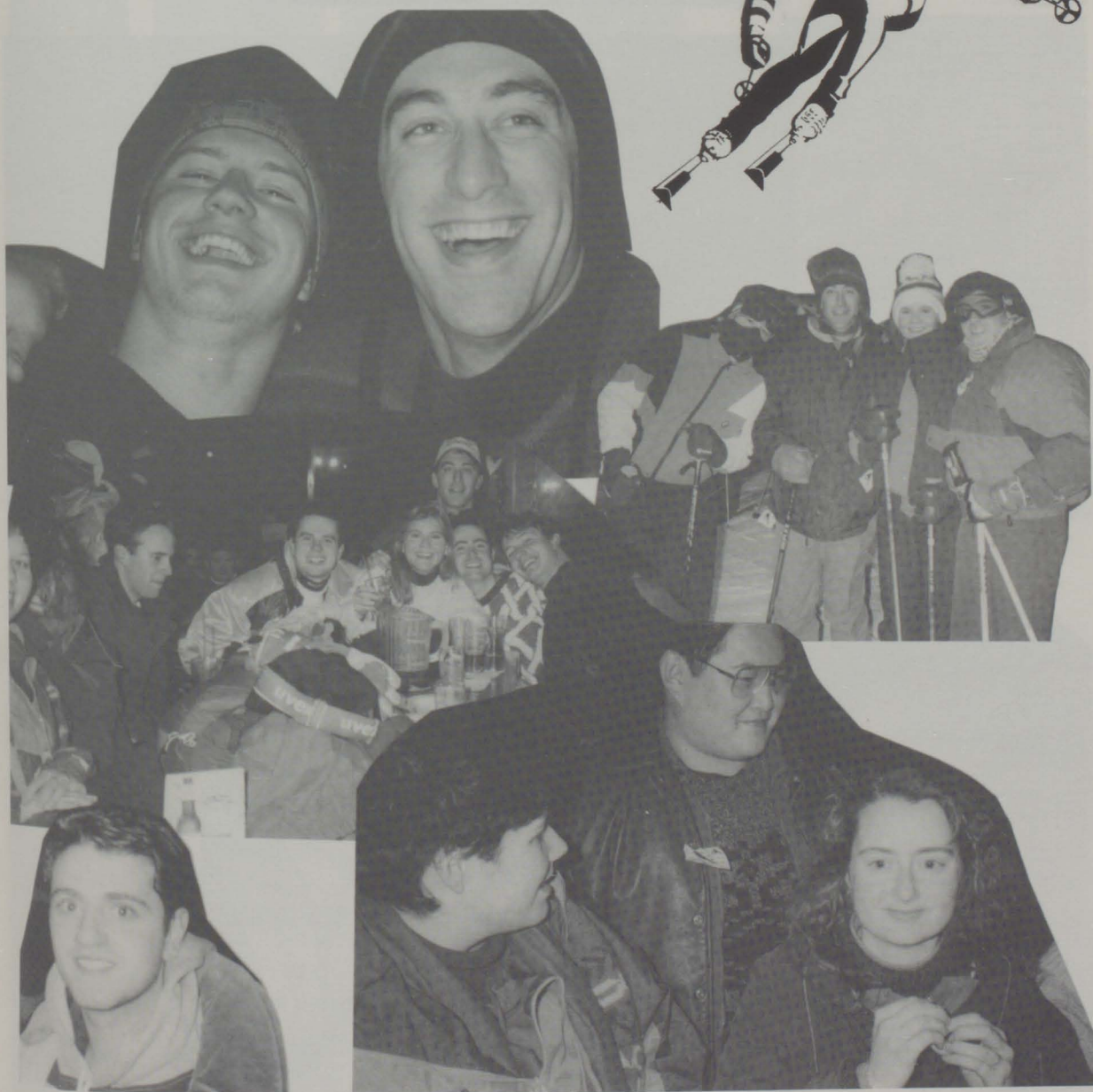



Hey Eli, bring your ID next time!



Hey, aren't you too short to ski?



Engineering Baseball (Fogular Furlan) - July 94



Is this the
World Cup
of Fuzball?



Poolshark
in action



High School Competition (Devonshire Mall)

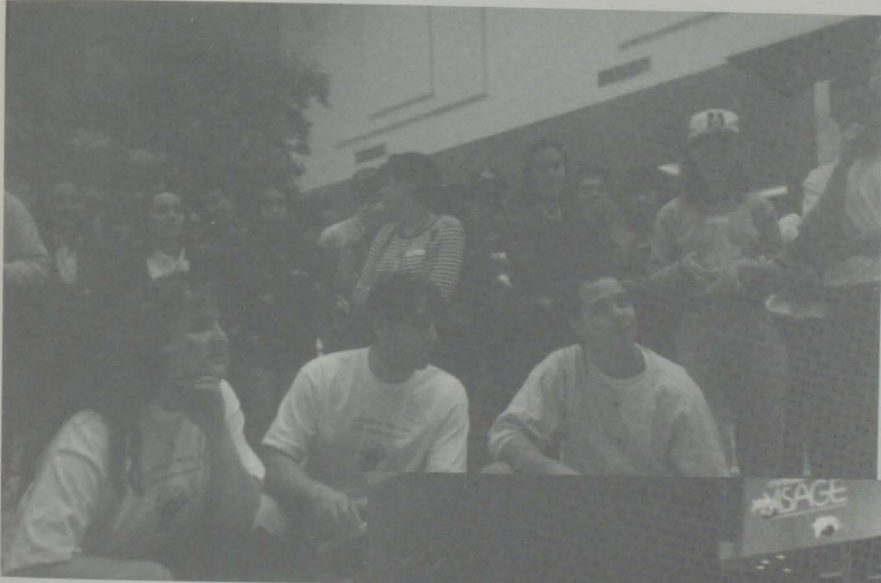

The organizers are stumped when asked "Why are we here?"



Lou, poking a girls eye out is not that funny

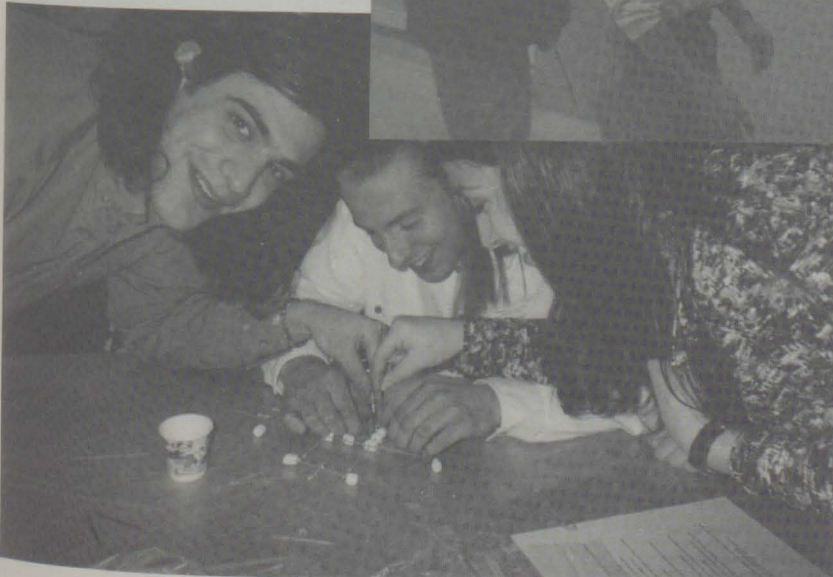

"Look Ma, nutritious university food!"



Hey Ken, don't
get sick here!

Windsor Engineers
in front of their
new business
venture



... and now, The Gang
at Ottawa!

Ultimate Drinking Matches



(Daytona Beach) - Kamikazee VS Chris
Kamikazee Wins!

(Cancun) - Rye VS Colene
Rye wins!

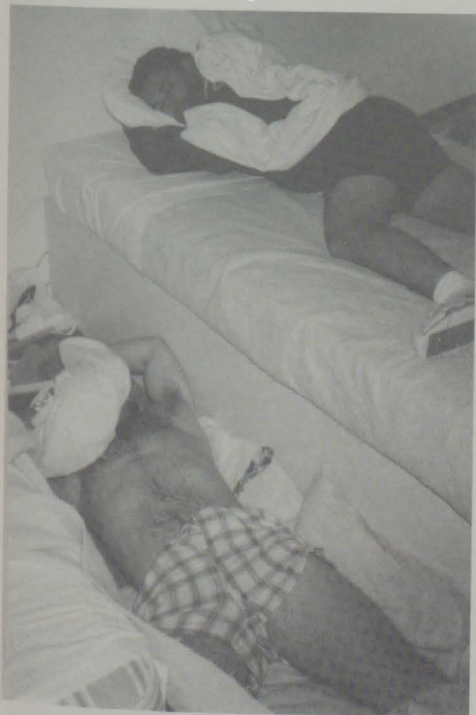

(Collingwood) - Rye VS Marco & Brad
Rye wins!

(Cancun) - Tequila VS Roger
"TA-KILL-YA" wins!



FINAL SCORE - BOOZE 4, ENGINEERS 0

Corn Roast '93

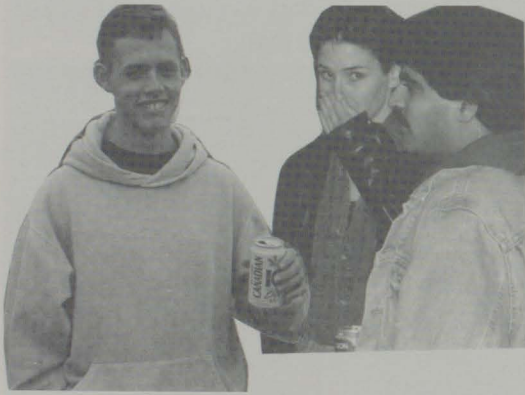

Luke Skywalker,
May the beer be with you



Someone having their own weiner roast



The Boys



I swear I thought that was my hotdog

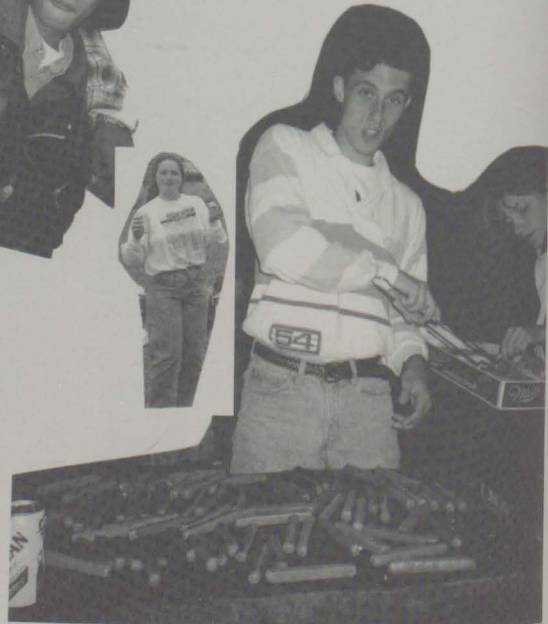

Just the way I like my beer, medium rare

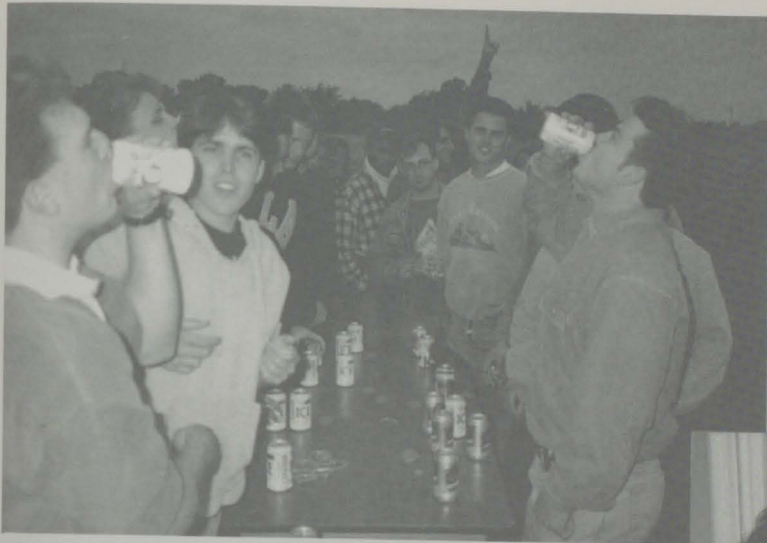

Boat races? I don't see any boats!



Should've got the butterfly ones



Erik and ??? kissing behind the Port-A-John

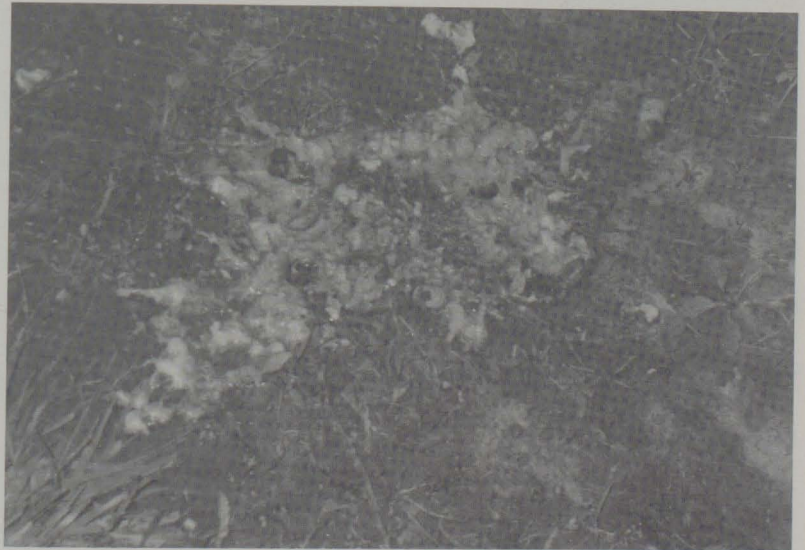

THE AFTERMATH



Engineering Bowling

Crescent Lanes Fall 1993

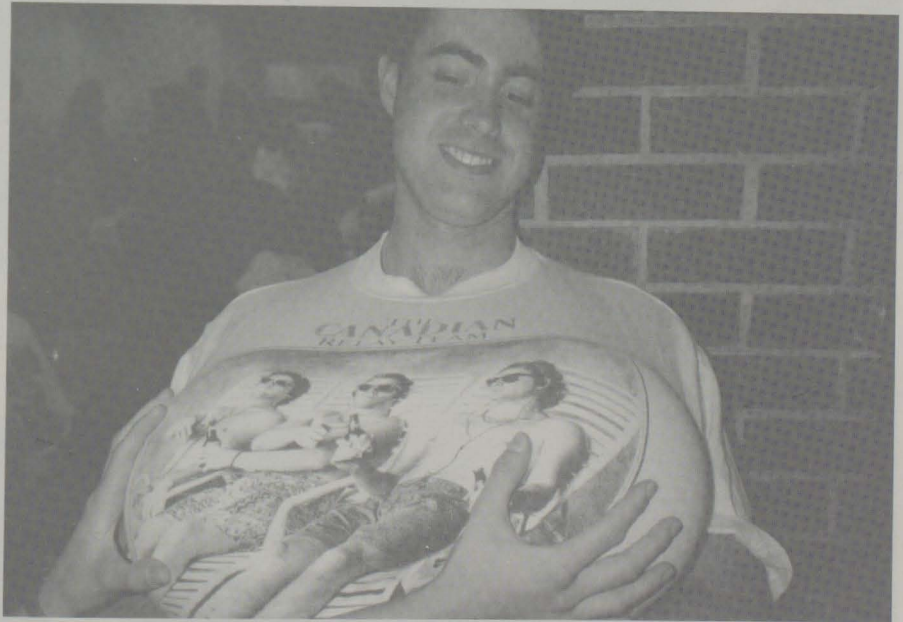
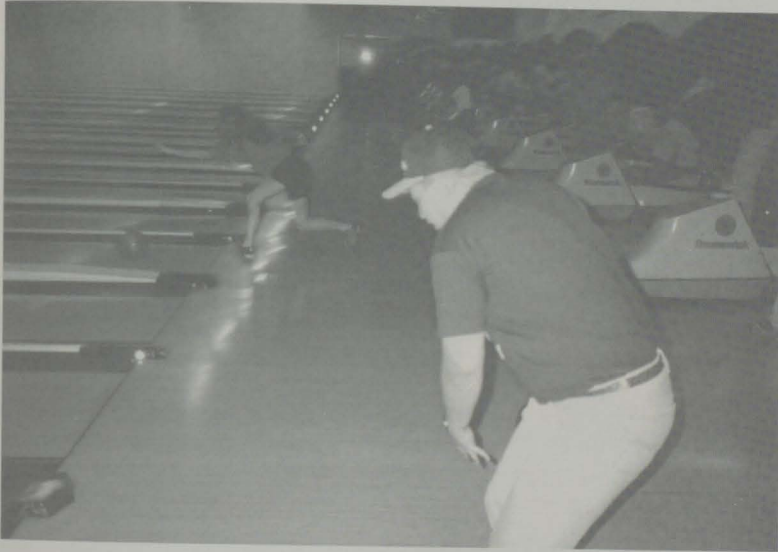

"Gee Brian, you're as firm as bowling balls."

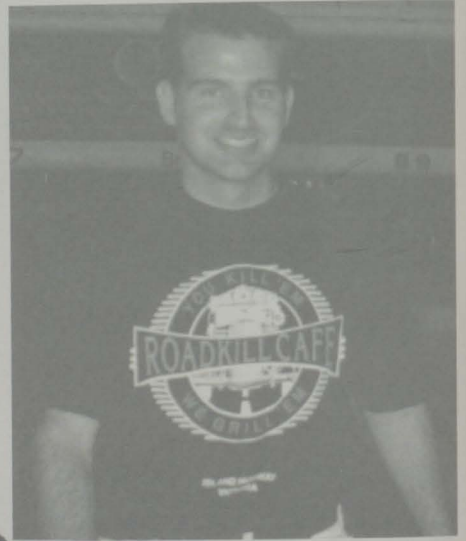
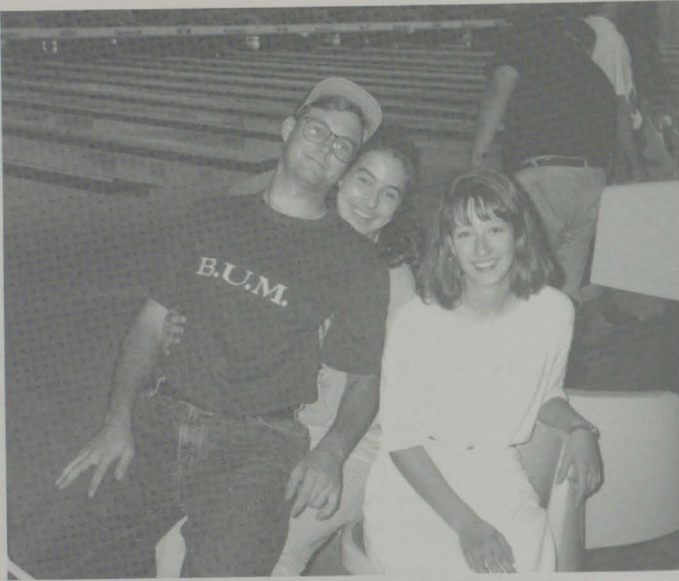

Hey Lou, this isn't funny anymore

"Hey check out . . .
a. the score.
b. those legs!"

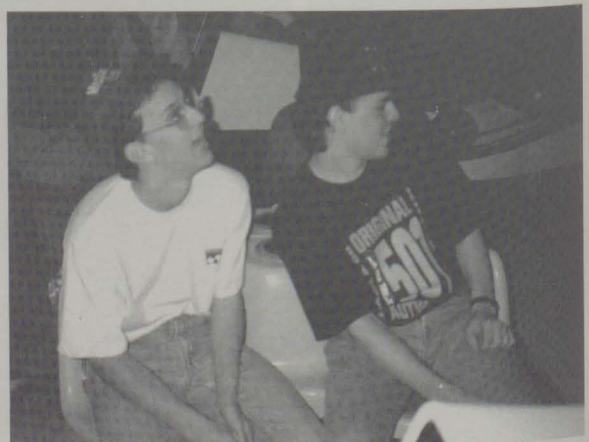



Yes Chris, those are nice bowling shoes



Okay, John Travolta!



You trying to do bird calls or something buddy?



Hey Tony, nice gold chain, oh . . . and by the way, are you Italian?

One Day I Was Strolling Around Campus and What Did I See?

You guys look marvelous!



Yes, this is what you're here for

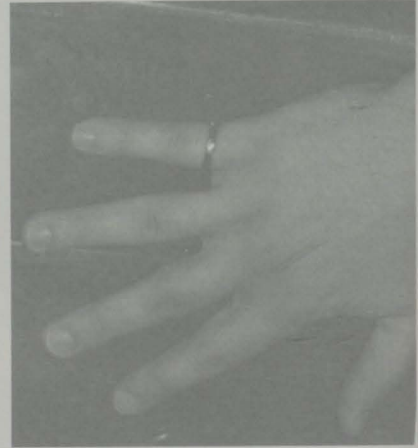

I found these guys working furiously to finish an assignment that was shortly due

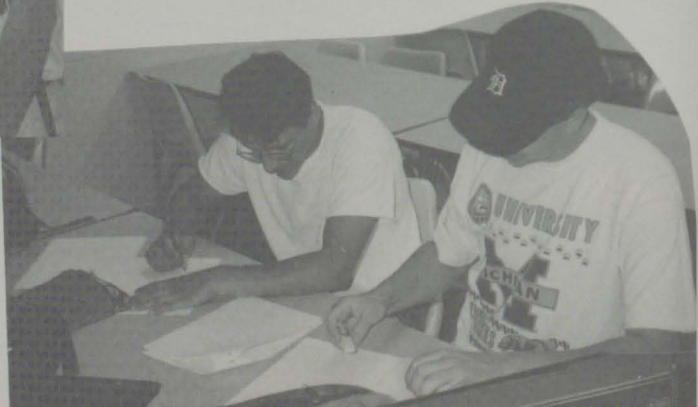

All of this work was making them hungry for a free snack



There was Volleyball . . .

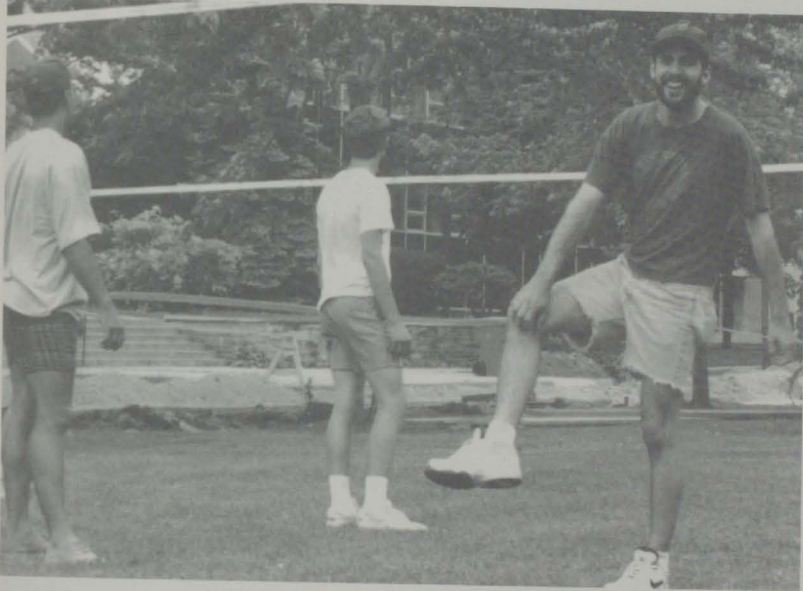

Are you doing
the shuffle Brian?

MABESA CASUALS

Get one soon, before everybody is wearing them!

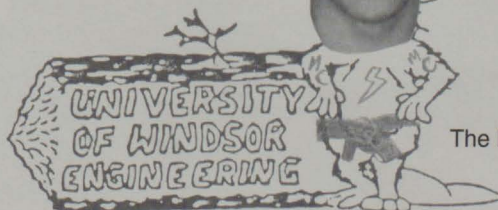

The Mabesa Casuals Mascot



I found some signs, on Sunset

At Ray's

During renovations, there were a few administrative changes

| CULT OF ENGINEERING | | | |
|---------------------|---------------|------|--------|
| DEAN | DR ALF HUNTER | ROOM | 242 EH |
| ASSOC DEAN | DR ROD WABEGA | | 240 EH |
| APARTMENTS | | | |
| CIVILED | KYLE GREGOIRE | | |
| ENVIRONMENTAL | DR M M | | 208EH |
| ELECTRICAL | DR R JU | | 22 EH |
| INDUSTRIAL | DR T OUN | | 212 H |
| MECH NICAL | DR N W SO | | 224A H |
| MAD CACA | MR LLARD | | 250A H |
| SECRETARIES | MRS J ASS | | |
| | MRS L RESCUE | | |

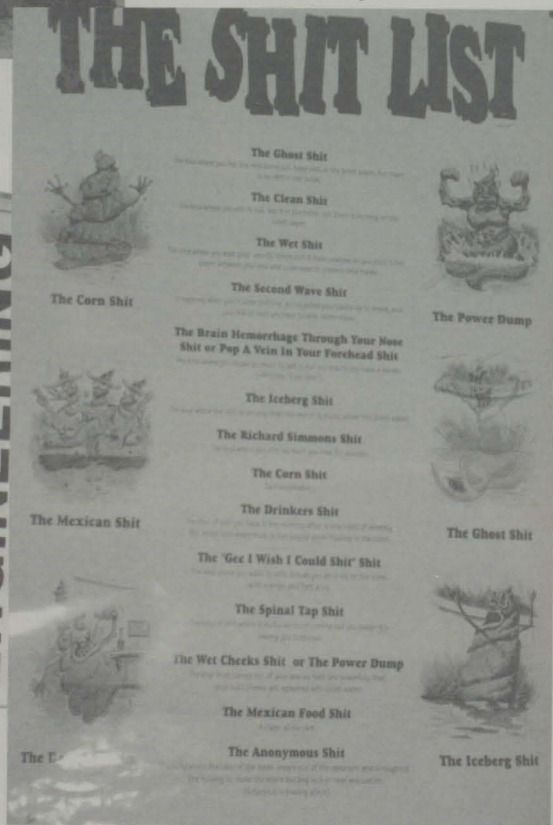

Rod's Chevette is ready for anything

This painting in Essex has been upside down for 2 years



... and then I walked
to the Grad House

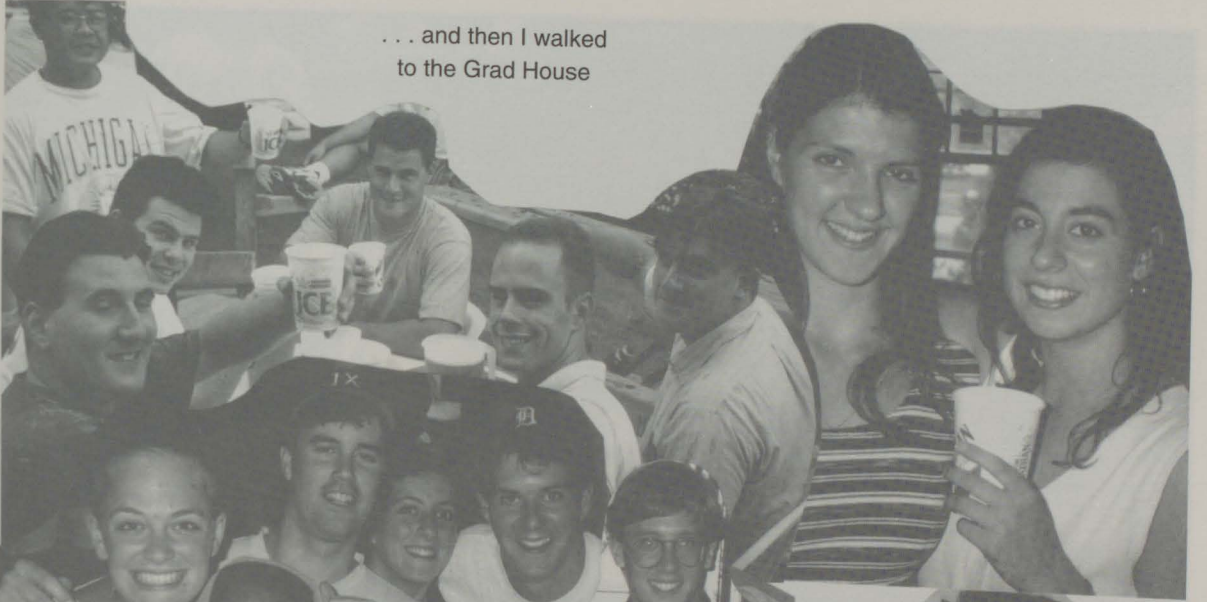



I even found the kind-hearted
President of the University
here to wish the Engineers well

Who Says That Engineers are Nerds?

George, a third year Mechanical Engineering student is a prime example of what a "Stud Engineer" is really like.



Engineers know their cars and always have the hottest wheels



Because of their great demand, engineers always have jobs and make lots of money



Don Cherry thought he was a sharp dressed man, but that's because he's never met an Engineer.

And to impress the ladies, engineers have a sensitive side too.

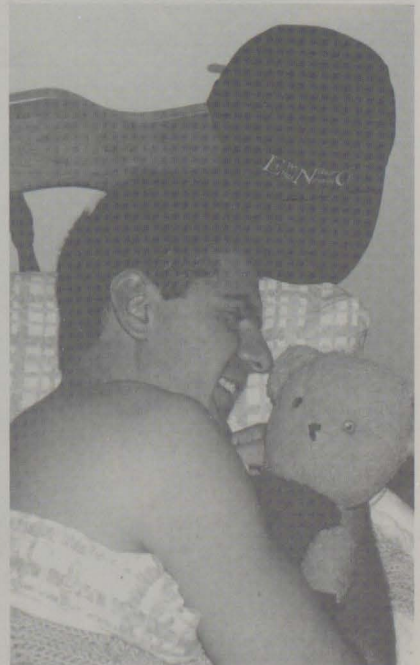

B.Y.O.B. Conference '94

Blue Mtn., Auberge, Collingwood Ont. - May '94 - Host: Heiner!



This conference was held to compare notes on beer, fishing, mountain biking, kitchens in bars, driving vans up mountains, go-karts, and of course passing out.

Thanks for everything Heiner!





Oh Brad, you're going to have a stiff back in the morning!

Sleeping Beauty



Taking a long walk off a short peer is just an expression Marco



We had a great time mountain biking



But ran into trouble on the way home

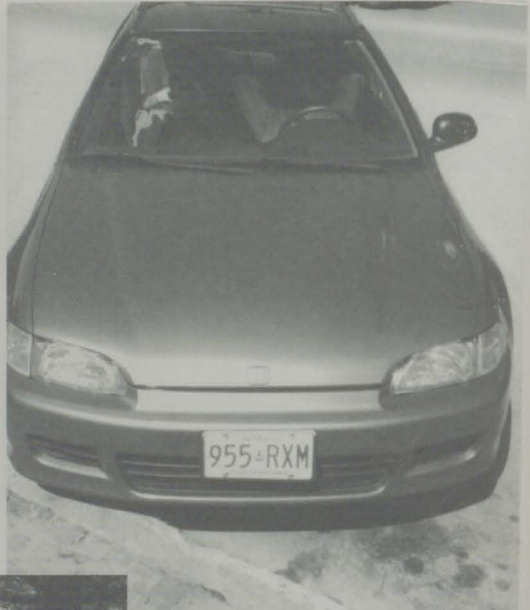

OFFENCE NOTICE/AVIS D'INFRACTION
 YOU ARE CHARGED WITH THE FOLLOWING OFFENCE
 VOUS ÊTES ACCUSÉ DE L'INFRACTION SUIVANTE

ON THE 29 DAY OF MAY 10 04 7:04 P M
 LE 29 JOUR DE MAI 10 04 7:04 P M

NAME: LEE SEN PETER S
 NOM: LEE SEN PETER S

ADDRESS: LA SALLE ONTARIO
 MUNICIPALITY/MUNICIPALITE: LA SALLE ONTARIO

DRIVER'S LICENSE NO./NUMERO DE PERMIS DE CONDUIRE: [blank]

SEX: M F
 DATE OF BIRTH/DATE DE NAISSANCE: [blank]

PLATE NUMBER: 955R XM ONT
 PROVINCE: ONTARIO

VEHICLE TYPE: PASSENGER CAR

DO YOU COMMIT THE OFFENCE OF: SPEEDING 105 km/h IN AN 80 km/h ZONE
 VOUS AVEZ COMMIS L'INFRACTION SUIVANTE: SPEEDING 105 km/h IN AN 80 km/h ZONE

CONTRARY TO: HIGHWAY TRAFFIC ACT
 CONTRAIREMENT A: HIGHWAY TRAFFIC ACT

SECTION/ARTICLE 108

NOTICE: WITHIN 10 DAYS OF RECEIVING THIS NOTICE, YOU MUST EITHER PLEAD GUILTY OR NOT GUILTY TO THE OFFENCE NOTICED. IF YOU DO NOT PLEAD GUILTY, A CONVICTION WILL BE ENTERED AGAINST YOU AND FINE PAYMENT ENFORCEMENT WILL FOLLOW.

AVIS: DANS LES 10 JOURS SUIVANTS, VOUS DEVEZ SOUScrire LAI RECOGNAITRE LA CULPABILITE OU LE NON PLEA D'UNE INFRACTION. SI VOUS NE PLEA D'UNE INFRACTION, UN JUGEMENT DE CONDAMNATION SERA ENREGISTRE EN VOTRE NOM ET LE RECOURS EN CAS DE NON PLEA SERA PERMIS. LE PROCES SE TIENDRA A L'INTERIEUR DU TRIBUNAL.

SIGNATURE OF ISSUING OFFICER: [Signature] OFFICER NO. 1888 A 018
 SIGNATURE OF DRIVER: [Signature]

PROVINCE OF ONTARIO'S OFFICE HAS NOT YET ALLOWED TO ACCEPT FINES IN UNDOCUMENTED FOREIGN CURRENCY.

SET FINE (INCLUDING COSTS) \$ 102.00
 AMENDE DETERMINEE (Y COMPRIS LES DEPENS) \$ SOMME TOTALE

TOTAL PAYABLE \$ 102.00
 SOMME TOTALE \$

IF YOU PLEAD NOT GUILTY THE TRIAL SHALL BE HELD AT: COUR DE LA JUSTICE DU QUEBEC

ONTARIO COURT (PROVINCIAL DIVISION) AT COUR DE L'ONTARIO (DIVISION PROVINCIALE) A

10 LOUISA STREET, 2ND FLOOR, ORANGEVILLE, ONTARIO 10, RUE LOUISA, 2^E ETAGE, ORANGEVILLE (ONTARIO)

DATE OF SERVICE: 05/29/04
 DATE DE LA SIGNIFICATION DE LA VOUS: 05/29/04

CO 2001 (REV. 01/04)

The Ticket

Port Dover

Drunk Conference Summer 1993



Held in sunny Port Dover, this was a meeting of hand and beer, beer and mouth, mouth and toilet!

Everybody was all calm and relaxed. Little did we know that Erik had run out of beer, and a primeval craving took over



Norm!



Never, never let Marco lead.

(P.S. Hey Colene, what does this sign mean to you?)

“Hey guys, how does that exhaust taste?”

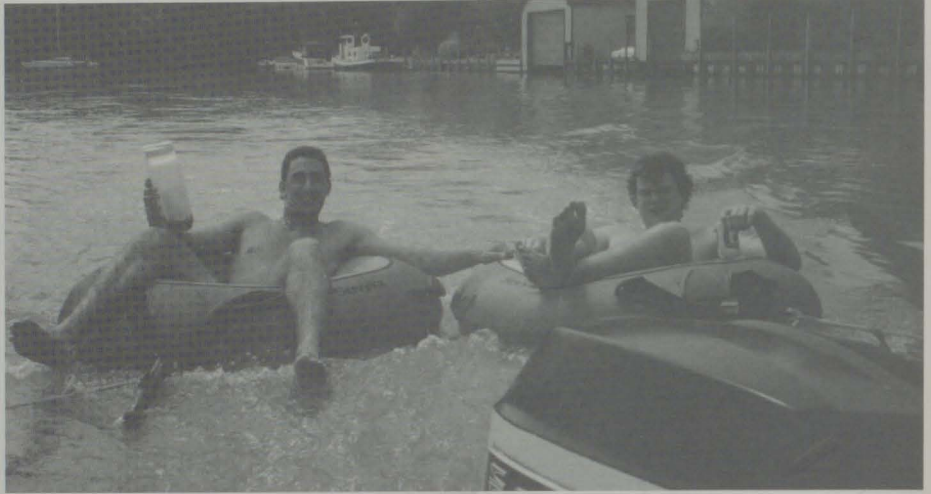

Hey Frog, I've got the camera

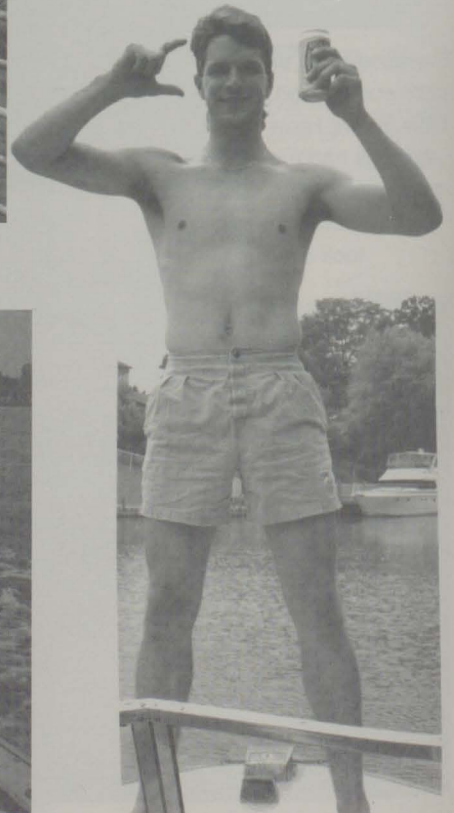

Object of the game: jump on the other guy and pull his shorts off



Slack Week '94

South of the Border - Cancun, Mexico

Those that had the courage
to run to the border



HANG ON FOR DEAR LIFE!





The island person comes home

"TEAM PARASAIL"



The girls painting the town red

Bloop, bloop, blap, blah!



Roger riding on his Harley Davidson
1340cc Fatboy



Algonquin



A.P.E.C.
Algonquin Park
Environmental Conference
Summer Break Week 1994



Remember
"It's a Shame About Ray"
Mark Algonquin
Flying Farts
Baby Duck Wine
Rod's Rain Dance
Brads snoring
"This is the best trip ever"

Buttnutt!



Just like the movie
"Indian Summer"



University Life





Now these guys are here to do business.



Nirvana visits campus during exams.





I told Al this picture was being sent to G.Q.



Computer room rookies



Marco should have ben watching the road



St. Patrick's Day - Moose Pub

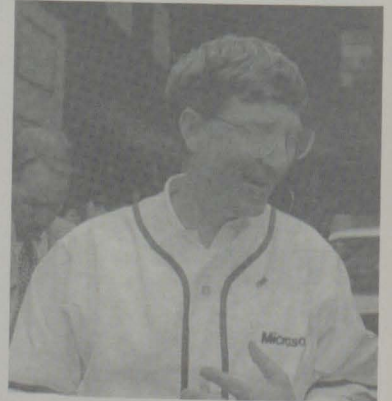

One of our more successful alumni, Gil Bates visits.



The sign reads,
"Please Don't Feed The Engineers"

My fourth year
project got an A+

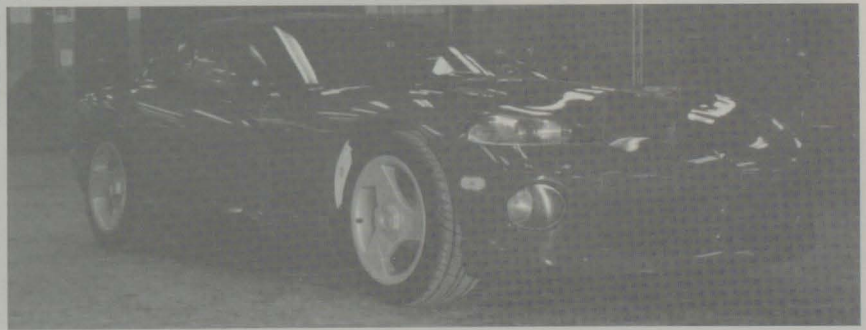

The founder of Moosehead Beer
- Big Al

Jill brings her Steve doll
along for a stroll



Watch out for the Hitman,
Cousin It!



These guys have a tendency of
being late for buses



Beav says: "I don't think
Mark's going to be smiling
for too long!"



A member of the Royal Family
makes an appearance



"First Years" invade the computer room

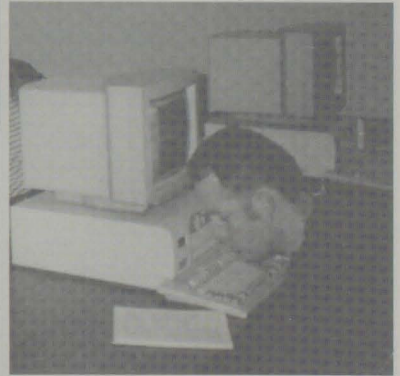

Studying in the "Green Room" at Casa Powell



That one must be Sleepy

What are you doing with those elves?





“Hey Chris! That beer is really starting to add up!”

Honestly, we're doing
Machine Design



Oh Joy! I'm free!
I'm free! I'm freeeee!



Alf: "Now that's a beer!"

A toast by the
Night of the
Living Dead



"Man, these
marshmallows are
good!"



After a general meeting - "No, really! I'm reading the newspaper"

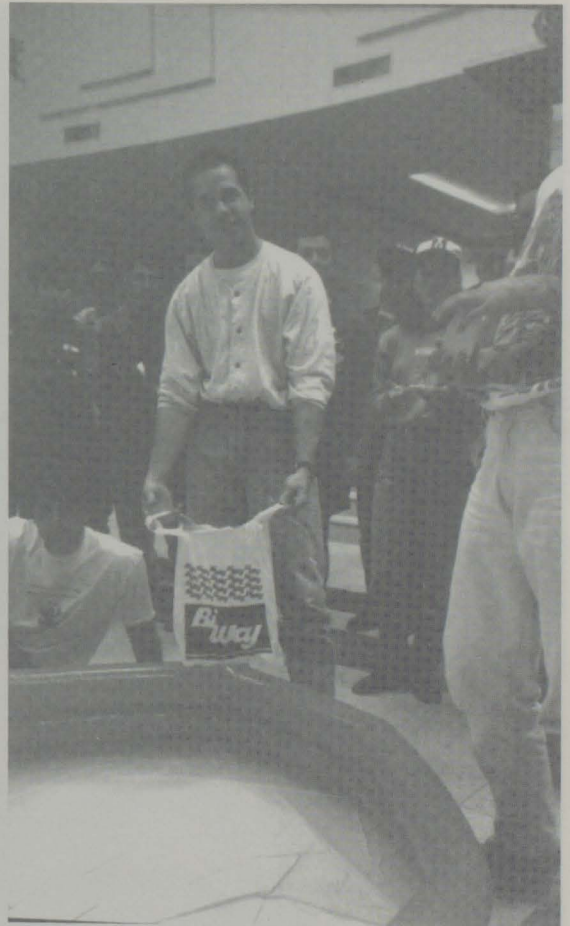

Where Louie does his shopping



Phil and Louie picking up Ottawa girls from the back of a pickup

"Lotto, get the hell
out of my house!"



Phil with his environmentally
friendly headgear

"You talkin' to me?"



This rare photo shows that when The Bag feeds, it can devour a whole man!



Dink and Dank

Flashback to 3rd year .
.. "Hey Roger, did your barber ever get his bowl resharpened?"





Woodstock '94

"Hey Dude, can I use my tickets from '69"

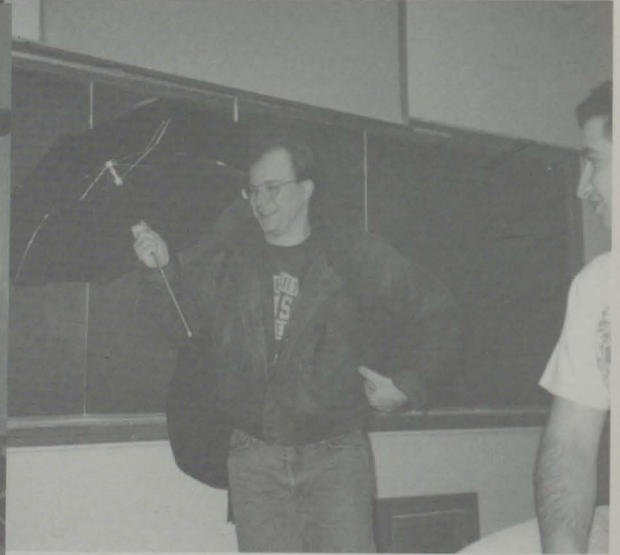
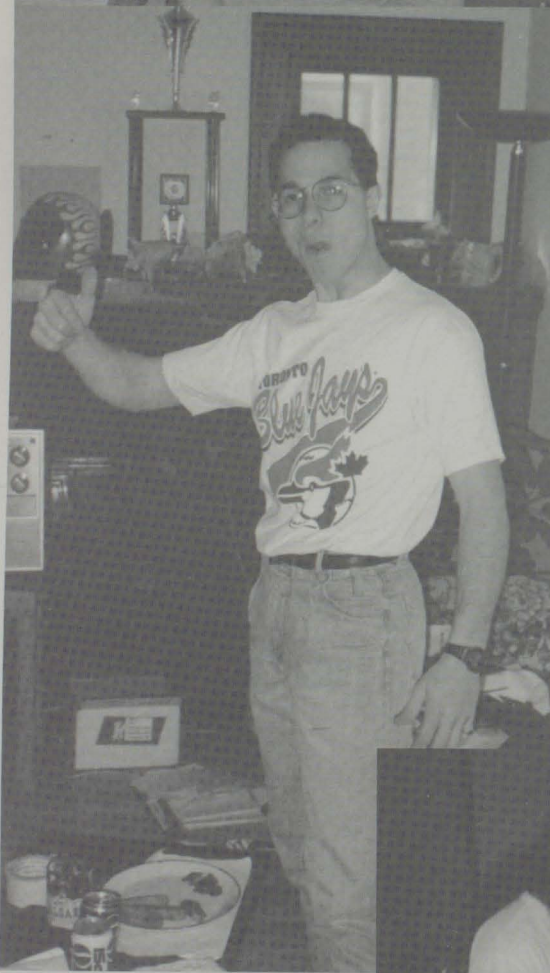

"I'm a little teapot . . ."

"If you don't like it, you can suck on my . . ."

"Let's face it Al,
you're screwed!"

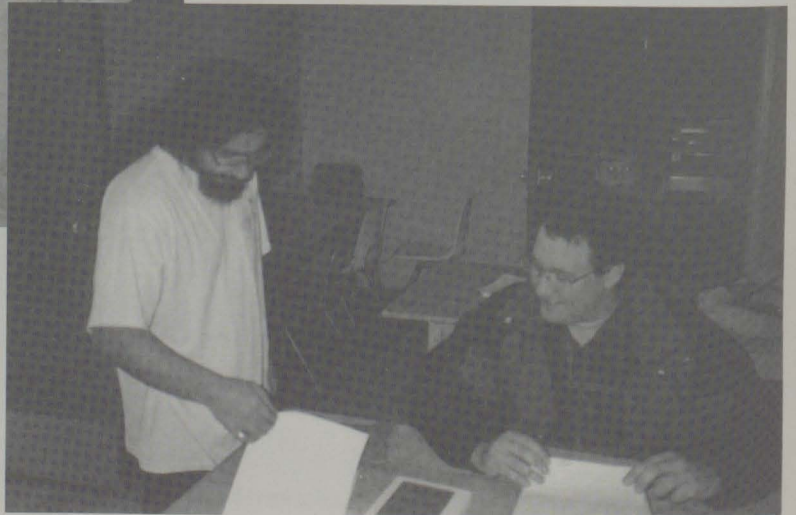



Ken is just realizing now the mistake he made going into Materials



"Yes, it's this big!"



"Hey Reach!
Look out!"

"Uh, did a fly hit me?"



Phil after a visit to the friendly folks at the Grad House

"If you want to pass this final you better pucker up!"



Ok!



What Chris feels like doing to anyone who asks about ENGSOC



John and Joe in the Mario Kart Challenge



John shows off his deady "Chair Karate" moves

The boys, the chick magnet, and the Mustang

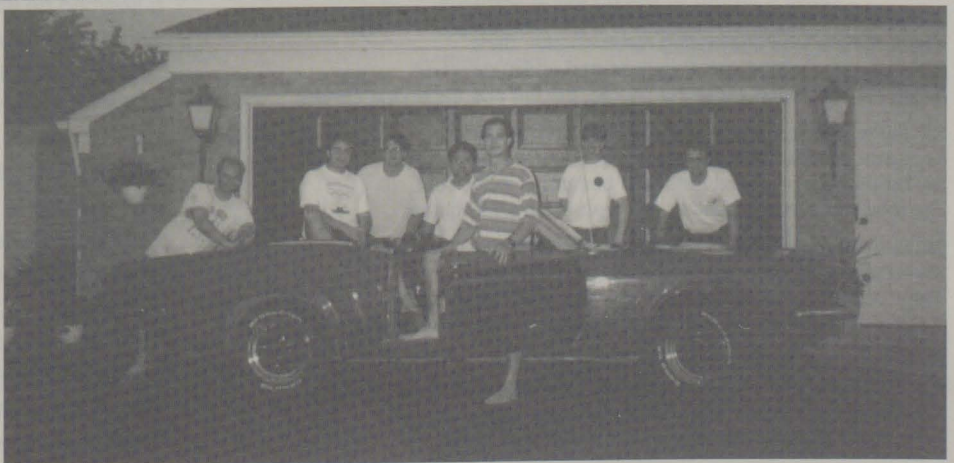

Engineering Literature

The Engineering Song

Godiva was a lady through Coventry did ride,
To show to all the villagers her lovely bare white hide,
The most observant man of all, an Engineer of course,
Was the only one to notice that Godiva rode a horse.

Chorus:

**We are, we are, we are, we are, we are the Engineers,
We can, we can, we can, we can, we can demolish forty beers,
Drink rum, drink rum, drink rum, drink rum and come along with us,
For we don't give a damn for any man who don't give a damn.**

I've come a long, long way, she said, and will go as far,
With the man that takes me off my horse and leads me to a bar,
The man who took her from her steed and took her to a beer,
Were a bleary-eyed surveyor and a drunken Engineer.

Sir Francis Drake and all his ships sailed up Calais Bay,
Cause they heard the Spanish rum fleet was headed up that way,
But the Engineers had beat them by a night and half a day,
And though they were as tight as virgins, you could hear them say.

The Army and the Navy boys set out to have some fun,
Looking for taverns where the fiery liquids run,
But all they found were empties, for the Engineers had come,
And traded in their instruments for gallon jugs of rum.

An Artsman and an Engineer one found a gallon can,
Said the Artsman "Match me drink for drink and prove you're a man"
They drank three beers, the Artsman fell, his face was turning green,
But the Engineer drank on and said, "It's only gasoline."

Venus is a statue made entirely of stone,
There not a fig leaf on her, she's naked as a bone,
On noticing her arms were broke, and Engineer discoursed,
"The damn thing's broken concrete and it should have been reinforced."

When I was young, I knew a girl whose heart was full of fire,
Her physical endowments would have made your hands perspire,
Shoe shocked me when she told me that she never had been kissed,
For her boyfriend was a tired Engineer Physicist.

A maiden and an Engineer were sitting in the park,
The Engineer was busy doing research after dark,
His scientific method was to marvel and observe,
While his right hand wrote the figures, the left one traced the curves.

My father peddles opium, my mother's on the dole,
My sister used to walk the streets; but now she's on parole.
My brother runs a restaurant, with bedrooms in the rear,
But they won't even speak to me, 'cause I'm an Engineer.

My father was a miner from the lower Malamute,
My mother as a mistress in a house on ill repute,
They kicked me out at a tender age and never shed a tear,
Saying, "Get out of here you son of a bitch, and join the Engineers."

Caesar set out for Egypt at the age of fifty-three,
But Cleopatra's blood was warm, her heart was young and free,
Any every night when Julius said goodnight at three o'clock,
A Roman Engineer was waiting just around the block.

Give a Shout, Give a Cheer

Give a shout, give a cheer
for the boys who drink the beer
In the cellars of old Essex Hall.

They are the brave, they are bold
and their liquor they can hold
Its the story of old Essex Hall.

Well its guzzle, guzzle, guzzle as the
beer goes down the muzzle,
Shout out your orders load and clear -
" MORE BEER "

If Dean North should appear, we'll say
"Hey North - Have some beer"
In the cellars of old Essex Hall.

On Top of Old Essex

On top of old Essex
All covered with snow
Stood an old professor
With head hanging low.

It seemed he was dreaming
About his engineers
And how he could nail them
In the final exam.

But they saw him scheming
And decided to act
But muffled it as usual
Not knowing the facts.

Thus we have the moral
For all in first year
Forget about studying
And just drink your beer.

Windsor Engineering Top 10 Lists

The Top 15 Reasons Why I became an Engineer . . .

15. Nothing like impressing someone with your knowledge of the Fibonacci series.
14. Enjoy playing connect the bedheads.
13. Cornroast.
12. Taking 6 courses a semester is more interesting
11. Enjoy hearing about how other people only go to school 2 days a week.
10. I always wanted a \$5,000 library by the age of 23.
9. I always wanted to learn to copy really fast.
8. You need an Engineering Degree to flip burgers at the Grad House (Hugh).
7. So I could go to school in the summer.
6. Learn how to use a calculator smarter than me.
5. I always wanted to learn a foreign language.
4. I always wanted to see how low a mark I could get on an exam (with studying).
3. Increase my alcohol tolerance.
2. Appreciate subtle differences between $F=ma$ and $F=mg$.
1. I heard there was a lot of girls in Engineering.

How to Get Through Engineering

10. Frequent local pub's (Grad House).
9. Never question when copying.
8. Learn how to program you calculator.
7. Learn how to copy fast.
6. Go to Mr. Copies or buy a copy card.
5. Get a hold of old or present exams.
4. To avoid being confused, don't go to classes.
3. Attend all General Meetings.
2. Pretend the T/A is your friend.
1. Buy a Mabesa Casual t-shirt.

Top 10 Courses

10. Statics (The ol'days before things started moving)
9. Networks & Systems (Learn how to shut down Ontario Hydro)
8. Soils (Learn how to dig holes)
7. Thermodynamics & Kinetics of Metallurgical Process (Who knows?)
6. Engineering Society (Learn how to sexually harass and get away with it)
5. Deformation & Fracture (Learn the UTS of a latex condom)
4. Gas Dynamics (How to clear a room)
3. Noise (See who can swear the loudest)
2. Fluid Mechanics I (How to funnel a beer)
1. Fluid Mechanics II (Funneling a beer without getting sick)

*Compliments
of*



PROCTOR & REDFERN LIMITED

*Congratulations
and best wishes*

**ITT
CANADA**



ELASTO-TEC CANADA, INC.
3370 MANHEIM WAY • WINDSOR, ONTARIO N8W 5B1
519/974-6565

*Best Wishes
to the
Graduates*

PERFORMANCE THROUGH ENGINEERING



MORGAN PRECISION TOOLS INC.

Suppliers of Industrial Measurement
and Calibration Services

MASTER - V.P.

THE ULTIMATE MILL READOUT

by **ACU-RITE**



- Taking the manual calculations out of manual milling
- Faster creation of bolt hole patterns
- Automatic midpoint capability
- Programmed presets and tool offsets
- Instant start-up on repeat work

1823 Wyandotte Street East, Windsor, Ontario
256-2625 and 1-800-265-1329 and Fax 256-8030

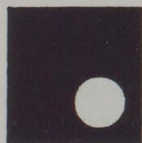

CONSULTING
ENGINEERS
Since 1892

**LA FONTAINE,
COWIE,
BURATTO
& ASSOCIATES
LIMITED**

3260 Devon Drive, Windsor, Ontario, N8X 4L4



DOUGLAS DOWNING
PRESIDENT

CORROSION SERVICE COMPANY LIMITED
369 RIMROCK ROAD
DOWNSVIEW, ONTARIO M3J 3G2

(416) 630-2600 EXT. 238
FAX (416) 630-2393

Saluting the Profession of Engineering



Ethyl Canada Inc.
220 St. Clair Parkway
Corunna, Ontario

'Balancing Environmental Values with Human Needs Through Innovative Technology'

Varian Canada Inc.

45 River Drive / Georgetown / Ontario / L7G 2J4

CONGRATULATIONS
ON BEHALF OF

Varian Canada Inc.
45 River Drive
Georgetown, Ontario
L7G 2J4



varian



hallmark tools
A DIVISION OF DERLAN MANUFACTURING INC.

*Leaders in Plastic Injection
Mold Technology*

P.O. BOX 331110
DETROIT, MICH. 48232-7110
(313) 964-4894
FAX (519) 966-2888

2187 HURON CHURCH RD.
P.O. BOX 7040
WINDSOR, ONTARIO N9C 3Y6
PHONE (519) 966-4052

Congratulations
FROM

Canada Salvage
1262 Ottawa St., Windsor, Ontario N8X 2E6



UMA ENGINEERING LTD.
Engineers & Planners

Environmental Engineering (impact assessments, audits, water & sewage systems, storm water management); **Urban Engineering;**
Transportation Engineering (impact studies, traffic management, roads, structures, signalization & lighting, transit system operations);
Building Engineering (repair/renewal/conservation)

1135 Adelaide Street N., Ste. 211, London, ON N5Y 5K7 (519) 642-2400
5080 Commerce Blvd., Mississauga, ON L4W 4P2 (416) 238-0007
2315 St. Laurent Blvd., Ottawa, ON K1G 4K6 (613) 739-3339
1074 Webbwood Drive, Unit 2, Sudbury, ON P3C 3B7 (715) 671-9227
230 Cumberland Street, Thunder Bay, ON P7A 4N3 (807) 345-9099

*Congratulations
and best wishes*

M.T.E. CONTROLS

MACHINE TOOL ELECTRIC

5135 Hennin Drive,
Oldcastle, Ontario
N0R 1L0



(WINDSOR) LTD.

PERFECTION AUTOMOTIVE PRODUCTS

P.O. BOX 7336
WINDSOR, ONTARIO
N9C 4G1

*Compliments
of*

BASF

Automotive OEM

BASF Canada Inc.
845 Wyandotte Street West
Windsor, Ontario N9A 5Y1
(519) 256-3155
Telefax (519) 258-7815



*Ciociaro
Club
of
Windsor*

3745 NORTH TALBOT ROAD
R.R. #1, OLDCASTLE
ONTARIO N0R 1L0

TEL: (519) 737-6153
(519) 737-6757
FAX: (519) 737-7269



Esco Engineering

179 Lansdowne Avenue,
Kingsville, Ontario N9Y 3J2
Phone: (519) 733-3122

Neil Stone
Chief
Engineer

*food & chemical process plant
layout - piping*



**R.J. CYR
CO. INC.**

Conveyors • Cranes • Shop Fabrication
Erection and Millwright Service
Windsor, Ontario, Canada N0R 1K0
(519) 737-6194 Fax (519) 737-6566

Compliments
of



Canada



JOHN NOVOSEL
PRESIDENT

5375 PULLEYBLANK ST.
R.R. #1, WINDSOR, ONTARIO
N9A 6J3

TEL: (519) 737-7137
FAX: (519) 737-7111

Compliments
of

ViloSystems

1106 LARAMIE ST.,
TECUMSEH, ONT.,
N8N 3B7



Gore & Storrie Limited
Consulting Engineers

Wastewater • Water
Water Resources • Waste Management
Environmental Planning • Drainage

255 Consumers Road
North York, Ontario, M2J 5B6
(416) 499-9000
(416) 499-0090 + ext.



GENERAL CONTRACTORS
FOR OVER 100 YEARS

HALIFAX \ TORONTO \ CALGARY \ VANCOUVER

Green Shield
CANADA

285 Giles Blvd. E., P.O. Box 1606
Windsor, Ontario N9A 6W1

Phone (519) 255-1133 Ext. 901
Inwats 1-800-265-5615
Home Phone: (519) 972-7861
Cellular Phone: (519) 257-0181
Fax (519) 255-7929

DELCAN

CONGRATULATIONS
TO THE
CLASS OF '94

DELCAN
Corporation

Delcan Corporation is one of Canada's leading engineering and planning firms with offices across Canada, USA and overseas

TORONTO
(416) 441-4111

CALGARY
(403) 276-9881

VANCOUVER
(604) 525-9333

COMPLIMENTS OF

Union Gas

WINDSOR, ONTARIO

ALIVE! CANADA

Suicide Prevention & Awareness

1695 University Ave. W., Unit F
Windsor, ON N9B 1C3

Ph: 252-9020

FAX: 258-2346

Community Educator

If you
need a
**Labelling
System**
you need...



**AVERY
DENNISON**

35 McLachlan Drive Rexdale,
(Toronto), Ontario M9W 1E4
Telephone (416) 675-3161

Phone (519) 352-5637

Fax (519) 352-4204

Thames Machine and Tool Limited

C.N.C. Machining

Machine Build & Repair - Welding & Fabricating

Tools - Dies - Fixtures - Custom Machining

ALLAN NAUER
General Manager

585 Riverview Drive
CHATHAM, ONTARIO
N7M 5J5



SNC • LAVALIN

Engineering the World, Engineering the Future

2235 SHEPPARD AVE. E., WILLOWDALE, ON M2J 5A6
Phone: (416) 756-2300 Fax: (416) 756-2266

875 Foster Ave., Windsor, Ont N8X 4W3
Phone: (519) 250-8744 Fax: (519) 250-8766

Other Ontario offices located at:
London, Ottawa, Waterloo



Westinghouse Canada Inc.

*is proud to support
the pursuit
of*



academic excellence

*Congratulations to the
1994 Engineering Graduates*

FMG Timberjack

FMG Timberjack Inc.
925 Devonshire Avenue
Woodstock, Ontario

Compliments of

ELECTROMAC TOOL & DIE LTD.

1965 Ambassador Drive
Windsor, Ontario
N9C 3R5

Novellette

MACHINE REPAIR AND FAB. LTD.

745 Morton Drive
Windsor, ON N9A 6Z6

Phone (519) 734-1505
Fax (519) 734-6348

**Meeting Today's Demanding Needs
for High Performance Concrete
with Specialty Admixtures**

Exclusively from Master Builders Technologies, Ltd.

- RHEOCRETE® 222 - Organic Corrosion Inhibitor
- RHEOBUILD® - Third Generation Superplasticizers
- MB-SF™ - Silica Fume
- POLYHEED® - Admixtures for Superior Finishability
- POZZUTEC® 20 - Low Temperature, Non-Chloride Accelerator



Master Builders Technologies, Ltd.
Admixture Division
3637 Weston Road
Toronto, Ontario M9L 1W1
800-387-5862

CONGRATULATIONS



5310 WALKER ROAD
OLDCASTLE, ONTARIO, CANADA N0R 1L0
P.O. BOX 33396, DETROIT, MICHIGAN 48232

MEDA
GROUP

*Congratulates the graduating class of '94 for their
enthusiasm and dedication.*

Meda Limited
Meda Medical Personnel Limited
Meda Personnel Limited
Phoenix Consultants, Inc.
Meda Management Consulting Limited
Goliger's Travel (Top Gun International Ltd.)
Contract Professionals International Limited
Career Probe West Inc.

*The Meda Group welcomes résumés from
qualified applicants who would like to join our
dynamic team.*

1575 Lauzon Rd.
Windsor, Ontario N8S 3N4
Phone: (519) 944-7221 Fax: (519) 944-6862
Chatham: (519) 351-5027 Detroit: (313) 965-4877

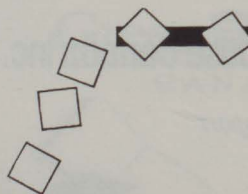

Nacan Products Limited, a multinational Fortune 300 Company is a manufacturer of Adhesives, Resins and Starches.

Nacan produces over 2,000 technically advanced products and operates an international network of more than 100 manufacturing and customer service centres on five continents. Nacan's products are with us every day. They can be found in almost everything we use or consume daily: food we eat, paper we write on, clothes we wear, furniture we sit on to the boxes, containers and packages that ultimately enclose these items. Our research efforts constantly result in improvements that make our customer's products even better.

Nacan Products Limited

60 West Drive, Brampton, Ontario L6T 4W7

*Best Wishes to all
University of Windsor
Engineering Students*

Schneider Canada is this country's leading supplier of equipment used in the control and distribution of electrical power.

Schneider Canada manufactures, sells and services Federal Pioneer, Merlin Gerin, Square D and Telemecanique products.

Offices in principal cities across Canada.



■ Federal Pioneer ■ Merlin Gerin ■ Square D ■ Telemecanique



Designing, Manufacturing & Supplying

- automated resistance welding systems
- special machines
- index tables
- VOLTZA® transgun packages
- OHMA® welding and piercing cylinders
- OHMA® press packages - 4-70 tons
- copper, brass, bronze
- resistance welding components
- standard RWMA components
- seam welding wheels
- cold-formed caps
- slide assemblies
- special electrodes
- cold-formed welding tips

Special Machinery Division

P.O. Box 7068
415 Morton Dr.
Windsor, Ont. N9C 3Y6

Can. (519) 734-8464
U.S. (313) 962-1448
FAX (519) 734-7408

Electrodes Division

P.O. Box 7068
595 Morton Dr.
Windsor, Ont. N9C 3Y6

Can. (519) 734-6886
U.S. (313) 961-4080
FAX (519) 734-0016

OHMA® Systems Inc.

655 Morton Dr.
Windsor, Ont.
N9J 2L3

Can. (519) 734-8330
U.S. (313) 961-3731
FAX (519) 734-6227

*VOLTZA® REG. TRADE MARK OF DOBEN LTD.

*OHMA® REG. TRADE MARK OF DOBEN LTD.

**Assume
responsibility.
Gain respect.**

Earn the right to put P.Eng. beside your name. To learn how, contact PEO, the association that regulates the engineering profession in Ontario.



**Professional Engineers
Ontario**

1155 Yonge Street
Toronto, Ontario M4T 2Y5
Tel: (416) 961-1100
Fax: (416) 961-1499

**Compliments
of**



**GENERAL CHEMICAL CANADA LTD.
PRODUITS CHIMIQUES GENERAL DU CANADA LTÉE**

Congratulations

INTEGRAM

Windsor Seating



Through the integration of people and technology we will design, manufacture, and supply quality seating systems to our customers at a competitive price.

INTEGRAM - WINDSOR SEATING
A DIVISION OF ATOMA INTERNATIONAL INC.
201 PATILLO ROAD, P. R. #1
TECUMSEH, ONT. N8N 2L9



*Soft Gel Manufacturer
Standard & Custom Formulas
Technical Services &
Turnkey Technology*

Accucaps Inc.

2001 HURON CHURCH ROAD, WINDSOR, ONTARIO N9C 2L6 CANADA

PHONE: (519) 969-5404 TELEX: 064-77665 FAX: (519) 969-7378

*Congratulations
and best wishes
for continued success
in all that you do.*

jfk. SYSTEMS INC.

3160 MOYNAHAN DRIVE
OLDCASTLE, ONTARIO N0R 1L0

(519) 737-1361
FAX 1-519-737-1041
VOICE MAIL BOX #223

HAWKER SIDDELEY

CONGRATULATIONS

**HAWKER SIDDELEY CANADA INC.
3 Robert Speck Parkway, Suite 700
Mississauga, Ontario
L4Z 2G5**



REMEMBER

IT'S BETTER ON THE BUS!

Your Most Economical Means of Travel
to
School, Work or just a
Leisurely trip around town.

Leave The Driving To Us.

For more information
call Customer Services
at 944-4111

QUALITY IS JOB 1

IT'S WORKING



*CAST ALUMINUM RESEARCH
& DEVELOPMENT*

ESSEX ALUMINUM PLANT

ESSEX ENGINE PLANT

WINDSOR ALUMINUM PLANT

WINDSOR ENGINE PLANTS

WINDSOR CASTING PLANT

*INTERNATIONAL DISTRIBUTION
OPERATIONS*

Congratulations
to
the Graduating Class.
Best Wishes
for
Continued Success.

WPP

WINDSOR PLASTIC PRODUCTS LTD.
6845 HAWTHORNE DRIVE WINDSOR, ONTARIO N8T 3B8

CONGRATULATIONS

TO THE
GRADUATES
OF
1 9 9 4



Responsible Care:
A Total Commitment®



DuPont Canada Inc.
WILL YOU BE ONE OF OUR RESOURCES?

DuPont Canada Inc., one of the largest chemical companies in Canada, provides a wide variety of products including Fibres & Intermediates, Specialty Plastics & Films, and Specialty Chemicals & Materials for the manufacturing, construction, health care and high technology markets, and direct consumer applications.

Safety and Concern & Care for the individual and the environment are among our most acclaimed corporate principles. Our philosophy of continuous improvement and dedication to quality and innovation are key to maintaining and improving our Relative Competitive Position in the changing Global marketplace. Since we believe business excellence and people excellence are interdependent, we constantly encourage job roles and working relationships that foster employees' interest and involvement in our operations. Our organization is self-managed and customer-driven while offering challenge and the opportunity for employees to unleash their talents and energies.

Committed to Employment Equity
One of the Financial Post 100 Best companies to work for in Canada

DuPont Canada Inc.
 Box 2200, Streetsville Postal Stn.
 Mississauga, ON
 L5M 2H3

One of the Financial Post
100 BEST
 COMPANIES TO WORK FOR IN CANADA

Committed to Employment Equity



DuPont Canada

Fax 519-733-6553

BEST WISHES



Pelee Island Winery
 455 Highway 18 East,
 Kingsville, Ontario,
 Canada N9Y 2K5

Bus: (519) 776-6898

Bus: (519) 733-6551

VIKING PUMPS



(A Unit of IDEX Corp.)

VIKING PUMP OF CANADA, INC.

661 GROVE AVENUE, P.O. BOX 398
 WINDSOR, ONTARIO N9A 6M3

MANUFACTURERS OF
 ROTARY GEAR PUMPS,
 REGENERATIVE TURBINE PUMPS,
 VERTICAL AND HORIZONTAL CENTRIFUGAL PUMPS.

FOR THE PAINT, ASPHALT, OIL, CHEMICAL,
 AND RUBBER INDUSTRIES.
 ALSO BOILER FEED PUMPS.

Please feel free to contact
 our Engineering Department for
 selection & application assistance.

MANUFACTURED IN WINDSOR, ONTARIO
 SINCE 1924.

Viking Pump of Canada, Inc.
 661 Grove Ave., Windsor, Ontario N9A 6M3 Canada
 Phone (519) 256-5438 Fax (519) 256-5070

Congratulations



WESTROC INDUSTRIES LIMITED

2424 Lakeshore Road West, Mississauga, Ontario L5J 1K4

Best wishes to
Windsor Engineering Students
from the Canadian Wood Council

The Council's technical literature, such as the *Wood Design Manual*, can help you to use structural wood products.



When you need to know about wood, call us.

Canadian Wood Council
Conseil canadien du bois

1730 St. Laurent Blvd.
Suite 350
Ottawa (Ontario)
K1G 5L1
tel: 1 800 463 5091
fax: 613 731 7899

The name

BEHIND THE NAMES YOU TRUST



KAO, MAY NOT BE A FAMILIAR NAME TO YOU, BUT IT IS TO MICROSOFT, LOTUS AND DOZENS OF OTHER TOP HARDWARE AND SOFTWARE MANUFACTURERS WHO HAVE PUT THEIR NAMES ON OUR DISKETTES. IN FACT, KAO'S REPUTATION FOR QUALITY AND PERFORMANCE HAS MADE US ONE OF NORTH AMERICA'S LEADING SUPPLIERS OF DISKETTES TO THIS MARKET. SO IF YOU'RE INTERESTED IN QUALITY AND RELIABILITY IN A LINE OF DISKETTES, DATA CARTRIDGES AND DATS, THERE'S ONLY ONE NAME TO LOOK FOR. KAO.

KAO

CRA Consulting Engineers
CONESTOGA-ROVERS & ASSOCIATES LIMITED

Specializing in :
Environmental & Municipal Engineering

651 Colby Drive, Waterloo, Ontario N2V 1C2 (519) 884-0510

CONGRATULATIONS
TO THE
GRADUATING
CLASS

FROM

CRA

Service Mold Inc.

2960 KEW DRIVE
WINDSOR, ONTARIO
N8T 3G7

*is proud to support
the pursuit
of*

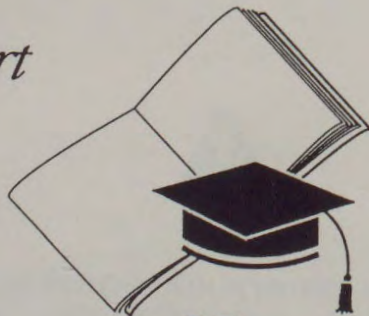

academic excellence

The General Motors of Canada, Windsor Trim and Transmission Plants wish all of you the best of luck in your studies!

You are the future! The foundation of General Motors is based on solid engineering.

We welcome you to your chosen profession and look forward in the future to seeing you at a career fair and in many of our GM dealerships.



MARK OF EXCELLENCE



TRI-MI MOULD (1990) INC.



1740 Moro Dr.
R.R. No.1
Windsor, Ontario
N9A 6J3

Telephone
(519) 737-1329
Fax (519) 737-1173

*is proud to support
the pursuit
of*

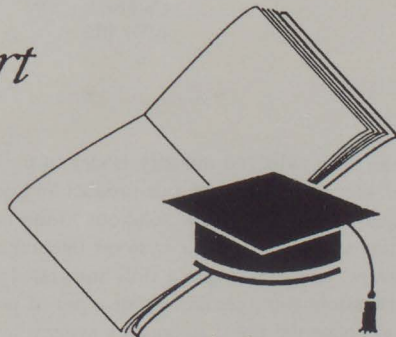

academic excellence

TRI-WAY

MACHINE LTD.

MANUFACTURES OF MACHINES AND SYSTEMS

ONE OF NORTH AMERICA'S LARGEST MACHINE TOOL MANUFACTURERS.
SERVING THE WORLD'S METAL CUTTING INDUSTRY WITH SOME OF THE
FINEST IN-LINE TRANSFER, PALLET TRANSFER, DIAL INDEX AND
FLEXIBLE MACHINING SYSTEMS EVER BUILT.

TRI-WAY MACHINE INC.

31200 STEPHENSON HWY.
MADISON HEIGHTS, MICH. 48071
TELEPHONE (313) 588-8244
FAX: (313) 588-8063



TRI-WAY MACHINE LTD.

6555 HAWTHORNE DRIVE
WINDSOR, ONTARIO N8T 3G6
TELEPHONE (519) 944-5600 or (313) 963-8982
FAX: (519) 944-9739



Automation Tooling Systems

250 Royal Oak Rd.
Cambridge, ON
N3H 4R6

Tel: (519) 653-6500
Fax: (519) 653-6533

ATS Inc. is an acknowledged industry leader in the design, manufacture and installation of factory automation systems. Our success is based on our product and our employees. The attention to detail and an ability to come up with unique designs to provide solutions to the manufacturing and precision assembly industry is responsible for our prominent place in robotic systems integration. Our staff of qualified engineers develop and design tooling and software, and turn it into a fully integrated automation systems. This ranges from a single robot workcell to full factory automation, combining all types of production machinery with our line of standard automation peripherals, to create the finest automation systems available in the industry today. Our business motto is basic: We want to be the best. Never sit back and take it easy no matter how successful we are, we can always be more so.

We extend our sincere congratulations to all of this year's graduating students and wish them success in their future endeavors.

