

Yale University

## EliScholar – A Digital Platform for Scholarly Publishing at Yale

---

YPFS Documents (Series 1)

[Browse by Media Type](#)

---

9-1-2011

### Payment, clearing and settlement systems in the CPSS countries

Bank for International Settlements (BIS)

Follow this and additional works at: <https://elischolar.library.yale.edu/ypfs-documents>

---

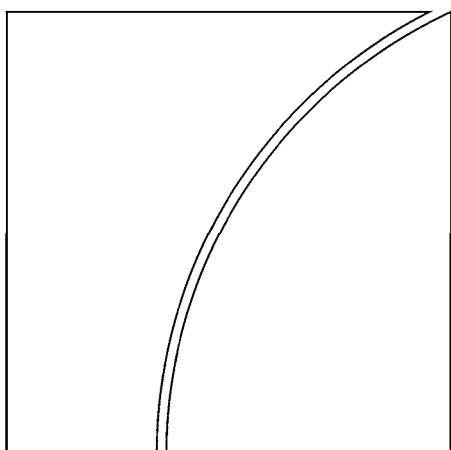
#### Recommended Citation

Bank for International Settlements (BIS), "Payment, clearing and settlement systems in the CPSS countries" (2011). *YPFS Documents (Series 1)*. 14534.

<https://elischolar.library.yale.edu/ypfs-documents/14534>

This Document is brought to you for free and open access by the Browse by Media Type at EliScholar – A Digital Platform for Scholarly Publishing at Yale. It has been accepted for inclusion in YPFS Documents (Series 1) by an authorized administrator of EliScholar – A Digital Platform for Scholarly Publishing at Yale. For more information, please contact [elischolar@yale.edu](mailto:elischolar@yale.edu).

# Committee on Payment and Settlement Systems



## **Payment, clearing and settlement systems in the CPSS countries**

Volume 1

September 2011



BANK FOR INTERNATIONAL SETTLEMENTS

Copies of publications are available from:

Bank for International Settlements  
Communications  
CH-4002 Basel, Switzerland

E-mail: [publications@bis.org](mailto:publications@bis.org)

Fax: +41 61 280 9100 and +41 61 280 8100

This publication is available on the BIS website ([www.bis.org](http://www.bis.org)).

© *Bank for International Settlements 2011. All rights reserved. Brief excerpts may be reproduced or translated provided the source is cited.*

ISBN 92-9131-877-9 (print)

ISBN 92-9197-877-9 (online)

## Foreword

The Committee on Payment and Settlement Systems (CPSS) publishes – under the aegis of the Bank for International Settlements (BIS) – reference works on the payment systems and other financial market infrastructures of various countries, widely known as Red Books.

The Red Book for the CPSS countries was last published in April 2003. After the enlargement of the CPSS to 24 countries in 2009, this edition of the Red Book for the CPSS countries is in two volumes. This first volume comprises 10 CPSS countries: Australia, Brazil, Canada, India, Korea, Mexico, Russia, Singapore, Sweden and Switzerland. The second volume, which covers Belgium, China, France, Germany, Hong Kong SAR, Italy, Japan, the Netherlands, Saudi Arabia, South Africa, Turkey, the United Kingdom and the United States and also has chapters on the euro area and international payment arrangements, is planned to be published in 2012.

Properly functioning financial market infrastructures enhance the stability of the financial sector, reduce transaction costs in the economy, promote the efficient use of financial resources, improve financial market liquidity and facilitate the conduct of monetary policy. I hope that this new edition of the CPSS Red Book will contribute to the general understanding and awareness of these issues by providing information on the arrangements in the CPSS countries.

I would like to thank all those who contributed to the publication of this Red Book by writing their country texts. Thanks also to the BIS staff for making this volume ready for publication, and particularly to David Maurer, who coordinated the production and led the process of editing the country texts.

William C Dudley  
Chairman  
Committee on Payment and Settlement Systems



**Central bank officials involved in the preparation  
of this volume of the Red Book**

<b>Reserve Bank of Australia</b>	Robert Lightfoot Nick Roberts
<b>Central Bank of Brazil</b>	Luciano Andrade Frois
<b>Bank of Canada</b>	Paul Miller
<b>Reserve Bank of India</b>	Gynedi Srinivas Nilima Ramteke
<b>Bank of Korea</b>	Yongo Kwon
<b>Bank of Mexico</b>	David Margolín Ricardo Medina Luis Lima Francisco Solís Luis Manuel de los Santos Alejandro de los Santos Alberto Mendoza
<b>Central Bank of the Russian Federation</b>	Elena Pak
<b>Monetary Authority of Singapore</b>	Jeryl Poh Ronald Sin
<b>Sveriges Riksbank</b>	Kristian Tegbring
<b>Swiss National Bank</b>	David Maurer Robert Oleschak
<b>Bank for International Settlements</b>	David Maurer Can Bülent Okay



## Contents

Foreword.....	iii
Central bank officials involved in the preparation of this edition of the Red Book .....	v

### **Payment, clearing and settlement systems in**

Australia.....	1
Brazil.....	55
Canada .....	103
India .....	145
Korea .....	205
Mexico .....	245
Russia.....	281
Singapore .....	325
Sweden.....	357
Switzerland .....	387





**Payment, clearing and  
settlement systems in  
Australia**



## Contents

List of abbreviations.....	5
Introduction.....	7
1. Institutional aspects.....	9
1.1 The general institutional framework .....	9
1.1.1 Institutions.....	9
1.1.2 Legislation.....	10
1.1.3 Other regulation .....	10
1.2 The role of the central bank .....	11
1.2.1 Payments system oversight .....	11
1.2.2 Securities clearing and settlement oversight .....	12
1.2.3 CLS Oversight Committee .....	13
1.2.4 Operational role .....	13
1.3 The role of other private and public sector bodies .....	14
1.3.1 Australian Competition and Consumer Commission (ACCC).....	14
1.3.2 Australian Securities and Investments Commission (ASIC) .....	14
1.3.3 Australian Prudential Regulation Authority (APRA) .....	14
1.3.4 Australian Transaction Reports and Analysis Centre (AUSTRAC).....	15
1.3.5 Council of Financial Regulators .....	15
1.3.6 Australian Payments Clearing Association (APCA).....	15
1.3.7 EFTPOS Payments Australia Limited (EPAL) .....	16
1.3.8 Financial Ombudsman Service (FOS) .....	16
1.3.9 Financial Sector Advisory Council .....	16
2. Payment media used by non-banks .....	16
2.1 Cash payments .....	17
2.2 Non-cash payments .....	17
2.2.1 Cheques and other paper-based instruments.....	17
2.2.2 Electronic credit transfers and direct debits .....	17
2.2.3 Payment cards.....	18
2.2.4 ATMs.....	20
2.2.5 Third-party bill payments.....	20
2.3 Recent developments .....	21
2.3.1 Payment patterns.....	21
2.3.2 Payment products .....	22
2.3.3 E-money.....	23

3.	Payment systems (funds transfer systems).....	23
3.1	General overview .....	23
3.2	Large-value payments systems.....	23
3.2.1	Reserve Bank Information and Transfer System (RITS).....	23
3.2.2	High Value Clearing System (HVCS).....	28
3.3	Retail payment systems .....	30
3.3.1	Card-based systems – proprietary .....	30
3.3.2	Card-based systems – scheme.....	34
3.3.3	Cheques.....	37
3.3.4	Retail credit and debit transfer systems – BECS .....	40
3.3.5	Retail credit and debit transfer systems – BPAY .....	41
3.3.6	Cash distribution and exchange.....	43
4.	Systems for post-trade processing, clearing and securities settlement.....	44
4.1	General overview .....	44
4.2	Post-trade processing systems .....	45
4.3	Central counterparties and clearing systems .....	45
4.3.1	ASX Clear .....	46
4.3.2	ASX Clear (Futures).....	48
4.4	Securities settlement systems.....	50
4.4.1	ASX Settlement.....	50
4.4.2	Austraclear .....	52
4.5	Use of the securities infrastructure by the central bank.....	54

## List of abbreviations

ACCC	Australian Competition and Consumer Commission
ACDES	Australian Cash Distribution and Exchange System
ADI	authorised deposit-taking institution
AML/CTF Act	Anti-Money Laundering and Counter-Terrorism Financing Act
APCA	Australian Payments Clearing Association Limited
APCS	Australian Paper Clearing System
APRA	Australian Prudential Regulation Authority
ASIC	Australian Securities and Investments Commission
ASX	Australian Securities Exchange
ASXCC	ASX Clearing Corporation Limited
ATM	automated teller machine
AUSTRAC	Australian Transaction Reports and Analysis Centre
BECS	Bulk Electronic Clearing System
CCP	central counterparty
CECS	Consumer Electronic Clearing System
CGS	Commonwealth Government Securities
CHESS	Clearing House Electronic Subregister System
COIN	Community of Interest Network
CSD	central securities depository
DVP	delivery versus payment
EFTPOS	electronic funds transfer at the point of sale
EPAL	EFTPOS Payments Australia Limited
ES Account	Exchange Settlement Account
HVCS	High Value Clearing System
MICR	magnetic ink character recognition
PSB	Payments System Board
RBA	Reserve Bank of Australia
RITS	Reserve Bank Information and Transfer System
RTGS	real-time gross settlement
SFE	Sydney Futures Exchange Limited



## Introduction

The Australian financial system comprises three broad groups of institutions. As of June 2010, banks authorised to operate in Australia account for around 58% of the assets of the financial system. Other financial intermediaries (including building societies, credit unions, money market corporations, finance companies and securitisers) hold about 9% of assets. Insurers and funds managers (such as life insurance offices, general insurers, superannuation funds and unit trusts) make up the remaining 33%.

Banks, building societies and credit unions are the principal providers of payment services in Australia. The Australian Payments Clearing Association (APCA), an industry body, has responsibility for the development and maintenance of industry rules and procedures for clearing and settlement in the major payments clearing systems. A new company, EFTPOS Payments Australia Limited (EPAL) has a central role in managing and promoting the domestic EFTPOS debit card system. Obligations arising between providers of non-cash payments services are settled through Exchange Settlement (ES) Accounts at the Reserve Bank of Australia (RBA).

In common with many countries around the world, the payments system in Australia has changed significantly in the past decade. In part, this has been a response to technological change and consumer behaviour, but it has also been the result of a comprehensive programme of reform.

Far-reaching changes to Australia's financial regulatory structure came into effect on 1 July 1998. These changes represented the Government's response to the recommendations of the Financial System Inquiry (the Wallis Committee), set up in 1996 to analyse the forces driving change in Australia's financial system and advise on ways to improve regulatory arrangements. Under the new structure, the RBA gained extensive regulatory powers to promote efficiency, competition and stability in the payments system under the *Payment Systems (Regulation) Act 1998*. The Government established a second board within the RBA – the Payments System Board (PSB) – to determine the Bank's payments system policy. Its responsibilities are set out in the amended *Reserve Bank Act 1959*.

The key risk reduction initiative in Australia was the introduction of a real-time gross settlement (RTGS) system in 1998. The reform eliminated the build-up of settlement exposures between financial institutions as a result of the exchange of high-value payments and transactions in debt securities. Instead, individual transactions involving different banks are settled in real time across accounts at the RBA. In 2002, Continuous Linked Settlement (CLS) Bank joined Australia's RTGS system, allowing foreign exchange transactions involving the Australian dollar to be settled through CLS.

The RBA has taken a number of steps to improve the competitiveness and efficiency of debit and credit card systems in Australia. In 2001, the RBA designated the Bankcard, MasterCard and Visa credit card systems under the *Payment Systems (Regulation) Act 1998*. After extensive consultation the RBA determined standards which lowered interchange fees and removed restrictions on merchants charging customers for use of credit cards, and imposed an access regime that facilitates entry by new players to the credit card market.

The interchange fee Standard requires the fees paid by transaction acquiring institutions to credit card issuing institutions to be no higher, on a weighted average basis, than a cost-based benchmark. Initially separate benchmarks were calculated for each scheme but, in 2006, the Standard was amended to provide for the calculation of a common benchmark to cover both the MasterCard and Visa schemes. The amended Standard does not apply to the Australian Bankcard scheme, which was closed at the beginning of 2007.

In 2004, the RBA designated the debit card system operated in Australia by Visa International and the EFTPOS debit card payment system in Australia as payment systems



under the *Payment Systems (Regulation) Act 1998*. After extensive consultation, the RBA determined Standards for the setting of interchange fees for both systems, and the removal of the “honour all cards” rule in the Visa system.<sup>1</sup> It also determined Access Regimes for the EFTPOS and Visa Debit systems.

The interchange Standards have led to lower interchange fees. In the case of the EFTPOS system, the Standard involves the adoption of a cap and floor on interchange fees. For Visa Debit, there is a cap on the weighted average interchange fee in that system.

During the development of these reforms, a MasterCard-branded debit card was released in Australia. The RBA indicated that this new “scheme debit” system would be subject to the same requirements as the Visa Debit system.<sup>2</sup> Both schemes were given the opportunity to voluntarily comply with the reforms. MasterCard provided an undertaking to this effect, but Visa did not. The interchange Standard and the Standard preventing “honour all cards” rules were therefore imposed formally on the Visa Debit system.

Over a two-year period, concluding in September 2008, the RBA conducted a wide-ranging review of its payment card systems reforms. The review concluded that the regulations relating to transparency, access and the removal of restrictions on merchants that had been introduced in the reform process should be retained. With regard to interchange fees, however, the RBA expressed a view that the enhanced competitive environment provided an opportunity to step back from formal regulation. It said that if the industry could provide it with comfort that interchange fees would not rise if regulation was lifted, it would be able to withdraw from interchange regulation. In the absence of such comfort, the Bank foreshadowed regulatory intervention to further lower interchange fees. The RBA indicated that it would assess progress in meeting its requirements in August 2009.

At that time, the Bank assessed that progress was not sufficient to warrant the lifting of regulation but was sufficient to delay, for the moment, a move to further lower interchange fees. The matter remains under review, with the Bank prepared to reopen consideration of the regulations in the light of industry developments. In the meantime, the Bank released for discussion a proposal to revise the EFTPOS interchange fee Standard to more closely align the regulatory treatment of international scheme and domestic (EFTPOS) debit cards.

Following consultation on this proposal, the EFTPOS interchange fee Standard was amended (effective 1 January 2010), capping the weighted average of any multilateral interchange fees in the EFTPOS system at the same level as for scheme debit. The amended Standard for the EFTPOS system left regulation of bilateral interchange fees unchanged, with fees paid from issuers to acquirers constrained to between 4 and 5 cents.

In 2008, the RBA designated the ATM system as a payment system under the *Payment Systems (Regulation) Act 1998*. After extensive consultation, the Bank determined an Access Regime for the ATM system. The Access Regime sets a cap on the connection cost that can be charged to new entrants to the ATM system and prohibits the charging of interchange fees except in specific circumstances. It also prohibits the charging of fees for establishing direct clearing/settlement arrangements and allows the Bank to exempt certain arrangements from compliance with aspects of the Regime where this is assessed to be in the public interest.

---

<sup>1</sup> This Standard allows merchants to make a separate decision on whether to accept Visa Debit cards rather than being required to accept these cards as a consequence of accepting Visa credit cards.

<sup>2</sup> The Visa International Debit card and MasterCard Debit card are referred to as “scheme debit”. In Australia the scheme debit cards operate through the separate four-party framework of the schemes whereas the PLUS and Maestro brands provide functionality overseas for the proprietary debit cards.

The Access Regime and complementary industry-based reforms were designed to: make the cost of cash withdrawals more transparent to cardholders and place downward pressure on the cost of ATM withdrawals; help ensure continued widespread availability of ATMs by creating incentives to deploy them in a wide variety of locations, providing consumers with choice and convenience; promote competition between financial institutions; and make access less complicated for new entrants, and therefore strengthen competition.

The reforms have resulted in significant changes to the way ATM transactions are charged, with customers being charged directly for withdrawals by the ATM owner while “foreign” fees have been eliminated.

The RBA also has responsibility under the *Corporations Act 2001* for setting *Financial Stability Standards* for Australian licensed clearing and settlement facilities. The RBA set two Standards in May 2003: one applying to central counterparties (CCPs) and one for securities settlement systems. Each Standard contains a number of measures and guidelines which set out matters that the RBA will assess in determining compliance with the relevant Standard. These measures and guidelines are similar to CPSS-IOSCO Recommendations.

The RBA has the power to vary or revoke existing Standards. In June 2005, the Standard for securities settlement systems was varied to exclude from its coverage those systems where the value of financial obligations settled in a financial year does not exceed Australian Dollar (AUD) 100 million.<sup>3</sup> This was to avoid capturing small systems that did not pose systemic concerns. In February 2009, one of the measures (Understanding risks) associated with the Standard was revised to give effect to disclosure of equities securities lending. At the same time, the Standard for CCPs was varied so that overseas-located CCPs providing services to Australian markets (and requiring an Australian licence) would be exempt from assessment against the Standard, provided they are subject to sufficiently equivalent regulation overseas.

## 1. Institutional aspects

### 1.1 The general institutional framework

Australia is a federation and both Federal (Commonwealth) and State legislation bear on aspects of the payments system and securities clearing and settlement systems.

#### 1.1.1 Institutions

In June 1998, the Commonwealth Parliament passed legislation that gave the **Reserve Bank of Australia (RBA)** explicit responsibility for regulating payment systems in Australia. Separate legislation, giving the RBA an explicit role in the regulation of securities clearing and settlement systems, was enacted in September 2001.

The **Australian Competition and Consumer Commission (ACCC)** is Australia’s competition regulator. The ACCC and the RBA both have responsibilities for promoting competition in the payments system and have agreed a Memorandum of Understanding to ensure a coordinated approach.

The **Australian Securities and Investments Commission (ASIC)** has responsibility for market integrity and consumer protection across the financial system, including payment transactions. ASIC and the RBA both have responsibilities in relation to clearing and

---

<sup>3</sup> At end-June 2010, 1 Australian Dollar bought 0.8523 US cents.

settlement facilities. A Memorandum of Understanding sets out a framework for cooperation between the two regulators in this area.

The **Australian Payments Clearing Association (APCA)** is a limited liability company which administers five clearing streams, covering: cheques; bulk electronic debit and credit payments; ATM and EFTPOS transactions; high value electronic payment instructions; and the exchange of cash between institutions. APCA also manages rules associated with an electronic network used to clear retail payments.

### 1.1.2 Legislation

The **Payment Systems (Regulation) Act 1998** gives the RBA powers to regulate payment systems and purchased payment facilities (such as stored value cards).

The RBA's policies under that Act are determined by its Payments System Board (PSB), which (under the **Reserve Bank Act 1959**) determines payments system policy.

The **Payment Systems and Netting Act 1998** allows the RBA to protect transactions in systems which settle on an RTGS basis from the potential application of the "zero hour rule". The Act also gives legal certainty to multilateral netting arrangements in the payments systems that are approved by the RBA. The effect of those protections is to ensure that authorised payment system rules operate according to their terms, ie payments are final and irrevocable. A system does not have to settle in central bank money to be an RTGS system for purposes of this legislation.

The **Corporations Act 2001** provides for a single licensing regime for "clearing and settlement facilities". Under the Act, the RBA is empowered to set financial stability standards for licensed clearing and settlement facilities and is required to monitor facilities' compliance with these standards and with their legislative obligation to reduce systemic risk. ASIC is responsible for all other legislative obligations imposed on clearing and settlement facilities.

The **Cheques Act 1986** establishes the framework under which cheques are drawn, accepted and paid.

The **Anti-Money Laundering and Counter-Terrorism Financing Act 2006** (the AML/CTF Act), which has substantially replaced the **Financial Transactions Reports Act 1988**, significantly enhanced Australia's regulatory scheme to detect and deter money laundering and terrorism financing. The AML/CTF Act sets out a principles-based framework, with higher-level obligations that encourage a risk-based approach to AML/CTF compliance. The **Proceeds of Crime Act 1987** makes money laundering an offence, and several supporting pieces of legislation provide for the confiscation of the proceeds of crime.

Provisions in the **Competition and Consumer Act 2010** dealing with restrictive trade practices and consumer protection are relevant to the operation of the payments system.<sup>4</sup> The Act prohibits conduct such as price agreements, boycotts and exclusive dealing with the purpose or effect of substantially lessening competition. However, the ACCC may authorise such conduct if it judges that it will result in a net public benefit.

### 1.1.3 Other regulation

The RBA has used its powers under the **Payment Systems (Regulation) Act 1998** to regulate payment systems by imposing Standards and Access Regimes upon them.

---

<sup>4</sup> The *Competition and Consumer Act 2010* was formerly known as the *Trade Practices Act 1974*.

Responsibility for the development and maintenance of industry rules and procedures for clearing and settlement in a number of major payments clearing systems rests with APCA, an industry body. These rules and procedures have been authorised by the ACCC.

## 1.2 The role of the central bank

As well as its responsibilities for monetary policy, financial stability and issuing Australia's currency notes, the RBA is responsible for the oversight and regulation of the payments system (see Section 1.2.1) and is empowered to set Financial Stability Standards for clearing and settlement facilities (see Section 1.2.2). The RBA also has an operational role in the payments system, including owning and operating Australia's RTGS system, RITS (see Section 3.2.1). It provides facilities for the final settlement of payments between financial institutions, serves as banker to the Australian Government and manages Australia's foreign exchange reserves (see Section 1.2.3).

### 1.2.1 Payments system oversight

The RBA is responsible for payments system oversight. An explicit mandate for payments system matters was provided through an amendment to the *Reserve Bank Act 1959* in 1998. Most of the RBA's powers and functions in the payments system derive from that amendment and the *Payment Systems (Regulation) Act 1998*.

The power to determine and carry out the policy of the RBA (other than payments system policy) is vested in the RBA's Board, which comprises the Governor as chair, its Deputy Governor, the Secretary to the Department of the Treasury and up to six other external members.<sup>5</sup>

The RBA's payments system policy is determined by its Payments System Board (PSB). This includes the exercise of responsibilities under the *Payment Systems (Regulation) Act 1998* and the *Payment Systems and Netting Act 1998*. The PSB comprises the Governor as chair, one other RBA appointee (appointed by the chair), an appointee from the Australian Prudential Regulation Authority (APRA) (appointed by APRA) and up to five other external members (appointed by the Treasurer). All members of the Board have equal voting rights.

The PSB's mandate is set out in the *Reserve Bank Act 1959*. The PSB is responsible for determining the RBA's payments system policy in a way that will best contribute to controlling risk in the financial system; promoting the efficiency of the payments system; and promoting competition in the market for payment services, consistent with the overall stability of the financial system.

While the PSB determines the RBA's payments system policy, the powers to carry out those policies are vested in the RBA. These powers are set out in three separate Acts,<sup>6</sup> of which the centrepiece is the *Payment Systems (Regulation) Act 1998*, under which the Bank may:

- “designate” a particular payment system as being subject to RBA regulation. Designation is simply the first of a number of steps the Bank must take to exercise its powers;

---

<sup>5</sup> The Secretary to the Treasury is the most senior public servant in the Department of the Treasury, which is the Australian Government Department that reports to Australia's Treasurer. The Treasurer's responsibilities within government include matters relating to the RBA. The external members of the Board are appointed by the Treasurer from the community but, to avoid conflicts of interest, can have no affiliation with authorised deposit-taking institutions. Members of the Board all have equal voting rights.

<sup>6</sup> The *Reserve Bank Act*, the *Payment Systems (Regulation) Act*, and the *Payment Systems and Netting Act*.

- determine rules for participation in a payment system, including rules on access for new participants;
- set Standards for safety and efficiency for any payment system. These may deal with issues such as technical requirements, procedures and performance benchmarks; and
- arbitrate on disputes in that system over matters relating to access, financial safety, competitiveness and systemic risk, if the parties concerned so wish.

The *Payment Systems (Regulation) Act 1998* also gives the RBA extensive powers to gather information from payment system participants and operators.

The Government's intent was that the Bank would treat these powers as "reserve powers", to be exercised if other means of promoting efficiency, competition and stability proved ineffective. Accordingly, the Government built considerable flexibility into the new regulatory regime. Under this co-regulatory approach, the private sector continues to operate its payment systems and may enter into cooperative arrangements, which may be authorised by the ACCC under the *Competition and Consumer Act 2010*. However, if the Bank believes that there may be benefits in exercising its formal powers in a system that it oversees to improve access, efficiency or safety, it may, as a first step, invoke its powers to designate that system. It may then decide, in the public interest, to set an Access Regime or impose Standards for that system. In doing so, the Bank is required to take into account the interests of all those potentially affected, including existing operators and participants. Full public consultation is required and the Bank's decision-making processes are subject to judicial review.<sup>7</sup>

The RBA also regulates holders of the stored value behind purchased payment facilities under a common regime with APRA.

APRA supervises stored value holders if they are authorised deposit-taking institutions or institutions that are deemed to be carrying on banking business because they offer a widely used purchased payment facility that is redeemable in whole or in part in Australian currency.

Other stored value holders may have an exemption issued by the RBA or they may offer a purchased payment facility, or a type of facility, to which the RBA has declared that the *Payments Systems (Regulation) Act 1998* does not apply.<sup>8</sup>

The RBA also oversees RITS. This is performed through ongoing monitoring, including of: associated risks, market behaviour, costs, and rules and regulations. RITS is also periodically assessed against the CPSS *Core Principles for Systemically Important Payment Systems*.

### **1.2.2 Securities clearing and settlement oversight**

The RBA is responsible for oversight of the stability of licensed clearing and settlement facilities.<sup>9</sup> Its powers in this area derive from the *Corporations Act 2001*. The RBA can set

---

<sup>7</sup> This designation process differs from regimes in other countries where payment systems are designated at inception as a means of imposing a regulatory regime and standards. The Australian approach is designed to allow market forces to determine payments arrangements with standards only imposed where there is a clear demonstration of market failure.

<sup>8</sup> Classes of facilities that have been declared not to be subject to the Act include gift cards, electronic toll devices and prepaid mobile phone accounts. Also, limited value schemes (liabilities less than AUD 10 million) and limited participant schemes (less than 50 persons are users) are exempt.

<sup>9</sup> Licences are granted by the Australian Government Minister responsible for the *Corporations Act 2001* on advice from ASIC.

*Financial Stability Standards* for clearing and settlement facilities. Under the regulatory framework, licensed facilities are required to comply with these Standards. Before determining the Standards, the RBA is required to consult with ASIC and with the clearing and settlement facilities that will be required to comply with the Standard.

### **1.2.3 CLS Oversight Committee**

The CLS Oversight Committee is a forum for central banks whose currencies are settled in CLS Bank<sup>10</sup> to coordinate and provide mutual assistance in oversight. The committee is organised and administered by the Federal Reserve System, which has regulatory and supervisory responsibility for CLS Bank. As CLS Bank settles transactions involving the Australian dollar, the Reserve Bank is represented on the Committee.

### **1.2.4 Operational role**

There are a number of aspects to the RBA's operational role in the payments system.

The final settlement of payments between financial institutions occurs across ES Accounts held at the RBA.<sup>11</sup>

Entities that provide third-party (ie customer) payment services or act as a CCP are eligible for ES Accounts. Institutions supervised by APRA, and which satisfy the RBA that they can manage their liquidity to meet their settlement obligations, are eligible for ES Accounts without special conditions. However, the RBA may impose collateral requirements on a transitional basis for institutions with only limited payments experience. Entities not supervised by APRA must satisfy the RBA of their capacity to meet settlement obligations and may be subject to special conditions.

Institutions currently holding ES Accounts are banks, special service providers for the credit union and building society industries, CCPs and some institutions that provide payment services to third parties but are not traditional financial institutions. Settlement of obligations between direct participants in payments arrangements occurs through these accounts.

The RBA owns and operates Australia's real-time gross settlement (RTGS) system, known as the Reserve Bank Information and Transfer System (RITS).<sup>12</sup> Access to ES Accounts is governed by RITS contractual arrangements. RITS also provides settlement functionality for batch settlement (ie net positions calculated by a Batch administrator) (see Section 3.2.1).

The RBA is responsible for the production and issue, reissue and cancellation of Australia's currency notes. However, it now plays a smaller role than formerly in the distribution arrangements for notes and coin. Commercial banks have an increased role in note distribution and inventory management. They own the working stocks of notes and coin and deal directly with each other to satisfy their demands and reduce their surpluses. These arrangements provide an incentive for more efficient recirculation of currency.

---

<sup>10</sup> For details on CLS (Continuous Linked Settlement) please refer to the corresponding section in the forthcoming second volume of this publication.

<sup>11</sup> This refers to the point at which obligations between direct participants in payment arrangements are extinguished. Provisions in the *Payment Systems and Netting Act* prevent transactions settled in an RTGS system, approved under that Act, from being unwound. This protection applies to any transaction settled on the day that a participant may fall under external administration regardless of the point of time that external administration commences. Similar provisions under this legislation prevent net obligations (even where settlement is yet to occur) from being unwound.

<sup>12</sup> RITS is an RTGS system providing settlement in central bank money. Conceptually other systems may operate on an RTGS basis through creation of interbank obligations, for example Austraclear (see Section 4.4.2).

The RBA also participates in the payments system as banker to a limited range of customers. It provides specialised banking services to the Australian Government, a range of government instrumentalities and a number of official international financial institutions and central banks.

### **1.3 The role of other private and public sector bodies**

#### **1.3.1 Australian Competition and Consumer Commission (ACCC)**

The ACCC is Australia's competition regulator. It is responsible for ensuring that private sector arrangements comply with the competition and access provisions of the *Competition and Consumer Act 2010*. It may exempt the conduct of organisations and arrangements from the competition provisions if it judges that there is a net public benefit in that conduct. It may also accept undertakings in respect of third-party access to essential facilities and arbitrate in negotiations over access in facilities that are declared services in terms of the *Competition and Consumer Act*. Private sector arrangements in the payments system, such as APCA, are subject to the *Competition and Consumer Act*.

The ACCC and the RBA both have responsibilities for promoting competition in the payments system and have agreed a Memorandum of Understanding to ensure a coordinated policy approach.

#### **1.3.2 Australian Securities and Investments Commission (ASIC)**

ASIC was established on 1 July 1998. It has responsibility for market integrity and consumer protection across the financial system, including payment transactions. It administers the *Corporations Act 2001* and regulates Australian corporations, financial markets, clearing and settlement facilities (in conjunction with the RBA – see Section 1.2.2) and financial service providers. The functions of ASIC include the oversight of financial market and clearing and settlement facility licensees, licensing of financial service providers (securities dealers and advisers), registration of auditors and liquidators, and investigating and enforcing corporate and securities law. A Memorandum of Understanding sets out a framework for cooperation between ASIC and the RBA.

#### **1.3.3 Australian Prudential Regulation Authority (APRA)**

APRA was established on 1 July 1998. It is the prudential regulator of the Australian financial services industry. It oversees banks, credit unions, building societies, general insurance and reinsurance companies, life insurance, friendly societies and most members of the superannuation industry.

APRA operates under the *Australian Prudential Regulation Authority Act 1998* and its powers derive from the *Banking Act 1959*, the *Insurance Act 1973*, the *Life Insurance Act 1995* and the *Superannuation Industry (Supervision) Act 1993*. The power to determine and carry out the policy of APRA is vested in its senior management (known as Members), who are appointed by the Government.

All authorised deposit-taking institutions (ADIs) (which include banks, building societies and credit unions) are supervised by APRA under one licensing regime and are covered by the same depositor protection provisions. If an ADI is, or is likely to be, unable to meet its obligations, APRA may assume control and carry on its business, or appoint an administrator, until its deposits are repaid or APRA is satisfied that suitable provision has been made for their repayment. If APRA believes that the institution will be unable to meet its obligations within a reasonable time period, it has the power to wind it up and distribute its assets, with depositors having first claim. The *Banking Act 1959* provides that the Australian

assets of an ADI shall be available to meet deposit liabilities in Australia in priority to all other claims, conferring a depositor repayment preference in the event of liquidation.<sup>13</sup>

APRA and the RBA have agreed a Memorandum of Understanding. APRA has a representative on the Payments System Board.

#### **1.3.4 Australian Transaction Reports and Analysis Centre (AUSTRAC)**

AUSTRAC is Australia's anti-money laundering and counter-terrorism financing (AML/CTF) regulator and specialist financial intelligence unit (FIU). In its regulatory role, AUSTRAC oversees compliance with the reporting requirements of the *Anti-Money Laundering and Counter-Terrorism Financing Act 2006* by a wide range of financial services providers, the gambling industry and other specified reporting entities and "cash dealers".<sup>14</sup> In its intelligence role, AUSTRAC provides financial transaction reports to Commonwealth, State and Territory law enforcement, security, social justice and revenue agencies, as well as certain international counterparts. AUSTRAC assists its partner agencies in the investigation and prosecution of criminal and terrorist enterprises in Australia and overseas.

#### **1.3.5 Council of Financial Regulators**

The Council of Financial Regulators is a non-statutory body chaired by the RBA and comprising the head and one other representative of the RBA, APRA, ASIC and the Commonwealth Treasury. Its role is to contribute to the efficiency and effectiveness of regulation by providing a high-level forum for cooperation and collaboration among its members. The Council is not a regulator in its own right.

#### **1.3.6 Australian Payments Clearing Association (APCA)**

APCA was established in 1992 to coordinate and manage development of industry policies and rules for a number of payments clearing arrangements.<sup>15</sup> APCA is a limited liability company, with a board of directors drawn from its shareholders, who are participants in its various clearing arrangements. Shareholders are the RBA, banks and the building society and credit union industry bodies. The costs of running APCA are met by members broadly in proportion to their importance in the payments arrangements, measured in terms of the volume of transactions cleared in each clearing stream. Other interested groups or individuals may join as associate members.

APCA manages five clearing streams whose rules have been authorised by the ACCC:

- the Australian Paper Clearing System (APCS) for cheques and other paper-based payment instructions;
- the Bulk Electronic Clearing System (BECS) for bulk electronic debit and credit payment instructions;
- the Consumer Electronic Clearing System (CECS) for ATM and EFTPOS payment instructions;

---

<sup>13</sup> APRA also administers the Financial Claims Scheme, under which, in the event of an insolvency of an ADI, protection is given to the first AUD 1 million per depositor. The Financial Claims Scheme is the Australian Government's deposit protection initiative enacted in October 2008 in response to the global financial crisis.

<sup>14</sup> As defined by the *Financial Transactions Reports Act 1988*.

<sup>15</sup> These contractual arrangements include system rules specifying participation requirements, message standards for bilateral file exchange and other bilateral payments instructions, minimum standards for participant operational reliability, procedures for calculating net obligations, time and manner of settlement, dispute resolution and procedures for handling a participant default.



- the High Value Clearing System (HVCS) for high-value electronic payment instructions; and
- the Australian Cash Distribution and Exchange System (ACDES) for the exchange of cash between institutions.

APCA also manages the rules associated with the Community of Interest Network (COIN) (see Section 3.3.3.7) used for the electronic clearing of APCS, BECS and CECS payments.

Each clearing stream is managed by a Management Committee drawn from the participants – typically banks, building societies and credit unions. The RBA is a member of some of these committees, namely those where it is a substantial player in the particular clearing arrangement. In addition, Advisory Councils and Stakeholder Forums have been established to provide organisations that are indirectly associated with payments clearing with an avenue of input to Management Committees. The RBA and APCA have agreed to a set of liaison procedures to ensure cooperation in payment systems oversight.

### **1.3.7 EFTPOS Payments Australia Limited (EPAL)**

EPAL was established in April 2009 to manage and promote the EFTPOS (proprietary debit) system. EPAL is wholly owned and funded by its members, which are the major participants in the EFTPOS system.

Decisions in relation to EFTPOS membership, participation, compliance, processing and the implementation of wholesale fees are made by EPAL.

EPAL scheme rules and the technical operational and security rules are approved by the Board of EPAL, with major amendments also requiring a special resolution of the members. The Board has eight industry-appointed directors, including representatives of both large and small financial institutions and large merchants, plus three independent directors drawn from a variety of private sector backgrounds and a managing director.

### **1.3.8 Financial Ombudsman Service (FOS)**

FOS is a free, independent dispute resolution scheme funded by participating providers of financial services.

The FOS facilitates resolution of disputes between customers (both individuals and small businesses) and service providers, including those relating to the payments system. The FOS may consider disputes where an individual claimant is claiming damages of up to AUD 280 000 and the service provider is unable to resolve the dispute through its internal dispute resolution procedures. The FOS has the power to make recommendations and awards that are binding on the service provider but not on the complainant, who retains the right to take legal action if he or she does not accept the ruling of the FOS.

### **1.3.9 Financial Sector Advisory Council**

The Financial Sector Advisory Council provides advice to Australia's Treasurer on financial sector developments and policies. Its members are drawn mainly from the private sector.

## **2. Payment media used by non-banks**

There are a wide range of media by which payments are made in Australia. Cash continues to be a popular form of payment for low-value transactions. Australia has well established debit and credit card networks that have become the main means, other than cash, by which Australian consumers make payments. Cheque use is in decline, but remains common for business payments. Reliance on cheques has been reduced by growth in the use of debit

and credit cards, and electronic credit and debit transfers (at the retail level), and by RTGS (for wholesale payments). Credit transfers and direct debits are also used widely by governments and businesses. The vast majority (by number) of payments in Australia are for low-value transactions; however, these make up only a small percentage of the value of transactions. Like most other countries, Australia has experienced a move away from over-the-counter and paper-based transactions towards electronic payments.

## **2.1 Cash payments**

Currency continues to be a convenient and popular form of payment for everyday, low-value transactions. A consumer study undertaken by the RBA in 2007 indicated that, at that time, around 70% of the number of consumer payments, and 38% of the value, were undertaken using cash. Cash was particularly important for small transactions, accounting for nearly all payments under AUD 10 and close to 90% of transactions under AUD 25. The ratio of currency to GDP is relatively steady at around 4%.

Coin is produced by the Royal Australian Mint in 5 cent, 10 cent, 20 cent, 50 cent, AUD 1 and AUD 2 denominations and is issued to meet demand as forecast by financial institutions. The RBA issues Australian currency notes based on its forecasts of demand. Currency notes are printed by Note Printing Australia Ltd, a wholly owned subsidiary of the RBA. Notes are issued in denominations of AUD 5, AUD 10, AUD 20, AUD 50 and AUD 100. All notes are printed on polymer substrate and incorporate a number of security features that make them highly resistant to counterfeiting.

## **2.2 Non-cash payments**

### **2.2.1 Cheques and other paper-based instruments**

Cheque use has been rapidly declining in recent years. In 2009/10 (ie year ended June 2010), cheques accounted for less than 12% of the value and 5% of the number of non-cash payments, down from around 17% and 11% respectively in 2004/05. The *Cheques Act 1986* allows cheques to be drawn on authorised deposit-taking institutions (ie banks, building societies, credit unions and special service providers). Many smaller financial institutions provide cheque issuance facilities to their customers through arrangements with a bank. Cheques are not commonly used for payments at the point of sale in Australia. They are used more frequently for bill payments and for business-to-business payments.

Banks also use warrants, which are irrevocable paper-based payment instruments, for some transactions between themselves. Warrants are limited, by industry agreement, to values of less than AUD 500 000.

### **2.2.2 Electronic credit transfers and direct debits**

Electronic credit transfers and direct debits are long-established forms of making payments in Australia. Most of these transactions are made using the framework set by the rules of the Bulk Electronic Clearing System (BECS) but credit transfers are also made through a separate bank-owned system, BPAY.

BECS credit transfers and direct debits are generally initiated from files containing batches of payment instructions compiled by paying or payee institutions or their agents and passed on to their sponsoring financial institutions. BECS is used widely, especially by government departments and companies, for regular payments such as social security benefits, salary and dividend payments and payment of bills.

BPAY is a bill payment system where transfers are mainly initiated by customers, both individuals and businesses, using the telephone or internet. BPAY aggregates the instructions into files for transfers between participating institutions.

In BECS, electronic files of payment instructions are exchanged bilaterally, whereas BPAY payment instructions, as for credit transfers in many countries, are processed through a central automated clearing house. Sections 3.3.4 and 3.3.5 describe arrangements for clearing and settlement of BECS and BPAY transfers.

In 2009/10, more than 1.7 billion credit transfers were made, with a value of AUD 6 422 billion. They represented about 27% of the number and 49% of the value of retail non-cash payments. This compares with 1.2 billion credit transfers in 2004/05, worth AUD 4 580 billion. BECS credits were 84% of the transfers by value in 2009/10 while the remaining 16% were BPAY transfers.

A large number of BECS credits are made by government departments, and these include unemployment and other welfare payments. The RBA's Government Direct Entry Service performs these transfers through BECS. The service uses high-speed data links to gather payments data from government agencies which, after amalgamation, verification and sorting, are distributed electronically to relevant financial institutions. Around 275 million transactions were processed in 2009/10, up from around 265 million transactions in 2004/05.

Direct debits across BECS mostly originate from billers, such as insurance and utilities companies when collecting regular payments, or from financial institutions when collecting loan repayments. Some large enterprises also use direct debits to collect payments from their commercial clients and such payments may be for large amounts. Under these debit arrangements, payers give financial institutions authority to debit their accounts at the initiative of nominated payees.

There were about 665 million direct debits in 2009/10 (474 million in 2004/05), with a value of around AUD 4 970 billion (AUD 3 323 billion in 2004/05). This represented about 11% of the number and 38% of the value of retail non-cash payments.

### **2.2.3 Payment cards**

The use of payment cards continues to grow steadily in Australia.

Debit cards allow access to deposit funds in customers' accounts. In Australia, banks, credit unions and building societies are the main issuers of debit cards, which can be used in ATMs, and EFTPOS terminals. At the end of June 2010, there were 42.6 million Australian-issued debit cards which could be used to access more than 33 million deposit accounts. Debit cards were used to make 830 million ATM withdrawals in 2009/10, up from 775 million in 2004/05; and 2 123 million purchase or point of sale cash-out transactions, up from 1 147 million transactions in 2004/05. Combined, these transactions totalled AUD 292 billion in 2009/10 and AUD 209 billion in 2004/05.

There are two main types of debit cards issued in Australia: those issued for access to the proprietary domestic Australian EFTPOS system, and those issued as international scheme cards. In Australia, EFTPOS system cards require Personal Identification Number (PIN) authorisation to initiate electronic transactions. Transactions are debited from customers' accounts in real time. Payment to the merchant is guaranteed by the acquiring bank for authorised transactions. Many merchants also offer a cash-out facility to cardholders making purchases. Terminals operate whenever the merchant is open; for some merchants, such as petrol stations, this is 24 hours a day, seven days a week. Many EFTPOS terminals are integrated with retailer cash registers. There were 712 434 EFTPOS terminals in Australia in June 2010, up from 518 532 terminals in June 2005.

Proprietary debit cards are issued by most sizeable retail financial institutions in Australia, and all these cards are accepted at all merchants that have EFTPOS terminals. The

proprietary debit cards under the EFTPOS brand cannot be used in situations where the card is not present at the merchant, such as payments over the telephone and internet. They also cannot be used outside Australia without prior arrangements with an international scheme.

Debit cards issued under the MasterCard and Visa brands are authorised with a signature or PIN (the latter method is replacing the former over time) at the point of sale and can be used over the telephone, internet and internationally. In Australia, EFTPOS system cards are the dominant type of debit card, although issuance of international scheme branded debit cards is growing. Most MasterCard and Visa branded debit cards are multifunction cards providing access to both the EFTPOS system and the international scheme.

The RBA undertook reforms to the EFTPOS system for proprietary debit cards and the debit card system operated by Visa in September 2006. MasterCard provided a voluntary undertaking to comply with the Visa Debit Standards. These reforms capped the level of scheme debit interchange fees; set a cap and floor to bilateral EFTPOS system interchange fees; removed the requirement that merchants accepting scheme credit cards also accept scheme debit cards; allowed merchants to surcharge customers using scheme debit cards for payment; and liberalised access arrangements for the EFTPOS system, in conjunction with an EFTPOS Access Code developed by APCA. From January 2010, the RBA established a separate cap for multilateral EFTPOS interchange fees.

*Credit cards* are issued mainly by banks. The most common brands are MasterCard and Visa. Four banks also issue American Express credit cards, as does American Express itself. Australia's original national credit card scheme was a local brand, Bankcard, introduced in 1975. After experiencing many years of declining market share, it closed in the first half of 2007.

Credit cards provide prearranged revolving credit, up to a specified limit. Payments for goods and services and withdrawals of cash are made against the line of credit. About 330 different types of cards are available from over 70 issuers. The features on offer may include: an interest-free period of up to 55 days; an annual fee (ranging from around AUD 24 to AUD 1 200 per annum); and a loyalty scheme. In recent years a number of new credit card products have been offered, including low interest rate cards and complementary American Express cards with existing MasterCard/Visa accounts.

At the end of June 2010, there were 20.5 million Australian-issued credit and charge cards which could be used to access 14.6 million credit and charge card accounts, compared to 15.6 million cards and just under 12 million accounts in June 2005. During 2009/10, credit and charge cards were used to make 29 million cash withdrawals (total value AUD 11 billion) and 1 530 million non-cash transactions, with a value of around AUD 222 billion. The use of credit cards for cash withdrawals has declined in recent years, with 37 million cash withdrawals and 1 169 million non-cash transactions, worth around AUD 153 billion, made in 2004/05.

The RBA introduced reforms to the credit card schemes beginning in August 2002. These reforms set standards that cap the level of interchange fees, allow merchants to surcharge customers using credit cards for payment and liberalise access arrangements for credit card schemes. Survey data show that surcharging by merchants has grown strongly in recent years; in June 2010 26% of surveyed merchants imposed a surcharge on at least one of the credit cards they accepted.<sup>16</sup>

---

<sup>16</sup> *East & Partners (2010) Australian Merchant Acquiring & Cards Markets: Special question placement report prepared for the Reserve Bank of Australia, June.*

*Charge and retailer cards*<sup>17</sup> allow payment to be deferred from the date of purchase until the account due date; some provide revolving credit. In some instances, the card may be linked to a separate line of credit through an account with a financial institution. In recent years, some of the major offerings have been replaced by co-branded cards from the international schemes.

*Prepaid cards* have a small but growing presence in the Australian payments market. They take a variety of forms: reloadable or not reloadable; linked to an account in the name of the cardholder or non-specific account; limited to use at a single merchant (or defined group of merchants) or able to be used widely. Some vendors also market reloadable cards as an alternative to traveller's cheques, debit cards and credit cards when travelling overseas, and may sell cards denominated in foreign currencies. Prepaid cards with wide acceptance are currently issued by authorised deposit-taking institutions under the auspices of one of the international card schemes.

#### **2.2.4 ATMs**

Automated teller machines (ATMs) were introduced on a wide scale in 1981. Financial institutions and independent deployers developed their own ATM networks. While they remained owned and controlled by individual institutions and sometimes groupings of institutions, over time mutual access arrangements were developed. By 2001 all the individual networks allowed access to all cardholders throughout Australia. ATMs allow cash withdrawals and account balance enquiries; some also provide facilities for deposits, transfers between accounts and ordering of cheque books and statements. There are no general legal restrictions on the location or number of machines, other than some location restrictions in casino or poker machine gaming areas in some states. Operators have agreed to meet standards established by Standards Australia covering design and placement. Most are capable of operating 24 hours a day but in many locations access is only available during business hours. ATM transactions can be initiated by debit cards and certain credit, prepaid and charge cards and are authorised using a PIN. In June 2010, there were 28 764 ATMs across Australia with about 53% owned by financial institutions and the remainder by independent deployers. By comparison, in June 2005 there were 23 472 ATMs in Australia.

The RBA has introduced reforms to the ATM system. These reforms set a cap on the connection cost that can be charged to new entrants to the system and prohibit the charging of interchange fees except in specific circumstances. In conjunction with complementary industry-based actions, the reforms have resulted in significant changes to the way ATM transactions are charged, with customers now charged directly for withdrawals and balance enquiries by the ATM owner while "foreign" fees – charged by the customer's own institution when using a card in another institution's ATM – have been eliminated.

#### **2.2.5 Third-party bill payments**

The main providers of third-party bill payment services are Australia Post, the national postal service, and BPAY, a bank-owned service company (see Section 3.3.5).

Australia Post provides bill payment services for around 1 000 billers. Payments can be made by telephone, the internet or over the counter at Australia Post outlets, although not all billers accept payment using all three of these options. Over-the-counter payments can be made using cheques, cash, and debit and credit cards. Australia Post processes bill payments into billers' nominated bank accounts.

---

<sup>17</sup> Also called travel and entertainment, store and private label cards.

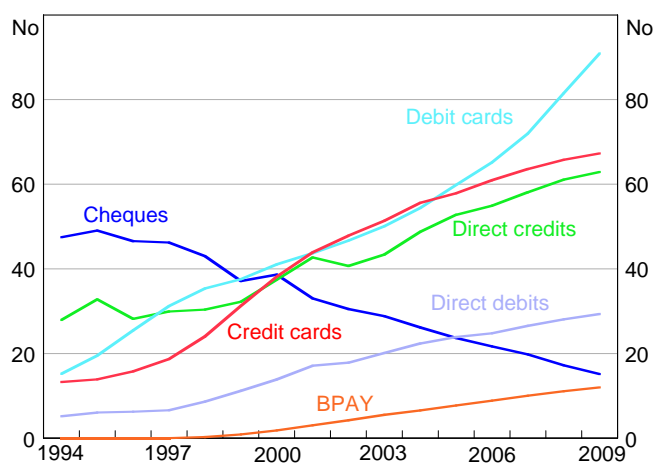
BPAY facilitates bill payments by allowing customers of participating financial institutions to arrange for the transfer of funds from their deposit or credit card account using phone banking or internet banking services. Over 87% of BPAY transactions are now initiated via the internet. There are more than 18 000 billers and over 160 financial institutions participating in BPAY. BPAY also offers an electronic bill presentment service called BPAY View.

## 2.3 Recent developments

### 2.3.1 Payment patterns

Recent years have seen a continuation of the trend towards electronic payments that has been evident for the past two decades or so (Graph 1). The number of cheques written in 2009 was less than half that in 2000. While comprehensive data on the use of cash are not available, the value of cash withdrawn over the counter at branches of financial institutions, through ATMs and by cash-outs on credit and debit cards has generally grown more slowly than the value of consumption over recent years. In contrast, the value and number of credit and debit card, BPAY and direct entry transactions have all grown considerably faster than consumption.

Graph 1  
Non-cash payments per capita<sup>1</sup>  
Per year

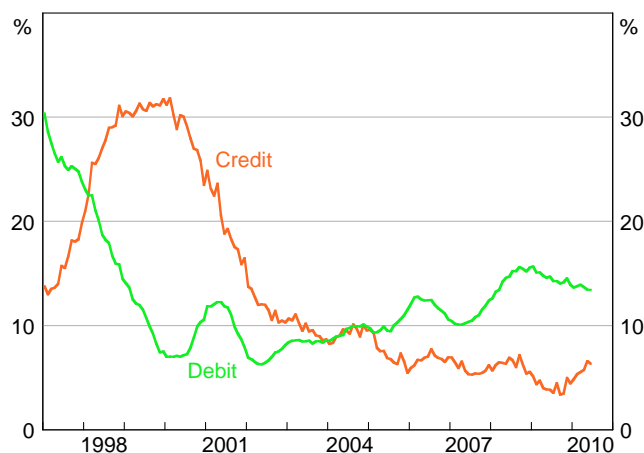


<sup>1</sup> Apart from BPAY, data from 2002 onwards are based on the RBA's Retail Payments Statistics. Data for earlier years come from APCA and the RBA, and have been adjusted for differences between these sources and the Retail Payments Statistics.

Sources: ABS; APCA; BPAY; RBA.

Over the past few years, both the value and number of debit card transactions have grown more quickly than those for credit cards (Graph 2). This is a reversal of the pattern seen from the late 1990s, when growth in credit card spending was particularly rapid. Although the number of debit card transactions is greater than the number of credit card transactions, total spending on credit cards remains significantly higher, reflecting the larger average size of credit card transactions.

Graph 2  
**Number of card payments<sup>1</sup>**  
 Year-on-year growth



<sup>1</sup> RBA credit card data prior to March 2008 adjusted to remove BPAY transactions.

Sources: BPAY; RBA.

According to 2010 survey data from Roy Morgan Research, a market research company, around 94% of adults hold a debit card of some sort, compared with 47% who hold a credit or charge card.

The combined market share of the MasterCard and Visa schemes was 85% of the value of credit and charge card transactions in 2009. Market shares have generally been relatively stable, with the exception of periods in 2004 and 2009 when major banks began issuing American Express credit cards.

### 2.3.2 *Payment products*

Over recent years, there have been a number of new card products offered to consumers. These include:

- the introduction of prepaid cards by the major credit card schemes. These cards take a variety of forms; for example, gift cards can be used at almost any merchant that accepts MasterCard or Visa credit cards, but are typically non-reloadable and allow purchases only. In contrast, general-purpose prepaid cards may be reloadable and allow cash withdrawals at ATMs. Prepaid travel cards may also be denominated in foreign currencies, with some cards allowing multiple currencies to be loaded; and
- a proliferation of new credit card types, including premium and super-premium cards that attract significantly higher interchange fees. At the same time, there has been much greater variation in the card features offered to customers, including low interest rate cards and new structures for rewards cards. Some issuers provide complementary American Express cards with existing MasterCard/Visa credit accounts, while merchant co-branded cards have also emerged.

### **2.3.3 E-money**

Several internet payment systems have also begun operations over recent years, including PayPal, which holds member accounts for online transactions, funded by either a direct debit from a deposit account with a financial institution or by a credit or scheme debit card payment. PayPal is an authorised deposit-taking institution in Australia. Other online payment systems include PayMate, which does not hold customer accounts but funds transactions with a credit or scheme debit card payment, and Payclick, which provides micro payments from a prepaid account.

## **3. Payment systems (funds transfer systems)**

### **3.1 General overview**

Retail payments clearing systems account for 99% of the number of non-cash transactions in Australia although only about 20% of the value. The Australian Payments Clearing Association (APCA) administers: the Australian Paper Clearing System (APCS) for cheques and other paper instruments; the Bulk Electronic Clearing System (BECS) for credit transfers and direct debits; and the Consumer Electronic Clearing System (CECS) for ATMs and EFTPOS payments. There are separate clearing arrangements for the four party credit and debit card schemes (Visa, MasterCard) operating in Australia, and for BPAY.

Settlement of obligations arising from the clearing of instruments in each of these systems is on a deferred net basis with batch settlement completed in RITS each morning at 9 am across ES Accounts at the RBA.

The RTGS system operated by the RBA settles payments arising from a range of sources. There were around 32 000 transactions each day in 2010, which accounted for about 80% of the value of non-cash payments. These payments arose from foreign exchange settlements using correspondent banks, payments relating to settlement of foreign exchange transactions through CLS Bank, the cash leg of securities markets trading, and large-value customer related payments.<sup>18</sup>

The institutions that participate in the RTGS system are members of RITS (see Section 3.2.1). They participate under RITS contractual agreements with the RBA. RITS accepts proprietary payments instructions as well as payments instructions from two feeder systems: Austraclear and the closed user group administered by APCA under the High Value Clearing System (HVCS) arrangements (see Section 3.2.2).

There is also a cash distribution system, the Australian Cash Distribution and Exchange System (ACDES), which operates under rules and procedures administered by APCA (see Section 3.3.6).

### **3.2 Large-value payments systems**

#### **3.2.1 Reserve Bank Information and Transfer System (RITS)**

Australia's RTGS system is RITS.

---

<sup>18</sup> Including transactions conducted by the RBA in the implementation of monetary policy.



### 3.2.1.1 Institutional framework

The RITS Regulations and Conditions of Operation (RITS Regulations) provide the legal structure for RITS. The RITS Regulations set out the rules for the operation of RITS and the rights and obligations of participants and the RBA. The legal basis of RITS is established by contract, and standard agreements are executed to bind each party to the RITS Regulations.

RITS is owned and operated by the RBA. The RBA is also responsible for the oversight of RITS. The governance structure of the RBA ensures there is a clear delineation between departments concerned with oversight and those responsible for day-to-day operations, customer relations and the development of RITS, including separate reporting lines. The governance of RITS is accountable and transparent to participants and other relevant parties. Information about RITS and its governance structure is published on the RBA's website and users and other parties are consulted in relation to prospective changes to RITS.

The RBA conducts its oversight of RITS through ongoing monitoring, including of associated risks, market behaviour, costs, and rules and regulations. RITS is continually monitored against the *Core Principles for Systemically Important Payment Systems*. The Bank periodically publishes an updated assessment.

### 3.2.1.2 Participation

Membership of RITS is available upon application to the RBA. Membership is mandatory for all ES Account holders. Eligibility criteria for ES Accounts are established by the Payments System Board and published online. These criteria are designed to enhance competition in the provision of payment services by allowing all domestic providers of third-party payment services access, irrespective of their institutional status.<sup>19</sup>

Australian-authorized banks are required to hold an ES Account for the settlement of their high-value transactions through RITS. However, ES Account holders whose total payments in RITS account for less than 0.25% of the total value of RTGS payments may apply to the RBA to settle their payments through an agent.<sup>20</sup> Nevertheless, ES Account holders using an agent are required to have an ES Account set up in RITS for contingency purposes.

In addition to ES Account holders, some non-bank members of RITS participate as non-transaction members (ie they do not make or receive RTGS payments directly). This arises from a requirement that eligible counterparties for the RBA's Open Market Operations must be RITS members, notwithstanding that settlement may occur through an agent.

As at end-2010, there were 93 RITS members, 71 of which held ES Accounts (56 banks and 15 other institutions) with the remaining 22 participating as non-transaction members.

### 3.2.1.3 Types of transactions

Payments instructions settled through RITS can be submitted either through the RITS proprietary network or via two external feeder systems: the HVCS, which is a SWIFT closed user group administered by APCA, or Austraclear, which is a securities settlement system

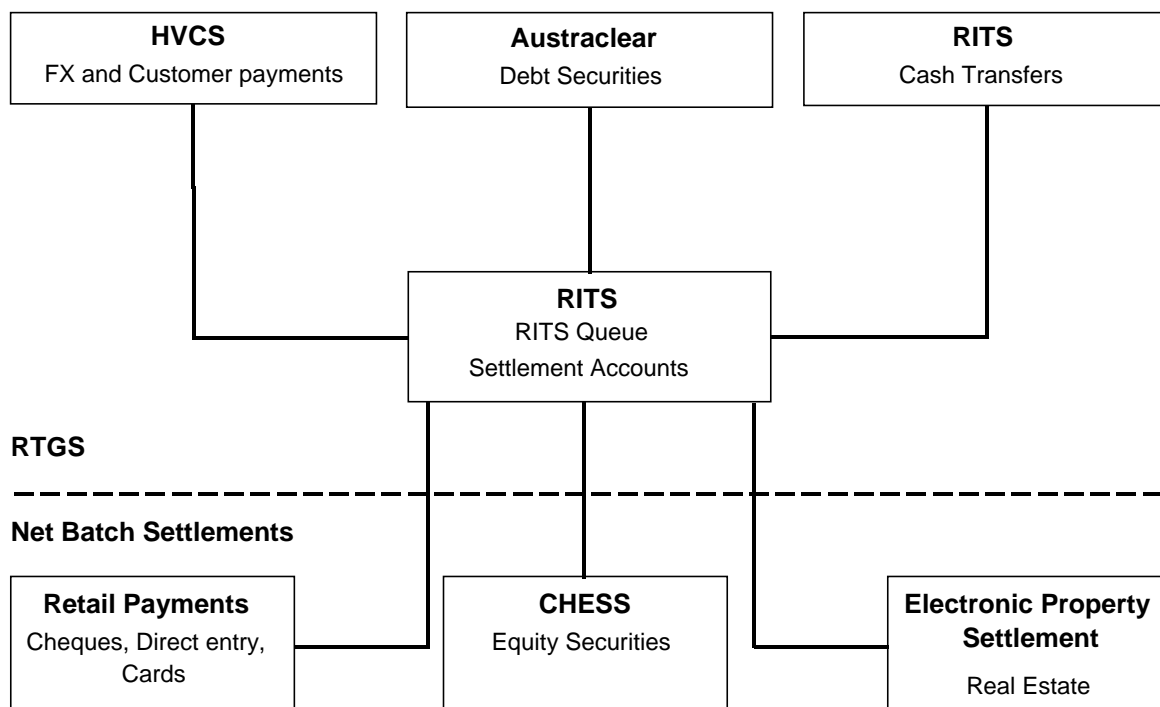
---

<sup>19</sup> The Reserve Bank does not permit ES Account holders to outsource the operation of their accounts, ie the ability to make or receive payments instructions cannot be outsourced. Furthermore, the Reserve Bank requires that ES Account holders maintain operational staff throughout RITS operating hours that may be immediately contactable by the Bank in the event of a contingency. In practice, this requires a domestic presence.

<sup>20</sup> This represents a relaxation of an earlier policy in recognition of the fact that a number of new bank entrants did not have sufficient potential scale to justify establishing the necessary back office systems and staff to operate an ES Account. The original policy was designed to prevent accrual of obligations between banks that can arise from indirect participation. The setting of 0.25% represents a trade-off between these two factors. In practice, most eligible banks have not migrated to agency arrangements.

operated by the Australian Securities Exchange (ASX). In addition, RITS provides (non-RTGS) settlement functionality for the simultaneous debit and credit of obligations arising from low-value netting arrangements (ie retail transactions for which obligations are calculated on a multilateral net basis so that the sum of all positions is zero). These net positions are entered for settlement either outside RTGS open hours (at a 9 am window for APCA systems; see Section 3.2.1.4) or within the RTGS day, following submission of a Batch by a Batch Administrator, at a time that RITS identifies that all participant obligations can be simultaneously met from credit funds.

Figure 1  
Access to RITS



There are three main categories of RTGS payment transactions settled across ES Accounts:

- The cash leg of wholesale debt securities settlements (and some money market cash transactions) undertaken in Austraclear (see Section 4.4.2).
- The Australian dollar leg of foreign exchange transactions, either AUD flows arising from CLS or correspondent bank settlements and other large-value SWIFT transactions. These are made through the HVCS (see Section 3.2.2). The HVCS is also termed the SWIFT Payment Delivery System (PDS).
- Interbank payments instructions (known as “cash transfers”), including interbank money market transactions. These are entered directly into RITS as “proprietary” RITS instructions.<sup>21</sup>

<sup>21</sup> There are no prescriptive requirements for particular types of RTGS transactions to be submitted to RITS by any particular channel, nor are retail or other types of payments prohibited. However, delivery-versus-payment settlement of securities occurs through Austraclear, CLS is a member of the HVCS for the purpose of making and receiving payments and RITS proprietary transactions do not provide for customer identifiers (ie RITS

RITS settles batches of interbank obligations that arise from a number of low value exchanges of payments. Participant obligations that arise from customer retail payments (cheque, cards and direct entry) are settled on a deferred multilateral net basis in RITS at 9 am each business day. Interbank obligations from the cash side of equities transactions are also settled through RITS on a multilateral net basis: equities transactions are processed through the ASX's Clearing House Electronic Subregister System (CHES) (see Section 4.1) and submitted to RITS for settlement in the CHES batch at around midday each day. Additionally, RITS provides functionality for batch settlement of real estate transactions for which net settlement amounts are entered through Austraclear. This facility has not been widely used yet.

#### 3.2.1.4 Operation of the system and settlement procedures

Within RITS, transactions settle in central bank money over ES Accounts, which must be maintained in credit at all times. Non-transaction RITS members do not have ES Accounts and must settle any payments through an agent.

The technical requirements for participation in RITS are set out in the RITS Regulations. Participants access RITS either by the Austraclear National Network Infrastructure (ANNI, Austraclear's proprietary network) or through the internet. Access via the internet and ANNI is encrypted end-to-end using the SSL protocol, with unique logins and digital certificates (stored on hardware tokens) using a secure process.

RITS operating hours for settlement are 7.30 am to 6.30 pm each business day Australian Eastern Standard Time and from 7.30 am to 8.30 pm during Australian Eastern Daylight Time (the first Sunday in October to the first Sunday in April). Prior to 8.45 am, settlement is limited to RITS cash transfers and interbank Austraclear transactions. This enables ES Account holders to fund debit positions in the 9 am batch and their subsequent daily RTGS payment obligations. RTGS settlement temporarily ceases at 8.45 am to allow the 9 am batch to run. The Daily Settlement session begins at 9.15 am, with RTGS settlement recommencing. At 4.30 pm, the main day session ends and there is a 45 minute settlement close session in order to enable the settlement of remaining queued transactions. After this, there is an evening settlement session, designed to facilitate CLS Bank settlement, in which "evening agreed" settlement participants continue sending and receiving SWIFT instructions.<sup>22</sup> The RBA retains discretion to vary the operating hours of RITS.

RITS is designed to be liquidity efficient and intraday liquidity is available through an intraday repurchase agreement facility provided by the RBA (see Section 3.2.1.5). RITS incorporates a central queue and offset functionality. Prior to settlement, RTGS transactions are entered into RITS where they proceed to the RTGS queue. Transactions are tested for settlement by RITS to ensure that the paying participant member has sufficient funds in its ES Account to cover the payment. Transactions that pass all tests are settled, while those unable to be settled at that time remain on the queue. The next transaction on the queue is then tested for settlement in a "next down looping" process. The "settle or leave" process allows transactions to be settled in any order and provides for very efficient use of liquidity.

---

proprietary transactions result in debits and credits to participant ES Accounts only). The money market in this context is an over-the-counter mechanism by which ES Account holders with surplus liquidity (noting that ES Accounts attract a below market interest rate) lend to ES Account holders with a potential deficit of liquidity. Proprietary and customer transactions drive changes to projected end-of-day balances that influence the distribution of system liquidity and the money market.

<sup>22</sup> All Australian CLS settlement members need to participate in the evening session. Other banks make a decision to participate or not based on their business requirements. For banks that are not "evening agreed", the SWIFT day finishes at the end of the settlement close session at 5.15 pm.

Redistribution of liquidity is also facilitated by a gridlock-preventing feature known as “Auto-offset”. When a payment from a member has been unsettled on the queue for one minute or more, RITS automatically searches the RTGS queue for offsetting payments from the receiving member. If these offsetting payments can be settled simultaneously, leaving both parties in credit, RITS will do so automatically (the gross amounts of all payments are posted to the relevant accounts at the same time). Targeted Bilateral Offset functionality also allows two RITS members to select transactions for offset against each other, thus assisting in client credit management at the same time as enhancing the efficient use of system liquidity.

RITS also utilises a “sub-limit” feature enabling participants to determine how a payment draws on liquidity. Participants may mark the status of payments submitted to RITS as either “priority”, “active” or “deferred”. The sub-limit reserves liquidity for the settlement of priority payments – these payments marked are tested against the full balance of the participant’s ES Account. Payments with a status of active are only tested against balances above the sub-limits, while deferred payments are not tested for settlement until their status is revised, which can be done at any time prior to settlement.

Participants can monitor and manage all outgoing payments in real time, and can monitor incoming payments that are active on the queue.

At the end of a session, transactions that are no longer eligible for settlement, either due to insufficient funds or being marked as deferred, are removed from the queue (with notification sent to the paying participant) and may be resubmitted in a subsequent session. A transaction may be withdrawn while it is in the RITS queue, prior to it being successfully settled.

Upon successful settlement testing and simultaneous debiting and crediting of ES Accounts, a transaction is final and irrevocable. This finality and irrevocability is supported by RBA approval of RITS under the *Payment Systems and Netting Act 1998*, which provides legal certainty for settlement in RITS in the face of participant insolvency.

#### 3.2.1.5 Risk management

As RITS is an RTGS system, participants are not exposed to credit risk: since customer accounts are not updated before interbank settlement is completed (with finality), there is no opportunity for a build-up of credit exposures between participants.

To minimise liquidity risk, RITS provides liquidity optimisation features (see Section 3.2.1.4) and access to central bank intraday liquidity through the use of repurchase agreements (repos).

The intraday repurchase agreement facility provided by the RBA enables participants to convert a range of highly rated debt securities (as determined by the RBA) into liquidity by means of an interest-free repurchase transaction (with an initial margin of over cover), with an agreement to reverse the transaction by the end of the day. These arrangements minimise the risk of credit exposure. In the event that a participant is unable to reverse an intraday repo with the RBA by the end of the day, the transaction can be converted to an overnight repo, with interest charged at 25 basis points above the target cash rate.

Participants have access to a range of information to manage their liquidity risk through the RITS interface. In particular, participants are able to view, in real time, their ES Account balances, settled payments and receipts, queued inward and outward transactions, the value of first and second leg intraday repos, and their projected end of day ES Account balances.

To manage operational risk, the RBA monitors RITS in real time for any problems at either the system or participant level, and the industry has detailed plans and procedures in place for dealing with contingencies. These are coordinated by the RBA and set out the industry response in circumstances where RITS, the SWIFT PDS or Austraclear are unavailable. They also cover circumstances where an individual participant is unable to send and receive payments. These plans and procedures are tested regularly. Participants also have internal procedures to deal with contingencies, with many able to switch to secondary connections to

RITS. The RBA maintains a live backup RITS facility at a remote site. The backup site is permanently staffed and both the primary and backup sites feature dual redundancy architecture.

#### 3.2.1.6 Pricing

RITS pricing is designed to recover the operational costs that the RBA incurs in the course of running RITS.

Participants are charged a fee of AUD 0.88 for each debit and credit to their ES Account through RITS and AUD 2.95 for each side of a cash transfer (with 10% goods and services tax applicable to both); these fees do not vary according to the time of day. The RITS fee structure is reviewed regularly, when consideration is given to both the level and range of fees. There are currently no fixed fees such as annual or entry fees imposed by RITS.

Even so, participants incur joining and annual fees for access to RITS through Austraclear's proprietary network as well as transaction fees for the settlement of securities (payable to Austraclear). Additional membership and transaction fees are incurred for transactions submitted through the SWIFT PDS (HVCS).

#### 3.2.1.7 Major ongoing and future projects

Work is under way to provide more timely settlement of low-value retail payments, currently settled on a next day deferred basis. Community networks (instead of bilateral links) will be used to exchange clearing files and simultaneously send associated settlement instructions to RITS. Participants will have the option to settle these low-value clearing obligations on a bilateral (or individual) basis or as part of a multilateral group settlement. This is expected to bring risk reduction and efficiency benefits for the RITS system and its participants, and support further innovation in the payments industry.

This work comprises three main parts:

- Establishment of RITS network connectivity with members utilising Community of Interest Network (COIN) infrastructure (see Section 3.3.3.7). This work has been completed;
- Provision of a Low Value Clearing Service (LVCS) to facilitate interconnectivity between COIN and SWIFT networks so that RITS members can exchange clearing files across their preferred network rather than having to use both COIN and SWIFT infrastructure. The LVCS became operational in June 2010; and
- Provision of a Low Value Settlement Service (LVSS) to facilitate more timely settlement of low-value clearings. RITS members will be able to provide settlement instructions to RITS for these low-value clearings by either SWIFT or COIN. This service is expected to be available in the first half of 2011.

Together, this new infrastructure will improve timeliness and efficiency of the clearing and settlement of low-value payments in Australia. This infrastructure modernisation aims to provide a platform to support product innovation and customer service, as well as reduce the risk associated with the current net deferred settlement arrangements.

### 3.2.2 High Value Clearing System (HVCS)

HVCS is a SWIFT closed user group payment arrangement established by APCA to provide a framework for access to RTGS for SWIFT message based payments so as to achieve settlement of participant obligations in central bank money with customer details exchanged outside RITS. It uses the SWIFT FIN-Copy service. The HVCS arrangements specify standards for access, operational reliability and other rule-based requirements. The HVCS does not involve proprietary system architecture.

### 3.2.2.1 Institutional framework

The HVCS regulations and procedures are administered by APCA. A management committee comprised of participant representatives is responsible for the effective operation of HVCS. The committee is also responsible for approving changes to the HVCS regulations. The committee is accountable to the APCA Board, which represents APCA's shareholders.

### 3.2.2.2 Participation

The RBA, authorised deposit-taking institutions and other prudentially supervised providers of payments services that hold ES Accounts at the RBA are entitled to join HVCS. There are no special membership categories and all members are directly responsible for their own settlement obligations. As at September 2010, there were 52 members of HVCS.

### 3.2.2.3 Types of transactions

HVCS is designed for the exchange of high-value electronic payments (ie SWIFT based payment instructions), such as the Australian dollar leg of foreign exchange settlements, including CLS obligations, as well as interbank customer payments. In practice, HVCS provides a significant volume of relatively low-value SWIFT based instructions (participants do not find that it is cost-effective to separate these low-value instructions from straight through processing functionality). Participant obligations arising from each individual HVCS instruction settle on an RTGS basis through RITS and comprised around two thirds of RITS payments by value in 2009/10 (and over 90% by volume).

### 3.2.2.4 Operation of the system and settlement procedures

The mechanism by which HVCS participants exchange payments is the SWIFT FIN-Copy service. A payment message within FIN-Copy is queued while a settlement request message is sent via the SWIFT network to RITS. RITS settles the interbank payment on an RTGS basis and forwards a settlement response to SWIFT, which then matches the settlement response it receives to the queued payment. SWIFT then forwards the message confirming payment to the participating member who is to receive the payment.

The core operating hours of HVCS are 9.15 am to 4.30 pm Australian Eastern Standard Time. To accommodate the operation of CLS Bank, there is a final settlement session for HVCS payments restricted to agreed banks. In winter, this session is from 4.30 pm to 6.30 pm and in summer, 4.30 pm to 8.30 pm. If summer time finishes in Australia but has not started in Europe the session is from 4.30 pm to 7.30 pm.

### 3.2.2.5 Risk management

Payments are settled on an RTGS basis through RITS. See Section 3.2.1.5 for a discussion of RITS risk management.

However, if due to an operational or other disruption RTGS through RITS becomes unavailable and is unlikely to recover on the day of failure, HVCS may implement contingency ("fallback") arrangements to substitute multilateral net settlement of the interbank obligations arising from transactions instead of normal RTGS settlement. Under these fallback arrangements, HVCS participants may, by prior bilateral agreement, send and receive HVCS payments in hard copy or electronic form. This fallback netting arrangement is protected as an "approved multilateral netting arrangement" under the *Payment Systems and Netting Act 1998*, subject to the RBA agreeing to switch to fallback arrangements.

In order to manage operational risk, HVCS participants must meet defined technical requirements and their systems must be capable of meeting minimum throughput requirements. HVCS participants must have backup facilities. Those participants who account for 2% or more of the value of sent and received payments within HVCS are required to have

a backup system in a geographically remote location. Participants must regularly test their internal backup arrangements and provide an annual compliance certificate to APCA management with regard to technical requirements set out in the HVCS procedures.

#### **3.2.2.6 Pricing**

Participants in the HVCS are required to pay an initial entry fee and an annual membership fee. Operating costs are assigned in proportion to participants' transaction volumes. HVCS development costs are assigned equally across members, usually in the form of one-off charges.

HVCS does not impose transaction-based fees for messages passing through HVCS. However, SWIFT imposes fees for each SWIFT payment message and the RBA charges a fee for each debit and credit to an ES Account.

### **3.3 Retail payment systems**

#### **3.3.1 Card-based systems – proprietary**

##### **3.3.1.1 Institutional framework**

Proprietary debit cards issued by financial institutions typically provide access to both the ATM system and the electronic funds transfer at point of sale (EFTPOS) system.

The operational arrangements for ATM and EFTPOS (proprietary debit) transactions have in the past been determined solely under the regulations and procedures of APCA's Consumer Electronic Clearing System (CECS). However, in April 2009 a new company, EFTPOS Payments Australia Limited (EPAL) was established to manage the EFTPOS system. Decisions in relation to EFTPOS membership, participation, compliance, processing and the implementation of wholesale fees will now be made by EPAL. Operational arrangements in relation to the ATM system will continue to be set by the CECS regulations and procedures.

For CECS, a Management Committee consisting of CECS participants is responsible for approving changes to the regulations and procedures including the means and timing of settlement, technical standards and dispute resolution. Management Committee decisions can be reviewed by the APCA Board, which is made up of representatives from APCA's shareholders. Changes to CECS regulations must also be approved by a meeting of CECS members.

For EPAL, scheme rules and the technical operational and security rules are approved by the Board, with major amendments also requiring a special resolution of members. The Board of EPAL has eight industry-appointed directors, including representatives of both large and small financial institutions and large merchants, plus three independent directors drawn from a variety of private sector backgrounds and a managing director.

##### **3.3.1.2 Participation**

There are 14 founding members of EPAL, including two major retailers that "self acquire" a large portion of their EFTPOS transactions. As at December 2010, there were 17 participants in CECS, consisting of 10 banks, three special service providers, two retailers and two payments system service providers. Most members of CECS have some form of representation within EPAL.

##### **3.3.1.3 Types of transactions**

Proprietary cards are issued by financial institutions under their own brand. In Australia, proprietary debit cards can be used to initiate both ATM and EFTPOS transactions. Many

merchants also offer a cash-out facility to cardholders making purchases. Transactions on proprietary cards require PIN authorisation and are debited to customers' accounts in real time.

#### 3.3.1.4 Operation of the system and settlement procedures

##### *Services provided*

Linkages between proprietary networks mean that there is effectively one national system of EFTPOS terminals, which accepts cards from all card issuers. The major national banks and the large regional banks provide most of the acquiring services to merchants. Most large merchants own their own terminals, while smaller merchants tend to lease them from their acquirers. Two major retailers switch their transactions to the various card issuers and transaction processors, in effect acquiring their own transactions. Other financial institutions, such as small regional banks, building societies and credit unions, are linked to the national system through arrangements with one of the larger banks or a small number of specialist providers of payments system services.

ATM networks are also linked bilaterally and, as with the EFTPOS system, there is effectively one national system with cards from all issuers accepted. Traditionally, the major banks and large regional banks owned and maintained large numbers of full service ATMs while smaller financial institutions grouped together to offer ATM services through service companies. More recently, there has been significant growth in the numbers of ATMs operated by independent ATM deployers who usually establish arrangements with a financial institution, or a specialist provider of payments system services, to link into the national ATM network.

##### *Data transmission*

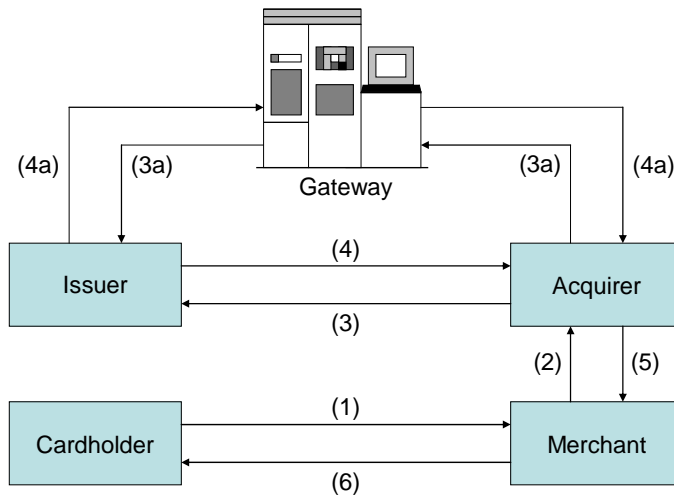
There is no centralised electronic clearing system or technical infrastructure for the proprietary debit system. Most items are exchanged electronically on a bilateral basis. The CECS and EPAL procedures specify formatting and other message standards and security standards.

##### *Authorisation*

The information flows in a typical EFTPOS transaction are illustrated in Figure 2. The cardholder presents their card to the merchant and enters their PIN (1), and the relevant data are transmitted to the merchant's financial institution (the acquirer) (2). If it is one of the acquirer's own cards, the account is checked internally and authorisation returned to the merchant (5). If the card is issued by another financial institution, the information is switched to the card issuer either directly via a bilateral link (3) or, if the issuer does not have this link, via a third institution acting as a gateway (3a). The issuer then checks if its cardholder has available funds. If so, it will return an authorisation message to the acquirer either directly (4) or via the gateway (4a). The acquirer passes the message to the merchant (5) and the transaction is complete (6).

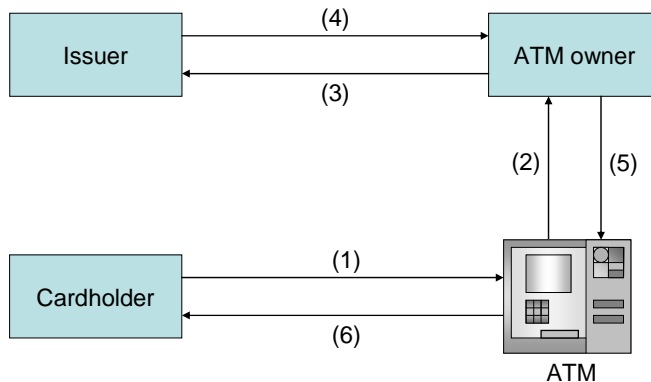


Figure 2  
**Information flows for an EFTPOS transaction**



Typical information flows for an ATM cash withdrawal are similar, as illustrated in Figure 3. The cardholder puts their card into an ATM, enters their PIN and the details of the withdrawal (1); the relevant information is then transmitted to the ATM owner (2). If the ATM owner and card issuer are the same institution, the transaction remains internal to that network. If the card is issued by another institution, the ATM owner will switch the information to that issuer (3). The issuer then checks the account and returns an authorisation (or a decline) via the ATM owner (4) to the ATM (5). Assuming authorisation was given, the cash is dispensed (6).

Figure 3  
**Information flows for an ATM transaction**



*Clearing and settlement procedures*

Settlement arrangements are determined by the CECS and EPAL rules for the ATM and EFTPOS systems and the RBA’s settlement processes that apply to all the low-value clearing streams. Each day, financial institutions calculate their national bilateral positions for

ATM and EFTPOS transactions against other clearing institutions and report these by 4 am the following business day to the Collator at the RBA.<sup>23</sup> These balances are then settled in RITS on a multilateral net basis at 9 am.

### 3.3.1.5 Risk management

Participants in the ATM and EFTPOS systems are members of EPAL and CECS or certified to CECS standards. The regulations and procedures imposed by these bodies mitigate fraud and other operational risks by requiring a minimum level of quality for operations, equipment and security measures. The regulations reference relevant Australian and international industry standards on, for example, system messaging formats, physical card characteristics and data protection. They also describe procedures to address operational contingencies, such as a failure of infrastructure, major telephone exchange outage, or loss of primary and backup interchange links. The rights and duties of card issuers and card users in the event of fraudulent transactions or operational failure are laid out in the Electronic Funds Transfer Code of Conduct, administered by the Australian Securities and Investments Commission (ASIC).

Participants in the ATM and EFTPOS systems are subject to various types of fraud risk, including stolen and counterfeit cards, card skimming and false card applications. Fraud risk in the EFTPOS system is reduced by the use of a PIN and the fact that EFTPOS transactions are only used in card-present environments. Accordingly, the EFTPOS system has experienced relatively low rates of fraud compared to other instruments. Both the EFTPOS and ATM systems are exposed to risk due to the use of magnetic stripe cards, although EPAL plans to convert all EFTPOS cards to EMV chip technology by 2014.<sup>24</sup>

Next day interbank settlement of ATM and EFTPOS transactions means that participants are exposed to settlement risk. This risk is addressed indirectly by EPAL and CECS membership requirements that aim to ensure participants have sufficient financial resources to meet their obligations. Total interbank settlement obligations (and hence the risks) generated from these systems are comparatively small – less than 1% of the value of daily payment flows. EPAL and CECS regulations specify rules to deal with a participant's failure to settle. The legal validity of netting arrangement for payments is protected as an "approved multilateral netting arrangement" under the *Payment Systems and Netting Act 1998*.

To the extent that liquidity risk is generated, arrangements are in place to allow ES Account holders to access additional liquidity for settlement if required (see Section 3.2.1.5).

### 3.3.1.6 Pricing

Members of CECS pay a uniform annual fee and a periodic fee that is based on their share of the national transaction volume. These fees are allocated to the operating costs of CECS and the CECS share of the general operating and administrative costs of APCA.

---

<sup>23</sup> "Collator" is a defined role in terms of APCA payments arrangements. APCA has appointed the Reserve Bank as Collator. The Collator collates advice from each participant in each APCA payment system (not including HVCS, which uses RTGS settlement) of gross credit and gross debit positions against each other participant as a result of bilateral file exchanges. The Collator matches these data, calculates multilateral net positions and passes these to RITS for batch settlement at 9 am on the day following the file exchange.

<sup>24</sup> EMV is a standard for the operation of credit and debit payment cards based on integrated circuit (chip) technology. The name EMV comes from Europay, MasterCard and Visa, the companies that started development of the standard.

Interchange fees, negotiated bilaterally between participants in the EFTPOS system, are paid by issuers to acquirers – the opposite of most card systems around the world.<sup>25</sup> The RBA determined a Standard for the setting of interchange fees in the EFTPOS system in 2006. The Standard sets a cap and floor on interchange fees, constraining them to between 4 cents and 5 cents per transaction, paid to the acquirer. Interchange fees on cash-out transactions (including purchase transactions with a cash-out component) remain unregulated. An amendment to the Standard in 2009 introduced a cap of 12 cents, paid to the issuer, for any multilateral EFTPOS interchange fees; that is, multilateral fees can be up to 12 cents paid to the issuer, or any amount paid to the acquirer. This amendment was intended to allow the newly formed EFTPOS scheme to establish multilateral interchange fees under a comparable regulatory framework to the Visa Debit System. As at the end of 2010, no multilateral EFTPOS interchange fees were in place. However, EPAL has indicated that a multilateral EFTPOS interchange fee regime will be put in place during the course of 2011.

Interchange fees in the ATM system were abolished in March 2009 as part of a package of reforms designed to improve competition in the Australian ATM system. The other main elements of these reforms were an industry-developed access code and the freedom for ATM owners to charge cardholders directly for the use of an ATM, provided that the charge is disclosed to the customer before the transaction is finalised.<sup>26</sup> At the same time, issuing institutions typically removed fees levied on their own customers for transactions made at another institution's ATMs. In 2010, most ATM owners charged a fee of around AUD 2 for cash withdrawals by a customer of another financial institution.

#### *3.3.1.7 Major ongoing and future projects*

On 3 June 2010, EFTPOS Payments Australia Limited (EPAL) announced that the EFTPOS system will move to EMV chip technology, with the industry aiming to complete the transition by 2014. According to EPAL, EMV chip technology will make the EFTPOS system more secure and provide a platform for new services.

By end-2011, the communications network used for EFTPOS and ATM traffic will move from fixed bilateral links to the use of an industry Community of Interest Network (COIN). This will allow new entrants to participate by establishing connectivity to a single network, rather than requiring multiple fixed links to other participants.

### **3.3.2 Card-based systems – scheme**

#### *3.3.2.1 Institutional framework*

The major international card schemes operating in Australia are Visa, MasterCard, American Express and Diners Club. Transactions undertaken using scheme cards, both credit and debit, are cleared under the rules of the relevant scheme.

---

<sup>25</sup> Background to these arrangements can be found in the 2000 joint study conducted by the RBA and the ACCC, *Debit and Credit Card Schemes in Australia – A Study of Interchange Fees and Access*, available on the RBA website.

<sup>26</sup> More detailed information on the rationale for the ATM reforms and the components of the reform package can be found in *An Access Regime for the ATM System* on the RBA website.

### 3.3.2.2 Participation

Authorised deposit-taking institutions (ADIs) are eligible for membership of the Visa and MasterCard schemes.<sup>27</sup> This includes a special class of ADIs known as Specialist Credit Card Institutions (SCCIs), which carry out card issuing or acquiring activities but do not otherwise engage in banking business. Two SCCIs (one issuer and one acquirer) are currently members of card schemes. Other members of the Visa and MasterCard schemes include banks, building societies and credit unions.

The American Express and Diners Club schemes have traditionally issued and acquired their own card transactions. In recent times, a number of banks have been licensed to issue American Express cards to their customers. In these cases, the banks provide the credit for purchases and are responsible for billing, issuing statements and providing access to accounts (eg via internet banking). American Express and Diners Club remain the sole acquirers of transactions in their schemes.

### 3.3.2.3 Types of transactions

Scheme card transactions (debit and credit) most commonly occur at points of sale, generally with the same terminals as those undertaken with proprietary cards. Most terminals are equipped with both magnetic stripe and chip readers and allow authorisation by signature or PIN. A small number of point-of-sale transactions are undertaken through contactless terminals. Apart from contactless and chip capabilities, the main differences from proprietary debit transactions lie beyond the customer interface, as discussed below. The major national banks and the large regional banks provide most of the acquiring services for the Visa and MasterCard schemes to merchants and around half of all ATMs.

As noted in Section 2.2.3, proprietary debit cards cannot be used in situations where the card is not present at the merchant, such as payments over the telephone and internet. On the other hand, scheme cards (debit and credit) can be used for telephone, internet and mail order purchases. The use of scheme cards over the internet has been increasing in recent years to around 10% of the value of card payments.

### 3.3.2.4 Operation of the system and settlement procedures

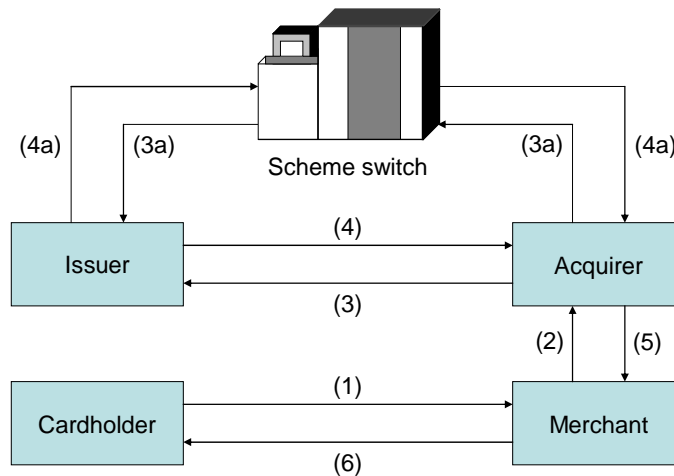
In Australia, as elsewhere, there is a centralised electronic clearing system for scheme card transactions. Most items are exchanged electronically, with a small residual of paper-based transactions. Scheme rules specify formatting and other message standards and security standards.

The most numerous category of scheme card purchase transactions are those performed electronically at the point of sale. The information flows involved in a typical transaction of this type are illustrated in Figure 4.

---

<sup>27</sup> ADIs are corporations authorised under the *Banking Act 1959* to undertake various banking activities, and are subject to prudential regulation by APRA. ADIs include banks, building societies and credit unions.

Figure 4  
**Information flows for a scheme card transaction**



The scheme card is swiped through or placed into an electronic terminal on the merchant's counter; if required the cardholder enters their PIN into the terminal at this stage (1). The transaction and cardholder details are routed to the merchant's financial institution (the acquirer) (2). If the acquirer is also the issuer, the transaction can be authorised internally and the authorisation returned to the merchant (5). If the issuer is another institution, the acquirer routes the transaction to that issuer either bilaterally (3) or via a switch facility provided by the scheme (3a). The issuer either authorises or declines the transaction and a message is sent back to the acquirer, (4) or (4a), and on to the merchant (5). If the transaction is authorised, and a PIN has not been required, the cardholder signs a voucher. The merchant checks the signature against the card and, if all is in order, the transaction is complete.

There are separate clearing and settlement arrangements for the card schemes operating in Australia. MasterCard and Visa have appointed settlement banks for the settlement of domestic card transactions. For those participants that have ES Accounts, the obligations to and from the settlement bank are settled as part of the 9 am multilateral deferred net settlement. For participants without an ES Account, settlement is effected multilaterally through accounts with the designated settlement bank.

### 3.3.2.5 Risk management

Members of the Visa and MasterCard schemes are required to be ADIs subject to prudential supervision, as noted in Section 3.3.2.2. American Express and Diners Club issue and acquire many of their own card transactions, and third-party issuers are ADIs. Scheme rules mitigate fraud and other operational risks by requiring a minimum level of quality for operations, equipment and security measures. The rights and duties of card issuers and card users in the event of fraudulent transactions or operational failure are set out in the rules of each scheme and, for transactions not authorised by signature, the Electronic Funds Transfer Code of Conduct, administered by ASIC.

Participants in the scheme card systems are subject to various types of fraud risk, including stolen and counterfeit cards and card details, card skimming and false card applications. The ability to use scheme cards (credit and debit) in a card-not-present environment presents additional fraud risks to those faced in the ATM and EFTPOS systems. The Visa and MasterCard schemes are moving to EMV chip cards and terminals, although many existing

cards, including all cards issued by the American Express and Diners Club schemes, remain reliant on magnetic stripe technology.

Total interbank settlement obligations (and hence the risks) generated by the Visa and MasterCard systems are small compared to overall interbank obligations. Visa and MasterCard each indemnify their members against any loss due to a participant failure. While this reduces the risks faced by individual members, Visa and MasterCard could be exposed to losses in the case of a default. Both schemes have in place policies to manage the risk of participant failure, including the requirement for prudential supervision of members and the posting of collateral by members that do not meet minimum credit requirements.

#### *3.3.2.6 Pricing*

Interchange fees in the Visa and MasterCard systems are paid by the acquirer to the issuer and are subject to regulatory caps – a weighted average of 50 basis points for credit card transactions, and 12 cents for debit card transactions. Acquirers generally charge merchants an ad valorem fee for card transactions and a separate fee for line and terminal rental. Both issuers and acquirers pay a variety of scheme fees to Visa and MasterCard for services including transaction processing and marketing.

Cardholders do not generally pay transaction fees, but may face fixed annual fees for credit cards or monthly account keeping fees for debit card accounts.

#### *3.3.2.7 Major ongoing and future projects*

##### *Chip technology*

The transition to chip technology for credit cards is continuing, with most terminals and a growing proportion of cards now chip-enabled. The credit card schemes have removed interchange fee penalties for merchants that process transactions on chip cards on a terminal that is not chip-enabled, although the schemes continue to promote the adoption of chip technologies, for instance through rules that shift liability for fraud to parties that have not adopted chip technology. At this time few, if any, ATMs are chip-enabled.

##### *Contactless payments*

Visa and MasterCard have both introduced contactless payment technology into Australia. A small but growing number of merchants have adopted contactless terminals, and issuers have started to issue chip cards with radio frequency antennae.

### **3.3.3 Cheques**

#### *3.3.3.1 Institutional framework*

Cheques, and other paper-based payment instruments such as money orders, AUD traveller's cheques and warrants are processed under the rules of APCA's Australian Paper Clearing System (APCS).

A Management Committee consisting of APCS participants is responsible for approving changes to the regulations, including means and timing of settlement, technical standards (such as message and security standards) and dispute resolution. Management Committee decisions can be reviewed by the APCA Board, which is made up of representatives from APCA's shareholders. Changes to APCS regulations must also be approved by a meeting of APCS members.

#### *3.3.3.2 Participation*

There are currently three classes of APCS members. Tier 1A members clear directly with one another and settle their resulting obligations across ES Accounts at the RBA. Tier 1B

members appoint Tier 1A members to clear on their behalf, but retain responsibility for their own settlement obligations. Tier 2 members appoint Tier 1A members as their agents to both clear and settle on their behalf. There are eight Tier 1A, three Tier 1B and 45 Tier 2 members of APCS.

### 3.3.3.3 *Types of transactions*

Cheques and other paper-based payment instruments such as money orders, AUD traveller's cheques and warrants are cleared through the APCS.

### 3.3.3.4 *Operation of the system and settlement procedures*

#### *Operation of the system*

Most banks provide a "three day clearing cycle". That is, if a cheque is deposited at an institution on Monday (Day 1), and cleared electronically, the institution makes the funds available to its customer for use on Wednesday (Day 3). Further details are provided below.

At the end of Day 1, institutions send all cheques deposited at their branches to their data centres or their clearers. Details of the value of the cheque are then added to the magnetic ink character recognition line (the MICR line), which includes details of the customer's account number, institution and branch. Cheques are then sorted into those drawn on the institution itself and those drawn on other institutions.

Settlement for the bulk of paper items drawn on other institutions (about 99%) is based on bilateral exchange of electronic files containing cheque details. Electronic files are sent to each clearing institution and paying institutions must inform the collecting institution by no later than the next business day if the cheque is to be dishonoured.

Physical exchange of cheques still occurs, either bilaterally or at regional clearing centres, but for the majority this is on a "not for value" basis as value has already been exchanged based on electronic information. To date, paying institutions have chosen to obtain their cheques for possible examination and storage. The *Cheques Act 1986* allows for the truncated presentation of cheques exchanged between institutions (ie electronic transmittal of data with the physical cheque remaining at the institution that collected it), although this is not widely used in Australia. Cheques deposited by customers are credited to their accounts on the day of deposit; where appropriate, interest accrues from the day of deposit. In most cases, the paying customers' institution posts debits to their customers' accounts on the night a cheque is exchanged. This means that paying customers' accounts are almost always debited on the same day as depositing customers' accounts are credited, so there is very little institution/customer float generated in the cheque clearing cycle.

In the absence of a covering line of credit, depositing customers are generally not able to withdraw these funds until the institution at which the deposit was made is reasonably sure that the cheque will be paid. Cheques are not considered paid until the paying institution has had time to validate the cheque and the drawer's capacity to cover it. The industry works on an exception basis, with paying institutions notifying collecting institutions only of those cheques that are dishonoured.

#### *Clearing and settlement procedures*

At the end of each clearing day, Tier 1A institutions advise the Collator at the RBA in Sydney of their bilateral net settlement positions with other Tier 1A institutions. These settlement balances also incorporate the positions of those institutions that have appointed a Tier 1A institution to clear and settle on their behalf. Tier 1A institutions are also responsible for reporting the multilateral net settlement positions of Tier 1B institutions for which they clear. No later than 3 am Sydney time on the following day, the final value of the previous day's exchanges is determined by the Collator, for settlement at 9 am. Institutions' ES Accounts are credited and debited simultaneously through a batch settlement in RITS. No central

bank/institution float is generated. Daily interest adjustments are made between institutions to reflect the fact that, although institutions pay interest to their customers from the day of deposit, they do not receive funds from the paying institution until settlement the next business day.

Industry practice is to credit customers for the amount of deposited cheques on the day of deposit. However, the deposited funds cannot be withdrawn until the bank of deposit is satisfied there is no further risk of dishonour. A cheque may be dishonoured for a number of reasons, including: the drawee institution becomes a failed financial institution; a cheque has been deemed fraudulent; or the payer has insufficient funds to meet the payment obligation. Funds credited to a recipient's account attract interest (if applicable to that account) from the day of deposit but may not be available for withdrawal for a number of days. Agreed industry best practice is that funds should be available no later than two days after the day of deposit.

#### 3.3.3.5 Risk management

Participants in the cheque system are subject to a number of risks, including those arising from fraudulently altered cheques, stolen cheque books, counterfeit cheques and kite flying (the activity of depositing valueless cheques and making withdrawals against those valueless cheques). Efforts have been made to mitigate risks arising from these sources, including by the incorporation of a number of security features in paper cheques, and the use of software programs to track consumer behaviour.

The APCS is a "recognised settlement system" under the *Cheques Act 1986*, which allows for the turnback, or presumed dishonour, of cheques for which a failed institution has not settled, removing the credit risk inherent in deferred net settlement. The legal validity of netting arrangement for APCS payments is protected as an "approved multilateral netting arrangement" under the *Payment Systems and Netting Act 1998*. The APCS regulations specify arrangements that apply should a direct settling participant fail to meet its obligations. In this case, the failed participant is removed from the batch and batch obligations are recalculated.

Net interbank obligations generated by the APCS are small relative to both the total value of interbank settlements in RITS and the largest of the retail clearing streams, BECS (see Section 3.3.4). Arrangements are in place to allow ES Account holders to access additional liquidity for settlement if required.

#### 3.3.3.6 Pricing

While there are no transaction-based fees for participation in the APCS, participants are required to pay both entrance fees and annual fees, based on the share of transactions processed through the APCS. Because the system is bilateral, most of the system's costs are associated with administration.

#### 3.3.3.7 Major ongoing and future projects

APCA is examining strategies and policies to manage the long-term decline in paper payments. The scope of this work includes looking at: areas where cheques are still used extensively; whether sufficient alternatives to cheques exist or need to be developed; and measures to improve cheque processing efficiencies and reduce processing costs.

By mid-2011, the communications network used for APCS and BECS will move from fixed bilateral links to the use of either the COIN or SWIFT (using its FileAct service). This will allow new entrants to participate by establishing connectivity to a single network (either COIN or SWIFT), rather than having multiple fixed links to other participants.



### **3.3.4 Retail credit and debit transfer systems – BECS**

#### *3.3.4.1 Institutional framework*

Credit transfers and direct debits are processed bilaterally under the rules of APCA's Bulk Electronic Clearing System (BECS).

A Management Committee, consisting of BECS participants, is responsible for approving changes to the regulations, including means and timing of settlement, technical standards (such as message and security standards) and dispute resolution. Management Committee decisions can be reviewed by the APCA Board, which is made up of representatives from APCA's shareholders. Changes to BECS regulations must also be approved by a meeting of BECS members.

#### *3.3.4.2 Participation*

There are two classes of members of BECS. Tier 1 members clear directly with one another and settle resulting obligations across ES Accounts at the RBA. Tier 2 members appoint Tier 1 members as their agents to both clear and settle on their behalf. There are 14 Tier 1 and 45 Tier 2 members of BECS.

#### *3.3.4.3 Types of transactions handled*

Credit transfers and direct debits, including bulk payments and transactions initiated via the internet or telephone banking facilities of financial institutions, are cleared through BECS.

BECS credit transfers are used widely, especially by government departments and companies for regular bulk payments such as social security benefits and salary and dividend payments, and more recently by individuals for internet-initiated payments. Direct debits are used mostly by billers, such as insurance and utilities companies, for collecting regular payments, as well as by financial institutions to collect loan repayments. In the case of direct debits, the payer must agree to the ongoing debiting of their account by providing an authority to the payee to allow funds to be deducted from their account.

#### *3.3.4.4 Operation of the system and settlement procedures*

##### *Operation of the system*

BECS is based on bilateral arrangements between participants. Files of direct-entry credits and debits are prepared by financial institutions and bilaterally exchanged between Tier 1 members using electronic links.

Credit transfers initiated by customers (payers) are debited from their accounts on the day of the transfer. These transfers are irrevocable and so there is no risk of dishonour. In most cases, the receiving customers' (payees') institutions will post credits to their customers' accounts overnight for value on the day of the transfer. Industry rules for Tier 1 members of BECS require that these funds be available to customers by 9 am the next morning. However, since customers may have their accounts with institutions who are not direct settlement members of BECS, receiving customers may not have their accounts credited for an extra day depending on the arrangements involved.

Direct debits initiated by customers (payees) are debited from the paying customers' (payers') accounts on the day of the transfer. Unlike credit transfers, these transfers carry the risk to beneficiaries of payments being dishonoured. In most cases, the payees' institution will post provisional credits to their customers' accounts the same day; however, in some cases payees may not have their accounts credited for up to three days depending on the internal processing systems of their institution.

### *Clearing and settlement*

At the end of each day, Tier 1 members reconcile their inward and outward exchanges (which include the positions of their Tier 2 appointers) and report their bilateral positions against other Tier 1 members to the RBA Collator in Sydney no later than 11 pm. These are settled on a multilateral net basis at 9 am on the following business day through RITS.

#### *3.3.4.5 Risk management*

Credit transfers are irrevocable and there is no risk of dishonour. Direct debits, on the other hand, like cheques, carry the risk to beneficiaries of payments being dishonoured. Dishonours of direct debits are generally communicated within 24 hours by payers' financial institutions.

Participants face settlement risk arising from next day settlement of interbank obligations. The legal validity of netting arrangements for BECS payments is protected as an "approved multilateral netting arrangement" under the *Payment Systems and Netting Act 1998*. The BECS regulations specify arrangements that apply should a direct settling participant fail to meet its obligations. In this case, the failed participant is removed from the batch and batch obligations are recalculated.

The direct entry system generates the largest interbank obligations of any of the retail payment systems. Nonetheless, these constitute only a small proportion of the total value of RITS settlements. Arrangements are in place to allow ES Account holders to access additional liquidity for settlement if required.

#### *3.3.4.6 Pricing*

While there are no transaction-based fees for participation in BECS, participants are required to pay both entrance fees and annual fees, based on the share of transactions processed through BECS. Because the system is bilateral, most of the system's costs are associated with administration.

#### *3.3.4.7 Major ongoing and future projects*

By mid-2011, the communications networks used for APCS and BECS will move from fixed bilateral links to the use of either the COIN or SWIFT (using its FileAct service). This will allow new entrants to participate by establishing connectivity to a single network (either COIN or SWIFT), rather than having multiple fixed links to other participants.

### **3.3.5 Retail credit and debit transfer systems – BPAY**

#### *3.3.5.1 Institutional framework*

BPAY is an electronic bill payment system owned by Australia's largest banks. There are more than 18 000 billers and over 160 financial institutions participating in BPAY.

#### *3.3.5.2 Participation*

BPAY has three classes of membership: 13 participant members; 151 associate members; and 22 payer institution members (PIMs). Participant members are involved in the clearing and settlement of BPAY transactions. Associate members and PIMs must contract a participant member to exchange and settle transactions involving their customers. Participant members, associate members and PIMs provide their customers with access to the BPAY interface, and credit and debit value to their customers' accounts.

#### *3.3.5.3 Types of transactions*

BPAY allows customers of participating financial institutions to pay their bills using credit transfers from their bank or credit card account with the transfers initiated by telephone or

internet banking services (including mobile applications and mobile internet banking). Unlike bill payments using direct debits, the customer has the option to initiate a transaction when a bill payment is due rather than providing a one-off authorisation for ongoing bill payments.

#### 3.3.5.4 Operation of the system and settlement procedures

A customer initiates a BPAY payment via their financial institution's telephone or internet banking systems, by entering details of the payment (including the amount and a customer reference number) and the biller to which it is to be paid (identified by a biller code). The customer's financial institution then transfers funds from either a deposit or credit card account to the biller's bank. In most cases, BPAY payments relate to a paper or e-mail bill transmitted outside the BPAY system; however, BPAY does operate an electronic bill presentment service (BPAY View) which is now offered by a small number of billers.

At the end of each business day, the members of BPAY send a file detailing the transactions initiated by their customers to the Central Interchange Processor (CIP). The CIP calculates the net amounts owing by each member to the system. BPAY transactions are settled along with BECS transactions in a multilateral net batch at 9 am in RITS. BPAY has contracted one of Australia's largest banks to act as its agent in BECS, to enable interbank settlement of BPAY obligations. If a payment is made during a business day, funds are available to the biller the next business day.

#### 3.3.5.5 Risk management

Participants in the BPAY system are members of BPAY and BECS or certified to BECS standards. The BPAY and BECS rules and operating procedures mitigate fraud and other operational risks by requiring a minimum level of quality for operations, equipment and security measures. The rights and duties of financial institutions and their customers in the event of fraudulent transactions or operational failure are set out in the Electronic Funds Transfer Code of Conduct, administered by ASIC.

Participants in the BPAY system are subject to fraud risks including the use of stolen credentials for telephone or internet banking systems. Fraud risk in the BPAY system is managed through the security measures built into financial institutions' telephone and internet banking systems from which BPAY payments are initiated.

Obligations in the BPAY system are settled along with BECS transactions in the RITS system at 9 am each business day on a deferred multilateral net basis. The interbank settlement obligations generated by the BPAY system are relatively small and of similar magnitude to the card payment systems.

BPAY has made an application for approval of its netting arrangements under the *Payment Systems and Netting Act 1998*, in order to safeguard its netting arrangements from legal challenge in the case of a participant entering external administration (where the participant is or may become insolvent).<sup>28</sup> Approval has been granted subject to a number of rule changes being made by BPAY.

---

<sup>28</sup> The *Payments System Netting Act* provides protection for netting where a party to an approved netting arrangement goes into external administration ie where:

- they become a body corporate that is an externally administered body corporate within the meaning of the Corporations Law; or
- they become an individual who is insolvent under administration within the meaning of the Corporations Law; or
- someone takes control of the person's property for the benefit of the person's creditors because the person is, or is likely to become, insolvent.

The comparatively small value of obligations generated by the BPAY system and the batch settlement of these obligations means that minimal liquidity risk is generated. Arrangements are in place to allow ES Account holders to access additional liquidity for settlement if required (see Section 3.2.1.5).

#### 3.3.5.6 Pricing

There are generally no specific fees charged to customers for BPAY transfers; however, individual institutions may charge customers a fee once a particular number of transactions are made. Billers, on the other hand, pay a fee to their financial institution for every payment received through BPAY. The biller's financial institution pays a wholesale fee to the payer's institution of 45.1 cents for a payment from a deposit account, or 40.7 cents plus 0.297% of the transaction value for a payment from a credit card account.

### 3.3.6 Cash distribution and exchange

Cash distribution and exchange occurs under a commercial arrangement between the RBA and private sector banks. Under existing arrangements, private sector banks own and hold the working stock of notes and coins and are responsible for its distribution. Accordingly, receipt of cash from the central bank reflects the net needs of each private bank. The RBA compensates commercial banks for interest forgone on their working stock of notes and coin up to a defined limit.

APCA's Australian Cash Distribution and Exchange System (ACDES) governs the exchange of cash between participating members. ACDES provides a formal framework for participating members to undertake exchanges of cash in an orderly and secure manner. The rules allow members with a shortage of particular denominations of cash in a particular geographical area to obtain cash from members with a corresponding surplus.

Commercial banks can purchase new notes from the RBA. The RBA has two banknote distribution centres.

#### 3.3.6.1 Institutional framework

An APCA Management Committee, consisting of representatives of each of the participants and the RBA, is responsible for approving changes to the ACDES Regulations and Rules. Management Committee decisions can be reviewed by the APCA Board, which is made up of representatives from APCA's shareholders.

The ACDES Regulations and Rules stipulate the means and timing of settlement, and dispute resolution procedures; they also set out the minimum matters that must be covered in bilateral agreements between participants. The bilateral agreements set out the general terms on which participants enter into transactions with each other.

The purchasing of cash from the RBA is covered by legal agreements between the RBA and ACDES participants.

#### 3.3.6.2 Participation

Five banks are participating members of ACDES and undertake exchanges of cash directly with each other. These five banks comprise Australia's four major banks and one regional bank. Together, these participants supply the majority of the community's cash needs.

#### 3.3.6.3 Types of transactions

Transactions are cash exchanges: the buying and selling of physical cash between participants with settlement in ES Account funds (ie net buyers of cash transfer ES Account funds to net sellers).

#### 3.3.6.4 Operation of the system and settlement procedures

Settlement for cash exchanges occurs on a deferred net bilateral basis through RITS by around 10 am on the following business day. Settlement of emergency buys may occur same-day by 4 pm through RITS.

#### 3.3.6.5 Risk management

Risks are managed by the ACDES Management Committee using the ACDES Regulations, Rules and Failure to Settle Guidelines and the Business Continuity Manual. Members have established exchange trading/dealing limits with counterparties to limit intraday settlement risk for transactions.

#### 3.3.6.6 Pricing

Members undertake exchanges at face value and share the costs of operating ACDES based on respective percentages of national activity.

## 4. Systems for post-trade processing, clearing and securities settlement

### 4.1 General overview

Clearing and settlement facilities operating in Australia are required to be licensed under the *Corporations Act 2001*. This legislation specifies that to grant a licence for clearing or settlement, the Australian Government must be satisfied, among other things, that the facility has adequate operating rules and procedures to ensure that systemic risk is reduced, and that the facility operates in a fair and effective manner. In making this assessment, the Australian Government considers advice from the RBA and ASIC.

Licensed facilities are subject to ongoing oversight by the RBA and ASIC. The RBA is responsible for ensuring that such facilities conduct their affairs in a way that is consistent with financial system stability. The *Corporations Act* specifies that licensed facilities must comply with the *Financial Stability Standards*, which are determined by the RBA, and do all other things necessary to reduce systemic risk. The RBA publishes formal annual assessments of all licensed facilities, which include specific evaluations against the *Financial Stability Standards*. ASIC is responsible for ensuring that licensed facilities meet any other supervisory obligations, including that operations are carried out in a fair and effective way, and that other conditions on a facility's licence are being satisfied.

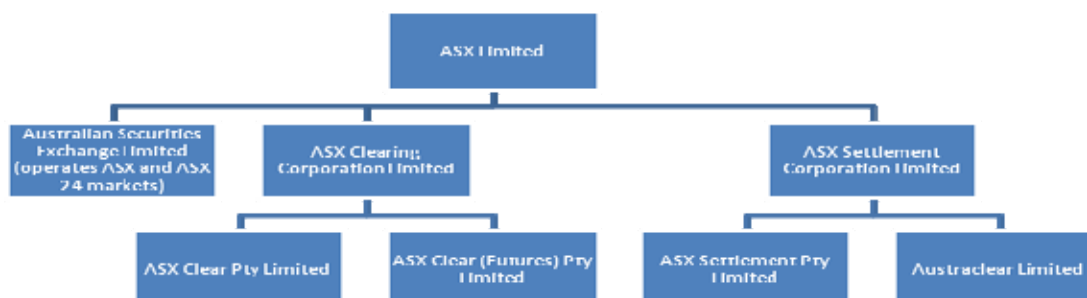
Four licensed clearing and settlement facilities are subject to the *Financial Stability Standards* – two CCPs, ASX Clear Pty Limited (ASX Clear) and ASX Clear (Futures) Pty Limited (ASX Clear (Futures)), and two securities settlement facilities, ASX Settlement Pty Limited (ASX Settlement) and Austraclear Limited (Austraclear).<sup>29</sup> These entities are all part of a single corporate group, Australian Securities Exchange (ASX) Limited.<sup>30</sup> ASX Limited is a for-profit, public company listed on its own financial market, ASX.

---

<sup>29</sup> A fifth entity, IMB Ltd, is licensed to settle a small volume of transactions in its own shares.

<sup>30</sup> ASX Limited was formed through the merger of Australian Stock Exchange Limited and Sydney Futures Exchange (SFE) Corporation Limited in 2006.

Figure 5  
**ASX Group corporate structure**



ASX Limited operates two markets, ASX and ASX 24 (formerly the SFE market). The ASX market provides trading services with respect to equities, warrants and a limited range of derivatives. The ASX 24 market offers trading services with respect to a range of futures and options. The ASX and ASX 24 markets are each linked to a separate CCP. ASX Clear offers CCP services for products traded on the ASX market. ASX Clear (Futures) offers CCP services for derivatives traded on the ASX 24 market, and for certain over-the-counter (OTC) transactions between ASX Clear (Futures) participants.

Equity trades initiated on the ASX market are settled by ASX Settlement, which also settles off-market equities trades between its participants. ASX Settlement owns and operates the Clearing-House Electronic Subregister System (CHESS), a central securities depository (CSD) for equities, which utilises the RITS system (see Section 3.2.1) for settlement of the funding leg through participating banks in central bank money.<sup>31</sup> Cash payments between clearing participants arising from margins and cash-settled derivatives trades initiated on the ASX and ASX 24 markets are made through Austraclear. Austraclear's primary function is to provide delivery versus payment (DVP) securities settlement (and CSD services) for fixed income securities.<sup>32</sup> Austraclear is a feeder system to RITS, with interbank obligations settling in central bank money on an RTGS basis.

#### 4.2 Post-trade processing systems

Austraclear also provides a limited range of post-trade processing services for OTC transactions. These include trade confirmation services for OTC debt securities transactions and some OTC derivatives transactions.<sup>33</sup> Austraclear offers these services as a complement to its settlement services, facilitating straight through processing of such transactions. (For more information regarding Austraclear, see Section 4.4.2.)

#### 4.3 Central counterparties and clearing systems

The two CCPs licensed to operate in Australia are ASX Clear and ASX Clear (Futures), both subsidiaries of ASX Limited.

<sup>31</sup> RITS offers a batch settlement facility that simultaneously debits and credits batch obligations.

<sup>32</sup> These securities are traded on an OTC basis.

<sup>33</sup> Austraclear typically charges AUD 3 per side for OTC trade confirmation services.

### **4.3.1 ASX Clear**

#### *4.3.1.1 Institutional framework*

ASX Clear Pty Limited is a wholly owned subsidiary of ASX Clearing Corporation Limited (ASXCC), itself a wholly owned subsidiary of ASX Limited. ASXCC is responsible for the investment of ASX Clear (and ASX Clear (Futures)) risk resources including margins (held under trust) and provides subordinated loans to both ASX Clear and ASX Clear (Futures). ASXCC holds an ES Account at the RBA.

ASX Clear is governed by its own board of directors, while the ASX Group is governed by the ASX Limited Board. The ASX Limited Board is primarily responsible to shareholders for the overall performance of ASX Group. Responsibility for oversight and risk management of the clearing and settlement facilities is delegated to the facilities' individual boards, which report to the ASX Limited Board. The boards all comprise a majority of independent, non-executive directors.

The legal basis for ASX Clear's operations is set out in the ASX Clear Operating Rules and Procedures. These rules define the nature and scope of its obligation to provide clearing services to participants, and describe the conditions under which final and irrevocable settlement of obligations is deemed to have occurred. The Operating Rules and Procedures also set out the rights and obligations of participants, including in the event of default or suspension.

Under Australian law, the ASX Clear Operating Rules and Procedures have effect as a contract between ASX Clear and each of its participants, and between each participant and each other participant. Furthermore, Australian law protects the netting arrangements contained in the ASX Clear Operating Rules and Procedures. This provides certainty for the netting process in the event of the insolvency of a participant.

The RBA in its oversight role continually monitors ASX Clear's compliance with the *Financial Stability Standard for Central Counterparties*, and publishes formal assessments annually. ASIC also publishes annual market assessment reports of the ASX Group; these cover, among other things, the fair and effective provision of services by the licensed clearing and settlement facilities, and whether the facilities' licence obligations are met. See Section 4.1 for a full description of the Australian regulatory framework.

#### *4.3.1.2 Participation*

There are two classes of participant in ASX Clear: direct participants (which clear for their own and client activity, as ASX trading participants); and general participants (which in addition to clearing for their own and client activity may act as third-party clearers for other ASX trading participants, ie other trading participants that are not clearing members of ASX Clear). At September 2010, ASX Clear had 54 participants – 51 direct participants and 3 general participants. The 51 direct participants comprised eight domestic banks, 23 domestic brokers and 20 foreign entities.

#### *4.3.1.3 Types of transactions*

ASX Clear provides CCP services for products traded on the ASX market. These include equities, pooled investment products, warrants, certain interest rate products and equity- and commodity-related derivatives.

#### *4.3.1.4 Operation of the system and settlement procedures*

For cash equities trades, novation occurs with effect from the matching of the trade on the market. In the case of derivatives trades, novation takes place no later than the evening of the day of the trade, when trade details are allocated to participants' accounts. Following novation, clearing participants receive confirmation messages regarding the trades that have

been novated, and on the next day (T+1) receive notification of their net obligations to ASX Clear for the previous day's trades.

Securities obligations between ASX Clear and its clearing participants are settled in ASX Settlement. Associated interbank payment obligations are settled in RITS.<sup>34</sup> Equities obligations are settled on a T+3 basis. Margin payments are initiated via Austraclear and settled through RITS (at present cash equities are not margined).

ASX Clear trade information is stored in CHESS.

#### 4.3.1.5 Risk management

ASX Clear applies three layers of risk management protections:

- **Participation requirements and ongoing monitoring.** Direct participants are required to hold at least AUD 5 million in core capital and general participants are required to hold at least AUD 10 million in core capital. Core capital consists of share capital, reserves and retained profits. Participants are also subject to requirements regarding technical and operational capacity. Minimum capital requirements provide comfort that a participant has sufficient financial capacity to absorb unexpected financial or operational shocks. They can also help to ensure that participants commit significant financial resources to the clearing business and assume the responsibility that direct participation entails. Furthermore, minimum capital requirements provide a means (albeit imperfect) of reducing the probability of a call on a CCP's risk resources by assuming exposures only to participants meeting a threshold level of credit quality.
- **Margining and other collateralisation of exposures by participants.** Margins protect the CCP from normal price volatility. Margins are routinely collected from participants in respect of derivatives exposures, but not currently for cash equities (see Section 4.3.1.8 in respect of a project to introduce margins for cash equities). Initial margin requirements are calculated on the basis of covering three standard deviations of the estimated distribution of price movements. Variation margins are collected to mark to market the value of positions on a daily basis, and may also be called intraday. For both derivatives and equities positions, additional collateral may be requested where exceptionally large or concentrated exposures are identified through capital stress testing. The margins and other collateral posted by a defaulting participant would be drawn on first to cover losses resulting from their default. ASX Clear tests the validity of its margin methodology by periodic backtesting.
- **Maintenance of risk resources.** ASX Clear risk resources protect against losses that could arise if a default exceeds any margin posted by the defaulting participant, ie risk resources guard against losses arising from a participant default in extreme but plausible conditions. ASX Clear risk resources comprise AUD 250 million in fully paid-up ASX Clear funds<sup>35</sup> and up to AUD 300 million which can be levied on surviving participants in the event of a participant default. ASX Clear assesses the adequacy of pooled risk resources by stress testing on a daily basis.

---

<sup>34</sup> On a Model 3 DVP basis. Securities are immobilised prior to submission of a batch payment instruction to RITS. Upon successful settlement of that RITS batch, settlement participant cash positions are immediately updated with a corresponding release of securities to their intended recipients.

<sup>35</sup> As ASX is a for-profit CCP (and is not mutualised), own resources are called upon prior to mutualised participant promissory resources in the default fund "waterfall". Own resources comprise own equity, restricted capital reserve, a subordinated loan funded by ASX Limited and a subordinated loan funded by a commercial bank.



In the event of a participant default, ASX Clear is able to reschedule any payments involving the failed participant. ASX Clear may also enter into market transactions to sell or purchase securities to facilitate the settlement of novated transactions. For derivatives, ASX Clear has the ability to close out a defaulted participant's positions, or to seek to transfer the client positions of the defaulted participant to a surviving participant.

#### 4.3.1.6 *Links to other systems*

ASX Clear is linked to the ASX Trade platform and the ASX Settlement and Austraclear settlement facilities. ASX Clear settles margin and treasury investment related transactions through RITS across the ES Account of ASXCC.

#### 4.3.1.7 *Pricing*

Combined clearing and settlement fees for equity trades are charged at 0.25 basis points per trade.<sup>36</sup> The corresponding fees for warrants, structured products and interest rate securities are 0.35 basis points per trade.

Clearing participants are also required to pay an annual fee of AUD 5 000, or AUD 7 500 if offering third-party clearing services.

#### 4.3.1.8 *Major ongoing and future projects*

Projects that ASX Clear is currently planning include:

- **Routine margining of equities.** ASX Clear intends to introduce margining for cash equities positions.
- **Harmonisation and linking of CCP activity.** ASX Limited has an ongoing project to harmonise and link the activities of its two CCPs (ASX Clear and ASX Clear (Futures)). The project will include migrating both CCPs to a common margining system.

### 4.3.2 **ASX Clear (Futures)**

#### 4.3.2.1 *Institutional framework*

ASX Clear (Futures) Pty Limited is a wholly owned subsidiary of ASX Clearing Corporation Limited, itself a subsidiary of ASX Limited. ASX Clear (Futures) has the same governance structure, legal framework and regulatory framework as ASX Clear (see Section 4.3.1.1). ASX Clear (Futures) was formerly known as SFE Clearing Corporation.

#### 4.3.2.2 *Participation*

At September 2010, ASX Clear (Futures) had 15 participants, predominantly large foreign banks and their subsidiaries.

#### 4.3.2.3 *Types of transactions*

ASX Clear (Futures) provides CCP services for derivatives traded on the ASX 24 market, including futures and options on interest rate, equity, energy and commodity products, and for non-market trades between ASX Clear (Futures) participants, including block trades, strip

---

<sup>36</sup> All prices quoted exclude goods and services tax.

trades and exchange-for-physical trades. ASX Clear (Futures) clearing participants must appoint a settlement participant in Austraclear to settle margin and other obligations.<sup>37</sup>

#### 4.3.2.4 Operation of the system

ASX Clear (Futures) novates trades initiated on the ASX 24 market upon ASX 24's registration of the matched trade. Non-market trades are novated when ASX Clear (Futures) approves and registers the trade details.

Each trading day, ASX Clear (Futures) calculates the obligations of its clearing participants arising from cash settlement of derivative contracts and margins. Participants with net obligations to the CCP are required to make RTGS payments through Austraclear (ie a payments message through the Austraclear system that will result in a transfer of ES Account funds to ASXCC via RITS RTGS functionality) (see Section 4.4.2 for a description of Austraclear).<sup>38</sup> Once these payments have been received, ASX Clear (Futures) makes payments to those participants with a net obligation from the central counterparty. Settlement occurs in real time across the ES Accounts of participating banks at the RBA (see Section 3.2.1). Unless there is a participant default, flows across the ES Account of ASXCC will reflect net margin receipts or payments.

Where derivative contracts require physical settlement, ASX Clear (Futures) utilises the securities settlement functions within Austraclear or, for certain commodities, facilitates delivery via a warehouse.

#### 4.3.2.5 Risk management

The ASX Clear (Futures) risk management framework has three key components:

- **Participation requirements and ongoing monitoring.** ASX Clear (Futures) participants are required to maintain a minimum of AUD 5 million in net tangible assets. Participants are also subject to requirements regarding technical and operational capacity. Minimum capital requirements provide comfort that a participant has sufficient financial capacity to absorb unexpected financial or operational shocks. They can also help to ensure that participants commit significant financial resources to the clearing business and assume the responsibility that direct participation entails. Furthermore, minimum capital requirements provide a means (albeit imperfect) of reducing the probability of a call on a CCP's risk resources by assuming exposures only to participants meeting a threshold level of credit quality.
- **Margining and other collateralisation of exposures by participants.** Margins protect the CCP from normal price volatility. Clearing participants are required to post initial margin for their derivatives positions. Initial margins are calculated on the basis of covering three standard deviations of historical price movements. In addition, clearing participants are required to pay variation margins on a daily basis, covering any price movements in the previous day. ASX Clear (Futures) can also collect variation margins on an intraday basis. Additional margin may also be requested where exceptionally large or concentrated exposures are identified through capital stress testing. In the event of a default, any margin posted by the defaulting participant would be used first to cover its obligations to ASX Clear

---

<sup>37</sup> A clearing participant in ASX Clear (Futures) may also be an Austraclear settlement participant. A settlement participant that does not have an ES Account at the RBA must appoint a participating bank.

<sup>38</sup> Note that a clearing participant with surplus collateral lodged with ASX Clear (Futures) may not need to make a payment through Austraclear settlement participants and participating banks.

(Futures). ASX Clear (Futures) tests the validity of its margin methodology by periodic backtesting.

- **Maintenance of risk resources.** ASX Clear (Futures) risk resources protect against losses that could arise if a default exceeds margin posted by the defaulting participant, ie risk resources guard against losses arising from a participant default in extreme but plausible conditions. Risk resources comprise AUD 370 million of fully paid-up own and participant funds and AUD 30 million in participant promissory funds. ASX Clear (Futures) assesses the adequacy of risk resources by stress testing on a daily basis.

In the event of a participant default, ASX Clear (Futures) has the ability to close out any open contracts, to exercise or terminate open contracts, or to seek to transfer client positions.

#### 4.3.2.6 Links to other systems

ASX Clear (Futures) is linked to ASX 24 markets and to Austraclear. ASX Clear (Futures) settles margin and treasury investment related transactions through RITS across the ES Account of ASXCC.

#### 4.3.2.7 Pricing

Clearing fees for cash-settled financial derivatives are combined with ASX 24 trading fees, and range between AUD 0.60 and AUD 1.50 per side depending on the derivative product cleared. Clearing fees for physically settled securities derivatives range between AUD 2 and AUD 2.50 per side, with higher fees for physically settled commodity derivatives.

In addition, clearing participants may be charged an annual fee of AUD 10 000.

#### 4.3.2.8 Major ongoing and future projects

As discussed in Section 4.3.1.8, ASX Limited is currently working to harmonise the activities of its two CCPs.

## 4.4 Securities settlement systems

Two securities settlement systems licensed to operate in Australia are subject to the *Financial Stability Standards* – ASX Settlement and Austraclear; both are subsidiaries of ASX Limited.<sup>39</sup>

### 4.4.1 ASX Settlement

#### 4.4.1.1 Institutional framework

ASX Settlement Pty Limited is a wholly owned subsidiary of ASX Settlement Corporation Limited, which is itself a wholly owned subsidiary of ASX Limited. As with the ASX Limited CCPs, responsibility for governance lies across a specific ASX Settlement board and the ASX Limited Board (see Section 4.1). ASX Settlement was formerly known as ASX Settlement and Transfer Corporation.

The legal basis for ASX Settlement's operations is set out in its operating Rules and Procedures. Under Australian law, these rules have effect as a contract between ASX Settlement and each of its participants, and between each participant and each other

---

<sup>39</sup> A third entity, IMB Ltd, is licensed to settle a small volume of transactions in its own shares.

participant. The operating Rules and Procedures set out the rights and obligations of participants and ASX Settlement, including in the event of default or suspension.

The netting arrangements undertaken by ASX Settlement with respect to its participants' obligations have approval as a protected netting arrangement under the *Payment Systems and Netting Act 1998*. This provides certainty for the netting process in the event of the default of an ASX Settlement participant or a payments provider (see Section 1).

The RBA continually monitors ASX Settlement's compliance with the *Financial Stability Standard for Securities Settlement Facilities*, and publishes formal assessments annually. ASIC also publishes annual market assessment reports of the ASX Group; these cover, among other things, the fair and effective provision of services by the licensed clearing and settlement facilities, and whether the facilities' licence obligations are met. (See Section 4.1 for a description of the Australian regulatory framework.)

#### 4.4.1.2 Participation

At September 2010, ASX Settlement had 106 participants.

#### 4.4.1.3 Types of transactions

ASX Settlement operates the securities settlement facility for equities and warrants traded on the ASX market.<sup>40</sup>

#### 4.4.1.4 Operation of the system

ASX Settlement's securities settlement system is CHESSE.<sup>41</sup> Settlements in CHESSE occur on a Model 3 DVP basis, with settlement of participants' cash obligations and securities transfers occurring simultaneously upon confirmation that interbank settlement across ES Accounts at the RBA has taken place as a multilateral net batch.

On business day T+1, CHESSE generates a single net batch instruction reflecting the net position of each participant's novated trades in each line of stock. Between T+1 and T+3, participants can also instruct CHESSE to include additional non-novated (off-market) transactions in the batch at T+3. The majority of non-novated transactions are typically related to the "priming" of clearing participants' accounts to facilitate settlement of novated trades.

On T+3, after the cutoff for new settlement instructions, transfer of securities positions is stopped in CHESSE and participants' "payment providers" are requested to fund the net cash obligations of settlement participants. Payment providers hold ES Accounts at the RBA and act on behalf of settlement participants.<sup>42</sup> Payment obligations are settled between payment providers in RITS in a single daily multilateral net batch. Immediately upon confirmation from RITS that the funds transfers have been settled, ASX Settlement completes the net securities transfers in CHESSE, thus ensuring DVP and final settlement.

---

<sup>40</sup> It also operates a transfer service for a very small number of transactions undertaken on minor regional exchanges.

<sup>41</sup> The ASX Group encompasses a vertically integrated exchange, CCP and settlement system (including the CSD). CHESSE spans both the CCP and the settlement system. Transactions arising from the exchange pass through the ASX proprietary trading engine via a proprietary message system to CHESSE. ASX has added infrastructure to permit competing exchanges to access its CCP and settlement services (which involves access to CHESSE). CHESSE distinguishes between novated and non-novated trades but Model 3 DVP settlement involves a single net position for each line of stock that represents the net of novated and non-novated transactions.

<sup>42</sup> There were 12 payment providers operating in ASX Settlement at June 2010.

#### 4.4.1.5 Risk management

Settlement risk in CHESS is mitigated by the use of a Model 3 DVP mechanism. CHESS settlement is from credit funds only so that ASX Settlement is not exposed to credit risk.

Often delivery of securities occurs at the end of a chain of custodian transfers, a process that a settlement participant may have limited capacity to control in a global market. Accordingly, ASX Settlement participants may not be able to ensure that all securities are lodged in the appropriate accounts prior to settlement. CCPs provide participants with a guarantee against the default of a participant. They do not, however, guarantee timely settlement. A small proportion of settlement fails are common in equities settlement systems.

This risk can be mitigated through securities lending arrangements. ASX Settlement does not feature a centralised securities lending service but all ASX Settlement participants have standing arrangements with institutional lenders (eg custodians).

If, due to a shortfall of either securities or funds, a participant is unable to settle its scheduled obligations in the batch, ASX Settlement rules allow for all or some of the transactions of the affected participant to be “backed out”. These transactions are then rescheduled for settlement on the next settlement day. ASX Settlement’s back-out process seeks to remove as few transactions from the batch as possible, maximising settlement values and volumes, while minimising the spillover to other participants.

To ensure that participants have the proper incentive to avoid settlement fails, ASX Settlement imposes a fee for failed settlements. Serious or lengthy fails may be referred to the ASX Disciplinary Tribunal.

Operational risk is mitigated through maintenance of a live backup site. A small core of staff for key functionality is permanently located at the backup site and procedures ensure that full migration of personnel to the backup site can occur within two hours. The backup site can be operated remotely from the primary site.

Settlement participants are required to maintain business continuity arrangements to allow the recovery of usual operations within approximately two hours following a contingency event.

ASX Settlement regularly tests business recovery arrangements. Connectivity and procedural testing of the backup site are performed monthly. Live tests (ie where market, clearing and settlement services are provided in real time from the backup site) are conducted on a two-year cycle.

#### 4.4.1.6 Links to other systems

ASX Settlement is linked to the ASX Clear CCP. ASX Settlement utilises RITS for cash settlement between participant banks (see Section 4.4.1.4).

#### 4.4.1.7 Pricing

Combined clearing and settlement fees for transactions settled by ASX Settlement are described in Section 4.3.1.7.

Settlement participants are also required to pay an annual fee of AUD 5 000 or AUD 10 000, depending on the type of access they require.

### 4.4.2 Austraclear

#### 4.4.2.1 Institutional framework

Austraclear Limited is a wholly owned subsidiary of ASX Settlement Corporation Limited, itself a subsidiary of ASX Limited. Austraclear and ASX Settlement have the same governance structure and regulatory framework (see Section 4.4.1.1).

Austraclear's Regulations are a contract between Austraclear and each of its participants, and between participants, governed by Australian law. Austraclear is an electronic depository and securities settlement system for Commonwealth Government Securities and other debt securities. It is an RTGS feeder system to RITS and is approved under the *Payment Systems and Netting Act 1998*. Austraclear provides transfer of securities against Austraclear cash accounts between a diverse range of participants. Non-bank Austraclear participants must nominate a "participant bank" that agrees to meet their obligations. Austraclear RTGS of securities creates interbank obligations that simultaneously settle across ES Accounts at the RBA on an RTGS basis through RITS.<sup>43</sup> Some transactions will settle solely in Austraclear (ie where two non-bank participants share a common participant bank).

#### 4.4.2.2 Participation

At September 2010, Austraclear had 729 participants.

#### 4.4.2.3 Types of transactions

Austraclear primarily settles trades executed in the OTC market for fixed income securities, including government bonds and repos. It also accepts payments instructions for cash settlement of derivatives transactions and margins.

#### 4.4.2.4 Operation of the system

Austraclear's key settlement system is EXIGO.

Austraclear settles securities transactions on a Model 1 DVP basis. This involves the simultaneous transfer of payment and securities obligations between the buyer and seller on an item-by-item (gross) basis through the settlement cycle. Austraclear also provides for one-way cash transfers between participants, which are settled on an item-by-item (gross) basis.

To settle payments, participant banks hold ES Accounts at the RBA and act on behalf of other Austraclear participants.<sup>44</sup> Settlement of payment obligations occurs between participating banks across ES Accounts at the RBA on an RTGS basis. A simultaneous transfer of securities title occurs in Austraclear to complete final settlement.

#### 4.4.2.5 Risk management

Austraclear addresses settlement risk by the use of a Model 1 DVP mechanism.

Operational risk is mitigated through maintenance of a backup site. Key systems offer full redundancy at both the primary and backup sites.

Austraclear tests backup arrangements quarterly and carries out connectivity and procedural testing on a monthly basis. Live tests (ie where market, clearing and settlement services are provided in real time from the backup site) are conducted on a two-year cycle.

Through its Regulations, Austraclear also requires that its participants have appropriate disaster recovery arrangements.

---

<sup>43</sup> "Participant Bank" is a defined term in the Austraclear Regulations, meaning a participant in RITS with an ES account at the RBA which has unconditionally agreed to meet obligations on behalf of an Austraclear participant or participants.

<sup>44</sup> At June 2010, 59 participant banks were operating in Austraclear.

#### *4.4.2.6 Links to other systems*

Austraclear has links with two overseas international securities depositories – Euroclear and Clearstream. These links allow Austraclear participants to hold entitlements to securities held in those depositories in their Austraclear account. Austraclear also has a link with Central Moneymarket Unit (CMU), a CSD operated by the Hong Kong Monetary Authority, which allows CMU participants to settle securities held in Austraclear.

Austraclear is linked to the ASX Clear and ASX Clear (Futures) CCPs. It is a feeder system to RITS enabling RTGS of cash obligations (see Section 4.4.2.4).

#### *4.4.2.7 Pricing*

Transaction fees for settlement of fixed income securities are set at AUD 11 per side, and for cash transfers at AUD 5 per side.

Participants are also charged annual access fees, ranging from AUD 750 to AUD 5 000 depending on the type of access.

#### *4.4.2.8 Major ongoing and future projects*

ASX Limited is augmenting Austraclear's user functionality and internal operations including trade management, trade input, corporate action reporting, market repo trade enhancements and straight through processing. The project is expected to be completed in stages over 2011 and 2012.

### **4.5 Use of the securities infrastructure by the central bank**

The RBA provides liquidity (including intraday) via transactions in eligible securities. Eligible securities for market operations and intraday repurchase transactions must be lodged in Austraclear.

**Payment, clearing and  
settlement systems in  
Brazil**





## Contents

List of abbreviations.....	59
Introduction.....	61
1. Institutional aspects.....	63
1.1 The general institutional framework .....	63
1.2 The role of the central bank .....	64
Oversight.....	64
Provision of settlement services.....	65
Cooperation with other institutions .....	65
1.3 The role of other public and private entities .....	65
1.3.1 Financial intermediaries providing payment services .....	65
1.3.2 Other payment service providers .....	66
1.3.3 Clearing and settlement service providers.....	66
1.3.4 Main bodies related to securities and derivatives markets .....	67
2. Payment instruments used by non-banks .....	69
2.1 Cash payments .....	69
2.2 Non-cash payments .....	70
2.2.1 Cheques.....	70
2.2.2 Credit transfers .....	71
2.2.3 Credit cards.....	71
2.2.4 Debit cards.....	72
2.2.5 Retailer cards.....	72
2.2.6 Direct debits.....	72
2.3 Recent developments .....	73
3. Payment systems (funds transfer systems).....	73
3.1 General overview .....	73
3.2 Large-value payment systems .....	75
3.2.1 Reserves Transfer System (STR).....	75
3.2.2 Funds Transfer System (SITRAF) .....	80
3.2.3 BM&FBOVESPA – Foreign Exchange Clearinghouse .....	83
3.3 Retail payment systems .....	85
3.3.1 Cheque Clearinghouse (COMPE).....	85
3.3.2 Deferred Settlement System for Interbank Credit Orders (SILOC).....	86
4. Systems for post-trade processing, clearing and securities settlement.....	88

4.1	General overview .....	88
4.1.1	Regulatory framework .....	88
4.1.2	Infrastructure .....	88
4.2	Post-trade processing systems .....	91
4.3	Central counterparties and clearing systems .....	91
4.3.1	OTC Clearinghouse (CETIP) .....	91
4.3.2	BM&FBOVESPA – Brazilian Securities, Commodities and Futures Exchange .....	93
4.4	Securities settlement systems .....	100
4.4.1	Special System for Settlement and Custody (SELIC) .....	100
4.5	Use of securities infrastructure by the central bank.....	102

## List of abbreviations

ANBIMA	Brazilian Financial and Capital Markets Association
ANBID	National Association of Investment Banks
ANDIMA	National Association of Financial Market Institutions
BCB	Central Bank of Brazil
BM&FBOVESPA	Brazilian Securities, Commodities and Futures Exchange
BRL	Brazilian Real
CETIP	OTC Clearinghouse
CIP	Interbank Payment Clearinghouse
COMPE	Cheque Clearinghouse
CMN	National Monetary Council
CVM	Securities and Exchange Commission
DOC	Credit Transfer
DVP	Delivery versus payment
ECT	Brazilian Post Office Company
GTS	Global Trading System
MEGABOLSA	BM&FBOVESPA's Stocks Trading System
PVP	Payment versus payment
RSFN	National Financial System Network
RTGS	Real-time gross settlement
RTM	Market Telecommunication Network
SELIC	Special System for Settlement and Custody
SILOC	Deferred Settlement System for Interbank Credit Orders
SITRAF	Funds Transfer System
STN	National Treasury Secretariat
STR	Reserves Transfer System
TEC	Special Credit Transfer
TECBAN	Banking Technology S.A.
TED	Electronic Funds Transfer



## Introduction

Prior to the mid-1990s, changes in the Brazilian payment, clearing and settlement systems aimed at increasing the speed of processing of financial transactions.<sup>1</sup> In the reform carried out by the Central Bank of Brazil (BCB) in 2001 and 2002, the focus shifted to risk management. In the scope of this reform, the BCB implemented an RTGS system, known as the Reserves Transfer System (STR), and also advised the National Congress in its introduction of important legal changes relating to clearing and settlement systems.<sup>2</sup> Furthermore, a new rule was introduced concerning the accounts that financial institutions hold at the BCB: since 2002, overdrafts have no longer been permitted.<sup>3</sup> Hence, a funds transfer between two settlement accounts is allowed only if there are sufficient funds on the account of the remitting institution.

As a result of these developments, Brazil now has a national payment system with the following main features: (i) all large-value funds transfers, including customers' orders, are settled in same day funds, typically a few minutes after they are initiated; (ii) securities clearing and settlement systems provide relatively short settlement cycles (for instance, real time or T+1 for government securities, depending on the settlement system chosen by the counterparties); (iii) all clearing and settlement systems settle in central bank money;<sup>4</sup> (iv) DVP is observed in all securities settlement systems; (v) a central counterparty is used for most derivatives, stocks and interbank foreign exchange transactions; (vi) almost all OTC derivatives and securities transactions must be registered in a centralised system; and (vii) straight through processing is extensively used in all payment and securities settlement systems.

As regards institutional aspects, the Payment System Law, enacted in 2001, is the main legal instrument for the Brazilian payment, clearing and settlement systems. It sets forth, inter alia, that: (i) the BCB is responsible for defining which clearing and settlement systems are systemically important;<sup>5</sup> (ii) multilateral netting of obligations in a clearing and settlement system is permitted; (iii) assets posted as collateral to clearing houses cannot be seized even by judicial order; and (iv) the Bankruptcy Law does not affect the fulfilment of a participant's obligations to a clearing and settlement system. Therefore, even in case of a participant's bankruptcy, such obligations will be brought to completion and settled in accordance with the regulations of the relevant system, and the collateral posted by the defaulting participant will be foreclosed (so that settlement is always carried out irrevocably).

The BCB is empowered by the National Monetary Council (CMN)<sup>6</sup> to regulate, authorise and oversee all Brazilian interbank clearing and settlement systems, regardless of the volume, value and type of transactions they process. CMN has also set forth principles for the Brazilian clearing and settlement systems, which are reflected in the corresponding regulation by the BCB.

---

<sup>1</sup> One reason was that Brazil was then facing chronic inflation of up to 2% per month. Arrangements to help economic agents preserve their funds against inflation depended on the existence of short settlement cycles, particularly for inflation-indexed government securities.

<sup>2</sup> For further information on these legal changes, see Section 1.1.

<sup>3</sup> Since 2002 the BCB has extended to reserve account holders, free of charge, fully collateralised and unlimited intraday credit.

<sup>4</sup> Settlement in central bank money is mandatory for systemically important systems only. In practice, however, all systems settle in central bank money.

<sup>5</sup> For details see Section 1.2.

<sup>6</sup> CMN is the government body that sets currency and credit policy, among other responsibilities.

Payment services are provided mainly through the 33,500 branches of universal and commercial banks. They are also available through some 120,000 “correspondentes bancários”. These are non-financial institutions that act as banks’ agents, providing payment and banking services to people without direct access to the Brazilian banking system. Regarding payment instruments, electronic instruments have continued to replace cheques in recent years. The use of TED, a customer-initiated electronic funds transfer order, has increased steadily, reaching about 300,000 transfers a day at the end of 2009. Credit transfers via TED are settled in real time or “quasi-real time”, depending on whether they are settled via STR or SITRAF (Funds Transfer System), respectively.<sup>7</sup> As a general rule, a bank receiving a credit transfer must credit the payee’s account no more than 60 minutes after the interbank settlement has taken place. After receiving a TED order, the payer’s bank must forward it to the relevant settlement system within 30 minutes.

STR is the hub of the national payment system, since all Brazilian clearing and settlement systems settle in central bank money. In addition to STR, domestic interbank funds transfers can be settled in SITRAF or cleared in SILOC (Deferred Settlement System for Interbank Credit Orders) before final settlement in STR.<sup>8</sup> Cheques are cleared through COMPE (Cheque Clearinghouse). SITRAF, a private sector-operated RTGS-like system, has been designated as systemically important. SILOC and COMPE are multilateral netting systems that are not classified as systemically important. The FX Clearinghouse, a BM&FBOVESPA-operated multilateral netting system designated as systemically important, provides clearing services for foreign exchange transactions involving the Brazilian real (BRL) and US dollar (USD). To a large extent, STR and SITRAF share the same technological platform.

For securities transactions, the entity that provides settlement services typically also provides post-trade processing, as well as acting as a clearing house and as a central depository. BM&FBOVESPA also acts as a central counterparty for all transactions accepted in its clearing and settlement systems.<sup>9</sup> Hence, the entities providing these services are vertically integrated. In some cases, the integration also includes the trading environment.<sup>10</sup> The provision of these services, however, shows a certain degree of horizontal segmentation: SELIC (Special System for Settlement and Custody), the DVP<sup>11</sup> securities settlement system operated by the BCB, settles federal government securities. The federal government securities transactions can also be settled with multilateral netting through the Debt Securities Clearinghouse. For its part, the Equity and Corporate Bond Clearinghouse, a multilateral netting system, clears and settles mainly equity transactions, while corporate bonds are cleared and settled principally through CETIP (the OTC clearing house).

Finally, it should also be noted that (i) the Brazilian payment card industry is undergoing important changes aimed at increasing competition, especially on the acquiring side (see Sections 1.2 and 2.3 for further information); (ii) internet banking is widely used: at the end of 2009 some 35 million sight deposit accounts could be accessed remotely via internet, which accounted for some 48% of all banking transactions in terms of volume in that year; and (iii) mobile payments, although nascent in Brazil, may become an important retail payment channel in the coming years, particularly for people without direct access to the banking

---

<sup>7</sup> SITRAF is an RTGS-like system. Typically, more than 97% of orders are settled in less than one minute.

<sup>8</sup> A funds transfer will be settled through a particular system depending mainly on its value, payment purpose, and the speed requested by the payer.

<sup>9</sup> In addition to the FX Clearinghouse, BM&FBOVESPA owns and operates three other clearing houses: Debit Securities Clearinghouse; Equity and Corporate Bond Clearinghouse; and Derivatives Clearinghouse.

<sup>10</sup> For further information, see Section 4.1.2.

<sup>11</sup> DVP: delivery versus payment. For a description of different DVP models, see Committee on Payment and Settlement Systems, *Delivery versus payment in securities settlement systems*, Basel, 1992.

system (given that almost 200 million mobile phones are in use and that most people have access to one).

## 1. Institutional aspects

### 1.1 The general institutional framework

The Financial System Law, enacted in 1965, regulates the Brazilian financial system. It also sets out the roles and functions of both the National Monetary Council (CMN)<sup>12</sup> and the BCB. CMN is responsible for currency and credit policy, as well as for the integrity of financial institutions and instruments. The BCB's aims encompass the stability of the Brazilian currency's purchasing power and the soundness of the financial system. The BCB is responsible for implementing CMN policy directives and also for licensing and supervising financial institutions,<sup>13</sup> as well as for issuing currency (banknotes and coins) and administering currency in circulation.<sup>14</sup> The BCB is also authorised to intervene in the management of a financial institution, put it under special administrative governance or determine its extrajudicial liquidation.

A CMN resolution of 2001 empowers the BCB to regulate, authorise and oversee all Brazilian interbank clearing and settlement systems, regardless of volume, value and the type of transaction processed. In the case of securities clearing and settlement systems, responsibility for these activities is shared with the Securities and Exchange Commission (CVM).<sup>15</sup> The resolution also sets forth core principles for the Brazilian payment system that accord with the recommendations contained in the CPSS report *Core principles for systemically important payment systems* and the CPSS/IOSCO joint reports *Recommendations for securities settlement systems* and *Recommendations for central counterparties*.

Enacted in 2001, the Payment System Law is the principal legal instrument underpinning the Brazilian clearing and settlement systems. It establishes that:

- it is the responsibility of the BCB to define which clearing and settlement systems are systemically important;<sup>16</sup>
- multilateral netting of obligations in a clearing and settlement system is permitted;
- the institution responsible for operating a systemically important clearing and settlement system must act as a central counterparty and adopt measures and safeguards that ensure the settlement of the relevant transactions;
- assets posted as collateral to clearing houses<sup>17</sup> cannot be seized even by judicial order; and

---

<sup>12</sup> CMN comprises the Minister of Economy, the Minister of Planning and the President of the BCB.

<sup>13</sup> According to law, financial institutions are public or private legal entities whose main or complementary activity is the collection, intermediation, and investment of their own financial resources or those of third parties in national or foreign currency, and custody of securities.

<sup>14</sup> The BCB has the sole right to issue banknotes and coins.

<sup>15</sup> Clearing and settlement systems for government securities and bank-issued bonds are under the sole supervision of the BCB.

<sup>16</sup> See Section 1.2 (BCB oversight) for information on criteria used by the BCB to designate a clearing and settlement system as systemically important.



- the Bankruptcy Law does not override a participant's obligations to a clearing or settlement system. Thus, even in the event of a participant's bankruptcy, such obligations will be brought to completion and settled in accordance with the regulations of the relevant system, and collateral posted by the defaulting participant will be foreclosed (settlement is always carried out irrevocably).

For all transactions (funds transfers, securities, derivatives and foreign exchange), settlement finality is addressed by the BCB's provisions governing the functioning of the Brazilian clearing and settlement systems. In Brazil, all clearing and settlement systems settle in central bank money. Hence, settlement finality for all these systems is determined when the relevant financial positions are settled by STR.<sup>18</sup>

Cheques are regulated according to the general principles of the Geneva Convention.<sup>19</sup> Financial relationships between economic agents, including issues related to funds transfers, clearing and settlement of obligations, are contractual relationships. Contracts are subject to the provisions of the Civil Code, the so-called White Collar Law, which addresses crimes against the national financial system, and the Payment System Law. In addition, the Consumer Protection Law governs the relationship between financial institutions and their customers.

## 1.2 The role of the central bank

### ***Oversight***

A CMN resolution states that the BCB has the responsibility for promoting the soundness, normal functioning and improvement of the Brazilian payment system. The BCB is also responsible for authorising and overseeing clearing and settlement systems, including those that settle securities, foreign exchange and derivatives transactions.<sup>20</sup> Additionally, the Payment System Law mandates to the BCB the task of defining which clearing and settlement systems are systemically important.

The BCB, in its capacity of regulating the functioning of clearing and settlement systems, has ruled that:

- systemically important clearing systems must settle their net positions directly in accounts held at the BCB;
- all systems clearing and settling securities and other financial assets, including foreign currency and financial derivatives, are considered as systemically important, as well as funds transfer and cheque clearing and settlement systems with average daily turnover higher than 4% of the STR average daily turnover, or that, in the

---

<sup>17</sup> In Brazil, a central counterparty is always the entity operating the relevant securities clearing and settlement system. Therefore, this provision is also applicable in case of a central counterparty.

<sup>18</sup> In the case of SITRAF, an RTGS-like system whose settlement accounts are funded with central bank money pre-deposits (see Section 3.2.2.4 for details), finality occurs intraday.

<sup>19</sup> Cheque Law, enacted in 1985.

<sup>20</sup> Systems that settle securities are under the joint supervision of BCB and CVM (systems settling government securities and bank-issued securities, however, are overseen by the BCB exclusively). In any case, aspects related to systemic risk are assessed solely by the BCB.

BCB's judgment, have the potential to pose a risk to the smooth functioning of the national payment system;<sup>21</sup>

- the maximum settlement lag should be: (i) at end of day for systemically important funds transfer systems; (ii) one business day for spot transactions with securities (except stocks); and (iii) three business days for transactions with stocks carried out on stock exchanges. The settlement deadline in any other situation is established by the BCB, which examines each particular case; and
- clearing houses should maintain net worth consonant with their risk exposure, with a minimum of BRL 30 million for systems considered systemically important and BRL 5 million for systems that are not considered systemically important.<sup>22</sup>

### ***Provision of settlement services***

The BCB operates both the funds transfer system STR (see Section 3.2.1) and the government securities settlement system SELIC (see Section 4.4.1). No retail payment system is operated by the BCB. In Brazil, a bank that takes sight deposits from the public is legally disbarred from holding a sight deposit account at another bank. Therefore, except for payments made in cash or those between customers of the same bank, all payments are settled in central bank money. Furthermore, as established by the Federal Constitution, the BCB is the exclusive depository of National Treasury funds. To ensure the smooth operation of the national payment system, the BCB extends fully collateralised and unlimited intraday credit, free of charge, to holders of reserve accounts.

### ***Cooperation with other institutions***

The BCB and CVM share responsibility for the oversight of securities settlement systems. Additionally, the BCB has cooperated with certain competition and consumer authorities – the Ministry of Justice's Secretariat of Economic Law and the Ministry of Finance's Secretariat for Economic Monitoring<sup>23</sup> – to increase competition in the Brazilian payment card industry.

The BCB also participates in the COMPE Group and the National Payment System Management Committee. The former deals with cheque clearing issues while the latter is an informal consultative group on the payment system comprising representatives from clearing and settlement systems, and bankers' associations. The BCB also coordinates technical groups related to the National Financial System Network (RSFN), a privately owned telecommunications network that is mainly used to access STR and SITRAF.

## **1.3 The role of other public and private entities**

### ***1.3.1 Financial intermediaries providing payment services***

The institutions that provide payment services are universal banks, commercial banks, savings banks, cooperative banks and credit unions. All are authorised and supervised by the BCB. These institutions offer sight deposit accounts, which are the main type of

---

<sup>21</sup> To evaluate this potential, the BCB uses a methodology that aims to measure the possibility of contagion among participants of a clearing and settlement system in case of a participant default. The relevant methodology is publicly disclosed.

<sup>22</sup> USD 1.00 = BRL 1.7412 at end-2009.

<sup>23</sup> This joint work was carried out under the umbrella of a 2006 technical cooperation memorandum.

accounts used by firms and households to make payments.<sup>24</sup> At the end of 2009, there were some 1,500 institutions of this type, with 33,500 branches, and 134 million sight deposit accounts.

### **1.3.2 Other payment service providers**

In addition to the aforementioned financial intermediaries, “correspondentes bancários” – some 120,000 at the end of 2009 – play an important part in providing payment services. These are non-financial institutions that act as agents for banks<sup>25</sup> by offering banking and payment services to customers with no direct access to the Brazilian banking system. ECT, the Brazilian Post Office, is an important correspondente bancário that provides payment services in many municipalities without bank branches.

Payment card companies also play an important role in the national payment system. The main international brands operating in Brazil are Visa, MasterCard and American Express. Hipercard and *Cheque Eletrônico* are the main domestic brands. Visa and MasterCard, which are organised as four-party schemes, provide both credit and debit cards. American Express and Hipercard, both three-party schemes, offer credit cards only. For its part, *Cheque Eletrônico* offers debit cards only. On the acquiring side of the payment card market, the main participants are the Brazilian Company for Means of Payment (Cielo) and Redecard S.A. (Redecard), which are domestic companies controlled by Brazilian banks. They operate the two largest POS networks in Brazil, accounting for more than 90% of payment card transactions.

Both the debit card scheme *Cheque Eletrônico* and the shared ATM network *Banco24Horas* are operated by Banking Technology S.A. (TECBAN), which is owned by a consortium of Brazilian banks. For its part, Telefônica S.A. is a telephone network operator that provides Oi Paggo, the most widely used mobile-based payment service.

### **1.3.3 Clearing and settlement service providers**

The table below summarises information on the Brazilian clearing and settlement service providers.

---

<sup>24</sup> Payments can generally also be made directly from savings accounts (about 91 million accounts at end-2009). However, this typically excludes the use of cheques and debit cards, which are only offered on sight deposit accounts.

<sup>25</sup> Typically, correspondentes bancários are post offices, lottery vendors, supermarkets, drugstores and other small retail outlets.

Table 1

**Providers of clearing and settlement services**

<b>Entity</b>	<b>Form of constitution</b>	<b>Ownership</b>	<b>Systems operated</b>	<b>Main items cleared/settled</b>	<b>Section</b>
CIP – Interbank Payment Clearinghouse	Non-profit civil association	Domestic banks	SITRAF	Credit transfers	3.2.2
			SILOC	Credit transfers; interbank payments related to some card schemes	3.3.2
Banco do Brasil	For-profit company	Federal government and several domestic and foreign investors	COMPE	Cheques	3.3.1
CETIP S.A. – Organised OTC Market for Securities and Derivatives	For-profit company	Several domestic and foreign investors	OTC Clearinghouse	Corporate bonds and OTC derivatives	4.3.1
BM&FBOVESPA	For-profit company	Several domestic and foreign investors	FX Clearinghouse	Interbank foreign exchange transactions	3.2.3
			Equity and Corporate Bond Clearinghouse	Equities and corporate bonds	4.3.2.1
			Debt Securities Clearinghouse	Government securities	4.3.2.2
			Derivatives Clearinghouse	Mainly exchange-traded derivatives	4.3.2.3

**1.3.4 Main bodies related to securities and derivatives markets****1.3.4.1 Securities and Exchange Commission (CVM)**

CVM, which was created by the Securities Market Law in 1976, is an independent regulatory body with nationwide authority over securities and derivatives markets. Besides regulating and enforcing the related laws and its own rules, CVM is empowered to investigate and to sanction market participants, including exchanges, OTC market operators, issuers, intermediaries, custodians, central depositories, asset managers and investment funds. Together with the BCB, CVM authorises and oversees securities settlement systems (systems settling either government securities or bank-issued securities are authorised and overseen by the BCB exclusively).

The institution is run by a board of five members, all appointed by the President of Brazil and approved by the Federal Senate for alternate five-year terms. CVM is a member of international organisations such as the International Organization of Securities Commissions,

the Emerging Markets Committee Advisory Board, and the Council of Securities Regulators of the Americas.

#### 1.3.4.2 *Brazilian Financial and Capital Markets Association (ANBIMA)*

Founded in October 2009, ANBIMA was created by the merger of the former National Association of Investment Banks (ANBID) and the former National Association of Financial Market Institutions (ANDIMA). The new entity represents more than 300 members including universal, commercial and investment banks, asset managers, securities brokers and dealers, and investment advisers.

Since 1998, ANBIMA (previously ANDIMA and ANBID) has created and instituted codes of regulation and best practice by which market participants themselves set regulatory standards. In addition to raising operational standards, self-regulation aims to instil transparency into the Brazilian financial and capital markets. To carry out this activity, the entity counts on several market committees, most of which consist of external members, thus ensuring independence.

ANBIMA (previously ANDIMA) implemented the SELIC system in 1979, in cooperation with the BCB. It also played an important part in the implementation of the CETIP system in 1986. Furthermore, ANBIMA operates the Market Telecommunication Network (RTM), which interconnects hundreds of financial institutions and data providers via a dedicated high-speed optical fibre network for data, voice and image.

#### 1.3.4.3 *BM&FBOVESPA Group*

The Brazilian Securities, Commodities and Futures Exchange (BM&FBOVESPA) is the only stock and derivatives exchange in Brazil. It was created in 2008 by the merger between the former São Paulo Stock Exchange, founded in 1890, and BMF&F S.A., the former Brazilian Mercantile & Futures Exchange, founded in 1986. BM&FBOVESPA provides a fully electronic trading environment through order-driven systems that give direct market access to both retail and institutional investors, including co-location facilities.<sup>26</sup> It offers a complete set of financial and commodities products in the cash, futures and options markets.

BM&FBOVESPA also operates the FX Clearinghouse, the Equity and Corporate Bond Clearinghouse, the Debt Securities Clearinghouse and the Derivatives Clearinghouse (see Sections 3.2.3, 4.3.2.1, 4.3.2.2 and 4.3.2.3, respectively, for further information). Furthermore, it acts as a central counterparty for all these clearing houses, and also as a central depository for stocks and some corporate bonds.

The BM&FBOVESPA Settlement Bank and the BM&FBOVESPA Supervision of Markets (BSM) are subsidiaries of BM&FBOVESPA. The former provides custody and settlement services to all exchange participants. The latter is the self-regulatory organisation for the BM&FBOVESPA markets.

BSM is also responsible for managing the Investor Indemnification Mechanism to which investors can make claims for the reimbursement of losses from fraud, bad order execution or other cases of participant misconduct. The BSM's self-regulation committee comprises eight members, five of whom are external to BM&FBOVESPA Group.

---

<sup>26</sup> Co-location is a direct connection to the exchange whereby customer orders can be entered into the trading systems without using the technological infrastructure of brokerage houses. These orders are generated through a software application installed on a computer that is hosted in premises made available by BM&FBOVESPA.

#### 1.3.4.4 CETIP S.A. – Organised OTC Market for Securities and Derivatives

In addition to providing depository, clearing and settlement services related mainly to corporate bonds, bank-issued securities and derivatives (see Section 4.3.1), this entity also provides the CETIPNET electronic trading platform.

As a self-regulated institution, CETIP supervises participants to ensure compliance with laws and regulations. Self-regulation is conducted by means of an independent structure, with management autonomy, that is also responsible for supervision in markets served by CETIP.

## 2. Payment instruments used by non-banks<sup>27</sup>

### 2.1 Cash payments

Cash payments are used in everyday purchases and other small-value transactions. They account for 77% of payments made by individuals, according to a 2007 BCB survey. At the end of 2009, the total amount of currency in circulation was about BRL 131.9 billion, of which approximately BRL 128.5 billion was in banknotes and BRL 3.4 billion in coins. Banknotes are issued in six denominations (BRL 2, 5, 10, 20, 50 and 100),<sup>28</sup> and coins in six denominations (BRL 0.01, 0.05, 0.10, 0.25, 0.50 and 1).<sup>29</sup> Both banknotes and coins are legal tender in Brazil, but the acceptance of coins as a payment instrument is mandatory only up to 100 units of each denomination. From 2005 to 2009, currency held by the public accounted for an average 39.8% of the M1 monetary aggregate, as shown in the table below.

Table 2

#### Share of currency held by the public in the M1 monetary aggregate (end of year)

Year	Currency held by the public (BRL billions)	M1 (BRL billions)	in % of M1
2005	58.3	144.8	40.3
2006	68.9	174.4	39.5
2007	82.3	231.4	35.6
2008	92.1	223.4	41.2
2009	105.5	248.1	42.5
<b>Average</b>			<b>39.8</b>

<sup>27</sup> All economic agents excluding institutions accepting sight deposits.

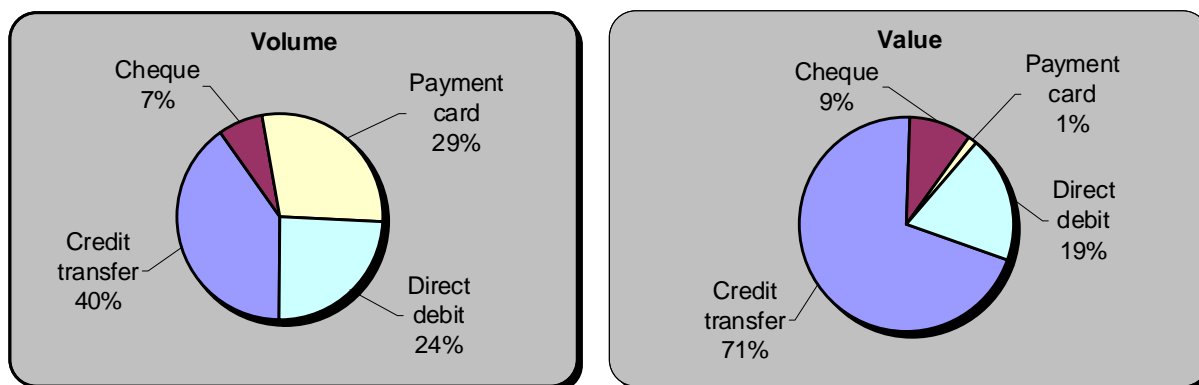
<sup>28</sup> Until a few years ago, BRL 1 banknotes were also issued (some remain in circulation and continue to be legal tender).

<sup>29</sup> The BCB has the sole right to issue banknotes and coins.

## 2.2 Non-cash payments

Non-cash payments are made mainly by means of credit transfers, payment cards, direct debits and cheques. The following chart shows the share of each payment instrument in 2009.

Chart 1  
Use of payment instruments in 2009<sup>1</sup>



<sup>1</sup> Payment cards do not include retailer cards.

### 2.2.1 Cheques

Cheques continue to be an important payment instrument in Brazil,<sup>30</sup> although their use has declined in recent years owing to substitution by payment cards and credit transfers. Cheques are standardised in format and carry magnetic ink character recognition (MICR) encoding so that basic data can be read automatically. A cheque can only be presented on a sight deposit account. Typically, cheques are still physically presented to the drawee bank, although they can be truncated where previously agreed between banks.

The interbank settlement of a cheque occurs on T+1, with the exact process varying according to the cheque's value.<sup>31</sup> The payer's and payee's accounts are respectively debited and credited as follows:

- the payer's account is debited on the night of T in the case of "over-the-limit" cheques,<sup>32</sup> or on the night of T+1 in the case of "below-the-limit" cheques; and
- the payee's account is credited on the night of T+1 in the case of "over-the-limit" cheques, or on the night of T+2 in the case of "below-the-limit" cheques.

In 2009, approximately 1.8 billion cheques were written, amounting to some BRL 2.5 trillion (an average of about BRL 1,400 per cheque), against 2.5 billion cheques in 2005, amounting to BRL 2.2 trillion.

<sup>30</sup> The practice of post-dating cheques as a means of postponing payment, as may be agreed between the payer and payee, is customary but not supported by the Cheque Law.

<sup>31</sup> As of 18 February 2005, cheques whose values are equal to or larger than a reference value (currently BRL 250,000) are settled bilaterally among banks, without netting, through STR. Cheques with lower values are settled by multilateral netting in a specific clearing system (COMPE).

<sup>32</sup> Cheques with a value equal to or larger than a reference value (currently BRL 299.99). Conversely, "below-the-limit" cheques are those having a value below this reference value.

### 2.2.2 Credit transfers

In Brazil, interbank credit transfers that can be ordered by non-banks include *Electronic Funds Transfer (TED)*, *Credit Transfer (DOC)*, *Special Credit Transfer (TEC)* and those related to “bloquetos de cobrança”.<sup>33</sup> These credit transfers are non-paper-based, and differ in terms of (i) settlement cycle and, as a consequence, the value date for the beneficiary; (ii) the value of the transfer;<sup>34</sup> and (iii) the nature of the beneficiary’s account (in the case of TEC, the beneficiary’s account is typically a salary account).

In the case of both TED and TEC, the beneficiary’s account receives same day value (in the case of TED, typically a few minutes after the transfer is initiated by the payer). In the case of DOC, funds are made available in the beneficiary’s account on the morning of the following day (T+1), while in the case of bloquetos de cobrança the availability of funds in the beneficiary’s account will depend on the terms of the agreement between the beneficiary and its financial institution. For intrabank credit transfers, the remitter’s account is debited and the receiver’s account simultaneously credited at the moment the transfer is initiated.

A credit transfer can be initiated either by the remitter through an electronic channel (ie ATM terminals, personal computers and mobile phones),<sup>35</sup> or by a bank cashier on behalf of the remitter. In 2009, some 7.2 billion credit transfers were made, amounting to about BRL 18.6 trillion (an average of BRL 2,600 per transaction). From 2005 to 2009, the volume of credit transfers increased by about 50%, or 10.7% per annum. Over the same period, the use of TED, which is settled in real time or “quasi-real time” depending on whether it is settled in STR or SITRAF, has steadily increased, posting average annual growth rates of 15.4%.

Various systems are used for the interbank settlement of credit transfers: STR or SITRAF, at the discretion of the sending bank, for TED; SILOC for DOC, TEC and most bloquetos de cobrança (those with a value larger than BRL 5,000 are settled bilaterally through STR).

### 2.2.3 Credit cards

Although credit cards were introduced to Brazil as early as 1956, they became an important payment instrument only in the 1990s. Their widespread adoption has been accelerated by the elimination of certain restrictions, such as the ban on paying for fuel purchases with a credit card, and the abolition of the “private label” requirement that, until 1996, prevented an issuing bank from operating more than one brand.

In Brazil, credit card holders pay no interest if they pay the invoice in full on the next due date. On average, cardholders are given a grace period of 28 days. Visa, MasterCard, American Express and Hipercard<sup>36</sup> are the main brands issued and accepted in Brazil.<sup>37</sup>

The number of credit cards increased from 67.5 million in 2005 (an average of one card per 2.7 Brazilians) to 152.3 million in 2009 (an average of one card per 1.3 Brazilians), representing an increase of 125.6% over the period or an annual average growth rate of 22.6%. In 2009, around 2.8 billion credit card transactions were made, amounting to about

---

<sup>33</sup> *Bloquetos de cobrança* are bar-coded payment slips that allow bills to be paid in any bank. The related funds transfers are usually electronic.

<sup>34</sup> By agreement among the Brazilian banks, TED is used for transfers larger than BRL 3,000, but those related to stock exchange transactions do not observe this minimum value. DOC and TEC are only used for transfers lower than BRL 5,000.

<sup>35</sup> Internet banking and ATM terminals are widely used in Brazil. Together, they accounted for some 78% of all banking transactions in 2009.

<sup>36</sup> Hipercard is a domestic brand.

<sup>37</sup> Visa and MasterCard are organised as four-party schemes, while American Express and Hipercard are three-party schemes.



BRL 254.1 billion (an average value of BRL 92 per transaction). From 2005 to 2009, credit card transactions increased by about 85.0% (an annual growth rate of 16.6%).

Various different approaches are used for interbank settlement, as there is no central clearing system for all payment cards. MasterCard, for instance, settles participating banks' net positions through SILOC, while banks participating in the Visa scheme settle obligations arising from card payments in SITRAF. As for three-party schemes, the respective licensed bank receives payments from the cardholders mainly via SILOC, while payments to merchants usually involve intrabank payments (retailers participating in a three-party scheme typically hold an account at the relevant licensed bank).

#### **2.2.4 Debit cards**

Debit cards are typically issued as bank cards. Most include credit and cash withdrawal functions too.<sup>38</sup> The debit card brands issued in Brazil are Visa Electron, MasterCard Maestro and the domestic Cheque Eletrônico brand. In a debit card transaction, the payer's account is usually debited at purchase, while the merchant's account is typically credited on T+1 or T+2 depending on the agreement between the merchant and the respective acquirer.

In 2009, around 2.3 billion debit card payments were made, amounting to a total of about BRL 121.5 billion, with an average value of BRL 53 per transaction. From 2005 to 2009, the number of debit cards increased from 163.9 million (an average of 0.9 cards per capita) to 221.5 million (1.6 cards per capita), which is equivalent to a growth rate of about 35.1% (or 7.8% annually). In the same period, debit card payments increased by around 102.5% in terms of volume (or 19.3% annually).

For interbank settlement, MasterCard and Visa use the approaches described at the end of Section 2.2.3. The net positions of banks participating in the Cheque Eletrônico scheme are settled through SILOC.

#### **2.2.5 Retailer cards**

Mainly issued by large retailers, retailer cards can be used only at the shops of the sponsoring group, ie as in-store credit cards. Typically, cardholders can settle their outstanding balances 1–2 months after a purchase or pay it down in instalments generally without paying interest. As remote payment methods are not available for the settlement of retailer card debt, cardholders have to make payment at the shop by means of cash, cheque or debit card.

The number of retailer cards rose from 97.5 million in 2005 to 196.5 million in 2009, equivalent to an increase of 101.1% over the period (or 19.1% annually). In 2009, around 1.1 billion retailer card transactions were made, amounting to some BRL 59.5 billion (an average value of some BRL 54 per transaction). From 2005 to 2009, retailer card transactions increased by about 98.3% in terms of volume (or 18.7% annually).

#### **2.2.6 Direct debits**

Direct debits are normally used for recurring payments such as utility bills (ie water, electricity and telephone). For such payments, the payer preauthorises his bank to accept funds transfers initiated by the payee. A few days before the payment is due the payee sends the invoice to the payer to be checked. If there are no objections the payer's account is automatically debited on the due date and the payee's account credited. The authorisation is usually valid indefinitely; direct debits therefore continue to be automatically executed until cancelled.

---

<sup>38</sup> The same payment card can be used as debit card or credit card.

Most direct debits are met via intrabank payments. Interbank direct debits are cleared by TECBAN and settled through SILOC. In 2009, around 4.3 billion direct debit transactions were made, amounting to about BRL 5,081.5 billion.

### 2.3 Recent developments

In 2009, the Brazilian banks together with CIP implemented the so-called Authorised Direct Debit (DDA). Despite its name, the service basically allows *bloquetos de cobrança*<sup>39</sup> to be electronically presented to the debtors. Payment can be made either via direct debit or an individual credit transfer. The new process is likely to increase the use of interbank direct debits in Brazil, as direct debits are currently used mainly for intrabank payments.

Meanwhile, the Brazilian payment card industry is undergoing important changes aimed at improving competition among its participants, especially on the acquiring side. These changes are driven mainly by the joint work of the BCB with competition and consumer authorities. One such innovation is the abolition of an exclusivity clause which prevented merchants from entering into a relationship with more than one acquirer per payment card scheme. Today, merchants can use a single POS terminal to capture transactions from any payment card brand.

Internet banking is widely used: at the end of 2009 some 35 million sight deposit accounts could be accessed remotely via internet. In that year, this access channel accounted for some 48% of all banking transactions. For their part, mobile payments, now at a nascent stage, are likely to become an important retail payment channel in coming years, especially for people without direct access to the banking system (some 200 million mobile phones are in use in Brazil and most people have access to one). Currently, Oi Paggo, operated by Telefônica S.A., is the best-known mobile payment scheme.

## 3. Payment systems (funds transfer systems)

### 3.1 General overview

STR is the designated hub of the Brazilian payment system for the following reasons:

- all banks are legally obliged to deposit available funds in accounts held at the BCB; and
- BCB rules specify that:
  - the net positions of systemically important clearing systems must be settled in central bank money;<sup>40</sup>
  - all funds transfers between accounts held at the BCB must be made through STR.

The following diagram shows the links between STR and all other Brazilian clearing and settlement systems.

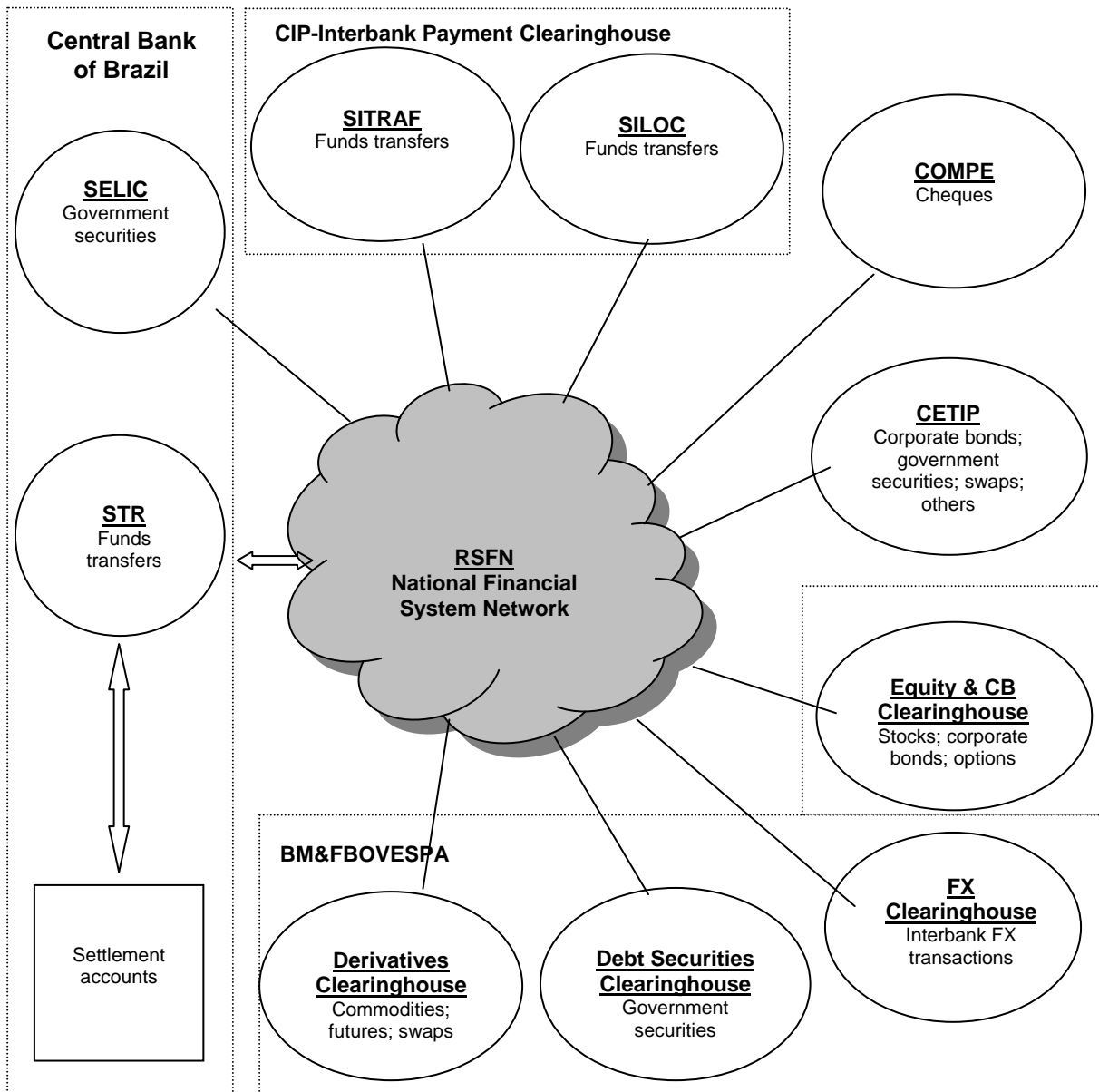
---

<sup>39</sup> See footnote 33.

<sup>40</sup> In practice, all non-systemically important clearing and settlement systems also settle in central bank money, even though this is not mandatory.

Diagram 1

## Overview of the Brazilian clearing and settlement systems



In addition to STR, domestic interbank funds transfers can also be settled by means of SITRAF, or they can be cleared by SILOC before final settlement in STR.<sup>41</sup> Cheques are cleared through COMPE. SITRAF is a hybrid (RTGS-like) settlement system that is considered systemically important and, like STR, allows intraday funds transfers. SILOC and COMPE are non-systemically important multilateral netting systems. For its part, the FX Clearinghouse, which is designated as systemically important, provides clearing services for foreign exchange transactions involving BRL and USD. To a large extent, STR and SITRAF share the same technological platform.

<sup>41</sup> Funds transfers are settled through a particular system (STR, SITRAF or SILOC) mainly on the basis of their value, the purpose of the payment and the speed requested by the remitter.

As a general rule, the bank receiving a credit transfer (TED, TEC or DOC) must credit the payee's account no more than 60 minutes after the interbank settlement has taken place. A further rule applies to TED: after receiving an order, the payer's bank must forward it to the settlement system (STR or SITRAF) within 30 minutes.<sup>42</sup>

The smooth functioning of the national payment system depends particularly on the following factors:

- by means of repo transactions with Brazilian government securities, the BCB extends, free of charge, fully collateralised and unlimited intraday credit to banks holding reserve accounts;
- end-of-day balances are used to verify banks' compliance with reserve requirements. Thus, in the course of a business day, these balances serve as a source of liquidity to settle obligations in STR;
- should a gridlock arise, the BCB can activate the STR's optimisation routines in order to improve system liquidity and settlement efficiency.

Payments clearing and settlement systems are regulated and overseen by the BCB according to principles set by the CMN. Systemically important clearing and settlement systems, as designated by the BCB, must offer settlement certainty and maintain minimum standards of availability<sup>43</sup> and capital.

The clearing and settlement systems are regulated by the Payment System Law. In addition, the legislation mentioned in Section 1.1 regulates payment instruments and the relationship between customers and payment service providers as well as the finality and irrevocability of settlement.

## 3.2 Large-value payment systems

### 3.2.1 Reserves Transfer System (STR)

#### 3.2.1.1 Institutional framework

STR, whose regulations are publicly disclosed, is owned and operated by the BCB.<sup>44</sup>

#### 3.2.1.2 Participation

Participation in STR is mandatory for banks that hold reserve accounts at the BCB<sup>45</sup> and for entities that operate systemically important clearing and settlement systems. Institutions that are permitted rather than obliged to participate in STR include non-banks, such as credit unions and brokerage houses, and entities operating non-systemically important clearing and settlement systems. The National Treasury Secretariat (STN) also participates in the system, since STR settles funds transfers related to the collection of income taxes and payments for

---

<sup>42</sup> The rule is applicable to funds transfer orders that are settled on the same day.

<sup>43</sup> Availability for a given clearing and settlement system is measured by the availability index for the last 12 months, which is the ratio comparing the total time the system actually was available for participants' access with the total time that it should have been available.

<sup>44</sup> The system went live on 22 April 2002.

<sup>45</sup> Reserve accounts are mandatory for commercial banks, universal banks with a commercial bank portfolio and savings banks, but optional for investment banks and foreign exchange banks. The reserve accounts are used as settlement accounts for funds transfers settled through STR.

the federal government. In December 2009, STR had 138 participants (135 banks and three clearing house operators), in addition to the BCB and STN.<sup>46</sup>

### 3.2.1.3 Types of transactions

STR participants can execute funds transfers of unlimited value on their own or a customer's behalf for credit to the account of another participant or its customer. The system plays a central part in settling monetary policy operations, interbank transactions that support the money, capital and foreign exchange markets, and the netting payments of clearing houses. STR accepts credit orders only.<sup>47</sup>

Cheques with a value exceeding the so-called VLB-Cheque,<sup>48</sup> a reference value currently set by the BCB at BRL 250,000, are also settled through STR, as well as payments relating to *bloquetos de cobrança*<sup>49</sup> that exceed the "VLB-Cobrança" (set by the BCB at BRL 5,000). In both cases, settlement is made between banks on a bilateral gross basis.

### 3.2.1.4 Operation of the system and settlement procedures

STR is a real-time gross settlement system. Technical access to the system can be made through either the National Financial System Network (RSFN)<sup>50</sup> or the internet.<sup>51</sup> RSFN has a proprietary messaging protocol based on the XML message standard format. For access via internet, the STR-Web application is used. Typically, banks, clearing houses and the National Treasury Secretariat use RSFN as the primary access channel with internet as a backup. Non-bank financial institutions can use either RSFN or the internet as their primary access channel. Diagram 2 shows the STR's general technical framework.

Participants can choose between four different priority levels for a funds transfer order. The highest is reserved for funds transfer orders for withdrawals and deposits made by banks at the BCB, and for the settlement of clearing house net positions. Transfer orders that do not specify a priority are classified by STR at the lowest level.

A funds transfer order is submitted for settlement as soon as it is received by the system, but it is queued if (i) the remitter has insufficient funds on its settlement account, or (ii) other queued funds transfer orders from the same participant carry an equal or higher priority level. Queuing is not applicable to funds transfer orders related to SELIC (Section 4.4.1) or to orders sent by entities that operate clearing and settlement systems. In these cases, STR immediately rejects the order if funds are insufficient.

---

<sup>46</sup> In practice, non-bank financial institutions began to participate in STR in the second quarter of 2010.

<sup>47</sup> All funds transfers must be individually authorised by the holder of the account to be debited.

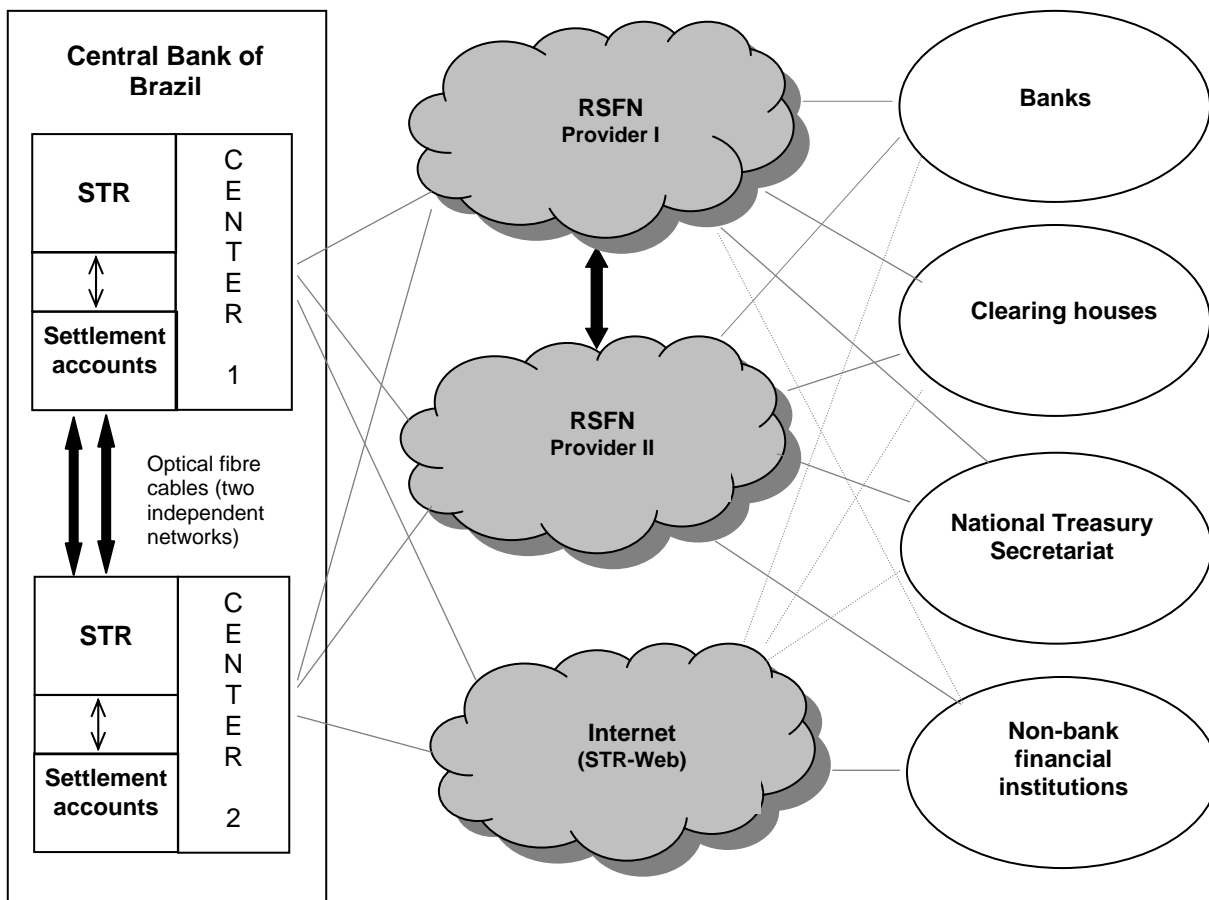
<sup>48</sup> VLB is the Portuguese abbreviation for "Reference value for gross settlement".

<sup>49</sup> See footnote 33.

<sup>50</sup> RSFN is the financial system network that carries message flow through the Brazilian payment system. It is used by financial institutions mainly to access STR and SITRAF. From an operational standpoint, RSFN is underpinned by two independent telecommunication networks. Each operates as a backup service for the other, and both networks meet stringent security, availability and reliability criteria set by the BCB.

<sup>51</sup> Telephone access is also possible as a contingency measure.

Diagram 2  
STR technical framework

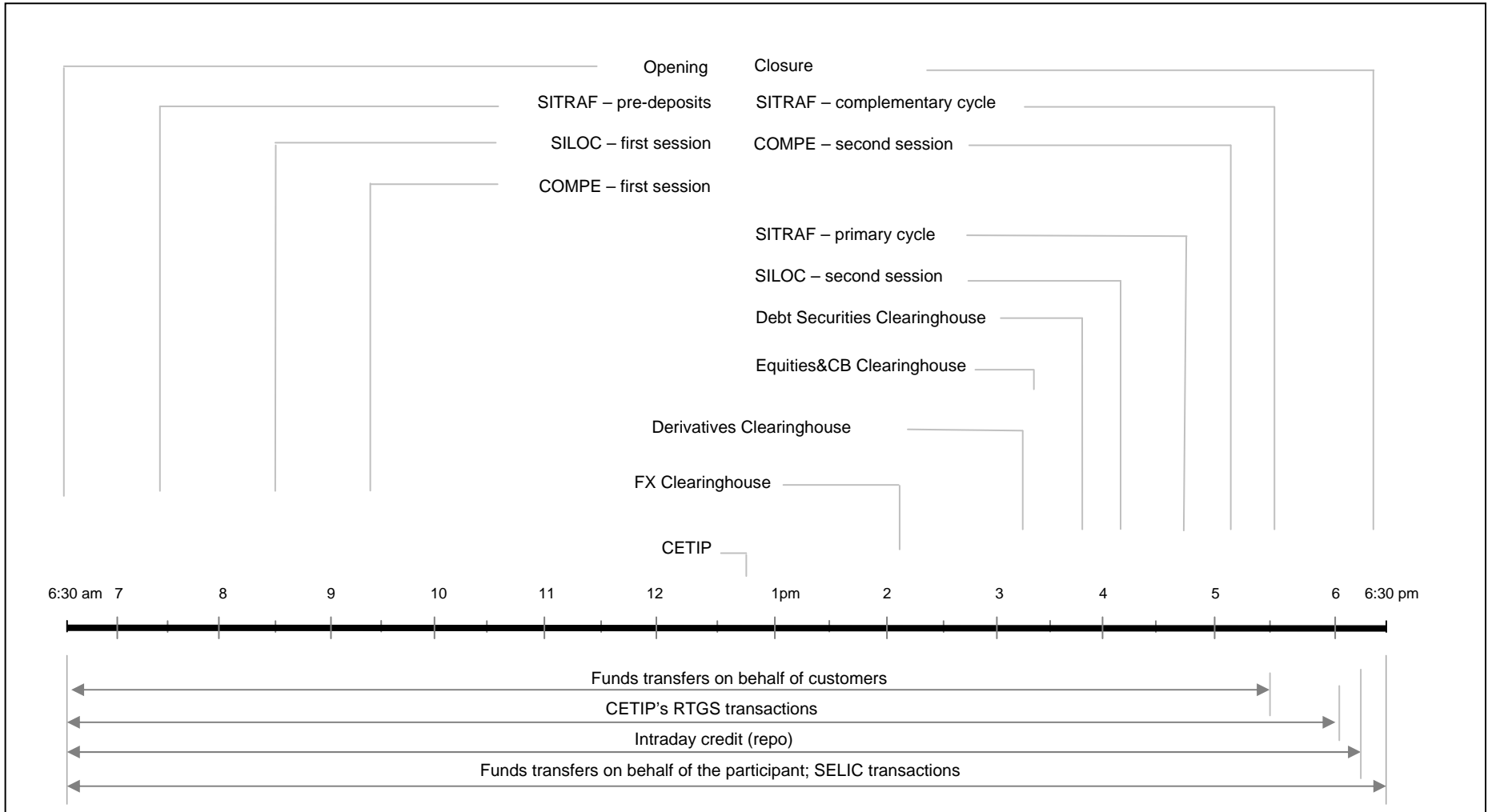


Queued orders are arranged in the following order: (i) by participant; (ii) by preference level; and – in case of equal priority level – (iii) in order of when they were entered into STR. In general, a queued order cannot be settled before a preceding one, ie the settlement occurs on a FIFO (first in first out) basis. In order to avoid gridlock situations in the payments flow, the BCB can activate, if and when it judges necessary, a routine to optimise the settlement process. Settlement is considered final, ie irrevocable and unconditional, at the moment the funds are credited to the relevant settlement account. The receiving participant is notified of the transfer immediately on settlement.

STR is open for settlement of transactions on business days from 06:30 to 18:30 (Brasilia time),<sup>52</sup> but funds transfers on behalf of customers are only permitted until 17:30. The STR settlement schedule, with the main events, is shown in the following chart.

<sup>52</sup> Participants can access the system until 23:59 for transaction-related information including their settlement account balances. The cutoff time for funds transfer orders for settlement on a future date will soon be extended to 23:59.

Chart 2  
STR schedule (Brasília time)



### 3.2.1.5 Risk management

The basic rules of the system, as listed below, prevent credit or liquidity risk arising between the sending bank and the receiving bank: (i) once a funds transfer order is debited to the sending bank's account and credited to the receiving bank's account, settlement is final, ie unconditional and irrevocable; (ii) a funds transfer order is released by the system only if the remitting bank has sufficient funds in its settlement account; and (iii) the receiving bank is notified of any funds transfer order only after it is settled by the system, so that it cannot count on liquidity related to funds transfers that are not yet settled.

To increase participants' liquidity and, hence, avoid a gridlock situation, the BCB uses repo transactions to extend, free of charge, unlimited intraday credit to institutions holding reserve accounts. Participating banks use this facility frequently, as shown in the table below.

Table 3  
**Use of Central Bank of Brazil intraday credit (daily average)**

Year	Total value (BRL billions)	Number of transactions <sup>1</sup>
2005	56.4	486
2006	66.6	531
2007	64.0	476
2008	47.2	389
2009	48.0	294

<sup>1</sup> Rounded number.

Operational risks are mitigated through the use of two operational centres (the secondary centre operating in hot standby mode), a dual telecommunications network and existing contingency access channels. As a systemically important settlement system, the STR's technical infrastructure is designed to achieve an availability index of 99.8%. Operations can be recovered, if disrupted, in no more than 30 minutes.

### 3.2.1.6 Pricing

The STR pricing policy aims at full cost recovery, ie fees are charged to cover all costs, both fixed and variable. Fees are typically charged per transaction; participants pay neither a sign-up nor an annual fee. For a typical funds transfer order, the remitting participant pays from BRL 0.11 to BRL 0.88 depending on when the order is sent to the system (earlier orders are subject to lower fees), while the receiving participant always pays BRL 0.44 per order. For participants using the internet as their main access channel, a monthly charge is also payable (BRL 500, BRL 2,000 or BRL 4,000, depending on the participant's monthly volume of funds transfer orders).

### 3.2.1.7 Major ongoing and future projects

All non-bank financial institutions were granted direct access at the end of 2009. Some new participants, mainly credit unions and brokerage houses, started participating in the system from the second quarter of 2010.

The following new facilities are currently being implemented: (i) automated liquidity saving mechanisms; and (ii) the capability for funds transfer orders to be scheduled for settlement at a specific future date and/or time.



### **3.2.2 Funds Transfer System (SITRAF)**

#### *3.2.2.1 Institutional framework*

SITRAF is owned and operated by CIP (see Section 1.3.3),<sup>53</sup> and overseen solely by the BCB. It complies with the BCB's rules for Brazilian clearing and settlement systems.

#### *3.2.2.2 Participation*

Direct participation is open to all institutions holding a settlement account at the BCB. The system had 89 participants as at December 2009.

#### *3.2.2.3 Types of transactions*

SITRAF settles mainly TED transfers and other funds transfer orders issued by banks' customers for same day settlement. They are typically entered into the system to be settled in "quasi-real time" (typically, more than 97% of all funds transfer orders are released by the system in less than one minute). A future-dated order that has already been entered into the system is first stored and is submitted to the settlement process at the start of the value day.

#### *3.2.2.4 Operation of the system and settlement procedures*

SITRAF is a hybrid (RTGS-like) settlement system with a continuous net settlement process. Participants exchange electronic payment messages via RSFN. The system is supported by two data processing centres (primary and backup) in Rio de Janeiro (the backup centre working in hot standby mode). Funds transfer orders can be processed at a rate of some 133,000 per hour.

Transfers can be settled on a gross basis, in bilaterally netted batches or in multilaterally netted batches (see diagram below for the processing flow).

At the start of each operational cycle, between 06:35 and 07:30 (Brasilia time), each participant makes an initial deposit (pre-deposit) in the SITRAF settlement account at the BCB.<sup>54</sup> Within the SITRAF environment, the initial deposit is credited to each participant's settlement account, where the balance will increase with each inpayment and fall with each outward payment. Participants can top up their SITRAF account at any time during the processing cycle, ie they can transfer funds from their accounts in the STR environment to those in the SITRAF environment. If participants have excess liquidity on account with SITRAF, they can transfer funds to their STR accounts between 10:00 and 16:30.<sup>55</sup>

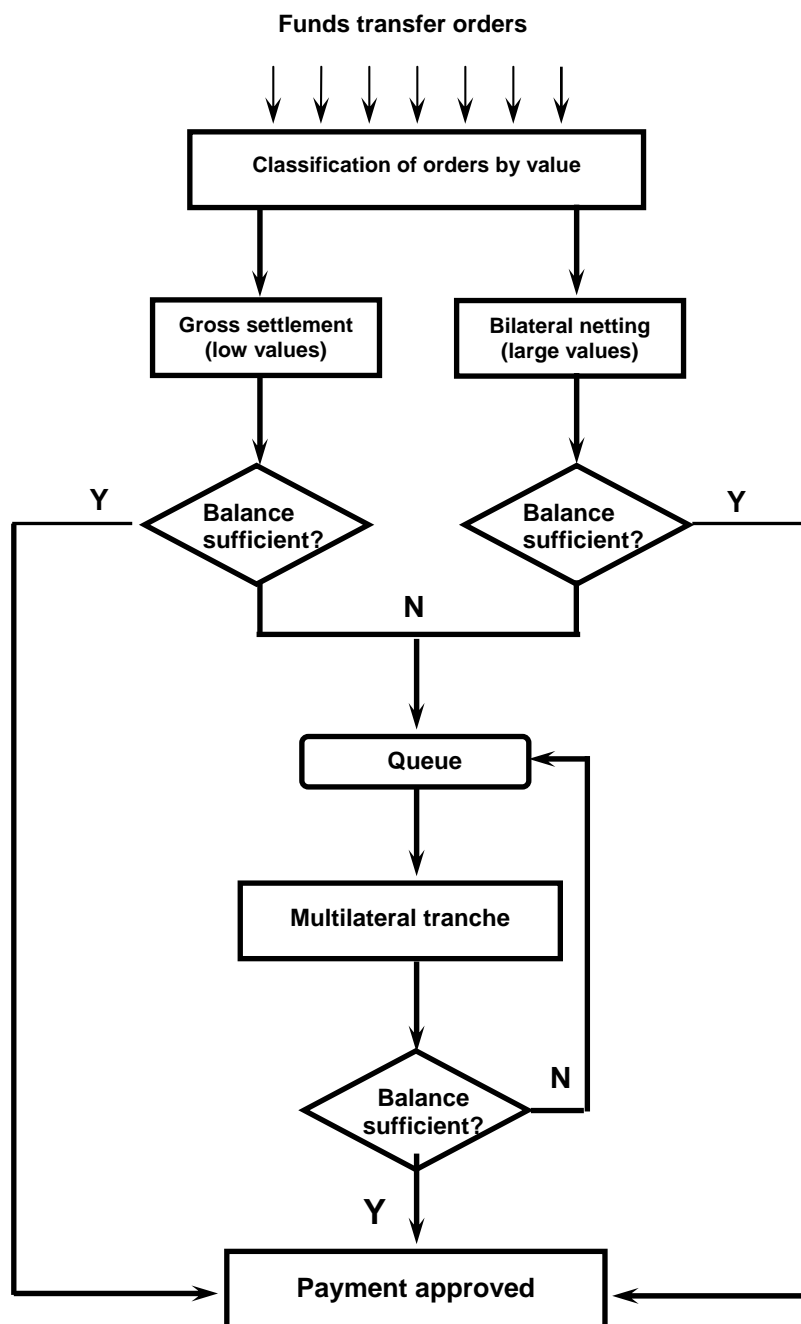
---

<sup>53</sup> The system started operation on 6 December 2002.

<sup>54</sup> The value of the initial deposit for each participant is calculated according to its transaction volume over a set period.

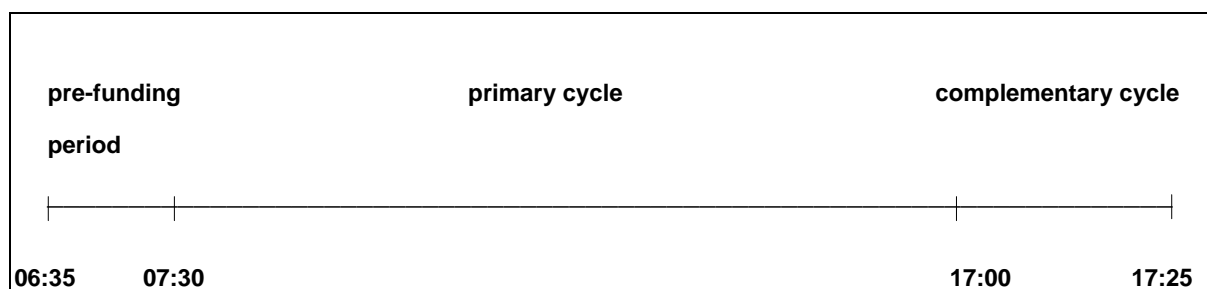
<sup>55</sup> The right to move liquidity between SITRAF and STR settlement accounts (and vice versa) is known as the "liquidity bridge".

Diagram 3

**SITRAF processing flow**

Interbank funds transfer orders can be submitted from 07:30 to 17:00. Each daily settlement cycle comprises a primary and a complementary cycle, as shown below.

Chart 3  
SITRAF schedule



During the primary cycle, funds transfer orders are settled based on the balance of each participant settlement account in the SITRAF environment. All accounts must always have a balance of at least zero. In order to avoid a potential concentration of liquidity during the primary cycle, the system's regulations stipulate that no account can have a balance higher than  $n$  times the amount of the participant's initial pre-deposit. This parameter is established by CIP based on statistical analysis to optimise the payments flow.<sup>56</sup> This upper limit is removed for the last 10 minutes of the primary cycle.

In the complementary cycle, participants with pending funds transfer orders must deposit the necessary funds in the SITRAF settlement account at the BCB by a preset deadline (17:20). The remaining funds transfer orders are then processed and released. At the end of the complementary cycle (17:25), CIP transfers the participants' remaining balances on their SITRAF accounts to their settlement accounts at the BCB.

### 3.2.2.5 Risk management

For an RTGS-like system, the following rules prevent credit and liquidity risks from arising at the system level (ie directly between participants): (i) once a funds transfer order is debited to the remitting bank's account and credited to the receiving bank's account, settlement is final;<sup>57</sup> (ii) a funds transfer order is released by the system only if the remitting bank has sufficient funds on its settlement account; and (iii) the receiving bank is notified of any funds transfer order only after it is settled, so that it cannot count on liquidity related to funds transfers that are not yet settled.

As a systemically important settlement system, SITRAF's technical infrastructure is designed to achieve an availability index of 99.8%. Operations can be recovered, if disrupted, in no more than 30 minutes.

### 3.2.2.6 Pricing

Fees are charged on a full cost recovery basis. For each funds transfer order, fees are charged to both the remitting and the receiving banks, the tariff depending on when the funds transfer is settled (for the remitting bank, the fee ranges from BRL 0.05 to BRL 0.40; for the receiving bank, from BRL 0.27 to BRL 0.40, as at December 2009).

<sup>56</sup> If it breaches its limit, a participant is barred from receiving new incoming transfers. The purpose of this rule is to prevent participants from postponing their payouts.

<sup>57</sup> Even though the participants' final positions are settled in central bank money only at the end of the relevant settlement cycle, SITRAF is deemed to be able to offer intraday finality by both its participants and the BCB, its supervisor, on the basis of the system's robust processes, which are underpinned by the use of pre-deposits on account with the central bank.

### 3.2.2.7 Major ongoing and future projects

Currently no important changes are in hand or at the planning stage.

## 3.2.3 **BM&FBOVESPA – Foreign Exchange Clearinghouse**

### 3.2.3.1 Institutional framework

The Foreign Exchange Clearinghouse is owned and operated by BM&FBOVESPA (see Section 1.3.4.3), which also acts as a central counterparty for all transactions accepted for settlement.<sup>58</sup> It is overseen by the BCB and complies with the BCB's rules for all Brazilian clearing and settlement systems.

### 3.2.3.2 Participation

Banks and brokers authorised by the BCB to operate in the interbank foreign exchange market can participate in the clearing house if they meet the managerial, financial and operational minimum requirements set out in its regulations. To act as a settling agent (direct participant), the participant must hold a settlement account at the BCB (70 direct participants in December 2009).

### 3.2.3.3 Types of transactions

The system settles interbank foreign exchange transactions executed over the counter<sup>59</sup> or through the BM&FBOVESPA-operated electronic trading platform (Global Trading System). So far, only transactions involving BRL and USD are settled through the system. Transactions can be settled on T, T+1 or T+2, as the counterparties choose.<sup>60</sup> The vast majority of transactions, however, settle on T+2.

### 3.2.3.4 Operation of the system and settlement procedures

The FX Clearinghouse is a multilateral net settlement system. There is one settlement session per business day, which starts at 10:45 and ends at 14:05 (Brasilia time). At the beginning of the settlement session, the clearing house informs participants about their net positions to be settled on that day in domestic and foreign currency.

By 13.05, each participant must transfer to the clearing house the net amount of the currency it is selling. The BRL transfers are made to the clearing house's account at the BCB via STR. The USD transfers are made to the clearing house's account at the correspondent bank designated for this purpose.<sup>61, 62</sup> At the end of the settlement session, the clearing house transfers to each direct participant the net amount of the currency it is buying. These transfers are made via STR for BRL, while for USD transfers the clearing house's

---

<sup>58</sup> The system started operation on 22 April 2002.

<sup>59</sup> OTC FX transactions can be settled either directly between the counterparties or through the FX Clearinghouse. In the former case, PVP is not observed. More than 90% of daily trades are settled through the FX Clearinghouse.

<sup>60</sup> Same day settlement requires a transaction to be entered into the system by 10:15.

<sup>61</sup> The FX Clearinghouse uses four correspondent banks in the United States (Citibank, Bank of America, Standard Chartered and Wachovia).

<sup>62</sup> If both the clearing house and the participant hold accounts at the same correspondent bank, funds transfers can be made between accounts of that correspondent bank. Where transfers involve different banks, they must be made through the Federal Reserve's Fedwire funds transfer system.

correspondent banks typically use Fedwire (or, where applicable, USD transfers on the books of a correspondent bank).<sup>63</sup>

### 3.2.3.5 Risk management

BM&FBOVESPA does not take on principal risk since all trades are settled on the PVP (payment versus payment) principle, ie a final transfer of one currency occurs only if a final transfer of the other currency takes place. For this purpose, the clearing house monitors and coordinates the settlement process for both legs of each transaction.

The clearing house also sets limits on the participants' open positions to limit its own exposure to settlement risks. Limits are set with reference to the participant's financial strength and transaction volumes.

Participants must deposit collateral – mainly Brazilian government securities – to cover foreign exchange rate volatility (replacement cost risk). To further diversify its risks, the clearing house uses four correspondent banks in the United States.

Acceptance of a transaction for settlement is subject to an automated risk evaluation process that takes into account each participant's net position, their position limits, available collateral and the acceptability of the contracted foreign exchange rate vis-à-vis the market rate.<sup>64</sup> If a transaction is executed at an out-of-market price, additional collateral will be required before it can be accepted for settlement. Assets posted as collateral are marked to market daily.

In the case of a default, the defaulting participant does not receive the amount of currency that it contracted to buy. Instead, the clearing house uses this amount to complete the transaction by purchasing the currency that the defaulting participant failed to deliver to its counterparty. This currency purchase is made via an outright transaction or a repurchase agreement, as the clearing house treats the participant, respectively, as an actual defaulter or as a defaulter for operational reasons only.

In the first case, the participant is excluded from the system and the related collateral is foreclosed immediately. In the second case, the participant discharges its debt to the clearing house – including any related replacement cost – by the stipulated deadline, allowing a reversion to the repurchase agreement so that the participant can receive the amount of currency it originally contracted for. If the debt is not discharged, the following procedures apply: (i) the participant is deemed to be in default and is excluded from the system; (ii) the collateral it posted is foreclosed; and (iii) the repurchase agreement is converted into an outright transaction.

To mitigate liquidity risk, the clearing house relies on committed facilities from a panel of domestic and international banks. Regardless of the kind of replacement transaction (outright or repurchase agreement), the clearing house purchases the currency to be delivered to the non-defaulting participant from the panel bank that offers the best terms.

The clearing house forecloses on collateral posted by the defaulter in an amount sufficient to cover any movement in the exchange rate. In any event, the non-defaulting participant receives the agreed amount of currency on the due date. If necessary, the clearing house can draw on its committed facilities in domestic or foreign currency to meet the defaulter's obligations.

In addition, the clearing house maintains a settlement fund and a loss-sharing mechanism to guarantee the completion of transactions in case of a participant default. The settlement fund consists of contributions made by participants when they join the system. Contributions vary

---

<sup>63</sup> SWIFT messages are used to order the USD funds transfers to the clearing house's correspondent banks.

<sup>64</sup> To gauge the acceptability of the exchange rate in a trade, the clearing house takes the exchange rate of the most recent transaction and applies a percentage fluctuation band, which is typically set at 2%.

in amount from BRL 1 million to BRL 3 million, depending on the participant's position limit. The loss-sharing mechanism provides for all participants that have transactions to be settled on the day of the default to share the resulting losses, whether or not they carried out transactions with the defaulting participant.

As a systemically important settlement system, the FX Clearinghouse's technical infrastructure is designed to achieve an availability index of 99.8%. Operations can be recovered, if disrupted, in no more than 30 minutes.

### 3.2.3.6 Pricing

Fees are based on the daily USD amount traded by each participant, as follows:

- up to USD 40 million: BRL 5.00 per BRL 1 million traded;
- from USD 40 million to USD 80 million: BRL 4.50 per BRL 1 million traded;
- from USD 80 million to USD 120 million: BRL 4.00 per BRL 1 million traded;
- from USD 120 million to USD 160 million: BRL 3.50 per BRL 1 million traded;
- above USD 160 million: BRL 3.00 per BRL 1 million traded.

### 3.2.3.7 Major ongoing and future projects

BM&FBOVESPA is considering a possible integration of the four clearing houses it operates. A working group is studying the relevant opportunities and challenges.<sup>65</sup> At present, each clearing house has different settlement sessions and risk management procedures, as well as maintaining separate settlement funds. Integration would therefore bring efficiency gains, the extent of which would depend on both the degree of integration and the number of clearing houses involved.

## 3.3 Retail payment systems

### 3.3.1 Cheque Clearinghouse (COMPE)

#### 3.3.1.1 Institutional framework

COMPE is operated by Banco do Brasil (see Section 1.3.3). The system is overseen by the BCB and complies with the BCB's rules for Brazilian clearing and settlement systems.

#### 3.3.1.2 Participation

Participation is mandatory for banking institutions taking sight deposits, and optional for other financial institutions (132 participants in December 2009).

#### 3.3.1.3 Types of transactions

COMPE clears interbank positions arising from cheques with a value lower than BRL 250,000.<sup>66</sup>

---

<sup>65</sup> The working group comprises representatives of different market segments and includes BMF&BOVESPA's own members. Both the BCB and CVM act as observers.

<sup>66</sup> Cheques for amounts of BRL 250,000 or more are settled bilaterally through STR.

#### 3.3.1.4 Operation of the system and settlement procedures

COMPE is a multilateral netting system. Interbank settlement in STR always takes place on T+1, in the morning session or in the afternoon session depending on the value of the cleared cheques. Although cheques are still physically exchanged between banks in Brazil,<sup>67, 68</sup> interbank settlement is fully electronic. Cheque information is converted into electronic data via magnetic ink character recognition (MICR) and then sent to the COMPE operational centres over a proprietary data network. The primary processing centre is located in Brasilia, with a secondary one, working in hot standby mode, in Rio de Janeiro.

Two settlement sessions are carried out daily. For each, a single nationwide multilateral net position is computed for each participant. These net positions are settled through STR on the participants' settlement accounts at the BCB. In the morning session (starting at 09:00), the system settles cheques with a value larger than a reference value (currently BRL 299.99 for so-called "over-the-limit" cheques). Data are sent simultaneously to the primary and secondary processing centres on the previous night, ie on the night of the day the cheques were collected. Cheques with a value lower than the reference value ("below-the-limit" cheques) are settled in the afternoon session (starting at 17:15). These data are sent to the system on the morning of the settlement date.<sup>69</sup>

#### 3.3.1.5 Risk management

There is no mechanism to guarantee the settlement of cheques. A defaulting participant is excluded from the session and related positions are unwound.

#### 3.3.1.6 Pricing

Fees are levied to cover all costs arising from the clearing process (BRL 7.72 per 1,000 documents). In addition, participants share the costs of physically exchanging cheques according to their individual clearing volumes.

#### 3.3.1.7 Major ongoing and future projects

Cheque truncation is the most important project now in progress. At present, cheques are still physically exchanged, generating significant costs in view of COMPE's short settlement cycles and Brazil's vast distances. While this project was initiated some time ago, progress has only recently been made with its implementation.

### 3.3.2 Deferred Settlement System for Interbank Credit Orders (SILOC)

#### 3.3.2.1 Institutional framework

SILOC is owned and operated by CIP (see Section 1.3.3).<sup>70</sup> It is overseen by the BCB and it complies with the BCB's rules for all Brazilian clearing and settlement systems.

---

<sup>67</sup> Cheque truncation is already permitted within the scope of bilateral agreements.

<sup>68</sup> The physical exchange of cheques is managed through a national clearing house, 15 regional clearing houses, and 10 local clearing houses (as at December 2009).

<sup>69</sup> Physical exchange of cheques takes place as follows: "over-the-limit" cheques on the night of the day they are collected (T); "below-the-limit" cheques on the morning of the next day (T+1).

<sup>70</sup> The system started operation on 18 February 2004.

### 3.3.2.2 Participation

The system is open to all financial institutions with a settlement account at the BCB (120 participants in December 2009).

### 3.3.2.3 Types of transactions

SILOC clears interbank positions arising from customer small-value funds transfer orders, ie DOC, TEC and funds transfers relating to bloquetos de cobrança<sup>71</sup> with a value of less than BRL 5,000. The system also clears transactions carried out through TECBAN's shared ATM network ("Banco24Horas") and domestic payments arising from payment card transactions.<sup>72</sup>

### 3.3.2.4 Operation of the system and settlement procedures

SILOC is a multilateral netting system. There is no physical exchange of documents, and a single nationwide net position is computed per participant for each settlement session. Typically, transaction data are sent electronically to the system on the night of the day they are initiated by customers.<sup>73</sup> Net positions are settled through STR on participants' accounts at the BCB, on the same day for TEC, and on T+1 for DOCs, bloquetos de cobrança and transactions from TECBAN's shared network.

Two settlement sessions are carried out daily, one in the morning and the other in the afternoon. SILOC sends electronic files to participants to inform them about their net positions for the morning session before 05:10, and before 15:05 for the afternoon session. In the first session, which ends at 08:20, interbank positions arising from the previous day's transactions are settled. In the second session, ending at 16:10, it is mainly returned items that are settled, ie transactions presented in the morning session that had to be returned to the sending bank.

### 3.3.2.5 Risk management

There is no mechanism to guarantee the settlement of funds transfer orders processed by the system. A defaulting participant is excluded from the relevant session and related positions are unwound.

### 3.3.2.6 Pricing

As in the case of SITRAF, SILOC aims at the full recovery of costs. As of February 2010, a flat fee (typically BRL 0.01905) is charged per processed transaction (BRL 0.35 for returns).

### 3.3.2.7 Major ongoing and future projects

According to the system operator, the following main projects are being assessed (July 2010): (i) implementation of a new facility to control collateral posted by banks participating in payment card schemes; (ii) possible participation in the International Payments Framework (IPF);<sup>74</sup> (iii) enlargement of the scope of the DDA (Direct Debit Authorisation) project so as to

---

<sup>71</sup> See footnote 33.

<sup>72</sup> Currently, MasterCard (both credit and debit cards) and TECBAN's debit cards ("Cheque Eletrônico").

<sup>73</sup> In the case of DOC, TEC and bloquetos de cobrança, data are sent to the entity to which the initial clearing processing is outsourced.

<sup>74</sup> <http://internationalpaymentsframework.org>.



include utility bills;<sup>75</sup> (iv) clearing and settlement of mobile phone payments; and (v) provision of settlement services to Visa and other payment card schemes.

## **4. Systems for post-trade processing, clearing and securities settlement**

### **4.1 General overview**

#### **4.1.1 Regulatory framework**

As set forth by the Securities and Derivatives Market Law, CMN (see Section 1.1) regulates the securities and derivatives markets, and CVM (see Section 1.3.4.1) supervises all related activities and services. By a CMN resolution, securities clearing and settlement systems are under the joint supervision of the BCB and CVM, but the former is solely responsible for assessing aspects relating to systemic risk.

The capital market is also subject to self-regulation in the form of rules established by ANBIMA (1.3.4.2), BSM (1.3.4.3) and CETIP (1.3.4.4).

#### **4.1.2 Infrastructure**

##### *Trading*

Federal government bonds are traded by telephone (in the traditional OTC market) or on a BM&FBOVESPA-operated electronic trading platform (SISBEX).<sup>76</sup> In this market, repurchase agreements predominate over outright transactions. Traditional OTC is also the main trading method for corporate bonds, state government bonds, non-standard derivatives and most securities relating to the National Treasury's special responsibilities. Some of the National Treasury's securities can also be traded at organised OTC markets operated by CETIP and BM&FBOVESPA. All OTC derivatives and securities transactions in which at least one trading party is a financial institution must by law be registered in a system authorised by the BCB or CVM.

Stocks, standardised derivatives and commodities are traded at BM&FBOVESPA, the only Brazilian stock and derivatives exchange. Two electronic trading platforms are used: MEGABOLSA<sup>77</sup> for equities and equity derivatives; and Global Trading System (GTS) for commodities and other derivatives.

The following table provides further information on the trading and registration of securities and derivatives transactions.

---

<sup>75</sup> As already mentioned (Section 2.3), DDA is currently applied only to bloquetos de cobrança, while utility bills are paid mainly by means of intrabank direct debits.

<sup>76</sup> Transactions are registered in SELIC or SISBEX respectively for settlement on a real-time gross basis or with multilateral netting.

<sup>77</sup> MEGABOLSA is a local version of the NSC (*Nouveau Système de Cotation*) trading platform developed by the former Paris Bourse in the early 1990s.

Table 4  
**Securities and derivatives market profile**

Market segment	Equities and equity derivatives	Derivatives	Corporate bonds	Government bonds
Main types of securities	Common and preferred shares; exchange-traded funds; closed-end funds; rights and receipts; BDRs; futures, forwards and options on equities	Futures, options and swaps on interest rates, stock indexes, price indexes, FX rates and actuals	Debentures, commercial paper, asset-backed securities, REITs (real estate investment trusts), and mortgage-backed securities	Fixed rate bonds, inflation-indexed bonds, floating interest rate bonds, foreign exchange-indexed bonds
Numbering system	ISIN	ISIN	ISIN	ISIN
Exchanges	BM&FBOVESPA	BM&FBOVESPA	BM&FBOVESPA	BM&FBOVESPA
Registration entity/system (OTC market)	BM&FBOVESPA	BM&FBOVESPA CETIP	SOMAFIX, BOVESPA-FIX  CETIP (CETIPNET)	SELIC  SISBEX  CETIP (CETIPNET)

Source: Best Brazil – Market Profile.

#### *Post-trade, clearing and settlement services*

In Brazil, the entity that provides securities settlement services usually also provides all post-trade processing, acting both as a clearing house and as a central depository. In the case of BM&FBOVESPA, it also acts as a central counterparty. Hence, the entities providing these services are vertically integrated. In some cases, the integration extends to the trading environment. At the same time, a certain degree of horizontal segmentation exists. SELIC, the BCB-operated DVP1 securities settlement system,<sup>78</sup> settles federal government securities. These securities can also be settled with multilateral netting through the Debt Securities Clearinghouse. For its part, the Equity and Corporate Bond Clearinghouse clears and settles mainly equity transactions, while corporate bonds are primarily cleared and settled through CETIP. Apart from the Equity and Corporate Bond Clearinghouse and the Debt Securities Clearinghouse, BM&FBOVESPA also operates a derivatives settlement system. Diagram 4 provides an overview of the Brazilian clearing and settlement infrastructure for securities and derivatives transactions.

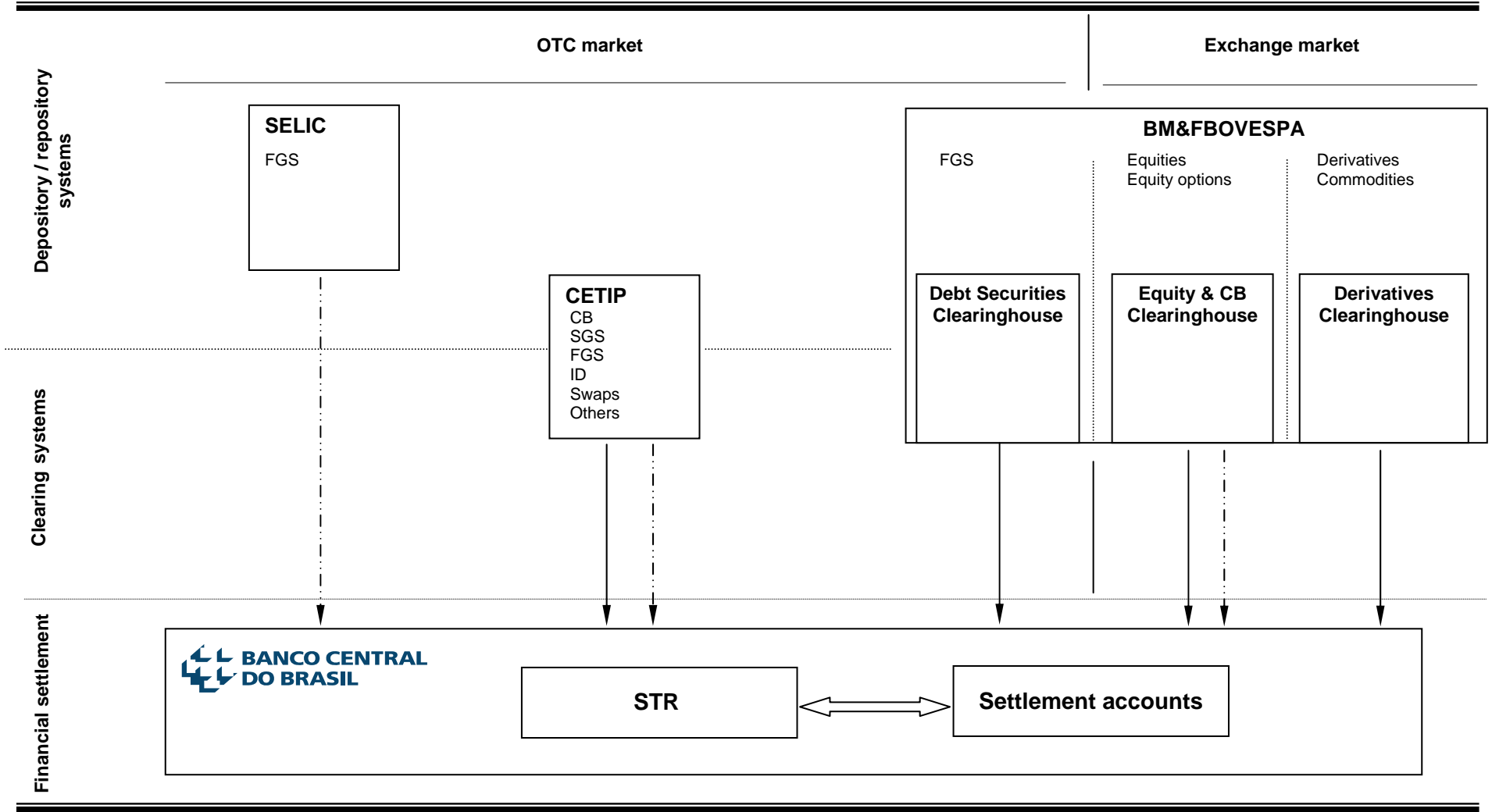
Broadly speaking, DVP is observed in all securities settlement systems, and almost all securities are dematerialised. As required by BCB regulations, all securities and derivatives settlement systems must meet a minimum availability index of 99.8%, and must be capable of recovering their activities, after operational disruption, in no more than two hours.<sup>79</sup>

<sup>78</sup> For a description of different DVP models, see the CPSS report, *Delivery versus payment in securities settlement systems*, 1992.

<sup>79</sup> These requirements also apply to systemically important funds transfer settlement systems (RTGS systems must be capable of recovering activities in less than 30 minutes).

Diagram 4

Overview of the securities and derivatives market



FGS – federal government securities

CB – corporate bonds

SGS – state government securities

ID – interbank deposits

↓ DNS

↓ RTGS

With a view to reflecting the vertical integration of post-trade services in all Brazilian securities and derivatives clearing and settlement systems, they are described in the following order: Section 4.3, which deals with central counterparties and clearing systems, includes CETIP, Equity and Corporate Bond Clearinghouse, Debt Securities Clearinghouse and Derivatives Clearinghouse, even though the first two of these systems could also be described in the section on securities settlement systems/central depositories; Section 4.4, which deals with securities settlement systems, includes SELIC.

## **4.2 Post-trade processing systems**

There is a high degree of vertical integration in all post-trade services for securities and derivatives transactions, including clearing<sup>80</sup> and settlement services. Thus, the relevant systems are described at the end of Section 4.1.2.

## **4.3 Central counterparties and clearing systems**

### **4.3.1 OTC Clearinghouse (CETIP)**

#### *4.3.1.1 Institutional framework*

The OTC Clearinghouse is operated by CETIP (see Section 1.3.4.4). The system is jointly overseen by BCB and CVM (see Section 1.3.4.1). The latter also regulates the securities and derivatives markets.

#### *4.3.1.2 Participation*

Access to the system is open to any institution authorised to operate by the BCB or CVM. The system comprises 9,109 direct participants for securities-leg settlement purposes, of which 119 are direct participants in STR for funds-leg settlement purposes (December 2009).

#### *4.3.1.3 Types of transactions cleared*

CETIP processes mainly transactions involving corporate bonds,<sup>81</sup> state and municipal government securities, securities relating to the National Treasury's special responsibilities,<sup>82</sup> and also OTC derivatives.<sup>83</sup>

#### *4.3.1.4 Operation of the system*

In addition to its role as a clearing house, CETIP is also a central depository for some securities that are traded over-the-counter. Both DVP1 and DVP3 are used for settlement, depending on the type of transaction processed. As a central depository, CETIP maintains

---

<sup>80</sup> The term "clearing" refers to all the processes that take place between trading and settlement.

<sup>81</sup> Certificates of Banking Deposit – CDB, Receipts of Banking Deposit – RDB, Interbank Deposits – DI, Bills of Exchange – LC, Mortgage Bills – LH, debentures, commercial paper, among others.

<sup>82</sup> The obligations are mainly related to state companies, the Salary Variation Compensation Fund (FCVS), the Agricultural Activity Guarantee Program (PROAGRO), and the Agricultural Debt Securities (TDA).

<sup>83</sup> Cash flow swaps, commodities forwards, non-deliverable currency forwards, exchange rate options and others.

accounts at the level of final investors, except in the case of government-issued securities and bank-issued securities, where omnibus accounts are used.<sup>84</sup>

Both counterparties to a transaction enter the related data into the system (dual-entry principle), and the system matches the two entries. To submit transactions, participants use the Market Telecommunication Network (RTM), while RSFN is used for the flow of messages related to the settlement of the funds leg. Straight through processing is always used.

Depending on the type of transaction and the time it is carried out, settlement occurs on T or T+1. Multilateral netting of the funds leg is typically used in the case of primary market transactions, including payment of principal, interest and other corporate actions. On the other hand, bilateral netting of the funds leg is applied for derivatives transactions, and real-time gross settlement is used for the funds leg of securities traded in the secondary market. In all cases, the settlement of the funds leg is via STR except where the same settlement bank is used for both counterparties to a transaction.

#### 4.3.1.5 Risk management

There is no central counterparty for CETIP transactions, so that each participant has to manage the counterparty risk, which is mitigated by the application of DVP to all transactions. Therefore, if a settlement bank does not confirm the payment of a clearing member obligation, participants' multilateral net positions will be recalculated with the exclusion of transactions cleared through the defaulting participant. As a consequence, the transactions relating to the defaulting participant can then be settled bilaterally only, through the RTGS mode. In the event of default by a settlement bank, the system allows for transfer of the multilateral net positions it would have settled to another settlement bank,<sup>85</sup> provided that the related settlement session has not yet ended.

#### 4.3.1.6 Links to other systems

CETIP is linked to STR and SELIC, respectively for settlement of transactions' funds legs and for collateral management purposes.

#### 4.3.1.7 Pricing

CETIP charges fees to its participants according to the service provided (issuance of securities, custody account holding, services related to electronic trading platforms, settlement of transactions etc). For settlement services, the following fees are charged: (i) a monthly fee based on the monthly number of transactions the participant carries out, which varies from BRL 438.97 (up to 45 transactions) to BRL 17,354.75 (more than 3,500 transactions); (ii) a transaction fee, which varies depending on the settlement method and when the transaction is entered into the system (for instance, in the case of multilateral netting or gross settlement, the fee ranges from BRL 0.56 to BRL 1.21 per transaction); and (iii) a funds-leg settlement fee, which corresponds to a percentage of the value of each secondary market transaction (0.0001% or 0.000025% depending on whether settlement is made through STR or on the books of a bank, subject to a minimum and a maximum value).

---

<sup>84</sup> The use of individual investor accounts is required by CVM for all securities under its supervision. This means all securities except for government-issued securities and bank-issued securities. The latter are under the jurisdiction of the BCB, which allows the use of omnibus accounts.

<sup>85</sup> Each non-bank participant has previously informed the system about its primary and secondary settlement banks.

#### 4.3.1.8 Major ongoing and future projects

CETIP plans a new collateral management service based on the one offered by Clearstream.<sup>86</sup> The initial focus will be collateral for OTC derivatives trades entered into the system (bilateral guarantee).

### 4.3.2 **BM&FBOVESPA – Brazilian Securities, Commodities and Futures Exchange**

In addition to the Foreign Exchange Clearinghouse (see Section 3.2.3), BM&FBOVESPA owns and operates the clearing houses described in this section. For all of them, it acts as a central counterparty for all transactions accepted for settlement purposes (except where settlement occurs in real time). As for BM&FBOVESPA itself, see Section 1.3.4.3 for further information.

#### 4.3.2.1 *Equity and Corporate Bond Clearinghouse (former CBLC)*

##### 4.3.2.1.1 *Institutional aspects*

The Equity and Corporate Bond Clearinghouse is jointly overseen by BCB and CVM (see Section 1.3.4.1). The latter also regulates the securities and derivatives markets.

##### 4.3.2.1.2 *Participation*

Banks, brokers and dealers can participate in the system as clearing members, which are classified into three categories: self-clearing members; full clearing members; and specific agents. The first category submits only its own trades and those of its customers. Full clearing members additionally submit transactions conducted by other brokers and special customers, such as mutual funds, pension funds, insurance companies etc, while specific agents also submit some transactions involving corporate bonds.

Besides being BCB-authorized financial institutions, all clearing members must fulfil certain operational and financial requirements. The system comprises 64 clearing members (December 2009).

##### 4.3.2.1.3 *Types of assets and products cleared*

The system clears transactions involving stocks (spot market and derivatives market – options, forwards and futures) and corporate bonds (currently only outright transactions in the spot market). The clearing house also operates a securities lending facility, offering three types of contracts: (i) fixed-term contracts; (ii) contracts where the borrower has the option to return the securities prior to maturity; (iii) contracts where either the lender or the borrower has the option to terminate the transaction prior to maturity (in this case, if the lender calls back the lent securities, the borrower has four days to deliver).

##### 4.3.2.1.4 *Operation of the system*

In addition to being a clearing house, the system is also a central depository for both stocks and some OTC-traded debt securities. Settlement is typically on a DVP3 basis. However, the system's regulations allow for settlement to be carried out on a real-time transaction-by-transaction basis for some transactions, such as those relating to IPOs. As a depository, the system maintains individual custody accounts for every final investor. The settlement cycle depends on the market and the timing of the transaction, as shown in the following table.

---

<sup>86</sup> For details of Clearstream, please refer to the corresponding section in the forthcoming second volume of this publication.

Table 5

**Equity and Corporate Bond Clearinghouse –  
Settlement cycle by type of security and transaction**

Market	Type of transaction	Settlement date
Corporate bonds	Spot	T for transactions entered into the system up to 13:00 and T+1 for others
Stocks	Spot	T+3
	Forwards	(T+n)+3 (third day following the maturity date)
	Futures <sup>1</sup>	(T+n)+3
	Options <sup>2</sup>	T+1

<sup>1</sup> Variation margin is settled on T+1. <sup>2</sup> Date for premium payment (in case of exercise, the normal settlement cycle of the spot market is observed).

All trades carried out through BM&FBOVESPA's trading systems are submitted to the system for settlement as soon as they are executed, which assures a high degree of straight through processing. The clearing house effects novation of each contract in real time, immediately after capturing the transaction from the trading system. At this moment, BM&FBOVESPA becomes the central counterparty for those transactions.

A single settlement session is carried out daily and, in each session, the clearing house computes a net cash position for each clearing member. All related funds transfers are made in STR. A clearing member can hold an account at the BCB or can settle its positions through a settlement bank appointed for this purpose. A clearing member with a net debtor position must transfer the funds to the clearing house's settlement account at the BCB by 15:00. Some minutes later (at 15:25), DVP occurs with the simultaneous and final transfer of both securities and funds.

#### 4.3.2.1.5 Risk management

The system has a principal-to-principal relationship only with clearing members, which are responsible for meeting obligations if a broker associated with them should default. In turn, brokers are responsible for the obligations of their clients, should one of them fail to meet its obligations. As a rule, all clearing members must deposit collateral to cover their open positions. Based on the collateral posted by the clearing members, the clearing house determines the respective position limits. Each clearing member distributes this limit to their associated brokers and each broker, in turn, sets limits for its customers. At each level, the limit can be divided among different markets. The collateral is marked to market daily.

The clearing house calculates in real time the risk each clearing member poses to the system in each settlement cycle, taking into account the cash equity and equity derivatives transactions on the clearing member's book that are not yet settled. For this purpose, it uses the RiskWatch<sup>87</sup> system, applying a 95% confidence level and data for the last 252 business days (historical scenario).

With respect to derivatives and securities lending transactions, the system calls up margin from each original counterparty of a contract in order to cover the related risk exposure.

<sup>87</sup> RiskWatch, a product of Algorithmics Incorporated, Canada, has been adapted for the Brazilian market.

Clearing members also contribute to the system's settlement fund, a mutualised mechanism to cover risks not covered by margin calls. Contributions are set by the RiskWatch system, which is used to calculate participants' exposure daily by stress testing their portfolios (open positions in the derivatives market and securities lending programme). The settlement fund is sufficient to cover the potential failure of the two clearing members with the largest exposures.

If a delivery failure occurs,<sup>88</sup> the clearing house automatically assigns the failed position to the securities lending facility for potential borrowing. If the relevant securities are available for borrowing, the clearing house opens a borrowing transaction in the name of the failing clearing member. If the securities are not available, the clearing house keeps the delivery outstanding and charges the failing clearing member a penalty fee, giving it until T+4 to cover the failed delivery. If the clearing member again fails to meet its obligation, a buy-in procedure is started.

In the case of a payment default, the clearing house typically uses standby credit lines from a panel of banks. These credit lines, which allow the clearing house to borrow against the assets involved in the failures, are large enough to cover the two largest debt positions. Additionally, the clearing house can use the following remedies in the order indicated:

- execution of margins posted by the defaulting participant;
- the contribution made by the defaulting participant to the settlement fund;
- the contributions made by other clearing members to the settlement fund (loss-sharing mechanism); and
- the clearing house's own funds.

#### *4.3.2.1.6 Links to other systems*

The system is linked to SELIC, CETIP, Euroclear and the Depository Trust & Clearing Corporation (DTCC) for collateral management purposes, and to STR for funds leg settlement of all related clearing members' obligations.

#### *4.3.2.1.7 Pricing*

A specific fee is charged for clearing and settlement services (for instance, 0.0006% on the value of the transaction in the case of spot, options and forward markets).<sup>89</sup>

#### *4.3.2.1.8 Major ongoing and future projects*

A possible integration with other BM&FBOVESPA-operated clearing houses is the main project under consideration (see Section 3.2.3.7 for further information).

### *4.3.2.2 Debt Securities Clearinghouse*

#### *4.3.2.2.1 Institutional framework*

The system is jointly overseen by the BCB and CVM (see Section 1.3.4.1). The latter also regulates the securities and derivatives markets.

---

<sup>88</sup> The securities must be delivered by 10:00 on T+3.

<sup>89</sup> Other fees are charged for trading and registration (the latter does not apply to the spot market).



#### 4.3.2.2.2 Participation

The following participants are eligible for a principal-to-principal relationship with the clearing house, thereby posting collateral directly:

- clearing members, which are banks and brokers that clear transactions on their own behalf or for customers;
- centralised settlement participants, which are typically investment funds, pension funds and insurance companies, which clear their own transactions only.

The clearing house comprises 51 clearing members and 390 centralised settlement participants (as at December 2009).

#### 4.3.2.2.3 Types of assets and products cleared

The system clears federal government securities traded on either SISBEX or traditional OTC markets – outright transactions (spot and forward markets) and also repurchase agreements.<sup>90</sup> Spot transactions can be settled on the same day (T), if they are traded and entered into the system by 11:00. Forward transactions are settled on the future date contracted between the original counterparties, which can be up to T+23 (T+1 is most common). For repurchase agreements, the front leg is typically settled on the same day, and the back leg on T+1 (the settlement of the back leg can be as long as T+66).<sup>91</sup> Short sales are allowed only where they involve securities offered by the securities lending programmes provided by either SELIC or BM&FBOVESPA itself.

#### 4.3.2.2.4 Operation of the system

Multilateral netting and DVP3 are used for all transactions accepted for settlement purposes. OTC trades must be submitted to SISBEX by one of the counterparties, subject to confirmation by the other counterparty (dual-entry principle). Trades are only accepted if their prices are within predetermined price ranges. OTC transactions are automatically reported to the clearing house together with those directly traded through SISBEX.

The clearing house daily calculates the multilateral net balances of all direct participants. No later than 13:30 in each settlement session, the clearing house advises participants of the net positions in securities and in cash that they must deliver by 14:30. Debt securities positions and debt funds positions are covered by means of transfers to the clearing house accounts at SELIC and STR, respectively, and the clearing house in turn transfers the securities to net buyers, and funds to net sellers, by 15:30.

#### 4.3.2.2.5 Risk management

All participants are subject to position limits, which are based on the posted collateral and assets traded. These limits are monitored in real time, and all assets are marked to market at least once a day. To manage its risk exposure, the clearing house uses a portfolio risk methodology (stress testing). The methodology is similar to that used by the Derivatives Clearinghouse.

In the event of a delivery failure, the clearing house can apply the following measures in the order indicated: (i) an automatic borrowing transaction by the clearing house on behalf of the

---

<sup>90</sup> Counterparties can choose to settle a transaction involving federal government securities through either the Debt Securities Clearinghouse or SELIC. However, the securities leg will always be settled via SELIC (the Debt Securities Clearinghouse uses delayed net settlement, while SELIC employs real-time gross settlement).

<sup>91</sup> Two types of contracts are permitted: (i) repos in which a specific security is named; and (ii) general collateral repos, where the security is identified only at the end of the trading day.

defaulter to obtain the securities for delivery to the non-defaulting participant; (ii) purchase of these securities on behalf of the defaulter; (iii) replacement of these securities with equivalent ones, subject to the non-defaulting participant's approval; and (iv) payment of the equivalent cash amount to the non-defaulting participant. In any case, the defaulting participant must pay the replacement costs. Collateral is foreclosed in the event of non-payment.

A settlement fund can be used to cover the obligations of a defaulting participant.<sup>92</sup> It can also be used to cover losses sustained by third parties owing to operational failures, whether they are caused by a direct participant or by BM&FBOVESPA itself.

To mitigate liquidity risk in case of a payment failure, the clearing house can draw on standby credit lines from a banking panel to meet obligations due by the end of the relevant settlement session.

#### *4.3.2.2.6 Links to other systems*

The system is linked to STR for settlement of direct participants' net funds positions. It is also linked to SELIC for settlement of participants' net securities positions and also for collateral management purposes.

#### *4.3.2.2.7 Pricing*

Typically, the clearing house charges a total fee of BRL 0.15 per BRL 1 million traded per day.

#### *4.3.2.2.8 Major ongoing and future projects*

A possible integration with other BM&FBOVESPA-operated clearing houses is the main project under consideration (see Section 3.2.3.7 for further information).

### *4.3.2.3 Derivatives Clearinghouse*

#### *4.3.2.3.1 Institutional framework*

The system is owned and operated by BM&FBOVESPA. It is jointly overseen by BCB and CVM (see section 1.3.4.1). The latter also regulates the securities and derivatives markets.

#### *4.3.2.3.2 Participation*

Banks and brokers complying with the requirements set out in the system's regulations – including a minimum capital requirement and proof of managerial, organisational and operational capability – can act as clearing members,<sup>93</sup> or as direct settlement participants.<sup>94</sup> To settle their positions, non-bank participants must have a contractual relationship with an institution holding an account at the BCB, ie with a settlement bank. The clearing house comprises 81 clearing members and 29 direct settlement participants (as at December 2009).

#### *4.3.2.3.3 Types of assets and products cleared*

The clearing house settles spot, forwards, futures, options (both standard and exotic) and swaps contracts, whether they are traded at BM&FBOVESPA or over the counter. The

---

<sup>92</sup> The settlement fund is financed solely by BM&FBOVESPA.

<sup>93</sup> A participant clearing its own transactions as well as transactions carried out by its customers.

<sup>94</sup> A participant clearing its own transactions only, or transactions relating to some special investors as defined in the system's regulations (a large foreign investor, for instance).

financial derivatives contracts are mainly related to interest rates, foreign exchange rates, inflation indices and stock indices. Commodity derivatives contracts are related mainly to sugar, ethanol, livestock, coffee, corn and soybeans.

#### 4.3.2.3.4 Operation of the system

The Derivatives Clearinghouse is a T+1 multilateral netting system.<sup>95</sup> All trades carried out via the Global Trading System are captured immediately after trade execution and no confirmation procedure is required. These trades are therefore submitted for clearing as soon as they are executed. OTC contracts must be entered into the system by a participant and confirmed by the counterparty. Where a contract is entered into the system without identifying its original (final) counterparties, these counterparties must be notified to the system by the related participants by the end of that trading day (this procedure is known as “allocation of trades”).

As the seller to all buyers and the buyer to all sellers, the clearing house carries out multilateral netting of all financial rights and obligations into a single cash-consolidated position, thus reducing participants’ liquidity requirements and optimising collateral. Participants with net debt positions make the payments owed to the clearing house (pay in) by 14:50 of each settlement day, and the clearing house makes payments (pays out) to participants with net credit positions by 15:25. All related funds transfers are made via STR. If a participant is not a banking institution, these funds transfers (pay-ins and pay-outs) are carried out through a settlement bank. If this settlement bank fails to meet a participant’s obligation, the related payment can be carried out through another settlement bank,<sup>96</sup> provided that the settlement session is still open. A secondary settlement bank is also used if, for any reason, the relevant primary settlement bank is unable to receive these payments.

The settlement process observes the following rules:

- delivery of commodities is made on a net traded quantity basis, where applicable; and
- payments related to physically delivered commodities and net financial positions on contracts that are exclusively cash-settled are incorporated into the participants’ multilateral net positions.

A participant is deemed to be in default according to the system’s rules if it fails to (i) meet a financial obligation towards the system; (ii) deliver a commodity at the specified time; (iii) deliver a commodity in accordance with the contracted specifications.

#### 4.3.2.3.5 Risk management

The clearing house’s risk coverage model combines the “defaulter pays” with the “survivors pay” principles. “Defaulter pays” is the main protection mechanism, with all original counterparties required to deposit collateral in proportion to the risk of their open positions. Participants, ie clearing members and direct settlement participants, are also required to post collateral to cover the risk related to trades that have not yet been allocated to the original counterparties. DVP is observed for spot market transactions. In the derivatives market, the clearing house makes daily margin calls, marking to market open positions and collateral. Appropriate haircuts are applied.

---

<sup>95</sup> Counterparties to OTC contracts, which are also accepted for netting purposes, can choose whether BM&FBOVESPA will act as a central counterparty for the transaction.

<sup>96</sup> Based on prudential criteria, the clearing house can specify to a participant which secondary settlement bank should be used in the event of a primary settlement bank’s default. In practice, however, the secondary bank for most participants is the bank owned and operated by BM&FBOVESPA itself (Bank BM&FBOVESPA).

The clearing house sets an intraday risk limit for each participant's open position based on the collateral posted. The clearing house's risk exposure vis-à-vis each participant is reviewed every 15 minutes during a trading session. Should a participant breach its intraday risk limit, the clearing house requires it to post additional collateral on the same day, ie it makes an intraday margin call. Additional collateral may also be required on the same day from an original counterparty. This can occur if the collateral posted is not sufficient to cover the risk arising from trades allocated to an original counterparty in the course of a trading day.

Thus, a two-phase risk monitoring process is used: (i) relating to trades that are carried out during a given trading day but are not yet allocated to the original counterparties. In this case, the clearing house's exposure is reviewed every 15 minutes, taking into account the participants' intraday risk limit (on posted collateral); and (ii) for all open trades executed up to the previous day (for which the original counterparties have already been identified). In this case, the clearing house's risk exposure is reviewed against the original counterparties instead of against the participants themselves.

To assess its risk exposure, the clearing house:

- decomposes the contracts into their risk factors;
- considers a set of stress scenarios for each risk factor;
- calculates the risk arising from participants' portfolios under different sets of scenarios;
- chooses the worst combination.

As collateral, the clearing house accepts cash deposits, highly liquid assets such as federal Brazilian government securities, stocks, certificates of deposit, and certificates of gold deposited in custody at BM&FBOVESPA. In the case of default, ie where a participant or an original counterparty fails to meet an obligation relating to an open position, the clearing house will foreclose on collateral in the following order:

- collateral deposited by the defaulting party;
- collateral deposited by third parties on behalf of the defaulter;
- collateral deposited by brokerage houses that intermediated the trades related to the defaulter, in cases involving commodities;
- collateral deposited by the participant, where the defaulter is an original counterparty and the collateral it posted is not sufficient to cover the relevant debt.

After foreclosing on collateral, the clearing house can, as necessary, look to other resources in the following order: (i) the Clearing Member Fund, which is financed by participants; (ii) the Special Clearing Fund, which is financed by BM&FBOVESPA itself; and (iii) in the case of commodity-related contracts, if still necessary, the Agricultural Market Trading Fund, which is again financed by BM&FBOVESPA itself. Participants contribute between BRL 2 million and BRL 4 million to the Clearing Member Fund, depending on the trades that they are authorised to clear. (Additional contributions are due if the clearing member clears transactions relating to other trading participants). All clearing members are jointly liable for the default of any other clearing member up to the value of their share in the Clearing Member Fund.

As in the case of the other systems operated by BM&FBOVESPA, the Derivatives Clearinghouse maintains standby facilities from a panel of banks to mitigate liquidity risk.

#### 4.3.2.3.6 Links to other systems

The system is linked to STR for settlement of net financial positions, and to SELIC and CETIP for collateral management.<sup>97</sup>

#### 4.3.2.3.7 Pricing

Fee scales depend on the market segment (forwards, futures, options on actuals, options on futures, and spot), as well as access method and commodity type (where applicable), among other criteria.<sup>98</sup>

#### 4.3.2.3.8 Major ongoing and future projects

A possible integration with other BM&FBOVESPA-operated clearing houses is the main project under consideration (see Section 3.2.3.7 for further information).

### 4.4 Securities settlement systems

CETIP and the Equity and Corporate Bond Clearinghouse are described as clearing houses, although, as vertically integrated post-trade infrastructure providers, they are also central depositories and securities settlement systems.

#### 4.4.1 Special System for Settlement and Custody (SELIC)

##### 4.4.1.1 Institutional aspects

The system is jointly operated by the BCB and ANBIMA (see Section 1.3.4.2). The former also regulates and oversees the system.

##### 4.4.1.2 Participation

Besides the National Treasury and the BCB, commercial banks, universal banks, investment banks, savings banks, dealers and brokers, clearing and settlement system operators, mutual investment funds and many other institutions hold custody accounts in SELIC. For funds leg settlement, they are classified as settling participants if they hold settlement accounts at the BCB, or as non-settling participants if they do not. A non-settling participant may be either an independent or a subordinated participant. The former enters its transactions directly into the system, while the latter enters its transactions via its contracted settling participant.

Non-settling participants settle their obligations through their accounts with settling participants.<sup>99</sup> The system comprises 7,656 participants, of which 133 are settling participants, 131 are independent non-settling participants, and 7,392 are subordinated non-settling participants (as at July 2010).

---

<sup>97</sup> BM&FBOVESPA and the Chicago Mercantile Exchange Group have established a strategic partnership which includes a commercial agreement, a cross-investment programme and other initiatives. The commercial agreement underpins an order-routing system that allows CME to provide access to BM&FBOVESPA products via its GLOBEX electronic trading platform. For its part, BM&FBOVESPA can provide access to CME products through its electronic trading platform (GTS).

<sup>98</sup> For further information, please see [www.bmf.com.br/bmfbovespa/pages/boletim2/Custos/Tarifacao2.asp](http://www.bmf.com.br/bmfbovespa/pages/boletim2/Custos/Tarifacao2.asp).

<sup>99</sup> Each non-settling participant can use the services of more than one settling participant.

#### 4.4.1.3 Types of transactions

SELIC only settles OTC transactions that involve securities issued by the National Treasury,<sup>100</sup> whether traded in outright or repurchase operations, including those carried out by the BCB for monetary policy purposes.<sup>101</sup>

#### 4.4.1.4 Operation of the system

SELIC, a DVP1 securities settlement system, is the system used by the BCB as a central depository for securities issued by the National Treasury. The system is also used by the BCB to carry out government securities auctions on behalf of the National Treasury. Omnibus accounts are used for custody services, ie securities are registered in SELIC exclusively in the name of system participants (final investor accounts are maintained at the level of custodian institutions, outside the SELIC system).

Settling participants submit their transactions through RSFN, following standards and procedures set out in the relevant network manuals. Non-settling participants use different networks, according to the procedures specified in the system's regulations. The system is open from 06:30 to 18:30 (Brasilia time). All transactions are entered into the system on the dual-entry principle, ie both participants involved with the settlement of a transaction enter the details into the system and the two entries are then matched.

Since SELIC is a DVP1 settlement system, the settlement of each transaction always depends on the availability of the traded securities in the seller's custody account, and of funds in the settling participant's STR account. If the balance of securities on the seller's custody account is insufficient, the transaction will be held as pending for no longer than 60 minutes or until 18:30, whichever is the sooner (on expiry of this waiting period, the transaction is deleted from the system).<sup>102</sup> For each transaction, the system blocks the related securities and, at the same time, instructs STR to settle the funds leg. When STR settles the funds leg, SELIC transfers the securities to the buyer's account.

#### 4.4.1.5 Risk management

There is no principal risk in transactions submitted to SELIC for settlement, as SELIC is a DVP1 securities settlement system. As mentioned above, securities are blocked at SELIC at the moment when the related funds leg is submitted to STR for settlement. If the buying participant has insufficient funds, the transaction is promptly rejected by STR and, therefore, by SELIC too. In such a case, the relevant securities revert to their previous status, ie they are free for use in another transaction.

However, as in any similar system, the liquidity risk and replacement cost risk faced by participants are not addressed at system level. A securities borrowing and lending programme is available to mitigate the risk of a participant failing to meet its securities delivery obligations.

---

<sup>100</sup> These securities include: fixed rate bonds; inflation-indexed bonds; floating interest rate bonds; and foreign exchange-indexed bonds. Their maturities vary from six months up to 40 years.

<sup>101</sup> The system's regulations permit some "chain transactions". These are used mainly for liquidity-saving purposes (in October 2010, for instance, such transactions accounted for 6% of the daily total value of transactions processed in the system). Although their settlement is processed on a gross basis, the availability of securities and funds is checked by the relevant system, ie SELIC for the securities leg and STR for the funds leg, taking into account the entire transaction chain. When checking the availability of funds and securities, the relevant system will settle all transactions at the same time, provided that all relevant accounts (securities and funds) have a positive balance at the end of the process.

<sup>102</sup> Transactions involving the sale of securities carried out on the same day as they were acquired in a primary auction are not subject to the restriction.

#### *4.4.1.6 Links to other systems*

For collateral management purposes, SELIC is linked to CETIP and all BM&FBOVESPA-operated clearing houses. In the case of the BM&FBOVESPA – Debt Securities Clearinghouse, the link is also used to settle the relevant final positions of securities. SELIC is also linked to STR for settling the funds leg of each transaction.

#### *4.4.1.7 Pricing*

The SELIC pricing policy aims at recovering operational costs. Only a custody fee is charged, ie there is no specific per transaction settlement fee. The custody fee is charged as a percentage of the value of securities deposited in each custody account and ranges from 0.00015% (values larger than BRL 10 billion) to 0.00035% (values up to BRL 5 billion).

#### *4.4.1.8 Major ongoing and future projects*

New features added in November 2010 include a system for electronic securities auctions, a new graphic interface, and a modified access policy for custody accounts (custody account holding was extended to several non-bank financial institutions).

### **4.5 Use of securities infrastructure by the central bank**

All BCB's monetary policy operations involving government securities, as well as intraday credit operations, are carried out through SELIC. All such transactions are settled in real time. BCB also uses SELIC to carry out primary auctions on behalf of the National Treasury.

**Payment, clearing and  
settlement systems in  
Canada**





## Contents

List of abbreviations.....	107
Introduction.....	109
1. Institutional aspects.....	111
1.1 The general institutional framework .....	111
1.1.1 The legal and regulatory framework .....	111
1.2 The role of the central bank .....	114
1.2.1 Operational roles.....	114
1.2.2 Oversight.....	115
1.2.3 Cooperation with other institutions.....	116
1.3 The role of other private and public bodies .....	117
1.3.1 Department of Finance .....	117
1.3.2 The Canadian Payments Association .....	117
1.3.3 Provincial regulators .....	118
2. Payment media used by non-banks .....	118
2.1 Cash.....	118
2.2 Non-cash payments .....	119
2.2.1 Paper-based payments.....	119
2.2.2 Electronic transfers .....	120
2.2.3 Payment cards.....	121
2.2.4 Automated teller machines (ATMs).....	124
2.3 Recent developments .....	124
Contactless and mobile phone payments .....	124
Online debit card payments .....	125
Other recent developments.....	125
3. Payment systems .....	126
3.1 General overview .....	126
3.2 The Large Value Transfer System .....	126
3.2.1 Institutional framework.....	126
3.2.2 Participation .....	127
3.2.3 Types of transactions.....	127
3.2.4 Operation of the system and settlement procedures .....	128
3.2.5 Risk management.....	128
3.2.6 Pricing.....	129
3.2.7 Major ongoing and future projects .....	130

3.3	Retail payment systems – the Automated Clearing Settlement System .....	130
3.3.1	Institutional framework .....	130
3.3.2	Participation .....	130
3.3.3	Types of transactions .....	131
3.3.4	Operation: the transaction processing environment and settlement .....	131
3.3.5	Risk management .....	132
3.3.6	Pricing .....	133
3.3.7	Future developments .....	133
3.4	Offshore payment systems – CLS Bank.....	133
3.5	Other cross-border payment arrangements .....	134
4.	Systems for post-trade processing, clearing and securities settlement.....	135
4.1	General overview .....	135
4.2	Post-trade processing systems .....	135
4.3	Central counterparties and clearing systems .....	135
4.3.1	Canadian Derivatives Clearing Corporation.....	135
4.3.2	CDS Clearing and Depository Services Inc (CDS) .....	137
4.3.3	Natural Gas Exchange Inc .....	137
4.3.4	ICE Clear Canada .....	138
4.4	Securities settlement systems.....	138
4.4.1	CDS Clearing and Depository Services Inc .....	138
4.5	The use of securities infrastructure by the central bank.....	142
4.5.1	Collateral management.....	142
4.5.2	Monetary policy .....	143
4.5.3	Government debt administration .....	143
4.5.4	Client services.....	143

## List of abbreviations

ACSS	Automated Clearing Settlement System
ACV	Aggregate Collateral Value
AMF	Autorité des marchés financiers
ASO	additional settlement obligation
ATM	automated teller machine
BNDS	Bank Note Distribution System
BoC	Bank of Canada
CCP	central counterparty
CDCC	Canadian Derivatives Clearing Corporation
CDS	CDS Clearing and Depository Services Inc
CLS	Continuous Linked Settlement
CP Act	Canadian Payments Act
CPA	Canadian Payments Association
CPSS	Committee on Payment and Settlement Systems
CSA	Canadian Securities Administrators
CUCC	Credit Union Central of Canada
DTCC	Depository Trust and Clearing Corporation
DVP	delivery versus payment
EDI	electronic data interchange
EFTPOS	electronic funds transfer at the point of sale
FCAC	Financial Consumer Agency of Canada
ICE	Intercontinental Exchange
IDP	<i>Interac</i> Direct Payment
IIAC	Investment Industry Association Canada
IIROC	Investment Industry Regulatory Organization of Canada
IMN	Inter-Member Network
LVTS	Large Value Transfer System
MX	Montréal Exchange
MFDA	Mutual Fund Dealers Association of Canada
NGX	Natural Gas Exchange Inc.
OSC	Ontario Securities Commission
OSFI	Office of the Superintendent of Financial Institutions
PAC	Payment Advisory Committee
PCSA	Payment Clearing and Settlement Act
PIN	personal identification number
POS	point of sale
SAC	Stakeholder Advisory Council
SCD	Shared Cash Dispensing
USBE	US Bulk Exchange



## Introduction

Regulatory responsibilities for payment systems are shared between the Bank of Canada and the Federal Minister of Finance. The Bank of Canada has responsibility for the oversight of payment, clearing and settlement systems it has designated for the purpose of controlling systemic risk. The Minister of Finance has certain oversight powers for the Canadian Payments Association, as well as for payment, clearing and settlement systems. The two bodies coordinate oversight activities through a non-statutory body called the Payments Advisory Committee (PAC).

The Canadian Payments Association (CPA), established in 1980, is a not-for-profit organisation with membership open to deposit-taking and certain non-deposit-taking financial institutions. The CPA has a legal mandate to establish and operate systems for clearing and settling payments; to interact with other such systems; and to facilitate the development of new payment technologies. Under this mandate, the CPA owns and operates the two national payments systems: the Large Value Transfer System (LVTS) and the Automated Clearing Settlement System (ACSS). The CPA also owns and operates the US Bulk Exchange System (USBEX), which facilitates the clearing of US dollar-denominated payments between members of the CPA.

The LVTS, Canada's principal system for large-value and time-sensitive payments, began full operations in February 1999. It is an electronic credit transfer system that provides real-time processing and finality of payment. Its risk management arrangements ensure that payments are final and irrevocable once processed and that settlement will occur even in the event of a default by one or more participants with the largest net debit positions.

The ACSS was introduced in 1984 to automate the clearing and settlement of payments in Canada. It is a deferred net settlement system that clears and settles electronic payments and paper-based payments, such as cheques. With the introduction of the LVTS, the ACSS is now primarily oriented to retail payments.

For both the LVTS and ACSS, access to the systems is tiered, with CPA members able to access each system directly or indirectly through other members with direct access. Settlement occurs across accounts that direct participants hold at the Bank of Canada. The LVTS is by far the larger system by value – accounting for approximately 90% of the total value of payments cleared and settled in Canadian payment systems.

A wide variety of options for making cashless payments exists. The use of cheques has continued to decline over the past decade, while electronic payment methods, such as debit and credit card payments and online bill payments, have grown rapidly.

The prevalent credit card networks are operated by Visa, MasterCard and American Express (Amex). The main debit card network in Canada is operated by the Interac Association, which offers two services: a shared network for cash withdrawal from ATMs, and a shared network that allows debit card holders pay for purchases at the point of sale (EFTPOS). Both services are widely used and accepted in Canada.

CLS Bank, in operation since 2002, facilitates the settlement of foreign exchange transactions in 17 currencies, including the Canadian dollar. CLS Bank uses the LVTS as its approved payment system for the Canadian dollar, for the settlement of CLS pay-ins and pay-outs in the currency.

The two systems for clearing and settling securities and derivatives transactions are CDSX<sup>1</sup> and the Canadian Derivatives Clearing Corporation (CDCC). The former is owned and

---

<sup>1</sup> CDSX is the full name of the system; it is not an acronym.

operated by the CDS Clearing and Depository Services Inc (CDS), a subsidiary of the Canadian Depository for Securities Limited, which is itself owned by the major Canadian chartered banks, members of the Investment Industry Regulatory Organization of Canada (IIROC)<sup>2</sup> and the TMX Group.<sup>3</sup> CDCC is a wholly owned subsidiary of the Montréal Exchange (MX), which has itself been owned by the TMX Group since May 2008. By transaction value, CDSX is the larger of the two systems.

In addition to depository services, CDSX facilitates the clearing<sup>4</sup> and settlement of Canadian dollar-denominated debt, money market and equity securities. It can be described as a model 2 delivery-versus-payment (DVP) mechanism:<sup>5</sup> transactions are settled with securities ownership moving on a gross basis in real time while net funds positions are settled at the end of the day via the LVTS.<sup>6</sup> The risk management arrangements ensure that CDSX could adequately settle all transactions even after the failure of the participant with the single largest net obligation to CDS.<sup>7</sup> CDSX also includes two integrated central counterparty facilities, for certain equities and debt.

The CDCC is the central counterparty (CCP) that clears almost all exchange-traded financial derivatives in Canada (except rights and warrants settled in CDSX). Currently, CDCC receives futures and options trades from two sources: the Montréal Exchange and Converge, which provides CCP services for over-the-counter equity options. CDCC is currently working on the implementation of a new CCP service for cash fixed income transactions and repurchase agreements (repos).

The Bank of Canada is involved in the payments and securities clearing and settlement systems in various ways. First, the Bank of Canada oversees the LVTS, CDSX and CLS Bank for the purpose of controlling systemic risk. Second, the Bank provides a settlement account to each of the CPA members that participate directly in the ACSS and the LVTS. Settlement is completed across these accounts. Third, the Bank provides collateralised advances to these same participants to fund end-of-day obligations in the LVTS if necessary. Fourth, the Bank accepts collateral and provides various collateral services in support of LVTS intraday operations and advances. Fifth, the Bank acts as the settlement agent for CDS with respect to the money settlement of CDSX, making and receiving payments on CDS's behalf through the LVTS. The Bank also provides the CLS Bank with a settlement account and makes and receives payments on its behalf through the LVTS. Finally, the Bank of Canada is a CPA member and participates directly in the LVTS and the ACSS. The Bank is also a participant in CDSX.

---

<sup>2</sup> IIROC, which was created in 2008 through the amalgamation of the Investment Dealers Association of Canada and Market Regulation Services Inc, self-regulates aspects of the investment industry in Canada.

<sup>3</sup> TMX Group owns and operates two major stock exchanges in Canada: the Toronto Stock Exchange (for senior equity) and the TSX Venture Exchange (for public venture equity). TMX Group also has other subsidiaries such as the Montréal Exchange (for derivatives trading), the Canadian Derivatives Clearing Corporation (a central counterparty), the Natural Gas Exchange (for natural gas and electricity contracts) and Shorcan (a fixed income inter-dealer broker).

<sup>4</sup> For non-CCP-related services, clearing pertains to reconciliation, confirmation and netting of participants' positions. For CCP-related services, clearing also includes novation.

<sup>5</sup> See Committee on Payment and Settlement Systems, *Delivery versus payment in securities settlement systems*, Basel, 1992, page 4 (<http://www.bis.org/publ/cpss06.pdf>).

<sup>6</sup> CDS's model 2 DVP also has additional risk mitigation features such as: (i) simultaneous transfer of funds and securities at the time of settlement are final and irrevocable; and (ii) negative funds balances are fully collateralised.

<sup>7</sup> See Section 4.2.1: CDSX will settle even in the event of the failure of the largest extender of credit in the system.

## 1. Institutional aspects

### 1.1 The general institutional framework

The general legal and regulatory framework governing payments, clearing and settlement systems is discussed first, followed by a description of those institutions eligible to participate in the Canadian payments system.

#### 1.1.1 The legal and regulatory framework

The general legal framework for the Canadian payments system involves both public laws and private laws. Public laws are rules that have compulsory application by statute and are designed to promote the public interest. They include the *Canadian Payments Act*, the *Payment Clearing and Settlement Act*, the *Bank of Canada Act*, the *Bank Act*, the *Bills of Exchange Act*, the *Currency Act*, provincial securities laws, federal insolvency laws, and federal and provincial consumer protection laws.

Private laws are those rules that establish the legal framework of voluntary arrangements and are created to define and promote individual responsibilities and rights. These laws include property law, commercial law and contract law. They relate, among other things, to the autonomy of contracting parties, the liability for contractual commitments and good faith in mutual relations. For example, the deposit agreements and payments service contracts between individuals and their deposit-taking institutions, as well as the membership criteria, by-laws, procedural rules and operating standards of the Interac Association and credit card companies are legally validated through private law. However, the by-laws and procedural rules of the CPA, which is a statutory body, are defined under both public and private laws.

The most relevant legislation and voluntary standards are discussed below.

#### *The Canadian Payments Act (CP Act)*

The CP Act establishes the role of the Canadian Payments Association (CPA) and the Minister of Finance in the Canadian payments system. The Act gives certain oversight powers to the Minister of Finance respecting payments systems and the CPA.<sup>8</sup>

The CP Act gives the CPA Board of Directors the power to make by-laws (which require the approval of Governor in Council)<sup>9</sup> and rules that set out the procedures and standards governing the daily operations of participants in its national clearing and settlement systems. Among the items covered in the by-laws are the organisational structure of the clearing and settlement systems; the general procedures for the clearing of payments and their subsequent settlement on the books of the Bank of Canada; the description of which classes of items are eligible for clearing in the national system; and the definition of the rights and responsibilities of member institutions. These by-laws, together with the related rules, can be considered to form the operational framework of the LVTS and the ACSS.<sup>10</sup>

#### *The Payment Clearing and Settlement Act (PCSA)*

The PCSA gives the Bank of Canada responsibility for the oversight of payment, clearing and settlement systems in Canada for the purpose of controlling systemic risk. The Bank designates those systems with the potential to create systemic risk as being subject to the

<sup>8</sup> See Section 1.3.1 for more on the role of the Minister of Finance.

<sup>9</sup> The Governor in Council is the federal cabinet, a part of the federal government.

<sup>10</sup> See Section 1.3.2 for more information on the CPA.



PCSA and oversees designated systems for the appropriate control of systemic risk.<sup>11, 12, 13</sup> The PCSA contains provisions that, when combined with federal insolvency legislation, strengthen the legal enforceability of netting in designated systems. In addition, the PCSA contains provisions to ensure that the settlement rules of designated systems are immune to automatic stays, reversal or other legal challenges, even in cases where a participant in one of these systems fails. Thus, the PCSA increases the certainty surrounding the legal arrangements governing the operations of designated clearing and settlement systems. The PCSA also contains provisions with respect to the services the Bank may provide to an eligible system or its clearing house,<sup>14</sup> such as the provision of accounts and liquidity facilities.

#### *The Bank of Canada Act (BoC Act)*

The BoC Act, by governing the powers and activities of the central bank, has an important influence on the institutional framework of Canadian payment, clearing and settlement systems. The Bank may open accounts for commercial banks and other members of the CPA, and these accounts are used to effect the final settlement of payment obligations in the ACSS and the LVTs. The Bank of Canada, as the ultimate source of liquidity to the financial system, is authorised to make loans or advances on a secured basis to commercial banks and other members of the CPA.

#### *Acts governing bills of exchange*

The *Bills of Exchange Act* sets out the statutory framework governing cheques, promissory notes and other bills of exchange. The Act deals with matters such as what constitutes a valid bill of exchange and the rights and obligations of various parties to a bill, including provisions establishing liability in the event of fraud or forgery, and liabilities in the event of the loss of an instrument.

The *Depository Bills and Notes Act* allows clearing houses or depositories to transfer depository bills or notes, such as bankers' acceptances, from seller to buyer through book-entry transfers.

#### *Federal and provincial financial institutions statutes*

The federal financial institutions statutes (*Bank Act, Trust and Loans Companies Act, Cooperative Credit Associations Act and Insurance Companies Act*), coupled with legislation governing provincially incorporated financial institutions, provide the statutory underpinnings of the Canadian financial system. These statutes regulate such matters as corporate ownership and business powers, and define many aspects of the relationships between financial institutions and their customers, the government and some government agencies.

---

<sup>11</sup> The Minister of Finance must be of the opinion that designation is in the public interest. See Section 1.2.2.

<sup>12</sup> The PCSA directs the Bank to be concerned with the oversight of clearing and settlement systems, rather than the regulation of a particular financial market or the supervision of the affairs of individual financial institutions that may be members of these systems. Any matter that is not directly related to an institution's participation in a designated clearing and settlement system is not subject to the Bank's oversight under the PCSA.

<sup>13</sup> The PCSA does not define specific criteria to be used to evaluate the potential for systemic risk. The Bank has, however, published criteria as part of its "Guideline Related to Bank of Canada Oversight Activities". This document is available at <http://www.bankofcanada.ca/en/financial/guide2002.html>.

<sup>14</sup> The PCSA defines a clearing house as a corporation, association, partnership, agency or other entity that provides clearing or settlement services for a clearing and settlement system, but does not include a stock exchange or the Bank of Canada.

Governed by the *Office of the Superintendent of Financial Institutions Act*, the Office of the Superintendent of Financial Institutions (OSFI) is responsible for regulating and supervising federally chartered financial institutions, which include many of the financial intermediaries that provide payment services. OSFI administers the various federal financial institutions statutes and, in carrying out its responsibilities, identifies institution-specific risks and intervenes in a timely manner to prevent or mitigate losses to depositors and policyholders.

The various provincial securities commissions currently regulate and oversee different aspects of the securities industry and capital markets in Canada. For example, the Ontario Securities Commission (OSC) administers and enforces the *Ontario Securities Act*, and the Autorité des marchés financiers (AMF) administers and enforces the *Quebec Securities Act* and the *Quebec Derivatives Act*. Some provincial securities commissions are involved in the regulation of certain clearing and settlement systems for securities and derivatives transactions, such as the systems operated by CDS and CDCC. A regulatory passport system permits some cross-provincial coordination, but this remains limited. In June 2009, the Government of Canada announced the creation of the Canadian Securities Transition Office to develop a national Canadian securities regulator, and in May 2010, it released the proposed *Canadian Securities Act*. The proposed Act would harmonise the existing provincial securities legislation in the form of a single statute. At this time, it is expected that provincial participation will be voluntary and the national regime will apply to provinces and territories that opt in.

#### *The Canadian Code of Practice for Consumer Debit Card Services*<sup>15</sup>

The Canadian Code of Practice for Consumer Debit Card Services is an industry-led initiative that establishes minimum levels of consumer protection in debit card arrangements. The Code was developed and revised through consultation among consumer groups, financial institutions, retailers and government, and is voluntary and not legally binding on organisations that endorse the Code.<sup>16</sup>

#### *Canadian Code of Practice for Consumer Protection in Electronic Commerce*<sup>17</sup>

The Canadian Code of Practice for Consumer Protection in Electronic Commerce provides merchants that choose to endorse the Code with a set of principles and benchmarks for good business practices for conducting commercial activities with consumers online. The code is voluntary and not legally binding. It was developed by various industry representatives and released in 2004. The set of principles addresses consumer information provision, contract formation and fulfilment, online privacy, security of payment and personal information, redress and unsolicited e-mail.

#### *The Code of Conduct for the Credit and Debit Card Industry in Canada*<sup>18</sup>

The Code of Conduct for the Credit and Debit Card Industry in Canada came into effect in August 2010. It was introduced by the Department of Finance to address issues related to

---

<sup>15</sup> The Code of Practice for Consumer Debit Card Services is available at <http://www.fcac-acfc.gc.ca/eng/industry/RefDocs/DebitCardCode/DebitCardCode-eng.asp>.

<sup>16</sup> The following organisations endorse the Code: the Canadian Bankers Association, Canadian Federation of Independent Business, Credit Union Central of Canada, Consumers' Association of Canada, La Fédération des caisses Desjardins du Québec, Retail Council of Canada. In addition, the Canadian Payments Association supports the Code.

<sup>17</sup> The Code of Practice for Consumer Protection in Electronic Commerce is available at <http://cmcweb.ca>.

<sup>18</sup> The Code of Conduct for the Credit and Debit Card Industry is available at <http://www.fin.gc.ca/n10/10-029-eng.asp>.

the costs and conditions of accepting credit and debit cards. It also addresses the application of competing domestic networks on the same card and the issuance of premium credit cards. The purpose of the Code is to ensure that merchants who accept credit and debit cards are fully aware of their payment card costs, have more pricing flexibility and can freely choose which payment options they accept. The Code applies to credit and debit card networks, issuers and acquirers. Compliance with the Code is monitored by the Financial Consumer Agency of Canada (FCAC).

## **1.2 The role of the central bank**

The Bank of Canada has various operational roles as well as responsibility and authority for the oversight of designated clearing and settlement systems operating in Canada, for the purpose of controlling systemic risk.

### **1.2.1 Operational roles**

The Bank of Canada does not own or operate any payment, clearing or settlement systems, although it is a member of the CPA and a participant in the LVTS, ACSS and CDSX. The Bank does, however, provide the following services:

#### *Provision of a settlement asset*

The LVTS and ACSS use claims on the Bank of Canada to settle net payment obligations among those participants that participate directly in these systems.<sup>19</sup> This is supported through the provision of domestic currency settlement accounts by the Bank of Canada to participants.

#### *Standing liquidity facility*

The Bank of Canada provides collateralised, overnight advances to participants in the LVTS. These advances provide a source of immediate liquidity should they need to fund an end-of-day settlement obligation.

An LVTS advance is a secured loan provided by the Bank of Canada to a participant in the LVTS to cover a net amount owed by the institution in its end-of-day LVTS position. The interest rate on the overnight loan is set at the upper limit of the Bank of Canada's operating band for the overnight interest rate – the Bank Rate. Positive balances on the participants' accounts with the Bank of Canada are paid interest at the bottom of the operating band.

#### *Collateral services*

The Bank of Canada performs several functions respecting the collateral pledged to it by direct participants in support of overnight advances and use of the LVTS. The Bank establishes the types of assets acceptable for pledging, values the pledged securities (including an applicable haircut) and reports the valuations to the LVTS.<sup>20</sup>

#### *Settlement agent services*

The Bank of Canada provides accounts and acts as settlement agent, or "banker", for CDSX, which is operated by CDS. CDSX settles trades of debt securities and equities in Canada and reports to participants the net payment obligations owed to (and from) other participants

---

<sup>19</sup> See Section 3 for more on the LVTS and the ACSS.

<sup>20</sup> See *Assets eligible as collateral under the Bank of Canada's standing liquidity facility*, Bank of Canada, July 2010, available at <http://www.bankofcanada.ca/>.

resulting from these trades.<sup>21</sup> To effect settlement, CDS receives LVTS payments into its account at the Bank of Canada from participants that owe money and makes LVTS payments to participants entitled to receive money. In addition, the Bank provides CDS with a cash collateral account and an account for the collection of entitlement payments received via the LVTS during the day.

The Bank of Canada also provides the CLS Bank with a settlement account and makes and receives Canadian dollar payments on its behalf in the LVTS.<sup>22</sup>

As a participant in the LVTS, ACSS and CDSX, the Bank sends and receives payments and conducts securities transactions on its own behalf and on behalf of the federal government, other central banks and foreign official financial institution clients, such as the International Monetary Fund (IMF) and the Bank for International Settlements.

### 1.2.2 Oversight

Under the *Payment Clearing and Settlement Act* (PCSA), the Bank of Canada reviews all eligible payment and other clearing and settlement systems for their potential to pose systemic risk. A system is eligible for review by the Bank if:

- it has three or more participants, one of which is a bank;
- it clears or settles Canadian dollar payment obligations; and
- the payment obligations are ultimately settled through accounts at the Bank of Canada.

If the Governor of the Bank forms the opinion that a system has the potential to pose systemic risk, the system may be designated as subject to the PCSA, provided that the Minister of Finance is of the opinion that this is in the public interest. Once designated, a system has to satisfy the Bank that it has mechanisms in place to manage and control systemic risk associated with the system. The Governor may issue directives to the system operators or to participants in a designated system in extreme situations where the Governor judges that systemic risk is being inadequately controlled. The Bank has designated the LVTS, CDSX and CLS Bank under the PCSA.

The “Guideline related to Bank of Canada oversight activities under the Payment Clearing and Settlement Act”,<sup>23</sup> issued by the Bank of Canada in 2002, describes how the Bank operates under the PCSA, particularly in gathering information to identify systems eligible for review and in determining whether eligible systems will be designated. The guideline also indicates the minimum standards that the Bank applies to designated systems. These minimum standards incorporate the international standards issued by the Committee on Payment and Settlement Systems (CPSS) and the International Organization of Securities Commissions (IOSCO).<sup>24</sup> The LVTS, Canada’s principal system for large-value payments, has been assessed by the Bank as being in full compliance with the 2001 CPSS Core Principles for systemically important payment systems. In addition, in June 2000, the IMF and the World Bank published their Report on the Observance of Standards and Codes on

---

<sup>21</sup> See Section 4.4.1.

<sup>22</sup> Other than CLS, no foreign, non-Canada-domiciled banks are granted direct access to accounts at the Bank of Canada. However, the Bank of Canada provides accounts to other central banks and foreign official institutions.

<sup>23</sup> The guideline is available at: <http://www.bankofcanada.ca/en/financial/guide2002.html>.

<sup>24</sup> For more information, see Clyde Goodlet, “Core principles for systemically important payments systems and their application in Canada”, *Bank of Canada Review*, Spring 2001.

Canada (prepared in the context of the Financial Sector Assessment Program) which concluded that the LVTS is in full compliance with the CPSS core principles.<sup>25</sup> In January 2008, an IMF Report on the Observance of Standards and Codes concluded that CDSX is in full compliance with the majority of the 2001 CPSS-IOSCO recommendations for securities settlement systems.

The PCSA also provides the Bank of Canada with a number of powers that it could exercise with respect to designated payment, clearing and settlement systems. Two noteworthy powers are the ability to provide a guarantee of settlement to particular systems and the ability to pay interest on special deposits accepted from the participants in particular systems. With regard to the former, the Bank of Canada has provided a guarantee that the LVTS will settle in all circumstances. The guarantee could only be called on in the following extremely unlikely circumstances: there is an unanticipated failure of more than one participant on the same day during LVTS operating hours; the failing participants have a net owing position vis-à-vis the system; and the amount owed by the failing participants exceeds the value of collateral that has been pledged to the Bank of Canada.<sup>26</sup>

To carry out its oversight responsibilities, the Bank engages in regular monitoring, meetings and correspondence with the payment system operators; conducts on-site inspections; and reviews proposed changes to a designated system's operations, arrangements, rules and procedures to analyse their implications for systemic risk. The Bank supports these activities through various research initiatives, which help to inform policy-related decisions. Audits and self-assessments of designated systems are conducted annually.

The Bank does not have oversight powers with respect to non-designated systems. It therefore does not oversee or apply any standards to eligible but non-designated systems. However, the Bank regularly monitors developments and conducts research and analysis to periodically assess payment clearing and settlement systems for their potential to pose systemic risk.

### **1.2.3 Cooperation with other institutions**

The Bank of Canada shares oversight authority of CDSX with the Ontario Securities Commission (OSC) and the equivalent securities commission for Quebec, the *Autorité des marchés financiers* (AMF). While there are some common responsibilities in relation to regulating CDSX (eg risk controls), the mandates of these regulators do not fully overlap with the Bank's. The emphasis lies in maintaining strong relationships between the different regulators and there is frequent communication regarding the various changes and amendments to the systems.

With regard to oversight of CLS Bank, responsibilities are shared across the central banks with eligible currencies in the system, including the Bank of Canada. In November 2008, the cooperative oversight arrangement was formalised in a protocol document that provides a mechanism for participating central banks to carry out their individual responsibilities while promoting a consistent oversight approach. The Federal Reserve Bank of New York is the lead overseer of CLS and coordinates the cooperation between participating central banks. The shared oversight arrangement enables CLS to be overseen in a comprehensive manner while keeping to a minimum the duplication of effort.

The Bank of Canada's cooperation with the Department of Finance and the Canadian Payments Association is described in the following section.

---

<sup>25</sup> This report is available at <http://www.imf.org/external/np/rosc/can/index.htm>.

<sup>26</sup> See Section 3.2 for more on the LVTS.

### 1.3 The role of other private and public bodies

#### 1.3.1 Department of Finance

The Minister of Finance has oversight powers respecting the Canadian Payments Association (CPA) and payments systems under the *Canadian Payments Act* (CP Act). These include approval and directive powers regarding by-laws, rules and standards set out by the CPA, or any other payment system designated for such oversight under the CP Act. The main objective of the Minister's oversight is to protect public interests. The Minister oversees the Canadian Payments Association and its systems (ACSS and LVTS).<sup>27</sup>

As both the Bank of Canada and the Minister of Finance have the ability to designate payments systems, a non-statutory body called the Payments Advisory Committee (PAC) has been formed to coordinate oversight activities and to advise the Minister of Finance and Governor of the Bank of Canada on relevant issues. The group is co-chaired by senior officers of the Department of Finance and the Bank of Canada.

#### 1.3.2 The Canadian Payments Association

The Canadian Payments Association (CPA) is a not-for-profit organisation created by an Act of Parliament in 1980 under the *Canadian Payments Association Act*. The Act was modified in 2001 and renamed the *Canadian Payments Act* (the CP Act).

##### *Mandate and services*

The mandate of the CPA under the CP Act is threefold, and in fulfilling this mandate, the CPA has the public policy objective to "... promote the efficiency, safety and soundness of its clearing and settlement systems and take into account the interests of users". The mandate of the CPA is to:

- establish and operate national systems for the clearing and settlement of payments and other arrangements for the making or exchange of payments;
- facilitate the interaction of its clearing and settlement systems and related arrangements with other systems or arrangements involved in the exchange, clearing or settlement of payments; and
- facilitate the development of new payment methods and technologies.

In carrying out its mandate, the CPA owns and operates the two main national systems for the clearing and settlement of payments in Canada: the Automated Clearing Settlement System (ACSS) and the Large Value Transfer System (LVTS). Through a network of committees representing its members and stakeholders, the CPA interacts with financial institutions and users of the payments system operating in Canada and actively investigates emerging payments and payment-related issues and services.

##### *Membership and governance*

Membership in the CPA is open to the Bank of Canada; all domestic banks; foreign banks authorised to operate in Canada; other deposit-taking institutions such as credit union centrals and trust and loan companies; and certain types of non-deposit-taking financial institutions, namely, life insurance companies, securities dealers and money market mutual funds.

---

<sup>27</sup> The Minister may designate other payment systems if it is substantially national in scope or plays a major role in supporting transactions in Canadian financial markets or the Canadian economy. To date, the Minister has not designated a payment system under the Act.



The CPA is governed by a 16-person Board of Directors (Board), where the Chair is a senior representative of the Bank of Canada. Three further positions on the Board are appointed by the Minister of Finance and the rest are elected by CPA members, with half of the seats assigned to “bank” class members and half assigned to “non-bank” members. Also contributing to the mandate of the CPA is the Stakeholder Advisory Council (SAC), which provides advice to the Board on payment, clearing and settlement issues. The SAC consists of no more than 20 persons including two Board members and is broadly representative of the users of the CPA’s services and the service providers.

The CPA operates under the authority of the CP Act. Through its Board, the CPA sets by-laws, rules and standards that govern members’ participation in these systems and outlines operational procedures. All CPA by-laws are approved by Cabinet.<sup>28</sup> CPA rules and standards, including amendments to such, are subject to a 30-day review period by the Minister of Finance who has the power to disallow any rule, in whole or in part, that is not deemed to be in the public’s interest. The Minister also has the authority to direct the CPA to make, amend or repeal a by-law, rule or standard.

### **1.3.3 Provincial regulators**

Every province and territory has one or more bodies to regulate financial institutions under provincial responsibility. The regulation of the securities industry is a provincial responsibility and each province has its securities commission or administrator that is generally accountable to the Provincial Ministry of Finance. These provincial regulators participate in an organisation called the Canadian Securities Administrators (CSA). The CSA’s objective is to coordinate and harmonise regulation of the Canadian capital markets.<sup>29</sup>

## **2. Payment media used by non-banks**

### **2.1 Cash**

The Bank of Canada is the sole issuer of Canadian bank notes under the *Bank of Canada Act*. It is responsible for designing, producing and distributing bank notes. The Bank of Canada meets the public’s demand for bank notes by providing bank notes to financial institutions through the Bank Note Distribution System.<sup>30</sup> Financial institutions distribute bank notes to their own branch network, other financial institutions, retailers and ultimately the public. Notes no longer fit for circulation are returned to the Bank of Canada for destruction. Denominations currently printed and issued are the 5, 10, 20, 50 and 100 dollar bank notes. In late 2011, the Bank of Canada will begin to introduce a new series of bank notes with the same denominational structure.

The Royal Canadian Mint is a crown corporation that operates under the *Royal Canadian Mint Act*. The Mint is responsible for issuing Canadian coin, which is a separate function from the Bank of Canada’s role in issuing bank notes.<sup>31</sup> The Act specifies that all Canadian coins produced by the Mint shall be delivered to the Minister of Finance or a designate. The

---

<sup>28</sup> That is, approved by the executive branch of the federal government.

<sup>29</sup> The CSA website is at <http://www.securities-administrators.ca/>.

<sup>30</sup> See G Bilkes, “[The new bank note distribution system](#)”, *Bank of Canada Review*, Summer 1997.

<sup>31</sup> On occasion, the Department of Finance, the Bank of Canada and the Mint will consult each other and cooperate on certain initiatives, such as the past replacement of the CAD 1 and 2 bank notes by coins.

Department of Finance therefore buys coinage from the Mint and sells it to financial institutions.

The coin denominations currently issued are the 1, 5, 10 and 25 cent pieces and the 1 and 2 dollar pieces. Both bank notes issued by the Bank of Canada, including those notes that are no longer issued but still in circulation, and coins issued by the Royal Canadian Mint are legal tender.<sup>32</sup>

As of 2009, the value of bank notes and coin issued stood at CAD 60.5 billion.

## 2.2 Non-cash payments

Non-cash payments can be divided into paper or electronic payments. Paper-based payments of less than CAD 25 million are cleared through the ACSS.<sup>33</sup> Electronic payments are cleared in both the ACSS and LVTS.<sup>34</sup>

The volume of paper-based items cleared through ACSS has declined considerably with the rapid expansion of electronic payments. In 1990, paper-based items represented 87% of the total number of ACSS transactions and electronic payments represented only 13%. By 2009, paper-based items represented 16% and electronic payments represented 84% of ACSS transactions. The value of paper-based items cleared in ACSS has also declined over time. However, paper-based items represented 58% of the total value of ACSS transactions in 2009, still exceeding that of electronic payments (42%). This can partly be explained by the continued use of large paper-based items,<sup>35</sup> which are those greater than CAD 50,000 and less than CAD 25 million.

### 2.2.1 Paper-based payments

The vast majority of paper-based payments in Canada are cheques. Less frequently used paper items include traveller's cheques, money orders, bank drafts, paper-based remittances and paper preauthorised debits. The framework surrounding the exchange of paper items is set out in the CPA's by-laws, rules and standards.

#### *Cheques*

A cheque is a bill of exchange drawn on a member of the CPA and is payable on demand of the person/institution to whom the item is directed. The statutory framework for cheques is provided by the *Bills of Exchange Act*<sup>36</sup> and they are subject to the by-laws and rules of the CPA.

Cheques were once the predominant method for making cashless payments. However, with the commencement of the LVTS, the use of cheques for large-value payments has decreased substantially as payments have moved to this well risk-proofed, electronic credit transfer system. For small retail transactions at the point of sale too, the use of cheques has

---

<sup>32</sup> The legal tender status of Canadian bank notes falls under the *Bank of Canada Act*: <http://laws.justice.gc.ca/en/B-2/FullText.html>. Coin is considered legal tender in Canada up to certain limits, as is described in the *Currency Act*: <http://laws.justice.gc.ca/en/C-52/FullText.html>.

<sup>33</sup> In 2003, a CAD 25 million limit was imposed on paper items cleared in ACSS. This forced the migration of such large-value payments to the LVTS.

<sup>34</sup> For a description of ACSS settlement, see Section 3.3.4.

<sup>35</sup> LVTS only processes electronic payments. High-value paper items typically relate to business-to-business transactions.

<sup>36</sup> See Section 1.1.1.



given way to debit and credit cards. In 2009, an estimated 1.1 billion cheques worth CAD 3.4 trillion were used in Canada. This represents a decline of almost 20% in volume and 4% in nominal value over the previous five years.

### **2.2.2 Electronic transfers**

Automated funds transfers and account-holder initiated one-time transfers are cleared and settled through the ACSS and subject to the applicable CPA by-laws, rules and standards.

#### *Electronic Funds Transfers*

Electronic funds transfer (EFT) payment media include direct debit (debit transfers) and direct credit. Direct debits are payments preauthorised by the payer. As preauthorised debits, they may be payable at regular intervals for obligations such as rent or mortgage payments, organised savings programmes, bill payments and tax payments. They may also be sporadic payments subject to certain authorisation and notification requirements. The debit and transfer process is initiated by payment instructions from the payee through its financial institution.

Direct credits (or standing orders) are payments transferred on a prearranged basis directly into the payee's account at regular repeating intervals. Each transfer is initiated by payment instructions from the payer to its bank to debit its account and forward the payment to the payee's account at its deposit-taking institution. These include such payment items as direct payroll deposit and regular government transfer payments.

Both direct debit and direct credit have been growing significantly in volume and value. Over the past five years, direct debit grew 28% in volume and 56% in value. Direct credit grew 33% in volume and 76% in value over the same period. In 2009, there were 756 million direct debits worth CAD 604 billion and 703 million direct credits worth CAD 1.4 trillion.

#### *Account-holder initiated transfers*

One-time credit transfers initiated by account holders are often in the form of electronic bill payments. It is increasingly common for consumers and businesses to conduct electronic bill payments over the internet, whether that is on the biller's website, through online banking or through third parties that authorise and accept online payments from customers to pay businesses on the customer's behalf.<sup>37, 38</sup> Account holders may also initiate credit transfers for bill payments using their financial institution's automated telephone banking service or ATMs. Electronic bill payments that clear and settle through the ACSS may fall under the CPA's framework and rules for bill payments, which include the use of electronic data interchange (EDI). (EDI provides remittance information in a standardised format.) However, many small and medium-size billers have end-to-end bill payment arrangements with their financial institutions and do not follow the CPA's bill payment framework or use EDI. The same applies to bill payment services provided by third parties and credit card schemes.

Nonetheless, in 2009, ACSS cleared and settled 2.2 million business-to-business EDI bill payments worth CAD 128 billion and 342 million consumer-to-business EDI bill payments worth CAD 106 billion. Over the previous five years, the combined EDI payments grew a remarkable 93% in volume and 63% in value.

---

<sup>37</sup> For more information, see N Chande, "A survey and risk analysis of selected non-bank retail payments systems", *Bank of Canada Discussion Paper*, no 17, 2008 (<http://www.bankofcanada.ca/en/res/dp/2008/dp08-17.pdf>).

<sup>38</sup> The 2009 Canadian Internet Use Survey, conducted by Statistics Canada, suggested that 67% of Canadians use the internet for online banking or bill payments.

The use of *Interac* Online and *Interac* Email Money Transfer<sup>39</sup> are other examples of credit transfers initiated by account holders; however, the value and volume of these transactions are currently relatively small.

### *Credit transfers through the LVTS*

The LVTS facilitates large-value and time-sensitive credit transfers between direct participants in the system who may act on their own and their clients' behalf. CPA by-laws, rules and standards govern the exchange of these payment instructions. Since the LVTS began operations in 1999, electronic transfers made through this system have grown to account for 90% of all payment value exchanged through CPA-operated systems.

## **2.2.3 Payment cards**

### *Debit cards*

Debit cards in Canada are PIN-based and generally offer two main services to the cardholder. They allow cardholders to pay a vendor through an electronic funds transfer at the point of sale (EFTPOS) and provide access to the ATM networks with which the card issuer is affiliated. With respect to the latter, such networks include the card issuer's proprietary network, and shared networks such as *Interac*, The Exchange, MasterCard Cirrus and Visa Plus.<sup>40</sup> *Interac* offers the principal nationwide network for shared ATM transactions and EFTPOS.<sup>41</sup>

*Interac's* Shared Cash Dispensing (SCD) service allows cardholders to withdraw cash from the ATM of any other *Interac* Association member or associated institution using a debit or credit card with the *Interac* logo. The service uses a shared network, the *Interac* Inter-Member Network (IMN), to connect the proprietary systems of the members for the routing of transactions. In 2009, the SCD service processed 244 million transactions worth a total of about CAD 27 billion.

The *Interac* Direct Payment (IDP) service allows customers to pay for purchases at the point of sale (POS).<sup>42</sup> It also uses the *Interac* IMN to connect acquirers and issuers. Cardholders validate the payment instructions through the use of a PIN, which is verified by the issuer online and in real time for each transaction. Once a debit card transaction is authorised over the IMN, the cardholder's bank account is debited in real time. In 2009, 436,000 merchants accepted debit as a method of payment and 3.9 billion transactions were processed for a total value of CAD 171 billion.<sup>43</sup> With 22 million active debit card users in Canada, this represents an annual average of 174 transactions worth CAD 7,680 per user.

---

<sup>39</sup> See Section 2.3, Recent developments.

<sup>40</sup> Transactions through proprietary networks are typically cleared and settled as "on-us" transactions.

<sup>41</sup> The role of *Interac* Association is to facilitate the development of shared services that support electronic banking and payment services offered by its member institutions. It is a non-profit unincorporated association that sets and enforces rules governing transactions routed over its network, manages network operations, and markets *Interac* services. Any company incorporated in Canada is eligible for *Interac* membership. As of 2010, there were 60 members representing various aspects of the payments industry (including beyond deposit-taking financial institutions). Members are classified as either direct or indirect connectors and consist of issuers, acquirers, connection service providers and settlement agents.

<sup>42</sup> Cross Border Debit, introduced in 2005, is a service that allows *Interac* cardholders to use their debit card at retailers in the United States that are connected to the NYCE network. Agreements have also been developed with PULSE and China Union Pay to allow their cardholders to withdraw cash in Canada at ATMs of participating acquirers.

<sup>43</sup> By comparison, in 2005 some 391,000 merchants accepted debit cards and 3.1 billion debit card transactions were made, worth CAD 137 billion.

Card issuers charge cardholders for access to the shared ATM network and the EFTPOS service. These are often bundled with other account service fees. Additional fees are often charged when the cardholder uses an ATM that is not affiliated with the financial institution that issued their card.

Under the 1996 Consent Order,<sup>44</sup> Interac Association must derive its revenues solely from switch fees and operate on a cost-recovery basis. Interac Association therefore calculates the costs of operating the system to determine the switch fee and collects switch fees from both the issuer and acquirer for every IDP and SCD transaction. These fees are determined at the beginning of the fiscal year based on annual budget requirements.

Debit card interchange fees are not regulated in Canada and the 1996 Consent Order does not restrict Interac's ability to set the level of interchange fees.<sup>45</sup> Interac Association therefore determines the level of interchange fees for IDP and SCD transactions. The interchange fee for IDP transactions is currently set at zero. As such, merchants are typically charged a flat fee by their acquirer for every IDP transaction, as opposed to an ad valorem fee. There is, however, an interchange fee for SCD transactions, which is paid by the card issuer to the acquirer.

All SCD and IDP transactions will be chip-enabled by the end of 2012 and 2015, respectively, as part of a migration towards EMV-compliant chip technology to mitigate debit card fraud.<sup>46</sup>

### *Credit cards*

Credit cards, including charge cards, provide consumers and businesses with uncollateralised borrowing (almost always subject to a prespecified credit limit) for either a cash advance (eg through an ATM) or for purchases at a participating merchant. Payments to merchants can be made at the point of sale, by mail, or over the telephone and internet. Cardholders are billed monthly and, depending on the terms of the card, may pay the whole balance or a partial amount. Interest is charged on the unpaid portion and there is typically a minimum monthly payment. For a cash advance, a consumer may be subject to a fee that is a fixed amount, a percentage of the transaction value, or a fixed amount plus a percentage. In addition to the cash advance fee, the credit card issuer charges interest starting on the date the cash is withdrawn and continues to charge interest daily until the entire cash advance is paid off.<sup>47</sup>

The main general purpose credit card brands in Canada are Visa, MasterCard and Amex. Visa is only issued by financial institutions and MasterCard is issued by financial institutions and offered by some major retailers. As of 2008, card issuers can issue both Visa and MasterCard, which is referred to as duality. Amex is unique because it issues credit and charge cards to consumers and businesses directly. Credit card issuers compete for cardholders by offering reward and loyalty programmes, additional services, such as travel insurance, and competitive interest rates and annual fees. In fact, many credit cards have no annual fees.

---

<sup>44</sup> In 1996, the Competition Tribunal issued a consent order that broadened Interac's membership criteria, established Interac's governance and revenue structure as not-for-profit, and addressed fees, surcharges and other aspects. See <http://www.ct-tc.gc.ca/CMFiles/0093a38PPG-3102004-67.pdf>.

<sup>45</sup> See P Bergevin, "Change is in the cards: competition in the Canadian debit card market", *Backgrounders*, no 125, C D Howe Institute, February 2010.

<sup>46</sup> EMV refers to the global chip technology standards developed by EMVCo.

<sup>47</sup> Source: Financial Consumer Agency of Canada.

Credit card acceptance in Canada is fairly high with over 670,000 merchants accepting 2.7 billion credit card transactions worth CAD 289 billion in 2009.<sup>48</sup> Merchants receive credit card processing services and POS equipment from acquirers. For every credit card purchase accepted, acquirers charge merchants a percentage of the transaction value, which is referred to as the merchant discount rate (MDR).<sup>49</sup> The MDR includes the interchange fee that is paid by the acquirer to the issuer for every transaction.

Credit card interchange fees are not regulated in Canada. In 2009, the Standing Senate Committee on Banking, Trade and Commerce examined the credit and debit card systems in Canada and their relative rates and fees. The Committee's report suggested that the government appoint within an existing federal organisation an "oversight board" that would, among other things, monitor and publish annually information on trends in interchange and other payment system fees.<sup>50</sup> More recently, the Competition Bureau, pursuant to Section 76 of the *Competition Act*, included interchange fees in its December 2010 application to the Competition Tribunal to address the arrangements that Visa and MasterCard impose on merchants for their credit card network services.<sup>51</sup>

As with debit cards, the migration towards EMV-compliant chip technology for credit cards is currently under way. Cardholders with chip cards will have to enter a PIN at the POS instead of signing a receipt.

### *Prepaid cards*

Prepaid cards in Canada have mainly consisted of single-use or reloadable gift/store cards. These cards are either closed loop, ie redeemable at a specific retail store or chain, or semi-closed loop, ie redeemable at multiple merchants within a limited area, such as a shopping mall. A consumer may purchase such cards using traditional methods of payment (eg cash, debit card or credit card). When a card is purchased, the merchant will activate it by swiping its magnetic stripe through the POS terminal. The merchant's payment service provider will then authorise and process future transactions made on the card. Most of these cards are transferable; however, consumers may have the option of registering the card's account number online and uploading funds when desired or automatically.

Single-use gift cards and reloadable store cards are regulated in some provinces. Certain consumer protection laws specifically regulate unclaimed card balances, expiry dates, dormancy fees (ie fees charged for inactive use) and the disclosure of terms and conditions.

Open-loop stored value cards are available in Canada. All three major credit card brands offer prepaid cards that are accepted anywhere their credit cards are accepted. Thus, transactions are processed through their proprietary networks. This allows cardholders to make purchases in-store, online, abroad or over the phone, and to withdraw cash at certain ATMs. However, a variety of fees may be associated with the purchase and use of these cards, including monthly maintenance fees, overdraft fees and card replacement fees. These cards may be issued by participating financial institutions or sold by designated retailers.

---

<sup>48</sup> By comparison, in 2005 there were 626,000 merchants accepting Visa and/or MasterCard credit cards and 1.9 billion transactions worth CAD 210 billion (Source: Canadian Bankers' Association).

<sup>49</sup> See C Arango and V Taylor, "Merchants' costs of accepting retail payments: is cash the least costly?", *Bank of Canada Review*, Winter 2008–09 ([http://www.bank-banque-canada.ca/en/review/winter08-09/arango\\_taylor.pdf](http://www.bank-banque-canada.ca/en/review/winter08-09/arango_taylor.pdf)).

<sup>50</sup> See *Transparency, balance, and choice: Canada's credit card and debit card systems*, Report of the Standing Senate Committee on Banking, Trade and Commerce, June 2009.

<sup>51</sup> The Competition Bureau's notice of application is available at <http://www.ct-tc.gc.ca/Home.asp>.

### **2.2.4 Automated teller machines (ATMs)**

The first cash dispenser was installed in Canada by a large chartered bank in 1969. The first automated banking machine followed in 1972. Today, ATMs are practically ubiquitous and offer a wide range of services. The two main types of ATMs in Canada are full-service ATMs located on the premises of a financial institution, and cash dispensers known as “white label machines”.<sup>52</sup> Full-service ATMs offer cash dispensing as well as banking services to their account holders, including deposits, account balance viewing, bill payments and transfers between accounts held by the same person with the same institution. When the account holder is a customer of the financial institution providing the ATM services, the transaction is routed through a proprietary system and not through Interac’s network for Shared Cash Dispensing (SCD). These so-called “on-us” transactions make up roughly 75% of total ATM transactions. For “on-us” transactions, account holders may be charged regular account fees, depending on their banking arrangements. Customers who withdraw cash from a full-service ATM that is not owned by their financial institution are usually subject to regular account fees, plus network access fees and convenience fees.<sup>53</sup> These transactions are later cleared and settled in ACSS.

White label machines offer basic cash withdrawal services and are independently owned and operated by private companies. They were introduced in Canada in the late 1990s, following the 1996 Consent Order that expanded Interac’s membership eligibility to non-financial institutions.<sup>54</sup> Since then, white label machines have proliferated and are now readily found in almost any retail setting. To access customer accounts, white label machines must connect to Interac’s network for SCD. Thus, customers who use white label machines are subject to network access fees and convenience fees, in addition to their regular account fees.

As of 2009, there were more than 40,000 white label machines in Canada, which far exceeded the 17,000 full-service ATMs. However, the volume and value of transactions made at full-service ATMs is significantly higher than at white label machines. Of the estimated 1 billion ATM cash withdrawals made in 2009, 622 million were at full-service ATMs.

## **2.3 Recent developments**

### **Contactless and mobile phone payments**

Canada is likely to continue to shift towards electronic payment methods as current technologies evolve and new technologies are introduced. The migration towards EMV-compliant chip technology for debit and credit cards, for example, is an opportunity to introduce contactless payments to Canada. Contactless devices, whether they are cards, mobile phones or other devices, use the chip technology with radio frequency identification (RFID) or near field communication (NFC) to transmit information wirelessly. The device is waved in front of a contactless reader to process the payment. However, transactions over a certain maximum value, eg CAD 50, must usually be verified by the consumer’s signature or PIN. Visa PayWave and MasterCard PayPass credit cards and prepaid cards are currently accepted at a limited number of retail locations, particularly grocery or fast-food chains. Interac has begun to introduce a contactless debit card over 2010 and 2011. It too will have

---

<sup>52</sup> For background information and statistics on Canada’s ATM market, see the Canadian Bankers’ Association: <http://www.cba.ca/?lang=en>.

<sup>53</sup> For a list of ATM fees charged to customers, see the Financial Consumer Agency of Canada website: <http://www.fcac-acfc.gc.ca/>.

<sup>54</sup> See Section 2.2.3, Debit cards.

limits on transaction values without specific verification that will be determined by the card issuers.

Contactless tags have been attached to mobile phone handsets in recent pilots. The use of mobile phones for contactless payments will probably become more common as NFC technology is embedded in new phones. Furthermore, as smartphones are increasingly adopted by consumers, more applications will be available to augment mobile payment capabilities, such as account balance viewing and person-to-person (P2P) transfers. The most recent example of a mobile payment scheme is Zoompass, which is the result of a joint venture between three major telecommunication companies in Canada. Transactions are conducted online through a computer, mobile phone browser or mobile phone application. Users sign up for a Zoompass account that is linked to an existing bank account and/or credit card. Once registered, users can transfer funds into their Zoompass account by accessing their bank account through the Zoompass website or through an online bill payment. They can also transfer funds automatically from their bank account to their Zoompass account at set time intervals, or whenever the Zoompass account drops below a certain balance. Zoompass allows users to make P2P payments via their mobile phone. Zoompass account holders can also sign up for a prepaid MasterCard PayPass card that allows for contactless transactions in retail locations.

### ***Online debit card payments***

The *Interac* portfolio has broadened into online services to allow cardholders to access their bank accounts to pay for purchases over the internet and to transfer funds person-to-person. *Interac* Online, introduced in 2005, is currently offered by four financial institutions and accepted by a number of merchants, government agencies and charities. The service directs cardholders to their online banking websites, where the transaction is completed by entering their card number and password. *Interac* Email Money Transfer, introduced in 2004, is a domestic person-to-person funds transfer service that also uses online banking.

### ***Other recent developments***

Another recent development in Canadian retail payments is the announcement by Visa and MasterCard that they plan to introduce PIN-based debit cards (Maestro and Visa Debit). Unlike the existing *Interac* debit cards, these cards will be processed over the card companies' proprietary systems and cardholders will have more opportunity to use a debit card for purchases made online, over the phone or abroad. They will also offer cardholders the benefits of reward programmes and liability protection against unauthorised or fraudulent card use.

Newly introduced regulation directed towards the payment card industry will also shape the retail payments landscape. The 2010 Code of Conduct for the Credit and Debit Card Industry<sup>55</sup> requires payment card network operators and participants to adjust their business practices according to new rules. For example, the Code affects the manner in which Visa and MasterCard are able to introduce their debit cards because of the restriction against competing debit card applications on the same card.

In March 2010, the Government of Canada enacted the *Payment Card Networks Act*, which allows for the regulation of the market conduct of credit and debit card networks and their participants, if necessary. This legislation also expands the mandate of the Financial Consumer Agency of Canada to supervise payment card network operators to monitor their compliance with the Code of Conduct and with any regulations introduced under the new Act.

---

<sup>55</sup> See Section 1.1.1.



In December 2010, the Competition Bureau filed an application with the Competition Tribunal to address the rules that Visa and MasterCard impose on merchants who accept their credit cards.

### 3. Payment systems

#### 3.1 General overview

The CPA owns and operates Canada's two national systems for the clearing and settlement of payments: the LVTS and the ACSS. The LVTS is the larger of the two by transaction value. These systems are described in the following two sections, which are followed by an outline of the options for clearing cross-border payments.

#### 3.2 The Large Value Transfer System

The Large Value Transfer System (LVTS) started its activities on 4 February 1999.<sup>56</sup> It is an electronic credit transfer system that provides real-time processing and real-time finality of payment, as well as guaranteeing settlement. The LVTS is Canada's primary system for clearing and settling large-value Canadian dollar transactions. It is designated under the PCSA for Bank of Canada oversight.<sup>57</sup> It is also closely linked with the implementation of monetary policy. The Bank of Canada sets the target for the overnight interest rate, which is the rate at which LVTS participants lend or borrow funds overnight from each other to settle their end-of-day payment obligations. Changes to the Bank's target for the overnight interest rate influence other interest rates in the market, which affects total spending in the economy, and, ultimately, inflation.<sup>58</sup>

During 2009, LVTS processed, on average, 22,250 transactions per day worth approximately CAD 153 billion, which represents 90% of the total value in the Canadian national payments systems.

##### 3.2.1 Institutional framework

The *Canadian Payments Act* gives the CPA the right to establish by-laws, rules and standards regarding the operation and governance of its systems. The LVTS by-law and associated rules and standards govern all aspects of the LVTS.<sup>59</sup> It is on the basis of these documents that the CPA administers both the daily operations of the LVTS and compliance with transaction rules. Both the Governor of the Bank of Canada and the Minister of Finance are given, by the PCSA and CP Act respectively, certain regulatory powers with respect to the LVTS rules and by-law.<sup>60</sup>

---

<sup>56</sup> For more information on the LVTS, see N Arjani and D McVanel, *A primer on Canada's Large Value Transfer System*, Bank of Canada, March 2006 ([http://www.bankofcanada.ca/en/financial/lvts\\_neville.pdf](http://www.bankofcanada.ca/en/financial/lvts_neville.pdf)).

<sup>57</sup> See Sections 1.3.2 for information on the CPA and 1.1.1 for information on the PCSA and the CP Act.

<sup>58</sup> For more information, see *A primer on the implementation of monetary policy in the LVTS environment*, Bank of Canada, June 2010, available at: [http://www.bankofcanada.ca/en/lvts/lvts\\_primer\\_2010.pdf](http://www.bankofcanada.ca/en/lvts/lvts_primer_2010.pdf).

<sup>59</sup> These rules are publicly available on the CPA website at: [www.cdnpay.ca](http://www.cdnpay.ca).

<sup>60</sup> See Sections 1.1.1 and 1.2.2.

### 3.2.2 Participation

The CPA sets out the requirements for financial institutions to be direct participants in the LVTS. To become a participant, a financial institution must first be a member of the Canadian Payments Association. It must also:

- maintain a settlement account at the Bank of Canada;
- enter into agreements relating to taking loans from the central bank and to pledging the appropriate collateral;
- have access to SWIFT in Canada;
- have the technical capability for its LVTS operations; and
- have adequate backup capability for its LVTS operations.

Beyond these requirements, the LVTS is an open system that does not require financial institutions to maintain a minimum value or volume of transactions to become participants. Foreign bank branches that are members of the CPA are eligible to become direct participants. However, the Governor of the Bank of Canada has the right to prohibit such a participant if the Governor is of the opinion that such a participant poses or is likely to pose an unacceptable risk to the Bank of Canada or the LVTS. Financial institutions that are not participants must use the services of a direct participant in order to make transactions in the LVTS.<sup>61</sup>

As of October 2010, there were 16 direct participants in the LVTS consisting of 12 commercial banks, two federations of credit union centrals, one government savings institution and the Bank of Canada. Direct participation in the LVTS is a reflection of Canada's concentrated banking industry. The decision to be a direct or indirect participant is a business decision that takes into consideration the benefits of direct participation and the operational costs.

### 3.2.3 Types of transactions

The LVTS is an electronic credit transfer system for the final and irrevocable transfer of large-value or time-sensitive Canadian dollar payments. It is used to facilitate a range of transfers such as commercial transactions; correspondent banking transactions; payment (settlement) obligations arising from the Visa and MasterCard networks in Canada; payment obligations arising from the Canadian securities settlement system (CDSX);<sup>62</sup> the Canadian dollar leg of foreign exchange transactions; payment obligations arising from ACSS; and transfers relating to the auction of federal government funds. Although designed to process large-value transfers, no minimum value threshold is set in the LVTS.

Participants send their payments through one of two streams: Tranche 1 or Tranche 2. Tranche 1 is a fully collateralised defaulter-pays mechanism. Tranche 2 uses collateral in a survivors-pay arrangement. Tranche 2 payments account for the majority of LVTS volume since the cost of collateral supporting these payments is lower.<sup>63</sup> On average, for 2009, Tranche 2 accounted for 99% of daily payments volume and 80% of daily payments value.

---

<sup>61</sup> There is no contractual relationship between an indirect participant and the CPA. The relationship is between the direct and indirect participant. However, LVTS rules require direct participants to provide the CPA with a list of other CPA members that have an account with the direct participant and for which the direct participant acts as an agent for LVTS purposes.

<sup>62</sup> See Section 4.4.1.

<sup>63</sup> Section 3.2.5 describes the risk control mechanisms in more detail.



### **3.2.4 Operation of the system and settlement procedures**

Each morning participants set their own net debit cap for Tranche 1 and the bilateral credit limits they grant to each of the other participants for Tranche 2. Based on the bilateral credit lines they grant, the maximum additional settlement obligation (Max ASO) is calculated for each participant. Collateral is pledged to the Bank of Canada in an amount sufficient to cover both the Tranche 1 net debit cap and the calculated Max ASO, ie collateral supporting Tranche 2 payments.<sup>64</sup> Participants often pledge more than the required amount of collateral to ease the process of making intra-cycle adjustments.<sup>65</sup> However, in the event of a default this excess collateral would not be used to effect settlement.

From 00:30 to 18:00, participants send payment messages on their own behalf and on behalf of their clients.<sup>66</sup> Payments during this period are also sent to settle payment obligations arising from the daily auction of federal government funds, the bank note exchange system and other clearing and settlement systems, such as the ACSS, CDSX and CLS. Each payment instruction, whether for Tranche 1 or Tranche 2, is subject to real-time risk control tests which verify that a participant's net debit position does not exceed the appropriate net debit cap.<sup>67</sup> If the tests are passed, funds are made available to the recipient on an unconditional and irrevocable basis.

The general payments exchange period is followed by a half-hour pre-settlement period to allow participants to transact with each other for the purpose of reducing their short or long position in LVTS – thus reducing the amount they may have to borrow from, or have on deposit with, the Bank of Canada overnight.

At the end of the daily cycle, the participant's final multilateral net positions are settled across settlement accounts at the Bank of Canada. These entries are final. After the settlement period, the Bank of Canada lifts its security interest on the amounts pledged as LVTS collateral.

The Bank of Canada facilitates intraday credit to participants in the sense that collateral is pledged to the Bank of Canada in support of final settlement. Participants that have a net debit position in the LVTS at the end of the day close out their position by taking a fully collateralised overnight advance from the Bank of Canada, for which they pay the Bank Rate. Deposits earn Bank Rate less 50 basis points.<sup>68</sup>

### **3.2.5 Risk management**

The LVTS has risk control mechanisms that enable payments to be final and irrevocable even in the unlikely event of a default by one or more participants. In aggregate, the amount pledged by participants to the Bank of Canada is sufficient to ensure settlement in the event of a failure of the participant with the largest possible multilateral net debit position.

The main risk control mechanisms are:

---

<sup>64</sup> The Bank of Canada determines eligible collateral and the conditions that apply. See [http://www.bankofcanada.ca/en/financial/securities\\_160710.pdf](http://www.bankofcanada.ca/en/financial/securities_160710.pdf).

<sup>65</sup> At any time during the payments cycle, participants can adjust their Tranche 1 net debit cap and/or bilateral lines of credit, subject to additional collateral requirements and other conditions.

<sup>66</sup> The period from 00:30 to 06:00 is reserved for CLS activity and non-CLS payments (if bilaterally agreed by participants). General payment exchange occurs from 06:00 to 18:00.

<sup>67</sup> Each participant's position is calculated in real time on a payment-by-payment basis (netting by novation).

<sup>68</sup> See Section 1.2.1.

- Participants determine their own Tranche 1 multilateral net debit caps, which must be fully collateralised. Therefore, in the event of one or more participant defaults, sufficient liquidity will be available to settle all Tranche 1 payments.
- For Tranche 2 payments, each participant extends a bilateral credit line to each other participant, thereby controlling the amount of exposure it is willing to take on with respect to each participant. Further collateral is pledged by each participant to support Tranche 2 payments. The amount pledged is a set portion (called the “system-wide percentage”) of the largest limit it grants to any counterparty. This is called the maximum additional settlement obligation (Max ASO). Participants may adjust the bilateral credit limits they extend throughout the day. However, although such an adjustment may increase the required collateral, the required collateral will never decrease intraday, regardless of the adjustment made.
- In the event of a default, the defaulter’s Tranche 1 and Tranche 2 collateral is used first. Any remaining shortfall is made up by survivors on a pro-rated basis based on the bilateral credit limit extended to the defaulter in Tranche 2. The maximum any survivor will be allotted in the event of one or more defaults is their maximum additional settlement obligation, thereby capping their exposure.
- For Tranche 2, each participant has a multilateral net debit cap which is the sum of all the bilateral credit limits granted to it multiplied by the system-wide percentage.
- The combination of bilateral and multilateral caps and the pledged collateral ensures that the system can handle the failure of the participant with the largest net debit position.

Finally, the Bank of Canada guarantees settlement.<sup>69</sup> However, given the design of the risk controls, this guarantee would only be called upon in the extremely unlikely circumstance that more than one direct participant defaulted within the same LVTS day, the defaulters had an overall net debit position in Tranche 2, and there was not enough collateral to complete settlement. If the Bank needed to invoke its guarantee, it would realise available collateral and become an unsecured creditor of the defaulting institutions for the residual amount.

Regarding operational risk, the CPA has arrangements in place to ensure timely recovery of operations if problems, such as system problems or building unavailability, are encountered. In addition to technical redundancies and contingency procedures for processing payments, the CPA has two operating sites and two data centres. The LVTS rules also require participants to be available to process payments at least 98% of the time in any given 30-day period. The recovery time objective for LVTS is one hour.

### 3.2.6 Pricing

Under the *Canadian Payments Act*, the Canadian Payments Association charges its members dues for their participation in the system based on their volume of activity. The costs for any development projects, as well as the operating costs, are entirely covered by the LVTS participants. The pricing method used by the CPA can be characterised as “cost recovery”. The proportion of the total costs charged to each participant depends on its share of the total volume sent and received through the LVTS. New participants pay an admission fee that covers administrative costs, initial implementation and setup costs, and the costs of verifying the appropriate technical/systems capabilities to participate in the LVTS. Although the Bank of Canada has the right to recover costs for the settlement services it provides to

---

<sup>69</sup> This is a residual guarantee, only invoked once the defaulter’s and survivors’ collateral have been used.

CPA members, it does not presently charge fees beyond the interest charges applied to overnight loans.<sup>70</sup>

### **3.2.7 Major ongoing and future projects**

During 2009, the CPA continued to develop a strategy to evolve its systems and rules framework over the long term. The five-pillar “Vision 2020”, released in February 2010, includes a strategy to enhance the robustness and resiliency of CPA technology, networks and applications for clearing and settlement. To inform the strategy and to ensure that its systems, including the LVTS, continue to perform reliably and cost-effectively, the CPA also initiated a Payment Systems Health Check.<sup>71</sup>

## **3.3 Retail payment systems – the Automated Clearing Settlement System**

The Automated Clearing Settlement System (ACSS), introduced in 1984, is owned and operated by the CPA. This uncollateralised deferred net settlement system clears and settles primarily retail electronic payments and paper-based payments in Canada. The ACSS is used to process a high volume of lower-value, less time-sensitive payments that do not require the intraday finality provided by the LVTS.

In 2009, the ACSS handled an average of 23 million payment items per day, with an average total value of CAD 20 billion.

### **3.3.1 Institutional framework**

Under the CP Act, the CPA administers the ACSS by-law and supporting rules which govern all aspects of the operation of the ACSS. All by-laws must be approved by the Minister of Finance. The Minister of Finance has the right to disallow any new rule or amendment within 30 days.<sup>72</sup>

### **3.3.2 Participation**

The ACSS and related arrangements are based on a tiered structure with direct and indirect participants (also known as direct clearers/group clearers and indirect clearers). Only direct clearers and group clearers and the Bank of Canada can make entries in the ACSS.<sup>73</sup> Direct clearers enter transactions directly into the system and settle for the net value of payment items drawn on or payable by it through their settlement accounts at the Bank of Canada. They can also act as clearing agents for indirect clearers. In order to be eligible to become a direct clearer, an institution must:

- be a member of the CPA;
- be a deposit-taking institution or a securities dealer;
- process payment items volume of at least 0.5% of the total national volume of payment items;
- establish and maintain a settlement account at the Bank of Canada;

---

<sup>70</sup> The Bank of Canada pays interest on deposits at a rate below the target overnight rate.

<sup>71</sup> Further information about Vision 2020 and the Payment System Health Check is available from the CPA.

<sup>72</sup> Both the ACSS by-law and the associated rules are available on the CPA website at: [www.cdnpay.ca](http://www.cdnpay.ca).

<sup>73</sup> See Section 1.1.2 for a complete description of institutions eligible for CPA membership.

- establish a loan facility with the Bank of Canada; and
- satisfy the technical requirements of the ACSS.

Group clearers must fulfil the same requirements. In addition, they must provide a list of entities that belong to the group and show that there are contractual commitments to act as group clearer.

Indirect clearers are members of the CPA that enter into the ACSS through the services provided by a direct clearer. Items drawn on an indirect clearer or payable to one are settled through a settlement account at a direct clearer.

As of December 2010, there were 11 direct clearers in the ACSS consisting of eight commercial banks, two federations of credit union centrals and one government savings institution. In addition, there were 107 indirect clearers. The Bank of Canada also participates in ACSS.

### **3.3.3 Types of transactions**

The ACSS clears and settles a variety of primarily retail payment instruments. Paper-based items include, for example, cheques, money orders, gift certificates, remittances and traveller's cheques. Electronic payment items include direct debit and direct credit items (or standing orders); account holder-initiated payments; electronic funds transfers initiated at the point of sale (EFTPOS) and cash disbursements through shared ATM networks such as Interac.<sup>74</sup>

All items must meet specifications and standards set out in the ACSS rules according to the type of payment item. For this purpose, the items are grouped into "streams" that share the same rules and procedures. A CAD 25 million cap is imposed on the value of individual paper items that can be cleared through the system. Payments greater than CAD 25 million must be sent electronically via EFT or LVTS. There are no value restrictions on other types of payments in the system.

### **3.3.4 Operation: the transaction processing environment and settlement**

Payment items exchanged throughout the day are processed overnight and settled the next day. The specifics of the exchange and clearing of the items vary depending on the item, for example, whether exchanged on paper or via electronic data transmission. Nevertheless, all items follow a similar path.

Clearing of paper-based instruments is handled through six regional settlement points across the country and the specifics differ according to the type of payment item. Generally, paper-based items collected by CPA members previous to and throughout the value day (V) are forwarded to a local data centre operated, or contracted, by a direct clearer. At the data centre, high-speed computerised reader/sorter equipment sorts the items according to the institutions on which they are drawn. Once sorted, the items drawn on other institutions are delivered to the data centres of the appropriate direct clearer in the same regional clearing area. The delivering direct clearer enters into its ACSS terminal the information of the exchanged items, including the volume and value of items with a "stream" identifier. This information can be checked by the receiving direct clearers' data centre and disputed if necessary. The next day, the payment items are returned to the branches of the institutions on which they are drawn according to the type of payment item. For cheques, most are returned no later than two days after they are deposited.

---

<sup>74</sup> See Section 2.2.2 for a more detailed description of the various payment types.

Electronic payments, such as point of sale, EFT and EDI payments are entered into ACSS through a virtual exchange region called the National Electronic Settlement Region. These entries are used to calculate each direct clearer's net position for settlement on the next business day.

This exchange of items, entering of information into the ACSS terminals and, potentially, contesting of entries continues on the value day until the final closing time. The ACSS calculates a multilateral net position across all "streams" for each of the direct clearers. By 08:00 the next morning (V+1), the financial institutions have typically finished making adjustments to their clients' accounts, debiting payers' accounts and crediting payees' accounts. At approximately 09:30, initial net balances are available to all the direct clearers. Bilateral reopenings of the clearing may occur to correct errors if both counterparties agree. By 11:00, the final multilateral positions of the direct clearers are calculated and made known to the Bank of Canada.

Direct clearers' net positions are settled by adjustments to their settlement accounts at the Bank of Canada. This is typically completed by 12:00 EST on V+1. Direct clearers in a net debit position make an LVTS payment to their ACSS account at the Bank of Canada. Direct clearers in a net credit position have the funds credited to their account and value is returned to them through an LVTS payment on V+1. ACSS members have agreed to an interest compensation mechanism to allow them to give provisional credit to their clients on day V even though ACSS settlement occurs on day V+1. The CPA calculates the interest compensation, so that direct clearers in a net credit position receive an interest payment to cover the cost of crediting depositors before receiving the funds through settlement and direct clearers in a net debit position make interest payments. Interest is calculated at the Target Overnight Rate.<sup>75</sup> The interest compensation adjustments are included in the clearing balances exchanged through the LVTS.

### 3.3.5 Risk management

The ACSS is a survivors-pay, uncollateralised, deferred net settlement system. The settlement entries in the direct clearers' accounts at the Bank of Canada are considered to be final. However, the ACSS does not legally support settlement finality, intraday or at the end of the day.<sup>76</sup>

Participants take on credit risk throughout the day as value is credited to client accounts in anticipation of receiving funds through settlement the next day. However, there are circumstances under which this value may not be received. For instance, some types of payments may be reversed when an item presented is drawn on an account with insufficient funds or if the item is subject to a stop payment order. CPA rules govern the process for the reversal of these payment items. Also, value may not be received in the rare event that a direct or indirect clearer defaults on its settlement obligation. In this situation, the CPA rules outline the default procedure, which includes the immediate return of payment items drawn on the defaulting member and the reversal of the debit posting to the settlement account of that member.<sup>77</sup> They also stipulate the additional settlement obligations required from the surviving participants to cover the remaining shortfall. These rules will be modified in the near future, as outlined in Section 3.3.7 below.

---

<sup>75</sup> The Target Overnight Rate set by the Bank of Canada is the average interest rate the Bank wants to see in the market for financial institutions lending to each other overnight. For more information, see "Target for the Overnight Rate fact sheet", available at <http://www.bankofcanada.ca/en/backgrounders/bg-p9.html>.

<sup>76</sup> The ACSS rules indicate that only certain payment items settled in ACSS are irrevocable and irreversible.

<sup>77</sup> For a description of risks and default procedures in the ACSS, see *A guide to risk in payment systems owned and operated by the CPA*, CPA, 2005 ([http://www.cdnpay.ca/imis15/pdf/pdfs\\_publications/Risk\\_Guide.pdf](http://www.cdnpay.ca/imis15/pdf/pdfs_publications/Risk_Guide.pdf)).

Some degree of liquidity risk is experienced daily through the uncertainty related to the final net settlement obligation due at 12:00 EST. For credit and liquidity risk, participants cannot use real-time risk management tools in the ACSS to control their exposure. For example, there are no bilateral or multilateral credit limits.

Regarding operational risk, the contingency arrangements for the ACSS are similar to those for the LVTS. However, the recovery time objective is four hours.

### **3.3.6 Pricing**

The CPA recovers its operating costs through dues charged to its members. Each year, the total assessment is determined based on the costs of operating the system. The amount each member pays is based on its proportional share by volume of the ACSS payment items it sent and received compared to the total volume of items sent and received through the ACSS. At a minimum, each member pays CAD 10,000 for its annual dues. The dues are payable in two instalments.

As with the LVTS, the Bank of Canada does not charge fees for its settlement services. There is no ACSS balance and no overdrafts are carried on the Bank of Canada's balance sheet overnight and therefore no interest rate charges are payable to the Bank of Canada. In the rare event that a direct clearer cannot pay its negative clearing balance through LVTS, the direct clearer can apply for a collateralised advance from the Bank of Canada to obtain the liquidity needed to settle. This advance is settled through the LVTS later in the day and is therefore unlikely to be used for overnight borrowing. The Bank of Canada does not impose an interest rate charge for this intraday borrowing.

### **3.3.7 Future developments**

#### *Default procedures*

Recently, the CPA reviewed the ACSS default procedures and decided to remove the unwinding provisions due to the legal and operational complexities involved with returning certain payment items. The CPA is pursuing amendments to existing by-laws and rules for this purpose.

#### *Review of risks in ACSS*

Following the review of ACSS default procedures, the CPA has decided to examine the risks that exist in the ACSS. This study will be part of a larger Retail Clearing Framework Program. The CPA is planning to identify the risks that exist in ACSS and the existing mitigating strategies, and to consider whether any further mitigating actions should be introduced.

## **3.4 Offshore payment systems – CLS Bank**

The Continuous Linked Settlement (CLS) Bank began commercial operations on 9 September 2002.<sup>78</sup> CLS Bank facilitates the settlement of foreign exchange transactions in 17 different currencies, including the Canadian dollar. CLS Bank uses the LVTS as its approved payment system for the Canadian dollar. In 2009, CLS Bank settled an average daily value of USD 3.4 trillion from an average daily volume of 598,000 instructions. This included Canadian-dollar transactions with an average daily value of CAD 77 billion and average daily volume of 18,500 instructions.

---

<sup>78</sup> For more details on CLS, see the corresponding chapter in the forthcoming second volume of this publication.

Currently, four major Canadian banks participate directly in CLS Bank as settlement members and a fifth is expected to become a settlement member in the near future. Other Canadian banks participate indirectly as third-party users, accessing the system through the services of a settlement member. Several LVTS participants provide nostro services to CLS Bank members. There are currently two Canadian dollar liquidity providers.

The Bank of Canada has designated the Canadian dollar operations of CLS Bank under the PCSA. The Bank of Canada is part of a formal cooperative oversight arrangement that allows CLS Bank to be jointly overseen by the central banks whose currencies are included in the system. The Federal Reserve Bank of New York is the lead overseer of CLS and it coordinates the cooperation between participating central banks. The shared oversight arrangement enables CLS to be overseen in a comprehensive manner while keeping to a minimum the duplication of effort.

Another role played by the Bank is to provide CLS Bank with a Canadian-dollar settlement account. This enables the Bank to make and receive final and irrevocable payments on behalf of CLS through the LVTS.<sup>79</sup>

### 3.5 Other cross-border payment arrangements

Outside CLS Bank, cross-border payments are settled in a variety of ways. Correspondent banking arrangements are important for both electronic and paper-based payments such as cheques. Correspondent arrangements are typically organised as either an “in-house” arrangement, where the foreign correspondent for the Canadian clearing bank is its branch or banking subsidiary in the foreign country, or as “club” arrangements, where a group of individual institutions in different payments jurisdictions agree to offer one another indirect access to the domestic clearing system in which they participate.

In addition, the CPA owns and operates the US Bulk Exchange System (USBE) to facilitate the clearing of US dollar-denominated payments, both cheques and certain types of electronic payments, between members of the CPA. The USBE provides a mechanism for tracking the exchange of these USD payment items and the resulting balances due to and from the participants. These balances are calculated on a bilateral basis between each pair of participants, rather than on a multilateral basis. The net positions are settled through CHIPS via either the Canadian participants’ branch or subsidiary acting in CHIPS, or via correspondent arrangements.

There are also two cross-border electronic batch payments systems of interest currently operating in Canada: the US Federal Reserve’s International Automated Clearing House (IACH) Service and the European Transferts Interbancaires de Paiements Automatisés Network (TIPANET).

Finally, ATM networks offer access to cash for payments, both to foreigners visiting Canada and to Canadians travelling abroad. Customers can obtain local currency through ATMs via the Cirrus or Plus networks. The cross-border payment obligation of the card-issuing institution to the cash-dispensing institution is cleared and converted into a USD obligation through the MasterCard International (for Cirrus) or Visa system (for Plus). The Canadian leg of the obligation is settled through the LVTS. For example, if a Canadian resident uses a foreign ATM to obtain local currency, the card-issuing institution in Canada settles its obligation to the cross-border cash-dispensing institution through an LVTS payment to the MasterCard (or Visa) settlement bank in Canada. This settlement bank then settles through its nostro account with an international settlement bank serving MasterCard or Visa, which

---

<sup>79</sup> For more details, see P Miller and C Northcott, “CLS Bank: managing foreign exchange settlement risk”, *Bank of Canada Review*, Autumn 2002.

then credits the account of the cash-dispensing institution. Essentially the same is the process for clearing and settling cross-border Visa and MasterCard credit card payments, as well as MasterCard offline debit card transactions.

## **4. Systems for post-trade processing, clearing and securities settlement**

### **4.1 General overview**

In Canada, the two major systems for post-trade processing, clearing and securities settlement are CDSX and CDCC. CDS Clearing and Depository Services Inc (CDS) operates CDSX, which is Canada's main system for clearing and settlement of eligible Canadian exchange-traded and over-the-counter equity, debt and money market transactions. The Canadian Derivatives Clearing Corporation (CDCC) issues, clears and guarantees as a central counterparty all equity, index and interest rate derivatives traded on the Montréal Exchange (MX).

### **4.2 Post-trade processing systems**

Canada does not currently have trade repositories, nor is there any specific institution that only performs post-trade services. Both CDCC and CDSX have integrated some post-trade services internally within their systems (described below). For example, CDS offers a Matched Institutional Trade Interface service that enables domestic institutional trades provided through a virtual matching utility (VMU) or other authorised third party to be reported and created in real time as confirmed non-exchange trades in CDSX. Currently trade data are collected by CDS and CDCC for all trades that settle through their systems. The situation with regard to trade repositories may change as part of the G20 commitment for over-the-counter (OTC) derivatives, which states that OTC derivatives contracts should be reported to trade repositories. Should international trade repositories not provide Canadian authorities with adequate data access and coverage of Canadian participants and products, there may be a desire to establish a Canadian trade repository for OTC derivatives.

### **4.3 Central counterparties and clearing systems**

#### **4.3.1 Canadian Derivatives Clearing Corporation**

The Canadian Derivatives Clearing Corporation (CDCC) issues, clears and guarantees as central counterparty all equity derivatives, index derivatives and interest rate derivatives traded on the Montréal Exchange (MX).<sup>80</sup>

CDCC is a wholly owned subsidiary of MX, which is itself owned by the TMX Group.<sup>81</sup>

At the end of 2009, CDCC had 34 members, and 40.2 million contracts (one-sided) were processed that year.

---

<sup>80</sup> The source for this section is CDCC's website: [www.cdcc.ca](http://www.cdcc.ca).

<sup>81</sup> TMX Group owns and operates two major stock exchanges in Canada: the Toronto Stock Exchange (for senior equity) and the TSX Venture Exchange (for public venture equity). TMX Group also has other subsidiaries such as the Montréal Exchange (for derivatives trading), the Canadian Derivatives Clearing Corporation (a central counterparty), the Natural Gas Exchange (for natural gas and electricity contracts) and Shorcan (a fixed income inter-dealer broker).



#### 4.3.1.1 Institutional framework

CDCC is recognised as a self-regulated organisation and is regulated by Quebec's *Autorité des marchés financiers* (AMF). In addition, to support the clearing of derivatives contracts that are registered for sale to US residents, CDCC files documentation in accordance with Securities and Exchange Commission requirements.

#### 4.3.1.2 Participation

All clearing members of the CDCC must be participants of an exchange recognised in a Canadian province (such as the MX) or be a bank or an authorised foreign bank under the *Bank Act* of Canada. Clearing members must meet the requirements of their regulator: IIROC for broker-dealer members or OSFI for federal commercial deposit-taking institutions. CDCC regularly monitors the capital of its clearing members through quarterly and monthly financial reporting.

#### 4.3.1.3 Types of assets and products cleared

CDCC issues, clears and acts as central counterparty (CCP) for three broad categories of contracts traded on the MX:

- Option contracts: this category includes options on bonds, equities, exchange-traded funds and equity indexes.
- Futures contracts: this category includes two-year, five-year, 10-year and 30-year Government of Canada bond futures, three-month bankers' acceptance futures and S&P/TSX 60 index futures. In June 2010, CDCC also started to clear futures on the NGX WCS WTI Crude Oil Index, which is based on the differential price between the Western Canadian Select Heavy Crude Oil (WCS) and the West Texas Intermediate Light Crude Oil (WTI). This is the first contract to settle in USD in CDCC.
- Options on futures contracts: this category includes options on 10-year Government of Canada bond futures.

CDCC also acts as CCP for OTC equity options contracts traded on its Converge platform.

#### 4.3.1.4 Operation of the system

CDCC receives trades from the MX and Converge. CDCC's clearing application has a record of the net outstanding derivatives contracts, including futures and options. Based on the net outstanding derivatives contracts, CDCC's clearing application generates, during the overnight batch process, cash and security delivery obligations for each clearing member to be settled at its commercial settlement bank and at CDSX respectively.

#### 4.3.1.5 Risk management

CDCC has many risk control mechanisms in place. As a central counterparty, it ensures settlement will occur even if a clearing member were to default on its obligations. Numerous risk controls are in place to deal with default and limit risk. These include membership standards, margin deposits, a list of acceptable collateral with associated haircuts, two intraday margin calculations at 10:30 and 13:30, capital monitoring, a liquidity line and a clearing fund that can also be used for loss-sharing among survivors. In case of a participant's default, CDCC would use the following resources in this sequence:

- (i) the defaulter's margin deposits;
- (ii) the defaulter's clearing fund deposits;
- (iii) any remaining collateral pledged by the defaulter in excess of the margin requirement and clearing fund contribution;

- (iv) if the defaulter's proprietary assets and client assets are not sufficient to cover losses:
  - (a) the survivors' clearing fund deposits;
  - (b) a second clearing fund contribution, but not more than the preceding clearing fund contributions;
- (v) CDCC's capital.

#### 4.3.1.6 *Links to other systems*

Cash positions (mainly option premiums and cash-settled variation margins) are settled through electronic transfers at a commercial settlement bank the next business day by 07:45. Clearing members can also use LVTS to pledge cash to CDCC as collateral. Security positions have to be settled in CDSX on an ISIN basis with the associated risk controls. CDCC and its clearing members all have accounts at CDS. The trades are settled on a trade-for-trade basis in CDSX. Clearing members also use CDSX to pledge securities as collateral to CDCC.

#### 4.3.1.7 *Major ongoing and future projects*

In December 2009, CDCC was selected to develop CCP services for Canadian fixed income markets in response to a request for proposal from the Investment Industry Association of Canada (IIAC). CDCC is working with the industry to implement the new service in 2011. It is expected that the Bank will formally oversee the system operated by CDCC once it commences operations.<sup>82</sup>

### 4.3.2 **CDS Clearing and Depository Services Inc (CDS)**

CDS offers two CCP services: Continuous Net Settlement (CNS) and FINet. CNS nets eligible exchange-traded equity transactions and FINet nets eligible trades in Government of Canada bonds, treasury bills, Government of Canada-guaranteed corporate bonds and provincial bonds, notes and treasury bills. These CCP services are integrated with CDS's securities settlement CDSX.<sup>83</sup>

### 4.3.3 **Natural Gas Exchange Inc**<sup>84</sup>

Natural Gas Exchange Inc (NGX), wholly owned by TMX Group, provides electronic trading, central counterparty clearing and data services to the North American natural gas and electricity markets. In May 2009, through the acquisition of NetThruPut, NGX added crude oil to its suite of physically and financially cleared products.

In 2008, NGX formed a technology and physical clearing alliance with the Intercontinental Exchange Inc (ICE). Under the arrangement, the cleared and bilateral markets for North American physical natural gas and Canadian electricity operated by NGX and ICE are offered together on ICE's Trading Platform. NGX also uses the ICEBlock system to electronically accept, for clearing, off-exchange transactions in financial gas and other energy products. In 2011, NGX and ICE expanded the alliance to Canadian and US physical and Canadian financial crude oil products.

<sup>82</sup> Under the PCSA, the Governor of the Bank of Canada can designate a system once the Minister of Finance agrees it is in the public interest to do so.

<sup>83</sup> This system is described in Section 4.4.1 below.

<sup>84</sup> For more details, see <http://www.ngx.com>.

The Alberta Securities Commission regulates NGX. NGX is not subject to Bank of Canada oversight.

In 2009, NGX cleared 625,000 contracts worth a total of CAD 97 billion.

#### **4.3.4 ICE Clear Canada<sup>85</sup>**

ICE Clear Canada is the designated central counterparty for ICE Futures Canada, an agricultural exchange offering futures and options contracts on canola and barley. ICE Clear Canada was originally established in 1998 as WCE Clearing Corporation. Winnipeg Commodity Exchange (WCE) and WCE Clearing Corporation were acquired by Intercontinental Exchange Inc (ICE) in 2007.

ICE Clear Canada is regulated by the Manitoba Securities Commission pursuant to the provisions of the *Commodity Futures Act* (Manitoba). All ICE Clear Canada's rules, operational manual and by-law amendments are submitted to its regulator, the Manitoba Securities Commission. ICE Clear Canada is not subject to Bank of Canada oversight.

In 2009, ICE Clear Canada cleared 3.6 million transactions at a value of CAD 29.5 billion.

### **4.4 Securities settlement systems**

#### **4.4.1 CDS Clearing and Depository Services Inc**

The Canadian Depository for Securities Limited was incorporated in 1970 as a non-profit corporation. It is owned by the major Canadian chartered banks, members of the Investment Industry Regulatory Organization of Canada (IIROC) and the TMX Group. CDS Clearing and Depository Services Inc (CDS) is a subsidiary of Canadian Depository for Securities Limited. CDS owns and operates CDSX, which is Canada's main system for clearing and settlement of eligible Canadian exchange-traded and OTC equity, debt and money market transactions. CDS's depository service provides facilities to deposit and withdraw depository-eligible securities, manage related ledger positions, and use these positions for various business functions.<sup>86</sup> In 2003, CDSX replaced both the Debt Clearing Service (DCS), which was used to clear and settle most Canadian-dollar debt transactions, and the Securities Settlement Service (SSS), which settled equities and some debt transactions.

On average in 2009, CDSX processed about 1 million daily trades worth about CAD 258 billion. This compares to about 250,000 daily trades worth about CAD 192 billion in 2005. The value of securities on deposit was about CAD 3.3 trillion as at 31 December 2009.

##### *4.4.1.1 Governance*

CDS does not have its own board; however, the Canadian Depository for Securities Limited Board of Directors consists of 14 directors: nine shareholder directors, one director from CDS's management, one director from the TMX Group and three independent directors from outside the securities industry.

##### *4.4.1.2 Institutional framework*

CDS, its clearing and settlement system, and its participants are subject to legislation and regulations of various jurisdictions. At the federal level, the Bank of Canada oversees CDSX,

---

<sup>85</sup> For more information, see [https://www.theice.com/clear\\_canada.jhtml](https://www.theice.com/clear_canada.jhtml).

<sup>86</sup> Major depository accountabilities are the safe custody and movement of securities, accurate record-keeping and the collection and distribution of the entitlements associated with the securities.

which is a designated system under the *Payment Clearing and Settlement Act* (PCSA). At the provincial level, CDS is regulated by the Ontario Securities Commission (OSC) under the *Ontario Securities Act* and the Autorité des marchés financiers (AMF) under the Quebec Securities Act. CDS also works with the Alberta and British Columbia securities commissions as needed. In addition, CDS reports, as required, to the Canadian Securities Administrators (CSA). Finally, CDS cooperates with federal and provincial financial institution regulators that oversee CDS participants.

#### 4.4.1.3 Participation

In 2009, CDS participants included the Bank of Canada, 11 commercial banks, eight trust companies, 55 investment dealers and nine other participants (credit unions, depositories and treasury branches), when counting participants and their affiliates individually, along with 13 limited-purpose participants. Canadian financial institution members in CDSX must be incorporated, in compliance with regulations for their industry, and meet minimum prudential requirements. Foreign institutions are regulated by the laws of their own country, but there must be certainty, according to expert legal opinion, that the laws of the foreign country do not interfere with the enforceability of CDS rules and procedures.

All CDSX participants must be members in good standing with an industry self-regulatory organisation, if applicable. They must also demonstrate sufficient financial and operational capacity to meet obligations to CDS and other participants. CDS relies on its participants' regulators for monitoring compliance, although CDS conducts a credit assessment of new participant applicants.

#### 4.4.1.4 Types of assets and products cleared

CDSX settles transactions in equities and the following debt securities: Government of Canada; federally guaranteed; provincial; corporate; unrated public sector entities and government grants; unrated municipal; and US Treasury bills, bonds and notes.

#### 4.4.1.5 Operation of the system

Settlement in CDSX uses a model 2 delivery versus payment (DVP) mechanism,<sup>87</sup> ie transactions are settled with securities ownership moving on a gross real-time basis while the net funds positions are settled at the end of the day.<sup>88</sup> The DVP mechanism has additional risk mitigation features including: (i) the simultaneous transfers of funds and securities at the time of settlement of transactions are final and irrevocable; and (ii) negative funds balances are fully collateralised.

CDS manages the safekeeping of depository-eligible domestic and international securities in both electronic and physical certificate form for its participants. Eligible securities are held by CDS or transfer agents and registered in CDS's nominee name (CDS & Co). Once the electronic or physical securities are deposited with CDS, CDS enters them into a ledger and they trade electronically.

Trade transactions are entered by one party and confirmed by the other party. These transactions can be entered into CDSX either via file transmission from proprietary systems or exchanges, or by direct participant access. CDSX also provides trade matching, where netted payment obligations are settled at the end of the day via designated bankers, with payments made through the LVTS to CDS's settlement account held at the Bank of Canada.

<sup>87</sup> See Committee on Payment and Settlement Systems, *Delivery versus payment in securities settlement systems*, Basel, 1992.

<sup>88</sup> Securities may also be cleared via a daily batch settlement which occurs during the early hours. Although described as a batch process, it is legally a gross mechanism.

Securities held in CDSX can also be reserved as collateral for LVTS payments that are intended for settling final funds positions in CDSX. CDS retains a prior claim on these securities until the LVTS payment is made. LVTS payments are final and irrevocable, allowing final settlement of CDS to occur once all the payment obligations have been received. After settlement, securities that were held in accounts with restricted access become available for use without restriction.

The opening hours for CDSX are designed to support the operations of the LVTS during the CLS settlement period. CDSX is open from 00:30 to 19:30, where settlement of payments (payment exchange) begins at 16:00 and ends at 17:00. After settlement, CDSX remains open until 19:30 for free movement of securities only.<sup>89</sup>

#### 4.4.1.6 Risk management

The risk containment model developed in CDSX, which is a combination of survivor-pay and defaulter-pay loss-sharing arrangements, runs in real time and is designed to protect CDS from the intraday failure of the participant with at least the single largest net obligation to CDS. In addition, for CAD transactions, the Bank of Canada acts as CDS's settlement agent and provides settlement accounts so that CDS is protected from banker risk.

There are primarily two types of participants in CDSX: receivers of credit and extenders of credit. The receivers of credit are the majority of institutions participating in the system and they receive lines of credit from extenders that enable them to purchase securities during the day. Extenders of credit collateralise their own intraday payment obligations. Receivers of credit must also collateralise their own obligations enabled by the extended line of credit. At the end of the day, the extenders of credit are required to make payments to CDS to cover the net amount of securities bought on their own behalf and on behalf of their customers, as well as to cover securities bought by receivers of credit. Receivers of credit grant the extenders a security interest in the securities delivered to them on that day. If an extender is required to make payment for a receiver that is unable to fulfil its end-of-day payment obligation, the extender is entitled to take possession of those securities (the so-called delivered or "unpaid-for" securities). The amount that each extender can owe the system (either on behalf of those to which it has extended credit or on its own behalf) is capped.

The system also has a loss-allocation procedure in the event that an extender of credit is unable to meet its end-of-day payment obligation, either for its own net purchases during the day or on behalf of those receivers of credit that are unable to fulfil their payment obligations at the end of the day. Under the loss-allocation procedure, the remaining extenders are required to fulfil the obligation to the system of the failed extender. This loss-allocation procedure is backed up by a pool of collateral that all extenders of credit maintain in accordance with the requirements set out in the CDSX Rules. The extenders may also guarantee some of their own payment obligations individually by pledging collateral to CDS on a dollar-for-dollar basis to cover these obligations.

The sum of these two types of collateral is sufficient to cover the failure of the extender with the single largest possible net debit to the system. Thus, in the case of the failure of a single extender, CDSX would be expected to be able to settle without causing undue liquidity strains for participating financial institutions. To facilitate any liquidity issues in the event of a default, CDS has obtained a collateralised line of credit from a private sector bank. In the extreme case, where the liquidity line is insufficient, the Bank of Canada would provide a fully collateralised last-resort loan facility. As CDSX operates as a model 2 DVP system, transactions that have settled intraday cannot be unwound.

---

<sup>89</sup> Free movement of securities allows participants to pledge securities to other participants' accounts.

Within this framework, CDSX incorporates a variety of risk-control mechanisms in its design and operations:

- CDSX is a real-time online facility with the position of each participant calculated on a transaction-by-transaction basis.
- CDSX has been designed to operate on a DVP (value-for-value) basis. There is gross, or item-by-item, settlement for securities transfers throughout the day and, at the same time, there is continuous netting and novation to CDS of corresponding payment obligations.
- All participants' net debit payment positions vis-à-vis CDSX are subject to "system operating caps", ie ceilings, with the cap for certain participants linked to the size of their regulatory capital.
- Each category credit ring member has a collateral pool where members of the pool combine collateral for common use and share risk by guaranteeing the obligations of the other members that arise from use of the pool.<sup>90</sup>
- The Aggregate Collateral Value (ACV) control ensures that any default will be fully collateralised (subject to the sufficiency of the applicable haircut rates as described below) at all times. The system rejects transactions that would cause a participant's payment obligation to exceed the collateral value of securities available and pledged as collateral to cover that payment obligation. The ACV control tracks the value of a participant's collateral in real time.
- The usable value of securities as collateral in the system is the market value of each security less a haircut, to account for day-to-day volatility in the market price. The securities eligible as collateral in CDSX are mostly in line with the securities allowed for the Bank of Canada's Standing Liquidity Facility – with the exception of equities.
- Any transactions that would put a participant outside the limits imposed by the collateralisation requirement or system operating caps are placed in a "pending" status until a change would allow the transaction to settle within these limits.
- All participants in CDSX can calculate their potential risk exposure at any given time.
- At the end of the day, the net amounts in Canadian dollars owed and owing between the CDSX (as a result of the novation of obligations to CDS) and the participants are settled using the LVTS. US dollar settlement occurs through a commercial settlement bank via Fedwire.
- The system does not permit the reversal or unwinding of transactions as a means of dealing with participant failure.
- For Canadian dollars, the Bank of Canada acts as settlement agent for CDS in the LVTS, with respect to payment obligations in CDSX. The Bank of Canada, in carrying out this daily function, receives payments from participants that owe money to CDS and makes payments to participants entitled to receive money from CDS. With the Bank acting as settlement agent, so-called "banker risk" is eliminated for CDSX and its participants transacting in Canadian dollars. There is no liquidity or credit risk to the Bank of Canada from carrying out this function because the LVTS is used to make end-of-day CDSX payments and the Bank will make an LVTS payment on behalf of CDS only if there is a sufficient balance in the CDS account to cover the amount of the payment.

---

<sup>90</sup> Except for non-contributing receivers of credit (ie participants who do not create payment obligations for CDS).

For CDS's CCP services (FINet and CNS), the process has additional risk management features that require each FINet/CNS participant to contribute margin collateral to cover the participant's own risks to CDS for its specific FINet/CNS activities. If a participant fails to fulfil any of its obligations to CDS within FINet or CNS, CDS may suspend the participant and initiate both the CDSX default procedures and the related CCP closeout procedures. The closeout procedures use a defaulters-pay model and the value of the FINet/CNS collateral that CDS has received from the defaulting participant is expected to be sufficient to cover any CCP loss generated by the default of that participant. If it is not sufficient, the survivors share in the losses.<sup>91</sup>

#### *4.4.1.7 Links to other systems*

The LVTS and CDSX have links that allow participants to move liquidity from one system to the other. A participant in both LVTS and CDSX with a positive funds balance in CDSX can send these funds to the Bank of Canada in CDSX and the Bank will send the participant an LVTS payment for that amount. A similar arrangement allows a participant in both systems to transfer LVTS funds to its CDSX funds account.

CDS has also established custody links to depositories in the United States, Japan, France, Peru and Sweden. To help CDSX participants manage their US business, CDS has set up links with both the Depository Trust Company (DTC) and the National Securities Clearing Corporation (NSCC) to form an active inter-depository linkage. DTC is the central depository for US securities and provides custodial and settlement services (trade-for-trade only), and NSCC provides clearing services and settlement (on a trade-for-trade and CCP basis) through DTC. CDS facilitates this through two links: the New York Link (NYL) and DTC Direct Link (DDL). For NYL, CDS sponsors participants for direct membership in NSCC and DTC. These participants can access NSCC's/DTC's custodial, institutional clearing and settlement services, where NYL trading activity is predominantly settled on a continuous net settlement basis. For DDL, CDS also sponsors participants for direct membership in DTC.

#### *4.4.1.8 Major ongoing and future projects*

To improve the efficiency and cost effectiveness of the Canadian capital markets, CDS is working towards eliminating physical securities certificates both for existing issues within CDS's vaults and the issuance of new securities. This will reduce overall industry processing and holding costs for securities transactions, and lower the risk and eliminate the potential cost of replacing lost certificates. In addition, with a target date of November 2011, all entitlement payments paid to CDS will be in electronic form.

## **4.5 The use of securities infrastructure by the central bank**

The Bank of Canada is a direct participant in CDSX and completes several business activities through its participation.

### **4.5.1 Collateral management**

The Bank of Canada uses CDSX to receive securities as collateral. This collateral is used to support the intraday operations of the LVTS; Standing Loan Facilities related to the settlement of the LVTS; and any advances associated with the withdrawal of currency by participants in the Note Exchange System.

---

<sup>91</sup> For a detailed description of the risk controls and default management, see [http://www.cds.ca/cdsclearinghome.nsf/Downloads/-EN-CDSFinancialRiskModel-Version6.0/\\$File/CDS+Financial+Risk+Model\\_Version+6.0.pdf?OpenElement](http://www.cds.ca/cdsclearinghome.nsf/Downloads/-EN-CDSFinancialRiskModel-Version6.0/$File/CDS+Financial+Risk+Model_Version+6.0.pdf?OpenElement).

#### **4.5.2 Monetary policy**

The Bank of Canada, as part of its monetary policy, has a target for the overnight rate, and is prepared to enter into open market securities operations with purchase and resales or sales and repurchases to support the target rate. Term repos can also be used when liquidity premia in money markets are distorted and associated with widespread liquidity problems in an asset class or maturity. These would be most useful for providing liquidity to money markets since they can be offered to any financial market participants with marketable securities as the basis for the transaction. These transactions are all settled in CDSX.

#### **4.5.3 Government debt administration**

As part of the debt management services the Bank provides to the federal government, the Bank issues through auction, and settles through CDSX, all new issues of government treasury bills and marketable bond issues. Within CDSX, the Bank of Canada is the sub-custodian for Government of Canada securities. Also, all interest and redemption payments on government securities held in CDSX are settled through CDSX by the Bank of Canada acting on behalf of the government.

#### **4.5.4 Client services**

The Bank of Canada offers settlement services on behalf of its correspondent clients, primarily other central banks, for the Canadian dollar-denominated securities transactions that these clients have entered into. These transactions are settled through CDSX.





**Payment, clearing and  
settlement systems in  
India**



## Contents

List of abbreviations.....	151
Introduction.....	153
1. Institutional aspects.....	154
1.1 The institutional framework .....	154
1.1.1 Regulatory institutions.....	154
1.1.2 Legal framework .....	156
1.2 The role of the central bank .....	158
1.2.1 Note issuance .....	158
1.2.2 Payment and settlement services .....	158
1.2.3 Oversight.....	162
1.2.4 Cooperation with other institutions.....	163
1.3 The role of other private and public sector bodies .....	164
1.3.1 The Indian Banks' Association.....	165
1.3.2 The Clearing Corporation of India Limited .....	165
1.3.3 India Post.....	166
1.3.4 The Institute for Development and Research in Banking Technology .....	166
1.3.5 National Payments Corporation of India .....	166
1.3.6 Foreign Exchange Dealer's Association of India .....	166
1.3.7 Fixed Income Money Market and Derivatives Association of India.....	167
1.3.8 The stock exchanges.....	167
1.3.9 Securities depositories.....	167
2. Payment media used by non-banks .....	168
2.1 Cash payments .....	168
2.2 Non-cash payments .....	168
2.2.1 Cheques.....	168
2.2.2 Credit transfers .....	169
2.2.3 Direct debit.....	169
2.2.4 Payment cards.....	170
2.2.5 Point of sale (POS) infrastructure .....	171
2.2.6 ATM infrastructure and services .....	171
2.2.7 Postal orders, money orders and retail services from India Post.....	172
2.3 Recent developments .....	173
2.3.1 Rationalisation of service charges .....	173
2.3.2 Mandatory use of electronic mode of funds transfer.....	173
2.3.3 Internet/mobile phone banking.....	173

2.3.4	Remittance services.....	174
2.3.5	Role of intermediaries .....	174
3.	Payment systems (funds transfer systems).....	175
3.1	General overview .....	175
3.2	Real-time gross settlement system .....	176
3.2.1	Operating rules.....	176
3.2.2	Participants .....	177
3.2.3	RTGS transaction types .....	177
3.2.4	Settlement procedure and liquidity support.....	177
3.2.5	Transaction processing environment .....	178
3.2.6	The RTGS system process flow.....	178
3.2.7	Credit and liquidity risk .....	178
3.2.8	Pricing .....	179
3.2.9	Statistics.....	179
3.3	Exchange and settlement system for foreign exchange transactions .....	179
3.3.1	Ownership, governance and regulatory status of CCIL .....	179
3.3.2	Participants .....	180
3.3.3	Transactions handled.....	180
3.3.4	System operating procedure .....	181
3.3.5	Clearing of trades and settlement obligations.....	181
3.3.6	Settlement procedure.....	181
3.3.7	Risk management .....	182
3.3.8	Cross-currency CLS-eligible trades .....	183
3.4	Retail payment systems .....	183
3.4.1	Card-based systems .....	183
3.4.2	Cheque clearing system.....	184
3.4.3	Electronic Clearing Service (ECS) .....	185
3.4.4	Electronic Funds Transfer system.....	186
3.4.5	Ongoing and future projects.....	186
4.	Systems for post-trade processing clearing and securities settlement.....	187
4.1	General overview .....	187
4.2	Post-trade processing systems .....	189
4.2.1	Government securities .....	189
4.2.2	Collateralised Borrowing and Lending Obligation (CBLO) .....	189
4.2.3	Interest rate swaps.....	190
4.2.4	Exchange-traded securities and derivatives .....	190
4.3	Central counterparties and clearing systems .....	193

4.3.1	Government securities .....	193
4.3.2	Collateralised Borrowing and Lending Obligations (CBLO) .....	194
4.3.3	Foreign exchange settlement.....	196
4.3.4	National Securities Clearing Corporation Ltd. (NSCCL) and Indian Clearing Corporation Limited (ICCL).....	196
4.3.5	Bombay Stock Exchange.....	200
4.4	Securities settlement systems.....	202
4.4.1	Government securities .....	202
4.4.2	Securities traded on the NSE and the BSE .....	202
4.4.3	Derivatives .....	203
4.5	Use of securities infrastructure by the Central Bank .....	203



## List of abbreviations

ATM	automated teller machine
BOISL	Bank of India Shareholding Ltd
BSE	Bombay Stock Exchange
CBLO	collateralised borrowing and lending obligation
CCIL	Clearing Corporation of India Limited
CCP	central counterparty
CDSL	Central Depository Services Ltd
CFMS	Centralised Funds Management System
CRR	cash reserve ratio
CSGL	constituent subsidiary general ledger
ECS	Electronic Clearing Service
EFT	Electronic Funds Transfer
FEDAI	Foreign Exchange Dealers Association of India
ICSE	Inter-Connected Stock Exchange
IDL	intraday liquidity
IDRBT	Institute for Development and Research in Banking Technology
IFTP	interbank funds transfer processor
INFINET	Indian Financial Network
INR	Indian rupees
IPO	initial public offer
IVR	interactive voice response
LAF	liquidity adjustment facility
MICR	magnetic ink character recognition
NDC	net debit cap
NDS/SSS	Negotiated Dealing System/Securities Settlement System
NEAT	National Exchange for Automated Trading
NECS	National Electronic Clearing Service
NFS	National Financial Switch
NDS-OM	Negotiated Dealing System – Order-Matching (RBI-NDS-GILTS-Order Matching Segment)
NPC	National Payments Council
NSCCL	National Securities Clearing Corporation of India Ltd
NSDL	National Securities Depository Limited
NSE	National Stock Exchange
OECLOB	open electronic consolidated limit order book
OTC	over-the-counter



*India*

OTCEI	Over The Counter Exchange of India
PFRDA	Pension Fund Regulatory Development Authority of India
PI	participant interface
RBI	Reserve Bank of India
RTGS	real-time gross settlement
SCRA	Securities Contracts (Regulation) Act, 1956
SEBI	Securities and Exchange Board of India
SGF	settlement guarantee fund
SGL	subsidiary general ledger
SLR	statutory liquidity ratio
SSS	securities settlement system

## Introduction

The financial sector in India has undergone significant reforms during the last two decades. The reforms were initiated in 1992, with increased emphasis on deregulation, competition, and adoption of international best practices. At the same time, banks and financial institutions were encouraged to play an effective role in strengthening economic growth. The major initiatives undertaken by the Reserve Bank of India (RBI), the central bank, included deregulation, improved prudential measures and risk management, as well as measures to develop financial markets. Recognising that payment and settlement systems should conform to international standards, the RBI set out its objectives in a 1998 monograph on *Payment Systems in India*. The subsequent *Payment System Vision Document for 2001–04* provided a roadmap for the consolidation, development and integration of the country's payment systems. The resulting progress in the payment and settlement systems was detailed in the *Vision Document for 2005–08* published in May 2005. For its part, the *Vision Document 2009–12*<sup>1</sup> reflects the changes after the enactment of the Payment and Settlement Systems Act, 2007, and sets out the objective of ensuring “that all the payment and settlement systems operating in the country are safe, secure, sound, efficient, accessible and authorised”.

The RBI plays a pivotal role in the development of India's payment and settlement systems for both large-value and retail payments. The central bank played a pioneering role in automating the paper-based clearing system in the 1980s. It introduced an electronic funds transfer system and electronic clearing services (ECS Credit and Debit) in the 1990s. The special electronic fund transfer (SEFT) system was introduced in April 2003 (subsequently discontinued in March 2006, after the implementation of the National Electronic Fund Transfer (NEFT) system in November 2005) and the real-time gross settlement (RTGS) system in March 2004. The RBI operates the RTGS, which has replaced the paper-based interbank clearing system and settles a sizeable volume of large-value and time-critical customer transactions. RBI also manages the clearing houses (for paper-based and electronic clearing) in 17 large cities while operating the clearing houses at four major locations. It is the settlement banker in these cities. The RBI introduced the NEFT system in November 2005. Together with ECS, this forms the electronic retail payment infrastructure. The National Electronic Clearing Services (NECS) system, which aims to centralise the Electronic Clearing Service (ECS) operation and bring uniformity and efficiency to the system, was implemented in September 2008. At present, the NECS settles only credit transfers. To improve efficiency in the paper-based clearing system, the central bank introduced cheque truncation in the National Capital Region of New Delhi in February 2008. Efforts are currently underway to implement cheque truncation in Chennai. The RBI continues to be involved in the mechanisation of paper-based clearing in smaller cities and towns.

The central bank played an instrumental role in setting up the Clearing Corporation of India Limited (CCIL), a central counterparty (CCP) for the settlement of trades in government securities and foreign exchange. The RBI serves as the custodian and central securities depository (CSD) for Government of India securities. To facilitate faster settlement of trades in government securities in dematerialised form, the RBI introduced in February 2002 an electronic negotiation-based trading and reporting platform called the Negotiated Dealing System (NDS). Further, to enhance the trading infrastructure in the government securities market, the RBI introduced in August 2005 an electronic order-matching system called the RBI-NDS-GILTS-Order Matching or NDS-OM in short. The NDS and NDS-OM are both part of the securities settlement system (SSS) known as the Negotiated Dealing

---

<sup>1</sup> The Vision Document is available at <http://rbi.org.in/scripts/PublicationVisionDocuments.aspx>.

System/Securities Settlement System (NDS/SSS).<sup>2</sup> The NDS/SSS provides final settlement for government securities transactions that are settled in the books of the RBI, the CSD. The NDS/SSS facilitates monetary operations of the central bank. The liquidity adjustment facility (LAF), also administered by the RBI through the NDS/SSS, transmits interest rate signals to Indian money markets. All secondary operations in government securities where CCIL acts as the central counterparty (CCP) are also settled in the NDS/SSS, on the DVP3 model,<sup>3</sup> with the funds being settled through the RTGS system.

The debt segment of the equities and securities market in India is dominated by bonds and treasury bills issued by the government. Though physical issue of government securities is permitted by law, institutional investors mostly hold their investment in dematerialised form. The RBI is the depository (CSD) for government securities. For other securities, equities and corporate bonds, the two central depositories are the National Securities Depository Limited (NSDL) and the Central Depository Services Limited (CDSL), which hold the securities issued and traded through the stock exchanges in dematerialised form.

There are at present 19 stock exchanges in the country; all have screen-based trading. The National Stock Exchange (NSE) and the Bombay Stock Exchange (BSE), Mumbai, are the two leading exchanges for equities, debt and derivatives. Trades are independently cleared and settled at the clearing houses<sup>4</sup> that both exchanges have set up for the purpose. Settlement takes place on a T+2 basis. Funds settlement takes place in commercial bank money.

## 1. Institutional aspects

### 1.1 The institutional framework

The financial sector has been significantly liberalised over the last two decades, and is now more integrated with the global financial system. Simultaneously, new institutions have been created and existing institutions strengthened so as to build an efficient regulatory framework. Legislation has also been considerably improved to support the regulatory framework and improvements in market infrastructures.

#### 1.1.1 Regulatory institutions

In India, there are three major regulators for the financial system. The Reserve Bank of India (RBI), established under the Reserve Bank of India Act, 1934 (RBI Act), is the central bank of the country, which pursues the objectives of economic growth, price and financial stability. The Securities and Exchange Board of India (SEBI), established under the Securities and Exchange Board of India Act, 1992, is the regulator of the capital market. The Insurance Regulatory and Development Authority (IRDA), established under the Insurance Regulatory

---

<sup>2</sup> The Negotiated Dealing System (NDS) and the Negotiated Dealing System – Order-Matching (NDS-OM) are the trading and reporting components of the SSS. The NDS-OM, though managed by CCIL, is owned by the RBI.

<sup>3</sup> See Committee on Payment and Settlement Systems, *Delivery versus payment in securities settlement systems*, Basel, 1992, p 4.

<sup>4</sup> The National Securities Clearing Corporation Ltd (NSCCL), a wholly owned subsidiary of NSE, was incorporated in August 1995 and started operations in April 1996. It was the first clearing corporation in the country to provide a novation/settlement guarantee mechanism. Bank of India Shareholding Ltd (BOISL) is an independent clearing house jointly promoted by BSE (49%) and Bank of India (51%) and which undertakes clearing and settlement of funds and securities on behalf of BSE.

and Development Authority Act 1999, is an independent supervisor of the insurance sector with licensing authority. Given the rising importance of pension funds and their operations, the government recently set up the Pension Fund Regulatory Development Authority of India (PFRDA) to facilitate orderly growth in this sector. Though many regulatory powers have been delegated to the regulators, as above, certain powers are still exercised by the government. For instance, the Department of Economic Affairs (for public debt management, functioning of capital markets etc), the Ministry of Corporate Affairs (administering the Competition Act, 2002, and supervising accounting bodies), and the Registrars of Cooperative Societies (controlling of cooperatives, namely, state cooperative banks, district cooperative banks etc) have powers to regulate the activities of certain types of financial intermediaries.

The RBI's mandate, under the RBI Act, is "to regulate the issue of Bank notes and the keeping of reserves with a view to securing monetary stability in India and generally to operate the currency and credit system of the country to its advantage". The RBI has adopted a multiple indicator approach in order to achieve the desired level of economic growth while preserving price and financial system stability. The RBI's key functions include:

- issuing currency;
- acting as the monetary authority;
- regulation and supervision of banks and other financial market participants;
- regulation of payment and settlement systems;
- management of foreign exchange reserves;
- developmental functions; and
- other conventional central banking functions.<sup>5</sup>

As part of the regulation and supervision of payment systems, the RBI oversees clearing house operations. To ensure the smooth operation of clearing houses, the RBI has issued model Uniform Regulations and Rules for Bankers' Clearing Houses (URRBCH) for adoption by clearing house members.<sup>6</sup> The RBI uses its regulatory and supervisory powers to ensure that these regulations are followed.

The Payment and Settlement Systems Act, 2007, empowers the RBI to regulate and oversee all payment and settlement systems in the country and also to provide settlement finality<sup>7</sup> and a sound legal basis for netting. The Act came into effect on 12 August 2008. The RBI has constituted the Board for Regulation and Supervision of Payment and Settlement Systems (BPSS) as a committee of its Central Board.<sup>8</sup> The BPSS became operational with effect from 7 March 2005. It formulates policies for the regulation and supervision of all types of payment and settlement systems, sets standards for existing and future systems, authorises payment and settlement systems, determines criteria for membership to these systems and decides on continuation, termination and rejection of membership. The BPSS was reconstituted after the Payment and Settlement Systems Act came into effect.

---

<sup>5</sup> Such as lender of last resort; banker to banks; banker to the government etc.

<sup>6</sup> Clearing houses are associations of member banks. Banks participate as members of clearing houses.

<sup>7</sup> Section 23 of the Payment and Settlement Systems Act, 2007, defines settlement finality with respect to all transactions undertaken in money, securities, foreign exchange and derivatives.

<sup>8</sup> Central Board is the nomenclature used in the RBI Act 1934. The Central Board consists of the Governor, Deputy Governors, 14 directors nominated by the central government under Section 8 (1) b, c and d.

### **1.1.2 Legal framework**

The different segments of the financial system and the activities of financial intermediaries are governed and regulated by various statutes that indirectly affect the payment and settlement systems. Some of the enabling legal framework is in the form of rules and regulations that, though not legally codified, are enforceable due to their contractual nature. Some of these laws and regulations are briefly explained below.

Under the provisions of the RBI Act, the RBI, as the central bank of the country, is the sole authority for the issue of currency notes. The act also empowers the central bank to frame regulations for clearing houses. Through an amendment to this act, the RBI was empowered to make regulations in respect of fund transfers through electronic means between banks or between banks and other financial institutions.

The Foreign Exchange Management Act 1999 (FEMA) was enacted to promote the orderly development and maintenance of India's foreign exchange market. FEMA confers powers on the RBI to regulate, inter alia, foreign currency payments into and out of India.

The Banking Regulation Act, 1949, provides the legal basis for all the activities that can be undertaken by banks in India. It is applicable to all institutions that receive deposits repayable on demand or otherwise, for lending or investment. The Act confers powers on the RBI to regulate the banks in the country and thus the clearing houses managed by banks, to inspect the books and accounts of banks and to call for periodical financial reports and data from the banks. Non-bank institutions accepting deposits and other financial institutions are also governed and regulated under the RBI Act, 1934.

The Negotiable Instruments Act, 1881 (NI Act), defines promissory notes, bills of exchange and cheques. After the enactment of the Information Technology Act, 2000, amendments were made to the NI Act to provide for electronic cheques and cheque truncation.

The Information Technology Act, 2000, provides the legal basis for activities related to electronic transaction processing. It also stipulates the security features that are necessary to maintain the confidentiality, integrity and authenticity of such transactions. It provides legality for digital signatures and encryption of data and enables electronically stored information to be equivalent to documentary evidence in a court of law.

The Indian Contract Act, 1872, sets forth the principles of contracts in India. Agreements entered into by parties, including their mutual rights and obligations, are governed by the Indian Contract Act.

Clearing systems are governed by the Uniform Regulations and Rules for Bankers' Clearing Houses (URRBCH). The URRBCH cover all aspects related to the function and operation of clearing houses, such as membership criteria, suspension from or termination of membership and the procedures related to clearing and settling claims among members. Individual clearing systems, such as the cheque clearing system, electronic clearing service and electronic funds transfer system, operate under the governing covenants of these regulations and rules as adopted by each clearing house. Originally, the URRBCH and each system's local procedural guidelines were contractually agreed between the clearing house and its members. This is no longer the case with the URRBCH, as these contracts now have legal recognition under the Payment and Settlement Systems Regulations, 2008.

These regulations, together with the Payment and Settlement Systems (PSS) Act, 2007, came into effect in August 2008. The PSS Act specifies that no person, other than the RBI, shall operate a payment system except with an authorisation issued by the RBI (unless specifically exempted by the terms of the PSS Act). The Act provides for netting and

settlement finality and vests formal oversight powers over all payment and settlement systems with the RBI. In summary, the Act:

- designates the RBI as the authority that regulates payment and settlement systems;
- makes it mandatory to obtain RBI authorisation to operate a payment system;<sup>9</sup>
- empowers the RBI to regulate and supervise payment systems by determining standards and calling for information, regular reports, documents etc;
- empowers the RBI to audit and conduct on- and off-site inspections of payment systems;
- empowers the RBI to issue directives; and
- provides for netting and settlement to be final and irrevocable.

In addition to the Payment and Settlement Systems Act, 2007, five other laws have an important influence on securities markets and securities settlement systems. The Securities and Exchange Board of India Act, 1992, provides for the establishment of a board (the SEBI) to protect the interests of investors in securities and promote the development of securities markets. It also confers powers on the SEBI to regulate the securities market by registering and regulating all market entities such as stock exchanges and depositories, to conduct enquiries, audits and inspections of such entities and to adjudicate offences under the act.

Sections 20 and 21A of the RBI Act mandate the RBI to act as a debt manager to the central and state governments. Earlier, the Public Debt Act, 1944, provided the framework for regulating transactions in the government securities market. This act was superseded by the Government Securities Act, 2006 (GS Act 2006), from 1 December 2007. Some of the significant changes brought about by the GS Act 2006 are legal recognition to lien, pledge and hypothecation of government securities; simpler procedural formalities with regard to transfer of title in the event of the death of the title-holder; and legal recognition for Constituent Subsidiary General Ledger (CSGL) accounts.

Section 45W of the RBI Act empowers the RBI to regulate, determine policy and give directions to all or any agencies dealing in securities, money market instruments, foreign exchange, derivatives or other such instruments as the RBI may specify.

The Securities Contract Regulations Act, 1956 (SCRA), confers powers on the government of India to regulate and supervise all stock exchanges and securities transactions. This act also applies to government securities. The central government has delegated its powers under the act to the RBI. These powers relate to contracts in government securities, money market securities, gold-related securities and derivatives, as well as repurchase agreements in bonds, debentures, debenture stock, securitised debt and other debt securities. All other segments of the securities market are regulated by the SEBI through powers conferred on it by the Securities and Exchange Board of India Act and the SCRA and through powers delegated to it by the central government under the SCRA.

The Depositories Act, 1996, paved the way for the establishment of securities depositories that support the electronic maintenance and transfer of ownership of securities in a dematerialised form, facilitating faster settlement in the securities market.<sup>10</sup>

---

<sup>9</sup> Section 2 (1) (i) of the Payment and Settlement Systems Act, 2007, defines a payment system as “a system that enables that payment to be effected between a payer and a beneficiary, involving clearing, payment or settlement service or all of them, but does not include a stock exchange”.

<sup>10</sup> Prior to the enactment of the Act, the securities were held in physical form with the beneficial owners.

The Companies Act, 1956, sets out the code of conduct for the corporate sector in relation to the issue, allotment and transfer of equity. It also regulates underwriting, the use of premiums and discounts on issues, rights and bonus issues, the payment of interest and dividends, and the publication of annual reports and disclosure of other information.

## **1.2 The role of the central bank**

The responsibilities of the RBI include issuing notes, providing payment services, acting as banker to the government and to banks, supervising and regulating banking institutions, conducting monetary policy, maintaining the external value of the rupee and acting as the custodian for the country's foreign exchange reserves. Direction and oversight of the RBI's affairs are vested in its Central Board of Directors.

### **1.2.1 Note issuance**

The responsibilities of note and coin issuance and currency management entrusted to the RBI under the RBI Act are fulfilled by the RBI through 19 of its regional offices, eight sub-offices/currency chests and (as of June 2010) a network of 4,302 currency chests.<sup>11</sup> Under the Act the RBI is the sole authority for the issue of currency notes and coins. The RBI's currency management function focuses on ensuring the adequate availability of notes and coins and on improving the quality of notes in circulation and enhancing the security features of banknotes. A recent priority has been to mechanise the processing and destruction of notes. Banknotes are printed by four security presses, of which two are owned by the government and two by an RBI subsidiary. The RBI issues notes in denominations of INR<sup>12</sup> 5, 10, 20, 50, 100, 500 and 1,000. The government is responsible for minting and supplying coins to the RBI, which acts as the agent of the government in issuing and distributing coins, as well as withdrawing and remitting them to the government.

### **1.2.2 Payment and settlement services**

The RBI plays a major operational role in the payment and settlement system. It established and also manages the RTGS system used for settling large-value and time-critical retail payments above INR 200,000, as well as transactions related to the securities settlement system (SSS). The SSS facilitates electronic trading and settlement of government securities. Its introduction eliminated the manual processing of securities transactions and centralised all the investments of market participants at the Mumbai office of the RBI. In the retail payments area, the RBI operates and manages clearing houses (for both paper-based and electronic transactions) in four metropolitan cities, namely, Chennai, Mumbai, Kolkata and New Delhi. The central bank also functions as the settlement bank for retail payments in these four cities and 13 other large cities.

#### *Provision of settlement (and credit) facilities*

The RBI of India plays a direct role in providing settlement and credit facilities. Central bank money is the asset used for settlement. To facilitate this, the RBI requires participants in the various payment systems to maintain accounts with the central bank.

---

<sup>11</sup> A currency chest is a repository of notes and coins of the RBI under the custody of a commercial bank.

<sup>12</sup> The USD-INR year-end reference rate as on 31 December 2009 was USD 1 = INR 46.68.

- *Current account*

Banks in India maintain current accounts with the RBI not only because it is their banker and lender of the last resort, but also for statutory reasons. Under the provisions of the RBI Act, 1934, and the Banking Regulation Act, 1949, banks are required to maintain statutory cash reserves with the RBI. For this purpose they maintain a current account with the RBI designated as the principal current account, where their cash reserve balances are maintained and monitored. To facilitate the settlement of interbank payments, banks need additional accounts: a secondary account, held at the same RBI office as their principal account, and a subsidiary account, held at other RBI offices, depending upon their operations and requirements.

Banks must meet certain minimum balance requirements in each of these accounts. The funds in these current accounts are used for the settlement of interbank and government payments, and the net settlement obligations arising from cheque-based clearing or the electronic retail payment system, and for funding the RTGS settlement account. Banks can transfer funds between accounts they hold at different RBI offices. Overdrafts are not allowed in these accounts and will result in penal action, as will balances that fall below the minimum requirement. For smooth operation of the payment systems, the RBI provides liquidity support to banks and primary dealers facing temporary liquidity problems against collateral consisting of Indian sovereign/guaranteed securities.

To promote the development of the government securities market, the current account facility has been extended to non-bank entities such as primary dealers in government securities. Similarly, other non-bank entities such as non-banking financial institutions and insurance companies have been allowed to open current accounts with the RBI to facilitate the settlement of their money market operations (as they are not clearing house members). At present, institutions allowed to open current accounts at the RBI include banks, primary dealers, central and state governments, local bodies, quasi-government institutions, foreign central banks, foreign governments, international organisations, financial institutions, insurance companies and securities depositories.

Participants in the RTGS system must have an RTGS settlement account. Current account balances can be used to fund this account at the start of the RTGS business day. Throughout the day, participants can transfer funds between their RTGS settlement account and their current account. At the end of the day, the RTGS settlement account balance is transferred to the respective current account.

- *Subsidiary general ledger (SGL) account*

Under the Banking Regulation Act, 1949, banks in India must maintain reserves of cash, gold or unencumbered approved securities as a statutory requirement. The banks maintain statutory reserves and their investments in government securities in dematerialised form in an account called the subsidiary general ledger (SGL) account, which is held with the RBI.

The RBI's Public Debt Office (PDO) acts as the depository for all central and state government securities. These securities are issued in physical and dematerialised form. Subsequent to the introduction of delivery versus payment (DVP) for the settlement of government securities transactions in 1995, it was required that these securities be held as far as possible in dematerialised form. For this purpose, all investors were required to open SGL accounts, for the record-keeping of securities as book entries. Later the provision of SGL accounts was rationalised, so that the PDO now offers SGL accounts only to banks and entities that have a current account with the RBI. Institutions regulated by the RBI are required to hold securities only in dematerialised form. In the past, banks could hold multiple SGL accounts at various RBI offices, based on their operational requirements. However, with the introduction of the NDS/SSS, their SGL accounts have been centralised at the PDO of the RBI's Mumbai office to facilitate centralised settlement of government securities transactions.



SGL account holders may transact in securities through primary market operations as well as secondary market trading. Under the DVP mechanism, trades in government securities are settled by debiting or crediting participants' SGL accounts. Securities held in their SGL accounts can also be used as collateral for loans and advances obtained from the RBI (under the provisions of the RBI Act). Besides holding securities in their own investment portfolios, banks may open separate accounts for investment in government securities on behalf of their customers. These are called constituent SGL (CSGL) accounts. Securities held in SGL and CSGL accounts are kept strictly segregated.

Banks must open a separate SGL account (an IDL-SGL account) to obtain collateralised intra-day liquidity (IDL) for settling transactions in the RTGS system. This IDL-SGL account is used for depositing or transferring collateral to the intraday liquidity (IDL) facility related to the RTGS system. Participants can move securities freely between their IDL-SGL and regular SGL accounts. The use of the IDL facility is reversed and the securities are automatically released by the RBI into the IDL-SGL accounts when funds become available on banks' RTGS settlement accounts. RTGS members can view their SGL and IDL-SGL account balances in real time and transfer securities from one account to another electronically.

Participants also use the securities in their SGL account to provide collateral and contributions to the settlement guarantee fund maintained by CCIL<sup>13</sup> (to facilitate the guaranteed settlement of government securities transactions). To facilitate faster movement of collateral between CCIL and its members, members may make online transfers of securities from their SGL account with the RBI to the SGL account that CCIL holds at the RBI. This is considered a value-free transfer and not a DVP transaction as it involves only a securities transfer and no funds transfer is involved.

The two securities depositories, National Securities Depository Limited (NSDL) and Central Depository Services Limited (CDSL), also maintain SGL accounts with the RBI to facilitate the dematerialised settlement of government securities traded in the retail debt segment of the NSE and BSE.

### *Monetary policy and payment systems*

Under the provisions of the RBI Act, 1934, and the Banking Regulation Act, 1949, banks must maintain a statutory minimum of cash reserves in a current account with the RBI.<sup>14</sup> These reserves are defined as a percentage of banks' demand and time liabilities. Similarly, under the provisions of the Banking Regulation Act, 1949, banks are required to maintain a certain percentage of their total demand and time liabilities in India in the form of cash, gold or approved securities (the statutory liquidity ratio or SLR).<sup>15</sup>

As part of its monetary policy operations, the RBI has traditionally used direct instruments such as reserve requirements, increasing or decreasing the cash reserve ratio (CRR) and SLR to influence the level of liquidity in the system and thus achieve its monetary policy objectives. However, with the development of the country's financial markets, monetary policy objectives are now increasingly being met with indirect instruments such as open market operations (OMOs), the Liquidity Adjustment Facility (LAF) and the Market Stabilisation Scheme (MSS).

---

<sup>13</sup> This fund is used for CCP-related risk management. If a member defaults, its contribution to the fund is utilised.

<sup>14</sup> Non-scheduled banks maintain cash reserves by holding physical cash or by maintaining a balance in the current account with the Reserve Bank or by way of a net balance in current accounts with the State Bank of India and its associate banks or public sector banks, or in one or more of these options.

<sup>15</sup> The stipulated requirement is announced by the RBI in its periodic monetary policy reviews based on the factors affecting liquidity in the system.

Through OMOs, the RBI sells or purchases government securities on an outright basis when it wants to permanently decrease or increase the liquidity available in the economy.

However, to address temporary mismatches in liquidity on a day-to-day basis, the LAF is the preferred option. The LAF consists of interventions at the shorter end of the money market through the use of repurchase agreements (repos) and reverse repos.<sup>16</sup> These are conducted as hold-in-custody operations, whereby the securities are held in custody by the RBI. The duration of these repos and reverse repos is usually overnight, though longer durations of 14 or 28 days have also existed. These auctions are conducted on a fixed rate basis, although there have also been variable rate auctions. The LAF has emerged as the RBI's prime instrument for influencing liquidity and transmitting interest rate signals to the market.

The MSS was introduced in April 2004. Its objective is to provide more flexibility to the RBI in its monetary management. Under the MSS, the RBI can issue government securities to sterilise excess liquidity that might arise from long-term capital flows. Under the scheme, the RBI issues treasury bills or dated securities up to a pre-agreed ceiling; the interest cost is borne by the government, while the proceeds are retained by the RBI until the redemption of the MSS securities.

The RBI's lender of last resort/emergency liquidity assistance function is primarily intended to deal with systemic crises. Lender of last resort assistance is provided under exceptional circumstances to any entity solely for the purpose of regulating credit in the interests of Indian trade, commerce, industry and agriculture, repayable on demand or on the expiry of a fixed period not exceeding 90 days, against any bill of exchange or promissory note. Section 18 of the RBI Act empowers the RBI to provide such support to any entity on such terms and conditions as found suitable by the RBI for a period not exceeding 90 days.

#### *Public debt office*

The RBI is the central security depository (CSD) for government securities. As such, the settlement of government securities trades in the secondary market, as well as acquisitions of such securities by investors in primary issues (through flotation or auctions), is reflected in the books of the RBI (in electronic bookkeeping form). Other related services are also provided by the RBI to investors – for instance, transfers, nominations, interest payments and redemptions. These services are provided by the RBI's Public Debt Office (PDO). In February 2002, the RBI set up an electronic trading and reporting platform for OTC government securities transactions called the Negotiated Dealing System (NDS). The OTC trades reported over the NDS are accepted for clearing by CCIL which acts as the CCP for government securities trades that are finally settled in the SSS.

The RBI aims to facilitate straight through processing of clearing and settlement of trades related to government securities for which the PDO discharges the functions of a CSD. To this end, it seeks to improve the facilities for trading and settlement in the government securities market. For that reason the RBI introduced an electronic order-matching trade module for government securities on its Negotiated Dealing System (RBI-NDS-GILTS-Order Matching Segment, NDS-OM) on 1 August 2005. The system is anonymous and purely order-driven, with all orders being matched by strict price/time priority and the executed trades then flowing directly to CCIL, which becomes the CCP to each trade on the system.

In its first phase, only regulated entities, that is, banks and primary dealers, were permitted to access NDS-OM. Subsequently, insurance companies gained access. Those without a current account with the RBI were allowed to open special current accounts (the current

---

<sup>16</sup> Repos are a purchase of securities to temporarily inject liquidity in the system, while reverse repos are the sale of securities to temporarily absorb excess liquidity in the system.

account facility has since been withdrawn and these entities, together with mutual funds, now have a current account with designated commercial banks). Access to NDS-OM has now been extended to all qualified mutual funds, provident funds and pension funds. Larger institutions can have direct access to the system, while smaller players access it through a principal member (via a CSGL account).

### 1.2.3 Oversight

The Payment and Settlement Systems Act 2007 (PS Act) mandates the RBI to regulate and supervise payment systems. Chapter III of the Act lays down that “no person ... shall commence or operate a payment system except under and in accordance with an authorisation issued by the RBI under the provisions of this Act”. The regulation and supervision of payment systems is provided for in Chapter IV.<sup>17</sup>

The aims and scope of the oversight are outlined in *Payment Systems in India Vision 2009–12*. The document states that the aim is “to ensure that all payment and settlement systems operating in the country are safe, secure, sound, efficient, accessible and authorised”.

Before the PSS Act was enacted, the MICR cheque clearing houses were assessed with regard to (i) URRBCH; (ii) minimum standards for operational efficiency for MICR clearing; (iii) MICR procedural guidelines and (iv) various circulars issued by the RBI. Other electronic retail payment systems were assessed on their individual procedural guidelines and benchmarks or best practice indicators for operational efficiency.

Under the PSS Act, oversight is more structured, and comprises the three major activities of monitoring, assessment and inducing change.

Monitoring: “planned” systems are monitored through the authorisation process, which comprises submission of the following:

- an application by the entity with the notified fee amount;
- Memorandum of Association;
- the entity’s financial statements;<sup>18</sup>
- details of Board of Directors and the CEO;
- a clear process flow;
- proposed business plan;
- gross/net/hybrid settlement mode;
- risk mitigation mechanism;
- ensuring Know Your Customer (KYC) norms; and
- mechanism for redressal of customer grievances.

Assessment: systems are assessed through a process of off-site surveillance and needs-based on-site inspections. Off-site surveillance is conducted through a combination of annual

---

<sup>17</sup> The powers to regulate and supervise comprise: Section 10: Power to determine standards; Section 11: Notice of change in the Payment System; Section 12: Power to call for returns, documents or other information; Section 13: Access to information; Section 14: Power to enter and inspect; Section 16: Power to carry out audit and inspection; Section 17: Power to issue directions; Section 18: Power of RBI to give directions generally; Section 19: Directions of RBI to be generally complied with.

<sup>18</sup> Different capital requirements are specified by the RBI for entities based on the type of payment system they propose to operate.

self-assessment by the payment system operator and the information it furnishes. Annual self-assessments are carried out by the payment system operators according to an assessment template prepared by the RBI. Various risk assessment templates corresponding to different retail (electronic and paper) payment systems and large-value payment systems form part of the assessment framework. The assessment templates for retail (electronic and paper-based) are based on a subset of the Core Principles.<sup>19</sup> With respect to financial market infrastructures (FMIs), the assessment template is based on standards such as the Core Principles, Recommendations for Securities Settlement Systems and Recommendations for Central Counterparties.

On-site inspections are based on the risk profile of the entity derived from the annual self-assessment, information provided by the entity concerned, and market intelligence.

Currently, all payment systems provide turnover data (volume and value) to the RBI. In future, information on a variety of risk parameters will be collected in a more detailed format.

A system of alerts for proactively managing the smooth and efficient functioning of payment systems in the country is also planned. The alerts will track various risks such as credit, liquidity, counterparty, settlement and operational exposures.

Inducing change: a variety of tools exists, starting with the URRBCH and the procedural guidelines for various products, Minimum standards for operational efficiency for select retail payment systems, RTGS business rules and membership criteria, as well as statutory powers conferred by the PSS Act, are available for inducing change. In addition, meetings where stakeholders can air their views can pave the way for changes in policy. Moral suasion continues to be an important tool for effecting change.

To sum up, the oversight process relies on off-site surveillance and needs-based on-site inspection, data and information collection, compilation and analysis, and a system of alerts complemented by market intelligence.

#### **1.2.4 Cooperation with other institutions**

The RBI liaises with all stakeholders including the Indian Banks Association and participants as part of its consultative process on all major policy initiatives. The RBI is a member of the South Asian Association for Regional Cooperation (SAARC) Payments Council. Under this initiative, technical assistance has been provided to a SAARC member nation which is modernising its payment system. The RBI also cooperates with the Federal Reserve for the USD-INR net settlement system for which the Clearing Corporation of India Ltd acts as a central counterparty. In association with the CPSS, the RBI also conducts seminars on payment systems for countries in the region. In addition, some African nations have requested and received technical assistance to improve their payment system infrastructure.

##### *Indo-Nepal remittances*

Given the large number of Nepalese people who work in India and send money to relatives in Nepal, the need was felt for an affordable payment facility for remittances from India to Nepal. Agreed between the Nepal Rastra Bank (the central bank of Nepal) and the RBI, the scheme commenced operation on 15 May 2008. Its main features are:

- (i) One-way remittances are sent from India to Nepal using the banking system with a ceiling of INR 50,000 per remittance and a maximum of 12 remittances per person per year.

---

<sup>19</sup> Core Principle (CP) I, CP-II, CP-V, CP-VII, CP-IX and CP-X.

- (ii) The remittance facility is extended to non-customers as well as customers of the banks.<sup>20</sup>
- (iii) All NEFT-enabled bank branches in India participate in this cross-border remittance scheme.
- (iv) Remittances are distributed to the beneficiaries in Nepal through the branches of Nepal State Bank Ltd and its approved agents.

### 1.3 The role of other private and public sector bodies

Financial intermediaries in India are categorised into four groups:

- commercial banks
- cooperative banks
- financial institutions
- non-bank financial companies

Commercial banks can be divided into distinct categories depending on their method of establishment and pattern of ownership. These are public sector banks (PSBs, in which the government holds an equity stake), private sector banks, foreign banks and regional rural banks (RRBs). Commercial and cooperative banks are allowed to engage in a wide range of banking and financial services. Financial institutions and non-bank finance companies are not allowed to accept deposits with a cheque issuance facility. Non-bank entities now under the PSS Act are permitted to provide certain payment services after due authorisation from the RBI under the PSS Act subject to adherence to the norms prescribed for the service provided.<sup>21</sup>

Banks must be licenced by the RBI. In addition to the licence, banks that fulfil certain conditions<sup>22</sup> are considered for inclusion in the Second Schedule to the RBI Act. Banks that do not fulfil these conditions are treated as non-scheduled banks.

At the end of March 2010, there were 169 commercial banks, 1,674 urban cooperative banks (UCBs), 31 state cooperative banks, 370 district central cooperative banks, four development financial institutions and 12,630 (June 2010) non-bank finance companies in India. The commercial banks comprise 27 PSBs, 22 private sector banks, 34 foreign banks and 82 RRBs and four local area banks. The cooperative banking system forms an integral part of the Indian financial system, where UCBs play an important role as financial intermediaries in urban and semi-urban areas, catering to the needs of the non-agricultural sector, particularly small borrowers. The RRBs, owned by the commercial banks and the central and state governments, were formed under the Regional Rural Bank Act, 1976. They play a key role in rural institutional financing, in terms of geographical and client coverage, business

---

<sup>20</sup> Remittances can be initiated by passing cash over the counter or by a credit transfer from the senders' bank account.

<sup>21</sup> An entity which is licensed by the RBI as a bank can accept deposits from the public and provide a cheque issuance facility. Entities which are not banks cannot issue cheques and cannot participate in the payment system. The only exception is the Post Office.

<sup>22</sup> It should (i) be a state cooperative bank or a company under the Companies Act or any institution notified by the central government for the purpose of inclusion in the Second Schedule of the RBI Act, or any corporation or a company which is formed by or under any law in any place outside India; (ii) have paid-up capital and reserves of an aggregate value of not less than INR 500,000; and (iii) satisfy the RBI that its affairs are not being conducted in a manner detrimental to the interests of its depositors.

volume and contribution to the development of the rural economy. The public sector banking institutions with their nationwide branch network dominate the banking sector.

### **1.3.1 The Indian Banks' Association**

The Indian Banks' Association (IBA), formed in 1946, is a self-regulatory body with 159 members comprising public sector banks, private sector banks, foreign banks with offices in India, urban cooperative banks, developmental financial institutions, federations, merchant banks, mutual funds and housing finance corporations. The IBA facilitates promotion of sound and progressive banking principles and practices, cooperation and coordination on procedural, legal, technical, administrative and professional matters, and the pooling of expertise for common purposes, such as reducing costs, increasing efficiency or improving systems, procedures and banking practices. The IBA coordinates issues in the area of payment, clearing and settlement systems in the committees that are formed for this purpose. Moreover, it coordinates with financial sector regulators in all relevant areas. The IBA represents the banking sector's interests in the areas of charges for payment products, ATM usage etc, and interacts with the RBI on these issues. IBA also plays a major role in the implementation of cheque standardisation, including the selection of printers of blank cheque forms.

### **1.3.2 The Clearing Corporation of India Limited**

The Clearing Corporation of India Limited (CCIL) was set up in 2001 under the Indian Companies Act. Within a decade, CCIL has come to occupy a significant position in the country's payment system. Various banks and financial institutions contribute to its share capital. CCIL was established with the aim of providing a safe institutional framework for the clearing and settlement of trades in government securities, forex, money and debt markets, so as to bring efficiency to the transaction settlement process and protect participants from counterparty risks. CCIL acts as the CCP through novation and guarantees settlement for transactions in the government securities and foreign exchange markets. CCIL has also developed a money market product, the collateralised borrowing and lending obligation (CBLO)<sup>23</sup> and guarantees its settlement. Participants in these markets must become members of CCIL for each segment separately and contribute to CCIL's settlement guarantee fund.<sup>24</sup>

CCIL offers a platform for the settlement of foreign exchange trades through CLS Bank using the third-party services of a settlement bank.

CCIL also provides non-guaranteed settlement facilities for transactions routed via the National Financial Switch (NFS), which is the main switch for ATM transactions in India. In this case, CCIL neither acts as a CCP nor does it provide guaranteed settlement. The settlement file is routed through CCIL to the RBI where the final settlement takes place in central bank money.

In June 2003, CCIL set up a wholly owned subsidiary, Clearcorp Dealing Systems (India) Ltd to provide dealing systems/platforms for CBLOs, repos and money market instruments of any kind, as well as for foreign exchange.

---

<sup>23</sup> The "Collateralised Borrowing and Lending Obligation (CBLO)", a money market instrument, is a product for entities who are either excluded from the interbank call money market or whose access to it is restricted by a ceiling on call borrowing and lending transactions, and who do not have access to the call money market. The CBLO is a discounted instrument in electronic book entry form with a maturity ranging from one day to ninety days (and up to one year under RBI guidelines) that allows market participants to borrow and lend funds.

<sup>24</sup> The settlement guarantee fund is made up of initial margins collected by members. In the event of a default, the defaulting member's contribution is used.

### **1.3.3 India Post**

India Post has a large network of post offices across the country. In addition to mail and parcel services, post offices offer savings accounts and insurance products. Several new services such as Western Union money transfers, electronic money orders and distribution of mutual funds have been added to India Post's range of services in the past decade. Post offices are clearing house members even though they are not banks. They can also issue cheques to their savings account holders.

### **1.3.4 The Institute for Development and Research in Banking Technology**

The Institute for Development and Research in Banking Technology (IDRBT) was established by the RBI in 1996 as an autonomous centre for development and research in banking technology, with a view to implementing a variety of payment applications and fostering the development of a reliable communication network. The Governing Council of the IDRBT includes the Deputy Governor and an Executive Director of the RBI, in addition to members from the IBA and from leading academic institutions (in the area of science and technology).

The IDRBT concentrates its research efforts on financial network architecture, security policy, security systems, payment and settlement systems and data warehousing. Through its education, training and e-learning programmes and initiatives, the IDRBT contributes to the education of technology professionals from India's banking sector. The IDRBT operates and manages the Indian Financial Network (INFINET), a closed user group communication backbone for the Indian financial sector that hosts intrabank and interbank applications. The IDRBT is also the certifying authority for the Indian financial sector under the Information Technology Act, 2000.

To support straight through processing for payment system applications, the IDRBT developed the Structured Financial Messaging Solution (SFMS), which is akin to SWIFT for message exchange within India. The National Electronic Funds Transfer (NEFT) system was developed on an SFMS platform by the IDRBT.

### **1.3.5 National Payments Corporation of India**

With banks as its shareholders, the National Payments Corporation of India (NPCI) is an umbrella organisation for retail payment systems. It is incorporated as a company under Section 25 of the Companies Act (which does not pay dividends to its shareholders and applies its profits or other income to promoting its objectives). Its aims are the optimal use of resources through consolidation of existing infrastructure; the construction of new nationwide payments infrastructure; and the provision of a robust and affordable technology platform for retail payment services. NPCI has since taken over the operations of the National Financial Switch from IDRBT.

### **1.3.6 Foreign Exchange Dealer's Association of India**

Foreign Exchange Dealer's Association of India (FEDAI) was set up in 1958 as an association of banks dealing in foreign exchange in India. (Such banks are known as Authorised Dealers or ADs). It is a self-regulatory body incorporated under Section 25 of the Companies Act. FEDAI's major activities include the framing of rules for the interbank foreign exchange business, and liaison with the RBI on reforms and the development of the forex market. FEDAI aims for the smooth functioning of the markets through close coordination with the RBI and other organisations such as the Fixed Income Money Market and Derivatives Association of India (FIMMDA), the Forex Association of India and various market participants.

### **1.3.7 Fixed Income Money Market and Derivatives Association of India**

The Fixed Income Money Market and Derivatives Association of India (FIMMDA) is an association of scheduled commercial banks, public financial institutions, primary dealers and insurance companies. Incorporated as a company under Section 25 of the Companies Act in 1998, it is a voluntary market body for the bond, money and derivatives markets. FIMMDA has members representing all major institutional segments of the market.

Its objectives are to:

- liaise with regulators on various issues that impact the functioning of these markets;
- undertake developmental activities, such as introduction of benchmark rates and new derivatives instruments;
- provide training and support for dealers and staff at member institutions;
- adopt and develop international standard practices and a code of conduct;
- devise standard best market practices;
- arbitrate in disputes between member institutions;
- develop standardised documentation; and
- facilitate smooth and orderly market functioning.

FIMMDA seeks to achieve these objectives by establishing specific working groups. FIMMDA is represented in the RBI's Technical Advisory Committees (TACs) on Government Securities and Money Market and on the Foreign Exchange Markets. FIMMDA also runs seminars, training programmes and symposiums.

### **1.3.8 The stock exchanges**

There are 19 stock exchanges in the country that are recognised under the Securities Contract Regulations Act, 1956 (SCRA). Most are regional exchanges. Their area of operation is specified at the time of their recognition under the SCRA. Companies wishing to list their securities on stock exchanges are obliged to do so on the regional stock exchange nearest to their registered office in order to facilitate investments and trade in securities. All of these exchanges have settlement guarantee funds, offer screen-based trading, and clear and settle trades independently. Companies can seek listing on other exchanges as well.

The SEBI has recently allowed all exchanges to set up trading terminals anywhere in the country. Three exchanges, the Over-the-Counter Exchange of India (OTCEI), the National Stock Exchange (NSE) and the Inter-Connected Stock Exchange of India (ICSE), were permitted to have nationwide trading facilities from their inception. The NSE has emerged as the country's leading stock exchange. Chapter 4 includes a detailed description of the two leading stock exchanges, the NSE and the Bombay Stock Exchange (BSE), which together account for more than 99% of India's stock market trading in terms of both volume and value.

Trades executed on the NSE are cleared and settled by the National Securities Clearing Corporation of India Limited (NSCCL), acting as a central counterparty. In the case of the BSE, an independent company, the Bank of India Shareholding Ltd (BOISL), handles clearing and settlement on behalf of the exchange.

### **1.3.9 Securities depositories**

The National Securities Depository Limited (NSDL) was established in November 1996 after the enactment of the Depositories Act in August of that year. The NSDL is promoted by the Industrial Development Bank of India (IDBI), formerly the largest development bank in India (now merged with the IDBI Bank), the Unit Trust of India (UTI, then the largest mutual fund)



and the NSE. The other shareholders of the NSDL include some large public sector, private sector and foreign banks.

Central Depository Services Limited (CDSL) was established in February 1999 and is promoted by the BSE, along with public, private and foreign banks in the country.

These depositories also extend their services to securities traded on other stock exchanges in the country.

The depository services for equities and debt instruments are extended through depository participants (DP), which can be banks, non-bank financial institutions, custodians, brokers, or any entity eligible under the SEBI (Depositories and Participants) Regulations, 1996. Currently, 758 DPs are registered with the two depositories, offering their services in many cities in the country. Investors must open an account with a DP in either of the two depositories in order to conduct transactions in dematerialised securities.

The two depositories have direct interfaces with the clearing houses of stock exchanges, issuing companies and their registrars, share transfer agents and depository participants. This facilitates dematerialisation of securities. However, the depositories can reconvert the securities to physical form at the request of the holder.

## **2. Payment media used by non-banks**

### **2.1 Cash payments**

In India, cash continues to be the most widely used medium of exchange. Cash is readily accessible through the growing number of ATMs that banks have deployed across the country in recent years. The RBI makes periodic changes to the design of banknotes as well as their production, distribution and withdrawal; old and unusable banknotes are destroyed and replaced with new ones. Currency notes are legal tender everywhere in India for payment or for deposit on account without any limit. The ratio of currency to broad money (M3: currency held by the public, demand and time deposits at banks and other deposits held at the RBI) was 14.3% at end-March 2010. The ratio of currency to GDP was 11.21%.

### **2.2 Non-cash payments**

In India, non-cash payments through banking channels are effected by means of cheques (64.7% of the volume and 11.7% of the total value of cashless payment transactions at end-March 2010), credit transfers (9.3% and 44.8% of the total volume and value respectively for transactions relating to ECS (credit, EFT/NEFT, and RTGS), payment obligations arising out of FX transactions, Government securities transactions and CBLO operated by CCIL (0.1% and 43.4% respectively), and direct debits and credit and debit cards (26.0% and 0.2% respectively).

#### **2.2.1 Cheques**

The predominant medium for non-cash payments in India is the paper-based cheque. Other paper instruments include banker's cheques and payment orders. At end-March 2010, 64.7% of the total number and 11.7% of the total value of cashless transactions were by cheque. Cheque volumes have risen substantially over the last three decades, owing to the expansion of banking branch networks and banking services. The share of cheque payments

in the total value of cashless payments has, however, declined since 2004–05,<sup>25</sup> as large-value interbank and some customer transactions are now settled through the RTGS system.

Under the Negotiable Instrument Act, 1881, cheques must be presented physically to the bank branch on which they are drawn. The resulting delayed payment cycles have prompted a shift from manual processing to more efficient electronic systems for the exchange and settlement of cheques. Automated cheque processing was introduced from the mid-1980s when the first MICR cheque processing centres (CPCs) were set up. Inter-city clearing started in the early 1990s (but was discontinued in November 2009). From the mid-1990s, the Magnetic Media-Based Clearing System has also helped to substantially reduce clearing and settlement times. (MMBCS provides for electronic settlement based on electronically submitted settlement data, although processing is manual.) The NI Act was amended in 2001 to allow scanned cheque images, paving the way for the cheque truncation initiative that went live in February 2008 in the New Delhi region. Another cheque truncation project is planned for Chennai in south India. Growth in cheque volumes is expected to slow in the medium term, as electronic payments gain ground.

### **2.2.2 Credit transfers**

While credit transfers represented 44.8% of all cashless payments in terms of value at end-March 2010, in terms of volume they only represented 9.3%. This indicates that large-value payments are now increasingly carried out as electronic credit transfers. The settlement of government securities, foreign exchange and CBLO transactions (through CCIL) are settled electronically on a net basis.

The Electronic Clearing Service (ECS), which clears retail electronic transfers, comprises a credit and a debit system. The ECS system is used mainly for one-to-many transfers. In the ECS Credit system, each single debit transaction triggers a large number of credit entries. In the ECS Debit system a large number of debits result in a single credit entry. The ECS Debit system is presented in Section 2.2.3.

The National Electronic Funds Transfer (NEFT) system came into operation in November 2005. It facilitates electronic retail transfers between bank branches using SFMS and secured by PKI (public key infrastructure) technology. The Electronic Funds Transfer (EFT) system that was previously in use has been discontinued.

The RTGS system, which is used mainly for large-value payments, settles both interbank and customer transactions. A threshold value<sup>26</sup> has been prescribed for customer transactions in RTGS, while there is no such limit under NEFT. Customers can choose to make payments through either RTGS (if they are above the threshold limit) or NEFT. The RTGS system accounts for a large percentage of the total value of funds transfers in the country. The details of the RTGS system are presented in Section 3.2.

### **2.2.3 Direct debit**

The ECS Debit scheme is the only direct debit scheme in India for payments to electricity, telephone, insurance or credit card companies, or payments of loan instalments etc. ECS Debit aggregates a large number of debits into a single credit to the beneficiary. The system works on the principle of preauthorised debits, which is a signed paper mandate obtained from the customers by the utility company with a copy of the signed mandate being maintained at the bank. The account holder's account is debited on the agreed date and the

---

<sup>25</sup> Financial year from April 2004 to March 2005.

<sup>26</sup> At present the threshold value for customer payment orders in RTGS is INR 200,000.

amounts are credited to the beneficiary. The customer can set a ceiling on the amount that can be debited from his account for any particular type of payment. Prior to the value date, the utility company informs the customer of the debit amount and, if the debit amount is incorrect, the customer can instruct his bank to stop payment. Final settlement takes place both in central bank money and in commercial bank money (in those centres where the RBI does not have an office). In Mumbai, the settlement takes place in RTGS.

The volume of ECS Debit transactions increased from 36.0 million as at end-March 2006 to 150.2 million as at end-March 2010, with the value of transactions rising from INR 129.9 billion to INR 698.2 billion.

#### **2.2.4 Payment cards**

Card-based transactions are registering phenomenal growth in India. Cards, especially debit cards, are becoming the preferred electronic payment mode for both consumers and retailers.

##### *Credit cards*

Credit cards were introduced in India in the late 1980s and have since gained large-scale acceptance. Under the PSS Act, American Express Banking Corp, USA; Diners Club International Ltd, USA; MasterCard International Inc, USA; and Visa Worldwide Pte Ltd, Singapore, have been authorised to issue credit cards in India.<sup>27</sup> At end-March 2010, 24.1 million credit cards had been issued by banks in India.

##### *Debit cards*

In recent years, debit card issuance and usage have grown much faster than those of credit cards. Banks in India also offer combined ATM and debit cards. Under the PSS Act, American Express Banking Corp, USA; MasterCard International Inc, USA; Visa Worldwide Pte Ltd, Singapore, have been authorised to issue debit cards in India.<sup>28</sup> At end-March 2010, banks in India had issued 143.0 million debit cards.

##### *Prepaid payment Instruments*

Prepaid payment instruments are payment instruments with value stored on smart cards, magnetic strips cards, internet accounts, internet wallets, mobile accounts, mobile wallets, paper vouchers and stored value internet payment services. Prepaid instruments are a convenient cashless payment method and facilitate e-payment for goods or services purchased via the internet or mobile phone. The RBI issued guidelines in April 2009 and August 2009 on prepaid payment instruments. Issuers of prepaid payment instruments must be authorised by the RBI under the PSS Act. Authorisation by the RBI is required for the following types of instrument:

- semi-closed system payment instruments: these are payment instruments that are redeemable at a group of clearly identified merchant locations/ establishments, which contract specifically with the issuer to accept the payment instruments. These instruments do not permit cash withdrawal or redemption by the holder.
- open system payment instruments: these are payment instruments that can be used for purchase of goods and services at any card-accepting merchant locations (point of sale terminals) and which also permit cash withdrawal from ATMs.

---

<sup>27</sup> At the moment there are no domestic credit card brands in India.

<sup>28</sup> At the moment there are no domestic debit card brands in India.

Only banks can issue open system payment instruments. For schemes operated by banks, the outstanding balance forms part of the “net demand and time liabilities” for the purpose of maintaining reserve requirements. This position is computed on the basis of the balances appearing in the books of the bank as on the date of reporting. Other non-bank persons issuing payment instruments are required to maintain their outstanding balance in an escrow account with any scheduled commercial bank and the amount so maintained is to be used only for making payments to the participating merchant establishments. The maximum limit for issuance of prepaid payment instrument is INR 50,000.

### **2.2.5 Point of sale (POS) infrastructure**

The total number of POS terminals in the country as of September 2010 was 524,038. All the POS terminals are interoperable with the exception of the terminals belonging to American Express. Transactions undertaken at POS terminals with debit or credit cards are settled as normal card transactions, with the acquiring bank routing these transactions to the VISA switch for settlement through Bank of America in the case of VISA-branded cards. For MasterCard-branded cards, transactions are routed to the MasterCard switch and settled through Bank of India. Settlement in both cases is on a T+1 basis.

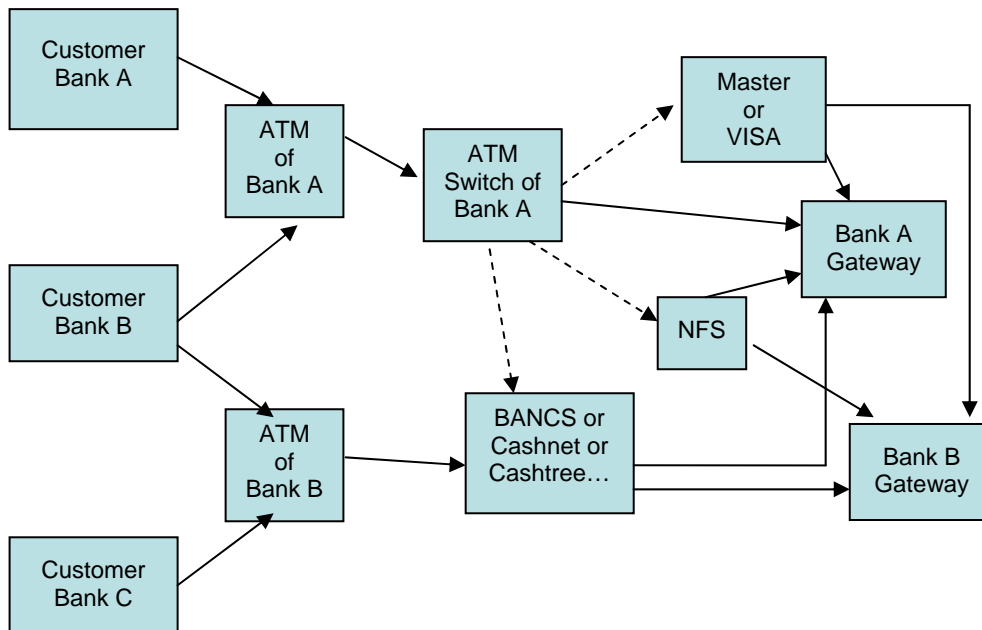
The use of debit cards at point of sale (POS) terminals has been increasing. Cash withdrawals at POS terminals have been permitted from July 2010, with this facility available on all debit cards issued in India, with a limit of INR 1000 per day. Cash withdrawals are available whether or not the cardholder makes a purchase. Banks offering this facility have been advised to put in place a proper customer redress mechanism. Earlier, the cash withdrawal facility using plastic cards was available only at automatic teller machines (ATMs).

### **2.2.6 ATM infrastructure and services**

The total number of ATMs in the country as of September 2010 was 64,965. The major ATM networks in India are National Financial Switch (NFS), CashTree, BANCS, Cashnet, and the SBI Group network. In addition, most ATM switches are also linked to VISA or MasterCard gateways (for cards affiliated to VISA and MasterCard). The NFS is the largest of these networks.

*National Financial Switch (NFS):* The National Financial Switch (NFS) was established by IDRBT to facilitate connectivity among the ATM switches of all banks, addressing the limitations of other ATM networks and creating a reliable national infrastructure. Banks can connect to NFS either from their own switches or through the switch of their group. The NFS is now operated by the National Payments Corporation of India (NPCI). The Clearing Corporation of India (CCIL) is the settlement agency for all transactions routed through NFS. Forty-six banks participate in this service, covering a network of 62,842 ATMs as at end-September 2010.

ATM networks operate in clusters or other cooperative arrangements. A stylised transaction flow in an ATM network is shown below:



1. Where the issuing bank and acquiring bank are the same: when customer A uses its own bank ATM, the transaction is switched by the bank's ATM switch to its own gateway.
2. Where the issuing bank and the acquiring bank are different: customer B (of issuing Bank B) uses the ATM of Bank A (the acquiring bank), the transaction is routed to Bank A's switch. The Bank A switch has the option to route the transaction to one of the networks (shown with dotted lines):
  - (a) If Bank A and B are members of the same closed user group ATM Network (eg Cashnet, CashTree etc), the transaction is routed to the issuing bank from the network switch.
  - (b) If Banks A and B are not members of the same group, they exercise the option of routing the transactions to NFS (if Bank B is a member of NFS) or the VISA or MasterCard switch for transmission to the issuing bank.

ATMs are used mainly for cash withdrawals and balance enquiries. Savings bank customers can use a different bank's ATM free of charge for the first five transactions (of any type, financial or non-financial) in a month, with subsequent transactions being charged (the charge not to exceed INR 20). Customers pay no charges for using the ATMs of their own bank.

### 2.2.7 Postal orders, money orders and retail services from India Post

Another important and popular payment instrument is the money order (MO) service offered by India Post. MOs allow money to be transmitted via the postal network. The originating post office collects the remittance, plus a commission, from the person remitting the funds and sends an advice to the destination post office, where the funds are paid to the beneficiary. India Post also offers postal orders (POs), which are a prepaid funds transfer facility issued in various denominations. Recipients can encash them at any post office. MOs and POs are both giro payment instruments and are cleared outside the banking system. MOs are used for individual point-to-point transfers whereas POs are usually used to make small payments, eg for official charges or fees.

Other payment services from India Post include the Instant Money Order (iMO), an online money transfer service for amounts ranging from INR 1,000 to INR 50,000. An international

money transfer service is also available, through a collaboration between India Post and Western Union (for more information on remittances, see Section 2.3.4).

India Post has recently been authorised to issue prepaid payment cards to its account holders.

## 2.3 Recent developments

### ***Removal of charges for payment services***

The RBI has waived the processing charge levied on banks for ECS, NEFT and RTGS transactions until March 2011 to encourage the use of electronic payments and allow banks to pass on the benefit to the customers. Similarly, the limits on the size of ECS and NEFT transactions were removed in November 2004 to increase the user base.

#### ***2.3.1 Rationalisation of service charges***

The RBI has advised all banks of a framework for service charges. By this code, customers should not pay any charge for using the ATMs of their own bank. The use of a different bank's ATM is free up to the first five transactions (of any type, financial or non-financial) in a month, with subsequent transactions being charged (the charge not to exceed INR 20).

Under Section 18 of the Payment and Settlement Systems Act, 2007, the RBI has also issued a directive on the charges that banks can levy for various electronic products and for cheque collection services. The service charges are as follows:

Services	Transaction amount	Charges
Inward RTGS/NEFT/ECS		Free
Outward RTGS	– INR 200,000–500,000	– not exceeding INR 25 per transaction
	– INR 500,001 and above	– not exceeding INR 50 per transaction
Outward NEFT	– Up to INR 100,000	– not exceeding INR 5 per transaction
	– INR 100,001–200,000	– not exceeding INR 15 per transaction
	– INR 200,001 and above	– not exceeding INR 25 per transaction
Outstation cheque collection	– Up to INR 10,000	– not exceeding INR 50 per instrument
	– INR 10,001–100,000	– not exceeding INR 100 per instrument
	– INR 100,001 and above	– not exceeding INR 150 per instrument

#### ***2.3.2 Mandatory use of electronic mode of funds transfer***

An RBI directive has made it mandatory to route payments of INR 1,000,000 or more between RBI regulated entities and markets through electronic payment systems.

#### ***2.3.3 Internet/mobile phone banking***

Many banks offer internet banking services, which include access to account information as well as funds transfers between accounts, bill payments and online securities trading. The growing number of internet users and widening reach of internet services will have a significant impact on the way credit transfers are carried out.

Broader usage of mobile phones has encouraged banks and non-banks to develop new payment services for their customers, usually in cooperation with mobile service providers. Although other countries have adopted mobile phone-based technologies as a way of delivering access to financial services to a broader segment of the population, India has opted for a bank-led model.

The rapid growth in mobile phone banking prompted the RBI to issue a set of operating guidelines for banks in October 2008. For this purpose, “mobile banking transactions” are defined as banking transactions initiated by bank customers using their mobile phones that involve credits or debits to their accounts. The guidelines were relaxed in December 2009 to allow mobile banking transactions up to INR 50,000, both for e-commerce and money transfers. Banks are also permitted to provide money transfer facilities of up to INR 5,000 from a bank account to beneficiaries without bank accounts. In such cases, cash can be paid out at an ATM or a banking correspondent. By value, funds transfers account for a much larger share of mobile phone transactions than payments for goods or services. By volume, the reverse holds true. Final settlement of mobile banking transactions is made in central banking money.

#### **2.3.4 Remittance services**

The flow of inward remittances into the country has increased with the number of people migrating abroad for work. Such remittances are regulated by the RBI.<sup>29</sup> Remittances are received mainly through banks. In order to facilitate the faster receipt of funds by residents, the RBI permits money transfer agents to handle inward transfers, but not transfers out of the country.<sup>30</sup> Inward cross-border remittance services are offered by various money transfer agents and post offices. Agents must be authorised under the PSS Act to provide these services to Indian recipients.

#### **2.3.5 Role of intermediaries**

Electronic and online payment channels, which are increasingly popular for bill payments or online shopping, generally involve the use of intermediaries such as aggregators and payment gateway service providers. Platforms for such payments are also provided by electronic commerce and mobile commerce (e-commerce and m-commerce) service providers. The RBI has issued guidelines that safeguard the interests of customers and seek to ensure that their payments are duly accounted for by intermediaries,<sup>31</sup> so that transactions are completed in a safe and orderly way. The RBI stipulates that all accounts opened and maintained by banks for facilitating collection of payments by intermediaries from customers of merchants are to be treated as internal accounts of the banks.

The permitted credits/debits in these accounts are set out below:

1. Credits
  - (a) Payments from individuals towards purchase of goods/services.

---

<sup>29</sup> All providers of cross-border inward remittance services must be authorised by the RBI under the PSS Act.

<sup>30</sup> Under the Money Transfer Service Scheme (MTSS) guidelines, only personal remittances from abroad to beneficiaries in India and remittances to foreign tourists visiting India are permissible. The system is based on tie-ups between money transfer companies abroad and agents in India who pay out the remittances to the beneficiaries at current exchange rates. Outward remittances can be sent only through banks under the Foreign Exchange Management Act, 1999. As the INR is legal tender in Nepal, money transfers to Nepal are treated differently to other outward remittances (see also Section 1.3.4).

<sup>31</sup> Agents who deliver goods and services (such as travel or movie tickets) immediately on payment by the customer are not defined as “intermediaries” for this purpose.

- (b) Transfers from other banks as per agreement into the account, if this account is the nodal bank account for the intermediary.
  - (c) Transfers representing refunds for failed/disputed transactions.
2. Debits
- (d) Payments to merchants/service providers.
  - (e) Transfers to other banks as per agreement into the account, if that account is the nodal bank account for the intermediary.
  - (f) Transfers representing refunds for failed/disputed transactions.
  - (g) Commissions to intermediaries. These amounts shall be at pre-determined rates/frequency.

### 3. Payment systems (funds transfer systems)

#### 3.1 General overview

The settlement of both large-value and retail interbank payments in India was predominantly cheque-based<sup>32</sup> until RTGS was implemented in March 2004 and the subsequent issuance of instructions on the mandatory use of electronic payments for transactions between RBI-regulated entities and markets in March 2008. Since the introduction of the RTGS system, operated by the RBI, large-value and interbank transactions have progressively migrated to the RTGS system. The funds leg for settlement of securities, foreign exchange and CBLO transactions is also settled in the RTGS system. The separate high-value clearing for cheques of INR 100,000 and above, with same-day clearing and settlement, has also been discontinued since March 2010.<sup>33</sup>

The cheque-based clearing system continues to occupy a significant position, due to its volume, widespread usage and geographical coverage. There are 1,139 cheque clearing houses (as of March 2010) that clear and settle various types of paper-based instruments such as cheques, demand drafts, payment orders, interest and dividend warrants etc. In 66 of these clearing houses, cheque processing centres (CPCs) use MICR technology. Seventeen of these clearing houses are managed by the RBI, which provides settlement services for them through its banking department. In other places, the clearing house is managed by the State Bank of India (the country's largest public sector bank) and other public sector banks. These banks also perform the settlement bank function in these centres (a centre is within the jurisdiction of the clearing house).

The settlement of foreign exchange transactions has undergone significant changes, evolving from the direct settlement of transactions on a gross basis between trading members to multilateral net settlement with a guarantee from CCIL, a CCP. The INR leg of the trade is settled in the RTGS system. In addition, CCIL has introduced FX-CLEAR, a forex trading system which offers both order-matching and negotiation modes for dealing.

---

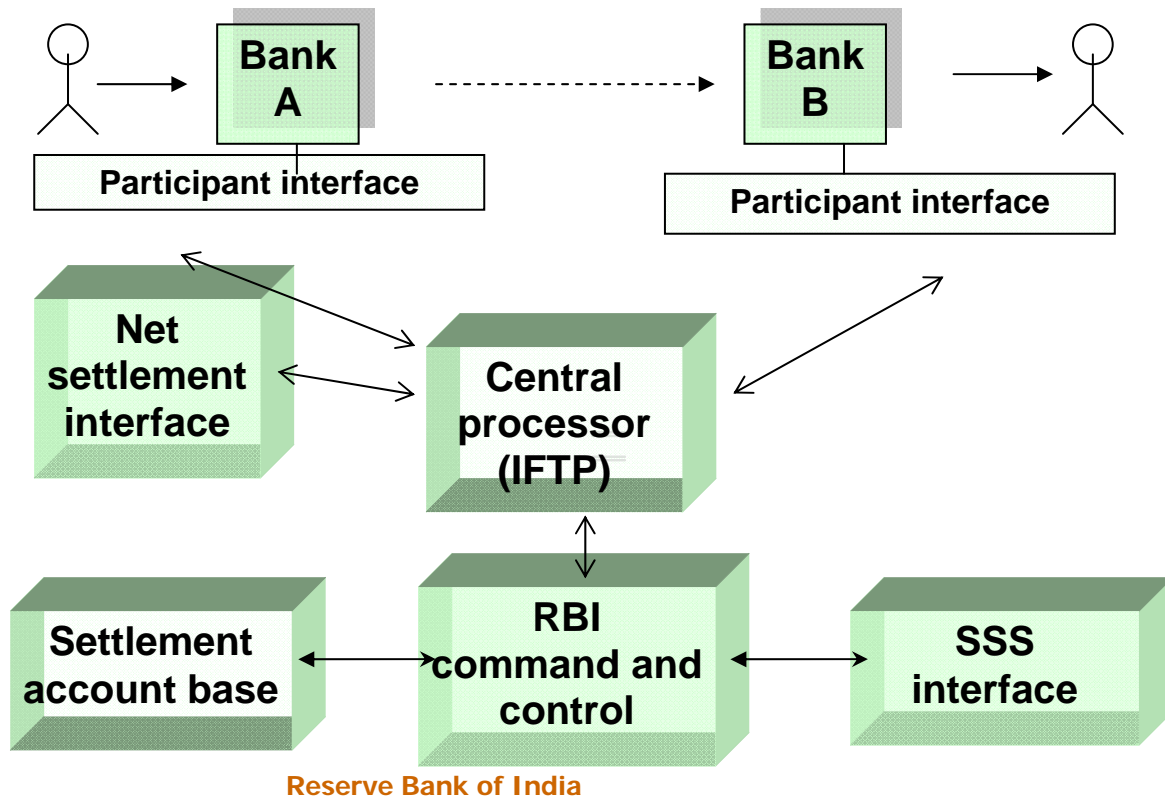
<sup>32</sup> A separate interbank clearing and settlement where banker's cheques were exchanged was introduced in 1989 as a risk mitigation measure for the cheque-based system; clearing and settlement was completed within 30 minutes in the accounts of the Reserve Bank.

<sup>33</sup> Transactions have migrated to electronic channels (RTGS/NEFT) or, if cheque-based, they are processed in the normal MICR clearing.



### 3.2 Real-time gross settlement system

The RTGS system, in operation since March 2004, is a large-value funds transfer system in which financial intermediaries can make payments for their own account as well as for their customers. The system offers final settlement of funds transfers on a continuous, transaction-by-transaction basis throughout the processing day. The process flow of the RTGS system is shown below.



#### 3.2.1 Operating rules

RTGS operations are governed by the RTGS (Membership) Regulations, 2004, and the RTGS (Membership) Business Operating Guidelines, 2004. These were previously contractual in nature but are now notified under the Payment and Settlement Systems Regulations, 2008. The regulations provide for the oversight of the RTGS system, a standing committee for the management of the system, an admission procedure for members etc. The RTGS guidelines detail business operations, including the use of settlement accounts and funding accounts, transaction types, communication, message formats, settlement of transactions, intraday liquidity facility, queue management and gridlock resolution.

### **3.2.2 Participants**

Membership is open to banks, primary dealers (market-makers in the government securities market) and any other institution at the discretion of the RBI.<sup>34</sup> The criteria for membership include membership of INFINET, membership in the NDS/SSS and maintenance of settlement accounts with the RBI in Mumbai. The RBI may provide membership of the RTGS system to clearing houses or agencies even if they do not fulfil the above criteria.

Members are classified into different categories, based on certain criteria. The RBI and the commercial banks belong to category A, primary dealers to category B. Members of categories A and B are direct members of the system. Clearing houses and clearing agencies (including CCIL) are category D membership. (There is no category C membership).

### **3.2.3 RTGS transaction types**

Members of categories A and B can submit their own interbank transactions, but only category A members can submit transactions on behalf of their customers. Transactions emanating from the SSS, settlements of the INR leg of foreign exchange transactions, and multilateral net settlements of cheque-based clearings, the ECS in Mumbai, the NEFT system and NECS are also processed in the RTGS system, in addition to transactions submitted directly by the RBI for its monetary policy operations. Category D members are allowed to submit only net settlement batches to the RTGS system.

### **3.2.4 Settlement procedure and liquidity support**

To settle transactions submitted to the RTGS system, members must maintain an RTGS settlement account with the RBI in Mumbai. This account has to be funded at the beginning of each RTGS processing day from the member's current account with the RBI, and at the end of the day the balance in the settlement account is transferred back to that current account. Since banks maintain current accounts with different offices of the RBI, they are allowed to transfer funds during the RTGS day between these current accounts and the RTGS settlement account. For this purpose, there is an interface between the RTGS system and the Integrated Accounting System (IAS) of the RBI. The IAS is the accounting system of the RBI (members' current accounts are in IAS). The banks use the option available in their Participant Interface (PI) (to transfer funds from one account to another in Mumbai) or use the centralised funds management system (CFMS) if the transfer is between accounts from one office of the RBI to another.

Transactions which have passed all validity checks are taken up for settlement on a FIFO with priority basis. All such transactions based on available balances in the settlement account are duly settled by debiting the account of the sending bank and crediting the account of the receiving bank. Settlement finality on a gross basis in real time is achieved when this process is complete.

Members can obtain intraday liquidity (IDL) from the RBI (fully collateralised by Indian government securities held by the members in their IDL-SGL account) free of interest to augment their available liquidity in the RTGS system. IDL must be returned by the end of the RTGS day. Failure to do so is subject to a penalty interest charge on outstanding balances.

---

<sup>34</sup> Foreign banks operating in India with a branch are RTGS members.

### **3.2.5 Transaction processing environment**

The RTGS system operated and managed by the RBI uses a Y-shaped message flow structure. Members connect to the system through INFINET and use the participant interface (PI) to communicate with the interbank funds transfer processor (IFTP), which validates all communications. When a transaction is successfully completed and this is confirmed by the RTGS system, the IFTP forwards the credit information to the beneficiary member's PI. All communications between the PI and the IFTP are encrypted and use digital signatures (under public key infrastructure).

### **3.2.6 The RTGS system process flow**

The RTGS business day starts at 09:00. Customer and interbank transactions can take place from the start of day to 16:30 and 18:00 respectively on weekdays and to 13:30 and 15:00 respectively on Saturdays. The IDL facility is available during these business hours.

A payment instruction is sent by a member through its PI, and is validated and acknowledged by the IFTP. It is then forwarded by the IFTP to the RTGS, which maintains the settlement accounts of the participants where the funds transfer actually takes place. In the RTGS, the availability of funds in the settlement account is checked, the funds are transferred (settlement takes place) provided balances are sufficient, and a message is sent to the IFTP for onward transmission to the beneficiary bank.

If sufficient funds are not available in the settlement account of the paying bank, the payment instruction is put in a queue that is processed on a first in, first out (FIFO) basis. Payment instructions can be assigned a priority by members (who can change these priorities until settlement). Instructions with a higher priority are processed first, while FIFO is applied to payment instructions with the same priority.

When a payment instruction is found pending in the queue, a message is sent to the SSS asking for the availability of eligible securities in the member's IDL-SGL account, for triggering IDL. If securities are available, the SSS uses them as collateral and a confirmation is sent to the RTGS system, where the necessary funds are made available and the payment is processed. When securities are not available, the SSS sends a message to the RTGS system and the payment instruction is put back into the queue.

At pre-scheduled intervals, the IDL reversal is activated to check for outstanding IDL utilised by members. If sufficient balances are available in a member's settlement account, the funds are utilised to reverse the IDL and a message is sent to the SSS to release the securities held as collateral into the member's IDL-SGL account. These securities then become available for other uses. Half an hour before the close of the RTGS business day, new IDL provision to members stops and members must return all outstanding IDL by the end of the day.

### **3.2.7 Credit and liquidity risk**

Settlement of transactions in RTGS on a gross basis eliminates credit risk. Liquidity risk is mitigated by the provision of IDL, which facilitates smooth settlement of transactions in the system. Now that the RTGS system is operational, the priority is to integrate other payment systems through the RTGS to mitigate the credit and liquidity risks present in those systems, as well as to promote efficient liquidity management by the participants. To this end, interfaces have been built with the securities settlement system and the foreign exchange transactions settlement mechanism. The settlement of these transactions now takes place in the RTGS system, as does the settlement for CBLOs. The settlement of the clearing operations at Mumbai for cheque-based (MICR clearing) and electronic clearing (ECS in Mumbai, NECS and NEFT) is settled in RTGS as a multilateral net settlement batch (MNSB). In addition to providing an interface to the RTGS system for various payment and settlement systems in the country, the integration of the RTGS system with the RBI's internal accounting

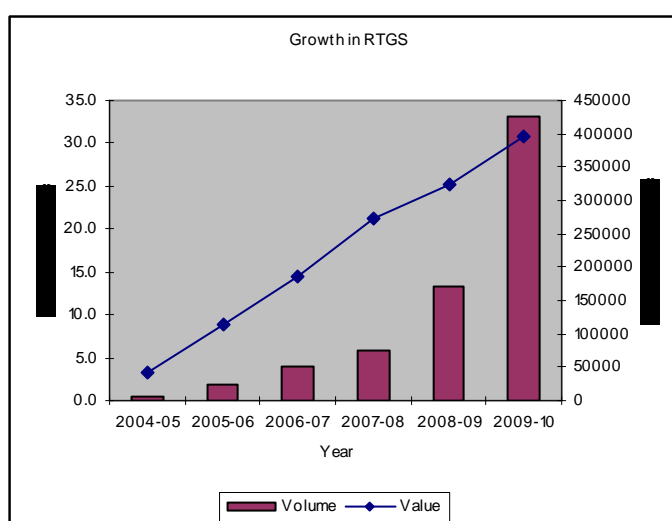
system (IAS) facilitates the movement of funds between the RTGS settlement accounts of members and their current accounts held with the RBI using straight through processing (STP).

### 3.2.8 Pricing

The system's development cost was borne by the RBI. The RBI levies no charge for transaction processing or IDL usage; the RTGS regulations do, however, provide for such charges.

### 3.2.9 Statistics

Since the RTGS system started operations, the volume and value of transactions have increased from 0.5 million transactions with a value of INR 40,661.8 billion in 2004–05 to 33.4 million transactions with a value of INR 394,533.6 billion in 2009–10. A total of 119 banks through more than 68,000 branches provide access to the RTGS service. The rising trend of RTGS utilisation is shown in the graph below.



## 3.3 Exchange and settlement system for foreign exchange transactions

Prior to the establishment of CCIL, transactions in foreign exchange markets were settled bilaterally by trading members through their correspondent banking arrangements. The introduction of the guaranteed settlement facility for USD-INR trades through novation by CCIL with itself as the CCP in 2002 has substantially increased the efficiency of the clearing and settlement of such trades. Foreign exchange transactions that are not settled through CCIL still make use of corresponding banking arrangements.

### 3.3.1 Ownership, governance and regulatory status of CCIL

The ownership structure of CCIL is presented in Section 1.3.2. It acts as a CCP in the settlement of trades in the government securities and foreign exchange markets. Governance is through CCIL's by-laws, regulations and rules. For foreign exchange transactions, the members must adhere to the directives and guidelines issued by the RBI. The Foreign Exchange Dealers Association of India (FEDAI), a self-regulatory organisation, facilitates the framing of market practices and ethics.

The RBI, as the regulator of government securities, foreign exchange and money markets, regulates the clearing and settlement of these instruments by CCIL. Since CCIL provides guaranteed settlement to participants in these markets, the respective regulatory departments within the RBI are in close touch with CCIL concerning its policies and procedures. CCIL also reports all exceptional activities to the RBI.

### 3.3.2 Participants

CCIL admits participants in the foreign exchange market as members to its foreign exchange segment after ensuring that they fulfil certain admission criteria.

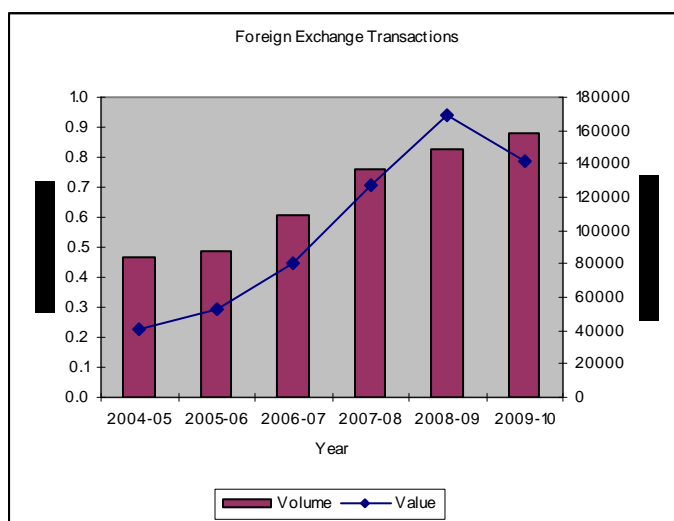
To be eligible, an applicant must:

- be an RBI authorised foreign exchange dealer;
- have a current account with the RBI for settlement of transactions in Indian rupees; and
- have adequate risk management systems in place and employ qualified personnel (for CCIL's risk management see Section 3.3.7).

As of March 2010, there were 75 members in the foreign exchange segment.

### 3.3.3 Transactions handled

CCIL started operations in the foreign exchange segment in November 2002, providing guaranteed settlement for spot<sup>35</sup> and forward INR/USD transactions, by novation to itself as the CCP. This facility was extended to cash and tomorrow-next transactions in February 2004. Since then CCIL's transaction volumes have grown to 1.4 million trades in March 2010, representing a total transaction value of more than INR 387,395.8 billion (on a gross basis without netting).



<sup>35</sup> (i) **Cash trades**: trades where the value date for settlement is the same as the trade date; (ii) **tomorrow-next trades**: trades where the value date for settlement is the next business day from the trade date; (iii) **spot trades**: trades where the value date for settlement is the second business day from the trade date; (iv) **forward trades**: trades where the value date for the settlement falls beyond the spot date.

### **3.3.4 System operating procedure**

CCIL receives trade information through the web-based reporting facility it provides to its members. CCIL has also developed the FX-CLEAR trading platform for its members. When this is used, the trade information is automatically routed to CCIL. Trades reported before the cut-off time (11:30 on T-1 for spot and forward deals, 11:30 on T for cash and tomorrow-next transactions) are matched by CCIL. Unmatched trades are rejected. CCIL verifies the exposures resulting from matched trades vis-à-vis the members' exposure limits (ELs). Members can include trades exceeding ELs under CCIL's guaranteed settlement facility, provided such exposures are fully pre-funded within the designated time. If they are not pre-funded, these trades are excluded from further processing and need to be bilaterally settled by the members outside the CCIL settlement system.

### **3.3.5 Clearing of trades and settlement obligations**

Forward deals are guaranteed for settlement from day T-2, while cash, tomorrow-next and spot deals are guaranteed from the time they are accepted for settlement. CCIL becomes the CCP to every accepted trade by novation. Transactions are processed in batches throughout the day.

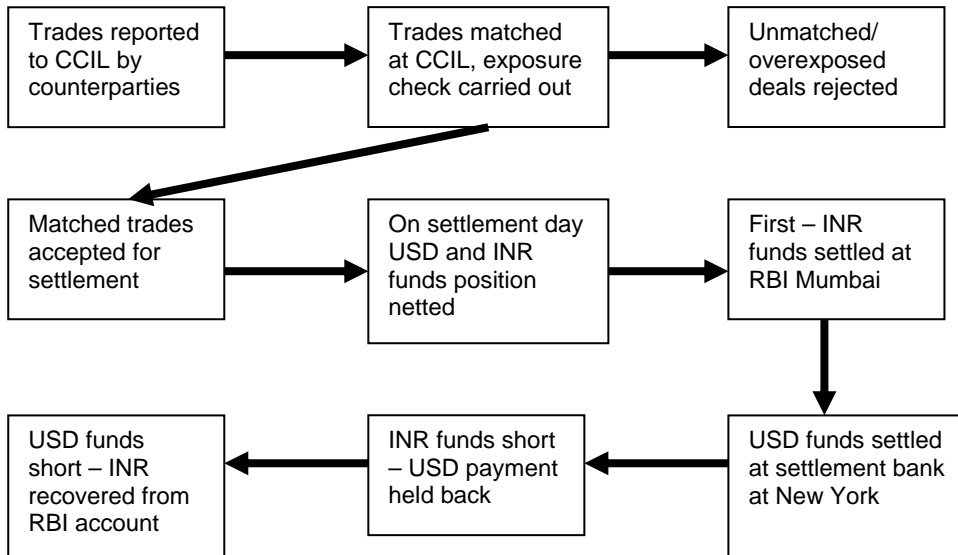
Settlement obligations are calculated separately for each currency, ie USD and INR. Members are advised of their final settlement obligations so that they can make arrangements for funds in each currency.

### **3.3.6 Settlement procedure**

Settlement is not on a PVP basis and is therefore exposed to settlement risk as the INR settlement takes place before the USD settlement. The risk is managed by setting position limits for the members. CCIL collects margins from members to cover market risk exposures for those positions and also for covering credit risk exposures based on a credit scoring model. A loss allocation process, based on notional bilateral net exposures, covers any residual risk.

The settlement of INR obligations takes place in members' accounts with the RBI. The net obligations of members are electronically advised to the RBI in a batch mode and are settled in the RTGS system at the RBI. The amounts to be paid in are first debited from members' current accounts and transferred to the account of CCIL, and the funds are then paid out from CCIL's account to the accounts of the receiving members. To meet any shortfall, CCIL has a rupee line of credit (RLOC) from four banks that hold accounts with the RBI. In case of a funds shortage by members with a net payment obligation, the RLOC is invoked by the RBI (as per CCIL's standing instructions) to complete the settlement. CCIL then withholds the USD payout to the members concerned until they have fulfilled their INR obligations.

The settlement details of the USD leg are sent to CCIL's correspondent bank in New York, through which the USD pay-ins to CCIL's nostro account take place. CCIL also offers a direct debit facility (using a SWIFT MT 300 message) for the USD leg in order to further reduce members' transaction costs. After the members with USD net payment obligation complete their pay-ins, the payouts to members with a USD net credit position take place from CCIL's nostro account. In case of a pay-in default by any member, a USD line of credit with the settlement bank (using the collateral of the settlement guarantee fund (SGF)) enables CCIL to complete the settlement process. Since the USD leg is settled after completion of the INR leg, in case of a USD default by a member, CCIL advises the RBI to debit the member's current account with an equivalent INR amount and to credit it to CCIL's account. This amount is withheld by CCIL until the member has fulfilled its USD obligations. If this does not happen, the INR amount is sold to obtain USD and repay the line of credit. In addition to recovering any additional costs incurred by CCIL, a penalty is levied on members that do not fund their positions in due time.



### 3.3.7 Risk management

Risk management comprises the following measures: (i) a net debit cap for each member; (ii) a member-specific margin factor and collection of margins by way of contribution to the Settlement Guarantee Fund (SGF) in the form of USD/INR funds, cash, securities etc; (iii) member-specific exposure limit based on the balances in the SGF and the margin factor and (iv) a loss allocation mechanism.

The net debit cap (NDC) for each member represents the maximum potential exposure for CCIL for a given settlement date, arising out of the member's failure to honour its commitment. Net debit cap limits for USD/INR trades are denominated in USD. CCIL sets the NDC according to ratings assigned to members on the basis of financial criteria such as net worth and asset quality. NDCs are periodically reviewed and adjusted.

CCIL also sets a margin factor for each member, based on: (i) a credit factor that reflects the ratings assigned to members based on financial criteria such as net worth and asset quality, and (ii) a volatility factor based on value-at-risk for USD/INR exchange rates over a three-day period.

CCIL also requires margins to be posted for trades settled through it. These comprise (i) a mark to market margin against adverse price movements or against trades accepted at off-market prices; (ii) a volatility margin against sudden increases in market volatility, which is applicable to outstanding trades or a member's securities contribution to the SGF.

CCIL also computes and sets an exposure limit for each member based on its SGF balance and margin factor. The exposure limit is the maximum net amount in USD payable by the member, on a given settlement date, for which a member can settle its trades through CCIL. The maximum exposure limit is the net debit cap.

The loss allocation mechanism consists in appropriating the SGF contribution of the defaulting member prior to apportionment of settlement loss as part of the loss allocation procedure. If CCIL is unable to make good the loss through the member's SGF contribution, the shortfall is allocated to the members who were due to receive payment from the defaulting member(s) in proportion to their individual net exposure in the currency of default. Any amounts subsequently recovered from the defaulting member are apportioned among the members who contributed to making good the shortfall.

If more than one member defaults, any shortfall that is allocated among the other members excludes all the trades done by the defaulting members with each other.

The system has a high netting ratio – up to about 98%. As a result, the residual risk exposure of the settlement system to a participant does not normally exceed 2% to 3% of the transaction value.

### **3.3.8 Cross-currency CLS-eligible trades**

CCIL does not offer CCP clearing for CLS-eligible<sup>36</sup> cross-currency trades. Foreign exchange cross-currency trades in CLS-eligible currencies of the authorised dealers are settled by CCIL under an arrangement with its settlement bank, Royal Bank of Scotland (RBS). CCIL uses the third-party services of RBS, and extends services to the participating banks (fourth parties) as a settlement aggregator.

Trade settlement: CCIL arranges settlement of these trades at a netted level through its accounts with its settlement bank, which in turn settles these trades in the CLS settlement system.

As a third party of a CLS Bank settlement member (RBS), CCIL must meet the settlement obligations of the fourth-party settlement participants settling through it, if the trades are not rescinded before a cut-off time. It therefore collects margins from the settlement participants to cover any exposures arising out of a default by a settlement participant or out of an early payout. Margins are based on potential future exposures on trade positions to be settled. To control the exposure, settlement date-wise limits are set. If required, early payout of receivables are allowed against full collateral cover.

In case of a default, the defaulting member must make good the shortfall by a set time on the next day. Margins are kept blocked until then and are appropriated if the defaulting member fails to make good the shortfall before the deadline. Any remaining shortfall is met by the CCIL's Settlement Reserve Fund.

## **3.4 Retail payment systems**

Retail payment systems in India include both paper-based and electronic (NEFT and ECS/NECS/RECS) funds transfer systems. Cards are another popular option for retail payments.

### **3.4.1 Card-based systems**

The settlement of transactions with American Express, Visa and MasterCard cards (for credit cards, debit cards and pre-paid cards) takes place in commercial bank money at the respective settlement banks.<sup>37</sup>

The RBI regulates the banks issuing the cards. Under the Payment and Settlement Systems Act, payment card systems are also subject to regulation by the RBI. Any new initiatives concerning the card system must be vetted by the RBI before implementation.

Card-based payments now account for a substantial share (56% in terms of volume and 13% in terms of value) of electronic retail payment transactions. Initially, debit cards were mainly single-purpose cards (for instance petrol cards or virtual calling cards issued by the telecom

---

<sup>36</sup> CLS (Continuous Linked Settlement) is an international payment system that settles foreign exchange transactions in 17 currencies eliminating settlement risk by means of a PVP mechanism. For details of CLS, please see the corresponding chapter in the forthcoming second volume of this publication.

<sup>37</sup> Bank of America for Visa and Bank of India for MasterCard.



service provider MTNL) and did not involve interbank settlement. Now co-branding is gaining ground.<sup>38</sup>

With the increased usage of credit/debit cards in the country on internet/mobile/interactive voice response (IVR), an additional level of authentication has been mandated by the RBI. This additional authentication/validation will be based on information not visible on the cards for all online “card not present” transactions. Also a system of online alerts<sup>39</sup> to the cardholder for all “card not present” transactions has been mandated.

### **3.4.2 Cheque clearing system**

Payment by cheque is the most popular mode of non-cash payment.

The cheque clearing system was automated with the introduction of MICR technology, initially in the four large cities<sup>40</sup> and subsequently in 62 other cities. With MICR, cheques can be sorted and listed at a centralised location using automated processors, which increases the speed and efficiency of cheque processing. Most of these MICR centres have been set up in the last few years.

More than 83% of the total volume and value of cheques are cleared at MICR processing centres. At these MICR cheque processing centres, banks are required to present to the clearing house before the end of banking hours all the cheques received at their counters or drop boxes for same-day processing. These cheques are processed overnight and reach the paying bank the next morning. The paying bank then accepts the cheque for payment if it is valid and the account of the payer has sufficient funds (value date of clearing or payment); otherwise, it is returned.

Settlement on the accounts of the paying and presenting banks with the settlement bank takes place on the same day. Cheque transactions are settled locally in the current accounts that participants in the system maintain with the bank managing the clearing house. At the 17 centres where the RBI manages the clearing house, settlement takes place in central bank money in participants’ accounts with the RBI. However, the presenting banks are only allowed to utilise the funds obtained after the return clearing (the clearing of returned cheques), which also takes place the same day. Also the presenting banks are normally expected not to permit the presenters of the cheques (the beneficiaries) to use the proceeds until the return clearing is complete.

Clearing house membership includes post office savings banks. In centres with more than one post office savings bank, membership is given to the general or head post office of that centre. The other post office savings banks then present their instruments for clearing through the one designated for this purpose by the general or head post office.

To reduce the clearing time for inter-city cheques, “Speed Clearing”, a new method of clearing inter-city cheques drawn on bank’s “core banking branches”<sup>41</sup> was introduced in June 2008. This is part of the main MICR clearing, in which cheques drawn on core banking branches will be cleared locally irrespective of the branch’s location.

High-value clearing was previously used to clear and settle large-value paper-based payments in major cities. Given the significant risks in paper-based clearing systems,

---

<sup>38</sup> General purpose debit cards are linked to bank accounts. These cards can be used at any POS or ATM. Because ATM/POS infrastructure in India is interoperable, interbank settlement is involved as the merchant and the card holder may hold accounts with different banks.

<sup>39</sup> The customer is sent an SMS message detailing any such transactions.

<sup>40</sup> The four large cities are Chennai, Kolkata, Mumbai and New Delhi.

<sup>41</sup> The branches of banks that are computerised and connected.

especially for large-value instruments, this clearing was discontinued at all centres in March 2010.

### **3.4.3 Electronic Clearing Service (ECS)**

The ECS system is available in 88 cities. Membership in the ECS is automatically extended to all members of the cheque clearing systems, provided ECS is available in that centre. As in the case of cheques, ECS transactions are settled locally in the current accounts maintained with the bank managing the clearing house. The two ECS sub-systems are governed by the Clearing House Regulations and Rules and the Procedural Guidelines for each of the systems. These are enforced by way of contracts between the participating banks and the bank managing the clearing house. Settlement takes place locally in the accounts maintained with the settlement bank. NECS was implemented to fill in the coverage gaps left by ECS; the system covers the whole of India, exploiting the IT infrastructure of member banks.

#### *ECS Credit*

ECS Credit is used for the payment of salaries, pensions, dividends, interest etc. Payers submit credit instructions through their banks (sponsor banks). On the settlement date, the account of each sponsor bank is debited and the accounts of beneficiary banks are credited. Credit instructions are sent to the beneficiary banks in advance so that instructions can be returned if, for any reason, the beneficiary bank is unable to credit the recipient customer's account.

Settlement for ECS is on T+1 basis. The entity making the payment submits the payment instruction through its sponsor bank. On day T the instructions are processed at the clearing house and passed on to the beneficiary bank. If the beneficiary bank cannot credit the customer for any reason, the instructions must be returned. A separate return clearing is held and final settlement is completed on T+1. Settlement takes place in the books of accounts of the settlement bank.

The volume of ECS transactions increased from 88.4 million during the year to March 2009 to 98.1 million transactions during the year to March 2010, and from INR 974.9 billion to INR 1,176.1 billion respectively in terms of value.

#### *National Electronic Clearing Service (NECS)*

NECS was implemented in September 2008 to fill the gaps in ECS coverage. NECS (Credit) facilitates multiple credits to beneficiary accounts in destination branches across the country, against a single debit of the account of a user at the sponsor bank. The system covers the whole country, making use of the core banking solutions (CBS) of member banks. This enables all CBS bank branches to participate in the system, irrespective of their location.

In the new set-up, users prepare a single consolidated NECS file and submit it to the central clearing house in Mumbai through their sponsor banks. The files can be uploaded by sponsor banks until the cut-off time one day prior to the settlement day, thus reducing processing time. Settlement is postponed to the next working day for files uploaded after the cut-off time. Returns are also processed on the settlement day itself and thus on the third day users know the status of their transactions.

#### *ECS Debit*

This system is used for multiple debits culminating in a single credit. A utility company gives the debit instructions (based on mandates given by its customers) to the sponsor bank, which in turn presents them to the clearing house for further processing. On the settlement date, the customers' accounts are debited and the sponsor banks' accounts are credited.

The clearing and settlement procedure is the same as in ECS (Credit).

ECS Debit transactions declined from 160.0 million transactions during the year to March 2009 to 149.3 million transactions during the year to March 2010. However, the value increased from INR 669.8 billion to INR 695.2 billion during this period.

### **3.4.4 Electronic Funds Transfer system**

The Electronic Funds Transfer (EFT) system implemented in the mid 1990s and the National EFT (NEFT) implemented in November 2005 are deferred net settlement (DNS) systems that process credit transfers. With the implementation of NEFT, the EFT system has been discontinued. In the NEFT system, settlement takes place at regular intervals during the day, with 11 hourly settlements on weekdays and five on Saturdays. Final settlement of NEFT batches occurs in the RTGS system.

#### *NEFT*

The NEFT system uses the Structured Financial Messaging Solution (SFMS) for EFT message creation and transmission from a branch to the bank's gateway and to the NEFT centre, using the tools available from the SFMS. By using PKI, NEFT considerably enhances the security of funds transfer operations. NEFT is available across the country and is not centre-specific. Bank branches that are computerised and capable of handling electronic transactions are linked to NEFT.

Participants must be banks and members of the RTGS system; they must have SFMS installed; and they must comply with other conditions prescribed by the RBI. All or any of these conditions may be relaxed or waived at the RBI's discretion.

The volume of transactions has increased from 32.2 million during the year to March 2009 to 66.3 million during the year to 2010, and from INR 2,519.6 billion to INR 4,095.1 billion respectively in value terms.

### **3.4.5 Ongoing and future projects**

#### *3.4.5.1 Cheque truncation*

The Cheque Truncation System (CTS) was implemented as a pilot project in the National Capital Region (Delhi) in February 2008 with a view to increasing the efficiency of paper-based processing. With the CTS, paper instruments will no longer need to be physically presented to the clearing house. Banks can decide whether to truncate the cheque at the branch level, the central level (service branch) or the gateway (overall bank) level. Clearing and settlement cycles are the same as for MICR clearing: ie T+1, with the exception of the processing cycles and the return clearing cycle, which are advanced by 4–5 hours). The scope for straight through processing and automated payment processing reduces costs, as well as the incidence of reconciliation problems and clearing fraud. Banks can also offer new products and services based on the CTS. The roll-out of the project to other centres (starting with Chennai) is under way.

#### *3.4.5.2 Centralised Funds Management System (CFMS)*

The CFMS consists of two components: the Centralised Funds Enquiry System (CFES) and the Centralised Funds Transfer System (CFTS). The CFES enables RBI account holders to view their balance and transaction details at any time. The CFTS enables banks with current accounts with different offices of the RBI to transfer funds from their own account in one RBI office to their own account in another. All 17 RBI offices have introduced the system. Seventy-six banks use the system to make funds transfers. The system has helped treasury managers centralise and improve their cash management; they can now electronically move funds from surplus centres to deficit centres.

## 4. Systems for post-trade processing clearing and securities settlement

### 4.1 General overview

The regulatory framework for the securities market, assigned to the RBI under the RBI Act is described in Section 1.1.2. The issue, servicing and repayment of government securities by the RBI is governed by the Government Securities Act, 2006 and the Government Securities Regulations, 2007. The OTC trades of government securities reported over the NDS are accepted for clearing by CCIL. The NDS-OM (NDS-GILTS-Order Matching) is an anonymous electronic order-matching trade system that matches all orders by strict price/time or yield/time priority. Members also have the option of using the Clearcorp Repo Order Matching System (CROMS) an anonymous order matching platform launched by Clearcorp Dealing Systems (India) Ltd, a wholly owned subsidiary of CCIL. The executed trades then flow to CCIL which acts as the CCP for government securities trades. The final settlement of securities takes place in the Public Debt Office (CSD) of the RBI.

SEBI regulates the securities market through powers conferred to it by the Securities and Exchange Board of India Act, 1992 and the Securities Contract Regulations Act, 1956 (SCRA) and through powers delegated to it by the central government under the SCRA. The BSE and NSE, the two major stock exchanges, account for the vast majority of equity transactions in the country. Both the BSE and NSE have their own trading platforms.

The BSE's electronic trading platform for equities is known as BOLT, for BSE On-line Trading. BOI Shareholding Limited (BOISL) is the BSE's clearing house, clearing and settling funds and securities on its behalf. The Indian Clearing Corporation Limited (ICCL) also functions as a clearing corporation for the BSE. At present, it undertakes clearing and settlement for the BSE's mutual funds and corporate debt segments.

The NSE's electronic trading platform is known as the National Exchange for Automated Trading (NEAT). National Securities Clearing Corporation Ltd. (NSCCL) is the clearing corporation for NSE and carries out the clearing and settlement of trades executed in the equities and derivatives segments of the NSE.

BOISL and NSCCL effect the securities pay-ins and payouts through two depositories,<sup>42</sup> the National Securities Depository Ltd (NSDL) and Central Depository Services Ltd (CDSL). Funds settlement takes place in designated settlement banks. In the case of corporate bonds, ICCL and NSCCL effect the funds settlement in the RTGS and the securities settlement in the two depositories.

---

<sup>42</sup> NSDL is promoted by NSE and CDSL is promoted by BSE, with major banks as the shareholders in both the depositories.

Details of trading, post-trade clearing and settlement

Markets	Asset class	Trading platforms	Clearing	Settlement	
				Securities / currency	Funds
Primary market (Auction bids)	Government securities	NDS	Bids flow directly to the RBI	SSS (PDO, RBI)	RTGS (RBI)
		NDS / NDS-OM / CROMS	CCIL		
Secondary market (OTC and order matching)					
Collateralised borrowing and lending obligation	Money market instrument	CBLO dealing system	CCIL	CCIL	
USD-INR	Currency	FX-Clear	CCIL	USD settlement through CCIL's correspondent bank in New York	
Stock market	Equities	NEAT / BOLT	NSCCL / BOISCL	NSDL / CSDL	Settlement banks
	Corporate bonds	NEAT / BOLT	NSCCL / ICCL		RTGS (RBI)

- Classification
- Different asset classes
- Different trading platforms corresponding to the various asset classes
- Clearing done by clearing corporations of the stock exchange and securities settlement done by securities depositories
- Funds settlement in commercial bank money
- Different markets
- Clearing, settlement at the central bank (RBI)
- Clearing, settlement at CCIL
- USD settlement through CCIL's correspondent bank in New York

## 4.2 Post-trade processing systems

### 4.2.1 Government securities

#### 4.2.1.1 Institutional framework

The NDS and NDS-OM are owned by the RBI, with NDS being operated by the RBI. NDS-OM is operated by CCIL under a specific agreement with RBI. The OTC trades reported over the NDS are accepted for clearing by CCIL which acts as the CCP for government securities trades that are finally settled in the SSS. NDS-OM is an anonymous order-driven system. Trades executed on NDS-OM flow directly to CCIL which becomes the CCP to each trade done on the system. The system is overseen by the RBI.

#### 4.2.1.2 Participation

The system has 162 participants, comprising banks, primary dealers and other financial institutions. CCIL and RBI are also participants. Participants must be members of INFINET and be eligible to open an SGL and/or CSG account with the RBI for securities settlement.

#### 4.2.1.3 Transactions handled

On the NDS platform, market participants can trade and report outright and repo transactions in government securities and treasury bills, as well as dated securities issued by state governments. Market participants who are allowed to open gilt custodian accounts for their customers are also allowed to put through the deals of these customers.

#### 4.2.1.4 System operating procedures

The system operates from 09:00 to 17:00 on weekdays for outright and repo trades and on Saturdays from 09:00 to 14:00 exclusively for repo transactions in government securities. All outright transactions in government securities have a standard (T+1) settlement cycle. For repo transactions, settlement can be on either a T+0 or T+1 basis.

#### 4.2.1.5 Pricing

CCIL has prescribed transaction charges for trades in government securities (see Section 4.3.1.7).

## 4.2.2 Collateralised Borrowing and Lending Obligation (CBLO)

### 4.2.2.1 Institutional framework

CCIL as a central counterparty offers a money market product approved by RBI known as the Collateralised Borrowing and Lending Obligation (CBLO). The CBLO combines a tradable repo and tripartite repo. Unlike a normal repo transaction, a CBLO is tradable. It is a discounted instrument backed by gilts as collateral. Lenders of funds buy CBLOs. CBLO balances are maintained in electronic book entry. CBLOs can be traded anonymously in the market through a trading system known as the CBLO Dealing system.<sup>43</sup>

---

<sup>43</sup> The CBLO Dealing system is made available by CCIL through its wholly owned subsidiary Clearcorp Dealing Systems (India) Ltd (CDSIL). The Clearcorp Dealing Systems (India) Ltd (CDSIL) owns and manages various trading solutions such as FX-CLEAR (a forex dealing system) and CROMS (Clearcorp Repo Order Matching System; an anonymous order matching platform for dealing in market repos in government securities).

#### **4.2.2.2 Participation**

Membership of the CBLO segment is granted to NDS members and non NDS members. The entities eligible for CBLO membership are nationalised banks, private banks, foreign banks, cooperative banks, financial institutions, insurance companies, mutual funds, primary dealers, non-banking financial companies (NBFCs), corporates, provident/pension funds etc.

#### **4.2.2.3 Transactions handled**

CCIL offers guaranteed settlement of transactions in CBLOs, both at trade level and at redemption level on maturity. The market is mostly concentrated in overnight CBLOs.

#### **4.2.2.4 System operating procedures**

CBLOs can be settled either on a T+0 basis or on a T+1 basis. System operating hours are based on the settlement schedule and on whether the trades are settled directly with RBI or with settlement banks. Where the trades are settled through settlement banks, the system operating hours are shorter. For details of the system operating hours, see Section 4.3.2.4.

#### **4.2.2.5 Pricing**

CCIL has prescribed transaction charges for trades in CBLO (see Section. 4.3.2.7).

### **4.2.3 Interest rate swaps**

A trade warehouse for the rupee-denominated interest rate swap market was set up in 2007 using the services of CCIL. All market-makers (ie banks and PDs) are required to report their trades within 30 minutes to the trade warehouse where the trades are matched. Trade matching is not accepted as a trade confirmation. Market participants are required to exchange physical confirmation for each trade. The trade warehouse offers full post-trade processing for the trades in the warehouse. Settlement of daily obligations relating to these trades is also offered by CCIL without any settlement guarantee. Funds settlement occurs in the accounts of the participating institutions with RBI. A portfolio compression model developed by CCIL has been launched.

### **4.2.4 Exchange-traded securities and derivatives**

#### **4.2.4.1 The National Stock Exchange (NSE)**

##### **4.2.4.1.1 Institutional framework**

The NSE was set up in November 1992 as a for-profit company under the Companies Act, 1956, and is owned by shareholders, who are financial institutions. The NSE is a listed company. The NSE was recognised as a stock exchange by the SEBI in April 1993. The NSE was the first stock exchange in the country to offer a nationwide order-driven, screen-based trading system.

National Securities Clearing Corporation Ltd (NSCCL), a wholly owned subsidiary of NSE, was set up in August 1995. It was the first clearing corporation in the country to provide a novation/settlement guarantee system in India. It started clearing operations in April 1996. NSCCL clears and settles trades executed in the equities and derivatives segments of the NSE. NSCCL has a panel of 13 clearing banks. Every clearing member is required to maintain and operate clearing accounts with any of the clearing banks in the panel at the designated clearing bank branches. The clearing corporation, NSCCL, is governed by the

regulations for clearing corporations.<sup>44</sup> Securities pay-in and payout is effected through the two depositories NSDL and CDSL.

#### *4.2.4.1.2 Participation*

Membership of the NSE/NSCCL is open to corporate entities, individuals and partnerships who fulfil the eligibility criteria laid down by SEBI and NSE. Trading/clearing members/clients are governed by the respective regulations.<sup>45</sup> All trading members in the cash market segment are also clearing members of NSCCL. The custodian clearing members are also members of the NSCCL panel that carries out clearing and settlement of transactions on behalf of their clients.

#### *4.2.4.1.3 Transactions handled*

The trading system at NSE provides a fully automated, screen-based trading for equities and derivatives products. It supports an anonymous order-driven market, which operates on a strict price/time priority basis.

#### *4.2.4.1.4 System operating procedures*

The market operates from 09:00 to 15:30 five days a week.

In the cash market segment all trades executed on NSE are electronically transferred to NSCCL after trading hours on the T day itself for clearing and settlement and are settled on a T+2 basis.

In the derivatives segment, the open positions of clearing members (CMs) are arrived at by aggregating the open positions of all trading members (TMs) and all other participants clearing through CM, in the contracts which they have traded. The open position of a TM is calculated by aggregating its proprietary open positions and those of clients for all traded contracts. Proprietary positions are calculated on a net basis for each contract and clients' positions are the sum of the net positions of each individual client. All transactions are cash-settled and there is no physical settlement.

#### *4.2.4.1.5 Pricing*

NSE has prescribed transaction charges for trades in various segments.

### *4.2.4.2 The Bombay Stock Exchange (BSE)*

#### *4.2.4.2.1 Institutional framework*

The BSE is the oldest stock exchange in Asia. Established in 1875, it was the first stock exchange in the country to be recognised under the Securities Contracts Regulation Act. In August 2005, the exchange changed its legal status from an Association of Persons into a corporate entity, with its name changing from "The Stock Exchange, Mumbai" to "Bombay Stock Exchange". Trading on the BSE in equity, debt and derivatives is entirely screen-based.

BOI Shareholding Limited (BOISL) is the BSE's clearing house, clearing and settling funds and securities on the BSE's behalf. The Indian Clearing Corporation Limited (ICCL), a wholly owned subsidiary of the BSE, functions as a clearing corporation for the BSE's mutual funds and corporate debt segments. The BSE has appointed certain banks as clearing banks

---

<sup>44</sup> NSCCL's operations are governed by the provisions of the Companies Act, SEBI Act, Securities Contract Regulation Act, Depositories Act, Income Tax Act etc, and any rules, regulations notifications, circulars and directives issued under this legislation.

<sup>45</sup> NSCCL has defined rules, regulations and by-laws for its members, which govern the relation between the Clearing Corporation and its members and deal with various operational issues.



through which the funds pay-in and payout are effected. Participants (ie member brokers and custodians) select one of these clearing banks through which to clear their funds obligations. Securities pay-in and payout is effected through the two depositories, NSDL and CDSL.

#### *4.2.4.2.2 Participation*

Individuals, companies established under Companies Act, 1956, and financial institutions that fulfil the eligibility criteria can become trading members of BSE.

#### *4.2.4.2.3 Transactions handled*

The BSE's electronic trading platform for equity, debt and derivatives is BSE On-line Trading (BOLT).

#### *4.2.4.2.4 System operating procedures*

The market operates from 09:00 to 15:30 five days a week.

All equity segment and fixed income securities listed on BSE are settled on a T+2 basis.

#### *4.2.4.2.5 Pricing*

BSE has prescribed transaction charges for trades in various segments.

#### *4.2.4.3 BOI Shareholding Limited (BOISL)*

The post-trade settlement system includes exchange, clearing corporation, clearing house, member brokers, depositories and public and private sector clearing banks as participants. The clearing and securities settlement in the equity cash segment takes place on a T+2 basis.

##### *4.2.4.3.1 Institutional framework*

BOI Shareholding Ltd. (BOISL) was established in 1989 as a joint venture company by Bank of India (BOI) and BSE. BOISL is an independent clearing house of the BSE. BOISL clears and settles funds and securities on behalf of BSE.

##### *4.2.4.3.2 Participation*

Information on participation is provided in Section 4.2.4.2.2.

##### *4.2.4.3.3 Types of transaction*

BOISL is the clearing house for trades carried out on the BOLT platform in the equity, debt market and derivative segments.

##### *4.2.4.3.4 Operations of the system and settlement procedures*

Trades executed on BOLT are netted at the BSE and a consolidated file is uploaded to BOISL on T+1. The file contains details of the funds and securities obligations of each clearing member for the respective settlement. For the fund settlement, the exchange uploads a file with the net obligations of clearing members to BOISL on T+1. After processing this file, BOISL uploads these files to the clearing banks where clearing members maintain their designated settlement accounts, also on T+1. Clearing banks must confirm pay-in by clearing members by 11:00 on T+2 to BOISL. At present, 16 banks act as clearing banks to the exchange.

Members can effect pay-in of dematerialised securities to the clearing house through either of the depositories, ie the NSDL or the CDSL. Members are required to give instructions to their respective depository participants (DPs) with details of settlement number, effective pay-in date, quantity etc.

### 4.3 Central counterparties and clearing systems

**Clearing Corporation of India Ltd. (CCIL):** The role of CCIL as a CCP in the government securities, CBLO and USD-INR segment is detailed in the following sections.

#### 4.3.1 Government securities

CCIL<sup>46</sup> acts as a central counterparty and guarantees settlement for government securities. For this purpose, the members of NDS and NDS-OM must become members of the government securities segment of CCIL. There is a direct interface between both systems, to facilitate straight through processing of transactions.

##### 4.3.1.1 Institutional framework

The institutional framework under which CCIL, the CCP, is governed is detailed in Sections 1.3.2 and 4.2.1.1.

##### 4.3.1.2 Participation

Information on participation in this segment can be found in Section 4.2.1.2.

##### 4.3.1.3 Types of transaction

CCIL acts as CCP for secondary trades relating to government securities and provides a guaranteed settlement on a DVP3 basis. Market participants can trade and report outright and repo transactions in government securities and treasury bills, as well as dated securities issued by state governments. Market participants who are allowed to open gilt custodian accounts for their customers are also allowed to put through the deals of these customers.

##### 4.3.1.4 Operations of the system and settlement procedures

For this purpose, NDS and NDS-OM members must become members of the government securities segment of CCIL. There is a direct interface between NDS, NDS-OM, CROMS and CCIL to facilitate straight through transaction processing. Trades that pass the exposure check are accepted for guaranteed settlement and are novated. Consequently, CCIL becomes the buyer to the seller of a trade and the seller to the buyer. CCIL then calculates the net obligations of each member for funds and securities. Members are then advised of their final obligations and the settlement details are sent to the RBI for further processing. Securities and funds settlement take place on a DVP3 basis at the end of the day.

##### 4.3.1.5 Risk management

**Margin:** When trades are accepted, CCIL collects margins to cover potential future exposures. Mark to market margins are then collected on an intraday or end of the day basis, to cover any loss in value of these trades. A volatility margin is also collected if high volatility is seen in the market. Margins are collected in the form of cash and/or government securities. Appropriate haircuts are applied on securities placed as margins and these are revalued daily at the end of the day. When necessary, CCIL makes additional margin calls on the members to ensure that it has enough collateral to provide the settlement guarantee.

**Default procedure:** As settlement is on a DVP basis, the first line of defence against a default is to withhold the delivery of funds or securities. The defaulter is allowed to make good the shortfall by a set time on the next day. If the defaulter fails to do so, the withheld funds or securities are appropriated to meet the shortfall. The margin payments are then applied to

---

<sup>46</sup> For institutional details please see the beginning of Section 4.2.1.1.

meet any residual loss. If there is still a residual loss, the CCIL's Settlement Reserve Fund is used to meet it.

*Liquidity risk:* Liquidity risk is managed through lines of credit from commercial banks and securities lines of credit from commercial banks and financial institutions.

#### 4.3.1.6 *Links to other systems*

The clearing system of CCIL is linked to NDS, NDS-OM, and CROMS. CCIL is linked to the RTGS system for settlement of funds and to the securities settlement system at RBI (CSD for government securities) for securities settlement. These systems are also used for collateral collection and margins.

#### 4.3.1.7 *Pricing*

The transaction charges, penalty for margin shortfall, charges payable by the defaulting member when the trade is settled by CCIL or when the trade is allocated to CCIL are published on the website of CCIL.<sup>47</sup>

### **4.3.2 Collateralised Borrowing and Lending Obligations (CBLO)**

#### 4.3.2.1 *Institutional framework*

The institutional framework under which CCIL, the CCP, is governed is detailed in Sections 1.3.2 and 4.2.2.1.

#### 4.3.2.2 *Participation*

The participation in this segment is detailed in Section 4.2.2.2.

#### 4.3.2.3 *Types of transaction*

The types of transaction in this segment are detailed in Section 4.2.2.3.

#### 4.3.2.4 *Operations of the system and settlement procedures*

CBLO dealing takes place in the auction market and the normal market. The auction market is available only to NDS members with a settlement account at RBI for overnight borrowing and settlement on T+0 basis. Access to the auction market is not available to associate members. Based on the borrowing limits fixed by CCIL, members submit their borrowing requests through the CBLO dealing system indicating the amount, maturity and the cap rate before the start of the auction session. Members are permitted to borrow and lend funds on overnight basis indicating the cap rate(s)<sup>48</sup> which is linked to CCBOR.<sup>49</sup>

The CBLO normal market is available to both CBLO (NDS) members and associate members. CBLO (NDS) members access the market via INFINET and associate members access it via internet. Members deposit cash and/ or eligible securities prior to starting CBLO dealing operations. Limits are made available to members based on the cash or eligible securities deposited with CCIL for that purpose in the CBLO segment. CBLO members can place borrowing or lending orders until the end of market hours for either T+0 settlement or T+1 settlement.

---

<sup>47</sup> <http://www.ccilindia.com/>.

<sup>48</sup> A cap rate is the maximum rate which the borrower is willing to pay.

<sup>49</sup> CCBOR stands for CCIL Collateralised Benchmark Offer Rate.

Trades received from the CBLO dealing system are novated and netted for settlement. A single obligation is generated for each member for each settlement date by netting trades received for settlement on that business date with the redemption obligation for the same date. For members who are not eligible for a current account at RBI, the funds settlement takes place at a designated settlement bank. The final interbank settlement obligations (including the settlement bank obligations) are settled in central bank money at the RBI. Securities of equivalent value are blocked for members against their borrowing limits.

CBLO credits in the form of book entry are given to those members who have lent funds after the CBLO funds settlement is completed. The CBLO holdings are maintained with CCIL. The CBLO leg is therefore settled in the books of CCIL. The settlements are carried out on a DVP3 basis. A report gives details of securities encumbered in the CBLO segment.

#### 4.3.2.5 Risk management

*Margins:* CCIL collects margins to cover potential future exposures on trades. Collateral in the form of government securities is also collected from the sellers of CBLOs, who effectively borrow funds from the buyers of the CBLOs. Appropriate haircuts are applied on securities placed as collateral for margin purposes and these are revalued daily at the end of the day. Settlement is on a DVP3 basis, with the settlement of CBLOs occurring in the books of CCIL and final interbank funds settlement at the RBI.

*Default procedure:* As settlement is on a DVP basis, the first line of defence against a default is to withhold the delivery of funds or CBLOs. In case of a default on the redemption proceeds of CBLO on maturity, the collateral collected in the form of margins is also blocked. The defaulter is allowed to make good the shortfall by a set time on the next day. If the defaulter fails to do so,<sup>50</sup> the withheld funds or CBLOs or collateral are appropriated to meet the shortfall. The accumulated margin payments are then applied to meet any residual loss. If there is still a shortfall, the CCIL's Settlement Reserve Fund is used to meet it.

*Liquidity risk:* Liquidity risk is managed through lines of credit from commercial banks.

#### 4.3.2.6 Links to other systems

The CBLO dealing system is hosted and maintained by Clearcorp Dealing Systems (India) Ltd. NDS members access the CBLO dealing system via INFINET and non-NDS members via the internet. CCIL is linked to RTGS for funds settlement for members who maintain a current account in RBI (and are allowed to operate that current account for settlement of their secondary market transactions) and to settlement banks in respect of other members. CCIL is linked to the CSD (RBI for government securities) for collateral and margin collections.

#### 4.3.2.7 Pricing

Transaction charges, settlement charges, and default charges, including delayed deposit of margin charged by CCIL, are published on the CCIL website.<sup>51</sup>

---

<sup>50</sup> The deadline for this process is stipulated in the segment's regulations. CCIL communicates any changes by means of a notification to the members.

<sup>51</sup> <http://www.ccilindia.com/>.

### **4.3.3 Foreign exchange settlement**

#### *4.3.3.1 Institutional framework*

The institutional framework under which CCIL, the CCP, is governed is detailed in Sections 1.3.2 and 3.3.1.

#### *4.3.3.2 Participation*

The participation in this segment is detailed in Section 3.3.2.

#### *4.3.3.3 Types of transaction*

The types of transaction in this segment is detailed in Section 3.3.3. CCIL provides guaranteed settlement for all interbank cash, tom, spot and forward USD-INR transactions.

#### *4.3.3.4 Operation of the system and settlement procedures*

The system operating and settlement procedures are described in Sections 3.3.4, 3.3.5 and 3.3.6.

#### *4.3.3.5 Risk management*

Risk management is outlined in Section 3.3.7.

#### *4.3.3.6 Links to other systems*

CCIL receives trade information through a web-based reporting facility in addition to its FX-CLEAR trading platform. The settlement of INR obligations takes place in members' accounts with the RBI. The settlement details of the USD leg are sent to CCIL's correspondent bank in New York, through which the USD pay-ins to CCIL's nostro account take place.

#### *4.3.3.7 Pricing*

The schedule of fees and charges for settlement of trades, transaction charges and system usage charges and penalties for default charged by CCIL are published on CCIL's website.

### **4.3.4 National Securities Clearing Corporation Ltd. (NSCCL) and Indian Clearing Corporation Limited (ICCL)**

The role of NSCCL as a CCP for trades executed on the NSE and the corporate bond segment and the role of ICCL as a CCP for the BSE's corporate bond segment are detailed in the following sections.

#### *4.3.4.1 National Securities Clearing Corporation Ltd. (NSCCL)*

##### *4.3.4.1.1 Institutional framework*

The institutional framework under which NSCCL, the CCP, is governed is detailed in Section 4.2.3.2.

##### *4.3.4.1.2 Participation*

Cash market segment: All trading members in the cash market segment are also clearing members of NSCCL. Custodian clearing members are also authorised by the NSCCL to carry out clearing and settlement of transactions for their clients.

Derivatives segment: Clearing members can be self clearing members (SCM); trading member-cum-clearing members (TMCM); or professional clearing members (PCM).

Corporate bonds: To settle trades in corporate bonds through NSCCL, participants must register with NSCCL. Entities carrying out settlement on behalf of participants are also registered as participants.

#### 4.3.4.1.3 Types of transaction

Cash market segment: The cash market segment comprises equities, government securities, warrants and exchange traded funds that are cleared and settled by NSCCL.

Derivatives segment: NSCCL clears and settles index futures, index options, stock futures, stock options, currency futures and currency options and interest rate futures.

Corporate bonds: Only corporate bonds.

#### 4.3.4.1.4 Operation of the system

The market operates from 09:00 to 15:30, five days a week.

Cash market segment: All trades executed on NSE are electronically transferred to NSCCL after trading hours on T+0 for clearing and settlement and are settled on a T+2 basis in the cash market segment. NSCCL, the CCP, becomes the counterparty to the net settlement obligations of every member by novation and is obligated to meet all settlement obligations, regardless of member defaults. The NSCCL is the central counterparty to all trades and nets positions so that members have a net obligation to receive or deliver securities and must either pay or receive funds.

Trading members execute transactions on behalf of clients or on a proprietary basis. Settlement obligations are netted at the clearing member level. NSCCL carries out clearing and settlement functions according to the settlement cycles of different sub-segments in the cash market segment.

Derivatives segment: NSCCL becomes the counterparty for all trades in NSE futures and options contracts. Financial obligations are assumed by the NSCCL in the event of any party failing to meet the settlement obligations. Clearing members are responsible to NSCCL for the obligations arising from their own trades, their clients' trades and the trades of trading members for whom they provide a clearing service.

Futures contracts are subject to two types of settlements; the daily mark to market settlement, which occurs on a continuous basis at the end of each day, and the final settlement, which occurs on the last trading day of the futures contract. Settlement of options contracts include the daily premium settlement for options purchased and sold during the day and the final exercise settlement for options positions at in-the-money strike prices on the expiration day.

Corporate bonds: Corporate bond trades are settled between Monday to Friday on three settlement cycles, ie T+0, T+1 and T+2, with different cut-off timings.

#### 4.3.4.1.5 Risk management

NSCCL's risk management system monitors the track-record and performance of members and their net worth; undertakes on-line monitoring of members' positions and market exposure, collects margins from members and automatically suspends members if the limits are breached.

Risk management measures for the cash market segment comprise the following:

- capital adequacy requirements;
- margin requirements include the daily mark to market margin (MTM margin), value at risk-based margin (VaR-based margin) and extreme loss margins (ELM margin). VaR and ELM margins are calculated at client level and collected in advance, whereas the MTM margin is computed and collected at the end of the day.

- an online system monitors the margins of the members in real time. Alerts warn both the member and NSCCL at pre-set levels when a member approaches its allowable capital.

Risk management measures for the derivatives segment: NSCCL monitors margins in real time by means of an online portfolio-based margining and monitoring system. The risk containment measures comprise:

- capital adequacy controls.
- margining and position monitoring is accomplished using an online tool, SPAN (Standard Portfolio Analysis of Risk),<sup>52</sup> to determine the largest loss that a portfolio might reasonably be expected to incur from one day to the next day.
- margins are monitored on a real-time basis. Members are alerted of their positions to enable them to control their positions and margins or bring in additional capital. If deposits are insufficient to cover the margins, the member's trading facility is automatically withdrawn. In addition, various position limits are also set.

#### Default procedures for the cash and derivatives segments

In the case of funds and securities pay-in defaults, NSCCL initiates a buy-in on T+3 on behalf of clearing members who have failed to make the securities pay-in by the scheduled time on T+2. The buy-in takes place in a separate auction market session on T+3 on the trading system of NSE. The settlement for transactions in the auction session takes place on T+4, when all unsuccessful or unsettled auctions are closed out. Clearing members failing to honour funds pay-in obligations by the cut-off time are suspended from trading if such shortages are above a prescribed value.

#### Utilisation in case of default

If a clearing member is declared to be in default, NSCCL applies the members' funds and the settlement fund in the following order:

- margin or any other payment of the defaulting member retained by NSCCL for the purpose of clearing and settlement;
- the member's contribution to the settlement fund, whether in the form of cash or securities or bank guarantee;
- the member's security deposit and the proceeds recovered from auctioning or transferring the membership;
- fines, penalties, interest etc earned from investment or disinvestment of the settlement fund, retained earnings of NSCCL and profits available for appropriation;
- contribution of all clearing members to the settlement fund in proportion to the total contribution and deposit made by each clearing member;
- additional contribution called from clearing members in proportion to their contribution to the settlement fund.

Corporate bonds: Trades are settled at participant level on a DVP1 basis, ie on a gross basis for securities and funds. If either of the participants/custodians fail to honour their pay-in obligation by the set time, the transaction is cancelled. The securities or funds received towards the pay-in obligation are returned to the respective participants/custodians.

---

<sup>52</sup> SPAN (Standard Portfolio Analysis of Risk) is licensed from the Chicago Mercantile Exchange. SPAN is used to determine margin requirements.

#### 4.3.4.1.6 Links to other systems

NSCCL clears and settles the trades executed in the equities and derivatives segments over the NSE's trading platform NEAT. NSCCL effects the securities pay-in and payout through the two depositories NSDL and CDSL. The funds settlement takes place in designated settlement banks. In the case of corporate bonds, NSCCL effects the funds settlement in the RTGS and the securities settlement in the two depositories.

#### 4.3.4.2 Indian Clearing Corporation Limited (ICCL):

The functions of ICCL are described below mainly with reference to its role as a CCP in the currency derivatives segment.

##### 4.3.4.2.1 Institutional framework

The institutional framework under which ICCL, the CCP, is governed is detailed in Section 4.2.4.2.1.

##### 4.3.4.2.2 Participation

Participants: ICCL's clearing members can be either (i) trading-cum-clearing members (TCMs), who can trade, clear and settle their own or client trades, as well as clear and settle trades of its associate trading members; or (ii) professional clearing members (PCMs), a member without trading rights. A PCM can clear and settle the trades only of its associate trading members and clients.

##### 4.3.4.2.3 Types of transaction

ICCL undertakes clearing and settlement services for the mutual funds segment and corporate debt segment and the currency derivatives segment of the United Stock Exchange of India Limited (USE) as well of the BSE.

##### 4.3.4.2.4 Operation of the system

The clearing and settlement process in the currency derivatives segment is given below:

Process	
Daily mark to market settlement.	The daily mark-to-market is settled in cash on T+1.
Settlement mechanism	Cash-settled in Indian rupees.
Settlement price	The settlement price is the RBI reference rate on the date of expiry.
Last trading day	The near-month contract is discontinued for trading two days prior to the expiry day (assuming both the days are trading days).
Final settlement day	The final settlement day is the contract expiry date which is generally T+2 from the last trading day of the contract.

ICCL has appointed nine commercial banks as clearing banks to settle the funds obligations of clearing members. A clearing member must open a settlement account with any of the designated clearing banks for this purpose.

##### 4.3.4.2.5 Risk management

ICCL has a risk management framework that includes the collection of various types of margins, collateral etc for the currency derivatives segment.



Margin: margins for the currency derivatives segment comprise:

- initial margin to cover a 99% VaR over a one-day horizon. The initial margin is subject to a minimum of 1.75% on the first day of currency futures trading and 1% thereafter. The initial margin is deducted in advance from the available liquid assets deposited by the clearing member with ICCL;
- extreme loss margin on the mark to market value of the gross open positions is deducted in advance from the available liquid assets of the clearing member; and
- such additional margins which ICCL may require clearing members to pay.

The margins are computed at a client level and collected or adjusted in advance from the liquid assets of the clearing members. Client margins are collected and reported to ICCL by the members.

Collateral requirements for ICCL clearing members comprise:

- A minimum liquid net worth which must be continuously maintained even after adjusting for the initial margin and extreme loss margin requirements;
- Liquid assets must be maintained in cash or cash equivalents and non-cash equivalents, ie approved securities and in the form of collateral as may be approved by ICCL. Liquid assets for trading in currency futures must be maintained separately in the currency derivatives segment. The cash or cash equivalent component should be at least 50% of total liquid assets. These norms are also applicable to the equity derivatives segment.

#### **4.3.5 Bombay Stock Exchange**

The institutional framework, participation, types of transaction and system operations are detailed in Sections 4.2.4.2.1; 4.2.4.2.2; and 4.2.4.2.3.

##### *4.3.5.1 Settlement procedure*

The pay-in and payout of funds securities based on the delivery or receive order issued by the BSE are settled on T+2.

Members can effect pay-in of dematerialised securities to the clearing house through either NSDL or CDSL. They must give instructions to their respective depository participants (DPs) that specify information such as the settlement number, effective pay-in date, quantity etc.

Members may also effect pay-in directly from the clients' beneficiary accounts through CDSL. For this, the clients are required to specify the settlement details and the ID of the clearing through which they have sold the securities.

Dematerialised securities are credited by the clearing house to the pool or principal accounts of the members. BSE can also transfer payout securities directly to the clients' beneficiary owner accounts without routing them through the members' pool or principal accounts in NSDL/CDSL. If securities received from one depository are to be credited to an account in the other depository, the clearing house does an inter-depository transfer to give effect to such transfers.

The bank accounts of members maintained with the clearing banks, are directly debited for their funds settlement obligations. Members whose funds pay-in obligations are not cleared at the scheduled time are subject to penalty payments or debarment from BOLT. The clearing house instructs the clearing banks to credit the members' accounts with funds on the pay-in day itself in respect of those members who are due to receive funds. If a member fails

to deliver the securities, the shortfall in the value of shares delivered is recovered from the member at the day's standard/closing price for the securities concerned.

#### 4.3.5.2 Risk management

The core of the risk management system is the liquid assets deposited by the members with the BSE. These liquid assets meet the following five requirements:

- (a) **mark to market (MTM) losses** on outstanding settlement obligations. The MTM is computed after trading hours on T+0 at the day's closing price or, if the security has not been traded that day, at the latest available closing price. MTM margins are also adjusted in respect of all the pending settlements on the basis of closing prices of T+0. The MTM is collected from members on the evening of T+0.
- (b) **VaR margins** to cover potential losses on 99% of trading days. The VaR margin is collected in advance from the total liquid assets of the member at the time of trade.
- (c) **extreme loss margins** to cover the expected loss in situations that lie outside the coverage of the VaR margins. The ELM is collected from the total liquid assets of the member.
- (d) **base minimum capital** is the capital required for all risks other than the market risk (for example, operational risk and client claims).
- (e) **special margin** is collected as a surveillance measure. If applicable, it is collected together with the MTM from the members.

Members are required to maintain sufficient liquid assets (collateral) to cover the above five requirements. There are no other margins in the risk management system. The margins are released when the settlement pay-in is completed.

If a member fails to deliver the securities due, the shortfall in the value of shares delivered is recovered from him at the day's standard/closing price for the securities concerned.

Penalties are specified for non-fulfilment of settlement obligations (ie normal pay-in, securities shortage pay-in and auction pay-in) and failure to deposit additional capital towards the capital cushion requirement by the set time

#### *Trade Guarantee Fund*

As required by the SEBI, the BSE has a Trade Guarantee Fund (TGF) to assure the timely completion and settlement of transactions.

The TGF is managed by the Defaulters' Committee, a standing committee of the BSE with a SEBI-approved constitution.

#### *Brokers' Contingency Fund*

The BSE's Brokers' Contingency Fund provides temporary refundable advances to members who face temporary financial mismatches. Members can draw an advance from the fund up to six times in a financial year. Advances have a maximum term of 30 days and are available only to meet shortfalls in a member's funds pay-in obligations in a settlement arising out of delivery-based transactions and not for any other obligations in a settlement.

BSE has contributed an initial sum of INR 600 million to the fund. All active members are required to make an initial contribution of INR 10,000 in cash to the fund and also contribute INR 0.01 for every INR 100,000 of gross turnover in all segments by way of continuous contribution to the fund. All active members are required to maintain a base minimum capital of INR 1 million with the BSE. This contribution, which is refundable, is also placed with the

fund. In addition, members are required to provide the fund with a bank guarantee of INR 1 million.

#### *Default procedure*

Members who have insufficient funds on account to meet margin calls are liable to penalties for margin default. These penalties are reviewed periodically.

### **4.4 Securities settlement systems**

The settlement arrangements for government securities with CCIL as the CPP and related risk mitigation measures are described in Section 4.4.1. Sections 4.4.2 and 4.4.3 cover the settlement of the trades executed on the stock exchanges.

#### **4.4.1 Government securities**

The RBI settles the transactions received from CCIL in DVP3: the funds and the securities obligations are settled on a net basis. From 1995 to 2002, settlement was on a DVP1 basis and from 2002 to 2004 it was on a DVP2 basis.<sup>53</sup>

Pay-in of securities takes place from the securities account of members with a net debit position in securities (ie the accounts of the members are debited) into the securities account of CCIL (ie the CCIL account is credited). Thereafter, settlement information is transmitted to the RTGS system for pay-in of funds (from the funds account<sup>54</sup> of members into the funds account of CCIL) and the subsequent payout of funds from the account of CCIL to the accounts of members with a net credit position in funds. Finally, when funds have been successfully transferred, the securities are released from CCIL's account into the accounts of members who hold a net receipt position in the settlement with respect to securities.

CCIL has a rupee line of credit and a securities line of credit with several banks. In case of a securities shortage during settlement, CCIL informs the RBI about any usage of a securities line of credit after utilising the available securities in the settlement guarantee fund. In the case of a funds shortage, the RBI accesses the funds line of credit available to CCIL and then notifies CCIL before settlement completion. Based on the utilisation of the credit lines, CCIL withholds securities or funds payable to the defaulting member(s). These are released to the members after fulfilment of their obligations vis-à-vis CCIL.

The settlement status is then updated in the NDS.

#### **4.4.2 Securities traded on the NSE and the BSE**

All actively traded securities are held and settled in dematerialised form at either the NSDL or the CDSL, the two national securities depositories. To allow dematerialised trading in a security, listed companies must connect to both depositories. SEBI mandates that all new IPOs must be traded in dematerialised form. Further, the Companies Act requires that every listed company making an IPO of securities for INR 100 million or more issue the security only in dematerialised form.

---

<sup>53</sup> See Committee on Payment and Settlement Systems, *Delivery versus payment in securities settlement systems*, Basel, 1992, p 4.

<sup>54</sup> The funds settlement takes place in the RTGS settlement account for RTGS members. However, for members who are not RTGS participants, the funds leg of the settlement takes place in their current account with the RBI.

On T+2, members pay securities into their designated clearing member accounts with the depositories within the prescribed time period. The depositories make the securities available to the clearing house. The NSCCL and BOISL are linked to the two depositories for settlement. Similarly, members with funds pay-in obligations make funds available in their designated clearing member funds accounts with the clearing banks within the prescribed time period. The clearing banks make the funds available to the NSCCL or to BOISL. As of March 2010, NSCCL had 12 clearing banks.

Once the pay-ins of funds and of securities are completed, the clearing house ensures that the payouts of funds and delivery of securities to the clearing members takes place through the clearing banks and depositories, respectively.

#### **4.4.3 Derivatives**

On settlement day (T+1 for daily settlements and expiry day+1 for final settlements), members make funds available in their designated clearing member funds accounts with the clearing banks. Funds are settled between accounts held at clearing banks.

#### **4.5 Use of securities infrastructure by the Central Bank**

The RBI uses the securities infrastructure to implement monetary policy through the Liquidity Adjustment Facility (LAF) and open market operations. LAF operations are normally conducted in the mornings. Bids are received from the participants through PDO-NDS from 09:30 to 10:30. If participants are unable to submit the bids in the PDO-NDS due to connectivity problems or other issues, as a contingency measure participants are allowed to submit a physical bid to the RBI. In such situations, an additional time window of 15 minutes is given for submitting the physical bids in hard copy.<sup>55</sup> Once a decision is taken whether to accept all or some of the bids (based on liquidity considerations), the bids are processed and sent for settlement. The funds leg is settled first on a gross basis in the RTGS system. On completion of the funds settlement leg, the securities leg is settled in the participants' securities accounts, ie their repo constituent (RC) and reverse repo constituent (RRC) accounts with the RBI.

When required a Second LAF (SLAF) can be held from 16:15 hrs to 16:45. An additional five minutes is given for physical bids if any. The process flow and settlement are the same as for the regular LAF operations held in the morning.

In the case of open market operations, bids are received through PDO-NDS between 10:30 and 12:30 hrs, with an additional 30 minutes for submission of physical bids if necessary. Once a decision is taken whether to accept all or some of the bids (based on monetary policy considerations), the bids are processed and sent for settlement. The securities in the principal SGL account held with RBI are blocked first. If sufficient securities are available on the participants' accounts, the funds leg is settled on a gross basis in the RTGS system. The securities leg is then settled in the RBI's PDO.

---

<sup>55</sup> Participants must notify the RBI by fax of their intention to submit a physical bid before the original cut-off time of 10:30.



**Payment, clearing and  
settlement systems in  
Korea**



## Contents

List of abbreviations.....	209
Introduction.....	211
1. Institutional aspects.....	211
1.1 The general institutional framework .....	211
1.2 The role of the Bank of Korea .....	213
1.3 The role of other private and public sector bodies .....	215
2. Payment media used by non-banks .....	219
2.1 Cash payments .....	219
2.2 Non-cash payments .....	219
2.3 Recent developments .....	224
3. Interbank funds transfer systems .....	224
3.1 General overview .....	224
3.2 Large-value payment system .....	225
3.3 Retail payment systems .....	230
3.4 Foreign currency settlement systems .....	235
4. Systems for post-trade processing, clearing and securities settlement.....	237
4.1 General overview .....	237
4.2 Confirmation system and trade repository .....	238
4.3 Central counterparty and clearing system.....	239
4.4 Securities settlement system .....	241
4.5 Use of the securities infrastructure by the BOK .....	244





## List of abbreviations

ARS	Automatic Response Service
ATM	automated teller machine
B2B/B2C	business to business / business to customer
BOK	Bank of Korea
BOK Act	Bank of Korea Act
BOK-Wire+	New Bank of Korea Financial Wire Network System
CCP	central counterparty
CD	certificate of deposit
CFIP	Committee on Financial Informatisation Promotion
CLS	Continuous Linked Settlement
CMS	Cash Management Service
CP	commercial paper
CSD	central securities depository
DVP	delivery versus payment
EFT Act	Electronic Financial Transactions Act
EFTPOS	electronic funds transfer at point of sale
FCFTS	foreign currency funds transfer system
FIC	financial investment company
FIFO	first in, first out
FSC	Financial Services Commission
FSCM Act	Financial Investment Services and Capital Markets Act
FSS	Financial Supervisory Service
IC	integrated circuit
KDIC	Korea Deposit Insurance Corporation
KEB	Korea Exchange Bank
KFCCC	Korea Federation of Community Credit Cooperatives
KFSB	Korea Federation of Savings Banks
KFTC	Korea Financial Telecommunications and Clearings Institute
KOSDAQ	Korea Securities Dealers Automated Quotation
KOSPI	Korea Composite Stock Price Index
KRW	Korean won
KRX	Korea Exchange
KSD	Korea Securities Depository
LVPS	large-value payment system
MoSF	Ministry of Strategy and Finance

*Korea*

MPC	Monetary Policy Committee
MS	magnetic stripe
MSB	monetary stabilisation bond
NCUFK	National Credit Union Federation of Korea
NDF	non-deliverable forward
PVP	payment versus payment
RPS	retail payment system
RTGS	real-time gross settlement
SIPS	systemically important payment system
SSS	securities settlement system

## Introduction

The payment systems of Korea consist of one large-value payment system (LVPS) and several retail payment systems (RPSs). The LVPS is BOK-Wire+, which is owned and operated by the Bank of Korea (BOK). Most of the RPSs are owned and operated by the Korea Financial Telecommunications and Clearings Institute (KFTC), the most prominent being the Electronic Banking System, the Cheque Clearing System, the Interbank Remittance System and the ATM Network.

Securities transactions are matched, confirmed, cleared and settled mainly by the Korea Exchange (KRX) and Korea Securities Depository (KSD). The KRX operates two stock exchanges (the KOSPI and KOSDAQ Markets) and one futures exchange (the Derivatives Market), and is also the central counterparty (CCP) of the securities markets it operates. Exchange-traded securities are matched, confirmed and cleared by the KRX, and settled by KSD through its securities settlement systems (SSSs). Over-the-counter (OTC) securities are meanwhile confirmed, cleared and settled mainly by KSD. The final settlement assets vary depending on the type of securities and the markets on which they are traded. The cash legs of all stock transactions and on-floor corporate bond transactions are settled with commercial bank money; other securities transactions are settled with central bank money.

Several notable developments in Korean payment and settlement systems have taken place in recent years. With regard to the LVPS, the BOK began operation of its BOK-Wire+ system in April 2009, adding a hybrid settlement function to the existing real-time gross settlement (RTGS) system, BOK-Wire. This improvement was aimed at reducing participants' liquidity burdens stemming from the rising funds transfer volumes associated with the rapid increase in the number of financial transactions. Significant changes have also been made to the retail payment environment. In particular, securities brokers are now allowed to provide funds transfer services to their non-institutional customers directly through the RPSs. Meanwhile, with the rapid spread of electronic payment instruments such as credit cards and online funds transfers, payment methods are increasingly shifting from paper-based to paperless ones. Also, with the use of mobile banking expanding rapidly, a wider range of payment services are taking advantage of mobile communication technology.

As in many other countries, active discussions on strengthening payment and settlement system safety are taking place in Korea. These draw on lessons from the recent global financial crisis. To this end, the BOK and other infrastructure operators have developed a reform plan for upgrading Korean SSSs. The establishment of a CCP and a trade repository for OTC derivatives is also under discussion.

## 1. Institutional aspects

### 1.1 The general institutional framework

With respect to the payment and settlement system of Korea, a broad range of laws and regulations govern transactions and the settlement details thereof, issuance and distribution of payment instruments, oversight of payment and settlement systems, protection for clearing and settlement agreements, etc.

The Bank of Korea Act (BOK Act), the Financial Investment Services and Capital Markets Act (FSCM Act) and the Electronic Financial Transactions Act (EFT Act), among others, clearly stipulate that the Bank of Korea (BOK) shall play a principal role in overseeing payment and settlement systems.

Table 1

**Laws relating to the Korean payment and settlement system**

Contents		Law
Transactions	Commercial transactions	Civil Act, Commercial Act, Standardised Contracts Act
	Securities exchange	Financial Investment Services and Capital Markets Act
	Foreign exchange	Foreign Exchange Transactions Act
Payment instruments	Bills, cheques	Bills of Exchange and Promissory Notes Act, Cheque Act
	Electronic funds transfer and electronic payment methods	Electronic Financial Transactions Act, Digital Signature Act, Framework Act on Electronic Commerce, Act on Consumer Protection in Electronic Transactions
	Electronic bills	Issuance and Distribution of Electronic Bills Act
	Card payments	Specialised Credit Financial Business Act
Oversight function	Oversight of payment and settlement systems	Bank of Korea Act, Electronic Financial Transactions Act, Financial Investment Services and Capital Markets Act
Settlement finality		Debtor Rehabilitation and Bankruptcy Act

**1.1.1 Bank of Korea Act**

Before the seventh amendment of the BOK Act in September 2003, there was no clear legal basis for BOK operation of its LVPS, nor for its responsibility for risk management, policy development and oversight of the nation's payment and settlement systems overall. This amendment of the Act provided the legal basis for these functions, and as a result the BOK was explicitly vested with the power to formulate and implement policies related to payment and settlement systems, allowing the BOK to more actively pursue the advancement of those systems.

Paragraph 1 of Article 81 of the Act stipulates that the BOK may, for the purpose of promoting overall payment and settlement system safety and efficiency, determine the necessary matters concerning the payment and settlement systems that it operates,<sup>1</sup> and other systems settling funds through BOK-Wire+. To be specific, the BOK may determine the rules related to the operation and risk management of BOK-Wire+, and it also determines oversight rules on payment and settlement systems overall.

Paragraphs 2 and 3 of Article 81 prescribe that the BOK may, with respect to the payment and settlement systems operated by institutions other than itself, require that their operators provide information related to payments and settlements and, if necessary, that their operators or their supervisory bodies take measures to improve system operating rules for the purpose of facilitating payment and settlement system operation. These provisions establish the legal ground for the BOK to collect information, perform assessment, request

<sup>1</sup> Currently, the BOK only operates BOK-Wire+.

improvement and monitor any payment and settlement systems. These include the retail payment systems (RPSs) operated by the Korea Financial Telecommunications and Clearings Institute (KFTC), the central counterparty and clearing system operated by the Korea Exchange (KRX) and the securities settlement systems (SSSs) operated by Korea Securities Depository (KSD).

Paragraph 4 of Article 81 authorises the BOK to require BOK-Wire+ participants to provide any relevant information. This enables the BOK to secure the information necessary to enhance payment and settlement system safety and efficiency with respect to non-bank financial institutions such as financial investment companies (FICs)<sup>2</sup> participating in the system as well as banks.

### **1.1.2 Other relevant legal texts**

In addition to the BOK Act, other laws relate to the payment and settlement systems directly or indirectly. The Civil Act, the Commercial Act and the Standardised Contracts Act regulate business transactions in general. Settlement of securities transactions is also governed by the FSCM Act, while the Foreign Exchange Transactions Act regulates foreign exchange settlement.

The Bills of Exchange and Promissory Notes Act and the Cheque Act set out the ways in which these instruments are to be issued, accepted and paid. The Specialised Credit Financial Business Act regulates credit, debit and prepaid cards. Electronic transactions are also regulated by the Electronic Financial Transactions Act (EFT Act), the Framework Act on Electronic Commerce, the Digital Signature Act and the Issuance and Distribution of Electronic Bills Act.

The FSCM Act and the EFT Act authorise the BOK to oversee FICs and other payment service providers. The BOK may require them to submit information; it may also require the Financial Supervisory Service (FSS) to examine institutions, or to conduct joint examination of them with the BOK.

The Debtor Rehabilitation and Bankruptcy Act explicitly ensures settlement finality of transactions processed through major payment systems designated by the Governor of the BOK and SSSs prescribed by the relevant Acts, once instruction transfer, clearing and settlement are completed in accordance with the operating rules of the relevant systems. In anticipation of insolvency or rehabilitation proceedings against any participant in these payment and settlement systems, the Act contains exceptional clauses guaranteeing effectiveness of their transfer instructions or payments regardless of other provisions of the Act. This means that such transactions shall not be subject to cancellation, termination or revocation, and that agreements of such systems on clearing and settlement shall be applicable to them.

## **1.2 The role of the Bank of Korea**

The BOK issues the legal tender and plays a pivotal role in the payment and settlement system of Korea by providing payment services for final settlement to financial institutions through the operation of the large-value payment system (LVPS), extending loans to financial institutions as the lender of last resort, and improving and overseeing the payment and settlement systems.

---

<sup>2</sup> An FIC is a company which conducts financial investment business under the FSCM Act.

(a) *Issuance of legal tender*

The BOK has the exclusive authority to issue the legal tender to be used in Korea for all transactions, without limitation. In this regard, the BOK provides new banknotes and coins, withdraws and exchanges old ones and eliminates damaged ones.

(b) *Provision of final settlement service*

The BOK provides final<sup>3</sup> settlement service through the current accounts of financial institutions with the BOK. The BOK Act stipulates that institutions that have current accounts with the BOK shall be limited to the government, governmental agencies, financial institutions, and any corporations that the Monetary Policy Committee (MPC) deems necessary to the performance of BOK business.

(c) *Operation of BOK-Wire+*

In 1994, the BOK began operating Korea's LVPS, BOK-Wire, a real-time gross settlement system (RTGS). BOK-Wire enabled financial institutions to connect to their current accounts with the BOK to transfer funds for short-term financial market transactions, securities settlement and foreign exchange settlement. It also provided net settlement of obligations arising from RPS transactions. With the BOK-Wire settlement volume increasing significantly, the BOK launched a plan to upgrade BOK-Wire in May 2005, and BOK-Wire was replaced in April 2009 by BOK-Wire+, which is equipped with a hybrid settlement function to save participants' settlement liquidity by applying a continuous bilateral and multilateral offsetting mechanism. The introduction of BOK-Wire+ has considerably reduced the amount of intraday settlement liquidity that financial institutions need to prepare.

(d) *Provision of liquidity*

The BOK may provide liquidity for banks facing unexpected temporary liquidity shortages, in order to prevent chain defaults and ensure financial stability. In this regard, the BOK supplies settlement liquidity to banks lacking it, through intraday overdrafts and liquidity adjustment loans,<sup>4</sup> in order to prevent delays in overall settlement caused by temporary liquidity shortages.

The BOK is able to fulfil this key role not only because of its exclusive right as the central bank to issue legal tender, but also because it is entitled to promptly intervene in the market in times of crisis as a provider of loans to financial institutions.

(e) *Payment and settlement system oversight*

To contribute to payment and settlement system safety and efficiency, the BOK oversees payment and settlement systems, their operators and participants, and their payment methods in accordance with the BOK Act and the Regulation on Operation and Management of Payment Systems. The BOK classifies the payment and settlement systems subject to its oversight into "systemically important payment and settlement systems" (SIPs) and "other payment and settlement systems" – according to the monetary values of transactions conducted through the systems and the effect that system failures would have on financial markets overall. The BOK assesses SIPs once every two years and other payment and settlement systems when necessary.

---

<sup>3</sup> The term "final" is used here in the sense that transactions paid using BOK banknotes are completed without any clearing or settlement process.

<sup>4</sup> A liquidity adjustment loan is an overnight standing facility provided by the BOK. The interest rate on a liquidity adjustment loan is 100 basis points above the Base Rate except on the last day of a reserve maintenance period, when it is 50 basis points above the Base Rate.

*(f) Research on and improvement of the payment and settlement system*

The BOK conducts research on the payment and settlement system. It also builds on the results of such research to improve the payment and settlement system by introducing new systems to further ensure system safety and efficiency. In addition, the BOK leads the efforts to promote financial informatisation<sup>5</sup> while contributing to the improvement of existing RPSs or the introduction of new ones.

*(g) Cooperation with other institutions*

After the global financial crisis, the BOK, the Ministry of Strategy and Finance (MoSF), the Financial Services Commission (FSC), the Financial Supervisory Service (FSS) and the Korea Deposit Insurance Corporation (KDIC) agreed to share financial information to enhance resilience and limit systemic risks. The BOK and the FSS also signed a memorandum of understanding on joint examinations and information-sharing. In addition, the BOK participates in international organisations including the Committee on Payment and Settlement Systems (CPSS) at the Bank for International Settlements, and in international cooperative oversight as a member of the CLS Oversight Committee together with the central banks of other countries issuing CLS currencies.

**1.3 The role of other private and public sector bodies****1.3.1 Payment and settlement system operators***(a) Korea Financial Telecommunications and Clearings Institute*

The owner and operator of most of the RPSs, the KFTC is a non-profit organisation set up on a joint ownership basis by member banks. It was established in June 1986 by a merger of the Korea Clearing and Credit Reporting Centre with the Korea Giro Centre. The KFTC has built interbank shared networks in addition to its cheque clearing and giro businesses, for the transmission of funds transfer messages between banks. It also provides support for the joint electronic businesses of financial institutions and recently launched an accredited certification<sup>6</sup> system (yessign).

*(b) Korea Exchange*

The KRX operates the KOSPI, KOSDAQ and Derivatives Markets in accordance with the FSCM Act. The KRX also clears transactions conducted in these markets. In addition, it acts as a central counterparty (CCP) by providing services such as matching and confirmation of trades, clearing, assumption of obligations and guarantee of settlements. Only members of the KRX<sup>7</sup> are allowed to trade securities in the KRX markets. KRX members are responsible for contributing funds to resolve possible settlement failures, for paying transaction charges, and for reporting their financial status (eg their quarterly balance sheets and income statements) to the KRX.

---

<sup>5</sup> Financial informatisation refers to the fact that payment instruments, financial transactions and financial information are electronically automated and standardised by information telecommunication technology.

<sup>6</sup> An accredited certification service (such as yessign) is one that issues and manages accredited certificates used for confirming the identities of parties in online transactions and for preventing e-document fraud. Accredited certificates are issued by financial institutions, and can be used for Internet banking and credit card payments for online purchases.

<sup>7</sup> Only financial institutions (mostly FICs) licensed as investment traders or investment brokers under the FSCM Act can be KRX members.



(c) *Korea Securities Depository*

KSD is the sole Korean central securities depository (CSD) under the FSCM Act. In this role, it provides centralised depository and securities settlement services through book-entry transfers. It also clears OTC securities. Financial institutions including banks, FICs, insurance companies and foreign depository services are allowed to open accounts with KSD, while individuals and other companies can use KSD only indirectly through KSD members.

(d) *Other system operators*

Other systems include CLS (Continuous Linked Settlement), the international foreign exchange (FX) settlement system, operated by CLS Bank; several local banks operating domestic foreign currency transfer systems; federations of non-bank credit institutions,<sup>8</sup> which operate funds transfer systems among their member credit cooperatives; and BC Card Co Ltd (BC Card), which operates a credit card settlement system.

CLS eliminates principal risk by providing PVP (payment versus payment) in the settlement of foreign exchange transactions. CLS Bank designated the Korean won (KRW) as a CLS-eligible currency in December 2004, and as a consequence was granted access to a BOK current account as well as to BOK-Wire+. As of the end of 2009, a total of 17 local banks and 11 foreign bank branches in Korea were using the service to settle foreign exchange transactions involving the KRW.

Several commercial banks operate foreign currency funds transfer systems (FCFTSs), which allow for foreign currency transfers between local financial institutions. A bank wishing to transfer foreign currency through the systems must open an account for each currency concerned with one of the settlement banks.

Some federations of non-bank credit institutions<sup>9</sup> – the Korea Federation of Savings Banks (KFSB), the Korea Federation of Community Credit Cooperatives (KFCCC) and the National Credit Union Federation of Korea (NCUFC) – operate funds transfer systems for their members. Funds transfers among members are completed through their accounts with the federation on a multilateral net settlement basis. Transactions between members and non-members (banks or members of other federations) are meanwhile conducted through RPSs operated by the KFTC.<sup>10</sup> More specifically, since individual members are not allowed to participate in the KFTC's RPSs, their instructions for payments to and from non-members are submitted to the RPSs in the name of the federation that participates in the relevant RPS. The KFTC calculates the federation's net settlement obligation, while the federation calculates each member's net settlement obligation and settles it through members' accounts with the federation.

BC Card, a consortium of 11 banks in Korea, provides the BC Card settlement service. When a consumer purchases goods or services with a credit card issued by a BC Card member bank, BC Card carries out multilateral net settlement between the banks of the cardholder and the merchant involved.

---

<sup>8</sup> In this article, savings banks, community credit cooperatives and credit unions are commonly called "non-bank credit institutions". The federations of these institutions are special corporations established under the Mutual Savings Banks Act, the Community Credit Cooperatives Act and the Credit Unions Act. These federations participate in the RPSs on behalf of their member institutions.

<sup>9</sup> These play roles equivalent to that of a central bank for their member institutions. They receive and manage deposits and reserves, conduct funds settlement between members, provide loans to members, and oversee the businesses of their members.

<sup>10</sup> There are 11 retail payment systems, and the three federations participate in seven of them.

### 1.3.2 Providers of payment services

#### (a) Banks

Banks eligible to carry out funds transfer services under the Banking Act provide a wide range of payment services based upon demand deposits. Banks issue bills and cheques, and provide cash deposits and withdrawal services as well as funds transfers through various RPSs operated by the KFTC (eg the Giro System or the Electronic Banking System). Foreign currency transfer services are also provided by banks, through the domestic foreign currency transfer systems.

#### (b) Post Office

The Post Office provides payment services similar to those of banks, in accordance with the Post Office Deposits and Insurance Act. Since 1995, a broad range of services have been provided by the Post Office through the RPSs operated by the KFTC.

#### (c) Federations of non-bank credit institutions

Federations of non-bank credit institutions are permitted to provide funds transfer services under the applicable special laws. Having participated in the RPSs and provided funds transfer, cash deposit and cash withdrawal services since 2002, they started issuing their own cashier's cheques<sup>11</sup> in 2008.<sup>12</sup> However, they are required to process their net settlement of RPS payments through settlement agent banks, given that the BOK cannot provide liquidity to them and that these federations do not usually maintain sufficient funds in their accounts with the BOK to meet daily net settlement needs, as they are not required to deposit mandatory reserves at the BOK.<sup>13</sup>

#### (d) Financial investment companies

FICs with investment trading or investment brokerage business licences under the FSCM Act have provided funds transfer services directly to individual customers since July 2009. They are now able to send and receive their payment instructions through RPSs as RPS participants.<sup>14</sup> Meanwhile, to prevent settlement risk from increasing in line with the number of FICs participating in the RPSs, they are required to process their net settlements through settlement agent banks,<sup>15</sup> in the same way as those of the non-bank credit institution federations.

#### (e) Credit card companies

Credit card companies issue credit cards based upon the credit status and expected future income of card applicants; and also provide acquiring and processing services. Credit cards can be used not only for purchasing goods and services, but also for instalment purchases<sup>16</sup>

---

<sup>11</sup> See Section 2.2.1 for more details.

<sup>12</sup> Before 2008, federations of non-bank credit institutions were only able to use cashier's cheques issued by banks. The amendment of the relevant law granted them permission to issue cashier's cheques by themselves.

<sup>13</sup> Under the BOK Act, the BOK can lend money to these federations only during times of severe monetary and credit contraction.

<sup>14</sup> Before February 2009, when the FSCM Act came into force, FICs were able to provide funds transfer services only indirectly, through banks.

<sup>15</sup> See Section 3.3.5 (d) for a more detailed explanation.

<sup>16</sup> In Korea, when consumers purchase goods or services using credit cards, they may sometimes choose between two options: general purchase and instalment purchase. When they choose to make a general

and cash advances. Credit card companies also issue debit cards (based on strategic partnerships with the banks where cardholders have their accounts), and prepaid cards.

(f) *Issuers of electronic money and other electronic prepayment instruments*

Issuers of electronic money (e-money) and electronic prepayment instruments<sup>17</sup> provide payment services by issuing certificates with electronically stored monetary values. Issuers of e-money must be approved by the Financial Services Commission (FSC), and issuers of electronic prepayment instruments must register with the FSC.<sup>18</sup> As of the end of 2009, three kinds of e-money and 13 kinds of electronic prepayment instrument exist.

(g) *Mobile telecommunications companies*

Mobile telecommunications companies in Korea offer mobile banking services in partnership with banks, providing users with access to the internet banking services of financial institutions through mobile devices such as mobile phones. Mobile banking services are delivered by mobile telecommunications companies that provide wireless funds transfer platforms which make internet banking services available via mobile phones. The rest of the funds transfer process is conducted by the banks in the same way as for internet banking services. In order to use mobile banking services, users must apply for internet banking services, since the services are provided through the Electronic Banking System operated by the KFTC.

Mobile telecommunications companies also provide mobile payment services. A customer having a mobile phone equipped with a special chip is able to make purchases (usually for public transport) via the phone, and the charge is made to the mobile phone bill.

### **1.3.3 Other related authorities and commissions**

(a) *Financial Services Commission*

The FSC serves as a policymaking body for matters pertaining to supervision of the financial industry as a whole for the purpose of protecting the integration of Korea's financial markets by promoting a sound credit system and fair business practices. The FSC drafts and amends financial laws and regulations; it also issues regulatory licences to financial institutions. Regarding payment and settlement systems, the FSC regulates system operators including the KRX, KSD, the federations of non-bank credit institutions, and most providers of payment services including banks, financial investment companies, non-bank credit institutions, etc.

(b) *Financial Supervisory Service*

The FSS acts as the executive supervisor for the FSC, and principally carries out examination of financial and other related institutions along with enforcement and other oversight activities as directed or charged by the FSC. The financial institutions including banks, non-bank credit institutions, financial investment companies, credit card companies, etc, and other related institutions including the KRX and KSD are supervised by the FSC.

---

purchase, they must pay the charge for their purchase at once on the following due date. When choosing the instalment option, however, they may pay for the goods and/or services purchased at regular intervals, usually three to 12 months.

<sup>17</sup> The ETF Act classifies electronic prepayment methods into e-money and other electronic prepayment instruments, in accordance with their convertibility to cash and their range of usage. See Section 2.2.4 for a more detailed explanation.

<sup>18</sup> See Section 2.2.4 for more details.

(c) *Committee on Financial Informatisation Promotion*

The Committee on Financial Informatisation Promotion (CFIP) is a private consultative group that focuses on financial informatisation. It comprises the BOK, the banks, the KFTC, the KDIC, the Korea Securities Computer Corporation, the Korea Credit Guarantee Fund, etc. The CFIP deliberates on matters related to the selection of cooperative business projects, the standardisation of work involved in financial informatisation and security for financial information networks. It led the establishment of such financial networks as the ATM Network, the Interbank Remittance System and the Electronic Banking System. Recently, the CFIP has worked on building international networks for ATM systems, on replacing magnetic stripe (MS) cards with integrated circuit (IC) cards, and on preparing mobile banking systems for smartphone use.

## 2. Payment media used by non-banks

### 2.1 Cash payments

In accordance with Article 47 of the BOK Act, the BOK currently issues banknotes in four denominations – KRW 1,000, KRW 5,000, KRW 10,000 and KRW 50,000 – and coins in six denominations – KRW 1, KRW 5, KRW 10, KRW 50, KRW 100 and KRW 500.<sup>19</sup> Most of the currency issued consists of banknotes. As of the end of 2009, banknotes of KRW 10,000 and higher values accounted for 88.9% of the total notes in circulation, with the KRW 50,000 notes accounting for 26.6%. Even though cash is still widely used in Korea, its share in total payments has been on the decline since the 1990s, owing to the rapid take-up of credit cards.

### 2.2 Non-cash payments

#### 2.2.1 Cheques and bills

Cheques and bills were formerly the most popular non-cash payment instruments, used mainly by companies. With the development and take-up of electronic payment instruments such as online funds transfer and payment cards, however, the share of cheques and bills in total payments has been on the decline since 2000.

Bills are usually used as a credit facility or payment instrument between companies. Most are promissory notes, which are certificates by which the issuer, as a debtor, promises to pay a certain amount of money to the note recipient. Promissory notes are used mainly in business transactions or financing loans between financial companies. Even though bills of exchange are also used in Korea, their total volume and value are negligible.

The cheques currently in use in Korea consist of cashier's cheques and current account cheques (corporate cheques). A cashier's cheque is drawn by a bank on itself: the bank secures settlement money for the cheque and deposits it into a separate account before issuance. In addition to blank cheques, there are three types of preset-value – KRW 100,000, KRW 500,000 and KRW 1,000,000 – cashier's cheques used in Korea, of which the KRW 100,000 denomination is the most popular (account holders with ATM cards,<sup>20</sup> or credit/debit cards with ATM card functions, can deposit cashier's cheques through

---

<sup>19</sup> The KRW/USD exchange rate was 1,164.50 at the end of 2009.

<sup>20</sup> Also called bank cards or cash cards.

ATMs, and even withdraw funds in the form of cashier's cheques). However, their share in total payments is now falling, owing to the recent expansion of electronic payments and the issuance of KRW 50,000 notes from June 2009.

A current account holder with a bank may issue current account cheques. Current account cheques, drawn on the credit statuses of their issuers, are used mainly by companies of good credit standing to pay for business transactions, taxes, use of public utilities, etc. Individuals may also issue current account cheques, but they rarely do so in Korea.

Table 2  
**Cheque and bill clearing figures**  
Daily averages, in billions of KRW

	2006	2007	2008	2009
Bills	5,431	8,059	9,931	8,172
Cheques	15,355	16,018	17,263	16,846

### 2.2.2 Funds transfers

A funds transfer enables a payer to transfer funds to a payee's account without any exchange of cash or cheque. Funds transfers in Korea include credit transfers and debit transfers, in which funds are transferred on the payment orders of the payer and the payee, respectively.

#### (a) Credit transfers

Credit transfers are available through BOK-Wire+ and various retail payment systems. Large-value funds transfers between financial institutions are made through BOK-Wire+, while most small-value funds are transferred mainly through retail payment systems including the Giro System, Interbank Remittance System, ATM Network, CMS (Cash Management Service) System and Electronic Banking System.

Companies or public corporations making large-volume payments can use the giro direct deposit service or the CMS credit transfer service. These services enable payers to transfer funds using giro direct deposits to recipient accounts with any banks across the country via a single bank account. Meanwhile, credit transfers for general-purpose payments (carried out irregularly between individuals) are executed through the Interbank Remittance System, the Electronic Banking System and the ATM Network.

The interbank remittance service allows bank customers, whether or not they have bank accounts, to remit funds from any branch teller window to any recipient account regardless of its bank affiliation. The recipient can withdraw the money immediately after the payer has sent it using this service.<sup>21</sup> The funds transfers between banks arising in the process are settled through BOK-Wire+ on the next business day. Service hours are the normal bank teller window operation hours, from 09:00 to 16:00. The maximum one-time transfer limit is KRW 100 million.

Senders can also use internet or mobile banking services provided through the Electronic Banking System to initiate credit transfers. Internet banking service hours extend from 00:05 to

<sup>21</sup> There is typically no automatic notification of recipients, who must check their bank account balances.

23:55, and the one-time and daily transfer limits are KRW 100 million and KRW 500 million respectively for individual customers, and KRW 1 billion and KRW 5 billion for corporate customers. Mobile banking services, allowing customers to access their bank accounts with mobile devices via wireless internet, have been provided since 1999. Recently, with the sharp increase in the number of smartphone users, mobile banking has gained ground rapidly.

Credit transfer can also be initiated from ATM terminals. When the system was first introduced, funds transfers were allowed only within the same bank. Funds transfers to other banks through ATMs then became available in 1994, and customers were allowed to access their own accounts through the ATMs of other banks in 1996. The service hours of ATM terminals extend from 00:05 to 23:55, 365 days a year. For safety, banks may set withdrawal and transfer limits for individual customers, up to the maximum values determined by the FSC.

The Internet Giro System, which is a type of electronic bill presentment and payment system, has been in operation since March 2000 and can be used to initiate credit transfers. Multiple billing institutions deliver bill details to the KFTC, which notifies the payers of the details via the internet. Bills can also be paid via the internet. By using this service, billing institutions can make substantial savings in printing and mailing costs, and payers can also save time by making payments via the internet without the need to visit bank branches or ATMs.

(b) *Debit transfers*

The giro direct debit service and CMS debit transfer service are used mainly to automatically transfer funds from a payer's bank account to a payee institution's account in accordance with advance agreements between the payer, the payee and the financial institutions involved, without further instruction or action by the payer.

Table 3

**Funds transfer figures, by type of transfer**

Daily averages, in thousands of transactions and billions of KRW

		2005	2006	2007	2008	2009
Credit transfer	Volume	5,370	5,781	6,470	7,175	7,396
	Value	135,406	146,468	170,068	196,701	207,910
Debit transfer	Volume	9,977	11,062	12,251	12,696	12,664
	Value	135,785	146,918	170,603	197,263	208,446

**2.2.3 Payment cards**

(a) *Credit cards*

Credit cards, first introduced in Korea in 1969, are used most widely in small- to medium-value transactions. In the early days, credit cards were allowed only for purchases of goods and services. An ATM card function was added in 1986. The range of services offered to credit card holders has increased ever since, and now includes cash advances, revolving credit and deferred payment-type public transport cards. Recently, mobile credit card services (allowing users to store their credit card information on IC chips installed in their

mobile phones) have started to allow users to make contactless payments via mobile phone. Credit cards are the most widely used card-type payment instrument in Korea.

In Korea, 11 domestic credit card brands are currently issued, by banks and specialised credit card companies.<sup>22</sup> In addition, five foreign brands are also accepted. Cardholders pay no fees on credit card transactions, their annual membership fees excepted, while merchants accepting credit cards must pay merchant discount fees. The average merchant discount fee was 2.2% at the end of 2009. Since the Korean credit card payment system is a three-party card payment system, there is no interchange fee.

Table 4

### Credit card payment volumes and values

Daily averages, in thousands of transactions and billions of KRW

	2005	2006	2007	2008	2009
Volume	7,311	8,574	9,514	11,363	13,370
Value	988	1,016	1,106	1,250	1,278

#### (b) Debit cards

Second in popularity behind credit cards are debit cards. Debit cards were in the past used mainly by people who were ineligible for credit cards, since they were no cheaper<sup>23</sup> and provided fewer bonus rewards than credit cards. Recently, however, an increasing number of people have been using debit cards, mainly because many Koreans have begun to think that using debit cards (instead of credit cards) helps prevent unnecessary purchases and impulse consumption, since debit card usage is restricted by the amount of money in a cardholder's account.

Table 5

### Debit card payment volumes and values

Daily averages, in thousands of transactions and billions of KRW

	2005	2006	2007	2008	2009
Volume	545	908	1,405	2,033	2,877
Value	22	34	52	73	100

Two kinds of debit card are currently used in Korea – PIN-based and signature-based – with signature-based cards predominant. Signature-based debit cards are issued by credit card companies. Since the service is provided through the credit card networks, cardholders can use them anywhere the relevant brands of credit card are accepted. Meanwhile, only local banks issue PIN-based debit cards, and purchases made with them are processed through

<sup>22</sup> Korean banks and specialised credit card companies issue credit cards that carry the logo of foreign card companies as well as their own. When such credit cards are used in Korea, they are treated as Korean-brand credit cards. However, when used abroad, they are treated as foreign-brand credit cards.

<sup>23</sup> No transaction fees are charged to either credit or debit card users.

the EFTPOS<sup>24</sup> network provided by the KFTC. PIN-based debit cards are not widely used in Korea due to the shortage of sellers accepting them and the restricted service hours of the network (08:00 to 23:00).

(c) *Prepaid cards*

Introduced in September 1994, prepaid cards are not widely seen in Korea. They are used mainly at filling stations, department stores, convenience stores, etc. The issuance of prepaid cards is currently very low, as they are not well promoted and few merchants accept them. Credit card companies have recently started issuing prepaid gift cards, which allow users to purchase goods or services up to the prepaid amounts.

Table 6

**Prepaid card payment volumes and values**

Daily averages, in thousands of transactions and billions of KRW

	2005	2006	2007	2008	2009
Volume	30	42	53	57	82
Value	1.4	2.0	2.5	2.8	3.5

**2.2.4 Other payment media**

Other media used in Korea include electronic money<sup>25</sup> (e-money), electronic prepayment instruments and electronic bills.

Banks, non-bank credit institutions and credit card companies may issue e-money without the approval of the FSC, while other institutions need approval to do so. Three types of e-money are currently issued in Korea, all used mainly for public transport.<sup>26</sup>

Meanwhile, other electronic prepayment methods, similar to e-money but with convertibility into cash and a range of usage far below those of e-money, are classified as “electronic prepayment instruments” in Korea.<sup>27</sup> Banks, non-bank credit institutions and credit card companies may issue electronic prepayment instruments without registering with the FSC, while other issuers may do so only after such registration. There are two types of electronic prepayment instrument: the IC card-type and the network-type. The IC card-type electronic prepayment instrument is used mainly to pay for public transport, and the network-type<sup>28</sup> for payment for goods and services purchased online.

<sup>24</sup> Electronic funds transfer at point of sale.

<sup>25</sup> The EFT Act defines e-money as a certificate or the information on such a certificate with transferable monetary values stored and issued in electronic form.

<sup>26</sup> The three types of e-money are not interoperable. As a result, public transport service providers accept only the e-money with which they are affiliated.

<sup>27</sup> In accordance with the EFT Act, e-money can be exchanged into cash at any time regardless of the balance, but exchanging electronic prepayment instruments into cash may take some time, and the cash exchanged into may be a smaller amount than the face value. E-money must, in addition, be usable in at least five business fields, but for electronic prepayment instruments two business fields will suffice.

<sup>28</sup> Network-type electronic prepayment instruments store monetary values in network databases which are accessed online for transaction approvals.



Table 7

**E-money and electronic prepaid instrument  
payment volumes and values**

Daily averages, in thousands of transactions and billions of KRW

		2005	2006	2007	2008	2009
E-money	Volume	422	438	352	298	289
	Value	0.33	0.31	0.29	0.25	0.25
Electronic prepaid instruments	Volume	n/a	n/a	n/a	9,860	12,071
	Value	n/a	n/a	n/a	11.3	15.0

Electronic bills are simply promissory notes in electronic form. The information on a bill (as to its issuer, recipient, amount, etc) is stored electronically, and its issuance, receipt, endorsement and repayment are carried out online. Corporations subject to outside audits<sup>29</sup> have been required to use electronic bills exclusively since November 2009.

### 2.3 Recent developments

Recently, developments in information and communication technology (ICT) have facilitated the use of paperless payment methods in Korea. Paper-based (excluding cash) payments accounted for 43% of retail payments in 2009, compared with 48% in 2005, while the portion of paperless payments accordingly increased from 52% to 57%.

The use of ICT in banking has made rapid progress. The UbiTouch service, a kind of electronic banking service launched in September 2008, allows customers to use any ATM providing the UbiTouch service, regardless of bank affiliation, by means of a mobile phone with a USIM chip containing account information.

Demand for smartphone banking services has also increased recently. In order to meet this demand, several banks are building systems for smartphone banking services – either individually or jointly. In particular, the BOK is leading a joint smartphone banking system project in which the KFTC and 13 commercial banks are participating. As a result, customers are now able to make funds transfers and to check their account balances.

## 3. Interbank funds transfer systems

### 3.1 General overview

Interbank funds transfer systems in Korea consist of one large-value payment system (LVPS) and several retail payment systems (RPSs) and foreign currency funds transfer systems (FCFTSs).

BOK-Wire, the LVPS, owned and operated by the BOK, was introduced in December 1994. Through this system, the BOK provided a funds transfer service via participants' current accounts with the BOK. In November 1999 the BOK began also providing a delivery versus

<sup>29</sup> In accordance with the Act on External Audit of Stock Companies, a corporation having assets totalling more than KRW 10 billion, or listed on the KRX, must be audited by an external auditor.

payment (DVP) service for securities settlement, and in December 2004 CLS was granted access to a current account with the BOK as well as to BOK-Wire in order to enable PVP service for FX settlement involving KRW. In its early days, BOK-Wire processed funds transfers based solely on its real-time gross settlement (RTGS) mechanism. However, as the BOK-Wire settlement volume surged, the liquidity burdens on participants increased. In May 2005, the BOK therefore launched a four-year project to develop a new system (BOK-Wire+), which would not only use the pre-existing RTGS mechanism but also apply a hybrid settlement mechanism.<sup>30</sup> BOK-Wire+ has operated stably since its launch in April 2009.

Most retail payment systems in Korea are operated by the Korea Financial Telecommunications and Clearings Institute (KFTC). They provide a wide range of services, including funds transfers between individual customers and large-volume corporate funds transfers.

Several major local banks operate the FCFTSs. By using FCFTSs, financial institutions are able to make foreign currency funds transfers in real time, which is not always possible via overseas correspondent banks. FCFTSs also help their participants manage their liquidity by providing them with intraday credit.

## **3.2 Large-value payment system**

### **3.2.1 Institutional framework**

The Monetary Policy Committee (MPC) is the BOK's ultimate decision-making body on its monetary policy. It decides on basic matters concerning the operation and management of the payment and settlement system. The BOK then sets the detailed standards applying to all participants, including the rights and responsibilities of the BOK, in line with the basic principles for BOK-Wire+ operation.

### **3.2.2 Participation**

In order to use BOK-Wire+, institutions must maintain current accounts with the BOK<sup>31</sup> while also fully satisfying the following requirements: financial soundness, adequate numbers of staff dedicated to BOK-Wire+ operations, and sufficient expected usage volumes.<sup>32</sup> Such requirements are determined by the Governor of the BOK, based on principles laid down by the MPC. The BOK annually checks whether member institutions meet these requirements, and those failing to do so are requested to take corrective measures, withdraw from membership or terminate the relevant contracts.

The number of BOK-Wire member institutions rose steadily in the past, from 115 in 1994 to 158 in 1997. After the Asian financial crisis in the late 1990s, however, the number dropped, due mainly to active financial sector restructuring, and as of the end of 2009 it was 129 (53 banks and 76 non-banks).

---

<sup>30</sup> A hybrid settlement system is a payment system which combines the characteristics of an RTGS system and a netting system, by adding bilateral and multilateral offsetting features to the RTGS system.

<sup>31</sup> BOK rules allow banks (local and foreign), insurance companies, securities dealers and brokers, government agencies and CLS Bank to open current accounts with the BOK.

<sup>32</sup> Currently, a minimum of six staff and 50 transactions per month.

### **3.2.3 Types of transactions**

Funds transfer services provided through BOK-Wire+ include general funds transfers,<sup>33</sup> interbank short-term lending/borrowing, third-party funds transfers, the cash legs of DVP settlement, the KRW legs of CLS settlement and RPS net settlements. BOK-Wire+ is also used for the implementation of BOK monetary policy operations as well as for the issuance and redemption of government and other public bonds.

#### *3.2.3.1 Main business*

General funds transfers between participants' accounts at the BOK are the most important service carried out by BOK-Wire+. The supply and repayment of short-term interbank lending/borrowing across participants' BOK accounts, in order to adjust temporary liquidity excesses or shortages, are done through BOK-Wire+. Third-party funds transfer allows an individual or a business to make a large-value funds transfer through a BOK-Wire+ participant promptly and safely. The DVP service conducted through BOK-Wire+ ensures that a buyer's payment for securities is made at the time of delivery through KSD (security delivery and payment are simultaneous). Through BOK-Wire+, participants are able to settle the KRW legs of their foreign exchange transactions using the PVP service provided by CLS Bank, which eliminates the principal risk of foreign exchange transactions. BOK-Wire+ also provides settlement services for transactions netted in the RPSs. Such payments include transfers between the current accounts of the participants concerned at designated times. BOK-Wire+ is also a pivotal monetary policy transmission channel, as market participants secure intraday overdrafts from or engage in repurchase transactions with the BOK.

#### *3.2.3.2 Ancillary business*

As the bank for the Korean government, the BOK collects treasury funds (taxes, fines, etc) received by financial institutions through BOK-Wire+ and carries out public and government bond-related activities, including issuances and registrations of rights of pledge, transfers of title, redemptions at maturity and repurchases before maturity. BOK-Wire+ is also used by the BOK to receive applications for loans and to grant loans.

### **3.2.4 Operation of the system and settlement procedures**

The online operating hours of BOK-Wire+ are 9:00–17:30 from Monday to Friday. The BOK may extend these hours temporarily if deemed necessary due to error in the BOK-Wire+ system, delays or concentrations of funds settlement, or any other unavoidable circumstances.

#### *3.2.4.1 Settlement system, by transaction*

The BOK-Wire+ settlement procedures are sub-classified into those using the RTGS system and those using the hybrid system with its bilateral and multilateral offsetting features added to the RTGS system. Participants hold two types of accounts with the BOK – current accounts and deposit accounts for settlement. The former are used for transactions carried out through the RTGS system, and the latter for those through the hybrid system.

Funds transfers involving BOK loans, government and public bond transactions, CLS settlement and RPS net settlement are handled through the RTGS system, while those related to general funds transfers, short-term interbank lending/borrowing and DVP settlements are dealt with through the hybrid system.

---

<sup>33</sup> The transfer of funds between accounts not connected to any underlying transactions such as securities or foreign exchange.

Table 8  
**Settlement systems and applicable transactions**

Settlement system (settlement account)	Applicable transactions	Settlement mechanism
RTGS system (current account)	<ul style="list-style-type: none"> <li>• CLS funds transfers</li> <li>• Designated-time net settlements</li> <li>• Issuances and redemptions of government and public bonds</li> <li>• BOK loans</li> <li>• Funds transfers between participants after 17:30 to repay intraday overdrafts<sup>1</sup></li> </ul>	RTGS
Hybrid system (deposit account for settlement)	<ul style="list-style-type: none"> <li>• General funds transfers (including third-party funds transfers)</li> <li>• Short-term interbank lending/borrowing</li> <li>• DVP transactions (including BOK repo transactions)</li> </ul>	RTGS, bilateral and multilateral offsetting

<sup>1</sup> Funds transfers between participants for repayment of intraday overdrafts are allowed until 17:50.

#### 3.2.4.2 Types of payment instructions

The payment instructions of BOK-Wire+ are divided into “Urgent payment instructions” and “Normal payment instructions”. Urgent payment instructions are settled immediately on a one-to-one and gross basis, provided there is a sufficient balance to cover settlement. This type of instruction is used in cases where payment must be made immediately or there is little scope for simultaneous offsetting. If the balance does not suffice to cover the relevant transaction, the system holds the payment instruction in a queue until the necessary funds are deposited or other conditions necessary for bilateral or multilateral settlement are satisfied.

Should a payment not need to be made urgently, a participant can save liquidity by classifying the payment as a normal payment instruction. In this case settlement is not processed immediately, even if the funds in the relevant account are sufficient. Rather, payment is made on a simultaneous bilateral settlement basis<sup>34</sup> at a time when the instruction of the relevant counterparty is input into the system, or by multilateral settlement, which occurs every 30 minutes. At 17:05, all normal payments are switched into urgent payments.

#### 3.2.4.3 Bilateral and multilateral settlement

When a new payment order is input into the BOK-Wire+ hybrid system, the system retrieves the order of the counterparty from its queue file and attempts to carry out simultaneous bilateral settlement. In the case of simultaneous bilateral settlement, urgent payment instructions are in principle processed ahead of normal payment instructions. However, the

<sup>34</sup> Technically, simultaneous bilateral settlement is not netting. In legal terms, settlement is gross (ie the individual obligations are not replaced by a net obligation) but it has the economic effect of netting payments because the gross payments are made simultaneously.

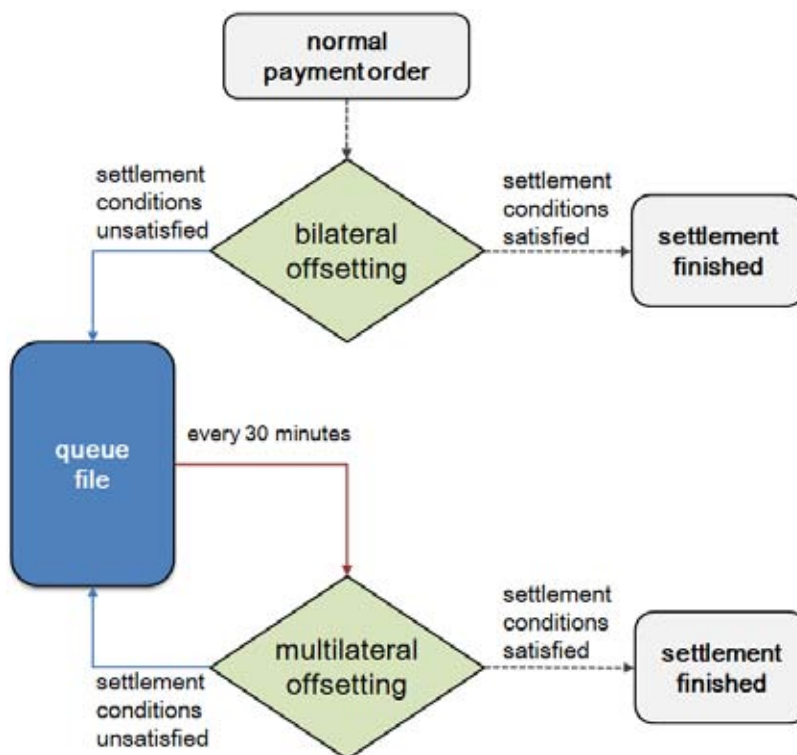
normal payment instructions of a participant to which liquidity flows as a result of a simultaneous settlement can be processed prior to urgent payment instructions. If there is a lack of funds or the net payment limit is exceeded as a result of simultaneous bilateral settlement of a normal payment instruction, the payment order is not processed but saved in a queue file. For such files, simultaneous multilateral settlement is attempted every 30 minutes, while payment instructions satisfying the settlement condition requirements, related for example to deposit balances and net payment limits, are processed simultaneously.

3.2.4.4 Queuing arrangement

Payment order processing methods differ in the RTGS and the hybrid systems of BOK-Wire+. To heighten funds transfer efficiency, the RTGS system processes payment orders in accordance with a bypass FIFO<sup>35</sup> rule. Under this rule, the system attempts to process the first transfer in a queue, but when this cannot be done due to a lack of funds, the next transfer is instead settled. The hybrid system, on the other hand, allows participants to adjust their own payment orders' positions in the queue in accordance with settlement conditions, or to change the types of their payment orders in the queue. Under this system, participants can change normal into urgent payment orders and vice versa.

Chart 1

**Bilateral and multilateral settlement mechanism**



<sup>35</sup> First in, first out.

### 3.2.4.5 Designated-time transaction system

The large-value funds transfer transactions that financial institutions apply for through BOK-Wire+ during the day are in principle processed upon receipt, in accordance with preset procedures. However, netted RPS settlements, redemptions of short-term loans with specified maturities and receipts of treasury funds from financial institutions are all processed at specific designated times during the day.

Table 9  
Designated-time transactions

Type		Time	Account
Net settlement of RPS <sup>1</sup>		11:00	Current account
Receipt of treasury funds		14:00	
Repayment of short-term loans	Half-day loans (mornings)	14:05	Deposit account for settlement
	Half-day loans (afternoons)	16:05	
	Overnight or longer-term loans	11:05	

<sup>1</sup> Net settlement of clearing transactions through clearing houses outside Seoul is carried out at 14:00.

### 3.2.5 Risk management

To reduce the credit risk involved in settlement, the BOK adopted the RTGS system when launching BOK-Wire. The related laws and regulations were also amended so as to prevent settlement finality from being impaired and to mitigate any legal risks. The Debtor Rehabilitation and Bankruptcy Act, which came into effect from April 2006, stipulates that bankruptcy procedures shall not affect transactions which are completed through BOK-Wire, thereby ensuring the finality of BOK-Wire settlement.

To facilitate smooth settlement among participants and reduce liquidity risk, the BOK extends intraday overdrafts to participant banks that are temporarily short of settlement funds. Overdrafts are provided only to financial institutions subject to the BOK's minimum reserve requirement, and interest (three-year treasury yield less overnight interbank rate) is charged on overdrafts in amounts exceeding 25% of the equity capital of recipient institutions.

With the launch of BOK-Wire+ in April 2009, the intraday liquidity needs of participants were significantly reduced, and liquidity risk in consequence declined. The new function of BOK-Wire+ has enabled participants to complete intraday settlement with lower liquidity, mitigating settlement delays and gridlock as well as the accompanying systemic risks.

### 3.2.6 Pricing

When using BOK-Wire+, participants pay fees determined by the BOK. Fees include a monthly fixed fee and per-usage fees that can vary according to when the payment order is entered. To encourage participants to enter their information early, the BOK applies discount rates to transactions entered before 16:00 and higher rates to those entered between 16:00 and 17:30.

Table 10  
**BOK-Wire+ service fee schedule**  
 In KRW

		Before 16:00	16:00–17:30	After 17:30 <sup>1</sup>
Fixed fee (monthly)		100,000		
Fee per transaction	Standard funds transfer	150	500	4,000
	Cancelled transaction	800	800	4,000

<sup>1</sup> Applicable to transactions made in extended hours.

### 3.2.7 Major ongoing and future projects

The BOK implemented a tiered participation model for BOK-Wire+ in June 2010. Through tiering arrangements, indirect participants in BOK-Wire+ can send and receive large-value payments as well as monitor their transactions through direct participants. To make this scheme more effective, the BOK plans to tighten BOK-Wire+ membership requirements and conduct an annual review of each participant's membership eligibility. Institutions failing to meet the requirements will be recommended to use the services through direct participants.

## 3.3 Retail payment systems

### 3.3.1 Institutional framework

Most retail payment systems in Korea are owned and operated by the KFTC.<sup>36</sup> The KFTC is a non-profit organisation set up on a joint ownership basis by member banks.<sup>37</sup> The decision-making bodies of the KFTC consist of the General Meeting, the Board of Directors and the Committee. The General Meeting is the supreme decision-making body and consists of member banks. The Board of Directors, comprising nine directors, enacts and revises the rules and regulations necessary for operating each RPS and makes decisions on the function and operation of the Committee. The Committee, composed mainly of participants selected as directors, decides on the details of business procedures, including operational rules and detailed guidelines, for the businesses involved in each RPS.

### 3.3.2 Participation

A payment service provider can participate in the RPSs of the KFTC in two ways. First, it can become either a general or an associate member of the KFTC, and then participate in any KFTC-operated business. The other method is to become a special participant in one or more specific businesses. Special participants, however, do not have the right to vote in the General Meeting. The BOK and financial institutions under the Banking Act may become general members, associate members or special participants, while other institutions running financial or finance-related businesses are required to obtain approval of the General

<sup>36</sup> The details of each system are laid out in Section 3.3.4.

<sup>37</sup> All local banks are either general or associate members of the KFTC. The BOK is one of the general members.

Meeting to become special participants. Special participants include the Post Office, the federations of non-bank credit institutions, foreign banks and FICs.

Approvals for participation in the RPSs operated by the KFTC, as well as expulsions, are determined at the General Meeting. At the end of 2009, 11 general members, 10 associate members and 43 special participants participated in the RPSs.

### **3.3.3 Types of transactions**

The KFTC operates 11 RPSs, providing a wide range of payment services:

- Cheque Clearing System
- Giro System
- CMS Systems
- Interbank Remittance System
- Bankline System<sup>38</sup>
- ATM Network<sup>39</sup>
- Electronic Banking System<sup>40</sup>
- K-Cash Network
- EFTPOS System
- B2B E-commerce Payment System
- B2C E-commerce Payment System

Cheque clearing services are provided through the Cheque Clearing System. The Giro and CMS Systems enable companies and public corporations to make large-volume funds transfers. Individual and corporate customers make funds transfers through the Interbank Remittance System, the Bankline System (a regional bank shared network), the ATM Network and the Electronic Banking System. The K-Cash Network is used for settlement of e-money transactions, and the EFTPOS System for settlement of debit card payments. The B2B and B2C E-commerce Payment Systems support online transactions between buyers and sellers.

Meanwhile, the credit card companies operate several credit card payment systems for settling credit card transactions.

### **3.3.4 Operation of the system and settlement procedures**

As customers request funds transfers by means of a range of payment instruments during the day, the KFTC calculates participants' total intraday transactions in each system and determines their multilateral net settlement obligations. It notifies the BOK and participants of the results at prearranged times. The BOK then completes settlement by conducting funds transfers across BOK-Wire+ participants' accounts with the BOK at the proper designated

---

<sup>38</sup> The Bankline System connects the computer network systems of regional banks through the KFTC, to allow regional bank customers to access banking services through all regional bank branches.

<sup>39</sup> The ATM Network is the name of the Korean ATM network.

<sup>40</sup> The Electronic Banking System is an expanded and revised version of the Automatic Response Service (ARS) system launched in 1984. It serves as an intermediary for electronic banking services such as ARS, telebanking, internet banking and mobile banking.



net settlement times. The details of the settlement procedures in several major RPSs are as follows:

(a) *Cheque Clearing System*

Both electronic and physical exchanges of cheques and bills are currently available in Korea. As of the end of 2010, however, the exchange of cheques has been carried out only through truncation.<sup>41</sup> With this method, banks receiving cheques (the payees' banks) reproduce the images and text information of the cheques and send them to the KFTC. Based upon the information received, the KFTC determines participants' balances with each bank and requests net settlement by the BOK at 11:00 on day T+1.

Where there is an insufficient balance in a payer's account for cashing the cheque or bill, the payer's bank notifies the payee's bank no later than 14:00 on day T+1. The payee of such a cheque is then not allowed to withdraw the funds until the issuer deposits sufficient money. When there is no such notification, funds are credited to the payee's account after 14:20 on day T+1. If the issuer of the cheque for which notification is given fails to deposit the relevant amount in his account by the end of business hours on day T+1, the cheque is classified as dishonoured and re-settled through the following day's cheque clearing process.

(b) *Giro System*

The settlement procedures for the Giro System differ depending on whether the giro bill concerned is paper-based or paperless. In the case of traditional paper-based credit transfers, the giro bills paid by customers are delivered to the KFTC on day T. After processing the bills, the KFTC sends the payment details to the payees' banks and the payees (T+1). Settlement obligations are calculated on a multilateral basis and the KFTC notifies them to the BOK before 10:00 on day T+2. Settlement takes place at 11:00 on day T+2.

In the case of the electronic giro service, settlement procedures vary according to the service type. An institution receiving funds through direct debit notifies the KFTC (T-1) of the preauthorised debit details. The KFTC sends the information to the payer's bank on the same day, and the payer's bank withdraws the relevant funds from the payer's account on the following day (T) and then notifies the KFTC (T+1). Net settlement obligations are calculated and sent to the BOK on day T+3, and the payee's bank credits the relevant funds to the deposit account of the payee on that day.

Companies using direct deposit services provide the related information including recipient account numbers and amounts to the KFTC at least two days before the due date (T-2). After classifying and grouping all notices in accordance with the payees' banks, the KFTC sends credit details to the payees' banks on day T-1, and the payees' banks credit the relevant amounts to the payees' accounts on the following day (T). Net settlement obligations are calculated on a multilateral basis and notification is made to the BOK for final settlement on day T.

(c) *Interbank Remittance System*

A funds transfer instruction submitted by a payer at a bank teller window is sent to the KFTC, which in turn transmits the instruction to the payee's bank through the Interbank Remittance System. Upon receiving the instruction, the payee's bank credits the amount to the payee's account. The KFTC then calculates the net settlement obligations on the following business day and requests net settlement by the BOK.

---

<sup>41</sup> Electronic information exchange.

*(d) ATM Network*

Where a customer withdraws cash through the ATM terminal of another bank, the details of the withdrawal are sent to the bank with which the customer holds his/her account (customer's bank). On receiving the information, the customer's bank verifies the payment request and sends a payment approval message to the bank to which the ATM belongs. The customer can then immediately withdraw cash through the ATM. The KFTC calculates the interbank net obligations, which are then settled through the BOK on the following business day. Meanwhile, in-house transactions (ATM withdrawals at branches of a customer's home bank) are not routed through the ATM Network; they are processed within the bank.

When a customer requests a credit transfer via an ATM terminal, the KFTC and the payee's bank are notified of the details through the ATM Network, and the relevant funds are immediately credited to the payee's account with the bank. The KFTC calculates the net settlement obligations and sends the information to the BOK on the following day to settle net interbank obligations.

*(e) Electronic Banking System*

Where a customer requests transfer of funds through internet banking, mobile banking or telephone banking services, the details thereof are sent through the Electronic Banking System to the KFTC and the beneficiary's bank. The relevant funds are then immediately credited to the beneficiary, and the interbank net obligations are settled through the BOK on the following business day.

*(f) CMS*

An institution receiving an insurance premium or a credit card payment using the CMS debit transfer service requests the relevant withdrawal from the payer's bank one day before the due date, through the KFTC. The payer's bank then debits the relevant funds from the payer's account on the due date, and interbank net settlement is carried out through the accounts of the banks concerned with the BOK on a multilateral net basis on the next business day. The payee's bank credits the relevant funds to the institution's account on the business day following the due date. Transfer arrangements for pension or salary payments through CMS credit transfer follow similar procedures.

*(g) Credit Card Settlement Systems<sup>42</sup>*

When a customer purchases goods or services using a credit card issued by any of the 11 BC Card member banks, the details are sent to the bank that issued the card. If the issuing bank approves the transaction, the goods or services are provided to the customer. The merchant then sends the sales slip to its bank, which will collect the payment from the issuing bank through the clearing system and pay the merchant. The issuing bank then sends a bill to the customer through BC Card.

Where a customer purchases goods or services using a credit card issued by a non-bank credit card company, the details are sent to that company and the goods or services are provided to the customer upon company approval of the transaction. After the transaction, the merchant submits the sales slip to the credit card company, which pays the merchant through its bank and sends a bill to the customer.

---

<sup>42</sup> Transactions with signature-based debit cards, which are the predominant type of debit card in Korea, are settled through the credit card settlement system described in this section. Those with PIN-based cards, the less popular type of debit card, are processed and settled through the EFTPOS Network.

### 3.3.5 Risk management

Funds transferred through some RPSs are immediately credited to the payees' accounts, and the related interbank net obligations are settled at the designated settlement times on the following business day (T+3) through BOK-Wire+. If there were no proper settlement risk management frameworks in place, therefore, a participant's settlement failure could represent a source of systemic risk. For this reason, the BOK implemented risk management arrangements for the net settlement systems in September 1997, to ensure the completion of net settlement even in the event of settlement failures of some participants. The arrangements include net debit caps, collateral requirements, and loss-sharing arrangements among participants. With FICs now able to provide funds transfer services through the RPSs, the BOK has also developed a "net settlement agent arrangement" to prevent any resulting increase in settlement risk.

#### (a) Net debit caps

A net debit cap is a ceiling set on the permitted amount of a participant's unsettled net obligation, in order to mitigate settlement risk. If a participant's unsettled net obligation exceeds its cap during a business day, it is not allowed to send additional payment instructions. RPSs in which net debit caps are applied include the ATM Network, the Interbank Remittance System and the Electronic Banking System, where customers' accounts are credited as soon as payment instructions are submitted, even before settlement of the funds through BOK-Wire+ has taken place. Each participant can, at its own discretion, determine its net debit cap. To prevent participants from setting their caps too high, the BOK uses a participant's cap as the basis for calculating its required collateral amount.

#### (b) Collateral requirements

Every RPS participant is required to provide securities as collateral against its possible settlement failure. In the event of a participant's default, the BOK can sell the participant's collateral securities or use them as collateral against BOK lending facilities to complete settlement.

Securities eligible as collateral are limited to Korean government bonds, government-guaranteed bonds and monetary stabilisation bonds.<sup>43</sup> For transactions subject to net debit caps the collateral requirement is equivalent to 30% of the cap, and for other transactions it is 30% of the daily average net payment amount cleared during the immediately preceding six-month period. The BOK assesses the market values of the collateral securities provided by participants on a daily basis, and requires participants to provide additional collateral if necessary to maintain collateral value.

#### (c) Loss-sharing arrangements

If a defaulting participant's collateral does not suffice to cover a settlement shortfall, all other participants must collectively make up the uncovered position in order to finalise the interbank net settlement. The allocation of participants' shares in this process is calculated according to the amount of their collateral. Once settlement through loss-sharing among participants has been completed, the defaulting participant must repay the other participants in accordance with their loss-sharing contributions, including interest determined in advance.

---

<sup>43</sup> Monetary stabilisation bonds (MSBs) are issued by the BOK. They originated as a major tool of monetary policy during the period when the volume of government and public bonds required for open market operations remained insufficient. They are issued in different maturities ranging from 14 days to two years, among which the two-year maturity constitutes the majority.

(d) *Net settlement agent arrangements*

FICs and the federations of non-bank credit institutions could pose relatively higher settlement risks than banks, given that they are not required to provide reserves to the BOK and therefore do not have sufficient funds in their BOK current accounts. To mitigate systemic risk, the BOK therefore allows them to carry out net settlement only indirectly, through agent banks. According to the contract between an FIC and its agent bank, the bank guarantees the FIC's obligation even when the FIC fails to make the relevant payment. Potential settlement risks caused by FICs are in this way limited to the agent banks.

### **3.3.6 Pricing**

Each institution participating in the RPSs is required to pay a one-off membership fee as well as annual fees to the KFTC. The membership fee is determined based upon the amount each institution has invested to build the system, while the annual fees aim at fully covering the maintenance and operational expenses arising from system use. These fees are applied based on the individual RPS in which each participant takes part.

Each financial institution determines, at its own discretion, the fees applicable to its customers using retail payment services. Customer fees vary depending on the financial institution and the type of transaction concerned.

### **3.3.7 Major ongoing and future projects**

Truncation of promissory notes and current account cheques exchanged through the Seoul Clearing House began in October 2009, and for clearing houses in cities neighbouring Seoul in December 2009. Nationwide deployment of truncation for promissory notes and current account cheques was completed in November 2010.

Meanwhile, with a view to establishing cross-border ATM network arrangements, discussions are taking place with central banks of countries with which Korea has active relationships. Cross-border linkages between ATM networks will allow customers to withdraw cash abroad more conveniently and at lower cost.<sup>44</sup> Banks can expect higher revenues from overseas cash withdrawal services combined with lower settlement liquidity burdens thanks to net settlement of obligations. Various arrangements are envisaged to mitigate the specific risks of cross-border ATM networks.

## **3.4 Foreign currency settlement systems**

### **3.4.1 CLS system**

#### *3.4.1.1 Overview*

Since 2004, when the KRW was designated a CLS-eligible currency, the CLS system has provided PVP settlement services for foreign exchange transactions including the KRW through direct links between BOK-Wire+ and other major RTGS systems around the world. At the end of 2009, 14 local banks and 11 foreign bank branches in Korea were settling foreign exchange transactions through the CLS system as third parties, using the services of three major local banks that are direct CLS settlement members.

---

<sup>44</sup> Currently, foreign cardholders in Korea and Korean cardholders abroad can withdraw cash only with cards that are affiliated to the global ATM card companies (eg VISA, MasterCard). With the establishment of cross-border ATM networks, cash can be withdrawn with cards not affiliated to the global ATM card companies and at lower service charges.

### 3.4.1.2 *Types of transactions*

Conventional foreign exchange transactions, such as spot exchange, forward exchange and swaps, are settled through the CLS system at present. Since December 2007, non-deliverable forward (NDF) settlement has also been done through the system.

### 3.4.1.3 *Settlement procedures*

CLS settlement member banks and third parties in Korea follow the same procedures used worldwide to settle their transactions, while CLS Bank uses its current account with the BOK to receive or discharge KRW funds. The settlement and funding period for Asia-Pacific currencies, including KRW, is between 07:00 and 10:00 CET, which is from 14:00 to 17:00 Korean standard time.

### 3.4.1.4 *Operation of the system*

To facilitate safe and efficient KRW funds transfers between CLS Bank and its settlement member banks, CLS Bank has been granted direct access to BOK-Wire+, as the only institution allowed to access it remotely from overseas. Because BOK-Wire+ does not use SWIFT (the standard communication network for CLS), the BOK has established the “CLS Link System”, which converts SWIFT messages to/from CLS Bank into the proprietary message format of BOK-Wire+.

### 3.4.1.5 *Oversight of the system*

The CLS system is subject to BOK oversight, as it is designated a systemically important payment and settlement system. In addition to the BOK’s own monitoring and assessment of the system on a regular basis, the BOK also participates in the CLS Oversight Committee for cooperative system oversight together with the other central banks of the 17 CLS-eligible currencies under the head oversight of the Federal Reserve Bank of New York.<sup>45</sup>

## 3.4.2 ***Domestic foreign currency funds transfer systems***

### 3.4.2.1 *Overview*

Financial institutions in Korea, including local banks and foreign bank branches, process foreign currency funds transfers related to small-value FX transactions or to purchases of goods and services through FCFTSs operated by some major local banks (KEB, Kookmin Bank, Shinhan Bank, etc).<sup>46</sup>

Due to international time differences, difficulties can arise when executing a foreign currency funds transfer via an overseas correspondent bank within the same business day. In contrast, the FCFTSs of domestic settlement banks can transfer foreign currency funds in real time. A large number of banks have opened foreign currency current accounts in FCFTSs. The FCFTSs also allow financial institutions to process payments, even when their account balances are insufficient, using intraday foreign currency credit provided by the settlement banks. Such credit can then be repaid overnight to the settlement banks through their overseas correspondent banks. By settling through FCFTSs, financial institutions can reduce their need for liquidity and avoid the fees imposed for execution of funds transfers through overseas correspondent banks.

---

<sup>45</sup> CLS cooperative oversight is governed by the Protocol for the Cooperative Oversight Arrangement of CLS, which can be downloaded from the website of the US Federal Reserve.

<sup>46</sup> These systems settle only the transactions of customers with accounts at the same bank.

### 3.4.2.2 *Types of transactions*

FCFTSs typically provide real-time funds transfer services in as many as 20 currencies including the USD, the EUR and the JPY. No specific restrictions are applied to the types of transactions accepted in a system, which is usually used to process retail foreign exchange or current transactions in relatively small values.

### 3.4.2.3 *Operation of the system and settlement procedures*

Settlement banks operate FCFTSs typically during their business hours from 09:00 to 17:00. Instead of using a correspondent bank in the respective currency region, the sending bank requests that the settlement bank operating an FCFTS settle the funds transfer and notify the receiving bank. The settlement bank processes the foreign currency funds transfer by debiting and crediting the sending and receiving banks' foreign currency accounts with the settlement bank.

If the sending bank's foreign currency balance is insufficient to cover the funds transfer, the settlement bank may provide an intraday credit facility within a certain limit. The bank furnished with such credit must assign its correspondent bank to transfer the same amount within the same business day to the settlement bank's correspondent bank. If the repayment is delayed, penalty interest at a rate agreed in advance between the settlement and the customer bank may be imposed.

### 3.4.2.4 *Risk management*

Settlement banks that operate FCFTSs are exposed to risks associated with intraday credit provision. For some currencies, settlement banks are unable to confirm until the following business day whether intraday credit provided to the sending banks has been repaid to their correspondent bank accounts overseas. Settlement banks are hence exposed to both credit and liquidity risks during this time.

In order to mitigate these risks, settlement banks set varying limits on intraday credit for participants, based upon their credit ratings, transaction frequencies and asset volumes.

The BOK has designated major FCFTSs as subject to its oversight, requiring that each settlement bank provide it with statistics on a periodic basis and notify it of any major changes made in system rules. The BOK also monitors and evaluates the systems and encourages settlement banks to implement prudent risk management.

### 3.4.2.5 *Pricing*

In general, local banks do not impose fees for account opening, maintenance or transfer services between themselves. However, participants need to pay fees when making overseas transfers.

## **4. Systems for post-trade processing, clearing and securities settlement**

### **4.1 General overview**

The securities settlement systems (SSSs) in Korea are operated by KSD, and the clearing systems are operated by the KRX. The KRX also operates the KOSPI, KOSDAQ and Derivatives Markets. Both stocks and bonds are traded in the KOSPI Market while only stocks are traded in the KOSDAQ Market. In the Derivatives Market, options and futures based on various underlying assets including stocks, stock indices, interest rates, currencies and commodities such as gold and lean hogs are traded.

The KRX, acting as a CCP, plays the role of clearing house for transactions conducted in the markets it operates. KSD is a central securities depository and provides book-entry transfers and a centralised depository. It also conducts settlement for floor-traded securities, as well as clearing<sup>47</sup> and settlement for those traded over the counter. The cash legs of securities transactions are settled through the accounts held either with the BOK or with commercial banks depending on the type of transaction.

Chart 2

### Summary of securities trading, clearing and settlement systems in Korea

Market	Securities	Clearing	Settlement		
			Securities	DVP	Funds
KOSPI / KOSDAQ / Derivatives markets	GBs <sup>1)</sup> , Repos	KRX	KSD	DVP3	BOK
	Stocks, Bonds <sup>2)</sup>				Commercial Banks
	Options, Futures				
OTC markets	Stocks <sup>3)</sup>	KSD	KSD	DVP3	BOK
	Bonds, CDs, CP			DVP1	
	Repos				

<sup>1</sup> Government bonds. <sup>2</sup> General bonds, including corporate and small-value government bonds. <sup>3</sup> Settlement between KRX members (brokers) and non-member institutional investors. See second paragraph of Section 4.4.4 for detailed explanation.

## 4.2 Confirmation system and trade repository

### 4.2.1 Institutional framework

Under the FSCM Act, the KRX provides confirmation of transactions made in the KRX markets, while trade confirmation for OTC transactions is conducted by KSD. Information on securities traded through the KRX markets is gathered and stored by the KRX; KSD stores information on securities traded over the counter. However, there is no trade repository for OTC derivatives in Korea.

### 4.2.2 Participation

In accordance with KRX membership regulations, only financial institutions (mostly FICs and some banks) which have obtained investment trading business or investment brokerage

<sup>47</sup> KSD provides trade confirmation services, but it is not regarded as a CCP for OTC transactions since it does not assume its members' settlement obligations.

business licences under the FSCM Act can be members. As of end-2009, 85 financial institutions had obtained KRX membership.

Participants using KSD's settlement system for their OTC transactions, in accordance with KSD's Regulation on Settlement Service for Securities, include banks, FICs, insurance companies, asset management companies and pension funds. At the end of 2009, KSD had 240 members for bond transactions, 82 for repo transactions and 157 for stock transactions.

#### **4.2.3 Types of transactions**

The KRX conducts trade confirmation for stocks, bonds and derivatives listed on the KRX markets. Stock, bond and repo transactions conducted over the counter are confirmed by KSD.

#### **4.2.4 Operation of the system**

When buy and sell orders for KRX-listed securities are placed on day T, they are matched automatically by the KRX matching system, and the KRX corrects errors in transactions and confirms them before 15:00 on day T+1.

Meanwhile, when a buyer and a seller enter into an agreement to trade bonds over the counter, they provide notification of the trade details to KSD. KSD then confirms the information and notifies the buyer and seller of final settlement details.

#### **4.2.5 Pricing**

The KRX charges no specific fees for its confirmation service. Instead it charges for the whole range of services it provides, which include trade matching, confirmation and clearing. More details on the KRX fee policy are provided in Section 4.3.7. Similarly, KSD does not charge any specific fees for its confirmation service.

### **4.3 Central counterparty and clearing system**

#### **4.3.1 Institutional framework**

The KRX acts as a CCP for the trades conducted in the markets it operates. As the CCP, the KRX assumes obligations, performs multilateral trade netting, and confirms settlement of funds and securities in accordance with the FSCM Act. The KRX also guarantees settlement of transactions conducted in the markets it operates, consequently reducing counterparty risk.

The KRX is a corporation owned by 43 shareholder companies, mainly FICs. The FSC is responsible for supervising KRX businesses. The KRX is required to obtain FSC approvals for establishing or amending its membership and operational rules. The KRX's clearing systems are subject to BOK payment and settlement system oversight.

There is currently no CCP for OTC securities transactions in Korea.

#### **4.3.2 Participants**

See Section 4.2.2.

#### **4.3.3 Types of transactions**

The KRX is the CCP of the KRX markets including the KOSPI, KOSDAQ and Derivatives Markets. The KOSPI Market is divided into the stock and the bond markets, and the bond market is subdivided into two segments. In the first segment – the general bond market –



corporate, and small-value government and public bonds are traded. In the second segment – the government bond market – government bonds, monetary stabilisation bonds and KDIC (Korea Deposit Insurance Corporation) bonds are traded.

Only stocks are traded in the KOSDAQ Market, while various options and futures are traded in the Derivatives Market.

Table 11  
**Summary of securities trading, clearing and settlement through KRX**

Securities traded	KOSPI Market			KOSDAQ Market	Derivatives Market
	Stocks	Government bonds	General bonds	Stocks	Options, futures
Clearing agent	KRX	KRX	KRX	KRX	KRX
Settlement (funds)	Banks	BOK	Banks	Banks	Banks
Settlement (securities)	KSD	KSD	KSD	KSD	–
Settlement day	T+2	T+1 <sup>1</sup>	T	T+2	T+1
DVP type	DVP3	DVP3	DVP3	DVP3	DVP3
Number of members <sup>2</sup>	61	85	85	61	63

<sup>1</sup> Day T for repo transactions. <sup>2</sup> End of 2009.

#### **4.3.4 Operation of the system**

As the CCP for securities transactions made through the KRX markets, the KRX assumes the obligations of its members. By means of multilateral netting, it determines the volume of securities and the amount of funds to be submitted by each member. KRX members as well as KSD are notified of the relevant details.

#### **4.3.5 Risk management**

To mitigate settlement risk for the Korean CCP, various risk management tools are employed. If a participant defaults on its obligations, the KRX requires members to pay margins (defaulter's pay). KRX members must also contribute to a joint compensation fund which makes good any losses not covered by the defaulters (survivor's pay). The KRX uses a part of its assets – its settlement reserve – to guarantee securities transactions between its members. The order in which these resources are used is as follows:

1. The margin funds from the defaulting participant
2. The defaulting participant's contribution to the compensation fund
3. The remainder of the compensation fund
4. KRX's line of credit and other assets including settlement reserve

In addition, only institutions satisfying certain requirements<sup>48</sup> are eligible to be members and carry out securities transactions in the KRX markets.

#### **4.3.6 Links to other systems**

For securities settlement, the KRX links its clearing systems with KSD's settlement system for securities settlement. There is currently no link with foreign CCPs or CSDs.

#### **4.3.7 Pricing**

The KRX charges three kinds of fee for its services: a trading fee, a clearing and settlement fee, and an access fee. Trading and settlement fees are charged to KRX members in proportion to their transaction values, while connection fees are charged on a per-transaction basis. Fee policy is decided by the KRX Board of Directors.

#### **4.3.8 Major ongoing and future projects**

Since 2008, the financial supervisory authorities, the BOK and major market participants have jointly discussed how to enhance the efficiency and safety of OTC derivatives market activities in Korea. In the light of market growth and the lessons learnt from the recent global financial crisis, the decision has been taken to build new infrastructure for the OTC derivatives market, including a CCP and a trade repository. While the details are still being discussed by a task force established in February 2010, the instruments most likely to be subject to CCP clearing are interest rate swaps, credit default swaps and currency swaps. The FSC plans to complete the legislative process by the end of 2012.

### **4.4 Securities settlement system**

#### **4.4.1 Institutional framework**

KSD is the only Korean CSD. It is constituted as a special corporation under the FSCM Act. In accordance with the Act, KSD provides a centralised depository for securities, and securities settlement by book-entry transfer for floor-traded and OTC securities transactions. The KRX is its major shareholder, and its depositors, which are banks and FICs, comprise the other shareholders. The FSC is responsible for its supervision, and KSD requires FSC approval for changes in its articles of incorporation and business rules. In accordance with the BOK Act, the BOK oversees the settlement systems operated by KSD.

#### **4.4.2 Participants**

See Section 4.2.2.

#### **4.4.3 Types of transactions**

All securities, except for derivatives, traded on-floor or over the counter are settled through KSD's settlement systems. Derivatives transactions are meanwhile settled by the KRX, either via cash settlement or physical delivery.

---

<sup>48</sup> The requirements include appropriate financial soundness, IT infrastructure and human resources.

#### 4.4.4 Operation of the system

Settlement procedures differ depending on the securities concerned. For stocks and bonds traded on the KRX markets, the KRX notifies its members and KSD of the settlement details. Members are required to transfer funds or deliver securities to KSD's securities settlement account or funds settlement account by no later than 16:00 on the settlement date. Settlement dates are day T+2 for stocks, T+1 for government bonds and T for general bonds. Only when both counterparties to a transaction have delivered their obligations (securities or funds) to the accounts of KSD will KSD simultaneously transfer the securities and funds to the members to complete settlement (DVP3 scheme).<sup>49</sup>

Where institutional investors such as asset management companies entrust conduct of securities transactions to KRX members, such trades are accompanied by large-value securities deliveries and funds transfers between KRX members and its institutional clients. Therefore a settlement procedure exists for settlement between KRX members and its institutional clients. When a KRX member enters into a transaction agreement through the KRX markets according to the entrustment, the member notifies KSD of the details. KSD then determines the settlement details based upon bilateral net settlement and notifies the trading parties (the KRX member and clients) of the settlement information. Based on this information, on T+2 the parties deliver the securities to their accounts with KSD and transfer the funds to KSD's account with the BOK during BOK-Wire+ business hours (currently 09:00–17:30). Once both parties complete their delivery of the securities and payment of the funds, KSD initiates simultaneous settlement of the securities and funds under the DVP3 scheme.

Payment for derivatives transactions conducted between the KRX and its members is carried out no later than 16:00 on day T+1, through the accounts held with commercial banks. In the case of physical delivery for gold futures, however, payment is made at 12:00 on day T+3 through the designated warehouse<sup>50</sup> under a DVP3 mechanism.

For bond, certificate of deposit (CD) and commercial paper (CP) transactions made over the counter, the trading parties must deliver the securities or make payment to the KSD settlement accounts during BOK-Wire+ business hours on the settlement date, in accordance with the notified details. Settlement occurs on day T+1 for bonds and day T for CDs or CP. As soon as the trading parties have delivered their securities and funds to their securities accounts with KSD and KSD's account with the BOK, KSD simultaneously settles the securities and funds – through the parties' securities accounts at KSD and funds accounts held with the BOK (DVP1 scheme).

OTC repo transactions are settled through the Institutional Repo Settlement System operated by KSD. The settlement procedures for transactions in and redemptions of repos are almost the same as those for bonds traded over the counter. The differences are that settlement of repos takes place on the trade date (T), and daily calculation of collateral and margin requirements is performed in order to maintain collateral value during the contract period.

---

<sup>49</sup> For a description of different DVP models, see CPSS, *Delivery versus payment in securities settlement systems*, Basel, September 1992.

<sup>50</sup> KSD is the designated warehouse at present.

Table 12

**Summary of clearing and settlement through KSD**

<b>Securities</b>	<b>Bonds</b>	<b>CDs, CP</b>	<b>Repos</b>	<b>Stocks<sup>1</sup></b>
Clearing	KSD	KSD	KSD	KSD
Settlement (funds)	BOK	BOK	BOK	BOK
Settlement (securities)	KSD	KSD	KSD	KSD
Settlement day	T+1	T	T	T+2
DVP type	DVP1	DVP1	DVP1	DVP3
Number of members <sup>2</sup>	240	240	82	157

<sup>1</sup> Stocks traded between KRX members and institutional investors. <sup>2</sup> End of 2009.

**4.4.5 Risk management**

KSD employs several risk management tools. First, by implementation of a DVP mechanism linking KSD's SSSs with BOK-Wire+, principal risk arising from the settlement of securities transactions is substantially eliminated. Also, as final settlement of securities occurs no later than T+2 (ie T+2 for stocks and T or T+1 for bonds), the volume of trade outstanding is limited and aggregate market exposure mitigated. To reduce operational risk, KSD has a recovery plan and runs a backup operating centre. It also limits its membership to institutions satisfying certain requirements, related to eg financial soundness, human resources and IT infrastructure. Lastly, KSD is subject to supervision by the FSS and the FSC, and its SSSs are overseen by the BOK.

**4.4.6 Links to other systems**

KSD links its settlement systems with the KRX and the BOK for the settlement of the securities leg and the funds leg of securities transactions conducted on-floor or over the counter in Korea. In addition, KSD's settlement systems are linked with two international CSDs, Euroclear and Clearstream, and two global custodians, Citibank and State Street Bank. Through these links, KSD provides depository and settlement services for foreign securities. KSD currently provides such services for securities listed on 34 foreign securities markets.

**4.4.7 Pricing**

Fees for settlement services provided by KSD are determined by KSD's Board of Directors and approved by the FSC. Fees consist of a settlement service fee and a deposit service fee. The settlement service fee is calculated as a percentage of each transaction value, plus KRW 500 per transaction. The deposit service fee is charged in proportion to the value of the securities deposited.

**4.4.8 Major ongoing and future projects**

The BOK, KRX and KSD are working to enhance the SSSs in several ways, including prevention of settlement delays or gridlocks caused by clashes between the different settlement processes in the KRX and the OTC markets.

To that end, the BOK and clearing and settlement system operators developed in November 2009 a reform plan for upgrading the SSSs. While full details of the reform are not yet

determined, some aspects include changing the settlement procedures for government bonds and repo transactions in the KRX markets from DVP3 to DVP1, for earlier settlement, and introducing a new scheme for intraday BOK liquidity provision using self-collateral repos,<sup>51</sup> to reduce the liquidity burdens on financial institutions caused by the changes in settlement procedures. Details of the reform will be set out and put into effect from the second half of 2011.

#### **4.5 Use of the securities infrastructure by the BOK**

The BOK uses the securities infrastructure in conducting its monetary policy operations. It carries out open market operations as and when necessary to influence the level of reserves in the banking system and to manage the overnight interbank lending/borrowing rate. These operations are conducted in two ways: through the issuance of monetary stabilisation bonds, and through securities transactions (outright sales and purchases or repo agreements). The corresponding depository services are provided by KSD.

---

<sup>51</sup> Under this scheme, the KRX and its FIC members can use the government bonds and monetary stabilisation bonds they purchase as collateral against which they can obtain intraday liquidity funds from the BOK for settling the transaction.

**Payment, clearing and  
settlement systems in  
Mexico**



## Contents

List of abbreviations.....	249
Introduction.....	251
1. Institutional aspects.....	252
1.1 General institutional framework.....	252
1.1.1 Institutions.....	252
1.1.2 General legal aspects.....	252
1.2 The role of the Bank of Mexico.....	253
1.2.1 Oversight.....	253
1.2.2 Provision of payment and settlement services.....	255
1.2.3 Cooperation with other institutions.....	256
1.3 The role of other private and public sector bodies.....	257
1.3.1 Mexican Bankers' Association.....	257
1.3.2 Broker-Dealers' Association.....	258
1.3.3 Ministry of Finance.....	258
1.3.4 National Banking and Securities Commission.....	258
2. Payment media used by non-banks.....	259
2.1 Cash payments.....	259
2.2 Non-cash payments.....	259
2.2.1 Credit transfers.....	259
2.2.2 Cheques.....	260
2.2.3 Direct debits.....	260
2.2.4 Payment cards.....	261
2.2.5 Postal instruments.....	263
2.2.6 Remittances.....	263
2.3 Recent developments.....	263
3. Payment systems.....	264
3.1 General overview.....	264
3.2 Large-value payment systems.....	264
3.2.1 SPEI.....	264
3.3 Retail payment systems.....	267
3.3.1 CCEN.....	267
3.3.2 ATM and POS networks.....	269
4. Systems for post-trade processing, clearing and securities settlement.....	271
4.1 General overview.....	271
4.2 Central counterparties and clearing systems.....	272



4.2.1	CCV.....	272
4.2.2	ASIGNA.....	274
4.3	Securities settlement systems.....	277
4.3.1	DALI.....	277
4.4	Use of securities infrastructure by the Bank of Mexico.....	279

## List of abbreviations

ABM	Asociación de Bancos de México – Mexican Bankers’ Association
AMIB	Asociación Mexicana de Intermediarios Bursátiles – the broker-dealers’ association
ASIGNA	Asigna Compensación y Liquidación – a central counterparty for derivatives
BMV	Bolsa Mexicana de Valores – the Mexican Stock Exchange
BMV Group	A holding company whose main operating subsidiaries are ASIGNA, BMV, CCV, INDEVAL and MEXDER
CCEN	Cámara de Compensación Electrónica Nacional – National Automated Clearing House. The retail payments automated clearing house
CCV	Contraparte Central de Valores – a central counterparty for operations with equities
CCP	Central counterparty
CECOBAN	Centro de Cómputo Bancario – a bank-owned company that operates CCEN
CLS	Continuous Linked Settlement
CLABE	Standard format for all bank account numbers, used in interbank credit transfers
CNBV	Comisión Nacional Bancaria y de Valores – National Banking and Securities Commission
CSD	Central securities depository
DALI	Depósito, Administración y Liquidación – a securities settlement system
EGLOBAL	A card transaction processor
INDEVAL	SD Indeval, Institución para el depósito de valores S.A. de C.V. – The Mexican central securities depository
IPAB	Instituto para la Protección al Ahorro Bancario – the Mexican deposit insurer
IPC	Índice de Precios y Cotizaciones – the representative Mexican stock exchange index
MEXDER	Mercado Mexicano de Derivados – the Mexican Derivatives Exchange
MXN	Mexican peso
PROSA	Promoción y Operación, S.A. de C.V. – a card transaction processor
RNV	Registro Nacional de Valores – National Securities Registry
RTGS	Real-time gross settlement
SHCP	Secretaría de Hacienda y Crédito Público – Ministry of Finance

*Mexico*

SIAC	Sistema de Atención a Cuentahabientes de Banco de México – the central bank system which provides liquidity and where participants' current accounts are held
SIC	Sistema Internacional de Cotizaciones – the registry for securities issued abroad that can be traded on the BMV
SICAM	Sistema para Liquidación de Cámaras – a system that clears operations from CCEN
SPEI	Sistema de Pagos Electrónicos Interbancarios – the main real-time payment system
SSS	Securities settlement system
TIIE	Tasa de Interés Interbancaria de Equilibrio. – a market representative rate, calculated by the central bank
TEF	Transferencia Electrónica de Fondos – CCEN's deferred electronic fund transfer system
UDI	Unidad de Inversión – an inflation-indexed unit of account

## Introduction

The Mexican payment and settlement systems has undergone significant change in the last 10 years. The central bank has developed Sistema de Pagos Electrónicos Interbancarios (SPEI), a near real-time hybrid settlement system for payments, helped INDEVAL, the central securities depository, to develop Depósito, Administración y Liquidación (DALI), a near real-time securities settlement system and also instituted safe and efficient intraday liquidity provision facilities. In all these projects, the central bank has striven to promote straight through processing, and to achieve high resilience and good performance in the new systems. It has also actively fostered competition among small-value payment services providers, with a view to promoting the use of safer and more efficient small-value payment methods.

SPEI is operated by the central bank and went live in 2004. It was designed to settle a large volume of payments in real time, to facilitate straight through processing and to use participants' liquidity efficiently. Any financial entity regulated by any of the Mexican financial authorities is eligible to participate in SPEI. More than 85% of SPEI payments are for less than MXN 100,000.<sup>1</sup> SPEI settles both large- and small-value payments. Moreover, SPEI settles pay-ins and pay-outs for CLS<sup>2</sup> and MXN payments for Directo a México, an international fund transfer service between USA and Mexico.<sup>3</sup>

The securities settlement system, DALI, is operated by INDEVAL. DALI went live at the end of 2008 and is a major improvement over the former securities settlement system. DALI settles more than 70% of the total volume processed in all Mexico's payment and securities clearing and settlement systems.

The two main exchanges are the Mexican Stock Exchange (BMV) for equities, and MEXDER for derivatives. Contraparte Central de Valores (CCV) clears transactions on BMV as a central counterparty (CCP), while ASIGNA is the CCP for transactions on MEXDER. BMV, MEXDER, CCV, ASIGNA as well as INDEVAL belong to the same holding company, BMV Group.

Sistema de Atención a Cuentahabientes (SIAC) manages the liquidity provision facilities and the banks' current accounts at the central bank. SIAC also manages the accounts of government entities that, by law, must be in account with the central bank.

CECOBAN, a company owned by banks, operates Cámara de Compensación Electrónica Nacional (CCEN), an automated clearing house. CCEN processes and clears deferred electronic fund transfers, cheques and direct debits. CCEN final settlement occurs in SIAC.

Almost all credit and debit cards are affiliated with Visa or MasterCard. However, two domestic bank-owned processors, Promoción y Operación, S.A. de C.V. (PROSA) and EGLOBAL process and clear all card transactions.

The central bank has a mandate to foster the proper functioning of payment systems. To achieve this, the central bank requires the systemically important payment systems to comply with the CPSS Core Principles for Systemically Important Payment Systems. Similarly, it ensures that the securities settlement systems and central counterparties comply with the relevant CPSS-IOSCO standards.

---

<sup>1</sup> The MXN/USD exchange rate was 13.0587 at the end of 2009.

<sup>2</sup> Continuous Linked Settlement, see Chapter 1.2.3.

<sup>3</sup> This service is provided jointly by the US Federal Reserve Banks and the central bank of Mexico.

## **1. Institutional aspects**

### **1.1 General institutional framework**

#### **1.1.1 Institutions**

The Bank of Mexico, Mexico's central bank, is an independent public legal entity governed by the Bank of Mexico Act. It is responsible for monetary policy and acts as regulator, market operator, liquidity provider and lender of last resort in the financial system. The Bank of Mexico Act also mandates the central bank to foster the proper operation of payment systems as one of its main objectives. The law provides the central bank with broad authority to regulate payment, clearing and settlement systems.

The Ministry of Finance or Secretaría de Hacienda y Crédito Público (SHCP) is the office of the executive in charge of fiscal, economic and financial policy.

The National Banking and Securities Commission or Comisión Nacional Bancaria y de Valores (CNBV), is an agency of the SHCP. It is the main supervisor and regulator for banks and other financial entities.

#### **1.1.2 General legal aspects**

The Payment Systems Act (PSA) regulates the clearing and settlement of transfer orders in national or foreign currency and with respect to securities operations. The PSA grants the central bank exclusive powers of oversight, supervision and sanction over the payment, clearing and settlement systems and their operators. This authority also covers systems that settle cash and securities.

The central bank is legally required to publish each year a list of the systems that fall within the scope of the PSA. To do this, the central bank determines which systems fall within statutory parameters such as participant numbers and transfer volumes.<sup>4</sup>

According to the PSA, all transfer orders in national or foreign currency or securities transactions that are settled in a system listed as a systemically important payment system are final, irrevocable and enforceable.<sup>5</sup> In addition, the funds of payment systems participants on account with their payment system cannot be legally attached from the start of the payment system's daily operations until payment obligations are settled. Moreover, collateral posted for intraday liquidity cannot be legally attached until the payment obligations against that collateral are settled.

A corollary of these rules is that no "zero hour rule" exists under the PSA or under the Commercial Reorganisations Act that governs bankruptcies.

The PSA also specifies the requirements for netting arrangements. The effect of netting is to substitute a net credit or payment obligation for the rights and obligations originated by transfer orders. Thus, no specific agreement is needed by the counterparties in a payment to allow netting.

The Credit Institutions Act provides that orders and transactions settled through foreign payment systems (such as CLS) that are considered as final, irrevocable, enforceable under

---

<sup>4</sup> For more details of the central bank's oversight powers see Section 1.2.1.

<sup>5</sup> The PSA establishes that the internal regulations of each payment or settlement system must determine the moment when transfer orders are considered accepted and thus become final, irrevocable and enforceable. For SPEI and DALI, their respective internal regulations provide that transfer orders are final when the systems send the credit advice messages to the respective participants.

the law governing the corresponding foreign payment system will also have such characteristics under Mexican law.

The Securities Market Act states that clearing and settlement of securities is a public service that can only be provided by the central bank, central counterparties and central securities depositories.

Central securities depositories can provide their service to national or foreign financial entities or foreign central securities depositories without acting as a counterparty in such transactions. In Mexico, the only central securities depository is INDEVAL, which is the owner and operator of the securities settlement system, DALI.

The regulatory framework for derivatives transactions is based on regulations issued by the SHCP, the CNBV and the central bank. These regulations allow derivatives trades to be executed either in OTC markets or on recognised exchanges. ASIGNA is the only CCP authorised to clear and settle derivative transactions. It is also the CCP for any derivative transaction executed on MEXDER, the Mexican derivatives exchange.

The Notes and Credit Transactions General Act regulates the issuance of cheques and the operation of cheque clearing houses. In connection with this Act, the Transparency and Financial Services Arrangement Act authorises the central bank to regulate and to licence clearing houses. CECOBAN, a private corporation, is the sole institution currently authorised by the central bank to provide cheque clearing and deferred fund transfers services.

Finally, in Mexico, any transfer of assets intended to defraud third parties that is made during the nine months before a declaration of bankruptcy may be legally voided. However, finality and irrevocability prevent courts from annulling transfers that have been accepted, settled and cleared through a listed systemically important payment system. In such a case, an aggrieved party would have to seek redress outside the payment system.

## **1.2 The role of the Bank of Mexico**

### **1.2.1 Oversight**

Four main statutes empower the central bank to oversee and regulate payment systems: (i) the Bank of Mexico Act mandates the central bank to foster the safe and efficient functioning of all payment systems; (ii) the Payment Systems Act authorises the central bank to regulate and oversee systemically important payment systems; (iii) the Securities Market Act empowers the central bank to oversee central counterparties and securities settlement systems; and (iv) the Transparency and Financial Services Arrangement Act gives the central bank a broad mandate to regulate and oversee retail payment systems and non-systemically important clearing houses.

The central bank oversees both systemically important and retail payment systems. For systemically important systems, the central bank monitors existing and planned systems, assesses them against international best practice and instructs operators to implement changes when necessary. For retail payments and retail payment systems, the central bank promotes competitiveness along with safety and efficiency.

The Payment Systems Act establishes that a payment or settlement system is systemically important when: (i) it has at least three participating financial entities, and (ii) its settlement

volume averages more than UDI 100 billion.<sup>6</sup> Payment systems operated by the central bank are systemically important, even if they do not fall within the above scope.

At the beginning of each year, the central bank lists in the Mexican Official Gazette the payment and settlement systems it considers to be systemically important. SPEI, SIAC and the securities settlement system have been listed as systemically important since 2005.

#### *Oversight activities for systemically important payment systems*

Financial stability depends on systemically important payment systems that are safe and efficient. To this end, the central bank requires that such systems comply with the CPSS core principles for systemically important payment systems.

SPEI was designed to comply with the CPSS core principles. To be able to identify any risks or quality deficits in its operation, the central bank monitors its operation and liaises regularly with its stakeholders, including the Mexican Bankers' Association or Asociación de Bancos de México (ABM), the Mexican Broker-Dealers' Association or Asociación Mexicana de Intermediarios Bursátiles (AMIB) and non-bank financial entities.

The central bank published a self-assessment for SPEI in 2007, which will be updated whenever there is a significant change in the system itself or the financial industry.

Under the Payment Systems Act, SIAC is designated a systemically important system because it is operated by the central bank and it settles, on average, more than UDI 100 billion each month. The central bank published a self-assessment of SIAC against the CPSS core principles in 2007. SIAC's main function is to manage liquidity provisions for participants in the payments systems; its payment functions are very limited (see Section 1.2.2), but it complies with all the applicable core principles.

The securities settlement system, DALI, is the third system designated as systemically important under the Payment Systems Act. It is operated by INDEVAL, the central securities depository, a private company owned by banks and broker-dealers.

DALI was designed to comply with the CPSS-IOSCO's Recommendations for Securities Settlement Systems. The central bank meets frequently with INDEVAL's officers and relevant stakeholders, mainly banks and broker-dealers, to review requests for rules and system changes and to assess DALI's performance.

INDEVAL is regulated by the National Banking and Securities Commission (CNBV) and the central bank. The central bank focuses on payment and settlement issues, while the CNBV is concerned with the conduct of participants and their compliance with legislation and regulations as issuers of securities and counterparties in securities transactions. Any change in DALI's internal rules requires the approval of both the CNBV and the central bank. Also, as an INDEVAL shareholder, the central bank has one seat on INDEVAL's board. The central bank and the CNBV cooperate whenever necessary (see Section 1.2.3).

The central bank published an assessment for DALI against the CPSS-IOSCO's Recommendations for Securities Settlement Systems, following the CPSS-IOSCO's Assessment Methodology for Securities Settlement Systems. The bank will review the assessment in the event of significant changes at DALI or within its operating environment.

The CCP for equities, CCV, a private company owned by broker-dealers and banks, is not listed as systemically important under the Payment Systems Act because it settles operations with a value of less than UDI 100 billion a month. The central bank and the CNBV have a joint mandate under the Securities Market Act to oversee CCV. The central bank can

---

<sup>6</sup> The Unidad de Inversión (UDI) was introduced in 1995 as a credit system based on a price level-adjusted unit of account. One UDI, as of October 2010, was equivalent to about USD 0.36.

meet CCV's officers, at either party's option, to review rules and procedures with a view to improving the system's security and efficiency. The central bank has published an assessment for CCV against the CPSS-IOSCO's Recommendations for Central Counterparties, and has asked CCV to change its rules and procedures to better comply with the recommendations.

ASIGNA, the CCP for derivatives, is not listed as systemically important because its monthly settlement volume is less than UDI 100 billion. It is supervised by CNBV. Unlike CCV, where the Securities Market Act provides the central bank with powers to oversee it, there is no similar legislation on derivatives; thus, the central bank has only limited powers over ASIGNA, such as the right to request information. This will change if ASIGNA were to be designated as systemically important under the Payment Systems Act.

#### *Oversight activities in retail payments and retail payment systems*

The central bank oversees retail payments systems to improve their safety and efficiency as well as to promote competition among payments service providers. The bank also encourages the use of the most efficient means of payments.

CECOBAN, a private company owned by banks, operates the National Automated Clearing House or Cámara de Compensación Electrónica Nacional (CCEN), an ACH for cheques, deferred credit transfers and direct debits. The Transparency and Financial Services Arrangement Act complements the Bank of Mexico Act and empowers the central bank to oversee clearing houses such as CECOBAN. Changes in CCEN's internal rules require central bank approval, and the central bank has a seat on CECOBAN's board as well as veto powers over relevant decisions.

The central bank collects and publishes quarterly information from banks on payment instruments such as same-bank cheques, cards and internet operations. This includes data on infrastructure, operations and fees.

Finally, a recent amendment of the Transparency and Financial Services Arrangement Act empowers the central bank to oversee and regulate card payments processors.

### **1.2.2 Provision of payment and settlement services**

#### *Operation of payment systems*

The central bank has operated both SIAC and SPEI since 1990 and 2004 respectively. The main payment system is SPEI; SIAC has limited payment functions. When SIAC started operating it was the only electronic payment system provided by the central bank. It is a real-time gross settlement (RTGS) payment system designed for interbank payments that carry no information identifying third-party payers or payees. SIAC does not support STP. As SPEI is more efficient, most payments have migrated to this system (for details of SPEI, see Section 3.2). SIAC now holds banks' current accounts and the accounts of certain government entities at the central bank but processes only a few large interbank payments. The central bank manages the liquidity provision for the payment system through SIAC, as described in the section on provision of liquidity below.

The central bank prescribes the operating rules for SIAC and SPEI and recovers all development and operational costs through fees.



### *Provision of liquidity*

The central bank provides participants with liquidity through SIAC (for details of SIAC, see the above section). Intraday liquidity to banks is supplied through two mechanisms:

- (i) Overdrafts on the banks' current accounts at the central bank. A bank is allowed to overdraw its current account up to the amount of its required reserves<sup>7</sup> in the central bank. There is no charge for intraday overdrafts, but if an overdraft is not covered by the end of the day, the central bank applies an interest rate of twice the average overnight interbank rate.
- (ii) Same day repo operations with government securities. The central bank automatically accepts Mexican government securities in repo operations. If banks repurchase securities before the end of the day, the central bank does not charge an interest rate; otherwise, the central bank novates repo operation to the following business day and counts the amount of the operation as a debit on the bank's end-of-day balance in its current account.<sup>8</sup> Failure to reverse the repo at the end of the day increases the amount of the central bank's charge on the bank's account as described in paragraph (i) unless the bank has a positive balance large enough to cover the amount of the repo (ie it has received funds in the funding period after the closing of the repo facility). There is also a small fine based on the number of underlying securities left in repo.

There is a limit, based on the bank's capital, for the amount of liquidity a bank can obtain using this mechanism. Broker-dealers can obtain liquidity through this mechanism with the support of a bank. If a broker-dealer fails to reverse the repo, the supporting bank is responsible for reversing it.

### *Provision of cash settlement facilities*

SIAC holds the banks' current accounts and manages the liquidity mechanisms. Participants in SPEI and DALI have an operating account in each system. SIAC, SPEI and DALI cash accounts use central bank money. DALI is a SPEI participant and provides its participants with cash accounts to settle their securities transactions. All balances in DALI participants' accounts are at all times covered by the balance that DALI maintains in SPEI. Banks and broker-dealers use the mechanisms described above to obtain liquidity in SIAC, and they can transfer liquidity in real time to their SPEI or DALI accounts and back to SIAC. All banks participate in all three systems, all broker-dealers participate in SIAC and DALI and some of them are also SPEI participants.

The central bank also provides cash settlement facilities to the CCEN automated clearing house. Each business day, CCEN's net results settle in the banks' SIAC current accounts.

### **1.2.3 Cooperation with other institutions**

The central bank is the payment and settlement systems regulator. CNBV, SHCP and the central bank regulate banks, broker-dealers, INDEVAL and CCV, and certain other entities. Some regulations could affect the way these entities participate in, or operate (INDEVAL and CCV) payment and settlement systems. Thus, there is a need for cooperation between the regulators of the payment and settlement systems and other regulators. The central bank aims to increase the safety and efficiency of systemically important payment and settlement

---

<sup>7</sup> Banks are required to maintain fixed deposits with the central bank for monetary policy purposes. These deposits are remunerated but banks cannot withdraw the principal. Bank's current accounts at the central bank are not remunerated.

<sup>8</sup> After the closing of the same-day repo facility, banks have a short period to fund their accounts.

systems with a view to maintaining financial stability. For retail payments, the central bank seeks to increase the use of the most efficient means of payment as well as the safety and efficiency of payment systems. It also monitors payment services providers with a view to ensuring that the fees they charge to their customers are reasonable. To these ends, the central bank cooperates with SHCP and CNBV in a variety of ways:<sup>9</sup>

- The central bank, SHCP, CNBV and other financial sector government entities participate in a financial stability board, chaired by SHCP. The board's purpose is to identify risks that could affect the smooth operation of the financial system, to establish policies to prevent and manage those risks and to propose and coordinate the responses of each financial authority to a crisis.
- The central bank meets with SHCP officers, whenever required, to deal with payment systems issues that involve both financial authorities, such as treasury payments and anti-money laundering. There is no memorandum of understanding between SHCP and the central bank.
- The central bank also meets with CNBV officers whenever there are payment or settlement issues that involve INDEVAL, CCV, the participants in the payments and settlement systems, or issues related to retail payments, such as user security regulations, new payment methods, rules for payment services providers or retail payments infrastructure. There is no memorandum of understanding between CNBV and the central bank; the cooperation between the two bodies takes place on an informal basis.

The central bank has regular meetings with ABM to discuss issues related to SPEI operations, such as change proposals from the banks or from the central bank to improve efficiency. The central bank also has meetings with ABM to assess the development of payments instruments, to discuss ways of improving them and to promote their use, as well as to evaluate new instruments.

The central bank meets regularly with DALI's stakeholders, through ABM and AMIB, to discuss enhancements to DALI's safety and efficiency. The central bank also held regular meetings with stakeholders during DALI's development phase before it started operations in November 2008.

The Mexican peso has been a Continuous Linked Settlement (CLS) currency since May 2008. The central bank participates in the CLS oversight committee comprising the central banks of issue of the 17 CLS participating currencies, with the Federal Reserve Bank of New York as lead overseer.<sup>10</sup> The committee is tasked with the oversight of CLS and meets at least once a year.

### **1.3 The role of other private and public sector bodies**

#### **1.3.1 Mexican Bankers' Association**

The Mexican Banker's Association (ABM) is a private organisation that represents commercial banks. It was founded in 1928 with the aim of promoting the general interests of banks and providing them with technical and specialised services. All commercial banks

---

<sup>9</sup> See Sections 1.3.3 and 1.3.4 for the roles of CNBV and SHCP.

<sup>10</sup> The oversight cooperation between the relevant central banks is governed by the *Protocol for the Cooperative Oversight Arrangement of CLS*. For more information on CLS, please see the corresponding chapter in the forthcoming second volume of this publication.

participate in ABM as associates, and development banks participate as guests. The Association shares knowledge and best practice through courses, conventions, seminars, research studies etc.

In addition, ABM serves as the main communication channel between banks when they are requested to evaluate and provide feedback to official requests and proposals, or when the banks themselves ask the authorities for operational changes and/or legal amendments.

The Association also promotes coordination among banks and authorities on issues related to means of payment such as new products, networks, ATM, POS, credit and debit cards, or SPEI and CCEN payment message formats.

ABM establishes work groups that meet regularly with central bank officers to discuss on specific matters. The central bank participates or chairs discussions on several key issues. Among the groups focused on payment and settlement issues are the Treasury Committee, which deals with liquidity and large-value payments issues; the Means of Payment Committee, which deals with retail payment systems and means of payments issues; and the Information Technology Committee, which coordinates IT developments of common interest to banks, ie formats and standards in SPEI, CCEN, DALI and card payments.

### **1.3.2 Broker-Dealers' Association**

The Broker-Dealers' Association (AMIB) was founded in 1980 to represent the interests of broker-dealers; to promote financial education; and to coordinate the definition of market participants' needs in areas such as instruments, operational schemes, infrastructure and improvements to stock market services.

AMIB is the main communication channel between broker-dealers and the authorities for payment and settlement system issues, and for providing feedback or requesting operational changes and legal amendments. AMIB is a self-regulatory organisation.

### **1.3.3 Ministry of Finance**

The Ministry of Finance (SHCP) is the office of the executive in charge of fiscal, economic, and financial policy. Among SHCP's tasks are the management of federal income and expenditure, the management of public debt and the management of development banks.

SHCP is empowered to implement and interpret legislation on financial services, as well as to issue and revoke operating licenses for entities that provide financial infrastructure, such as exchanges, central securities depositories and central counterparties.

### **1.3.4 National Banking and Securities Commission**

The National Banking and Securities Commission (CNBV) is the SHCP agency that supervises most financial entities, including banks and broker-dealers.

The CNBV is empowered to issue and revoke operating licenses for banks and broker-dealers, as well as to supervise financial market infrastructures that process securities operations, including exchanges, central securities depositories and central counterparties.

CNBV's main responsibilities are to: (i) formulate prudential regulation for banks; (ii) license financial intermediaries, such as banks; (iii) maintain the National Securities Registry (RNV), and supervise registered securities issuers; (iv) order the suspension of trading whenever the market meets with adverse conditions or its operations fail to comply with best practice; and (v) put insolvent banks into receivership.

CNBV's supervisory role comprises the following activities:

- (i) Assessing the risks faced by financial entities, the controls they have implemented, and the quality of their management with a view to ensuring that institutions maintain

adequate liquidity, are solvent, stable and comply with applicable rules and best practice.

- (ii) Onsite inspections, auditing of operations, registries and operational systems.
- (iii) Analysing economic and financial information to estimate possible effects on financial entities and the financial system as a whole.
- (iv) Devising mandatory action plans for financial entities to correct any weaknesses in their liquidity, solvency or stability.

## 2. Payment media used by non-banks

Individuals and companies use retail payments to purchase goods or services, or to pay out wages etc. Most retail payments in Mexico are made in cash, but the use of electronic payments is growing.

### 2.1 Cash payments

The central bank is the only issuer of bank notes and coins in Mexico. The official currency is the Mexican peso (MXN). The central bank issues banknotes in six denominations: MXN 20, 50, 100, 200, 500 and 1,000. The US dollar circulates along with the peso, especially in border regions and at tourist destinations.

The central bank designs its banknotes and prints them at its own works in Mexico City. The central bank distributes banknotes and coins through six branches and 45 correspondent banks.

Casa de Moneda de México, a public entity, mints coins in the following denominations: five, 10, 20, and 50 cents and one, two, five, 10, and 100 pesos. At the end of 2009, the notes and coins in circulation were worth MXN 537 billion,<sup>11</sup> an amount equal to approximately 4.5% of that year's GDP.

### 2.2 Non-cash payments

#### 2.2.1 Credit transfers

In Mexico, the most important domestic credit transfer instruments are the following: fund transfers between accounts at the same bank, interbank fund transfers processed through SPEI or CCEN,<sup>12</sup> and transfers to pay credit card balances processed by card switches. Currently, credit transfers can be initiated at the counter, via internet banking, at ATMs (to pay utility bills and top up prepaid mobile phones), and using mobile phones (although this service is still in its early stages). In addition, the Mexican Treasury (Tesorería de la Federación) has since 2008 paid the salaries of federal government employees through SPEI.

As the central bank has a mandate to promote the use of the most efficient payment instruments, it encourages the use of credit transfers instead of cheques or cash in a number of ways (for instance, through advertising campaigns). In particular, the central bank uses

---

<sup>11</sup> The exchange rate was 13.0587 MXN/USD at the end of 2009.

<sup>12</sup> See Section 3 for a more specific definition of SPEI and CCEN.

moral suasion by issuing public recommendations or by deterring banks from establishing excessively high fund transfer fees. In cases where a bank refuses to lower a fee that is considered excessive, the central bank can veto it, based on powers vested to the central bank under the Transparency and Financial Services Arrangement Act.

Credit transfers have shown significant growth. Real-time credit transfers are settled through SPEI, while next-day credit transfers are processed by CCEN. In 2009, credit transfers accounted for 36% of all non-cash payments. The number of transfers increased from 348 million in 2005 to 733 million in 2009. The amount transferred has increased from MXN 42.8 trillion in 2005 to MXN 187 trillion in 2009. Interbank credit transfers are only a small fraction of the total number of transfers, but they have been increasing faster: from 22 million transactions (MXN 20.5 trillion) in 2005, they reached 81 million (MXN 107.3 trillion) in 2009. SPEI processed 50.4 million of these payments (worth MXN 106.4 trillion), while CCEN processed 21 million (MXN 850 billion). The remainder was accounted for by transfers to pay credit card balances 9.6 million (MXN 34 billion), which were processed by card switches.

The upward trend of credit transfer usage is due to a steady growth in the number of internet banking users (an average annual growth rate of around 20% since 2004, taking the number of internet banking users to 10 million by the end of 2009). Moreover, banks have reduced their SPEI fees to customers; most charge less than MXN 6. Meanwhile, the standardisation of account numbers has reduced rejection rates, making interbank transfer services more reliable. Banks currently use a standard 18-digit number, the Clave Bancaria Estandarizada (CLABE), to identify both the bank and the account. The CLABE has been widely used in interbank credit transfers since June 2004.

Due to the transaction growth in SPEI, the central bank has reduced operating fees to participants from MXN 2.80 (in 2004) to MXN 0.50 for most payments, and to MXN 0.10 for payments sent after 19:00 and before 10:00. This encourages banks to send non-urgent high-volume/low-value transactions at night or early in the day.

### **2.2.2 Cheques**

Cheques are used for paying suppliers, payrolls, taxes, credit card balances, utility bills, cable TV subscriptions and school fees. The use of MXN-denominated cheques has declined; from 569 million in 2005 to 461 million in 2009. The total value of payments made by cheque was MXN 10.7 trillion in 2005, and MXN 11 trillion in 2009. The number of cheques, as a share of all non-cash payments, has fallen from 41% in 2005 to 22% in 2009.

In January 2009, the central bank set a MXN 20,000 ceiling for cheques payable to the bearer, to combat fraud.

All interbank cheques are truncated, and receiving banks send digital records with account and amount information to the issuing bank through CCEN. Also, for cheques with a value of MXN 10,000 and above, receiving banks send a digital image to the issuing bank through CCEN.

### **2.2.3 Direct debits**

Direct debits allow service providers such as cable TV or telephone companies to charge their customers' bank accounts automatically. Initially, banks offered companies direct debit services on their own customers checking or credit card accounts. This service was reasonable for large companies, but because banks' direct debit schemes were not interoperable, it was expensive for smaller billers to maintain accounts and service agreements with a sufficient number of banks to cover their customer base.

CECOBAN has offered interoperable direct debit services to banks through CCEN since 2002. In this service, the originators must secure a mandate from the account holder to

instruct their banks to post debits of the amount due. In September 2009, the central bank issued a regulation establishing objection and cancellation procedures in order to increase the service's attractiveness to consumers.

The number of direct debits rose from 30 million in 2005 to 42 million in 2009, and the value from MXN 49 billion in 2005 to almost MXN 141 billion in 2009. However, their share of non-cash payments hovered at around 2% between 2005 and 2009.

#### **2.2.4 Payment cards**

The number of payments with credit and debit cards at electronic terminals (POS) rose from 30% of total non-cash payments in 2005 to around 40% in 2009. Currently, debit cards, credit cards and prepaid cards are available and widely used.

##### *Debit cards*

Only banks issue debit cards. Almost all of them are affiliated to the Visa Electron or MasterCard brands. There is also a local brand, Carnet, owned and operated by PROSA. Debit cards were popularised in Mexico by the advent of electronic payroll services, and are used mainly to withdraw cash at ATMs, and to make POS payments. ATMs are also used for balance queries and to change PINs.

By the end of 2009, the number of debit cards issued by Mexican banks was 60.8 million; up from 36 million in 2005. The number of POS terminals rose from 201,852 in 2005 to 446,792 in 2009.

During 2009, the number of debit card transactions at POS was more than 475 million, up from 210 million transactions in 2005. Debit card transactions have outnumbered credit card transactions at POS since 2007. The average value of debit card transactions at POS has increased from around MXN 494 in 2005 to MXN 505 in 2009.

Some retailers offer "cash back" facilities at POS; there were 16 million cash advance transactions in 2009.

##### *Credit cards*

Credit cards are issued by most Mexican banks and certain other financial entities. Almost all credit cards are affiliated to the Visa, MasterCard or American Express brands. The Carnet brand can also be found on a few credit cards. Although there are no issuers for other credit card brands, JCB, Diners and Discovery have acquirer agreements with some Mexican card processors and banks, and their cards are widely accepted in Mexico. Credit cards are used mainly to make payments at retailers and for internet transactions. The number of credit card transactions at POS grew from 228 million in 2005 to 397 million in 2008. The value of the transactions increased from MXN 208 billion in 2005 to MXN 322 billion in 2008. In 2009, the number of credit card transactions declined to 376 million, 5.1% less than the previous year. Also, the number of credit cards declined from 25 million to 22 million during 2009.

##### *Prepaid cards*

At the end of 2009, there were around 3 million prepaid bank cards, all with the Visa Electron, MasterCard or Carnet brand.

##### *POS network*

The two switches that process card transactions are interconnected so that the acquirer customers of each can ask the other's issuer customers to authorise transactions. The

number of POS transactions grew by around 24% per year on average between 2005 and 2008. During that time, a government programme, FIMPE,<sup>13</sup> set incentives for merchants to install POS terminals. After FIMPE ended, the growth in the number of POS terminals stalled, rising by only 0.2% in 2009 to almost 447,000 installations.

Most POS terminals accept any credit and debit card issued by a Mexican bank, as well as those issued abroad under the Visa, MasterCard, Diners, Discovery or JCB brands. The Mexican Bankers' Association (ABM) sets interchange fees (IFs) for domestic transactions. Up to 2005, IFs for credit and debit transactions were the same, ranging from 2% to 3.5%, with the exception of the fixed fee of MXN 0.90 per debit card transaction charged at members of the national association of department stores (Asociación Nacional de Tiendas de Autoservicio (ANTAD)) – given that interchange fees are charged by the issuer's bank to the acquirer's bank. IFs were originally based on merchants' yearly card sales volumes. This, however, seemed to work against the promotion and expansion of the POS network, given the large number of small merchants and service providers with low yearly sales. In 2004, the Transparency and Financial Services Arrangements Act authorised the central bank to regulate IFs, enabling it to persuade the ABM to reduce IFs and to stop the practice of setting higher fees for small merchants. Also, the central bank asked banks to set lower IFs for debit card transactions than for credit card transactions. In October 2005, the ABM changed the reference IFs for credit and debit cards. Two years later, the ABM made slight downward adjustments to its schedule of IFs.

Currently, IFs for debit cards are lower than those for credit cards. Credit card IFs are the same for all brands, as are debit card IFs. For debit card transactions, a MXN 13.5 IF ceiling applies, and the ad-valorem IFs that depend on the type of merchant range between 0.5% and 1.15%. ANTAD merchants still get a very favourable IF of MXN 1.03. For credit card transactions the IFs range between 1.1% and 1.91%, depending on the type of merchant.

#### *ATM network*

Even with the growing penetration of electronic payments, small-value transactions continue to be settled overwhelmingly in cash. Most card transactions are still ATM cash withdrawals.

All ATMs are connected in a single network. The ATM network has grown 48% since 2005 to 33,905 ATMs at the end of 2009. The number of ATMs that are installed outside branches, in places such as convenience stores, malls and retail stores, increased by 62% during the same period, while growth in in-branch ATMs was 27%. The market share in the number of ATMs for the six largest banks has decreased from 89% in 2007 to 84% in 2009. In the same year, there were more than 1.3 billion ATM withdrawals, with a total value of around MXN 1.85 trillion, while in 2005 there were 1.1 billion ATM withdrawals worth MXN 1.3 trillion.

Recently, the central bank has intervened to improve transparency on fees and competition among ATM operators. Card issuers are not allowed to charge fees to their cardholders for using the ATMs of other issuers or banks. For their part, ATM operators can charge a service fee only to cardholders from other issuing financial entities, but they must notify them of the charge and ask for authorisation.

---

<sup>13</sup> The Electronic Means of Payment Infrastructure Fund (FIMPE) was designed to promote and increase access to the POS network, and to encourage the use of POS among businesses and consumers alike. The programme ran from 2005 until February 2008.

### 2.2.5 Postal instruments

Telecomunicaciones de México (Telecomm-Telégrafos) is a state-owned company that, among other services, offers telegraphic domestic money drafts that are purchased and paid out in cash. The postal service also offers domestic cash transfer services via postal drafts.

### 2.2.6 Remittances

Most remittances to Mexico are handled by companies such as MoneyGram and Western Union that provide money transfer services worldwide. These companies receive US dollars from remitters primarily in the USA and deliver Mexican pesos to beneficiaries in Mexico through a Mexican agent, usually a bank or retailer with an extensive branch network.

Some retail stores and banks offer domestic remittance services; a customer pays for a cash transfer in one of the stores and notifies the beneficiary. The beneficiary can withdraw the money from any store or branch using an ID card.

In 2009, Mexico received more than 66 million cross-border remittance transactions (64 million in 2005) amounting to USD 21 billion (USD 21.6 billion in 2005).

#### *Directo a México*

In October 2003, the US Federal Reserve Banks and the central bank of Mexico established a one-way mechanism to transfer money from the United States to Mexico. This link was first used to send US government pension payments to recipients in Mexico. Since February, 2004, any US bank or credit union enrolled in Directo a México has been able to send payments to any individual who has a bank account in Mexico. Currently Directo a México does not process transfers from Mexico to the United States.

Between its launch in October 2003 and December 2009, Directo a México has processed almost 1.9 million payments worth USD 850 million.

## 2.3 Recent developments

In Mexico, many people who have mobile phones still lack access to financial services. A number of initiatives have been launched to offer payment services via mobile phones. Several banks in the country have already launched products or applications for mobile payments based on bank accounts, as well as access to internet banking via mobile phones. However, most of these applications only work for customers of the same bank.

Regulations issued by SHCP, CNVB and the central bank provide a legal framework that supports financial transactions over mobile phones. Any bank account can be linked to a mobile phone and new rules have paved the way for a category of accounts with less stringent identification requirements. The amount of money that can be paid into an account of this new type each month is restricted, to combat money laundering and to comply with FATF<sup>14</sup> recommendations. The rules also require banks to allow interbank electronic transfers on terms similar to those applying to bank transfers, regardless of the beneficiaries' mobile carrier. They also allow banks to outsource some activities, such as the opening and operating of the restricted accounts.

A wide range of payment methods using mobile phones is expected to develop in the near future.

---

<sup>14</sup> The Financial Action Task Force (FATF) is an intergovernmental body that seeks to develop and promote domestic and international policies to combat money laundering and terrorist financing. Mexico has been a member of FATF since 2000.



### **3. Payment systems**

#### **3.1 General overview**

SPEI and CCEN are the interbank payment systems. The central bank owns and operates SPEI, and CECOBAN, a private company owned by banks, operates CCEN. SIAC is also an interbank payment system operated by the central bank, but most of its payment functions have migrated to SPEI (see Section 1.2.2).

SPEI is a real-time system that processes almost all large-value payments and most interbank low-value credit transfers.

CCEN processes mainly low-value payments. Most payments in CCEN are settled one day after they are entered into the system.

Bank customers can use SPEI or the CCEN TEF service (Transferencia Electrónica de Fondos) for credit transfers. When using TEF, the customer's account is debited immediately and the money credited to the beneficiary on the following business day. When using SPEI, the money is transferred within minutes. TEF transfers used to be significantly less expensive than SPEI transfers, but fees for SPEI transfers have been reduced.

#### **3.2 Large-value payment systems**

##### **3.2.1 SPEI**

###### *3.2.1.1 Institutional framework*

SPEI is an electronic funds transfer system owned and operated by the central bank. SPEI has allowed its participants to transfer money in real time since August 2004.

SPEI fully supports straight through processing (STP). Commercial banks participating in SPEI offer SPEI real-time payment services to both corporations and individuals. The system is used for both large-value payments and low-value transactions such as payrolls and person-to-person transfers. SPEI settles an average of around 300,000 transactions per day (in 2010). More than 80% are for less than MXN 100,000. The federal government disburses most of its payments, including payrolls, through SPEI.

SPEI is a hybrid system: it clears operations every few seconds, and the results are settled immediately on the participants' SPEI cash accounts. SPEI accounts open and close the day with zero balances. Participants can transfer funds into their SPEI account at any time, via an online connection with SIAC and DALI (see *Provision of cash settlement facilities* in Section 1.2.2). At the end of the day, positive balances in SPEI are credited to banks' current accounts in SIAC.

###### *3.2.1.2 Participation*

The Bank of Mexico encourages the direct participation of all regulated financial entities. At the end of 2009, some 46 banks, 32 non-banks (broker-dealers, foreign exchange firms, pension fund managers, insurance companies etc) and the DALI securities settlement system were participants. Telecomm-Telégrafos, the Mexican government agency that provides telecommunications and financial services to rural areas, has also participated in SPEI since the first quarter of 2010. The central bank defines the system operating rules and establishes the requirements for participation. Access criteria are published by the central bank. Any financial entity regulated by the Mexican financial authorities is allowed to participate in SPEI. CLS, the sole foreign participant in SPEI, has indirect access via the central bank.

### 3.2.1.3 *Types of transactions*

SPEI participants can make MXN-denominated credit transfers to any other participant in the system. The most important types of transfers are: (i) from one participant to another (usually large-value payments used to settle obligations between entities) and (ii) from a customer of a participant to a customer of another participant (generally low-value payments).

Participants can transfer funds from their SPEI accounts to their SIAC current accounts, and vice versa.

Payment messages use a proprietary format. Most messages go through the central bank's private network, but internet is used as a backup communication channel and as the primary channel for some small participants. Both networks use the TCP/IP protocol, and the same message structure. Only CLS, as the sole foreign SPEI participant, uses SWIFT to communicate with the central bank, which provides CLS with indirect access to SPEI.

### 3.2.1.4 *Operation of the system and settlement procedures*

SPEI's operating rules are prescribed by the central bank (in Circular 17/2010) and in the system's operating manual. The former is publicly available and contains the general rules of the system. The latter is only available to participants and is more detailed and technical.

SPEI opens at 19:00 (Mexico City time) on the calendar day preceding the value day and accepts payments until 17:30 of the value day. The central bank sends the federal government's payroll at the opening of the system and banks have until 08:40 to credit the beneficiaries' accounts. Until recently, banks offered the SPEI service to their customers from 08:30 to 16:00, but the central bank now requires them to extend this schedule in order to bring the terms of interbank payment services closer to those of same-bank transfers, which some banks offer on a round-the-clock basis. Since September 2010, banks have offered the SPEI service to their customers, via e-banking applications, from 06:00 to 17:30.

The system places new payment instructions in a queue. Roughly every 20 seconds, SPEI runs a clearing process for all payments in the queue. The clearing process uses an algorithm that determines a set of payments that can be settled with available balances. Payments in this set generate debits and credits to the participants' accounts held in SPEI. This process may overdraw some accounts for a fraction of a second, but the complete process does not generate overdrafts. All relevant information is backed up off-site. After all relevant information is backed up, the system sends a settlement advice to both the sender and the receiving participants. SPEI rules indicate that finality for all payments takes place when the settlement advices are sent. Payments that cannot be settled remain in the queue for the next clearing process. Payments that have not been settled by the end of the day are cancelled. There are no fines for payments that stay in the queue, to avoid establishing incentives for participants to delay sending payment instructions.

A participant may assign high priority to some payments and reserve part of its account balance to settle these payments.

SPEI's rules require a sending bank to forward a payment order instructed by a customer within five minutes after it accepts the payment instruction. The rules also require the recipient bank to credit the beneficiary's account within five minutes after receiving the settlement advice. By 2011, these margins will be shortened to 30 seconds.

The communication protocol is available to all participants and interested software vendors. This allows participants to develop automatic processes to achieve STP.

### 3.2.1.5 *Risk management*

The 2002 Payment Systems Act ensures finality of all payments settled by SPEI. This Act allows each system to define the moment of finality. In SPEI finality occurs when settlement advices are sent (see Section 3.2.1.4).

SPEI settles in real time and does not use credit lines. The clearing process seeks to efficiently use liquidity available on the account as well as from incoming payments. An algorithm looks for a set of payments that can be settled given the available liquidity. These processes do not generate credit risks since overdrafts are not allowed.

SPEI's rules oblige participants to send in their customers' transfers instructions within five minutes of accepting them. This rule ensures that final users get a better service and that payments are distributed more uniformly during all banking hours to avoid concentration of liquidity needs.

Further, participants can segregate funds to settle high-priority payments.

The central bank has a business continuity strategy for SPEI that is based on international recommendations and standards. Measures include a secondary site, periodical testing, and training of key staff. SPEI only sends a settlement advice message after the corresponding information has been successfully backed up at the alternate site. In case of equipment failure, connections are redirected to the alternate site where service is resumed within minutes. SPEI requires its larger participants to maintain two dedicated communication channels through separate nodes of the telecommunications network.

Security in SPEI is based on digitally signed messages. Participants must use digital certificates obtained and managed through a public key infrastructure developed by the central bank. Messages travel in an encrypted private network or are encrypted through the internet.

SPEI complies with the CPSS Core Principles for Systemically Important Payment Systems.

#### *3.2.1.6 Pricing*

Pricing is based on the principle of full recovery of costs. The central bank charges each participant a fee for each payment instruction, money transfer to other systems and returned transfer. The fee per transaction charged by the central bank to the participants, for instructions processed between 19:00 and 10:00 is MXN 0.10; for the rest of day, this fee is MXN 0.50. Transactions subject to these fees are: credit transfers, charged to the sender of the instruction, and return transfers, charged to the sender of the instruction that could not be credited by the receiver and which generated the return transfer. Participants that request the system to resend information are charged a penalty rate of MXN 0.01 per byte. This is to encourage system participants to maintain reliable information backup processes.

Moreover, an annual fee is charged to SPEI participants for the use of the central bank's private telecommunications network.

#### *3.2.1.7 Major ongoing and future projects*

To keep operational risk low, the central bank is developing a methodology to evaluate the business continuity plans of SPEI participants. All participants will be evaluated and recommendations will be issued accordingly. The central bank will soon require critical participants to maintain stringent and robust recovery plans. The system's disaster recovery plan is currently also undergoing a major review.

If the number of payment instructions continues to grow, the central bank may further reduce the cost per transaction, especially during non-peak hours, with a view to increasing the incentive to enter payment instructions early.

SPEI's rules have been modified to improve the service offered by the banks to their customers. Banks have been required to: (i) extend their e-banking service hours from 06:00 to 17:30 (as of September 2010); (ii) expand and standardise tracking information to improve tracking services (applicable as of April 2011); (iii) ensure that issuing banks send payments to SPEI within 30 seconds after accepting an instruction from a customer (applicable as of

June 2011); and (iv) ensure that receiving banks credit the beneficiaries' accounts within 30 seconds after receiving SPEI's settlement notification (applicable as of June 2011).

### **3.3 Retail payment systems**

In 1982, the central bank, together with the banks, created a trust, CECOBAN, to clear cheques. The central bank managed CECOBAN until 1997 when banks took control.

#### **3.3.1 CCEN**

CECOBAN, a private company owned by banks, owns and operates CCEN, which processes the interbank cheques service, the direct debits service, and the deferred Electronic Funds Transfers (TEF) service.

CECOBAN is the only clearing house authorised by the central bank to settle in SIAC through the Sistema para Liquidación de Cámaras (SICAM), which is operated by the central bank. SICAM allows banks to grant credit lines to other banks to facilitate settlement, and banks have empowered SICAM to draw on these credit lines. Every evening, SICAM receives from CCEN the net positions for each of the above services and determines the resources each participant has available to settle its obligations. When a participant has a negative net position, a procedure checks that its resources (ie either a positive current account balance in SIAC or unused pledged collateral at the central bank) will cover its settlement obligations. If necessary, SICAM draws on the credit lines. Credits or debits to SIAC current accounts take place early the next day.

##### *3.3.1.1 Participation*

Any bank can participate in CCEN. Banks must be certified by CECOBAN.

##### *3.3.1.2 Types of transactions*

###### *Cheques*

CECOBAN implemented CCEN, the current clearing house, in 2001. CCEN clears all interbank domestic cheques denominated in MXN and in USD. Net amounts from cleared cheques denominated in MXN are settled in the central bank, while net amounts from cheques denominated in USD are settled in a commercial bank.

Since 2003, banks have truncated all cheques received, sending data files with the relevant information to CCEN. Banks receive from the clearing house a digital image of all cheques with value equal or greater than MXN 10,000 and send it to the issuing bank.

In recent years, the number of cheque transactions has been on the decline, although the total value of transactions has remained almost constant. CCEN processed 163 million interbank cheques in 2005, while in 2009 it processed 134 million. The total value of cheque transactions was MXN 3 trillion in 2005 and MXN 3.1 trillion in 2009. An interchange fee of MXN 6 is paid by the issuing bank to the receiving bank.

###### *Direct debits*

CCEN has provided a direct debit service since 2002. Direct debits allow a biller to instruct its bank to debit the current accounts that the biller's customers may have with other CCEN participant banks. To send direct debit instructions, the biller needs authorisation from its customers. Direct debits are settled one business day after the instruction has been received.

Direct debits use the standardised CLABE account number to identify the accounts involved in the interbank operation.

The volume of direct debits processed by CCEN rose from 3 million in 2005 to almost 10 million in 2009, with the total value of these transactions rising from MXN 8 billion to MXN 30 billion over the same period. Given the total amount of non-cash payments, the use of direct debits is very limited, not least because more than 60% of all direct debit transactions result in returns due to lack of funds. In order to promote the use of direct debits, the central bank issued a regulation in September 2009 to improve procedures for contracts, objections and service cancellations. An interchange fee of MXN 1.4 is paid by the payer's bank to the payee's bank if the transaction is successful, and MXN 0.7 if not.

#### *Credit transfers*

CECOBAN has provided a deferred credit transfer service (TEF) since 1996. Funds are credited to the beneficiary account on T+1. In 2009, CECOBAN processed 21 million TEF payments, up from 16.6 million in 2005. The total value of TEF credit transfers rose from MXN 629 billion in 2005 to MXN 850 billion in 2009.

#### *3.3.1.3 Operation of the system and settlement procedures*

SICAM receives net positions for cheques, for credit transfers and for direct debits, and clears them in a single process for final settlement.

#### *CCEN process*

Between 17:30 and 20:30 (on day T), the issuing banks send electronic files to CCEN with all transactions for each of the three services. CCEN validates the format and dates, and notifies each participating bank of the outcome of these validations before 20:30. CCEN then processes the electronic files and generates outgoing files for each participating bank.

Receiving banks must access these files by 21:00. If any of the transactions contained in an incoming file cannot be executed, the banks generate a returned items file that must be submitted to CCEN between 21:30 and 06:30 of the following day (T+1). CCEN forwards to the banks the details of each returned item. Finally, CCEN validates this information and obtains the net amounts for each bank in each service between 06:45 and 07:30, and sends the results to the central bank, which uses SICAM to complete settlement through SIAC.

#### *SICAM process*

To proceed with settlement, CCEN sends to the central bank the following information:

- The gross amount of all cheques that each bank collects for each of the other banks.
- The gross amount of all credit transfers each bank sent to each of the other banks.
- The gross amount of all direct debits each bank seeks to collect from each of the other banks.

Using that information, SICAM determines net positions for each of the three services between 07:30 and 08:15.

To support timely settlement of these positions, banks may grant permanent credit lines to each other, and register them in SICAM. These credit lines are valid until revoked. Once SICAM knows the resulting net credit and debit balances, it determines how far each credit line needs to be drawn for settlement.

SICAM computes the corresponding debits or credits, including those generated by the credit lines, and by 08:30 instructs SIAC to post them in the participant banks' current accounts with SIAC. The central bank has standing instructions to debit or credit banks accounts in SIAC based on banks' liquidity needs or balance in SICAM.

When the balance in the current account of the participant bank plus the collateral and credit lines received from other participants are not enough to cover its debit position, SICAM excludes from clearing as many obligations to decrease its debit position as needed.

SICAM notifies banks whose transactions were excluded so they can stop payment to their customers.

#### *3.3.1.4 Risk management*

The central bank does not provide banks with extra credit to settle SICAM transactions. SICAM allows banks to grant credit lines to each other. It then calculates the amount of credit needed to settle net positions.

The central bank sets a limit on the amount of any individual credit line that a bank may grant to another bank on the basis of the lender's net capital. It also sets a limit on the aggregate amount of the credit lines a bank may grant to all other banks. SICAM analyses balances, credit lines and the collateral pledged to the central bank's overdraft facility for all banks and determines if it will be necessary to exercise credit lines.

#### *3.3.1.5 Pricing*

CCEN charges a monthly fee that covers the first 10,000 transactions. Then a variable fee is applied. The variable fee starts at MXN 0.55 per transaction and falls progressively to MXN 0.10.

### **3.3.2 ATM and POS networks**

#### *3.3.2.1 Institutional framework*

Retail interbank card payments and cash withdrawals are processed and cleared by two processors, PROSA and E-GLOBAL, and settled at a settlement bank.

PROSA and E-GLOBAL exchange information under the terms of a collaboration agreement that establishes the main features and terms of the card payments process, as well as a communication protocol.

Clearing takes place at the end of the day and settlement is done the following working day by a commercial settlement bank that holds accounts for all affiliated banks.

#### *3.3.2.2 Participation*

The two largest banks own a controlling share of E-GLOBAL, while PROSA is owned by a consortium of banks.

Every Mexican bank participating in the cards market uses either PROSA or E-GLOBAL to process its domestic interbank retail payment transactions.

#### *3.3.2.3 Types of transaction*

PROSA and E-GLOBAL process most ATM, POS and internet transactions online. Only a few POS transactions are still processed offline. The processing entities route, process payment messages, clear and settle transactions at the end of the day.

#### *3.3.2.4 Operation of the system and settlement procedures*

##### *Interbank transaction at an ATM*

Processing of a transaction that involves both PROSA and E-GLOBAL is illustrated with the following transaction example: first, a cardholder uses his card, issued by a bank affiliated with E-GLOBAL, to withdraw cash at an ATM operated by a bank affiliated with PROSA (acquiring bank). The ATM sends an authorisation query to PROSA and PROSA forwards it

to E-GLOBAL, which in turn sends it to the issuing bank. The issuing bank checks the cardholder's balance and authorises the transaction through E-GLOBAL. Afterwards, E-GLOBAL sends the authorisation to PROSA, which forwards it to ATM which in turn releases the cash to the cardholder.

International transactions are cleared every day by each payment card scheme and settled on US business days. PROSA and E-GLOBAL have links with Visa, MasterCard and some other entities; they buy or sell US dollars for settlement at rates fixed by the payment card schemes.

#### *Interbank transaction at a POS*

Processing of a transaction that involves both PROSA and E-GLOBAL is illustrated with the following transaction example: A customer uses his card (either credit or debit) at a store. The merchant's bank (acquiring bank) sends a payment authorisation request to the issuer bank via the acquiring bank's processor, PROSA. PROSA sends the request to the issuer bank's processor, E-GLOBAL, which forwards it to its associate, the issuer bank, which verifies the cardholder's account balance. Once the transaction is accepted, the authorisation is sent back to E-GLOBAL, which forwards it to PROSA. After the merchant receives the authorisation and prints the related receipt, the customer receives the requested product or service.

#### *Clearing and settlement process*

Every business day, each processor computes net positions for their affiliates and sends them to the affiliates by 13:30. Affiliates of E-GLOBAL settle net positions bilaterally at a settlement bank. PROSA notifies a commercial bank that acts as settlement bank of the net positions for transactions between PROSA affiliates and between these affiliates and those of E-GLOBAL. Affiliates with short positions send funds to the settlement bank. Then the settlement bank sends the corresponding funds to affiliates with long positions. Settlement concludes by 15:30. Settlement of such transfers is usually via SPEI.

#### *3.3.2.5 Risk management*

In order to manage credit risk, processors obtain guarantees<sup>15</sup> from all card issuers involved in the settlement process. Also, processors have credit lines with some banks to ensure that they can complete the settlement process. If a bank does not settle its short position, PROSA draws on these credit lines, with the interest costs borne by the bank that failed to meet its obligations on time.

#### *3.3.2.6 Pricing*

ATM operators charge user fees that may vary according to the ATM's location.<sup>16</sup>

In October 2009, the central bank issued a regulation to make ATM fees for interbank transactions more transparent. The new regulation prohibits foreign fees.<sup>17</sup>

Between October 2009 and May 2010, the acquiring bank charged the issuer bank an interchange fee of MXN 7.25 per authorised transaction. Processors charged their associates or customer banks for transaction processing (eg special authorisations or

---

<sup>15</sup> Guarantees are generally deposits or letters of credit.

<sup>16</sup> For instance, a cash withdrawal from an ATM located in a bank branch is less expensive than a cash withdrawal from an ATM located in a convenience store.

<sup>17</sup> A foreign fee is a fee levied by the card issuer on cardholders who carry out a transaction at the ATM of another bank.

digitalisation of receipts signed by the cardholder). Consequently, whenever cardholders used an ATM not operated by their own bank, they faced a foreign fee that was usually much larger than the interchange fee. After May 2010, only the acquiring banks can charge cardholders a fee when they carry out an interbank transaction. Acquirers now pay a new interchange fee to the issuers. Currently, this interchange fee is MXN 2.92. Both the acquiring and the issuer bank pay transaction fees to the processors.

### 3.3.2.7 Major ongoing and future projects

Some foreign processors and payment schemes have complained that the fees of established processors are too high, especially on the acquiring side, and represent an unfair barrier to market entry. The central bank is currently working to promote fair access for new card processors, as well as to set efficient mechanisms for the clearing and settlement of card payments. Both current and new processors will require approval from the central bank. As current processors are not regulated, they will have to apply to the central bank for authorisation, but the central bank does not expect them to have any difficulty in meeting the criteria, as the main goal of these new regulations will be to eliminate barriers of entry to the business of switching and processing low-value payments. The central bank will set the standards, terms and communication protocols for both current and prospective processors.

## 4. Systems for post-trade processing, clearing and securities settlement

### 4.1 General overview

Domestic equities, foreign equities in the Sistema Internacional de Cotizaciones (SIC),<sup>18</sup> convertible bonds, common share certificates, warrants, domestic mutual funds, and funds (ETFs) are traded on the Bolsa Mexicana de Valores (BMV), the country's sole stock exchange. All transactions in the equity market are traded through SENTRA Equities, an electronic trading system developed and operated by BMV. At the end of 2009, Mexican equities had a total market capitalisation of MXN 4.6 trillion, equivalent to almost 40% of that year's GDP. The daily average trading volume on the BMV in 2009 was more than MXN 7 billion.

Most primary and secondary market transactions for debt securities are performed over the counter. There are four inter-dealer brokers specialised in OTC fixed income securities. These provide an electronic trading platform to financial entities such as mutual funds, pension funds and insurance companies.

Most counterparties that are not banks or broker-dealers do not participate directly in DALI, the securities settlement system. Thus, it is their custodians that send transactions directly to DALI for settlement. If a counterparty is a direct participant in DALI, it can send its transactions to DALI directly or via the inter-dealer broker.

Most customers of these brokers have empowered them to send transactions directly to DALI for settlement. Otherwise, direct participants in DALI must instruct DALI directly.

CCV is a CCP for securities. CCV clears almost all equity transactions that are traded on BMV and settles them through the DALI securities settlement system.

---

<sup>18</sup> Registry for securities issued abroad that can be traded on the BMV.



ASIGNA is a CCP for the MEXDER derivatives exchange. Interest rates futures are the most important contracts settled by ASIGNA (more than 50% of the total notional amount), followed by government bonds futures (about 19%), foreign exchange futures (on the US dollar, about 14%) and the IPC index (Mexican stock exchange index) futures.

INDEVAL, the Mexican CSD, provides deposit and custody services and is the centralised custodian for all securities registered in the Registro Nacional de Valores (RNV) and traded on Mexican financial markets. INDEVAL owns and operates DALI. Each DALI depositor holds a cash account and as many securities accounts as needed to meet its operating requirements in the system. Transactions are settled in these accounts on a delivery-versus-payment (DVP) basis.

DALI settles securities transactions in debt and equity markets. In 2009, 79% of the total amount settled in DALI represented transactions in government securities, 20% was transactions in debt securities issued by banks and corporations, and less than 1% was equity market transactions.<sup>19</sup>

There is no trade repository operating in Mexico.

## **4.2 Central counterparties and clearing systems**

### **4.2.1 CCV**

#### *4.2.1.1 Institutional framework*

Contraparte Central de Valores de México (CCV) is a CCP for stocks traded on BMV. CCV is authorised by the Ministry of Finance (SHCP) to provide clearing, settlement and risk management services to the Mexican securities market. CCV started operations in February 2004 and has been a wholly owned subsidiary of BMV since May 2008.

The Securities Market Act (SMA) regulates the activities of CCV, its risk management procedures and its governance arrangements. SMA empowers the National Banking and Securities Commission (CNBV) and the central bank to regulate CCV and it gives SHCP the power to revoke CCV's operating license under criteria specified in the SMA.

The legal framework provides with a high degree of certainty that actions taken by the CCV within its own rules may not be reversed.

As CCV is not operated by the central bank nor does it settle, on average, more than UDI 100 billion a month, it is not subject to the Payment System Act.

CCV is a direct participant in DALI, the securities settlement system operated by INDEVAL (see Section 4.4.1 for details of DALI). CCV holds securities and cash received from its participants in account with DALI and settles its MXN cash and securities obligations on a net basis through DALI.

#### *4.2.1.2 Participation*

CNBV monitors the financial and operational soundness of banks and broker-dealers. Only institutions with operating licences as banks or broker-dealers can participate in the CCV, which verifies on an ongoing basis that participants continue to meet the eligibility conditions.

Participants in CCV can be settlement agents, or non-settlement agents. Non-settlement agents need a settlement agent to settle their transactions. Settlement agents are legally

---

<sup>19</sup> Most equity transactions in DALI are transfers in which custodians deliver/receive stocks to/from a trader agent in charge of selling/buying of securities on behalf of the investor on BMV.

responsible for fulfilling both their own obligations and those of their non-settlement agent customers. CCV segregates obligations and collateral received from settlement and non-settlement agents, and determines margin requirements and net obligations individually for each agent. By June 2010, CCV had 28 participants, 24 settlement agents and four non-settlement agents.

#### 4.2.1.3 *Types of transactions*

CCV clears and settles domestic and foreign equities, as well as warrants traded on BMV.

#### 4.2.1.4 *Operation of the system*

CCV operates from 08:30 to 15:30 (BMV's trading hours) every business day. Transactions confirmed and matched on BMV are sent to CCV in real time. For each transaction closed on BMV, CCV verifies that the two participants have enough collateral to cover the transaction before it accepts and novates it as the CCP. CCV is a participant in DALI and has cash and securities accounts there. To pledge collateral to CCV, participants transfer cash and eligible securities to CCV through DALI. CCV revaluates credit exposures approximately every hour from the trading day (T) to the settlement day (T+3), making margin calls when necessary.

At the start of the settlement day (T+3), CCV determines the net obligations in securities and cash. Settlement agents and non-settlement agents then transfer securities and cash to CCV's DALI accounts to fulfil their net obligations. About an hour after opening the system, CCV determines, on a first-in, first-out basis, which of its obligations to fulfil and pays out cash and securities. After a second hour, and every hour thereafter, when it has received more cash and securities in its DALI accounts, CCV again determines which of its obligations to fulfil and pays out cash and securities. If by the end of the day CCV has not received enough securities or cash from its participants to fulfil all its obligations or if CCV has not borrowed the required securities or cash, CCV returns to participants any cash or securities received during the day related to the obligations it could not fulfil. CCV may temporarily deliver cash to participants instead of securities for obligations that remain pending. CCV has one additional day to fulfil its cash obligations (T+4) and a further day for securities obligations (T+5). CCV pays fines to affected participants, based on the amount and the length of the delay. Cash obligations not settled by T+4 or securities obligations not delivered by T+5 constitute a default. In 2009 CCV settled 99.76% of its transactions by value on the due date. Cash balances in DALI are used as a settlement asset for MXN obligations, and all participants' balances in DALI are fully covered by central bank money in DALI's account with SPEI.

#### 4.2.1.5 *Risk management*

CCV's most important risk control mechanism is based on margin requirements and intraday margin calls. CCV determines the initial margin requirements so that they cover 99% of the observed price variations in a three-day period under normal market conditions. In the following days CCV estimates variation margins for each participant approximately every hour based on the latest market prices and makes margin calls whenever the corresponding margin requirements are not met. New transactions are accepted only if the collateral posted by each participant is sufficient to cover the margin requirements for the new transactions too.

CCV accepts domestic currency cash deposits, Mexican government and private bonds, highly liquid equities and letters of credit to meet margin requirements. Haircuts are applied to securities to cover potential losses for one day under normal market conditions. Currently, participants cover 95% of their margin requirements with cash deposits.

In addition to margin requirements, CCV has access to two funds created to cover potential losses arising from a participant default in extreme scenarios:

- A fund based on contributions from each participant,<sup>20</sup> the Compensation Fund.
- A fund based on penalties and sanctions paid to CCV, the Reserve Fund.

The order in which CCV would use available resources to deal with a default of a member is:

- (i) margin funds from the defaulting participant;
- (ii) the defaulting participant's contribution to the Compensation Fund;
- (iii) the Reserve Fund;
- (iv) 20% of CCV's capital;
- (v) the remainder of the Compensation Fund; and
- (vi) the remainder of CCV's capital.

CCV has a credit line with a bank so that cash needs can be promptly met.

#### 4.2.1.6 Pricing

CCV charges participants a monthly fee that depends on the value of the cleared and settled transactions. CCV also charges participants an annual fee for the use of its IT infrastructure. CCV's fee schedule is published on its website.<sup>21</sup>

#### 4.2.1.7 Major ongoing and future projects

The most important project now under way focuses on strengthening CCV's risk management and default procedures. CCV has met with the CNBV and the central bank to discuss ways to improve these procedures.

## 4.2.2 ASIGNA

### 4.2.2.1 Institutional framework

ASIGNA Compensación y Liquidación (ASIGNA) is the CCP for all derivatives contracts traded on MEXDER. ASIGNA was established as a trust in 1998 to provide clearing and settlement services for futures and options contracts. ASIGNA is a subsidiary of BMV.

Mexican derivatives markets are not regulated by any specific legislation. The most important general legal provisions that apply to ASIGNA's services are (i) the "Mandatory rules for corporations and trust participating in the establishment and operation of a market for listed exchange futures and options", jointly issued by SHCP, CNBV and the central bank and (ii) the "Prudential regulations to which participants in the market for listed future and options should adhere in their operations", issued by the SHCP and the CNBV. ASIGNA is supervised by the CNBV.

ASIGNA operates under its Internal Rules and its Policies and Procedures Manual. This code defines all regulations and requirements (both financial and operational) for clearing members, the operating processes (recording, acceptance, clearing and settlement of transactions), margin requirements (initial and variations), default procedures and fees and commissions.

---

<sup>20</sup> Representing 12% of the previous month's average of participants' end-of-day margin requirements.

<sup>21</sup> [www.contraparte-central.com.mx](http://www.contraparte-central.com.mx).

ASIGNA is not subject to the Payment System Act, because its settlement volume is less than UDI 100 billion a month.

#### *4.2.2.2 Participation*

Only trusts administered by Mexican banks and authorised by SHCP for this purpose can directly participate in ASIGNA. Clearing members must comply with the operational and IT requirements stated in ASIGNA's rules.

Clearing members are either own-position clearing members, which clear and settle their own transactions, or third-party position clearing members, which clear and settle transactions on behalf of customers. At the end of 2009, ASIGNA had nine clearing members; four of them own-position clearing members and five third-party clearing members.

#### *4.2.2.3 Types of transactions*

ASIGNA acts as a central counterparty for futures and option contracts traded on MEXDER: futures on government bonds, interest rates (interbank interest rate – TIIE), foreign exchange (USD and EUR), stocks and the Mexican stock exchange index (IPC); and options on stocks, USD and futures on the IPC.

#### *4.2.2.4 Operation of the system*

ASIGNA operates from 07:30 to 15:00 (MEXDER's trading hours) every business day. Transactions traded on MEXDER are sent to ASIGNA on a real-time basis. ASIGNA uses novation to become the central counterparty to all accepted MEXDER transactions.

ASIGNA accepts and clears transactions and determines margin requirements on an intraday basis (see Section 4.2.2.5).

Contracts are marked to market at the end of each trading day and ASIGNA compensates losses and gains over all open contracts for each participant. Net balances must be paid in cash before 10:00 on the following day. This is also the deadline for participants' contributions to the default fund (known as the Clearing Fund, see Section 4.2.2.5).

When contracts expire, they may be settled in cash or through delivery of the underlying, as is the case for futures on fixed-rate bonds, futures and options on stocks, and futures on currency. ASIGNA has a procedure to guarantee the delivery of the underlying to participants for each type of contract.

#### *4.2.2.5 Risk management*

ASIGNA's risk management is based on margin requirements, initial margins for new contracts and variation margins for open contracts. The margin requirements are set to cover the expected change in prices for a single day with a 99% confidence level, using the Theoretical Intermarket Margin System (TIMS) methodology. ASIGNA determines margin requirements approximately every 20 minutes during operating hours.

ASIGNA accepts domestic currency cash deposits and/or Mexican securities to meet margin requirements. The Margin Fund is based on these contributions. Haircuts are applied to securities to protect against price fluctuations.

Third-party position clearing members can ask their customers for additional margin payments. These additional contributions depend on each customer's margin requirements and credit risk exposure. Clearing members manage these contributions and can use them in case of a customer default.

In addition to the Margin Fund, ASIGNA has access to two funds created to cover potential losses arising from a participant default:

- the Clearing Fund, which is based on domestic currency cash contributions from each participant.<sup>22</sup> This fund can be mutualised.
- the Members' Fund: own-position clearing members must maintain a fund of at least UDI 2.5 million or 4% of their margin requirements. Third-party position clearing members must maintain at least UDI 5 million or 8% of their margin requirements.

The order in which ASIGNA would use available resources to deal with a default of a participant is:

- (i) the defaulting participant's contribution to the Margin Fund;
- (ii) the defaulting participant's contribution to the Clearing Fund;
- (iii) the defaulting participant's contribution to the Members Fund;
- (iv) if the defaulting participant is a third-party position clearing member and if there is an own-position clearing member administered by the same bank as the defaulting participant, then the available resources from this own-position clearing member are also used (after and including steps (ii) and (iii)).
- (v) the remaining balance of the Clearing Fund; and
- (vi) ASIGNA's own resources, which amount to at least UDI 15 million.

#### 4.2.2.6 Pricing

ASIGNA charges the following fees:

- A clearing and settlement fee that depends on the number, type and underlying of contracts cleared. For clearing member transactions the fee is approximately half of the one applicable to its customers. This fee ranges from MXN 0.33 to MXN 60 for futures contracts, and from MXN 0.07 to MXN 9 for options contracts.
- A delivery fee to cover the cost of cash and securities transfers involved in the delivery processes. For a domestic currency cash transfer the fee is MXN 80 (futures on USD) and MXN 120 (futures on Mexican government bonds), for a USD cash transfer it is USD 25 and for securities transfers (through the Mexican CSD INDEVAL) the charge is MXN 12.
- An exercise and assignment fee, for each stock option exercised or assigned. Currently this fee is MXN 2.

ASIGNA collects fees and commissions at the beginning of each month.

#### 4.2.1.7 Major ongoing and future projects

If MEXDER's plans to include OTC contracts materialise, ASIGNA will offer clearing services for these new MEXDER-traded products.

ASIGNA plans to replace its IT platform in the medium term.

---

<sup>22</sup> Maximum of (i) MXN 100,000; (ii) 10% of the previous month average of participants' end-of-day margin requirements; (iii) 10% of the participants' end-of-last-trading-day margin requirements.

### 4.3 Securities settlement systems

#### 4.3.1 DALI

##### 4.3.1.1 Institutional framework

The Institución para el depósito de valores (INDEVAL) is Mexico's sole CSD. It is licenced by the SHCP to provide custody, clearing, and settlement services. INDEVAL started operations in 1978 as a government agency and became a private entity in 1982. DALI, which has been operating since November 2008, is a SSS owned and operated by INDEVAL.

The Securities Market Act (SMA) regulates INDEVAL's activities and its governance arrangements. INDEVAL is currently owned by 39 banks and broker-dealers, BMV, and the central bank. Each shareholder has one share, and all shares have the same rights. The institution's board of directors has 14 members. The SMA mandates that both the central bank and SHCP have a seat on INDEVAL's board. A group of broker-dealers and banks has controlling interests in both INDEVAL and BMV. INDEVAL's directors are appointed each year at a shareholder meeting.

As DALI is a systemically important payment system under the Payment Systems Act, transactions settled through this system are final.<sup>23</sup> INDEVAL's rules and procedures are set out in its operating rules.

INDEVAL is regulated jointly by CNVB and the central bank. SHCP can revoke the INDEVAL's concession to operate as a CSD.

The Notes and Credit Transactions General Act and the Commercial Entities General Act require that all debt securities and equities issued in Mexico are evidenced by signed paper certificates. INDEVAL provides a custodial service for all certificates relating to bonds issued by banks and firms, and most of those relating to equities. Certificates for bonds issued by the Federal Government are held at the central bank. INDEVAL therefore holds securities on an immobilised but not on a dematerialised basis.

##### 4.3.1.2 Participation

Both domestic and foreign financial entities are allowed to participate directly in DALI. All participants in DALI must fulfil certain technical requirements. The main participants in DALI are banks, broker-dealers, CCV (the CCP for all equities traded on BMV) and the central bank. At the end of 2009, INDEVAL had 106 domestic and four<sup>24</sup> foreign direct participants.

##### 4.3.1.3 Types of transactions

DALI settles all kinds of operations with Mexican securities, which include government and private bonds, and equities. DALI also settles operations with foreign securities, mainly equities, and ETFs held in sub-custody by INDEVAL. INDEVAL also provides sub-custody services through global custody banks and international central securities depositories (ICSDs). In addition, DALI provides securities lending and borrowing services as well as tri-party repo services.

##### 4.3.1.4 Operation of the system

DALI operates from 07:46 to 16:15 every business day. DALI offers participants two access mechanisms: INDEVAL Financial Protocol and Portal DALI. INDEVAL Financial Protocol was

---

<sup>23</sup> Details on finality in DALI are described in Section 4.3.1.4.

<sup>24</sup> One CSD and three banks.

designed for computer-to-computer communications (H2H). Based on the ISO 15022 message format, this protocol supports straight through processing to reduce costs and operational risks. Portal DALI is a web interface that enables depositors to access DALI services from their browsers. All instructions to DALI bear a digital signature, based on a public key infrastructure. All settlement advices sent by DALI also bear a digital signature.

DALI settles most money market trades on the trade day. DALI uses a liquidity-saving clearing model and settles transactions on a DVP, near real-time basis. The system maintains a queue of pending trades and chooses at frequent intervals<sup>25</sup> the highest-value set of transactions that can be cleared and settled with the available cash and securities balances. Transactions that cannot be settled immediately are queued for later settlement. Settlement is final when DALI sends its depositors a settlement advice with the debits and credits in their accounts.

#### 4.3.1.5 Risk management

As the netting scheme in DALI generates no overdrafts in participants' accounts, DALI does not extend credit to its depositors and thus faces no credit risk from the settlement process. DALI participants have a domestic currency cash account in the system to settle payments generated by transactions. DALI has an account in SPEI, and DALI participants make payments in SPEI to DALI to fund their accounts. Balances in the DALI cash accounts are at all times fully backed by deposits in central bank money in SPEI. DALI uses an optimal clearing procedure that, at least every two minutes, determines the transactions that can be settled with the available participants' balances in cash and securities. Some transactions may be settled only partially.

DALI's liquidity-saving model significantly reduces liquidity risk, and near real-time settlement avoids end-of-day risk concentration.

#### 4.3.1.6 Links to other systems

Any party with a bank account can credit any DALI participant's cash account through SPEI. DALI participants can also transfer balances from their DALI cash account to any SPEI account and, through it, to any bank account in Mexico.

When DALI closes at the end of the day, all cash balances are automatically transferred to predefined accounts. If a DALI participant is also a participant in SPEI, the predefined account generally is its SPEI account. In other cases, the predefined account is a bank account.

#### 4.3.1.7 Pricing

Each month, participants pay fees of two principal types: one levied on the value of the securities they hold at INDEVAL and another based on the number of transactions settled. For debt securities (including Federal Government securities) the monthly fee ranges from 0.00014% to 0.000075% of the average value in that month; while for equities it is between 0.00058% and 0.00017% of the average value. Custody fees for INDEVAL shareholders are rated at 50% of the fees paid by other participants. Transaction fees depend on the role of the participant in the transaction: whether it is transferring securities or making a payment, and also on whether it uses H2H or Portal DALI to access the system (see Section 4.3.1.4). The fee for H2H transactions is half that for Portal DALI transactions. This arrangement has a twofold purpose, to reflect the actual costs of these two services in INDEVAL's fees, and to promote STP. The H2H fee for domestic securities transfers between two accounts of the

---

<sup>25</sup> No later than two minutes after receiving a new instruction.

same participant is MXN 8 per transaction, if the securities transfer is between the accounts of two different participants the fee is MXN 12. The H2H fee for a payment transaction is MXN 2.

For cross-border securities transactions, participants pay custody and transaction fees that are based on the fees that INDEVAL pays to the respective global custodian or ICSD. Changes in INDEVAL's fees require the approval of CNBV and the central bank.

#### *4.3.1.8 Major ongoing and future projects*

INDEVAL has started work on two major projects, a trade repository for OTC derivatives and a CCP for debt securities.

## **4.4 Use of securities infrastructure by the Bank of Mexico**

The central bank is a direct participant in DALI for the following activities: First, the central bank is the financial agent of the Federal Government and the payment agent for securities issued by the Federal Government. Second, the central bank holds the physical certificates that back Federal Government securities while INDEVAL manages the custody of these securities through its book entry system.

Transactions in the primary and secondary market are settled through DALI. The central bank acts as agent in DALI to pay interest on Federal Government securities and to redeem these securities. At the end of 2009, Federal Government securities worth MXN 2.7 trillion were outstanding.

The central bank also acts as the issuing and paying agent for securities issued by the Mexican deposit insurer, IPAB, and for central bank bonds.

SHCP provides a securities lending programme for banks and broker-dealers that act as market-makers for Federal Government securities. At the end of 2009, there were eight market-makers appointed by SHCP. The securities lending programme is jointly operated by INDEVAL and the central bank.

The central bank provides liquidity to banks with a view to (i) regulating the supply of money in the market (monetary policy implementation); (ii) giving support to banks with liquidity needs (discount window); and (iii) promoting the smooth functioning of the payment system. In its monetary policy implementation and in the discount window facility, the central bank provides banks with liquidity through repo transactions. To participate, banks transfer securities to the central bank's securities account in DALI. For its part, the central bank registers a repo in its books and delivers cash to the banks' current accounts at the central bank. To provide liquidity to the payment system, the central bank accepts same-day repo operations with banks and sends instructions to DALI to settle these repos. To use this facility, banks must give DALI a standing instruction to grant the central bank access to their accounts (see Section 1.2.2).





**Payment, clearing and  
settlement systems in  
Russia**



## Contents

List of abbreviations.....	285
Introduction.....	287
1. Institutional aspects.....	288
1.1 The general institutional framework .....	288
1.1.1 The legal framework .....	288
1.1.2 Providers of payment services.....	290
1.2 The role of the Bank of Russia.....	293
1.2.1 Organisation of cash circulation.....	293
1.2.2 Organisation of non-cash payments .....	294
1.2.3 Standing liquidity facility.....	295
1.2.4 Operator.....	295
1.2.5 Oversight.....	295
1.2.6 Catalyst role of the Bank of Russia.....	296
1.3 The role of other private and public sector bodies .....	297
1.3.1 Federal Treasury.....	297
1.3.2 Russian banking associations.....	298
1.3.3 Federal Financial Markets Service (FFMS) .....	299
1.3.4 Stock exchanges.....	299
1.3.5 Depositories.....	300
2. Payment media used by non-banks .....	300
2.1 Cash payments .....	300
2.2 Non-cash payments .....	301
2.2.1 Credit transfers .....	301
2.2.2 Direct debits.....	302
2.2.3 Cheques.....	303
2.2.4 Payment cards.....	303
2.2.5 E-money.....	305
2.2.6 Other payment instruments.....	305
3. Funds transfer systems .....	305
3.1 Large-value payment systems .....	305
The Bank of Russia Payment System (BRPS) .....	305
3.1.1 VER and MER systems .....	307
3.1.2 BESP system.....	311
3.1.3 Payment system using letters of advice.....	315

4.	Systems for post-trade processing, clearing and securities settlement.....	316
4.1	General overview .....	316
4.2	Post-trade processing system .....	317
4.3	Central counterparties and clearing systems .....	318
	4.3.1 Moscow Interbank Currency Exchange (MICEX).....	318
	4.3.2 The RTS Clearing Centre.....	320
4.4	Securities settlement systems.....	321
	4.4.1 The National Settlement Depository .....	321
	4.4.2 The Depository Clearing Company .....	323
4.5	Use of securities infrastructure by the central bank.....	324

## List of abbreviations

AP	Associated Participant
ARB	Association of Russian Banks
ATM	Automated Teller Machine
BESP System	Banking Electronic Speedy Payment System
BIC	Bank Identification Code
BoR	Bank of Russia
BRPS	Bank of Russia Payment System
CC	Clearing Chamber
CCP	Central Counterparty
CIS	Commonwealth of Independent States
CJSC	Closed Joint Stock Company
CPSS	Committee on Payment and Settlement Systems
DCC	Depository Clearing Company
DP	Direct Participant
DVP	Delivery versus Payment
EPM	Electronic Payment Message
EurAsEC	Eurasian Economic Community
FFMS	Federal Financial Markets Service
FSUE	Federal State Unitary Enterprise
GKO	Government Short-term Zero-coupon Bond
GSM	Government Securities Market
IOSCO	International Organization of Securities Commissions
ISO	International Organization for Standardization
KOI	Collective Data Processing System
KTsOI	Easy-access Collective Data Processing Centres
MER	System for Interregional Electronic Payments
MICEX	Moscow Interbank Currency Exchange
MoF	Ministry of Finance of the Russian Federation
MSE	Moscow Stock Exchange
NAMEX	National Mercantile Exchange
NCI	Non-bank credit institution
NP	Non-for-profit Partnership
NSD	National Settlement Depository
OFZ	Federal-loan Bond

*Russia*

OJSC	Open Joint Stock Company
OTC	Over-the-counter
POS	Point of Sale
RTGS	Real-time Gross Settlement
RTS	Russian Trading System
SC	Settlement Chamber
SDC	Settlement Depository Company
SE	Stock Exchange
SP	Special Participant
SPBEX	St Petersburg Exchange
SPCEX	St Petersburg Currency Exchange
SPRS	Single Postal Remittances System
SVK	Customer Interaction Interface
SWIFT	Society for Worldwide Interbank Financial Telecommunication
TSER	Electronic Settlement Transport System
VER	System for Intraregional Electronic Payments

## Introduction

Russia's financial market infrastructures (FMIs) have evolved rapidly in response to economic growth, technical innovation and regulatory initiatives. These changes will increase the Russian payment system's efficiency and bring it into line with international standards.

The Russian payment system comprises the Bank of Russia payment system (BRPS) and other payment systems operated mainly by credit institutions.

The BRPS comprises the system for intraregional electronic payments (VER), the system for interregional electronic payments (MER), the Banking Electronic Speedy Payment system (BESP system), and a payment system based on letters of advice.

The most significant recent development was the creation of the BESP payment system within the BRPS framework. Introduced at the end of 2007, the BESP system provides nationwide settlement on a real-time gross settlement (RTGS) basis for both urgent interbank payments and the non-urgent payments of non-bank institutions.

The banking system plays a key role in supporting the national payment system as it provides the main channel for payment transactions in the economy. Credit institutions provide clients with various payment instruments and services by executing payments through the BRPS and through correspondent accounts opened with each other or in their own interbranch networks.

Non-cash payment instruments include credit transfers, direct debits, cheques, payment cards and e-money. The main payment instruments are credit transfers, by which the bulk of payments are executed.

A significant trend is the increasing use of payment cards. The national payment card market consists mainly of international card payment schemes, with some Russian participants. The volume of transactions has grown strongly in recent years, while average transaction values have remained modest. Internet banking and mobile payment services are also being widely implemented.

The dynamically developing payments market has brought new players onto the stage in recent years. Besides credit institutions and the Russian Post, which have traditionally provided payment services, non-bank providers have entered the market as agents, supplying new infrastructure services and offering innovative payment instruments to consumers.

Two main groups provide trade, clearing and settlement services on the Russian securities market: the Moscow Interbank Currency Exchange Group (MICEX Group) and the Russian Trading System Group (RTS Group). The infrastructure is being improved to provide faster and more secure post-trade services. The MICEX Group has been reorganised to develop an integrated infrastructure. Moreover, a National Settlement Depository (NSD) that combines settlement and depository activities was created.

The BRPS aims at effective integration with other national financial market infrastructures to promote their efficiency and settlement security.

The development of the country's payment system requires a sound legal framework, which is a key priority for the Bank of Russia. A new federal law "On the national payment system", drafted by the Ministry of Finance of the Russian Federation and the Bank of Russia, was adopted in June 2011. The act regulates different types of payment operators, payment systems and infrastructures, and mandates the Bank of Russia to supervise and oversee the national payment systems.



## 1. Institutional aspects

### 1.1 The general institutional framework

#### 1.1.1 The legal framework

The payment system of Russia is governed by the Civil Code of the Russian Federation as well as by various federal laws, in particular those applying to:

- the Central Bank of the Russian Federation (Bank of Russia);
- banks and banking activity; and
- the postal service.

The payment system is also subject to the regulations of the Bank of Russia.

The **Civil Code of the Russian Federation** sets out the key norms that regulate cash and non-cash payments. It establishes that payments between legal entities, as well as between individuals, can be effected with cash or with non-cash instruments. The Civil Code also defines the terms of agreements on bank deposits and bank accounts,<sup>1</sup> which include queuing of funds withdrawals in the event of insufficient funds on the account to satisfy all claims (priority of execution depending on the purpose of payment),<sup>2</sup> the timing of operations through the account, payment instruments and the responsibilities of payment system participants. The Civil Code stipulates that a credit institution is obliged to transfer funds from a customer's account and to credit funds to a customer's account not later than the day after it receives the relevant payment document (T+1).<sup>3</sup> A shorter term can be defined individually in the contract between credit institution and account holder.

The **federal law "On the Central Bank of the Russian Federation (Bank of Russia)"** establishes the objectives, functions and authority of the Bank of Russia (BoR) with respect to payment systems and funds transfers related to the settlement of trades on Russian securities markets. The law prescribes that the total time for execution of non-cash payments must not exceed two business days for intraregional payments,<sup>4</sup> and five business days for interregional payments.

The **federal law "On banks and banking activity"** regulates the activities of credit institutions in Russia, determines their legal status, establishes the rules for their registration,

---

<sup>1</sup> The *bank account agreement* governs the account relationship between a bank and an account holder. According to a bank account agreement the bank accepts funds on holders' accounts and executes account operations on their instructions.

The *bank deposit agreement* is a legal relationship concerning the placement and repayment of funds. According to a bank deposit agreement, the bank accepts a deposit and is obliged to return it on the due date (or on demand) and to pay interest as specified in the agreement. At the same time, the rules of a bank account agreement generally apply to the relations between bank and depositor concerning the account on which the deposit was placed.

<sup>2</sup> Payments of public importance take priority (eg payments of alimony claims, salaries etc).

<sup>3</sup> The *payment document* is a specific term used in Russian legislation to refer to a payment instruction instrument used to effect payment transactions. A payment document can be presented to a payment services provider on paper as well as electronically (see Section 2.2). In this report, the term "payment document" is used exclusively with this meaning.

<sup>4</sup> The Russian Federation comprises national republics, territories, regions, cities of federal importance, an autonomous region, and autonomous areas. All these entities are referred to as "regions" in this report. In certain cases, a "region" may include several constituent entities of the Russian Federation.

and defines the list of operations that only credit institutions licensed by the BoR can carry out, as well as the list of other activities that credit institutions may carry out.

In 2010, the **federal law “On payment agents’ activity concerning reception of payments from individuals”** and related legislative amendments came into effect. This federal law provides the legal basis for the development of agent schemes for receiving payments from individuals through payment agents and bank payment agents (see Section 1.1.2.3).

Rules and procedures for operations using cash and non-cash means of payment in payment systems are defined by the regulations of the BoR, while agreements between participants and the payment system operators govern the responsibilities of the payment system participants.

To create a comprehensive, up-to-date legal basis for the national payment system, the Ministry of Finance (MoF) and the BoR have jointly drafted the **federal law “On the national payment system”**. The main objective is to establish a legal framework for the functioning of the national payment system based on common principles. The law was signed by the President of the Russian Federation and officially published on 30 June 2011. It will come into force after 90 days (except for certain provisions for which other terms are established).

The key provisions of the law include:

- Definition of e-money and procedures for its transfer, as well as requirements for credit institutions (e-money operators) concerning e-money transfers.
- Establishment of procedures for interaction between mobile phone companies and e-money operators.
- Establishment of procedures for registration of payment system operators for supervision purposes.
- Definition of important (systemically important and important to the public) payment systems and additional requirements for such systems.
- Establishment of requirements for the payment system infrastructure.
- Establishment of requirements for risk management systems within payment systems.
- Establishment of procedures for supervision of the national payment system, authorising the BoR to monitor payment system and infrastructure operators.
- Establishment of procedures for the oversight of the national payment system with a focus on the important payment systems.

The laws, regulations and contractual provisions that constitute the legal framework for the BRPS set out the rights and obligations of each party involved in transferring funds via the BRPS. The procedure for effecting payments through the BRPS is defined by the BoR’s regulations on the basis of the Civil Code and federal laws. The BoR’s regulations define such terms as irrevocability and finality of payment,<sup>5</sup> and provide for the use of a collateral mechanism in providing secured loans and the crediting of an account for carrying out payments in the BRPS. The BoR’s regulations also determine payment instruments and their formats, the procedures in the BESP system, the procedure for processing cycles and continuous processing of payments in the Moscow Region, the rules for the exchange of electronic messages between the BoR and its customers and the procedure for effecting electronic payments and settlements using letters of advice (see also Section 3.1.3).

---

<sup>5</sup> For a definition of irrevocability and finality see Sections 3.1.1.4 and 3.1.2.5.

The BoR's regulations provide the detailed part of the legal framework for payments and are compulsory for all payment systems. The relationships between the BoR and credit institutions and other customers that relate to settlement operations through the BRPS are regulated by standards, correspondent account contracts and electronic message exchange agreements.

The contracts between the BoR and its customers comply with civil legislation and should not in principle stand at variance with federal standards and subordinate legislation. However, according to the principle of freedom of contract established in the Civil Code, contracts may include provisions that are not stipulated by legislation.

## **1.1.2 Providers of payment services**

### *1.1.2.1 Credit institutions*

According to the Civil Code of the Russian Federation, non-cash payments must be effected through credit institutions.

A credit institution is a legal entity with the right to carry out banking operations as a profit-making entity as defined in the federal law "On banks and banking activity".

The activity of credit institutions is considered legal only if they have a licence granted by the BoR. The licence specifies the banking operations that the credit institution can execute. Credit institutions are not allowed to engage in industrial production, commercial trade or insurance activities.

There are two types of credit institutions: banks and non-bank credit institutions (NCIs). The key distinguishing feature of banks is that only they are allowed to carry out the following banking operations: to accept deposits (sight and time) from individuals and legal entities; to use deposited funds in their own name and for their own account; and to open and maintain bank accounts for individuals and legal entities. NCIs can execute certain banking operations, as may be determined by the BoR. The majority of NCIs in Russia specialise in effecting payments and act as settlement banks in securities markets. These NCIs are defined by the BoR as "settlement NCIs".<sup>6</sup> Other NCIs specialise in carrying out certain kinds of deposit and credit operation and do not have the right to act as settlement banks.

According to the federal law "On banks and banking activity", all banking operations and deals are effected in rubles. A bank can only carry out banking business in a foreign currency if appropriately licenced to do so by the BoR.

At the end of 2009 there were 1,058 credit institutions in Russia, including 1,007 banks and 51 NCIs, of which 47 were settlement NCIs. The credit institutions had 3,183 branches and 37,547 sub-branches. The registered authorised capital of operating credit institutions was 1,244.4 billion rubles.<sup>7</sup>

At the end of 2009 there were 226 credit institutions in Russia with foreign shareholdings. Of these, 82 had 100% of their authorised capital held by non-residents, and 26 were 50–99% held by non-residents.

### *Banks*

Banks are licenced to conduct banking operations by the BoR. The federal law "On banks and banking activity" stipulates that the following activities require a licence from the BoR:

---

<sup>6</sup> The term is established in the BoR's regulations.

<sup>7</sup> Exchange rate RUB/USD at end-2009: 30.2442.

- deposit-taking from individuals and other legal entities;
- the use of deposited funds in the institution's own name or for its own account;
- the opening and maintenance of bank accounts for individuals and other legal entities;
- making payments across their accounts to the order of individuals and legal entities, including correspondent banks;
- collecting funds, bills of exchange, payment documents and providing cash services for individuals and legal entities;
- buying and selling foreign currency in cash or non-cash;
- accepting and placing deposits in precious metals;
- issuing bank guarantees; and
- transferring funds to the order of individuals who are not in account with the bank concerned.

In addition, banks may manage assets under trust relationships with individuals and other legal entities, as well as conduct transactions in precious metals and precious stones, rent out special premises and safes for storing documents and valuables to individuals and other legal entities, engage in leasing operations, and provide consulting and information services etc. These activities do not require a licence from the BoR.

Banks can make payments through the BRPS via correspondent accounts; through accounts with settlement NCIs; and through accounts within their own interbranch network. The opening of correspondent accounts and execution of payment operations across such accounts are regulated by provisions within legislation and the BoR's regulations, and by bilateral agreements between credit institutions. The procedure for conducting interbranch payments is independently set out in the internal rules of a credit institution and subject to compliance with BoR requirements.

#### *Settlement NCIs*

Settlement NCIs are authorised by the BoR to carry out the following banking operations in domestic and foreign currencies:

- opening and maintaining bank accounts for legal entities;
- effecting payments for legal entities, including correspondent banks;
- collecting funds, bills of exchange, payment documents and providing cash servicing for legal entities;
- buying and selling foreign currency in non-cash form; and
- transferring funds for individuals without bank accounts at the institution concerned.

Given the settlement NCIs' focus on maintaining customers' accounts and effecting payments, the BoR has restricted them (unlike banks) in the use of their own funds and those of customers to make investments on their own behalf and for their own account. However, settlement NCIs are authorised to provide credit to settlement participants for completion of settlement using funds set up by settlement participants for this purpose.<sup>8</sup>

---

<sup>8</sup> The BoR requires settlement NCIs to establish a liquidity maintenance fund based on contributions from settlement participants. The fund provides credit for the completion of settlements on terms of up to three days. The use of money from the fund is regulated by the agreement "On establishing of liquidity maintenance

### 1.1.2.2 Russian Post

The Russian Post, a federal state unitary enterprise, operates the federal postal service. It has a wide network of post offices.

Together with postal services, the Russian Post offers a wide range of financial and telecommunication services. Postal remittances are one of the most important of these financial services.

Prior to 1997, postal remittances were executed by mail or cable transfer. Electronic remittances, via the internet and other channels, have been available since 1997, with data security assured by encryption and the use of electronic signatures.

In 2002, the Single Postal Remittances System (SPRS) was launched by a federal programme that aimed to promote the development of electronic remittances. At present, almost all postal remittances are processed by the SPRS,<sup>9</sup> which covers more than 40,000 postal service branches and includes 16,000 network terminals and 1,600 intermediate centre terminals.<sup>10</sup> Electronic remittances can be completed in no more than 72 hours, from payment execution to delivery. The service is used for a wide variety of transactions, including loan repayments and payments for goods and services.

The Russian Post plans to introduce addressless transmission of funds so that remittances can be received in any post office connected to the service. Another new product will be a so-called urgent remittance with delivery guaranteed at any destination post office within one hour.

### 1.1.2.3 Payment agents and bank payment agents<sup>11</sup>

Payment agents and bank payment agents have become increasingly prominent within the retail payment services market in recent years. Such agents allow individuals to pay for goods and services quickly via payment terminals<sup>12</sup> and ATMs without the need to visit a bank or pay a supplier directly in cash.

A customer settles a bill for goods and services by paying over cash or using a payment card at any agent's receiving point – which can be either a self-service payment terminal or the branch of a payment agent, such as a shop, kiosk or office, where a cashier can accept a cash payment and payment instruction for the bill and issue a receipt. The funds are then transferred to the payment agent's account with a credit institution. Settlement is effected either through accounts within the same credit institution or via correspondent accounts held with the BoR or other credit institutions.

---

funds" which stipulates that settlement participants are jointly responsible to the settlement NCI for the repayment of such credit.

<sup>9</sup> Together with the Russian Post, banks and remittance systems (Western Union, MoneyGram etc) also have licenses to offer remittance services through the SPRS.

<sup>10</sup> A *network terminal* is a secure postal terminal providing receipt and delivery of remittances, while an *intermediate centre terminal* converts paper documents into electronic documents and vice versa.

<sup>11</sup> A *payment agent* is a legal entity or individual authorised to accept payments from customers on behalf of suppliers of goods and services on the basis of agreements concluded with the suppliers. A *bank payment agent* is a legal entity or individual who receives payments from individuals and carries out certain other activities on behalf of a credit institution. A bank payment agent is not a branch of a credit institution.

<sup>12</sup> A payment terminal of a (bank) payment agent is not an ATM but a self-service device that accepts cash payments but cannot be used to withdraw cash. Payment terminals of bank payment agents can accept payment cards.

At present, the infrastructure of payment agents and bank payment agents covers most regions of the Russian Federation. Their payment terminals are widespread at retail points of sales, around subway stations etc.

Payment agents and bank payment agents receive payments from individuals for goods and services, as well as payments addressed to state bodies, local self-governing bodies and non-profit institutions controlled by the government. Individuals can also use bank payment agents to pay money into their bank accounts, access payment card services and send instructions to credit institutions to make payments from one bank account to another.

When setting the terms of agreements, payment agents and bank payment agents are subject to the same requirements as those that govern payments, the use of bank accounts and cash registers, fees and legal liability.

## 1.2 The role of the Bank of Russia

The federal law “On the Central Bank of the Russian Federation (Bank of Russia)” makes the BoR responsible for the effective and smooth functioning of the payment system. To this end, the BoR establishes the rules for effecting payments in the Russian Federation; reserves the exclusive right to issue cash and organise its circulation; and defines the procedure for effecting payments with international organisations and foreign states as well as with legal entities and individuals. The BoR is the lender of last resort to credit institutions and provides them with refinancing facilities, and it carries out payments through its payment system.

The BoR system comprises its Head Office, regional branches, other branches known as “settlement cash centres”<sup>13</sup> and such other organisations as are necessary to carry out its activities. These organisations are located in all regions of the Russian Federation to ensure the coordination of the BoR’s activities. They play a vital role in effectively organising and regulating payments and settlements across the country’s nine time zones.

In the national republics of the Russian Federation, the BoR’s regional branches are called “national banks”, and in all other regions they are called “main branches”. The BoR’s regional branches do not have a separate legal personality or make decisions of a regulatory nature.

At the end of 2009, there were 79 regional branches, 78 head settlement cash centres and 552 settlement cash centres in Russia.

### 1.2.1 Organisation of cash circulation

The official currency unit of the Russian Federation is the ruble. One ruble comprises 100 kopecks.

The BoR has the sole authority to issue cash (banknotes and coins), approve its denominations and design, organise its circulation and withdraw it from circulation. Its banknotes and coins are the Russian Federation’s sole legal tender. The BoR implements anti-counterfeiting measures, and develops new preventive features for banknotes and coins.

In accordance with legislation, and to discourage the excessive use of cash, the BoR has set a ceiling on the size of cash payments between legal entities, between a legal entity and a

---

<sup>13</sup> A *settlement cash centre* is the organisational unit of the BoR’s payment network that supports the opening of bank accounts for customers, and compiles and transmits electronic messages to the BoR’s authorised branches. It can also, as required, collect paper-based payment documents from customers and convert them into electronic form, provide cash services to customers and execute payments using letters of advice. Each national bank and main branch has settlement cash centres, one of which acts as the head settlement cash centre.

sole proprietor, and between sole proprietors. No cash payment under a single contract between such parties may exceed 100,000 rubles. There are no such restrictions for individuals.

To support cash circulation in the Russian Federation, the BoR:

- plans and organises the production, transportation and storage of banknotes and coins and the creation of the associated reserve funds;
- sets rules on the safekeeping, transportation and collection of cash for credit institutions;
- sets the criteria for accepting banknotes and coins, and procedures for destroying banknotes and coins, as well as for exchanging damaged banknotes and coins; and
- sets the rules for conducting cash operations.

The BoR monitors cash money turnover and changes in its structure, analyses the breakdown of banknote and coin denominations in circulation with regard to the needs of the economy, tracks the lifespan of different denominations of banknotes and coins, calculates banknote requirements by denomination and region, and plans the manufacture of banknotes and coins.

At the end of 2009, the following banknotes and coins of the BoR's 1997 design were in circulation: seven denominations of banknotes (five, 10, 50, 100, 500, 1,000 and 5,000 rubles) and eight denominations of coins (one, five, 10 and 50 kopecks and one, two, five and 10 rubles).

### **1.2.2 Organisation of non-cash payments**

According to the federal law "On the Central Bank of the Russian Federation (Bank of Russia)", the BoR coordinates and regulates the organisation of payments and funds transfers related to settlements on the Russian securities market.<sup>14</sup> The BoR establishes rules, instruments, timing and standards for effecting non-cash payments and monitors the payment activities of credit institutions on the basis of statistical reports.

Non-cash payments in the Russian Federation are effected in both national currency (rubles) and foreign currency (where permitted by federal law).

The BoR provides payment services to credit institutions and other legal entities as specified in the law.

The above law also empowers the BoR to carry out banking operations for state bodies and local self-governing bodies and their organisations, and state extra-budgetary funds,<sup>15</sup> military units, military servicemen, employees of the BoR and also other persons as specified by federal law. In addition, the BoR may provide services to customers that are not credit institutions in regions which lack credit institutions.

All credit institutions located in the Russian Federation and licenced by the BoR must open a correspondent account with its local branch of the BoR. It may also open a correspondent sub-account for its branch.

---

<sup>14</sup> In general the BoR regulates the cash leg of settlements on the securities market. The securities leg is regulated by the Federal Financial Markets Service (FFMS).

<sup>15</sup> The Pension Fund, the Social Insurance Fund, the Federal and Territorial Obligatory Medical Insurance Funds, Social Support Fund and the regional and local governments' extra-budgetary funds.

Other customers also have bank accounts with local branches of the BoR, which can be used for making payments (for more details see Section 3).

Each credit institution and branch of the BoR has a bank identification code (BIC), which identifies them as participants in the BRPS; the BIC must be used when completing payment documents and effecting transactions.

At the end of 2009, some 1,058 credit institutions, 2,253 branches of credit institutions and about 15,000 non-credit institutions were in account with the BoR.

### **1.2.3 Standing liquidity facility**

For the purpose of maintaining the money supply at a certain level, credit institutions must maintain reserve accounts with the BoR. Credit institutions that meet BoR criteria can use the required reserves averaging framework, which allows them to use required reserves as short-term liquidity, provided that the average balance of reserves during averaging period<sup>16</sup> is maintained at the required level. At present, the following ratios apply to average required reserves: 0.6 for all credit institutions excluding settlement NCI and 1.0 for settlement NCI. Thus, credit institutions may use from 60% to 100% of the total amount of required reserves.

The BoR also provides credit institutions with secured short-term liquidity for payment purposes by providing intraday and overnight credit on their correspondent accounts (sub-accounts) with the BoR. Credit institutions may redistribute their funds between different payment systems of the BRPS.

Other forms of credit provided by the BoR to credit institutions include lombard loans, loans secured by non-marketable assets and guarantees, unsecured loans<sup>17</sup> etc, as well as liquidity supplied through repo and currency swap operations.

### **1.2.4 Operator**

The BoR is the owner and operator of its own payment system. Software developed by the BoR and its infrastructure are designed to meet scalability and business continuity requirements.

The BoR monitors and controls its payment system on a day-to-day basis and plans for business continuity at all levels.

As the owner, regulator, manager, and supervisor of the payment system, the BoR takes appropriate steps to develop the system in line with the needs of the economy.

### **1.2.5 Oversight**

The BoR defines the key areas of its payment system oversight activities in accordance with international standards and best international and national practices.

The BoR's oversight activity covers all the institutional and infrastructural elements of the payment system, including large-value payment systems, retail payment systems, payment infrastructure and payment instruments. The main focus is on systemically important payment systems.

Oversight activities are coordinated through meetings and contacts with the representatives of Russian and international payment systems. A preliminary report on these payment

---

<sup>16</sup> The averaging period runs from the 10th day of each month to the 10th day of the following month (inclusive).

<sup>17</sup> In extraordinary circumstances. Since the end of November 2010, no unsecured lending has been outstanding to credit institutions.



systems,<sup>18</sup> conducted in 2010, assessed their compliance with the international standards developed by the CPSS and the International Organization of Securities Commissions (IOSCO).

The major priority is to create a legal framework which authorises the BoR to oversee all institutional and infrastructural elements of the Russian payment system. This project is part of a wider move to improve national payment system legislation. Such legislation would considerably extend the BoR's regulatory scope to include service operators with payments activities.

#### *Oversight of the Bank of Russia Payment System*

The law "On the Central Bank of the Russian Federation (Bank of Russia)" provides for oversight of the BRPS. This is implemented at two levels, reflecting the country's federal structure:

- at the federal level by the BoR department responsible for BRPS oversight; and
- at the regional level by regional branches of the BoR.

This two-level oversight reflects the BRPS's interconnected centralised and regional subsystems. Participants hold accounts in the appropriate branches of the BoR's network.

The BoR carries out its federal and regional BRPS oversight activities as follows:

- At the federal level the BoR oversees its payment system as a whole, setting the objectives and scope of oversight, as well as the methodology, procedures and tools. It has also implemented a uniform oversight methodology for the payment system's regional subsystems. The oversight of the BESP system is also conducted at a federal level.
- At the regional level the BoR implements the oversight methodology for the regional subsystem of its payment system.

BRPS oversight is based on data from the BoR regional branches and the various BRPS subsystems.

To improve the quality and timeliness of BRPS-related information, the BoR is building a centralised information analysis system for its payment system that will help identify payment system risks, assess the behaviour of individual participants, groups of participants and the system as a whole, and improve the response to critical situations.

#### **1.2.6 Catalyst role of the Bank of Russia**

The BoR acts as a catalyst, initiating and coordinating the process of making adjustments to the national payment system rules and procedures that enhance its stability and efficiency. The BoR also chairs or coordinates consultations and working groups<sup>19</sup> that advise on processes and standards for the national payment system. The BoR promotes the wider use of electronic documentation in the payments area through a special working group that includes credit institutions.

---

<sup>18</sup> The BoR does not yet have the legally established authority to oversee and regulate payment systems (including the collection of necessary information from these systems). Current oversight activity is therefore carried out with respect to payment systems that are of substantial importance to the Russian economy and that have voluntarily agreed to cooperate with the BoR.

<sup>19</sup> Typically such working groups include representatives of other regulatory bodies (MoF, FFMS), banking associations, organisations of financial market infrastructure, credit institutions etc.

The BoR pays close attention to the adoption of international standards in the domestic payment system. At the initiative of the BoR, a National Committee for Financial Services Standardization has been formed within the Federal Agency on Technical Regulating and Metrology with a view to participation in the International Organization for Standardization (ISO) Technical Committee 68 Financial Services. To conform as far as possible with international payment system standards, it is planned, in close cooperation with Russian financial market representatives, to develop a national standard for financial messages based on the ISO 20022 methodology.

The BoR also promotes the development of the retail payments market by monitoring, analysing and publishing reports and statistics. It also interacts with public authorities and the banking community. Moreover the BoR cooperates with the private sector, in particular with non-bank operators of retail payment services in order to improve their efficiency and security.

The BoR cooperates in the field of payment services development with other central banks, including those of Commonwealth of Independent States (CIS) and the Eurasian Economic Community (EurAsEC) countries as well as with international financial organisations.

### **1.3 The role of other private and public sector bodies**

#### **1.3.1 Federal Treasury**

The Federal Treasury of the Ministry of Finance of the Russian Federation (Federal Treasury) was created in 1992. It is legally mandated to ensure that the federal budget is implemented and to supervise operations with federal budget funds.

The BoR is legally obliged to maintain, free of charge, the accounts of the Federal Treasury and its regional offices (Federal Treasury offices). The value of transactions effected by the Federal Treasury offices makes up for a substantial part of the total value of the BoR's payments.

In 2009 the Federal Treasury offices accounted for about 88% of the volume of payments effected by the BoR across the accounts of its non-credit institution customers, and for 19% of the volume of payments effected by the BoR for all its customers. The value of payments conducted by the Federal Treasury offices through the BRPS in 2009 totalled 80% of the value of payments effected by the BoR across the accounts of its non-credit institution customers, and 13% of the value of payments effected by the BoR across the accounts of all its customers.

In 2009 the Federal Treasury and its 79 regional offices joined the BESP system (see Section 3.1) as associated participants, and they have actively used the BESP system since December 2009. As a result, the time taken to make and settle budget fund transactions between the Federal Treasury and its branches has been reduced to one minute.<sup>20</sup>

---

<sup>20</sup> Before the Federal Treasury joined the BESP system, payments took 2–5 days to settle depending on whether they were interregional or intraregional.

### **1.3.2 Russian banking associations**

#### *1.3.2.1 Association of Regional Banks (Association Russia)*

Association Russia was created in 1990 and became the first banking association in the country, initially comprising 44 banks. Now, more than 450 credit and other institutions in different regions of Russia are members of Association Russia.

The Association aims to develop and strengthen the banking sector by improving banks' capitalisation, creating economic and legal conditions to attract investment resources to the Russian banking system, ensuring fair competition and enhancing business efficiency.

Its most important function is to coordinate interests between regional banks, federal and regional administrative bodies, and the BoR, with a view to improving Russian banking and payment systems and services.

To these ends, the Association holds regular meetings with executives of the BoR and its regional branches, and organises advisory and coordinating councils as well as national and international forums and conferences on issues related to banking and payment activities.

At present, the Committee on Payment and Settlement System Development operates within Association Russia. It analyses Russian legislation and international practice concerning payment and settlement systems, and proposes improvements to payment system regulations. It also contributes to the development and implementation of international payment standards.

#### *1.3.2.2 Association of Russian Banks (ARB)*

The ARB was created in 1993. It is a private not-for-profit organisation that includes credit institutions and other financial institutions whose activities are related to the functioning of the Russian financial system.

The most important objectives of the ARB are:

- participation in the development of banking business in Russia;
- representation and assistance in protecting credit institutions' interests in legislative and executive bodies, the BoR, judicial, law enforcement, tax and other authorities;
- assistance to credit institutions in consolidating their resources for carrying out large-scale economic programmes;
- provision of organisational, information, analytical, methodical, legal and other assistance to credit institutions; and
- promotion of cooperation between Russian credit institutions and foreign banks, their unions and associations, and international financial organisations.

ARB includes about 80% of Russian banks that collectively hold more than 92% of the total banking capital of operating credit institutions and more than 93% of the total assets of the country's banking system. At present, ARB has 714 members, including 546 credit institutions.

ARB cooperates with the BoR on important issues of banking system development, as well as with regional banking associations and unions, and with the Russian regional banking community.

In 1997, ARB joined the EU's Banking Federation, which includes about 3,000 European banks.

ARB contributes to the development of the national payment system. The Committee on Payment Systems and Organisation of Settlements operates within the structure of ARB. Meetings held by the Committee with representatives of the BoR and credit institutions focus

on the development of draft regulation for Russian payment system activities, among other topics.

### **1.3.3 Federal Financial Markets Service (FFMS)**

FFMS is the federal executive body that formulates legislation on the financial markets, and controls and supervises financial markets (except for banking and audit activities). FFMS reports directly to the Government of the Russian Federation.

FFMS regulates securities markets by:

- establishing mandatory requirements for the activities of issuers and professional securities market participants, and for the standards that govern these activities;
- providing for the registration of securities issues and issue prospectuses, as well as monitoring and checking that issuers are in compliance with the terms and conditions of issues;
- licensing of the activities of professional securities market participants;
- establishing owners' rights protection and monitoring the observance of these rights by issuers and professional securities market participants; and
- preventing illegal or unlicensed activities in the securities market.

FFMS is a member of IOSCO.

### **1.3.4 Stock exchanges**

At present, there are four trading organisers in Russia (the Moscow Interbank Currency Exchange (MICEX), the St Petersburg Currency Exchange (SPCEX), the Russian Trading System Stock Exchange Non-for-Profit Partnership (NP RTS), and the Moscow Stock Exchange (MSE)), and four stock exchanges, two of which are located in Moscow (the MICEX Stock Exchange (MICEX SE) and the Russian Trading System Stock Exchange (RTS)), and two in St Petersburg (the St Petersburg Currency Exchange (SPCEX) and St Petersburg Exchange (SPBEX)).

According to the federal law "On the securities market", stock exchanges are market institutions that organise securities trading. Stock exchanges cannot combine securities trading with other kinds of professional activities in the securities market, with the exception of clearing activities (for a description of clearing and settlement services see Chapter 4).

Stock exchanges may be set up as not-for-profit partnerships or joint stock companies, and may only organise trading between their members. Other securities market participants can conduct their activities only through the intermediation of stock exchange members.

Any professional securities market participant that conducts activities specified in the federal law "On the securities market" may become a stock exchange member. The procedures for joining and leaving the stock exchange as well as for exclusion from the stock exchange are determined by the stock exchange independently, based on its internal regulations.

A wide range of Russian securities (government as well as corporate securities) and derivatives is traded on stock exchanges; only a minority is traded over the counter.

In 2009, the value of securities and derivatives trades executed on the major Russian trading platforms (MICEX, MICEX SE, RTS) amounted to more than 90 trillion rubles. The value of foreign currency trading on the organised foreign exchange market (MICEX Foreign Currency Exchange Market) was more than 96 trillion rubles.

### **1.3.5 Depositories**

The federal law “On the securities market” defines depository activity as the provision of custody services for securities certificates and/or the recording and transferring of rights over securities. A depository is a professional securities market participant that performs depository activity under the licence of the FFMS. Only a legal entity can be a depository.

The main aim of depositories is to ensure the rights of investors and shareholders for securities in the Russian Federation. This is achieved primarily by the immobilisation of securities certificates, in order to facilitate their circulation and eliminate the risks involved in their physical transfer from seller to buyer.

Depositories carry out the following main functions:

- accounting and custody of securities (securities certificates);
- recording information on the ownership rights to securities;
- ensuring the delivery of securities held in custody, from buyer to seller, by book entry across securities accounts;
- recording information on the obligations encumbered on securities, as accounted at the depository;
- physically issuing to the owners certificates of securities held in custody when they withdraw them;
- collection, state registration and storage of information received from the issuers of securities;
- receiving the securities income from the issuers, distribution and transfer to customers' cash accounts;
- redemption of securities; and
- cooperation with clearing and settlement systems to settle securities transactions.

In the stock market, depository services are provided by settlement depositories. Settlement depositories are the depositories that settle securities transactions executed at stock exchanges and/or other organisers of trading in the securities market.

At present, the Russian stock market (for certain securities segments) has developed a securities custody system consisting of two settlement depositories, namely, the National Settlement Depository (NSD), that mainly effects securities settlements at the MICEX SE, and the Depository Clearing Company (DCC), that mainly effects securities settlements at the RTS Stock Exchange. Other stock exchanges, which handle considerably lower trade volumes, cooperate with other settlement depositories (for details see also Chapter 4).

## **2. Payment media used by non-banks**

### **2.1 Cash payments**

The total amount of cash in circulation<sup>21</sup> at the end of 2009 was 4,629.7 billion rubles. Cash is one of the major payment means used for retail payments in the Russian Federation.

---

<sup>21</sup> Including cash held in vaults at the BoR and at credit institutions.

As a means of payment, cash is used in payments for retail sales of goods and services, as well as for salary payments, pensions, allowances and grants.

## 2.2 Non-cash payments

Non-cash payments in rubles between legal entities or involving individuals, must be effected in a legally permitted form.

Clients of credit institutions may choose any type of payment instrument or payment document. These are specified in agreements between credit institutions and their clients.

Non-cash payments are conducted through credit institutions (or their branches) and/or the BoR across accounts opened in accordance with the agreement on bank accounts (or the agreement on correspondent bank account/sub-account), unless the law or the payment instrument used stipulate otherwise.

Individuals may carry out non-cash payments across bank accounts or without opening an account.

The following payment documents are used to effect non-cash payments: payment orders, letters of credit, payment claims, collection orders and cheques. Funds transfers on behalf of individuals without a bank account are conducted through credit institutions by means of payment orders.

Payment instruments used in Russia include credit transfers, direct debits, cheques, payment cards and e-money.

### 2.2.1 Credit transfers

Paper-based credit transfers are initiated at a bank when a customer (or his representative) presents a payment document in paper form. Funds are transferred to the payee's bank by post or electronically as specified in the payment document. Credit transfer instructions can be executed electronically via special networks, the internet or mobile phone.

In 2009, some 2 billion credit transfers with a total value of 372.4 trillion rubles were effected in Russia. Although on the decline compared with the 2008 level, the share of credit transfers remained significant (at 54.3% of the total volume of transactions with payment instruments and 97.8% of their total value).

In 2009, internet and mobile payments accounted for 31.2% of the total volume of credit transfers through credit institutions and 37.0% of their total value. In recent years, mobile payments by individuals have grown significantly, increasing some 1.9 times in 2009 compared with the previous year. This has increased their share in the total volume of credit transfers effected by individuals from 3.7% to 9.7%. At the same time, their share in the total value of credit transfers effected by individuals remained insignificant, at 0.5% in 2009.

#### 2.2.1.1 Payments by payment order<sup>22</sup>

A payment order is the most widely used payment document in Russia. It is used to effect credit transfers. A payment order is an account holder's instruction to the bank to transfer a specified amount to the account of a payee opened with the same or another bank. Payment orders can be used for both one-time and recurring payments (standing orders). In the latter

---

<sup>22</sup> In this text, the term *payment order* is exclusively used to refer to a specific kind of payment document used in Russia for effecting of credit transfer transactions.

case, the payer instructs the bank to repeatedly execute a funds transfer to a given payee, for a set amount on a set series of dates.

In 2009, the share of such payments accounted for 58.1% of the total volume of credit transfers and 99.3% of their total value.

Payment orders can be used to remit funds for:

- delivery of goods, provision of services;
- federal, regional and municipal government budgets, and extra-budgetary funds;
- loan or interest repayments, and deposit placements; and
- other purposes as stipulated by agreement or legislation.

Funds transfers on behalf of individuals without a bank account are conducted by payment order on the basis of a payment document completed by the individual concerned. The form of the document is set by the credit institution involved or by the payee.

#### *2.2.1.2 Payments by letters of credit*

A credit institution makes payments under a letter of credit, or authorises another bank to make the payment, when the payee presents the documents specified by the payer within the letter of credit.

Letters of credit account for an insignificant share of non-cash payments, owing to the cumbersome nature of the payment process.<sup>23</sup>

### **2.2.2 Direct debits**

Payment claims and collection orders are used to collect payments by debiting the payer's account on the payer's initiative.

In 2009, the share of direct debits in the total volume and value of transactions with payment instruments was 3.6% and 0.6% respectively.

#### *2.2.2.1 Payments by payment claim*

A payment claim is a payment document comprising a demand by a creditor (payee) to a debtor (payer) to pay a set amount by debiting the payer's bank account on the basis of an agreement. Payment claims are used when payments are made for goods or services, or as stipulated by an agreement between a payer and a payee. They are usually used for recurring payments. The payee presents a payment claim to the payer directly, without the mediation of banks.

Payments by payment claim may be effected either with or without the payer's specific authorisation. In the latter case, the payer instructs the bank to pay all future payment claims from the specified payee without the need to obtain a separate authorisation for each individual payment document.

Payments by payment claim without specific authorisation are used where agreed by counterparties. The payer's bank must be authorised to withdraw funds from the payer's account without his specific instructions and be provided with appropriate information concerning the payee.

---

<sup>23</sup> The processing of letters of credit is both document- and labour-intensive.

In the case of payments that do require the payer's specific authorisation, the payer can instruct his bank to debit his account upon receipt of a payment claim either fully or partially, on a recurring or a one-time basis, or to refuse payment on grounds stipulated in the agreement between the counterparties.

#### 2.2.2.2 *Payments by collection order*

A collection order is a payment document under which funds are withdrawn from the payer's account without his approval, prior or otherwise.

Collection orders are used in cases:

- when an indisputable funds withdrawal procedure is established by law (eg for the withdrawal of funds by controlling bodies);<sup>24</sup>
- when a court ruling has established a right to withdraw funds; or<sup>25</sup>
- when agreed by counterparties<sup>26</sup> and the payer's bank has been authorised to withdraw funds from his account without his specific instructions (ie as in the case of payment claims without specific authorisation, as described above).

#### 2.2.3 **Cheques**

Procedures for the processing of cheques and their terms of use are regulated by the Civil Code as well as by other laws and banking rules.

Cheques issued by credit institutions are used to make non-cash payments.

Credit institutions are free to format cheques as they wish, provided that the cheque contains all the information stipulated by the Civil Code.

Cheques issued by credit institutions may be used for payments on the basis of agreements, concluded between credit institutions and customers, and interbank agreements on cheque payments. Rules for processing cheques are set by the credit institutions themselves. There is no central cheque clearing organisation in Russia.

Traditionally cheques are not widely used in Russia. Their share in the total volume and value of payments does not exceed 1%.

#### 2.2.4 **Payment cards**

The growth in non-cash payment instruments such as payment cards is one of the most important recent trends in the payment system's development.

At the end of 2009, some 700 credit institutions had issued and/or acquired payment cards in the Russian Federation. The number of payment cards issued by credit institutions at the end of 2009 totalled 124 million, up from 54.6 million at the end of 2005.

---

<sup>24</sup> State entities that can use collection orders to make compulsory withdrawals of funds from a payer's account include the Federal Tax Authority, State Pension Fund, State Social Insurance Fund and Federal Customs Authority. To ensure that funds are duly collected, such entities are entitled, in circumstances defined by law, to seize funds in a payer's account(s) by presenting a collection order for the relevant amount outstanding.

<sup>25</sup> That is, funds are withdrawn from the account (eg of a debtor) by court order. This is a different procedure to the one involved in the seizure of funds by a state entity.

<sup>26</sup> Typically, collection orders are used in this way to collect penalty payments for failure to comply with the terms of a contract.



Both Russian and international card payment schemes are active in the national market. The number of Russian card payment schemes has remained roughly constant over the past decade. At the end of 2009, there were about 60 Russian debit and credit card payment schemes, several times more than the number of international card payment schemes with cards issued and/or accepted in Russia.<sup>27</sup> However, international card payment schemes account for the largest share (in terms of the number of payment cards, number and value of payment card transactions etc) in the Russian market.

In 2009, 677.2 million payments by cards issued in Russia were made with a transaction value of 1.3 trillion rubles. This amounted to 18.0% of the total number and 0.3% of the total value of all payment instrument transactions. Card payments are settled according to the rules and settlement procedures of each card scheme. There are currently no regulations on interchange fees in the Russian debit and credit card market.

Debit cards are the most prevalent type of card in the Russian market, followed by credit cards and prepaid cards.<sup>28</sup>

#### *Debit cards*

Debit cards accounted for 91.6% of total cards issued at the end of 2009. Their dominant share is primarily due to the widespread use of payroll card programmes.<sup>29</sup>

#### *Credit cards*

The number of credit cards issued has started to grow rapidly as a result of banks' consumer lending programmes. At the end of 2009, credit cards accounted for 6.8% of the total number of cards issued.

#### *Prepaid cards*

The share of prepaid cards in the Russian payment card market remains insignificant, at 1.6% of total cards issued. Prepaid cards are used primarily to make low-value payments for goods and services (mobile communications, utilities etc) via the internet and mobile phones.

#### *ATMs and POS terminals*

Payment card infrastructure for non-cash payments and cash withdrawals has been actively expanded in recent years. At the end of 2009, there were 354,391 POS terminals and 92,530 ATMs in Russia, including 79,505 ATMs with a credit transfer function (compared with 140,096, 27,779 and 16,202, respectively, at the end of 2005).

Cash can generally be withdrawn from any ATM with any Visa and MasterCard credit or debit card. Cards of other international and national card systems are only accepted at certain ATMs. Some ATMs support a range of functions besides cash withdrawals, including payments for utility services, airtime for mobile phones, internet services and cable television subscriptions.

POS infrastructure in Russia is operated by commercial banks and processing companies that provide acquiring services for organisations that accept card payments for goods and services. Payments via the national card systems are usually regional (city/town) payments.

---

<sup>27</sup> Cards of the following international card payment schemes are issued in Russia: Visa, MasterCard, Diners Club, China UnionPay, American Express. Cards of the following international card payment schemes are accepted in Russia: MasterCard, Visa, American Express, Diners Club, Japan Credit Bureau, China UnionPay, Golden Cone, Great Wall International, Travelex.

<sup>28</sup> Cards with an e-money function.

<sup>29</sup> Employees are paid on their transaction accounts, which can be accessed with debit cards.

Merchants can accept all debit/credit cards of the international card systems on a single POS terminal, but some national card systems require a proprietary POS terminal.

“Cash back” at the POS is not yet offered in Russia and is not covered by the BoR’s regulations. Questionnaires have been sent to Russian banking associations and leading credit institutions to sound out market participants’ opinions on the provision of such a service.

### **2.2.5 E-money**

The active use of e-money in the Russian retail payment services market started several years ago, supported by advances in information and telecommunications technologies.

Two main models of e-money transfer are currently used in Russia:

- via prepaid cards issued by credit institutions;
- via PC software and telecommunication networks (including internet) supported by non-banks under various forms of contractual relationship with customers.

The adoption of the federal law “On the national payment system” has provided a legal basis for e-money regulation. According to the law, only credit institutions (including a new type of non-bank, non-deposit-taking credit institution that will be permitted to transfer funds including e-money) are liable for e-money payments. The law also establishes the procedure for e-money transfers, taking into account the features of the electronic payment instruments used.

### **2.2.6 Other payment instruments**

#### *2.2.6.1 Payments by bank order*

Since 2010, a credit institution may use a new kind of payment document – a bank order – for executing payments on a customer’s bank account or deposit account. Bank orders can be used in cases where the credit institution (or its branch) is the payer or the payee and the counterparty to the transaction is a customer.

Bank orders can be used to execute high-volume or recurring payments such as an identical credit transfer to or direct debit from a large number of customer accounts, eg interest payments or bank fees.

## **3. Funds transfer systems**

### **3.1 Large-value payment systems**

#### ***The Bank of Russia Payment System (BRPS)***

The BRPS is a systemically important payment system that plays a key role in the implementation of monetary and budgetary policy. It also plays a central part in settling payments by financial market participants, including most interbank payments.

In 2009, 942.9 million payments (555.6 million payments in 2005) with a value of 609.9 trillion rubles (194.0 trillion rubles in 2005) were made through BRPS. The total value of payments made through the BRPS was equivalent to 15.6 times Russia’s GDP in 2009.

The average daily volume of payments processed through the BRPS in 2009 was 3.8 million (2.2 million in 2005) and the average amount per transaction was 646.8 thousand rubles in 2009 (349.2 thousand rubles in 2005).

In 2009 about 99.8% of the total volume and 99.9% of the total value of payments made through the BRPS were effected electronically (99.1 and 97.9% respectively in 2005).

The BRPS is used for the settlement of both large-value and small-value payments; the BoR places no limit on the value of individual payments.

The BRPS must, by law, process free of charge all payments arising from federal, regional and municipal government budgets, as well as extra-budgetary funds.

The BRPS comprises the following payment systems, which differ by regional coverage, payment value, rules and daily settlement schedules, categories of participants and payment instruments, transaction speed, and technology:

- the systems for intraregional electronic payments (VER) and for interregional electronic payments (MER) (see Section 3.1.1);
- the Banking Electronic Speedy Payment system (BESP) (see Section 3.1.2); and
- the payment system using letters of advice (see Section 3.1.3).

The BRPS regional subsystem comprises the payment systems in each region (or group of regions), where payments are effected on a daily settlement schedule. Taking into account the existence of nine time zones in Russia, the schedules of regional subsystems are set in local time. Operating hours are usually from 9:00 to 18:00 local time. The BESP system (see Section 3.1.2) operates from 9:00 to 21:00 Moscow time.

The BRPS participants comprise the BoR's branches, credit institutions (or their branches), the Federal Treasury (or its regional offices) and other BoR customers other than credit institutions (ie state bodies and local self-governing bodies, state extra-budgetary funds etc).

To make payments through the BRPS, each customer must have a correspondent account (sub-account) with a regional BoR branch.

To identify BRPS participants, the BoR maintains the Bank Identification Code Directory (Russia's BIC directory), which details the BoR's branches and customers (name, location, payment system used etc). The directory does not include BoR's customers without banking licenses, details of which are recorded in directories kept on a decentralised basis at the regional level.

A separate directory within the BESP system gives details of system participants, including their form of participation and payment limits, if applicable.

Electronic access to the payment system is governed by an electronic document exchange agreement between the BoR and its customers that details the terms and conditions of participation, functional and technical requirements, information security obligations, and business continuity measures.

BRPS is supported on the BoR's own information and telecommunication infrastructure, mainly the collective data processing system (KOI), which comprises easy-access collective data processing centres (KTsOI), the electronic settlement transport system (TSER), which provides the communication channels and a network that supports BoR message transfer formats, and the BoR's customer interaction interface (SVK), comprising the hardware and software that support interaction with the BRPS. In some BRPS regional subsystems, information is processed locally (ie outside the KOI).

Security is assured by methodological, technical, organisational and software measures and protection facilities at all stages of data collection, processing, and storage. These are based on the software and hardware suites of each payment system's information security sub-system.

The BoR has established an information security standard for Russian banking system institutions that is mandatory for the BoR and recommended for all BoR customers participating in the BRPS.

### 3.1.1 VER and MER systems

Payments are processed in the VER and MER systems in compliance with applicable legislation, BoR's own regulations, and the terms of the agreements between the BoR and its customers.

#### *VER system*

The VER systems support electronic payments in the BRPS regional subsystems.

The technology and procedures for making intraregional electronic payments are established by the BoR's regional branches<sup>30</sup> and specified in the agreements between the BoR and its customers. Payments in the Moscow Region, which account for a large share of the total value of payments effected through the BRPS, are regulated by special BoR documentation. Payments are settled on a gross basis, using an offsetting mechanism, in runs that take place several times a day, and in real time between the runs.

In other VER systems, payments are executed by batch processing on a gross basis in close to real-time mode or in runs that take place several times a day. Schedules for intraregional electronic payments are set by the BoR's regional branches in local time, taking into account the BESP system schedule. The VER systems settle payments of the following payment documents: payment orders, payment claims and collection orders.

A total of 748.7 million payments with a value of 432.7 trillion rubles were effected through the VER systems in 2009 (464.3 million payments with a value of 153.8 trillion rubles in 2005). They accounted for 79.4% of the total volume and 70.9% of the total value of payments effected through the BRPS (83.6% and 79.3% respectively in 2005).

#### *MER system*

The MER system allows electronic payments to be transferred between the VER systems of different BRPS regional subsystems bilaterally and on a decentralised basis. The MER system settles payments using only one kind of payment document, a payment order. The schedule, rules and procedures of the MER system are established by BoR regulations.

In the MER system, payments are carried out on a gross basis with intraday finality, except for settlements between regions located in remote time zones, which have finality no later than the next day (T+1).

A total of 192.5 million payments with a total value of 69.6 trillion rubles were effected through the MER system in 2009 (86.3 million payments with a value of 36.1 trillion rubles in 2005). They accounted for 20.4% of the total number and 11.4% of the total value of payments conducted through the BRPS in 2009 (15.5 and 18.6% accordingly in 2005).

#### 3.1.1.1 Participation

To participate in the VER and MER systems, BoR branches are required to meet the necessary technical and security standards. Participating credit institutions (or their branches) and BoR customers are required to have a bank account with such BoR branches.

As of January 2010, 3,948 participants were registered with the VER systems, this total comprising 630 BoR branches, 1,068 credit institutions and 2,250 branches of credit institutions. The MER system had 3,940 participants, of which 628 were BoR branches, 1,066 were credit institutions and 2,246 were branches of credit institutions.

---

<sup>30</sup> Except intraregional electronic payments in Moscow and the Moscow Region.

### 3.1.1.2 Types of transactions

Payments of the following type are conducted intraregionally and interregionally: payments of credit institutions (or branches) and their customers; BoR's customers including the Federal Treasury, non-bank organisations (branches); financial market infrastructures and the BoR's own payments.

A range of liquidity sources can be used for settlement, namely (i) available funds in correspondent accounts (sub-accounts) of credit institutions (or their branches); (ii) funds received during the business day; and (iii) the BoR's standing intraday and overnight credit facilities.

### 3.1.1.3 System operational and settlement procedures

#### *VER system*

In the VER systems, settlements are processed according to a set schedule in close to real time during the day or runs that take place several times a day, depending on the particular regional subsystem. To initiate a payment a payer sends an electronic payment message (EPM) to the KTsOI or, if there is no electronic access, sends a paper-based payment document to the relevant BoR branch. The EPM is checked to ensure that the payment document can be fulfilled. EPMs that fail this check are withdrawn from processing and returned to the sender with a message explaining why the payment has been rejected.

When settlement is made, a check is made that sufficient funds are on account to settle the payment document (including funds available from secured intraday and overnight credits). In the Moscow Region, this check also takes into account any offsetting payments. When all verifications have been received and settlement has taken place, the payer (or the BoR branch if the customer payer has no electronic access) is notified electronically that its account has been debited while the payee (or BoR branch) is notified that its account has been credited.

An approved payment document that has not been settled because of insufficient funds is placed in the intraday queue and the payer is notified of its status. At the end of the business day the deferred payment documents are cancelled and the payer is notified.

Customers without electronic access to the BoR branch receive a printed copy of the settled payment document and a customer account statement.

#### *MER system*

The MER system that allows electronic payments to be transferred between the VER systems of different regions processes payments in three steps. First, the payment is executed in the VER system that services the payer by debiting the payer's account; second, the payment is sent to the VER system that services the payee and, third, the payee's account is credited.

In each regional subsystem, a specified BoR branch (the MER principal participant) checks and registers interregional electronic payments and returns incorrect payments. Message exchange is supported by servers at the MER Transport Centre in Moscow.

### 3.1.1.4 Risk management

#### *Credit risk*

All payments in the VER and MER systems are settled in BoR money, mitigating credit risk on settlement assets for system participants.

To reduce credit risk for the BoR and credit institutions, BoR regulations stipulate that settlement through the VER and MER systems is on a gross basis. BoR regulations, which

apply to all credit institutions and financial market infrastructures, define irrevocability and payment finality as follows: a payment carried out through the VER and MER systems is considered irrevocable as soon as the customer payer's account is debited in the BoR branch and it is considered final after the customer payee's account is credited in the corresponding BoR branch.

As there is no "zero-hour" rule in Russian legislation, the bankruptcy of a settlement participant does not affect a payment's irrevocability and finality.

Other measures that address credit risk include the following:

- daily monitoring of credit institutions to ensure that reserve requirements are fulfilled, debts to the BoR are discharged, no correspondent accounts with the BoR are blocked for legal reasons;
- prudential requirements for the financial stability of credit institutions;
- refinancing limits and limits on collateral intraday and overnight credits.

#### *Liquidity risk*

BoR regulations stipulate that customer payments can be effected only within a customer's liquidity limit and that the customer should be notified of its balance as soon as its account is credited.

BoR regulations also govern the collateral mechanism whereby the BoR provides intraday or overnight loans. The BoR can also provide liquidity by means of intraday repo transactions.

Credit institutions may raise additional liquidity (secured intraday and overnight credits) against collateral of BoR eligible securities, as well as eligible non-market assets, such as bills of exchange, claims under credit contracts etc.

#### *Operational risk*

The BRPS and the VER and MER systems software infrastructures are based mainly on the collective BoR data processing system. Operational risk management is implemented through measures that include:

- duplication of data processing centres, data processing systems and databases;
- backup of technically important facilities and communication channels;
- fault-tolerant equipment and servers;
- centralised management of software and communication systems;
- use of diagnosis and audit facilities;
- regular training of staff involved in operations; and
- application of business continuity principles at all levels;

If operations are disrupted, all parties involved are informed immediately and appropriate measures are taken. If necessary, a backup data processing centre is put into operation.

#### *3.1.1.5 Pricing policy*

While the BoR aims to recover its costs for the BRPS settlement service, the fees charged depend on a variety of factors: the type of payment (ie which payment system is used to settle a payment), the payment method (ie electronic or paper-based), and the time that payment documents are transferred.

The fee structure incentivises settlement participants to access the BRPS electronically and to submit payment instructions early in the day. Hence, in the VER and MER systems the

lowest fees apply to customers using electronic access (from seven to 16 rubles per payment<sup>31</sup> while higher fees (from 17 to 22 rubles per payment) apply to customers using paper-based payment instruments.

<b>Intraregional electronic payments</b>			
<b>Payment method</b>	<b>Transmission channel</b>	<b>Transmission time</b>	<b>Fees<sup>1</sup></b>
Electronic payments (payments using full-format electronic payment document)	Via communications channels	First time period <sup>2</sup>	7.00
		Second time period	10.00
		Third time period	13.00
		Overtime	20.00
	On magnetic carriers <sup>3</sup>		16.00
	Paper-based		20.00
Other payments using electronic technology (payments using abridged-format electronic documents)	Via communications channels	First time period	8.00
		Second time period	11.00
		Third time period	14.00
		Overtime	21.00
	On magnetic carriers		17.00
	Paper-based		21.00

<b>Interregional electronic payments</b>			
<b>Payment method</b>	<b>Transmission method</b>	<b>Transmission time</b>	<b>Fees</b>
Electronic payments (payments using full-format electronic payment document)	Via communications channels	First time period	8.00
		Second time period	12.00
		Third time period	16.00
		Overtime	24.00
	On magnetic carriers		17.00
	Paper-based		21.00

<b>Paper copy of an electronic document service</b>	
Fee for printing out a paper copy of an electronic payment message	6.00
Fee for printing out a paper copy of an electronic payment document	6.00

<sup>1</sup> In rubles; fees per payment. <sup>2</sup> First time period: from the beginning of business day to 13:00 local time; second time period: from 13:00 to 16:00 local time; third time period: from 16:00 to 18:00 local time. <sup>3</sup> CDs, flash drives etc.

<sup>31</sup> Depending on the time the payment document arrives at the BRPS.

Fees for VER and MER services increase towards the end of the business day with the aim of smoothing out settlement traffic over the course of the day, accelerating funds turnover and improving liquidity management for credit institutions. Higher fees (from 20 to 24 rubles per payment) are charged for the electronic payment documents received from customers closer to the end of the business day.

#### *3.1.1.6 Major current and future projects*

The VER and MER systems will be used as a basis for a planned non-urgent payment service.

### **3.1.2 *BESP system***

The BESP system is a national real-time gross settlement system operated centrally on the federal level. The BESP system is interlinked with the BRPS's regional subsystems through electronic messaging. The BESP system started operations at the end of 2007.

#### *3.1.2.1 Institutional structure*

The BESP system is governed by BoR regulations and instructions that set operational rules, payment procedures, system participation and the maintenance of the participants' directory. The BoR has also defined guidelines for operation and oversight.

The BoR has established a special monitoring and control centre to manage the BESP. Its day-to-day responsibilities include control of the BESP operations schedule, participation management and control of the intraday payments queue, which also entails, in case of gridlock, cancellation (within one business day) of payment limits set by the participants and the offsetting of queued payments by multilateral optimisation.

#### *3.1.2.2 Participation*

BESP participants include BoR branches that provide settlement services to the BoR's customers, other BoR divisions that make payments, credit institutions and their branches, and the Federal Treasury and its regional offices.

BESP participants are categorised as special, direct and associated participants.

Special participants (SP) are BoR branches with the authority to effect payments through the BESP system. BoR customers may be direct or associated participants of the BESP system.

Direct participants (DP) have direct access, allowing them to conduct payments both for themselves and on behalf of customers in real time in accordance with the single country-wide settlement schedule. Such participants have access to the full range of BESP services. To qualify as DPs, credit institutions must meet stringent security and technical requirements.

Associated participants (AP) have indirect access to the BESP system through the BRPS regional subsystems and the range of services they can use is restricted. To qualify as an AP, a credit institution must be in account with an SP and have an electronic messaging link to the BoR.

As of January 2010, the BESP system had 1,155 registered participants, of which 205 were SPs, 457 were DPs and 493 were APs. As of the end of 2009, BESP participants included 870 credit institutions (or their branches).

#### *BESP services to participants*

The BESP system provides settlement for the payments to other BESP system participants that are initiated by direct and associated participants both on their own behalf and on behalf of customers. Settlement of payments from DPs is carried out according to the BESP system



schedule (ie from 9:00 to 21:00 Moscow time), while payments of the APs are carried out according to the schedules of the regional subsystems.

APs are kept informed about their payments settled through the BESP system and about their bank account balances.

DPs have access to a range of additional services, including management of payments (setting priorities and limits on payments, adding/removing payments to/from the payment queues). They also have access to information on liquidity available at the DP's branches for BESP operations; balances on correspondent sub-accounts and real-time data on settlements of DP payments effected through the BESP system, excluded or cancelled payments etc.

Participation in the BESP system does not preclude BoR customers from effecting payments through the VER and MER systems.

### 3.1.2.3 *Types of transactions*

Payments in the BESP system are effected between BESP participants only. The BESP system is designed to settle participants' payments in real time and on a gross basis, including financial market and monetary policy transactions, budget and interbank payments.

More than 63,000 payments with a total value of 106.6 trillion rubles were effected through the BESP system in 2009. There are no restrictions on the minimum value of a payment to be processed through the BESP system. However, payments of more than 1 million rubles accounted for 86.4% of the total volume and almost 100% of the total value of payments in the BESP system. The average payment amounted to 1.7 billion rubles.

Payments effected through the BESP system accounted for 17.5% of the total value of payments through the BRPS in 2009.

Participants decide on grounds of speed and cost whether to route a payment through the BESP.

### 3.1.2.4 *System operation and settlement procedures*

The BESP system is supported within the BoR's data processing infrastructure, electronic settlement transport system (TSER) and customer interface (SVK).

Payments in the BESP system are effected using payment orders in the form of electronic payment messages, which are also used to exchange information (inquiries, confirmations etc).

DPs and APs can make payments using the liquidity on their bank accounts at BoR branches. Thus, participants do not need to open additional correspondent (bank) accounts. However, since DPs may effect payments in the BESP system as well as in the BRPS' regional systems, they are able to redistribute liquidity across accounts during the business day.

A payment from one DP to another DP is settled instantaneously in the BESP system. The DP payer sends an EPM to the KTsoI of the BESP system, which checks whether the EPM is authentic, if all details are correct and if the payment order can be fulfilled. Once these checks are completed, the DP payer's account is debited immediately and the DP payee's account is simultaneously credited. If the checks for authenticity or correctness fail, the EPM is dropped from the processing. If, on the other hand, there are insufficient funds on the DP payer's account, the DP's payment is queued until sufficient funds are received to automatically carry out the settlement. The DP payer is then notified that the settlement has been completed.

An AP may only access the BESP system indirectly, through the BRPS regional system.

A payment by one AP to another AP is settled in three steps:

- (i) an EPM is sent and checked (including a check to verify whether sufficient funds are on the AP payer's account) in the BRPS regional subsystem. It is then sent to the BESP system processing and settlement centre;
- (ii) the settlement operation is carried out in the processing and settlement centre and a confirmation is sent to the BRPS regional subsystem to debit the AP payer's account. At the same time, an EPM is sent to the BRPS regional subsystem to credit the AP payee's account; and
- (iii) the AP payer's account is debited and the AP payee's account is credited in the correspondent BRPS regional subsystems.

A DP's payment to an AP, as well as an AP's payment to a DP, is settled in two stages and represents a combination of the BESP system settlement procedures described above (DP to DP and AP to AP).

### 3.1.2.5 Risk management

#### *Credit risk*

Real-time settlement is the principal means for credit risk mitigation in the BESP system. To manage other credit risk aspects, the BESP system uses procedures similar to the ones described above for the VER and MER systems.

To mitigate credit risk for the BoR and credit institutions that are BESP participants, the BoR's regulations define irrevocability and finality for all payments effected through the BESP system as follows: a payment is considered irrevocable as soon as the payer's account is debited. A payment is final as soon as the payee's account is credited. Subsequently, the corresponding electronic information messages are simultaneously sent to the payer and payee. Settlement is effected individually for each payment in real time during the business day.

To further reduce credit risks, BESP participants may also set bilateral and multilateral limits on payments to other system participants.

#### *Liquidity risk*

If funds are insufficient, the BoR can provide intraday liquidity to BESP participants. Credit institutions can draw on collateralised intraday and overnight credits within their overdraft limit. Moreover, DPs can use BoR-provided software applications to manage queued payments, receive status information on incoming or outgoing payments and offset payments within the queue. APs can manage payment queues and receive information on the status of a payment only within their regional subsystems.

The BESP system can identify and resolve gridlock situations and manage DP payment queues, thereby contributing to real-time risk management.

A DP (credit institution' head office) can receive information about the liquidity of its DP branches so that it can manage its liquidity efficiently during the business day.

#### *Operational risk*

The approach to managing operational risk within the BESP system is similar to that applied to the VER and MER systems. System functions, including the IT system, are continuously monitored and payment activity is analysed daily with a view to ensuring smooth operation.

Data security is assured by a combination of technical and organisational measures. If operations are disrupted, all parties involved are informed immediately and appropriate measures are taken. If necessary, a backup data processing centre is put into operation.

BoR regulations and instructions outline BoR responsibilities in the event of a system disruption, together with specified responses and contingency plans.

Real-time and historical data are stored in two separate centres, ensuring that data files can be restored in the event of any malfunction.

### 3.1.2.6 Pricing policy

BESP system fees are set according to the type of participation (DP or AP) and thus on the level of service. They also depend on the payment's priority (express or regular). Payments through the BESP system attract higher fees than those of other payment systems. APs are charged 20 rubles per regular payment. DPs are charged 25 rubles for a regular payment and 30 rubles for an express payment.<sup>32</sup> Certain information services also attract a fee (of 9-13 rubles per executed electronic inquiry and six rubles per paper copy of an EPM).

A scaled discount system based on payment volumes has been introduced to encourage settlement through the BESP and to conform with international practice.

<b>Payments carried out through the BESP system</b>	
<b>Type of service</b>	<b>Fees</b>
Express payments by direct participants	30.00
Regular payments by direct participants	25.00
Regular payments by associate participants	20.00
<b>Information services in the BESP system</b>	
Fee per completed liquidity or account balance inquiry	13.00
Fee per completed inquiry for other services	9.00
<b>Paper copy of an electronic document service</b>	
Fee per paper print-out of an electronic payment message	6.00
Fee per paper print-out of an electronic payment document	6.00
<b>Discount rates</b>	
<b>Number of payments</b>	<b>Discount rate, %</b>
301–500	4
501–1,000	5
More than 1,000	6

### 3.1.2.7 Major current and future projects

The BESP system will be further developed to improve its capabilities as a settlement system for large-value and urgent payments, and for financial market transactions on a delivery versus payment basis. The system will also be used as an instrument for monetary policy operations. Therefore, as of August 2010, all eligible credit institutions (branches) that were not already BESP participants were given AP status.

BESP participants will in future also be able to access the BESP system via SWIFT.

<sup>32</sup> Only DPs can initiate express payments.

### **3.1.3 Payment system using letters of advice**

Payments using postal and telegraphic letters of advice are initiated on paper and settled in the BRPS. Paper-based payments are used where BoR are not equipped to make electronic payments or the paper-based payment instrument is not machine-readable at the BoR branch.

Payments by letters of advice require just over three days to complete on average, given the labour-intensive process for intraregional and interregional settlement. Settlement time for postal letters of advice depends mainly on the payment documents delivery service involved.

The share of paper-based payments in the total volume and value of BRPS payments is small. Some 1.6 million paper-based payments with a total value of 887.9 billion rubles were made in 2009 (5.1 million payments with total value of 4.1 trillion rubles in 2005). They accounted for 0.2% of the total volume and 0.1% of the total value of payments effected through the BRPS.

#### **3.1.3.1 Participation**

BRPS participants using letters of advice are the BoR branches and divisions listed in the national BIC Directory.

Users of letters of advice within the payment system include credit institutions (or their branches) and other non-bank BoR customers.

#### **3.1.3.2 Types of transactions**

Payments using letters of advice can be effected across BoR customers' accounts for any type of payment instrument.

#### **3.1.3.3 System operation and settlement procedures**

The payment system using letters of advice is decentralised. Paper-based payments are effected during the business day of BoR branches at the respective local times.

Information support for the payment system using letters of advice is provided by the BoR's collective data processing system and local computer systems.

When it receives paper-based payment documents, a BoR branch checks their format and security and also confirms that the payer has sufficient funds on account. After these checks are completed, the payer's account is debited and the payment documents are sent to the payee's BoR branch with instructions to credit the payee's account.

Most payment documents relating to postal letters of advice are transported between BoR branches by state services such as the postal service and BoR branch staff.

Payment documents relating to telegraphic letters of advice are transmitted by telegraph using BoR teletype facilities or on paper to the Russian Ministry of Communications and Mass Media divisions for subsequent transmission to BoR branches by telegraph.

#### **3.1.3.4 Risk management**

As payments using letters of advice are effected on a gross basis across the same bank (correspondent) customer accounts as electronic settlements, the risk management procedures are similar. Control processes include visual verification at the BoR branch, to mitigate the risks involved in the physical transfer of documents between branches.

#### **3.1.3.5 Pricing policy**

Fees for payments using letters of advice depend on the location of the BoR customers involved in the transfer. The fee for an intraregional transfer is 13.4 rubles per payment by

telegraph and 14.3 rubles by post; the price of an interregional transfer is 14.3 rubles by telegraph and 16.8 rubles by post.

#### 3.1.3.6 Major current and future projects

Paper-based payments will increasingly be relegated to backup status given the growing prevalence of electronic payment technology.

## 4. Systems for post-trade processing, clearing and securities settlement

### 4.1 General overview

The two leading providers of trade, clearing and settlement services on the Russian securities market are the Moscow Interbank Currency Exchange Group (MICEX Group) and the Russian Trading System Group (RTS Group), which are both vertically integrated organisations. Each group operates its own securities settlement system (SSS) and clearing system.

The MICEX Group operates the stock, government securities and derivatives markets.<sup>33</sup> Both stocks and bonds are traded in the stock market while only bonds are traded in the government securities market (GSM). In the derivatives market, options and futures are traded, based on various underlying assets including stocks, stock indices, interest rates, currencies and commodities.

The RTS Group operates the stock and derivatives markets. Both stocks and bonds are traded in the stock market. In the derivatives market are traded options and futures based on underlying assets that include stocks and stock indices.

The majority of Russian securities and derivatives is traded on the MICEX and RTS Group markets. The basic difference between the MICEX and RTS markets is that a unit of the GSM is located within MICEX, which is used to conduct monetary policy.

Market participants choose an exchange for securities transactions on the basis of participation criteria, system functionality, risk management and fee scale.

MICEX and the RTS Clearing Chamber (RTS CC) act as CCPs<sup>34</sup> for transactions on the markets of MICEX Group and RTS Group. There is currently no CCP for OTC securities transactions in Russia. The National Settlement Depository (NSD)<sup>35</sup> and the Depository Clearing Company (DCC) act as central securities depositories (CDSs) and provide book-entry transfers and a centralised depository. They also conduct settlement for securities traded on the floors.

The cash legs of securities transactions are settled through the NSD, which is part of the MICEX Group, and the RTS Settlement Chamber (RTS SC),<sup>36</sup> which is part of the RTS Group.

---

<sup>33</sup> The MICEX Group also operates the currency market. Trading, clearing and settlement services for currency transactions are provided by the MICEX Group's infrastructure.

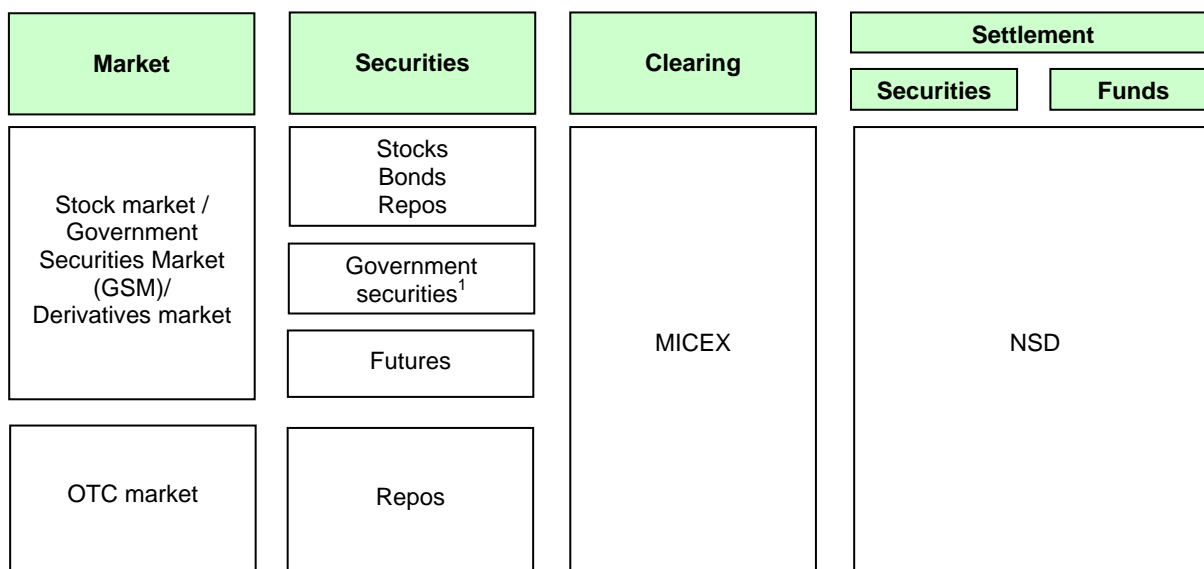
<sup>34</sup> In some cases MICEX also provides non-CCP clearing (see Section 4.3.1.3).

<sup>35</sup> The NSD is licensed by the BoR as it was founded in November 2010 as a result of a merger between NDC and MICEX SC. NSD provides securities settlement and funds settlement services.

<sup>36</sup> RTS SC is licensed by the BoR as it provides funds settlement services for securities transactions.

## Chart

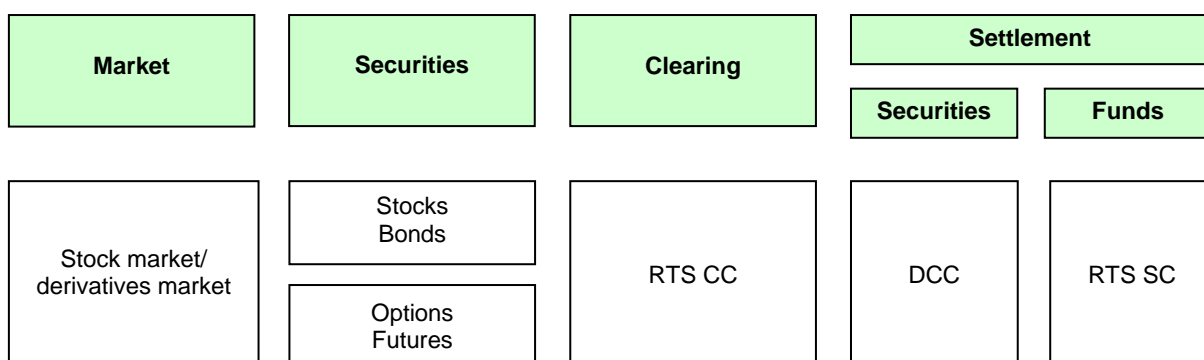
**Summary of securities trading, clearing and settlement systems  
in the MICEX Group**



<sup>1</sup> Federal bonds: GKO, OFZ,<sup>37</sup> BoR bonds,<sup>38</sup> sovereign Eurobonds, subfederal, municipal bonds.

## Chart

**Summary of securities trading, clearing and settlement systems  
in the RTS Group**



#### 4.2 Post-trade processing system

At present, no separate organisation performs the functions of a trade confirmation system or a trade repository. Post-trade services (after trade but before clearing) are provided within the MICEX and RTS Groups.

<sup>37</sup> GKO: government short-term zero-coupon bonds; OFZ: federal loan bonds.

<sup>38</sup> BoR bonds are bearer debt securities issued by the BoR exclusively for monetary policy purposes.

## 4.3 Central counterparties and clearing systems

### 4.3.1 Moscow Interbank Currency Exchange (MICEX)

#### 4.3.1.1 Institutional framework

MICEX acts as a CCP<sup>39</sup> for trades conducted in the markets it operates. MICEX performs clearing in accordance with (i) the requirements of the federal law “On the securities market”, (ii) FFMS regulations and, in particular, the regulation “On clearing activity in the securities market of the Russian Federation” (the Securities Clearing Regulation), (iii) the MICEX clearing rules and (iv) MICEX agreements with clearing participants.

The major shareholders of MICEX are the BoR and Russian banks.

MICEX is supervised by the FFMS.

#### 4.3.1.2 Participation

In accordance with the MICEX clearing rules, only credit and other financial institutions that have clearing contracts with MICEX can be MICEX clearing participants. As of end-June 2010, there were 696 participants for stock market transactions, 286 for GSM transactions, 205 for derivatives market transactions and 139 (credit institutions) for OTC repo transactions with the BoR.<sup>40</sup>

Clearing participants for derivatives market transactions must have minimum equity capital of EUR 0.1–10 million (for credit institutions) or EUR 0.1–1 million (for other financial institutions).<sup>41</sup>

Clearing participants for derivatives market transactions may be either direct clearing participants or general clearing participants. Direct clearing participants clear only for themselves while general clearing participants may also clear on behalf of other trade participants.

#### 4.3.1.3 Types of transactions cleared

As a clearing organisation MICEX provides:

- CCP clearing services for (i) equities from the MICEX Index<sup>42</sup> list and for high-quality bonds with settlement from T+1 to T+3,<sup>43</sup> (ii) repo transactions with repo near-leg settlements from T+0 to T+2 and repo far-leg settlements the day following settlement of the near leg; and (iii) futures traded on the derivatives market, including financial and commodities futures;
- non-CCP clearing services for (i) transactions on MICEX GSM, (ii) transactions on MICEX SE stock market with settlement from T+0 to T+30, (iii) repo transactions, which can be for up to 180 days<sup>44</sup> and (iv) for OTC repo transactions with the BoR.

---

<sup>39</sup> In some cases MICEX also provides non-CCP clearing (see Section 4.3.1.3).

<sup>40</sup> One financial institution can make transactions in more than one market.

<sup>41</sup> The equity capital requirements for credit institutions and financial institutions vary according to the type of financial instrument cleared and the category of participants.

<sup>42</sup> The MICEX Index is a major stock market index, comparable to the Dow Jones, Nikkei, Dax etc.

<sup>43</sup> Participants can choose the settlement date.

<sup>44</sup> Participants can choose CCP or non-CCP clearing for short-term repo transactions (from T+0 to T+2).

#### 4.3.1.4 Operation of the system

Transactions with the CCP are performed on the open-offer principle (without novation). MICEX assumes the obligations of its participants, determines the volume of securities and value of funds to be submitted by each participant and notifies clearing participants and NSD as necessary.

NSD provides settlement of securities and the cash legs of securities transactions effected in the stock market and GSM of the MICEX Group as well as the transfer of margin on transactions in the derivatives market.

Securities transactions are settled on the DVP3 model.

#### 4.3.1.5 Risk management

The MICEX risk management system consists of margin requirements, guarantee funds and participation requirements (see Section 4.3.1.2).

##### (i) Margin requirements.

MICEX requires an initial margin from the clearing participants in the MICEX Stock Exchange (MICEX SE) stock market. This can be provided both in cash and in securities and, on the MICEX GSM, funds and securities must be 100% pre-deposited. In the MICEX derivatives market, margin requirements depend on the total value of open positions. There is a real-time check of collateral sufficiency in the MICEX derivatives market. Collateral requirements are recalculated daily, and the variation margin is called based on a mark to market calculation.

##### (ii) Guarantee funds

Currently all guarantee funds are drawn from MICEX's own capital.

For the MICEX SE stock market, a basic guarantee fund (of 100 million rubles) and an additional guarantee fund<sup>45</sup> are designed to cover losses from a CCP participant's default. The MICEX derivatives market has a reserve fund (of 2 billion rubles) and an accumulation fund (default fund).

#### 4.3.1.6 Links to other systems

The MICEX clearing system is linked to the NSD.

There are currently no links with foreign CCPs and CSDs.

#### 4.3.1.7 Pricing

No clearing fees are charged on a per-transaction basis on the MICEX GSM and derivatives market. Instead, market participants pay an overall MICEX commission fee (exchange fee).

Transactions on the MICEX and MICEX SE stock markets attract a clearing fee for each transaction which varies according to its type and value.

#### 4.3.1.8 Major current and future projects

MICEX has the following plans for its future development:

- extension of CCP stock market clearing with T+n (n>3) settlements;

---

<sup>45</sup> An additional guarantee fund is used to cover potential defaults of CCP members, while a basic guarantee fund is used to cover losses during non-CCP clearing.



- improved risk management by instituting a joint fund based on contributions from clearing participants;
- providing CCP services for transactions on other exchanges and the OTC market.

#### **4.3.2 The RTS Clearing Centre**

##### *4.3.2.1 Institutional framework*

RTS CC acts as a CCP for the trades conducted in the markets it operates. RTS CC is a subsidiary of the RTS Stock Exchange (RTS SE).

RTS CC's legal, regulatory and supervisory framework is similar to that of MICEX.

##### *4.3.2.2 Participation*

Only credit institutions and other financial institutions that have clearing contracts with the RTS CC can be RTS CC clearing participants. At present, there are some 357 participants, including 60 non-residents.<sup>46</sup>

No equity capital requirement is specified for credit institutions and financial institutions that participate in the RTS CC.

##### *4.3.2.3 Types of transactions cleared*

RTS CC provides CCP clearing services for (i) equities and corporate bonds of Russian issuers traded on the stock market with settlement from T+0 to T+30;<sup>47</sup> and (ii) futures traded on the derivatives market, including financial and commodities futures and options.

##### *4.3.2.4 Operation of the system*

Transactions with the CCP are conducted on the open-offer principle. The RTS CC assumes the obligations of its participants, determines the volume of securities and value of funds to be submitted by each participant and notifies RTS SC, DCC and clearing participants as necessary.

The DCC or the Settlement Depository Company (SDC)<sup>48</sup> provides settlement for the securities legs of securities transactions effected on the RTS stock market and the St Petersburg Stock Exchange (SPBEX). RTS SC settles the cash legs of securities transactions in the stock market of the RTS Group and transfers variation margins on transactions in the derivatives market.

Securities transactions are settled on the DVP3 model.

##### *4.3.2.5 Risk management*

The RTS CC risk management system consists of margin requirements and guarantee funds.

###### **(i) Margin requirements.**

Clearing participants are obliged to deposit collateral (initial or deposit margin) against any stock or derivative transactions that exceed the limit value for uncollateralised transactions.

---

<sup>46</sup> As of end-2009.

<sup>47</sup> Participants can choose the settlement date.

<sup>48</sup> SDC is a securities depository licenced by the FFMS.

Such collateral can consist of cash and/or securities. The RTS CC continuously monitors collateral adequacy.

To mitigate losses in case of default in the derivatives market, the RTS CC re-calculates open positions twice a day on a mark to market basis and transfers the variation margin.

(ii) Guarantee funds<sup>49</sup>

To mitigate clearing risks, the RTS CC maintains insurance, reserve and guarantee funds.

The insurance fund is based on contributions from clearing participants, while reserve and guarantee funds consist of the RTS CC's own assets.

These funds are designed to cover the liabilities of a clearing participant in the event of its default and to complete the settlement. The total value of these funds is more than USD 60 million.<sup>50</sup>

#### 4.3.2.6 *Links to other systems*

The RTS CC is linked with the RTS SC for the settlement of the cash legs of securities transactions conducted on the trading floor of the RTS Group and with the DCC and SDC for the settlement of the securities legs of securities transactions.

There are currently no links with foreign CCPs and CSDs.

#### 4.3.2.7 *Pricing*

The RTS CC's clearing fee for stock market transactions is a percentage of the transaction's value.

The clearing fee for derivatives market transactions is charged on the fulfilment of the delivery obligation. The RTS CC levies a fixed commission fee for the execution of each future or option transaction.

The RTS CC does not charge a participation fee.

#### 4.3.2.8 *Major current and future projects*

A project is under way to extend the RTS CC's CCP services to derivatives transactions traded on other exchanges.

## 4.4 **Securities settlement systems**

The NSD and DCC are the CSDs<sup>51</sup> that provide securities settlement services for the securities settlement systems of, respectively, the MICEX and the RTS Groups.

### 4.4.1 ***The National Settlement Depository***

#### 4.4.1.1 *Institutional framework*

The NSD provides securities settlement services according to (i) the requirements of the federal law "On the securities market", (ii) FFMS regulations and, in particular, the regulation

---

<sup>49</sup> Default funds.

<sup>50</sup> As of end-2009.

<sup>51</sup> The NSD also provides funds settlement.

“On depository activity in the Russian Federation”, (iii) the rules of the NSD and (iv) the depository agreement with NSD participants. MICEX is the only NSD shareholder.

The NSD is supervised by the FFMS and the BoR.

#### *4.4.1.2 Participation*

Participants for securities settlement are the same as for all securities clearing, except for derivatives transactions (See section 4.3.1.2).

#### *4.4.1.3 Types of operations*

NSD provides funds and securities settlement services for all securities transactions (except for derivatives) traded on the floors of the MICEX Group.

#### *4.4.1.4 Operation of the system*

Securities transactions effected on the floors of the MICEX Group are settled by NSD on the basis of orders received from MICEX no later than 18:45 on the settlement date. Participants are required to deliver securities to NSD's accounts between 10:00 and 17:00 on the settlement date.

Settlement is effected according to the settlement day schedule; settlement times vary according to the type of security and clearing (CCP or non-CCP).

NSD also provides settlement for the cash legs of securities transactions effected on the floors of the MICEX Group.

Securities transactions are settled on the DVP3 model.

NSD provides its participants with daily statements on settled transactions.

#### *4.4.1.5 Risk management*

The NSD risk management system comprises the following interrelated measures and arrangements.

A DVP mechanism substantially eliminates principal risk on the settlement of securities transactions.

Also, as final settlement of some securities occurs no later than T+3 (T+1 for some stock market transactions) the volume of trades outstanding is limited, reducing aggregate market exposure.

Operational risks are addressed by internal control processes as well as IT security measures and a backup data centre. Business continuity is ensured by a recovery plan, including procedures for data and systems recovery.

Risks related to NSD's depository activity are insured with leading Russian insurance companies.

#### *4.4.1.6 Links to other systems*

NSD is linked to the securities settlement system of the RTS Group for securities settlements. In addition, NSD is linked to Russian custodian banks (Gazprom Bank, Sberbank Russia, ING Bank (Eurasia), Citibank) and with the CSDs of Kazakhstan, Belarus and Azerbaijan. Through these links, NSD provides depository and settlement services for foreign securities.

NSD is also linked to the BESP system, the BoR's RTGS system (see Section 3.1) for final settlement of the cash leg of securities transactions traded on-floor. NSD's account with the BESP system is used for the collection of cash prefunding from market participants and for

final settlement using the BESP system of the cash leg of securities transactions for market participants that have authorised NSD to do so.

#### *4.4.1.7 Pricing*

Fees for settlement services provided by NSD are set at 100 rubles per transaction. Fees are charged on a monthly basis. There is no annual commission fee.

### **4.4.2 The Depository Clearing Company**

#### *4.4.2.1 Institutional framework*

DCC provides securities settlement services under the same regulatory framework as NSD (see Section 4.4.1.1). RTS SE is DCC's major shareholder.

DCC is supervised by the FFMS.

#### *4.4.2.2 Participation*

Participants for securities settlement are the same as for all securities clearing (see Section 4.3.2.2).

#### *4.4.2.3 Types of transactions*

All securities transactions traded on the floors of the RTS Group are settled through DCC.<sup>52</sup>

#### *4.4.2.4 Operation of the system*

DCC settles securities transactions effected on the floors of the RTS Group on the basis of orders received from the RTS CC from 17:00 to 19:00 on the settlement date. Participants are required to deliver securities to DCC's accounts from 9:45 to 18:00 on the settlement date.

Settlement takes place according to the settlement day schedule with settlement times varying according to the type of securities.

Securities transactions are settled on the DVP3 model.

RTS SC settles the cash legs of securities transactions effected on the floors of the RTS Group and, like the NSD, is linked to the BESP system (see Section 4.4.1.6).

DCC provides its participants with daily statements on settled transactions.

#### *4.4.2.5 Risk management*

DCC employs several risk management tools. Its DVP mechanism substantially eliminates principal risk on the settlement of securities transactions.

Operational risks are addressed by compliance and data security measures, while business continuity is assured by a recovery plan and a remote backup computer centre.

Risks arising from DCC's depository activity are insured.

#### *4.4.2.6 Links to other systems*

DCC is linked to the securities settlement system of the MICEX Group for securities settlement. In addition, DCC is linked to Russian-based custodian banks (ING Bank

---

<sup>52</sup> DCC also provides securities settlement services for equities transactions on the SPBEX stock market.

(Eurasia), Citibank, VTB Bank, Deutsche Bank) and with the CSDs of the Ukraine, Kazakhstan and Belarus. Through these links, DCC provides depository and settlement services for foreign securities.

To provide securities settlement in the international financial markets, DCC has an account with Euroclear Bank.

#### *4.4.2.7 Pricing*

The settlement fee is set at 75 rubles per securities issue (regardless of the number of transactions involving a given securities issue that may be effected during the business day).

Information on DCC fees is publicly available; the fee scale is the same for all participants.

#### *4.4.2.8 Major current and future projects*

DCC plans to provide a DVP settlement service (i) in euro and (ii) over the securities settlement accounts of Russian custodians and CSDs.

### **4.5 Use of securities infrastructure by the central bank**

The BoR carries out operations with federal government securities and BoR bonds in order to conduct monetary policy, regulate liquidity and influence the level of interest rates.

Operations with federal bonds (GKO, OFZ) and BoR bonds are carried out by the BoR using MICEX Group infrastructure. For this purpose the BoR enters into agreements with the respective institutions of the MICEX Group for the use of its trading, clearing and settlement services.

**Payment, clearing and  
settlement systems in  
Singapore**



## Contents

List of abbreviations.....	329
Introduction.....	331
1. Institutional aspects.....	331
1.1 The general legal and regulatory framework.....	331
1.2 Role of MAS in payment, clearing and settlement systems .....	333
1.2.1 Settlement agent.....	333
1.2.2 Operator.....	333
1.2.3 Overseer .....	333
1.2.4 Cooperation with other institutions.....	334
1.3 The role of other private and public sector bodies .....	335
1.3.1 Singapore Clearing House Association (SCHA) .....	335
1.3.2 Association of Banks in Singapore (ABS).....	335
1.4 The role of banks .....	335
2. Payment media .....	335
2.1 Cash payments .....	335
2.2 Non-cash payments .....	336
2.2.1 Interbank GIRO.....	336
2.2.2 Cheques.....	336
2.2.3 Payment cards.....	337
2.2.4 Other access channels for banking and payments .....	340
3. Payment systems (funds transfer systems).....	341
3.1 General overview .....	341
3.2 New MAS Electronic Payment System (MEPS+).....	342
3.2.1 Operating rules .....	342
3.2.2 System participants.....	343
3.2.3 Types of transactions handled .....	343
3.2.4 Operation of the transfer system and the transaction processing environment .....	343
3.2.5 Settlement procedures.....	344
3.2.6 Credit and liquidity risks and their management .....	344
3.2.7 Pricing policies .....	344
3.3 Foreign exchange (FX) settlement systems.....	346
3.3.1 Continuous Linked Settlement (CLS).....	346
3.3.2 Clearing and Payment Services Pte Ltd (CAPS) .....	346
3.4 Retail payment systems .....	346



3.4.1	Singapore Dollar Cheque Clearing System (SGDCCS).....	346
3.4.2	USDollar Cheque Clearing System (USDCCS) .....	346
3.4.3	Cheque Truncation System (CTS) .....	347
3.4.4	Interbank GIRO (IBG) .....	348
3.4.5	ATM networks .....	348
4.	Systems for post-trade processing, clearing and securities settlement.....	349
4.1	General overview .....	349
4.2	Central counterparties and clearing systems .....	349
4.2.1	CDP.....	349
4.2.2	SGX-DC .....	351
4.3	Securities settlement systems.....	352
4.3.1	MEPS+-SGS .....	352
4.3.2	CDP.....	354
4.4	Use of securities infrastructure by the central bank.....	355

## List of abbreviations

2FA	two-factor authentication
ABS	Association of Banks in Singapore
ADR	American depository receipt
ATM	automated teller machine
BCS	Banking Computer Services Pte Ltd
BO	billing organisation
CAPS	Clearing and Payment Services Pte Ltd
CCP	central counterparty
CDP	Central Depository Pte Ltd
CEPAS	Contactless ePurse Application
CLS	Continuous Linked Settlement
CME	Chicago Mercantile Exchange
CMS	Capital Markets Services
COE	Certificate of Entitlement
CSD	central securities depository
CTS	Cheque Truncation System
CUP	China UnionPay
DCH	designated clearing house
DCSS	Debt Securities Clearing and Settlement System
DDA	direct debit authorisation
DVP	delivery versus payment
EFTPOS	electronic funds transfer at point of sale
ERP	Electronic Road Pricing
ESDN	electronic service delivery network
ETF	exchange-traded fund
ETN	exchange-traded note
FOP	free of payment
GDR	global depository receipt
IBG	interbank GIRO
ICSD	international central securities depository
IDA	Infocomm Development Authority
ILF	intraday liquidity facility
IPO	initial public offering
MAS	Monetary Authority of Singapore
MCB	Minimum Cash Balance

MEPS+	New MAS Electronic Payment System
MEPS+-IFT	MEPS+ Interbank Funds Transfer
MEPS+-SGS	MEPS+ Singapore Government Securities
MICR	magnetic ink character recognition
MLA	Minimum Liquid Assets
MPSVF	multipurpose stored value facility
MRT	Mass Rapid Transport
NETS	Network for Electronic Transfers (Singapore) Pte Ltd
OTC	over-the-counter
OTP	one-time password
PSMS	Pre-Settlement Matching Service
PS(O)A	Payment Systems (Oversight) Act
PVP	payment versus payment
QFB	qualifying full bank
QUEST-ST	Quotation and Execution System for Trading
REIT	real estate investment trust
RTGS	real-time gross settlement
SACH	Singapore Automated Clearing House
SAM	Self-service Automated Machine
SCHA	Singapore Clearing House Association
SFA	Securities and Futures Act
SIPS	systemically important payment system
SGDCCS	Singapore Dollar Cheque Clearing System
SGS	Singapore Government Securities
SGX	Singapore Exchange Ltd
SGX-DC	Singapore Exchange Derivatives Clearing Ltd
SGX-DT	Singapore Exchange Derivatives Trading Ltd
SGX-ST	Singapore Exchange Securities Trading
SMS	short message service
SPSVF	single-purpose stored value facility
SSS	securities settlement system
SVF	stored value facility
SWIFT	Society for Worldwide Interbank Financial Telecommunication
SYOG PPC	Singapore Youth Olympic Games DBS Visa Prepaid Card
SWIPS	system-wide important payment system
USDCCS	US Dollar Cheque Clearing System
WASVF	widely accepted stored value facility

## Introduction

The evolution of Singapore's payment, clearing and settlement systems has been driven by technological progress, changing consumer needs and the development of new financial activities. It has moved from a paper- and cash transaction-based system to one with a diverse range of alternative payment instruments, supported by efficient and reliable clearing and settlement infrastructure.

The majority of non-cash retail payments utilise interbank GIRO (IBG) debit and credit transfers as well as payment cards (stored value, debit and credit cards) and cheques. Bank customers can also use their debit cards to make third-party account funds transfers and to pay bills via automated teller machines (ATMs) and self-service kiosks. Other payment channels that have seen recent growth include contactless card payments and mobile and internet banking services.

The Monetary Authority of Singapore (MAS) operates an electronic payments and book-entry system, the New MAS Electronic Payment System (MEPS+), which supports large-value local currency interbank funds transfers and the settlement of scripless<sup>1</sup> Singapore Government Securities (SGS) between MEPS+ participants, subject to the availability of funds or securities.

Singapore dollar (SGD) cheque clearing, US dollar (USD) cheque clearing and interbank GIRO clearing services are provided by the Singapore Automated Clearing House (SACH), which is operated by the Banking Computer Services Pte Ltd (BCS).

The two main providers of securities clearing and settlement systems in Singapore are MAS and the Central Depository Pte Ltd (CDP). The MEPS+ Singapore Government Securities (MEPS+-SGS) subsystem at MAS clears and settles SGS trades while the CDP operates securities settlement systems for Singapore equities, corporate debt securities and other securities. CDP also operates as a central counterparty (CCP) and a central securities depository (CSD). The derivatives clearing and settlement system is operated by Singapore Exchange Derivatives Clearing Ltd (SGX-DC). Both the CDP and SGX-DC are wholly owned subsidiaries of Singapore Exchange Ltd (SGX).

## 1. Institutional aspects

### 1.1 The general legal and regulatory framework

MAS has explicit legal powers to establish and operate real-time gross settlement (RTGS) systems, oversee payment systems including cheque clearing and IBG systems, and regulate the issuance of multipurpose stored value facilities (MPSVFs). These powers are specified by various acts and regulations as highlighted in the table below.

CDP is a designated clearing house regulated under the Securities and Futures Act (SFA) and its relevant subsidiary legislation. The CDP clearing rules and delivery versus payment (DVP) rules govern its operations, its admission requirements and the ongoing obligations of its members.

The following table sets out the relevant legislation and regulations under the purview of MAS that apply to payment instruments and institutions in Singapore.

---

<sup>1</sup> SGS are dematerialised.

Payment instrument and/or institution	Legislation, regulations and bye-laws	Description
Cheques and GIRO	<i>Section 59 of the Banking Act (Chapter 19)</i> <sup>1</sup>	This provision of the Banking Act allows MAS, in conjunction with banks and other financial institutions, to establish a clearing house to facilitate the clearing of cheques and credit instruments, and ensure its smooth operation.
Cheques and GIRO	<i>Payment Systems (Oversight) (Singapore Dollar Cheque Clearing System and Inter-Bank GIRO System) Regulations 2006</i> <sup>2</sup>	These regulations set out the rules, obligations and procedures relating to participation in the Singapore Dollar Cheque Clearing System (SGDCCS) and the IBG.
Cheques and GIRO	<i>Payment and Settlement Systems (Finality and Netting) Act (Chapter 231)</i> <sup>3</sup>	The SGDCCS, the US Dollar Cheque Clearing System (USDCCS) and the IBG are designated under the Payment and Settlement Systems (Finality and Netting) Act.
Continuous Linked Settlement (CLS)	<i>Payment and Settlement Systems (Finality and Netting) Act (Chapter 231)</i>	<p>CLS is a designated payment system under the Payment and Settlement Systems (Finality and Netting) Act.</p> <p>CLS Bank is chartered and supervised by the Federal Reserve System, which includes both the Board of Governors of the Federal Reserve System and the Federal Reserve Bank of New York. The G10 and other central banks of issue for CLS-settled currencies established a Protocol for the Cooperative Oversight Arrangement of CLS<sup>4</sup> in November 2008 to provide a mechanism for mutual assistance in carrying out their individual responsibilities in pursuit of their shared public policy objectives for the safety and efficiency of payment and settlement systems and their focus on the stability of the financial system. MAS is a participating central bank in this Cooperative Oversight Arrangement.</p>
Currency	<i>Currency Act (Chapter 69)</i> <sup>5</sup>	MAS is the sole issuer of currency in Singapore. Under the Currency Act, the currency in circulation must be 100% backed by external assets. <sup>6</sup> This is achieved through the maintenance of a currency fund consisting of gold, silver and foreign exchange in the form of demand and time deposits, treasury bills, notes, coins as well as other eligible assets.
Payment systems	<i>Payment Systems (Oversight) Act 2006 (Chapter 222A) (PS(O)A)</i> <sup>7</sup>	<p>The PS(O)A provides for the oversight of payment systems and stored value facilities (SVFs) in Singapore.</p> <p>The PS(O)A gives MAS powers over payment systems, payment instruments and participants in payment systems, covering three main areas (for details, see Section 1.2.3):</p> <ul style="list-style-type: none"> <li>(i) The designation of payment systems as systemically important payment systems (SIPS) or system-wide important payment systems (SWIPS).</li> <li>(ii) Information-gathering powers over all payment system participants.</li> <li>(iii) The regulatory regime for SVFs.</li> </ul>

Payment instrument and/or institution	Legislation, regulations and bye-laws	Description
Real-time gross settlement (RTGS) system	<p><i>Section 29A of the Monetary Authority of Singapore Act (Chapter 186)</i></p> <p><i>Section 21 of the Payment and Settlement Systems (Finality and Netting) Act (Chapter 231)</i></p>	<p>This allows MAS to establish and operate one or more RTGS systems. MAS is responsible for the smooth operation of the RTGS system(s) and ensures that participants comply with the rules and regulations.</p> <p>MEPS+ is designated by MAS under the Payment and Settlement Systems (Finality and Netting) Act. All transactions settled by MEPS+ are thus final and irrevocable.</p>
Securities clearing and settlement systems	<i>Securities and Futures Act (SFA) (Chapter 289)</i>	MAS regulates CDP as a designated clearing house under the SFA.
Stored value facilities	<i>Payment Systems (Oversight) Act 2006: Part VII (Chapter 222A)</i>	This provides the legal framework for stored value facilities, with provisions for MAS to gather information from any issuer of SVFs.

<sup>1</sup> [Web link to Banking Act.](#) <sup>2</sup> [Web link to Payment Systems \(Oversight\) \(Singapore Dollar Cheque Clearing System And Inter-Bank GIRO System\) Regulations 2006.](#) <sup>3</sup> [Web link to Payment and Settlement Systems \(Finality and Netting\) Act.](#) <sup>4</sup> [Web link to Protocol for the Cooperative Oversight Arrangement of CLS.](#) <sup>5</sup> [Web link to Currency Act.](#) <sup>6</sup> External assets include gold and silver, among other assets, that can be stored locally in Singapore. <sup>7</sup> [Web link to Payment System \(Oversight\) Act.](#)

Other legislation that may be relevant to payment and settlement systems in Singapore includes the Bills of Exchange Act (Chapter 23), the Development Loan Act (Chapter 81), the Government Securities Act (Chapter 121A) and the Electronic Transactions Act (Chapter 88).

## 1.2 Role of MAS in payment, clearing and settlement systems

### 1.2.1 Settlement agent

MAS acts as a settlement agent for banks in Singapore by allowing funds transfers to take place across their RTGS accounts maintained in MEPS+. MAS also handles government-related payments and receivables that usually take the form of funds transfers between the government's accounts with MAS and with banks.

### 1.2.2 Operator

MAS operates MEPS+, a RTGS system which settles large-value interbank funds transfers (see Section 3.2). MEPS+ also handles the settlement of the cash leg of scripless SGS. Payment obligations that arise from trading in SGS and other Singapore dollar-denominated corporate debt between MEPS+ participants (which are typically banks in Singapore) are settled on a DVP basis through interfaces to the interbank funds transfer system in MEPS+ (see Section 4.2).

### 1.2.3 Overseer

MAS' oversight role for payment, clearing and settlement systems focuses on the objectives of safety and efficiency. With regard to safety, MAS seeks to ensure that payment, clearing

and settlement systems operate reliably without compromising financial stability. As for efficiency, MAS seeks to ensure that payment, clearing and settlement systems operate in a practical manner that is convenient for the users and efficient for the economy. In pursuing these objectives, MAS oversees both the operators and the participants in the payment, clearing and settlement systems. The main thrust of MAS' oversight is to ensure that the appropriate structures, processes and products are in place to safeguard stability and efficiency.

The PS(O)A is the cornerstone of MAS' payment systems oversight framework. It allows MAS to designate certain payment systems and subject them to its regulatory control. It also governs the issuance and management of SVFs.

A system is designated if it is considered a SIPS or a SWIPS. SIPS are systems where a failure or disruption can have an impact on the participants or cause wide systemic disruption in the financial system. SWIPS are systems where a failure or disruption in the system would not lead to systemic instability but could lead to widespread disruptions due to the large number of users relying on the system, thereby affecting public confidence. MAS' regulatory power over designated systems includes the power to request information, make regulations, inspect, investigate and establish an access regime.

MAS approval is also required for any multipurpose SVF (MPSVF) scheme with a total outstanding float of more than a prescribed threshold (currently SGD 30 million). In approving such a scheme, MAS requires the sponsoring bank(s) to be fully liable for the stored value. For all other MPSVFs, the holders of the stored value are required to disclose to potential users that they are not subject to MAS approval.

MAS regulates and supervises systemically important CCPs and securities settlement systems (SSSs) as designated clearing houses (DCHs) under the SFA and relevant subsidiary legislation, so as to reduce systemic risk and promote the safety and efficiency of clearing facilities that support systemically important markets or form an integral part of the financial infrastructure.

#### **1.2.4 Cooperation with other institutions**

MAS works with the industry to facilitate the development of Singapore's payment systems. It communicates with the industry regularly and conducts public consultations before implementing major regulatory changes. Examples of forums on payment system matters where MAS may participate are the Singapore Clearing House Association Management Committee and the Association of Banks in Singapore.

MAS also works closely with other government agencies when the operation of payment systems involves areas under their purview. For example, MAS works closely with the Ministry of Finance and the Infocomm Development Authority of Singapore on the promotion of e-payments and the introduction of new mobile payment methods. MAS also cooperates with foreign authorities in overseeing cross-border payment systems. For example, while CLS is a designated payment system under the Payment and Settlement Systems (Finality and Netting) Act, it is also overseen through an international cooperative oversight arrangement led by the Federal Reserve Bank of New York. MAS is a participating central bank in this mechanism for mutual assistance between central banks in their pursuit of shared public policy objectives for the safety and efficiency of payment and settlement systems.

### **1.3 The role of other private and public sector bodies**

#### **1.3.1 Singapore Clearing House Association (SCHA)**

The SCHA was formed in December 1980 to establish, manage and administer clearing services and facilities for the cheque, debit and credit items of its members. Membership is open to interested financial institutions and MAS. MAS chairs the SCHA.

The SCHA defines the bye-laws, rules and conditions governing the participating banks and operators of the SGDCCS, the USDCCS and the IBG system. It appoints the operator for the clearing systems and ensures that the operator provides the clearing services in accordance with the rules set by the SCHA, and that adequate business continuity arrangements are in place to manage risk of disruptions to the clearing services. In addition, the SCHA arbitrates disputes between members that may arise in connection with the clearing of cheques and GIRO items.

#### **1.3.2 Association of Banks in Singapore (ABS)**

The ABS is made up of member banks drawn from a wide spectrum of banks licensed by MAS. It represents the interests of its members, sets minimum standards of good practice, and supports projects of mutual benefit.

The ABS holds regular discussions with MAS regarding industry issues and the promotion of a sound financial system in Singapore. The ABS also provides input for legislation and guidelines relating to issues that affect the industry, including on payment and settlement systems.

### **1.4 The role of banks**

Commercial banks in Singapore may engage in a wide range of financial services, including traditional banking services such as loans and deposits, and investment banking business such as underwriting and distribution of equity and debt securities, corporate finance, fund management and unit trust management. As at end-September 2010, some 120 commercial banks were operating in Singapore, of which seven were locally incorporated.

Commercial banks are licensed under Chapter 19 of the Banking Act. Their activities are also governed by MAS' Notices to Banks and guidelines. Banks are currently the only institutions that may offer services across all segments of the payment process chain (issuing, acquiring, processing, clearing and settlement). However, new non-bank payment service providers are expected to play a greater role in the future.

## **2. Payment media**

### **2.1 Cash payments**

Cash remains the most widely accepted payment medium for small-value transactions. Under the Currency Act, MAS has the sole right to issue currency notes and coins in Singapore.



## **2.2 Non-cash payments**

### **2.2.1 Interbank GIRO**

The IBG system is an offline interbank payment system catering mainly for low-value bulk payments. IBG allows customers of participating banks to transfer funds via credit transfers and direct debits to and from the accounts of customers of any other participating bank. The net settlement amounts for IBG transactions are sent by the SACH to MEPS+ for settlement at the end of the day. In 2009, some 84.3 million eGIRO transactions were processed, up from 81.6 million in 2008. The value processed was SGD 218 billion, up from SGD 213 billion in 2008.

#### *2.2.1.1 Credit transfers*

In credit transfers, payers instruct their bank, physically or online, to debit their accounts and transfer the funds to the payee. In a standing order, payers instruct their bank to carry out the necessary transfers on a regular specific date, to a specific receiver and for a specific amount. Payroll crediting is the most common credit transfer. There is no maximum limit for each credit transfer.

In 2009, some 31.7 million credit transfer transactions were processed, up from 30 million in 2008. The value processed rose to SGD 158 billion, from SGD 153 billion in 2008.

#### *2.2.1.2 Direct debits*

Direct debit is an arrangement made by bank customers with a billing organisation (BO) to debit a designated bank account to pay regular bills (subject to an upper limit of SGD 25 million per direct debit). To set up a direct debit arrangement, customers sign a direct debit authorisation (DDA) form, which authorises their bank to allow the BO to initiate a regular collection instruction to deduct the required amount from a designated bank account. The signed DDA form is forwarded by the BO to the customer's bank for approval. Once it is approved, the BO issues instructions to its bank to collect bills from its direct debit customers. Examples of such preauthorised recurring payments are utility bill payments and payments for insurance premiums.

To facilitate faster processing of DDA forms, some banks tie up with their BOs to offer online DDA applications to customers with internet banking access. Other organisations allow DDA applications to be processed via EFTPOS terminals or through self-service kiosks such as the AXS stations.<sup>2</sup> These alternative DDA application methods allow DDA forms to be processed and approved more quickly.

In 2009, some 52.6 million direct debit transactions were processed, up from 51.5 million in 2008. The value processed was SGD 59 billion, the same as in 2008.

### **2.2.2 Cheques**

Cheques are commonly used in Singapore by consumers and businesses to charge or pay for goods and services. All banks in Singapore that clear SGD and local USD cheques use the Cheque Truncation System (CTS), an online image-based cheque clearing system introduced in 2003. Cheques are scanned into CTS when deposited at the bank, and their electronic images, rather than the physical cheques, are then transmitted through the clearing cycle. Cheque format has been standardised in the new system. More information on CTS can be found in Section 3.4.3.

---

<sup>2</sup> AXS is the operator of an electronic service delivery network (ESDN) for self-service kiosks.

In 2009, some 78.2 million SGD cheques were processed, down from 82.5 million in 2008. The value processed was SGD 536 billion, down from SGD 579 billion in 2008.

In 2009, some 0.90 million USD cheques were processed, down from 0.96 million in 2008. The value processed was SGD 48.9 billion, down from SGD 52.2 billion in 2008.

### **2.2.3 Payment cards**

#### *2.2.3.1 Electronic money*

In Singapore, electronic money is also commonly known as a stored value facility (SVF). SVFs are classified as either single-purpose stored value facilities (SPSVFs) or as multipurpose stored value facilities (MPSVFs). SPSVFs are used to pay for goods and services offered by the issuer only (eg prepaid phone cards), while MPSVFs allow customers to pay for goods and services offered by other merchants or organisations.

Under the PS(O)A, any entity can issue SVFs without MAS approval provided that total outstanding stored value remains below a prescribed threshold (currently SGD 30 million). This regulatory regime liberalises the SVF market and allows for flexibility in meeting consumer needs and providing additional choice in payment methods. Any MPSVF with outstanding stored value of more than SGD 30 million requires MAS approval as a widely accepted SVF (WASVF), together with the appointment of an approved bank.<sup>3</sup> Singapore's four widely accepted MPSVF schemes are the NETS CashCard, NETS FlashPay, the EZ-Link card and the Singapore Youth Olympic Games DBS Visa Prepaid Card (SYOG PPC).

Launched in November 1996 by the three domestic banks, the NETS CashCard started out as a contact-based MPSVF. Contactless card interfaces were introduced in July 2006. CashCard lets consumers pay in a cashless manner at a variety of retail outlets, car parks and vending machines. It can also be used to pay toll charges at Electronic Road Pricing (ERP) gantries and the checkpoints between Singapore and Malaysia. In addition, the CashCard can be used for online purchases with the use of a card reader. The CashCard can be reloaded with amounts of up to SGD 500 at bank ATMs, selected EFTPOS terminals and self-service kiosks with NETS CashCard access, as well as over the internet.

The NETS FlashPay,<sup>4</sup> launched in October 2009, is a contactless CEPAS<sup>5</sup> MPSVF card issued by NETS. It is currently accepted on public transport and at some retail outlets. It can also be used to pay tolls at ERP gantries and car parks. The NETS FlashPay can be reloaded with amounts of up to SGD 500 at ATMs, ticket offices at Mass Rapid Transit (MRT) stations, bus interchanges, convenience stores and self-service iNETS kiosks with NETS FlashPay access.

The EZ-Link card, launched in April 2002, is a contactless MPSVF issued by EZ-Link Pte Ltd and is primarily used to pay for public transport. EZ-Link cards are also accepted in some schools and shops, and at food and beverage outlets. Since September 2009, all EZ-Link cards have been CEPAS-compliant. They can be reloaded with amounts of up to SGD 500 at ticketing machines or ticket offices at MRT stations, bus interchanges and other locations, as

---

<sup>3</sup> The approved bank(s) will undertake to be fully liable for the outstanding stored value collected by the holder of the WASVF.

<sup>4</sup> Although both are issued by NETS, the NETS CashCard and NETS FlashPay run on different specifications and are not interoperable. NETS CashCard is contact-based and is used primarily for older-version in-vehicle units for toll charges. NETS FlashPay is CEPAS-compliant and can be used on the newer version in-vehicle units as well as for public transport.

<sup>5</sup> CEPAS, or Contactless ePurse Application, is Singapore's e-money standard. Its purpose is to facilitate interoperability of multipurpose stored value card payment schemes in the transit and other sectors.

well as over the internet. EZ-Link cards can also be reloaded automatically by linking them to a bank account or credit card account, so that funds are transferred to top up the EZ-Link Card whenever the stored value falls below a user-specified amount.

The DBS SYOG PPC, launched in March 2010, is a contactless MPSVF issued by DBS Bank Ltd. A proprietary form of a Visa Prepaid Card, its original purpose was to facilitate ease of payment for the officials, participants and spectators of the Singapore 2010 Youth Olympic Games. The SYOG PPC can be reloaded with amounts of up to SGD 500 at ATMs, selected retail outlets, and AXS self-service kiosks owned by DBS Bank, as well as over the internet. The cards continue to be valid after the Games.

The liberalisation of the SVF market has contributed to the emergence of many SPSVFs and limited-coverage MPSVFs, bringing about a substantial increase in SVF usage. From 2005 to 2009, the volume of electronic money transactions increased from 1.62 billion to 2.05 billion, while their value grew from SGD 1.42 billion to SGD 1.93 billion. Card take-up increased from 2.6 per capita in 2005 to 3.07 in 2009.

The launch of CEPAS brings consumers a significant step closer to the convenience of a single card for making transit, road toll and retail payments, as it can replace multiple cards for a variety of different purposes. When it is fully adopted, consumers will be able to use a single card seamlessly and safely in a wide range of payment scenarios. CEPAS will also allow a greater number of card issuers to participate in micro-payments.

#### 2.2.3.2 Automated teller machines (ATMs)

ATMs are another channel that allows bank customers to perform basic banking transactions without having to visit a branch. There were about 2,150 ATMs in Singapore in 2009, some 423 for every million inhabitants.<sup>6</sup>

Apart from depositing or withdrawing cash from their bank accounts, customers can use ATMs to apply for initial public offerings (IPOs), transfer funds to third parties, pay bills and reload their MPSVFs. The three major ATM networks in Singapore are the NETS OCBC-UOB network, the DBS-POSB network and the ATM 5 network.<sup>7</sup> Currently, ATMs are only interoperable within the respective ATM networks.

In 2009, some 204.8 million withdrawals with a total value of SGD 49.5 billion were made from ATMs.

#### 2.2.3.3 Debit cards

Debit cards are used to pay for goods and services or to withdraw cash. These transactions are effected through an online transfer of funds from the cardholder's bank or debit card account. Debit cards in Singapore are either PIN- or signature-based.

Examples of PIN-based debit cards are NETS EFTPOS and EPINS debit cards, with the former predominating. These cards let cardholders make payments for retail purchases at EFTPOS terminals or withdraw cash from their bank accounts at ATMs. Visa Debit and the Debit MasterCard are examples of signature-based debit cards.

In 2009, the number of debit card transactions rose to 205.1 million, from 182.4 million in 2008. The value processed was SGD 22.4 billion, up from SGD 20.5 billion in 2008.

---

<sup>6</sup> Population as at end-2009 from Department of Statistics Singapore.

<sup>7</sup> The ATM 5 network is run by MasterCard for six qualifying full banks: Citibank, Maybank, HSBC, Standard Chartered, ANZ and State Bank of India.

NETS introduced the EFTPOS service in 1986. ATM cards<sup>8</sup> issued by participating banks have a debit card function that lets cardholders pay for goods and services through an online transfer of funds from their accounts. EFTPOS terminals are available at government departments and major supermarkets, department stores, petrol stations, and a large number of smaller retail outlets. A cashback feature was added in 2001, allowing consumers to withdraw cash at the point of sale.

Since 2005, it has been possible to use China UnionPay (CUP) debit cards directly at NETS EFTPOS terminals in Singapore. CUP cardholders can also withdraw cash from a network of more than 1,500 ATMs operated by the local banks in Singapore.

In June 2010, Card Alliance Pte Ltd (Card Alliance) launched EPINS, a PIN-based debit payment service. Customers of partnering qualifying full banks (QFBs) can pay for their purchases with their ATM/debit cards at any of the merchant locations accepting EPINS debit payments in Singapore.

When the cardholder pays for a purchase with a PIN-based debit card, the issuer verifies the transaction and debits the cardholder's account accordingly before providing authorisation to the merchant through the EFTPOS network. The EFTPOS network settles the net debit and credit positions of the participating financial institutions through the settlement bank at the end of the day.

When the cardholder pays for a purchase with a signature-based debit card, the merchant submits the transaction to the acquirer, who verifies with the issuer through the card scheme operator. Once the issuer has verified that both the card number and transaction amount are valid, the merchant will process the transaction. After the transaction is authorised by the issuer, it is stored in a batch that the merchant later sends to the acquirer to receive payment (usually at the end of the day). The acquirer then sends the transactions in the batch to the card association, which debits the issuers for payment and credits the acquirer through its settlement bank.

All end-of-day transactions between the issuer and acquirer are conducted through the IBG.

#### 2.2.3.4 Credit cards

All major credit card brands, such as American Express, CUP, JCB, MasterCard and Visa, are issued and accepted in Singapore. The issuance of credit cards is subject to MAS guidelines and to regulations on, for example, income eligibility criteria and credit card marketing. With effect from 1 March 2009, MAS lowered the gross minimum income threshold for unsecured credit facilities from SGD 30,000 to SGD 20,000. However, this lower limit does not apply to credit cards, for which the threshold remains unchanged at SGD 30,000 for individuals at or below 55 years of age and SGD 15,000 for individuals above 55 years of age. The maximum aggregated credit limit for all unsecured personal credit facilities and credit or charge cards granted by individual financial institutions has also been revised and set at four times monthly income for individuals with at least SGD 30,000 in annual income. For individuals with annual income between SGD 20,000 and SGD 30,000, the maximum aggregated credit limit is twice monthly income. The unsecured lending provisions do not apply to high net worth Singaporean or permanent residents earning at least SGD 120,000 per annum and non-Singaporeans/permanent residents. Such individuals can qualify for unsecured credit in unrestricted amounts.

---

<sup>8</sup> A debit card allows the customer to access funds in a deposit account with a financial institution and to make payment for goods and services. ATM cards are a subset of debit cards that only let the customer access the financial institution's ATMs (or ATM network) and cash deposit machines.

The value of credit card transactions processed rose to SGD 26 billion in 2009, from SGD 25.7 billion in 2008.

## **2.2.4 Other access channels for banking and payments**

### *2.2.4.1 Telephone banking*

Since the introduction of phone banking in 1982, the range of services offered has increased. Besides being able to transfer funds from person to person and conduct account balance enquiries over the telephone, bank customers can also make bill payments, trade in stocks and bid for Certificates of Entitlement.<sup>9</sup>

### *2.2.4.2 Mobile banking*

Banking services have been available via mobile phones since the early 2000s. Some online purchases can be made via mobile phone instead of credit card. One payment method requires users to register their credit card account details with their mobile payment service provider. After payments are authenticated by means of an ID and PIN, they are processed as a credit card transaction. Another method charges the payment to the user's phone bill. Mobile payment solutions linked to a bank account are currently not widely available.

In June 2010, PayPal was selected by the Infocomm Development Authority (IDA) to be the mobile payment platform for the Singapore Digital Concierge, one of the key programmes in the IDA's 10-year Intelligent Nation Masterplan (iN2015) for the tourism, hospitality and retail sectors. The PayPal-IDA collaboration seeks to accelerate the growth of mobile commerce, making it easier for businesses and consumers to pay for goods and services securely via mobile phone.

### *2.2.4.3 Internet banking*

Internet banking allows consumers to conduct account balance enquiries, fixed deposit placements,<sup>10</sup> demand draft applications<sup>11</sup> and loan applications. In addition, payment services such as funds transfers (including transfers to third parties' accounts with other banks) and bill payments are available.

A number of banks have also launched internet payment services that let consumers pay for internet purchases by directly debiting their bank accounts. In addition, there are several online payment portals operating in Singapore. Internet banking services are proprietary and offered by banks individually.

MAS has issued guidelines to assist banks in establishing a sound and robust technology risk management framework to strengthen system security, reliability, availability and recoverability as well as deploy strong cryptography and authentication mechanisms to protect customer data and transactions. MAS encourages banks to adopt two-factor authentication (2FA) to enhance security and raise user confidence. A common 2FA implementation is the use of one-time passwords (OTPs) that are generated by a hardware token or sent by SMS to the customer's mobile phone.

---

<sup>9</sup> The Certificates of Entitlement (COE) system requires Singapore residents to bid for the right to buy a motor vehicle, with the number of certificates deliberately restricted. The COE allows holders to own a car for a period of 10 years in Singapore, after which they must either scrap or export their car with financial incentives, or bid for another COE at the prevailing rate if they wish to continue using their car for a further five or 10 years.

<sup>10</sup> Transferring funds (eg from a savings account) to a fixed deposit account.

<sup>11</sup> A demand draft allows the user to transfer funds to another account.

#### 2.2.4.4 Self-service machines

Following on from the ATMs that have allowed the public do their own banking since the 1980s, general self-service machines that are accessed with debit cards have gained in popularity since they were first launched in 2000. They can now be used to pay bills, buy movie tickets, book chalets, subscribe to magazines, reload stored value cards and even make donations to charity. Although self-service machines were slow to take off, incremental improvements and the greater reliability of the present generation of machines have resulted in steady growth. The two main self-service machine networks, AXS and SAM,<sup>12</sup> now have more than 750 installations across the country, capturing up to 20% of recurrent bill payment volume.

### 3. Payment systems (funds transfer systems)

#### 3.1 General overview

The key payment and clearing functions in Singapore are provided by a small number of major organisations.

1. MAS operates MEPS+, the settlement system for large-value interbank fund transfers. Payment obligations that arise from trading in SGS and in other SGD-denominated corporate debt are settled on a DVP basis via interfaces to the interbank funds transfer system in MEPS+ (see Section 4.2).
2. CLS settles foreign exchange (FX) transactions in 17 currencies including the Singapore dollar on a payment versus payment (PVP) basis, thereby eliminating FX settlement risk and providing netting efficiencies of up to 90% (see Section 3.3.1 for details of CLS). The three local banks in Singapore interface with CLS via a shared utility operated by the Clearing and Payment Services Pte Ltd (CAPS). Foreign exchange (FX) settlement of 17 major currencies occurs via the CLS system on a PVP basis. This system provides for greater efficiency in FX settlement with netting efficiencies of up to 90%. Singapore's three local banks connect to CLS Bank via CAPS using a single connection, rather than via direct connections between individual banks and CLS.
3. The SCHA provides three clearing systems for its member banks:
  - (i) SGDCCS;
  - (ii) USDCCS; and
  - (iii) IBG.

The SCHA provides SGD and USD cheque and interbank GIRO clearing services for its members through the SACH, which is operated by BCS. Banks' net obligations arising from the SGD Cheque Clearing System and the interbank GIRO system are settled through MEPS+ on a deferred same day basis. The settlement files are prepared by the SACH and sent to MEPS+ electronically at stipulated times.

---

<sup>12</sup> The two networks are typically not interoperable. Some merchants are linked to only one network. But both machines accept NETS EFTPOS as a form of payment. SAM stands for Self-service Automated Machine and is operated by Singapore Post.

Net obligations arising from the USD Cheque Clearing System are settled across participants' accounts held with Citibank, the settlement bank for USDCCS. The SACH prepares and sends the settlement files to Citibank at a stipulated time each working day.

4. Banks in Singapore operate about 2,150 ATMs. The major ATM networks in Singapore are:
- (i) the DBS-POSB ATM network;
  - (ii) the NETS OCBC-UOB network; and
  - (iii) the MasterCard ATM 5 network.

DBS-POSB customers can make cash withdrawals at any ATM in the DBS-POSB ATM network.

UOB and OCBC share their ATM network; the customers of one bank can withdraw money from the other's ATMs. Cash withdrawals are free from a customer's own bank, but a charge is levied after two withdrawals per month from the partner bank.

MasterCard ATM 5 lets customers make cash withdrawals at no charge for all ATMs in the network. It includes ATMs shared among six foreign banks: Citibank, Maybank, HSBC, Standard Chartered, Australia and New Zealand Banking Group Limited and the State Bank of India. For these banks, the customers have access to the shared ATMs in the network plus proprietary ATMs which can only be used by customers from the specific bank.

### **3.2 New MAS Electronic Payment System (MEPS+)**

MEPS+ is an RTGS system developed for large-value SGD interbank funds transfers and the settlement of scripless SGS transactions. MEPS+ consists of two subsystems, namely MEPS+ Interbank Funds Transfer (MEPS+-IFT) and MEPS+-SGS. MEPS+-SGS is described in more detail in Section 4.3.1.

An important feature of MEPS+ is the real-time and irrevocable transfer of funds and SGS. The settlement of the cash leg of SGD-denominated corporate and other government debt instruments can also be made through MEPS+ on a DVP basis.

Banks' current accounts held with MAS are structured to facilitate RTGS payments. At the start of the day at 06:00, funds maintained with MAS in the current account are transferred to the RTGS account, where they may be used for the settlement of MEPS+ payments from 09:00 to 19:00. Where an intraday Minimum Cash Balance (MCB)<sup>13</sup> requirement applies to a bank, only funds in excess of its intraday MCB requirement are transferred to the RTGS account from which funds are used for settlement.

MEPS+ is considered an SIPS and is designated under the PS(O)A.

#### **3.2.1 Operating rules**

MEPS+ is owned and operated by MAS. All participating banks are contractually bound to operate in compliance with the MEPS+ operating rules and regulations. The operating rules

---

<sup>13</sup> Under Section 39 of the Banking Act, all banks in Singapore are required to maintain an MCB with MAS calculated as an average fortnightly amount. On a day-to-day basis, a bank's closing MCB is allowed to vary within a band of 1% above or below the required 3% MCB, ie the closing MCB on any day should not drop below 2% of the liabilities base and any balance above 4% will not be counted towards the fortnightly average. The average closing MCB held over the fortnightly maintenance period must be at least 3% of the liabilities base.

cover areas such as general duties and responsibilities of the service provider and participants, as well as gridlock resolution, queue management and backup facilities.<sup>14</sup>

The regular weekday operating hours of MEPS+ are as follows:

<b>Time</b>	<b>System status</b>
06:00:00–08:59:59	System accepts forward-dated transactions only
09:00:00–19:00:00	System accepts same day value and forward-dated transactions
19:00:01–20:00:00	System accepts forward-dated transactions only

### **3.2.2 System participants**

All banks, local and foreign, licensed under the Banking Act are eligible to participate directly in MEPS+. Regulated non-banks of systemic importance may also seek approval from MAS to participate in MEPS+. Banks with small SGD payment volumes may choose not to participate in the system and, instead, to appoint a participating bank as their agent. While the terms of such agreements are negotiated bilaterally between the banks, and are outside the scope of MEPS+, MAS provides some services for these non-participating banks so that they can transfer funds and SGS from their MAS current accounts and SGS-Minimum Liquid Assets<sup>15</sup> (MLA) accounts, respectively. All banks licensed in Singapore hold a current account with MAS. MEPS+ participant banks can transfer funds from their current accounts to the RTGS account for settlement. There were 63 participating banks in MEPS+ at end-2009.

### **3.2.3 Types of transactions handled**

MEPS+ is designed to facilitate large-value SGD interbank funds transfers and to settle scripless SGS transactions on a DVP basis. In addition, it also maintains a real-time system link to the SGX Debt Securities Clearing and Settlement System (DCSS) for the cash leg settlement of listed SGD corporate debt securities on a DVP basis.

### **3.2.4 Operation of the transfer system and the transaction processing environment**

As MEPS+ is based on SWIFT infrastructure, participants use their existing SWIFT terminals and interfaces to submit payment instructions, manage queued transactions and perform online enquiries. Submitted payment instructions that fail to settle due to insufficient funds in a participant's account are queued with priority assigned by the participating bank. All queued instructions are settled according to their assigned priority levels on a first-in-first-out basis. Queued payments which cannot be processed at the end of a business day are cancelled and affected participants informed of such cancelled payments through appropriate SWIFT messages.

Some features of MEPS+:

- the use of SWIFT message formats, the SWIFT network and existing infrastructure at banks to streamline back office and cash management operations, increase straight through processing and reduce training, message translation and repair costs;

<sup>14</sup> [Web link to the MEPS+ service agreement.](#)

<sup>15</sup> Under Section 38 of the Banking Act, as part of the MLA requirements, all banks in Singapore must hold SGS equal to at least 10% of total liabilities, of which 5% must be outright holdings of SGS. The remaining SGS may be held under reverse repo transactions.



- parameterised queue management, to provide participants with advanced queue management capabilities for better liquidity and settlement risk management and increased efficiency;
- automated collateralised intraday liquidity facilities, to enable participants, particularly banks with low liquidity, to settle payments more efficiently and to increase system payments flow; and
- automated gridlock resolution, which detects and resolves gridlocks to prevent or reduce payment queues and to increase overall payments flow efficiency.

To mitigate operational risks, business continuity and disaster recovery plans are established and regularly tested by both MAS and participants. In addition, MEPS+ and participants' SWIFT systems are subject to periodic operational and technical audits by MAS' Internal Audit Department and MAS' bank examiners, respectively.

### **3.2.5 Settlement procedures**

Under the MEPS+-IFT subsystem, interbank funds transfers are made using SWIFT messages. Provided the paying bank has sufficient funds in its RTGS account, its same day payment instructions will be settled instantaneously and irrevocably.

MEPS+-IFT processes only same day value transactions. However, the system also accepts forward-dated transactions up to 14 working days ahead. Such forward-dated transactions are stored in the system and processed on the actual value date.

### **3.2.6 Credit and liquidity risks and their management**

To mitigate settlement risk, MAS allows banks to use the full amount of their reserves in excess of any MCB requirements imposed on an intraday basis. Participants may also request additional liquidity on an intraday basis through the use of automated collateralised intraday liquidity facilities. The intraday liquidity facilities are available only on business days and during MEPS+ operating hours. The availability of the intraday liquidity facility and the cutoff time for liquidity reversals are set out below:

<b>Activity</b>	<b>Monday–Friday</b>
Opening of facility	09:00
Close of facility	17:00
Liquidity reversals	17:30

Participants may be required to pay interest for each intraday repo transaction that is effected. MAS may from time to time notify the participant on the interest rate charged either through an announcement in MEPS+ or a general announcement on the MAS website. Currently, no interest is charged for usage of the intraday liquidity facility.

With effect from 24 July 2008, a MEPS+ participant may borrow SGD funds from MAS on an intraday and overnight basis by entering into an SGS repurchase transaction, if they have signed the PSA/ISMA Global Master Repurchase Agreement with MAS and deposit SGD funds with MAS on an overnight basis.

### **3.2.7 Pricing policies**

Fees and charges for MEPS+ participation and usage are set out in the MEPS+ Service Agreement and are reviewed periodically by MAS. MEPS+ participants are charged on a cost recovery basis, and the fees for the various components are as follows:

### MEPS+ pricing framework

#### (i) Time-based transaction charges

The MEPS+ pricing structure aims to improve payment safety and efficiency by encouraging banks to pay early in the day.

Settlement time band per transaction charge<sup>1</sup>

09:00–14:30	SGD 1.45
14:31–16:00	SGD 1.70
16:01–17:30	SGD 2.50
17:31–18:30	SGD 5.00

#### (ii) End-of-day statement messages

End-of-day statements<sup>2</sup> contain all the transactions and daily closing positions of participants. Participants are charged SGD 0.20 per SWIFT statement message to reimburse MAS for the SWIFT messaging costs incurred by MEPS+.

#### (iii) Annual subscription fee

Fee tiering is based on the assumption that banks with licences that allow for a wider range of banking activities derive more benefit from participating in MEPS+. This is because MEPS+ services can be used for the various banking activities offered.

<b>Bank category</b> <sup>3</sup>	<b>Annual subscription fee</b>
Local banks	SGD 16,000
Qualifying full banks	SGD 13,000
Full banks	SGD 7,500
Wholesale banks	SGD 2,000
Offshore banks	SGD 750
Clearing and settlement systems	SGD 2,000

#### (iv) Manual contingency charges

Manual contingency is a service provided by MAS for participants prevented by system failures from effecting payments or SGS transactions. MEPS+ has two manual contingency modes, one relying on the participant's instructions sent via MASNET, which is a secure e-mail network between financial institutions and MAS, and the other being a manual input mode. Both modes are subject to a SGD 100 per day activation fee to ensure that banks do not frivolously resort to the contingency mode. Each transaction submitted using MASNET is charged SGD 5 per transaction, the lower rate reflecting the greater efficiency compared with manual key-in.

<b>MASNET</b>	<b>Manual key-in</b>
SGD 100 activation fee (per day if used)	SGD 100 activation fee (per day if used)
SGD 5 per transaction	SGD 10 per transaction

<sup>1</sup> The charges below apply only to the bank sending a transaction. The receiving bank is not charged a fee.

<sup>2</sup> Participants can also log in to the system to monitor their payment flows during the day. <sup>3</sup> [Web link to an explanation of the various banking licences.](#)

### **3.3 Foreign exchange (FX) settlement systems**

#### **3.3.1 Continuous Linked Settlement (CLS)**

CLS allows cross-border currency transactions to be settled on a PVP basis. It is a real-time, global settlement system that eliminates the FX settlement risk arising from delays in settlement across time zones. The CLS service is offered by CLS Bank International<sup>16</sup> (CLS Bank), which links to the RTGS systems operated by central banks in 17 currencies.<sup>17</sup>

The CLS system offers greater liquidity efficiency, as it requires funding only of the netted values of the FX trades. As opposed to the correspondent banking model where full funding of the gross FX trade values is required, netting in CLS allows banks to manage their liquidity more efficiently, leading to reduced funding requirements and costs.

#### **3.3.2 Clearing and Payment Services Pte Ltd (CAPS)**

Incorporated in 2001, CAPS is a shared utility service owned and used by the three local banks, namely DBS, UOB and OCBC, to connect to CLS. DBS, UOB and OCBC are the Singaporean CLS members and CAPS, which is not a CLS member, merely acts as a link between the three local banks and CLS. It is the world's first collaborative payment utility designed to reduce CLS integration and operating costs. This initiative differs from the majority of the CLS settlement member banks, which have traditionally built direct connections to CLS Bank. Banks send their CLS foreign exchange trades to CAPS in a format of their choosing, where they are transformed into a CLS-compliant format for onward submission to CLS. CAPS essentially forms a link between its customer banks and CLS, achieving scale and efficiency economies for the participating banks.

### **3.4 Retail payment systems**

#### **3.4.1 Singapore Dollar Cheque Clearing System (SGDCCS)**

The operator of the SGDCCS is BCS. Direct participation in the SGDCCS is available only to ordinary SCHA members. Associate members can participate indirectly in the SGDCCS using a direct participating bank as their clearing agent. The SGDCCS is designated under the Payment and Settlement Systems (Finality and Netting) Act.

#### **3.4.2 USDollar Cheque Clearing System (USDCCS)**

The USDCCS was launched in 1996 to clear and settle US dollar-denominated cheques drawn on banks in Singapore. BCS is the appointed clearing operator and Citibank the settlement bank.<sup>18</sup> For the settlement of USD cheques, participating banks must maintain USD accounts with Citibank. In May 2010, the settlement method for USD cheques was changed from aggregated gross basis to a netted basis similar to that of SGDCCS. The netted settlement has resulted in significant liquidity savings for participants, and also

---

<sup>16</sup> CLS Bank is based in New York and is an Edge Corporation bank supervised by the Federal Reserve. CLS Services Pte Ltd is the operations arm of the CLS group and is located in London.

<sup>17</sup> US dollar, euro, sterling, Japanese yen, Swiss franc, Canadian dollar, Australian dollar, Swedish krona, Danish krone, Norwegian krone, Singapore dollar, Hong Kong dollar, New Zealand dollar, Korean won, South African rand, Israeli shekel and Mexican peso. For more details on CLS, see the corresponding chapter in the forthcoming second volume of this publication.

<sup>18</sup> A tender is carried out every five years to appoint the operator and settlement bank.

mitigates banks' exposure to the settlement bank. The USDCCS is designated under the Payment and Settlement Systems (Finality and Netting) Act.

### **3.4.3 Cheque Truncation System (CTS)**

In July 2003, banks in Singapore migrated to a new cheque clearing system, known as the CTS. Both SGD- and USD-denominated cheques presented to and drawn on banks in Singapore are cleared through CTS. CTS originated as an initiative from the SCHA and the ABS to enhance the operational efficiencies of the banking industry. CTS is the world's first nationwide end-to-end cheque truncation system. It uses imaging and internet technologies to scan cheques at the point of deposit and transmit the images over a secured communication network. Physical movement of paper cheques has given way to digital information, resulting in a more efficient, one-day cheque clearing cycle.

The clearing and settlement process of an SGD cheque is as follows:

1. The payer sends a cheque to the payee.
2. The payee deposits the cheque at the presenting bank (payee's bank), which credits the payee's account provisionally ("on hold" cheques).
3. The presenting bank captures the cheque images and magnetic ink character recognition (MICR) data before transmitting them electronically to the SACH via a secured private network.
4. After clearing the cheques and determining the net settlement amount for each participating bank, the SACH sends the net clearing figures to MEPS+, which in turn transmits the figures to the participating banks before performing settlement by debiting and crediting the participating banks' settlement accounts.
5. The SACH processes and sorts the data, and makes them available electronically for downloading and processing by the paying banks.
6. If the paying bank (payer's bank) rejects a cheque, it returns the unpaid cheque images and MICR data to the presenting bank through the SACH on the next business day.
7. The settlement amount for both paying and presenting banks is adjusted accordingly by the SACH in the figure sent to MEPS+ that day.
8. If the cheque is cleared successfully, the payee can withdraw the "on hold" funds after 14:00 on the second business day.

The SACH transmits the multilateral net positions of all direct and indirect participants to MEPS+ twice a day. Midday multilateral net settlement positions are made known to participating banks at 15:05, and net debit banks have until 15:45 to fund their MEPS+ accounts. End-of-day multilateral net settlement positions are made known to participating banks at 18:15, and banks have until 18:45 to fund any net debit positions.

The clearing process for USD cheques is similar to that of SGD cheques. However, there is only one settlement per day across participating banks' accounts with the settlement bank, Citibank.

If any participating bank fails to settle its obligations by the deadline specified, it is considered to be in default and may be suspended from clearing. This means that it can no longer present cheques and no other participating banks can present cheques drawn on the suspended bank. The SACH will recast figures of all participating banks and exclude those of the suspended bank. MAS may allow the suspended bank to be readmitted if it demonstrates that it can take steps to ensure that its obligations arising out of the clearing can be fulfilled.

Pursuant to the PS(O)A, in an emergency situation MAS may assume control of and carry on the operations of the clearing system or the settlement bank, or direct some other person to do so on behalf of MAS.

#### **3.4.4 Interbank GIRO (IBG)**

IBG is a paperless system that lets customers of participating banks transfer funds, via direct debits and credit transfers, to and from the accounts of customers of any other participating bank. In July 2001, the SACH, the IBG's operator, upgraded the IBG system to a browser-based system called eGIRO, thus eliminating the physical transfer of magnetic tapes between participating banks and the SACH. Participating banks can now electronically send and receive IBG items, including returned and rejected items, via a secure communication network on a same day basis.

In December 2008, an enhanced eGIRO system, known as eGIRO+, which makes use of the existing eGIRO network infrastructure, was piloted by some of the participating banks. Its features include an extended clearing window for submission of files to the SACH as well as the capability to receive files from the SACH via straight through processing.

There is only one settlement session for IBG payment instructions including eGIRO+ transactions. End-of-day multilateral net settlement positions are broadcast across MEPS+ at 18:15, and banks have until 18:45 to fund any net debit positions.

IBG is designated under the Payment and Settlement Systems (Finality and Netting) Act.

Any participating bank that fails to settle its obligations by the deadline specified in the rules of the settlement bank can be excluded from settlement. As with the SGD and USD Cheque Clearing System, a recasting process will then take place.

#### **3.4.5 ATM networks**

Most banks in Singapore have proprietary ATM networks, but there are linkages between these networks to provide consumers with wider access. There are currently three major ATM networks in Singapore:

- the POSB-DBS ATM network, which was established following the merger of POSB and DBS in 1998. This network is a proprietary intrabank network run by DBS;
- the NETS OCBC-UOB ATM network, a shared interbank ATM network of the other two local banks (UOB and OCBC); and
- the MasterCard ATM 5 network. This is a shared network of six QFBs, with the switching done by MasterCard.<sup>19</sup>

For transactions using the NETS OCBC-UOB ATM network, the switching is done by NETS. When a cardholder performs a transaction at an ATM of another bank, NETS switches the transaction to the issuing bank for authorisation, which involves verification of the PIN, checking that sufficient funds are available and authenticating the transaction. The issuing bank then sends its response back via NETS, which switches it to the ATM being used, and the transaction is completed.

If cardholders perform transactions at their own bank's ATMs, these require no switching, as the issuing bank is able to approve them directly.

---

<sup>19</sup> The ATM 5 network consists of Citibank, Maybank, HSBC, Standard Chartered Bank, ANZ and State Bank of India.

During clearing, NETS calculates the bilateral net settlement positions for each member bank. The net amount is then provided to the settlement bank, DBS Bank, for direct debiting or crediting of the member banks' accounts maintained with DBS Bank. Member banks manage their nostro accounts at DBS Bank through MEPS+.

Cirrus and Plus cash withdrawals are cleared by MasterCard and Visa, respectively, on a similar principle to NETS. When currency conversion is performed, the exchange rates are determined by MasterCard and Visa on a daily basis. Settlement for these transactions is conducted through the settlement banks for the respective card schemes.

## **4. Systems for post-trade processing, clearing and securities settlement**

### **4.1 General overview**

The three main providers of post-trade services in Singapore are MAS, the CDP and SGX-DC. Both the CDP and SGX-DC are wholly owned subsidiaries of SGX.

1. The MEPS+-SGS subsystem at MAS clears and settles SGS trades on a DVP basis.
2. The CDP is the CSD and SSS for Singapore equities, corporate debt securities and other securities. CDP also provides CCP clearing for Singapore equities. CDP operates two systems :
  - (i) the CDP Clearing & Settlement System (C&S), which is used to clear and settle securities trades executed on the trading platform of Singapore Exchange Securities Trading (SGX-ST); and
  - (ii) the Debt Securities Clearing and Settlement System (DCSS), a gross DVP settlement system used for the settlement of transactions in the over-the-counter (OTC) market for private bonds. No netting is carried out.
3. SGX-DC provides CCP clearing and settlement for all derivatives contracts traded on the Singapore Exchange Derivatives Trading Ltd (SGX-DT), and for certain classes of OTC derivatives contracts such as oil and coal swaps and freight forward agreements.

There are currently no dedicated trade confirmation systems or trade repositories operating in Singapore.

### **4.2 Central counterparties and clearing systems**

#### **4.2.1 CDP**

##### *4.2.1.1 Institutional framework*

CDP is a designated clearing house regulated under the SFA and its relevant subsidiary legislation. The CDP clearing rules and DVP rules govern its operations, its admission requirements and the ongoing obligations of its members.

##### *4.2.1.2 Participation*

Participation in CDP is restricted to clearing members, who must meet minimum membership criteria such as base capital and ongoing risk-based capital requirements. CDP had 25 clearing members as at October 2010, comprising broker-dealers and banks.

#### 4.2.1.3 Types of transactions

CDP clears and settles equities, structured warrants, company warrants, corporate bonds, extended settlement contracts, real estate investment trusts (REITs), exchange-traded funds (ETFs), exchange-traded notes (ETNs), business trusts, American depository receipts (ADRs) and global depository receipts (GDRs) that are traded on SGX-ST.

#### 4.2.1.4 Operation of the system

CDP begins the clearing process with trade matching, which occurs immediately on execution of the trade in the SGX-ST trading engine, Quotation and Execution System for Trading (QUEST-ST), a fully automated trading platform. Once the trade is matched, CDP becomes the CCP to each side of the transaction through novation, thus guaranteeing performance to the brokers on each side of the trade. On T+1, CDP informs each clearing member of its money and securities obligations.

Trades are settled on CDP in a T+3 settlement cycle, with securities settled on a gross basis while cash is settled on a net basis. For securities settlement, CDP debits the securities from the selling broker's clearing account and credits the buying broker's clearing account. For cash settlement, each clearing member has to maintain an account with any of the six CDP-authorized settlement banks. CDP maintains an account with each settlement bank in addition to an account with its clearing bank.<sup>20</sup> On the due date, CDP issues debit and credit instructions to each settlement bank. The buying clearing member's account will be debited and funds will be credited to CDP's account. Subsequently, the settlement bank will debit CDP's account and make payment to the selling clearing member.

#### 4.2.1.5 Risk management

CDP maintains rules to ensure that clearing members maintain adequate controls and sufficient financial resources to meet their obligations to CDP. Clearing members are subject to close supervision and inspection, and their settlement obligations are monitored daily.

CDP also maintains a clearing fund that is applied if a clearing member is unable to discharge its financial obligations to CDP. All clearing members are required to contribute to the clearing fund, with contributions varying in proportion to the clearing member's traded volume. CDP also contributes to the clearing fund and maintains a standby credit line.

If a clearing member defaults, CDP first applies any collateral or security deposit placed by the defaulting member with CDP. If these funds are insufficient, CDP applies the clearing fund in the following order:

- contributions to the clearing fund made by the defaulting member;
- CDP's contributions to the clearing fund;
- contributions made by all other clearing members, on a pro rata basis; and
- CDP's standby line of credit.

If the clearing fund is insufficient to cover the discharge of financial obligations, CDP will use its capital to cover any additional losses.

#### 4.2.1.6 Pricing

CDP charges clearing fees of 4 basis points of contract value, subject to a cap of SGD 600 per contract.

---

<sup>20</sup> The clearing bank acts as a payment and collection agent on CDP's behalf to handle money settlement between settlement banks. The clearing bank also guarantees CDP against a default by a settlement bank.

#### 4.2.1.7 *Links to other systems*

CDP does not link to other CCP systems.

#### 4.2.1.8 *Major ongoing and future projects*

CDP is launching a link to MEPS+ for settlement of SGD transactions. When completed, the clearing bank will no longer act as a payment and collection agent for CDP, but will continue to guarantee CDP against a default by a settlement bank.

### 4.2.2 **SGX-DC**

#### 4.2.2.1 *Institutional framework*

SGX-DC is a designated clearing house, regulated under the SFA and relevant subsidiary legislation. The SGX-DC clearing rules govern its operations, its admission requirements and the ongoing obligations of its members.

#### 4.2.2.2 *Participation*

Participation in SGX-DC is restricted to clearing members, who must meet minimum membership criteria such as base capital and ongoing risk-based capital requirements. SGX-DC had 24 clearing members as at October 2010, comprising broker-dealers and banks.

#### 4.2.2.3 *Types of transactions*

SGX-DC clears futures and options contracts on interest rates, stock indices, dividend indices and commodities traded on SGX-DT, and OTC derivatives contracts such as oil and coal swaps and freight forward agreements.

#### 4.2.2.4 *Operation of the system*

SGX-DC operates SGXClear, the system used to clear derivative products traded on SGX-DT. SGX-DC acts as the CCP to all executed trades. Novation occurs as soon as a trade is matched in SGX-DT's trading engine, QUEST-DT. As a consequence, all financial obligations arising from the trade are guaranteed by SGX-DC.

SGX-DC revalues all open positions on a daily basis based on the latest market prices and computes the gains and losses of all open positions. Margin calls are made on the clearing member if existing margins held with SGX-DC are inadequate. Similarly, the clearing member has to pay for computed mark to market losses on open positions. There are four clearing cycles, and debit instructions are sent to SGX-DC's settlement banks to instruct them to debit clearing members' accounts for mark to market losses and margin calls. On receiving these settlement instructions, each settlement bank is required to confirm to SGX-DC by a stipulated deadline via SWIFT that it is able to carry out the instructions.

#### 4.2.2.5 *Risk management*

SGX-DC's safeguards for its clearing process include an effective margin system for contracts cleared, daily marking to market of outstanding positions, an adequate clearing fund based on daily stress testing of members' outstanding positions, and ongoing supervision of members to ensure their financial adequacy.

If a clearing member defaults, SGX-DC will first apply any collateral, margins or security deposits placed by the clearing member with SGX-DC. If these funds are insufficient, SGX-DC will apply the clearing fund in the following order:



- SGX-DC's contributions to the clearing fund, up to 15% of the total clearing fund size;
- contributions to the clearing fund made by other members clearing the same contracts as the defaulting members, on a pro rata basis;
- the remainder of SGX-DC's contributions to the clearing fund; and
- contributions to the clearing fund made by all other members, on a pro rata basis.

If the clearing fund is insufficient to cover the discharge of financial obligations, SGX-DC will use its capital to cover any additional losses.

#### 4.2.2.6 *Links to other systems*

An inter-exchange allocation functionality is available in SGXClear to allow clearing members to allocate trades to clearing members of the Chicago Mercantile Exchange (CME) on a real-time basis. In addition, clearing members can accept incoming CME trades in real time.

#### 4.2.2.7 *Major ongoing and future projects*

SGX-DC is launching a new clearing service for OTC financial derivatives, starting with the clearing of interest rate swaps denominated in Singapore and US dollars.

### 4.3 **Securities settlement systems**

#### 4.3.1 **MEPS+-SGS**

##### 4.3.1.1 *Institutional framework*

MEPS+-SGS is governed by the same institutional framework as MEPS+. Details can be found in Section 3.2.1.

##### 4.3.1.2 *Participation*

The eligibility criteria for participating in MEPS+-SGS are the same as for MEPS+. Details can be found in Section 3.2.2.

##### 4.3.1.3 *Types of transactions*

MEPS+-SGS settles scripless SGS transactions on a DVP basis. Participants in the MEPS+-SGS subsystem may hold the following accounts, depending on the type of financial institution:

- *Trade account*  
SGS holdings in excess of minimum MLA requirements are maintained in this account. SGS holdings in this account can be used for settlement.
- *Reserve account*  
To maintain SGS for compliance with MLA requirements.
- *Customer account*  
To maintain SGS that belong to a participant's customer.
- *Non-resident accounts*  
To maintain SGS that belong to a participant's non-resident customer. Different accounts may be created for non-resident customers who are subject to various levels of withholding taxes.
- *ILF account*  
To maintain SGS pledged under an intraday liquidity facility (ILF) arrangement.

#### 4.3.1.4 Operation of the system

The operation of MEPS+-SGS is the same as for MEPS+. Details can be found in Section 3.2.4.

#### 4.3.1.5 Risk management

To mitigate settlement risk, the MEPS+-SGS is linked to the MEPS+-IFT system to facilitate the settlement of SGS transactions on a DVP basis. If the seller of SGS has insufficient SGS for delivery, the transaction is queued in MEPS+-SGS until sufficient SGS are made available. Once the seller has sufficient SGS, the SGS are earmarked for transfer to the buying bank and an IFT payment message is sent to MEPS+-IFT.

If the buying bank has insufficient funds to pay for the SGS purchase, the payment is queued in MEPS+-IFT. When the funds become available, the amount is debited from the buyer's RTGS account and credited to the seller's RTGS account. The MEPS+-IFT subsystem simultaneously instructs the MEPS+-SGS subsystem to transfer the securities to the purchasing bank.

#### 4.3.1.6 Links to other systems

MEPS+-SGS is linked to MEPS+-IFT to facilitate the settlement of SGS transactions on a DVP basis. CDP participates in MEPS+-SGS to provide SGS custody service for retail investors.

#### 4.3.1.7 Use of the system by the central bank

MEPS+ provides final and irrevocable settlement of SGS transactions on both a free-of-payment (FOP) and DVP basis. The issuance of SGS within MEPS+-SGS is on a DVP basis. On the issuance date, MEPS+-SGS automatically performs issuance to the successful bidders on a DVP basis. That is, the securities are issued and transferred into the successful bidders' securities accounts only after the successful bidders' MEPS+-RTGS accounts are successfully debited.

For SGS coupon payments within MEPS+-SGS, MEPS+-SGS automatically calculates the coupon payment at the beginning of the ex-date according to the coupon rate and coupon frequency of the securities and the members' holdings. The ex-date period, coupon payment date, coupon payment rate and coupon payment frequency are specified for each SGS issue in MEPS+-SGS at the start and MEPS+-SGS will derive the rest of the coupon payment schedule accordingly.

On the coupon payment date, MEPS+-SGS automatically pays the calculated coupon amounts to the holder (as at ex-date) of the SGS by debiting the MAS' MEPS+-RTGS account and crediting the holder's MEPS+-RTGS account. For all outstanding (as at ex-date) interbank repo transactions in MEPS+-SGS, the reverse interest amounts will also be automatically debited from the original receiving member's account (ie the receiving member for the opening leg of the transaction) and credited to the original delivering member's account.

For SGS redemptions within MEPS+-SGS, MEPS+-SGS automatically calculates the redemption proceeds that are due to holders on the maturity date. The maturity date is specified for each SGS issue in MEPS+-SGS. On the maturity date, MEPS+-SGS automatically calculates the redemption proceeds according to the quantity of SGS holdings. MEPS+-SGS then pays the redemption proceeds to the existing holder of the SGS on a DVP basis by debiting the MAS' MEPS+-RTGS account and crediting the relevant member's MEPS+-RTGS account while also redeeming the SGS from the respective SGS accounts.

## **4.3.2 CDP**

### *4.3.2.1 Institutional framework*

The settlement of securities is governed by the CDP clearing rules and DVP rules. CDP as a central depository is governed under the Companies Act. CDP's depository system allows retail investors to hold direct accounts besides accounts held by depository agents (custodian banks). CDP's terms and conditions govern the depository and the depositors.

### *4.3.2.2 Participation*

The participants in the securities settlement system are clearing members and depository agents. After CCP clearing and netting have occurred, CDP effects securities settlement between clearing members for trades done on SGX-ST. For institutional trades, CDP also effects securities settlement between clearing members and institutional investors through depository agents. For retail trades, CDP effects securities settlement between clearing members and retail investors.

### *4.3.2.3 Types of transactions*

CDP settles equities, structured warrants, company warrants, corporate bonds, extended settlement contracts, REITS, ETFs, ETNs, business trusts, ADRs and GDRs that are traded on SGX-ST.

CDP also operates a securities settlement system for corporate bonds traded on the OTC market, the DCSS, a gross DVP settlement system. CDP does not act as the central counterparty for such trades.

### *4.3.2.4 Operation of the system*

Securities certificates are immobilised with CDP, which operates as a CSD. Although the deposited securities at the CDP are registered in its name, CDP acts as a bare trustee, holding the securities on behalf of investors. Investors maintain securities accounts with CDP, and their securities holdings are reflected in these accounts. Depository agents and custodian banks may also maintain sub-accounts for those investors who do not maintain a direct account with CDP (eg overseas investors).

Under the book-entry settlement system, the transfer of securities ownership is effected through computerised book entries. On T+3, for retail investor trades, the buying clearing member will pay funds to CDP, while CDP will pay funds to the selling clearing member. After payment obligations are settled, CDP will debit securities from the seller's account and credit them to the selling broker's account. Subsequently, the securities will be debited from the selling broker's account and credited to the buying broker's account before they are credited to the buyer's account. If CDP determines that the selling broker has insufficient securities on T+2, CDP will automatically buy in against the selling broker on T+3, who will also be subject to penalties. Investors then settle money payments with their brokers.

Institutional investors can opt not to settle their trades with their brokers but with CDP via DVP. Depository agents or custodian banks settling on behalf of institutional investors use the Pre-Settlement Matching Service (PSMS), an open-access infrastructure developed by SGX. PSMS automates the matching of settlement instructions between the settling parties of institutional trades. If an investor opts to settle trades under the DVP rules, a custodian bank undertakes vis-à-vis CDP that it has sufficient securities or funds to meet the transaction obligations. For matched delivery instructions, CDP is irrevocably authorised to debit the securities from the relevant sub-accounts of the custodian bank. CDP's system will

then earmark the securities to be delivered by moving them from the “free” balance to the “available” balance.<sup>21</sup>

Cash settlement is net of all the matched and validated DVP purchase and sale settlement instructions for a settlement day. The net paying settlement banks pay CDP’s clearing bank, and the clearing bank in turn pays the net receiving settlement banks on behalf of CDP with cash settlement finality at the end of T+3.

As mentioned above, CDP also operates DCSS, a securities settlement system for private bonds traded on the OTC market. OTC bond transactions can be settled on a DVP or FOP basis. Funds are transferred via MEPS+ and securities are simultaneously transferred via the DCSS book-entry system on a gross trade-for-trade basis. A real-time DVP arrangement is achieved through a live leased line link between DCSS and MEPS+. On a FOP settlement basis, the transacting parties use CDP only for securities transfer and arrange for funds transfer separately.

#### *4.3.2.5 Risk management*

In respect of trades settled on a DVP basis, CDP is exposed to the direct counterparty risk of the settlement banks settling for institutional clients. CDP’s guarantee for DVP trades is supported by a two-tier guarantee of the settlement banks and the clearing bank. The settlement bank guarantees to make payment on behalf of the custodian banks once a settlement instruction is matched and validated. If the settlement bank is unable to make payment on the due date, the clearing bank is obliged to make the required payment.

#### *4.3.2.6 Links to other systems*

International central securities depositories (ICSDs) such as Euroclear and Clearstream also participate in the Singapore securities market. Trades done outside Singapore can be settled through ICSDs. These ICSDs have indirect linkages with CDP through their depository agents, which facilitate clearing and settlement for international investors in their systems. Transactions can be settled on a DVP or FOP basis.

### **4.4 Use of securities infrastructure by the central bank**

The MAS Standing Facility was launched in 2006 to manage intraday interest rate volatility and to serve as a safety valve for the banking system. The Standing Facility allows banks to place excess funds with or borrow from MAS against SGS collateral. Such funds transfers and DVP SGS transfers are effected in MEPS+.

---

<sup>21</sup> For securities in the “free” balance, the account holder has full legal title to them, while securities in the “available” balance are either securities purchased by the account holder but not yet paid for, or securities earmarked for subsequent transfers.



**Payment, clearing and  
settlement systems in  
Sweden**



## Contents

List of abbreviations.....	361
Introduction.....	363
1. Institutional aspects.....	364
1.1 The general institutional framework .....	364
1.2 The role of the central bank .....	365
Oversight.....	366
The provision of an interbank settlement system.....	367
1.3 The role of other public and private sector bodies .....	367
Public sector bodies .....	367
Private sector bodies.....	368
2. Payment media used by non-banks .....	369
2.1 Cash payments .....	369
2.2 Non-cash payments .....	369
2.2.1 Credit transfers .....	369
2.2.2 Cheques and money orders.....	370
2.2.3 Direct debits.....	370
2.2.4 Credit and debit cards.....	371
2.2.5 Prepaid cards.....	371
2.3 Recent developments .....	371
3. Payment systems (funds transfer systems).....	372
3.1 General overview .....	372
3.2 Large-value payment system .....	372
3.2.1 RIX.....	372
3.3 Retail payment systems .....	375
3.3.1 Bankgirocentralen BGC AB .....	375
4. Systems for post-trade processing, clearing and securities settlement.....	377
4.1 General overview .....	377
4.2 Central counterparties and clearing systems .....	378
4.2.1 NASDAQ OMX Derivatives Markets, central counterparty .....	378
4.2.2 European Multilateral Clearing Facility, central counterparty.....	381
4.3 Securities settlement systems.....	382
4.3.1 Euroclear Sweden, securities settlement system .....	382
4.4 Use of securities infrastructure by the central bank .....	384





## List of abbreviations

ACH	automated clearing house
ATM	automated teller machine
BGC	Bankgirocentralen BGC AB
CDS	credit default swap
CLS	Continuous Linked Settlement
CCP	central counterparty
CSD	central securities depository
DKK	Danish krone
DVP	delivery versus payment
EEA	European Economic Area
EMCF	European Multilateral Clearing Facility N.V
ERP system	Enterprise Resource Planning system
ESCB	European System of Central Banks
EU	European Union
EUR	Euro
IR TRR	Interest Rate Trade Reporting Repository
LOM	liquidity optimisation mechanism
MiFID	Markets in Financial Instruments Directive
NASDAQ OMX DM	NASDAQ OMX Derivatives Markets
NOK	Norwegian krone
OTC	over the counter
PNC	PAN Nordic Card Association
POS	point of sale
RIX	Riksbank funds transfer system
RTGS	real-time gross settlement
RTM	real-time settlement mechanism
SCP	Scandinavian Cash Pool
SEK	Swedish krona
SEPA	Single Euro Payments Area
SIA-SSB	Società Interbancaria per l'Automazione – Società per i Servizi Bancari
SSDA	Swedish Securities Dealers Association
SSS	securities settlement system
STP	straight through processing
USD	US dollar



## Introduction

Sveriges Riksbank is the Swedish central bank. According to the Sveriges Riksbank Act (*Lagen om Sveriges riksbank, 1988:1385*), the Riksbank is responsible for promoting a safe and efficient payment system.<sup>1</sup> To this end, the Riksbank oversees the payment, clearing and settlement systems, provides for the stability of the financial system and ensures the supply of banknotes and coins. In the Swedish payment system, the Riksbank has both an oversight role and an operational role. The Financial Stability Department is responsible for the oversight role, while the Asset Management Department performs the operational functions.

Finansinspektionen is the Swedish financial supervisory authority and is responsible for the supervision of companies operating in the credit, insurance and securities markets, including the supervision of all clearing organisations. The Ministry of Finance is the Swedish government office responsible for, inter alia, the drafting of legislation regulating the financial sector.

The Riksbank owns and runs the funds transfer system, which is known as RIX. RIX started operating in 1990. In 2009 the technical system and the technical platform were replaced with a new system from the Italian firm Società Interbancaria per l'Automazione – Società per i Servizi Bancari (SIA-SSB).

The Swedish central securities depository (CSD), Euroclear Sweden, operates the securities settlement system (SSS). Equities, bonds and money market instruments are all dematerialised within an in-house-developed system.

NASDAQ OMX runs the Swedish stock exchange, the derivatives exchange and the electronic inter-dealer exchange for certain government bonds. This same entity acts as the central counterparty (CCP) for derivatives and repo transactions. A new CCP, the European Multilateral Clearing Facility (EMCF), was introduced in the Swedish equity market in 2009. EMCF acts as a CCP in the clearing of cash equity transactions on the NASDAQ OMX exchanges in Stockholm, Copenhagen and Helsinki and on some other multilateral trading platforms operating in the Nordic countries.

There is one major retail payment system in Sweden. Bankgirocentralen BGC AB (BGC) offers automated clearing house (ACH) services with settlements occurring on participants' accounts in RIX.

In terms of transaction volumes, retail payments in Sweden are dominated by card transactions. Usually, cards issued in Sweden are connected to one of the international systems, Visa or MasterCard. However, in terms of transaction value, credit transfers and direct debits together account for the vast majority of all non-cash transactions while card transactions only account for a minor part. Nearly all credit transfers and direct debits are initiated electronically. The value and the number of cheque transactions, money orders or other paper-based credit and debit payment instruments are very low.

---

<sup>1</sup> The Swedish term "Betalningssystem" (typically translated as "payment system") here refers to the payment system in a broad sense and not to a particular payment or settlement system.

## 1. Institutional aspects

### 1.1 The general institutional framework

As Sweden's central bank, the Riksbank is an authority that reports to the Riksdag, the Swedish parliament. The Riksbank is responsible for monetary policy with the aim of maintaining price stability. The Riksbank is also mandated to promote a safe and efficient payment system (see Section 1.2). Additionally, the Riksbank issues banknotes and coins and manages the reserves of gold and foreign currencies.

Finansinspektionen is the Swedish financial supervisory authority. Finansinspektionen supervises companies in the credit, insurance and securities markets, including all clearing organisations.

The Ministry of Finance is the Swedish government office responsible for, inter alia, drafting legislation regulating the financial sector (credit institutions, securities firms, funds management, stock exchanges, clearing houses and insurance companies).

The principal laws forming the legal framework for the payment and settlement systems infrastructure in Sweden are listed and briefly described below:<sup>2</sup>

- The Sveriges Riksbank Act (*Lagen om Sveriges riksbank, 1988:1385*) states that the Riksbank shall, inter alia, "promote a safe and efficient payment system". The Riksbank may make available systems for settlement of payments and in other ways participate in the settlement of payments. It may also grant intraday credit to participants in the system against adequate collateral. A credit institution or any other company supervised by Finansinspektionen has the obligation, on the Riksbank's request, to provide it with such information as the Riksbank considers necessary in order to fulfil its task of promoting a safe and efficient payment system.
- The Payment Services Act<sup>3</sup> (*Betaltjänstdirektivet, 2007/64/EG*) aims to harmonise legislation on payments in the EU/EEA and also to strengthen consumer protection in connection with payments in euros (EUR) and the currencies of member states outside the euro area. It also represents a step towards the harmonisation of the payment market that the Single Euro Payments Area (SEPA) aims to achieve. The directive regulates, among other things, the right of direct debit payers to request repayment of incorrectly executed direct debits. It also provides guidelines on the responsibilities of banks and consumers in cases where an unauthorised transaction has occurred, for example, in connection with some forms of payment card fraud. In addition, an entirely new category of payment institution has been introduced which is entitled to mediate payments, but also to provide credit in connection with the payment service.
- The Settlement Systems Act on systems for settlement of obligations on the financial market (*Lagen om system för avveckling av förpliktelser på finansmarknaden, 1999:1309*) is based on the EC Directive on settlement finality in payment and securities settlement systems (Settlement Finality Directive).<sup>4</sup> It

---

<sup>2</sup> Other relevant laws are briefly described in *The Swedish Financial Market 2010*, which can be downloaded from the Riksbank website [www.riksbank.se](http://www.riksbank.se).

<sup>3</sup> The act transposes Directive 2007/64/EC of the European Parliament and of the Council of 13 November 2007 on payment services in the internal market amending Directives 97/7/EC, 2002/65/EC, 2005/60/EC and 2006/48/EC and repealing Directive 97/5/EC.

<sup>4</sup> Directive 98/26/EC of the European Parliament and of the Council of 19 May 1998 on settlement finality in payment and securities settlement systems.

governs the registration and approval of systems used for clearing and settling transactions with financial instruments and aims to reduce risk associated with participation in such systems.

- The Securities Market Act (*Lagen om värdepappersmarknaden, 2007:528*) contains provisions on investment services, marketplaces for securities trading and clearing and settlement of securities trading. This Act is based on the Markets in Financial Instruments Directive (MiFID).<sup>5</sup>
- The Financial Instruments Accounts Act (*Lagen om kontoföring av finansiella instrument, 1998:1479*) regulates the registration of ownership of both dematerialised financial instruments and those material instruments that have been taken out of circulation. The responsibility for maintaining the ownership register is assigned to a CSD, which is granted authorisation by Finansinspektionen.
- The Financial Instruments Trading Act (*Lagen om handel med finansiella instrument, 1991:980*) specifies the disclosures to be made, the information to be provided and the procedures to be followed when transactions with financial instruments are undertaken. It also lays down a netting provision regarding contracts involving financial instruments. The Act is based, inter alia, on the EU Prospectus Directive.<sup>6</sup>
- The Act on Fees on some Cross-Border Payments (*Lag om avgifter för vissa gränsöverskridande betalningar, 2002:598*) extends to payments made in Swedish kronor (SEK) the provisions on charges for cross-border payments in the EC regulation on cross-border payments in the Community.<sup>7</sup>

The Swedish banking sector is highly concentrated, with the four largest commercial banks (SEB, Handelsbanken, Nordea and Swedbank)<sup>8</sup> accounting for almost three quarters of household lending, 72% of corporate lending and an even higher proportion of payment activities in the end of September 2010. Foreign banks are allowed to operate in Sweden through branches as well as through subsidiaries. Some 27 foreign banks are represented in the Swedish market, almost all through branches.

## 1.2 The role of the central bank

The Riksbank's responsibilities in respect to the payments system and its various components are formulated in very general terms in the Sveriges Riksbank Act. The act mandates the Riksbank to promote a safe and efficient payment system, which has been interpreted as a general responsibility for looking after the stability of the Swedish financial system. The importance of safe and efficient financial market infrastructures to these objectives predicate the Riksbank's role as an overseer of the payments system (see *Oversight* below).

---

<sup>5</sup> Directive 2004/39/EC of the European Parliament and of the Council of 21 April 2004 on markets in financial instruments amending Council Directives 85/611/EEC and 93/6/EEC and Directive 2000/12/EC of the European Parliament and of the Council and repealing Council Directive 93/22/EEC.

<sup>6</sup> Directive 2003/71/EC of the European Parliament and of the Council of 4 November 2003 on the prospectus to be published when securities are offered to the public or admitted to trading and amending Directive 2001/34/EC.

<sup>7</sup> Regulation (EC) No 924/2009 of the European Parliament and of the Council of 16 September 2009 on cross-border payments in the Community and repealing Regulation (EC) No 2560/2001.

<sup>8</sup> The banks' mortgage institutions and finance companies are included in these figures.

The Riksbank Act also states (see Section 1.1) that the Riksbank may make available systems for settlement of payments and in other ways participate in the settlement of payments. The Riksbank runs the RIX funds transfer system (see *The provision of an interbank settlement system* below).

### **Oversight**

The Riksbank's oversight of the financial infrastructure covers instruments of payment and technical and administrative systems that enable flows of financial assets between different institutions and marketplaces.

The primary objective of the Riksbank with regard to the payment system – as both overseer and operator – is to identify, manage and limit systemic risks. These risks arise primarily in connection with the transfer of large-value payments between banks and other financial institutions. Therefore, from a financial stability perspective, the interest and activities of the Riksbank are concentrated on this aspect of the payment system. As a consequence, its oversight is focused on systemically important payment systems,<sup>9</sup> ie RIX, Euroclear Sweden and NASDAQ OMX Derivatives Markets (NASDAQ OMX DM).

Retail payment systems are also included in the Riksbank's oversight responsibilities as there are currently no alternative systems and they are considered systemically important. In the field of retail payments, the Riksbank also considers questions of efficiency with a view to encouraging the adoption of efficient payment solutions.

In performing its oversight role, the Riksbank regularly meets with representatives of various interests in the Swedish payments system. The Riksbank can propose new laws and amendments directly to the parliament and it is also required to comment on new laws and various official reports. In addition to these activities, the Riksbank takes part in the public debate on issues relating to financial market infrastructure. Also, the Riksbank makes yearly assessments of systems designated as systemically important.<sup>10</sup> As transparency is fundamental to the Riksbank's primary oversight tool of moral suasion, a key element of its oversight activities is the publication of its annual infrastructure assessments and semiannual Financial Stability Report.

This oversight and the annual assessments of BGC, NASDAQ OMX DM and Euroclear Sweden are conducted in cooperation with Finansinspektionen (see Section 1.3) and are organised by a memorandum of understanding. Finansinspektionen is the Swedish financial supervisory authority.

In addition to its oversight of the Swedish financial infrastructure, the Riksbank participates in the cooperative oversight of the Continuous Linked Settlement (CLS) Bank<sup>11</sup> (the international foreign exchange settlement system) and SWIFT<sup>12</sup> (the international messaging system). Since 2010, the Riksbank has also taken part in the cooperative oversight of the EMCF.

---

<sup>9</sup> Systemically important payment systems are either systems that settle large-value payments or systems that are indispensable due to the lack of an alternative.

<sup>10</sup> In Sweden these systems are currently RIX, BGC, Euroclear Sweden and NASDAQ OMX DM.

<sup>11</sup> Together with the 17 central banks of the currencies settled in CLS under the lead of the Federal Reserve Bank of New York, governed by the *Protocol for the Cooperative Oversight Arrangement of CLS*. For more details on CLS, please see the corresponding chapter in the forthcoming second volume of this publication.

<sup>12</sup> SWIFT stands for "Society for Worldwide Interbank Financial Telecommunication". The National Bank of Belgium acts as lead overseer.

### ***The provision of an interbank settlement system***

The Riksbank has no formal obligation to provide settlement services to banks, but the Sveriges Riksbank Act allows for this possibility. The Riksbank does provide interbank settlement facilities for banks, the Swedish National Debt Office and a few other financial institutions through RIX, which it owns and operates, as well as providing deposit and credit facilities (see Section 3.2.1.5). Via their accounts in RIX, the participants (credit institutions) can deposit funds or borrow both intraday and overnight against collateral: intraday to ensure a smooth flow of payments, or overnight in the context of monetary policy operations.

The terms and conditions for participants are set out in the Terms and Conditions for RIX and monetary policy instruments (see Section 3.2.1). Each participant enters into an accession agreement with the Riksbank in its capacity as settlement provider and system owner.

The Riksbank does not act as a banker to the government. This service is provided by the Swedish National Debt Office (see Section 1.3).

## **1.3 The role of other public and private sector bodies**

### ***Public sector bodies***

#### *Finansinspektionen*<sup>13</sup>

Finansinspektionen is the Swedish financial supervisory authority. Finansinspektionen is responsible for the supervision of companies operating in the credit, insurance and securities markets. This includes the supervision of all clearing organisations and payment systems, except for RIX, which is operated and overseen by the Riksbank. Contribution to the stability and efficiency of the Swedish financial sector is part of Finansinspektionen's overall objective. Finansinspektionen reports to the Ministry of Finance.

#### *The Ministry of Finance*<sup>14</sup>

The mandate of the Ministry of Finance is to see that legislation is in place that assures the efficiency and stability of the financial system. The Ministry of Finance also follows developments in the financial markets and business sector so that it can assess the need for new legislation or amendments to existing laws.

Much of Sweden's financial markets legislation stems from the European Union. The European Union's goal is to establish a single market for financial services. The Ministry of Finance represents Sweden's positions at EU meetings and is involved in formulating Community legislation in the financial markets area.

The Ministry of Finance is, inter alia, responsible for the National Debt Office, Finansinspektionen, the National Pensions Funds and the Swedish Pensions Agency.

#### *The Swedish Competition Authority*<sup>15</sup>

The Swedish Competition Authority, Konkurrensverket, is a state authority with responsibility for safeguarding and increasing competition, and for supervising public procurement in Sweden. A new Competition Act came into force on 1 November 2008. Based on EC competition rules, the Act contains provisions against anti-competitive collusion and abuse of

---

<sup>13</sup> Read more about Finansinspektionen at [www.fi.se](http://www.fi.se).

<sup>14</sup> Read more about the Ministry of Finance at [www.regeringen.se](http://www.regeringen.se).

<sup>15</sup> Read more about the Swedish Competition Authority at [www.konkurrensverket.se](http://www.konkurrensverket.se).



dominant market positions. It also contains rules that govern market concentrations between companies. In addition to applying the Competition Act, the Authority makes proposals for changes to rules and other measures that aim to eliminate obstacles to effective competition. It also disseminates expertise on competition issues.

#### *The Swedish Consumer Agency<sup>16</sup>*

The Swedish Consumer Agency, Konsumentverket, is the government agency responsible for consumer protection in all areas, including payment systems. In practice, the agency's role in the payment systems field mainly concerns the debit and credit card sector, where guidelines have been formulated and negotiated with the card-issuing companies.

#### *The Swedish National Debt Office<sup>17</sup>*

The Swedish National Debt Office, Riksgälden, is an agency reporting to the Ministry of Finance; its responsibilities include the management of cash and central government debt, as well as the provision of state guarantees and loans. Additionally, the National Debt Office is responsible for the deposit insurance and investment schemes and for government support to banks. The National Debt Office participates in the RIX system as the government agency responsible for the processing and management of government payments.

### **Private sector bodies**

#### *The Swedish Bankers' Association<sup>18</sup>*

In the private sector, the Swedish Bankers' Association, Svenska Bankföreningen, has standing committees which discuss and coordinate issues concerning the processing of payments and regulatory and technical aspects of payment systems. One example is that, within the framework of this association, RIX participants<sup>19</sup> enter into agreements with each other about cutoff times and the processing of payments. The Association is also owner of a retail payment system (credit transfer) in Sweden, the Data Clearing System, which is operated by BGC.

#### *The Swedish Securities Dealers Association<sup>20</sup>*

The Swedish Securities Dealers Association (SSDA), Svenska Fondhandlareföreningen, is an association that represents the common interests of banks and investment services firms active on the securities market. The mission of SSDA is a sound, strong and efficient Swedish securities market. SSDA promotes members' views on regulatory, market and infrastructure-related issues. It also provides a forum for discussing and exchanging views on matters of common interest to its members.

SSDA's membership comprises banks and investment services firms active in the Swedish securities industry.

---

<sup>16</sup> Read more about the Swedish Consumer Agency at [www.konsumentverket.se](http://www.konsumentverket.se).

<sup>17</sup> Read more about the Swedish National Debt Office at [www.riksdagen.se](http://www.riksdagen.se).

<sup>18</sup> Read more about the Swedish Banker's Association at [www.bankforeningen.se](http://www.bankforeningen.se).

<sup>19</sup> Excluding the public entities.

<sup>20</sup> Read more about the Swedish Securities Dealers Association at [www.fondhandlarna.se](http://www.fondhandlarna.se).

## *PAN Nordic Card Association*<sup>21</sup>

PAN Nordic Card Association is an organisation for Nordic banks working with payment cards. Members are banks within the Nordic Region. Banks can be members directly, or indirectly as a group member of a global general bank card scheme. The Association has five direct members and five indirect members as of May 2010. The association covers Sweden, Norway, Denmark, Finland, Iceland, Latvia, Estonia and Lithuania.

## **2. Payment media used by non-banks**

### **2.1 Cash payments**

Cash payments still account for a large share of total payments in Sweden, although no precise statistics are available. The ratio of the outstanding stock of banknotes and coins to GDP is about 3% as of 2009.

The availability of cash has increased over the past decade, thanks to the growing number of ATMs, which rose from about 2,200 in 1991 to about 3,300 in 2009. Although ATMs are operated on one of two different types of systems, there is a unified network in the sense that the underlying systems – some of which are proprietary, while others are owned collectively by a group of banks – are linked to each other. Individuals can thus make withdrawals, without charge, at any branch of any bank or at any ATM, regardless of which bank holds their account. These ATMs also accept any type of credit or debit card. There is also an independent ATM supplier, Kontanten, which serves about 400 ATMs in Sweden. Kontanten is linked to Visa and MasterCard and withdrawals are free of charge. Only holders of Visa or MasterCard credit and debit cards can make withdrawals at this type of ATM. Cash-back through points of sale (POS) is also increasingly popular, especially in rural parts of Sweden where ATMs are lacking.

### **2.2 Non-cash payments**

#### **2.2.1 Credit transfers**

The two retail payment systems in Sweden are the BGC payment system Bankgirot, managed by Bankgirocentralen BGC AB (BGC), and PlusGiro<sup>22</sup> managed by a private bank, Nordea. The bulk of non-cash payment transactions by companies and households is made through these two systems. The systems cover a wide range of transactions for both households and companies; the vast majority of Swedish enterprises and organisations hold accounts with both systems. The PlusGiro and Bankgirot numbers are always connected to a bank account. The bank account can be used to transfer money to either a PlusGiro or a Bankgirot number. The final settlement of transactions processed through these two systems always takes place in the RIX RTGS system.

BGC's payment system has increased its market share during the last few years and is today the most widely used retail payment system. The services provided by these two systems

<sup>21</sup> Read more about the PAN Nordic Card Association at [www.pan-nordic.org](http://www.pan-nordic.org).

<sup>22</sup> PlusGiro (former Postgirot), established in 1925, was until 2001 wholly owned by the Swedish Postal Service. Since 2005, however, PlusGiro has been only a trademark for payment services offered by Nordea Bank. To use PlusGiro payment products one must be a private or corporate customer of Nordea Bank. PlusGiro services cater for all types of payment transactions in all currencies – giro payments (only in SEK and EUR), credit transfers, wages, foreign payments, financial payments etc.

are generally included in the package of services that banks offer their account-holding customers – households and enterprises alike. In 2009 these two systems together accounted for about 92% of the value of all non-cash transactions.

Billers typically present their bills on paper but it has become increasingly common to use electronic invoices. Enterprises and organisations submit their payment orders almost exclusively by electronic media, while households are more frequently making payments via internet bank services. In 2009, around 97% of all transactions by value were generated electronically, while the remainder was paper-based. This is a 3% increase compared to 2005.

Paper-based payments are usually initiated via a form sent by mail to the debtors' bank. Privatgirot AB is a supplier of paper-based payment services, with the primary role of scanning, interpreting and verifying paper-based documents. The service lets Swedish banking clients make payments using forms. Paper-based payments through BGC's payment system are credited to the recipient on the same day that Privatgirot processes the order. PlusGirot payments are credited to the recipient on the business day following that on which Privatgirot processes the order.

A number of credit transfers also go directly from bank account to bank account. These credit transfers are channelled by the Data Clearing System and processed by BGC's payment system. Account numbers and payment messages are transferred in accordance with a standardised format, which allows for straight through processing (STP).

As SEPA only applies to payments made in euros, no national payments in Sweden are affected, generally speaking. Payments that are affected are those made in euros between Sweden and a euro area country. The two Swedish retail payment systems handle payments in Swedish kronor and domestic euro payments. However, no cross-border payments are handled by these systems. In other words, the initial impact of SEPA in Sweden will be very slight.

### **2.2.2 Cheques and money orders**

The use of cheques in Sweden is very limited. All cheques are truncated, that is, the presenting bank retains the physical document and the information is transmitted by electronic media to the drawee bank. A cheque can be cashed at any branch of any bank, irrespective of the bank on which it is drawn.

Unlike cheques, money orders are still common. They are a secure form of payment instrument that is used in connection with major purchases paid for in cash, such as car purchases. A money order is bought at one of the Swedish banks for the desired amount and is made out to the recipient or to the buyer of the money order. If the money order is made out to the buyer, it can later be assigned to the ultimate recipient and thus constitutes a secure form of payment as it has already been paid for.

Collectively, cheques and money orders are used only in a very restricted sphere: they represented only 0.6% of the value of all transactions in 2005 and only 0.3% in 2009.

### **2.2.3 Direct debits**

BGC's payment system is the only system that provides direct debit services, which are known as *autogiro* in Sweden. Direct debits still account for a rather limited share – around 8% in 2009, level with 2005 – of the total number of non-cash transactions. They are typically used for recurring payments such as rent or electricity bills.

E-invoicing is also used for these kinds of payments, which may help to explain why the take-up of direct debit is lower than in other countries. There is no euro-denominated domestic direct debit scheme; therefore, no SEPA direct debit scheme will be introduced in Sweden.

#### **2.2.4 Credit and debit cards**

Card usage has increased rapidly in Sweden in recent years. Between 1999 and 2009, the number of card payments increased almost sevenfold, from around 250 million transactions in 1999 to almost 1,700 million in 2009. The value of these transactions increased from SEK 174 billion in 1999 to SEK 735 billion in 2009. Previously, cards were used more to withdraw cash from ATMs than to make payments. In recent years, however, there has been a marked change. In 2005, for the first time, the transaction value at card payment terminals exceeded that of cash withdrawals from ATMs. In 2009, the number of card transactions at payment terminals was almost six times higher than the number of cash withdrawals from ATMs. In terms of the number of payments, cards are now the most widely used payment instrument.

The value of an average card payment has fallen significantly over the last 10 years, from approximately SEK 700 to more than SEK 400. Swedes are thus using cards more often to pay smaller amounts.

Almost all debit and credit cards issued by banks in Sweden are connected to the international card schemes of MasterCard or Visa. There is no national card scheme and all credit and debit card brands are accepted. Debit cards account for 80% of the transaction value of all card payments, which also corresponds to the number of cards in use.

Most cards are equipped with an EMV chip and – in line with the SEPA cards framework – by the end of 2010 all cards, all ATMs and all POS terminals will use the chip when a payment is made.

#### **2.2.5 Prepaid cards**

The sole prepaid card in operation is issued by the Swedish National Debt Office in cooperation with a commercial bank. It was introduced in 2010 and is used by public authorities to provide people without a bank account with a means for making electronic payments. The prepaid card is connected to the MasterCard scheme and accepted at any MasterCard-affiliated merchant or ATM.

Some chains of merchants also issue their own prepaid cards. But such cards can only be presented at outlets connected to the specific chain and hence their use is very limited.

### **2.3 Recent developments**

Internet banking has expanded very rapidly in Sweden. All banks offer internet services, which let users access account information, make credit transfers to other customers within the same or at another bank, pay bills and trade securities online. According to a Riksbank survey of 2009, about 70% of Swedish citizens regularly use online banking services. Paper-based bill payments still account for the largest share of online activity but e-invoicing is becoming increasingly popular. The share of transfers between accounts via internet banking is also growing. Online banking has also greatly simplified the task of making transfers between accounts at different banks.

Mobile phone banking is the latest innovation in online banking. Some banks have started to offer banking services to their customers via mobile phone applications. Pilot projects for making payments by mobile phone also exist.

Some Swedish banks also offer e-payment solutions that let consumers use their familiar online banking environment to make an online payment to a webshop.

### 3. Payment systems (funds transfer systems)

#### 3.1 General overview

The RIX system (RIX), the funds transfer system owned and operated by the Riksbank, is the hub of the Swedish payments system and operates on a real-time gross settlement (RTGS) basis.

The main system for retail payments is the Bankgirot. The Bankgirot is an ACH managed by BGC and owned by the banks. The Bankgirot system handles mainly retail payments, but also processes certain large-value payments. Bankgirot payments are settled on a bilateral net basis in RIX.

#### 3.2 Large-value payment system

##### 3.2.1 RIX

###### 3.2.1.1 Institutional framework

The Riksbank owns and operates RIX. RIX is a registered settlement system under the Act (1999:1309) governing systems for settlement of obligations in financial markets. As the provider of RIX, the Riksbank determines the Terms and Conditions for RIX and monetary policy instruments. Through the accession agreement, a private law contract, the participant is bound by the Terms and Conditions.

The Riksbank has established the RIX Council as a forum for discussions with representatives of the RIX participants on strategic issues. RIX is overseen by the Riksbank.<sup>23</sup>

The Terms and Conditions stipulate that settlement in RIX is final and irrevocable when the participant's account is credited.

###### 3.2.1.2 Participation in the system

The Riksbank accepts the following categories of institutions as participants in RIX:

- credit institutions;<sup>24</sup>
- investment firms (provided that they are permitted to trade in financial instruments or to provide guarantees in connection with issues of securities);
- clearing organisations; and
- the Swedish National Debt Office.

A participant can have the status of an *account holder* and/or an *agent*. An account holder can only send its own instructions while an agent can send funds transfer instructions on behalf of account holders or non-participating institutions. Some smaller banks use this type of arrangement. RIX has no relation to such non-participating institutions.

In mid-2010, two participants had the status of an agent, both also having the status of an account holder. In mid-2010, RIX had 23 participants, including the Riksbank. Of these, 17

---

<sup>23</sup> RIX is operated by the Riksbank's Asset Management Department. The oversight of the system is carried out by the Financial Stability Department.

<sup>24</sup> According to the EU definition, which includes a number of institutions that are regarded as investment firms according to Swedish legislation.

were credit institutions, including six branches of foreign banks. The other institutions were BGC, Euroclear Sweden, the European Multilateral Clearing Facility (EMCF), NASDAQ OMX and the Swedish National Debt Office.

RIX is open to remote participants, ie participants without domicile in Sweden. Currently the only remote participant is CLS Bank.

### 3.2.1.3 *Types of transactions handled*

RIX is used to settle interbank and customer payments. Payments arising from the Riksbank's own transactions with participants, primarily the trading of securities or currencies and the deposits and withdrawals of Swedish banknotes and coins, are also settled via RIX.

An individual payment can be registered and subsequently settled at any time during the system's operating hours. From the Riksbank's viewpoint, there is no minimum amount for the settlement of individual payments. However, under an agreement between RIX participants, payments below SEK 0.5 million should be aggregated.

Bilaterally aggregated payments are divided into the following three categories:

- foreign payments (settlement of the SEK leg of payments to/from abroad that are to be forwarded to another bank in Sweden);<sup>25</sup>
- Data Clearing (settlement of customer payments between banks relating to transfers, the cashing of cheques and bank drafts, and card payments); and
- BGC settlements (settlement of Bankgirot transfers, settlement of notes and coins etc).

For each category, settlement takes place one or more times per day.

The Swedish CCP for derivatives and repo transactions, NASDAQ OMX DM, uses RIX to settle the payment obligations between the participants on a multilateral net basis. NASDAQ OMX DM sends fund transfer instructions acting as an agent. BGC's settlement of cash withdrawals at ATMs as well as card transactions is also carried out on a multilateral net basis.<sup>26</sup>

For settlement of the cash leg for securities transactions, the Riksbank provides special settlement accounts, which are administered by Euroclear Sweden, the Swedish CSD, on behalf of the Riksbank. Those accounts are funded by transfers from the respective participant's account in RIX. RIX is also used for pay-ins to and pay-outs from CLS Bank.

### 3.2.1.4 *Operation of the transfer system and settlement procedures*

RIX operates on a real-time gross settlement (RTGS) basis. This means that fund transfers are settled, irrevocably and finally, one by one, on a continuous basis, and that the funds, which are immediately transferred to the participants' accounts at the Riksbank, are available for new payments while the system is open. The settlement, one by one, may take place simultaneously with the settlement of several funds transfers in gridlock resolution processes that are carried out at short intervals during the day. The gridlock resolution process makes a check for a bank with payments that cannot be settled due to a lack of liquidity, whether or not the circumstances are the same for the receiving banks. If this is the case, underlying payments are netted as far as possible with subsequent settlement.

---

<sup>25</sup> Not aggregated by all participants.

<sup>26</sup> Normally BGC settlements are gross bilateral positions but for these particular products (cash withdrawals at ATMs and card transactions) settlement is carried out on a multilateral net basis.

The RIX technical system is a product of the Italian firm SIA-SSB (Perago: rtgs developed by its South African subsidiary Perago Financial Systems Enablers). The system is operated by the Riksbank.

Most of the communication between the system and participants is via SWIFT, the international system for sending different types of standardised messages between financial institutions. However, it is also possible, via the RIX-Online service, for participants in RIX to register payment orders, see their account status in the system, reprioritise the order of payments in queues, change the use of collateral, submit queries etc. In this case communication between the system and participants takes place via the Stockholm Financial Network or through the internet. Participants are obliged to have a connection to RIX-Online as well as a SWIFT connection.

RIX has six settlement processes that work partly in parallel. One of the processes, the real-time settlement mechanism (RTM), has no queuing functionality. This process is used mainly for some urgent transactions and is the only available process towards the end of the day. The other five processes (liquidity optimisation mechanisms or LOMs) have a queuing function, which stores the participants' funds transfers in a queue (one for each process) when there is insufficient liquidity. The payments are settled automatically when liquidity is available. These processes apply the FIFO bypass next principle, ie the first funds transfer in the queue is settled first, but if the first funds transfer is larger than the available liquidity, the next possible funds transfer with the same priority will settle. RIX participants can alter the settlement order by changing the order of the payments in the queue, and, in some of the processes, change the priority.

The selection of settlement process for a funds settlement instruction is based on the receiver code specified in the instruction. Four of the LOM processes are dedicated to specific clearing and settlement systems, namely BGC, CLS, Euroclear Sweden and NASDAQ OMX DM.

Each LOM process has its own intraday settlement account and only the liquidity on that account can be used for settling funds transfers using this process. The participant can make internal transfers between its RTM account<sup>27</sup> (including an automatic credit facility) and the LOM accounts.

RIX accepts instructions 10 calendar days before their intended settlement day. The participant can specify a certain settlement time of the day in the funds transfer instruction.

According to the Terms and Conditions of RIX, settlement is final and irrevocable when the participant's account is credited.

The RIX opening hours for settlement are from 07:00 to 17:00 each banking day (Monday to Friday, excluding holidays).

The Riksbank has backup computer facilities located at physically separate sites. Communications to the computer facilities are duplicated and all production data are updated in real time. If a breakdown in operations should occur, a switch to the RIX backup system takes place automatically.

### 3.2.1.5 Risk management

Since there is no delay between the system's acceptance of a funds transfer for settlement and final settlement, the credit exposure between participants is eliminated in RIX.

The assets used to effect settlement in RIX consist of central bank money, which carries no liquidity or credit risk.

---

<sup>27</sup> Also called principal account.

The Riksbank provides intraday credit to any participant in RIX.<sup>28</sup> The credit is limited only by the value of the collateral provided by the participant. The Riksbank accepts a broad range of collateral including domestic and foreign securities as well as cash balances in certain currencies.<sup>29</sup>

Collateral is marked to market daily and haircuts are used as risk control measures. The eligibility requirements for securities used as collateral include rating and listing requirements. Neither collateral issued by Swedish banks or foreign credit institutions domiciled in the same country as the RIX participant, nor collateral issued by an entity with close links to a RIX participant, is accepted. However, there are exceptions for certain covered bonds. Collateral, in the form of pledged securities, can be held at the domestic CSD Euroclear Sweden, at Euroclear Bank or at the Danish and Norwegian CSDs, with the respective central bank acting as counterparty. Cash balances in foreign currency can be held at the Danish and Norwegian central banks as well as at the Riksbank (EUR).

It is possible for a participant to change the amount of collateral within a short period of time during the day. This procedure is fully automated with regard to collateral held at the domestic CSD.

#### 3.2.1.6 Pricing

The fees charged to participants must cover the Riksbank's costs for RIX.

The fee structure is based on a fixed and a variable component. Apart from a fixed monthly fee for participants who are entitled to credit, participants that have overall domestic revenues of at least SEK 1 billion pay a supplementary monthly fee. This fee is divided among the participants based on their domestic revenues. There is also a single fee per transaction paid by the sender and an admission fee for each new participant.

#### 3.2.1.7 Major ongoing and future projects

RIX was first introduced in 1990. In 2009 the technical system and the technical platform were replaced. In 2010 an upgrade of the technical platform will take place.

### 3.3 Retail payment systems

#### 3.3.1 Bankgirocentralen BGC AB

Bankgirocentralen BGC AB (BGC) is a wholly owned subsidiary of BGC Holding AB, which is owned by eight Swedish banks. BGC was established in 1959. BGC acts as an ACH and manages a payment system and a clearing and settlement service.

BGC's payment system consists of a technical system platform where a number of payment products are processed. Some of these payment products are offered by BGC and called Bankgiro products.

The clearing and settlement service is used to clear and create documentation for settlement of different payment products before they are finally settled in the funds transfer system, RIX.

In addition, BGC also offers other payment-related services such as electronic invoicing and e-identification.

---

<sup>28</sup> Overnight credit in the form of monetary policy facilities is only available to credit institutions with their domicile or a branch in Sweden.

<sup>29</sup> These currencies are the Danish krone (DKK), euro (EUR) and Norwegian krone (NOK).



### 3.3.1.1 Institutional framework

Finansinspektionen has granted BGC a licence to conduct clearing operations in accordance with the Swedish Securities Market Act (SFS 2007:528). Accordingly, BGC is supervised by Finansinspektionen. BGC's clearing and settlement service has been approved by Finansinspektionen in consultation with the Riksbank and notified to the European Commission in accordance with the provisions of the Swedish act on systems for settlement of obligations on the financial market (SFS 1999:1309), which is based on the EC settlement finality directive. BGC is also overseen by the Riksbank.

#### *The payment system*

To participate in BGC's payment system institutions must fulfil the participation criteria. The regulations regarding the payment system are set out in a main agreement, signed by all participants, that specifies the parties' basic obligations and rights. A number of underlying agreements are linked to the main agreement, such as the product agreement, the operation agreement, the service agreement and the agreement on BGC's clearing and settlement service.

#### *The clearing and settlement service*

To use the BGC clearing and settlement service, a participant must fulfil the participation criteria and sign the agreement on BGC's clearing and settlement service. The agreement includes, among other things, a description of routines and a timeplan and process for clearing and final settlement in RIX. The participant is also required to use BGC's clearing information system or the equivalent. For those participants (direct participants) who have taken on indirect participants, the agreement on BGC's clearing and settlement service between BGC and the direct participant also includes information regarding indirect participants.

### 3.3.1.2 Participation in the payment system

The payment system is an open system, implying that any institution according to regulations in Chapter 1, Paragraph 3 in the Law on Payment Services (2010:751) (eg banks and payment institutions) that meets the participation criteria can join the system. The Swedish National Debt Office is also a direct participant. At the end of 2010 the payment system had 22 direct participants and 62 indirect participants.

### 3.3.1.3 Types of transactions handled

BGC's clearing and settlement service includes clearing for Bankgiro products as well as for certain payment products that are not Bankgiro products. These payment products are credit transfers, paper-based payments, ATM withdrawals, card payments and transactions originating from cash handling by banks.

The Bankgiro products provided by BGC include, among others, direct debit, and various kinds of credit transfer.

In addition to the payment systems, BGC also provides electronic invoicing and e-identification services.

### 3.3.1.4 Operation of the transfer system and settlement procedures

Through BGC's payment system, retail payments, mainly credit transfers and transfers between accounts, are made between banks in Sweden. The majority of these payments are aggregated bilaterally and cleared on a bilateral gross basis, that is to say, between two participants. The remainder are cleared on a multilateral net basis, that is to say, between several participants. All types of payments have one or more predetermined daily settlement times. The payment orders mediated via BGC are settled either in the Riksbank's fund

transfer system, RIX, or via the euro large-value system, TARGET 2, depending on whether the payment is denominated in SEK or EUR.

As regards Bankgiro products, BGC is responsible for authorisation, clearing and creating documentation for settlement, and for payment information to the sending and receiving banks. In addition, BGC provides payment information to the payer and payment recipient. The clearing and settlement service is also used for certain payment products that are not Bankgiro products. A common feature of these payment products is that authorisation and, in some cases, portions of the clearing are usually processed in one of several pre-systems before the transaction reaches BGC's payment system.

### *3.3.1.5 Risk management*

As major portions of the payments are cleared using the bilateral gross amount method, and as failure management routines have been established to handle the multilateral net positions, credit risks between the participants are kept to a minimum. The RIX system, where the transactions are settled, also provides liquidity-saving mechanisms, as well as the possibility of reserving liquidity for a specific settlement, thus contributing to a low liquidity risk (see also Section 3.2.1.4).

Even though payments via BGC usually constitute a relatively small part of a participating bank's total flows, the agreement on BGC's clearing and settlement service provides an incentive for participants to be cautious in their liquidity management. The agreement explicitly requires participants to have sufficient liquidity in their RIX and TARGET2 accounts. If a participant cannot fulfil its obligations, its agreement with BGC's clearing and settlement service is automatically revoked. Without this agreement, the participant no longer has the right to participate in BGC's clearing and settlement service. As a result, it is unable to effect payments on behalf of itself or its clients, or their indirect participants via the BGC's payment system or for other payments handled in BGC's clearing and settlement service.

### *3.3.1.6 Pricing*

New participants pay an affiliation fee to join BGC's payment system. As of 2010, an annual fee is also charged. Expenses for participation in BGC's payment system are paid by direct participants, who in turn charge indirect participants as applicable. The pricing model is the same for all participants and is based on transaction volumes and service level.

### *3.3.1.7 Major ongoing and future projects*

In 2007, BGC decided to start a strategic cooperation, mainly concerning BGC's payment system, with VocaLink in the United Kingdom (UK), whose activities include operating the British retail payment system, BACS. In its capacity as supplier, VocaLink will manage the IT operations of BGC's payment system. The objectives of this cooperation are to offer Bankgiro products at a lower price and to meet market demand for new payment products. BGC will retain its current role in relation to the banks, their clients and the authorities.

## **4. Systems for post-trade processing, clearing and securities settlement**

### **4.1 General overview**

Euroclear Sweden is the Swedish CSD and operates the SSS. There is also a derivative and repo CCP, which is run by NASDAQ OMX DM.

EMCF was introduced in the Swedish equity market in 2009 and acts as a CCP in the clearing of equity transactions on the NASDAQ OMX exchanges in Stockholm, Copenhagen and Helsinki and on some other multilateral trading platforms operating in the Nordic countries.

## **4.2 Central counterparties and clearing systems**

### **4.2.1 NASDAQ OMX Derivatives Markets, central counterparty**

NASDAQ OMX Derivatives Markets (NASDAQ OMX DM) offers a fully integrated Nordic derivatives market with trading in standardised Swedish, Norwegian, Finnish, Danish, Icelandic, Russian and Baltic equity derivatives instruments and CCP clearing. The members are also offered a CCP clearing service for interbank traded fixed income derivatives, trading and CCP clearing of tailor-made derivatives contracts (TMC) on listed shares, tradable indexes, custom-made indexes and interest rate products. In 2010, NASDAQ OMX DM introduced CCP clearing for repo transactions in the Swedish market. NASDAQ OMX Stockholm AB (see the next section for the relationship between NASDAQ OMX Stockholm AB and NASDAQ OMX DM) also owns Nord Pool Clearing ASA, the CCP in electricity derivatives and other contracts traded on the Nord Pool ASA exchange (based in Norway and owned by NASDAQ OMX Group). It also performs clearing services for spot electricity trading in the UK and will start clearing power derivatives in early 2011. The clearing and settlement of electricity derivatives and emission rights are conducted via a Norwegian branch of NASDAQ OMX Stockholm AB.

This chapter focuses on NASDAQ OMX DM's role as a CCP and as a clearing organisation for derivatives.

#### *4.2.1.1 Institutional framework*

NASDAQ OMX DM is a secondary legal name for NASDAQ OMX Stockholm AB and is used for operations involving the trading and clearing of derivatives and CCP clearing of repo transactions.<sup>30</sup> NASDAQ OMX Stockholm AB is part of the NASDAQ OMX Group and is a subsidiary of NASDAQ OMX Nordic Oy. The Group's parent company is the listed American company, NASDAQ OMX Group.

NASDAQ OMX DM's role as a CCP is regulated by Swedish legislation and NASDAQ OMX DM's own rules and regulations. The applicable Swedish legislation is the Swedish Securities Market Act (2007:528), the Swedish Financial Instruments Trading Act (1991:980), the Swedish Rights of Priority Act (1970:979) and the Swedish Bankruptcy Act (1987:672). NASDAQ OMX DM's own rule set, the rules and regulations of NASDAQ OMX Derivatives Markets, defines terms and conditions relating to exchange and clearing operations.

In order to conduct trading and CCP clearing of derivatives, NASDAQ OMX Stockholm AB is authorised as an exchange and has a permit from Finansinspektionen to conduct clearing operations in accordance with the Swedish Securities Market Act (2007:528). Finansinspektionen has approved and registered NASDAQ OMX Stockholm AB with the European Commission in accordance with the Act on Systems for the Settlement of Obligations on the Financial Market (1999:1309). NASDAQ OMX Stockholm AB is subject to supervision by Finansinspektionen and to oversight by the Riksbank.

---

<sup>30</sup> A secondary legal name is not a legal entity but refers to a certain part of a company's operations. Secondary legal names are registered with the Swedish Companies Registration Office.

#### 4.2.1.2 Participation

Participation in NASDAQ OMX DM requires a membership. There are three categories of participants in NASDAQ OMX DM's derivative operations:

- non-clearing member: trading member who clears trades via a general clearing member;
- direct clearing member: entitled to participate in the clearing activities at the CCP on its own behalf, on behalf of a customer regarding transactions registered on individual customer accounts and on behalf of a customer regarding transactions registered on aggregated customer accounts; and
- general clearing member: similar to a direct clearing member except that a general clearing member can also participate in clearing activities on behalf of non-clearing members.

The requirements for membership in NASDAQ OMX DM's clearing system are defined in NASDAQ OMX DM's rules and regulations. These set out the requirements in terms of organisation, risk management and technical systems. The financial requirements are that a direct clearing member must have a capital base of at least SEK 10 million and a general clearing member at least SEK 500 million. Both direct and general clearing members must be legal entities with permission to operate a securities business in accordance with the law of the country where they are domiciled. The member must also have qualified brokers and back office personnel.

#### 4.2.1.3 Types of transactions

NASDAQ OMX DM practises what is known as "end-customer clearing". This involves customers, both financial institutions and private individuals, who normally have their own accounts and a direct contractual relationship with the CCP. End-customers can neither trade directly with NASDAQ OMX DM nor act as clearing members and clear transactions.

As an alternative to end-customer clearing, NASDAQ OMX DM offers member clearing. Both direct and general clearing members are allowed to clear transactions on their own behalf, for customers who have concluded a customer agreement with NASDAQ OMX DM and for customers on whose behalf transactions are registered in an omnibus account.

Unlike end-customer clearing, member clearing means that NASDAQ OMX DM is only permitted to have a contractual relationship with the clearing member, and not with the customer. This means, in turn, that NASDAQ OMX DM does not assume any customer-specific risk in member clearing as it does in end-customer clearing.

NASDAQ OMX DM operates two types of payment flows: (i) a pure cash settlement which takes place when a contract is fully or partly redeemed in cash;<sup>31</sup> and (ii) payment flows that arise when securities are exchanged against cash.<sup>32</sup>

Most of NASDAQ OMX DM's payments are made in SEK. Cash settlements in Sweden take place via the Riksbank's funds transfer system, RIX. Thus, because NASDAQ OMX DM is a RIX participant, the major share of NASDAQ OMX DM's cash settlements is made in central bank money.

---

<sup>31</sup> Pure cash settlements take place in conjunction with payments of premiums, fees and daily settlements of futures contracts.

<sup>32</sup> The payment flows that arise after redemption of a contract and the exchange of the underlying security against cash (DVP) via the local CSD.

#### 4.2.1.4 Operation of the system

Derivative transactions traded on NASDAQ OMX DM are automatically transferred to the clearing system. Other transactions, such as OTC derivative and repo transactions, are fed into the system through interfaces with members' in-house systems. When a transaction is accepted for clearing (ie after it has been successfully captured, matched and confirmed), NASDAQ OMX DM becomes counterparty to the parties involved, ie the seller to the buyer and the buyer to the seller.

As counterparty, NASDAQ OMX DM guarantees completion of each transaction, regardless of the original counterparty's ability to pay and deliver. NASDAQ OMX DM does not, however, undertake to complete the transaction on the appointed day if the counterparty cannot fulfil its obligations or if a participant fails to deliver securities promptly.

Delivery and custody of securities take place in dematerialised form and are administered by the CSD Euroclear Sweden for securities issued in Sweden.<sup>33</sup> NASDAQ OMX DM is a member of Euroclear Sweden. The bulk of all securities are registered in Euroclear Sweden's system, which enables gross settlement and is based on the principle of delivery versus payment (DVP) in central bank money.<sup>34</sup>

NASDAQ OMX DM's derivatives clearing is conducted in SECUR, a system developed by the NASDAQ OMX Group. Contingency procedures are established; two computer and communication sites are maintained, and data are mirrored on a real-time basis.

#### 4.2.1.5 Risk management

For all outstanding contracts, sufficient collateral must be pledged to NASDAQ OMX DM. Collateral can be pledged either individually by each customer, or by the clearing member for both its own and its customer's obligations. Once collateral has been pledged, the risk associated with the exposures not covered by the collateral rests with NASDAQ OMX DM.

Margin requirements are calculated at the end of each day, and additional collateral must be delivered before 11:00 of the following day. NASDAQ OMX DM can also make intraday margin calls. NASDAQ OMX DM accepts different types of assets as collateral, including cash in seven currencies,<sup>35</sup> government securities from seven countries,<sup>36</sup> certain warranties/guarantees, bank certificates issued by Swedish, Danish and Finnish banks, bonds and certificates issued by Swedish, Danish and Finnish banks and societies, and certain Norwegian listed shares. Collateral is deposited with a custodial institution accepted by NASDAQ OMX DM.

In addition to the collateral received from customers, NASDAQ OMX DM has its own financial resources that are intended to provide protection against losses in the event of default by customers. This so-called clearing capital is currently about SEK 2.3 billion. It consists of equity (including non-distributable reserves), retained profit and insurance.

If the counterparty's collateral is inadequate in connection with a default, NASDAQ OMX DM has the following fall-back procedure:

- (i) its own clearing capital;

---

<sup>33</sup> Other CSDs are used for other securities, eg VP Securities in Denmark, VPS in Norway and Euroclear Finland in Finland.

<sup>34</sup> A small proportion of NASDAQ OMX DM's delivery of securities is effected in the Danish, Finnish and Norwegian securities systems, which are all based on the DVP settlement principle.

<sup>35</sup> Sterling, Danish kroner, euros, Norwegian kroner, Swedish kronor, Swiss francs, US dollars.

<sup>36</sup> Securities from Denmark, Finland, Germany, Norway, Sweden, the United Kingdom and the United States.

- (ii) two credit lines in Swedish kronor for SEK 700 and SEK 500 million, respectively;
- (iii) the parent company Nasdaq OMX Group Inc also provides credit facilities to allow liquidity to be made available quickly. These credit facilities can only be used as clearing capital.

The clearing capital can be used to cover any losses incurred by NASDAQ OMX DM and by Nord Pool ASA Clearing.

#### *4.2.1.6 Links to other systems*

NASDAQ OMX DM is in the process of phasing out its former links with the derivatives exchanges and clearing organisations in London and Oslo. When this process is completed, NASDAQ OMX DM will no longer have any cross-border links.

#### *4.2.1.7 Pricing*

NASDAQ OMX DM members are charged clearing fees for trading-related activities, as well as technical fees for affiliation etc. Price lists are available on NASDAQ OMX DM's website.

#### *4.2.1.8 Major ongoing and future projects*

NASDAQ OMX DM will introduce a default fund in 2012 financed by contributions from its members. The default fund will take over the function of the current clearing capital and it will consist solely of NASDAQ OMX DM's own resources.

### **4.2.2 European Multilateral Clearing Facility, central counterparty**

While NASDAQ OMX DM is a CCP in the clearing of standardised derivative instruments traded on the NASDAQ OMX derivatives exchanges, the European Multilateral Clearing Facility (EMCF) is a CCP in the clearing of cash equity transactions traded on the NASDAQ OMX exchanges in Stockholm, Helsinki and Copenhagen. EMCF also provides CCP clearing services for transactions in European cash equities executed on Chi-x Europe, BATS Europe and Burgundy.

In 2009 EMCF launched its CCP clearing service in Sweden, to include instruments in OMXS30 and large-cap instruments. Any instruments that fall outside these categories but are currently in the scope of optional clearing within Nordic markets will also be part of the CCP's scope. Transactions are cleared according to the principle of multilateral netting. All clearing operations, regardless of the country where the trade is executed, take place in the Netherlands. Swedish transactions are settled by Euroclear Sweden (both the funds leg and the securities leg), where EMCF acts as a clearing member (for settlement of securities see Section 4.3).

EMCF is owned by NASDAQ OMX (with a 22% stake) and by ABN AMRO Bank NV (with a 78% stake).<sup>37</sup>

#### *4.2.2.1 Ongoing projects*

There are plans to introduce two additional CCPs in the Nordic equity markets as of 2011, with a view to increasing competition. As this type of competition is rather novel, it will require supplementary (inter-CCP) risk management. How this will be done has not been finalised and must be approved by the relevant supervisory authorities before the new CCPs can start operating.

---

<sup>37</sup> Since EMCF is established and based in the Netherlands, we refer to the Dutch chapter in the second volume of this publication.

## **4.3 Securities settlement systems**

### **4.3.1 Euroclear Sweden, securities settlement system**

#### *4.3.1.1 Institutional framework*

Euroclear Sweden is Sweden's CSD and is Sweden's only domestic system for securities settlement. In 2008, the Belgian Euroclear Group took full ownership of NCSD Holding AB (NCSD Holding), which, in turn, wholly owned VPC (the Swedish CSD). Thus, the Swedish CSD moved into foreign ownership. In 2009, VPC's name was changed to Euroclear Sweden.<sup>38</sup> The change of ownership has not altered the Swedish CSD's legal status in Sweden. The company continues to be a Swedish-registered company subject to Swedish law and under the supervision of Finansinspektionen.

Finansinspektionen has approved Euroclear Sweden's settlement system for securities and has registered it with the European Commission in accordance with the Swedish Settlement Systems Act (SFS 1999:1309). Finansinspektionen has also authorised Euroclear Sweden as a central securities depository in accordance with the Swedish Act on Accounting of Financial Instruments (LKF) (SFS 1998:1479). As such, Euroclear Sweden complies with stringent requirements for security and efficiency.

Another important function for Euroclear Sweden is the provision of services to facilitate pledging. Swedish legislation provides support for pledging and the settlement of securities. According to the Swedish Rights of Priority Act (FRL) (SFS 1970:979), the party to whom collateral is pledged has a specific right of priority, ahead of other creditors, to the pledged property in the event of a bankruptcy.

Euroclear Sweden has been designated as systemically important by the Riksbank and Finansinspektionen and is subject to supervision by Finansinspektionen. It is licensed by Finansinspektionen to conduct clearing operations in accordance with the Swedish Securities Market Act (VpML) (SFS 2007:528). The Riksbank and Finansinspektionen jointly oversee the system and perform a yearly assessment.

#### *4.3.1.2 Participation*

Euroclear Sweden accepts Swedish and foreign companies as participants. Participation requirements are stipulated in the Swedish Securities Market Act (SFS 2007:528) and in Euroclear Sweden's regulations. As of September 2010, 51 financial institutions were participating in Euroclear Sweden's securities settlement system. Some 1,230 issuers of financial instruments were affiliated in September 2010.

In its operations, Euroclear Sweden applies the principles of free access and neutrality. This implies that every party meeting the requirements of the Swedish Securities Market Act and Euroclear Sweden's regulations may participate in the system. Moreover, Euroclear Sweden is obliged to apply its regulations to all participants in a uniform manner.

#### *4.3.1.3 Types of transactions*

Euroclear Sweden offers securities settlement. The company also provides custody services in support of registration, issuing and account structuring, in accordance with its authorisation as a CSD. Euroclear Sweden's account services include the distribution of payment instructions (for example for interest payments, tax reporting and tax collection), the safekeeping of securities and the provision of information and services in conjunction with corporate actions.

---

<sup>38</sup> However, Euroclear Sweden's securities settlement system is still known as "the VPC system".

The system is divided into a market for equities and equity-related instruments (AM) and a money market (PM). The AM handles mainly equity market instruments and interest-bearing instruments intended for private individuals, such as bonds and premium bonds. The PM handles interest-bearing instruments for the institutional market, such as treasury bills, mortgage certificates, and mortgage and government bonds.

During 2009, Euroclear Sweden settled an average of approximately 1,100 PM transactions and 109,000 AM transactions per day. For comparison, in 2005 the volumes were 1,600 PM transactions and 50,000 AM. The daily gross value of these transactions in 2009 was approximately SEK 266 billion for PM instruments and about SEK 25 billion for AM instruments.

Both Swedish and foreign securities handled in the system are dematerialised.

#### *4.3.1.4 Operation of the system*

The settlement process starts with participants registering instructions in the system, which are subsequently matched. After instructions have been matched no party may unilaterally recall them.

On the day of settlement the settlement banks<sup>39</sup> grant participants a limit for securities settlement for both Swedish kronor and euros. This limit is equivalent to the cash for the settlement process at the end client's disposal. The system subsequently checks that each settlement bank has sufficient liquidity to cover the transactions of the settlement bank, the participants and the end clients. If securities and cash are available, these assets are blocked for final settlement. The transaction is then marked as ready, meaning that payment is irrevocably made available to the recipient at the next day's settlement time and that securities and funds are exchanged on a DVP basis. The final stage of the settlement cycle, actual settlement, takes place at three specific times for the AM and at four specific times for the PM. The normal settlement cycle is T+2 for the PM and T+3 for the AM.

For securities settlement in SEK, the settlement banks have special accounts for central bank liquidity and associated credit accounts. The Riksbank has given Euroclear Sweden the task of administering these accounts. Even if these accounts are administered by Euroclear Sweden, the Riksbank has complete responsibility for them and their balances represent claims on the Riksbank. On behalf of the Riksbank, Euroclear Sweden can also approve intraday credit for securities settlement. As regards the cash settlement of securities transactions, the settlement banks have neither financial nor operative exposure towards the settlement system. For securities settlements denominated in EUR, Euroclear Sweden (on behalf of the Riksbank) uses client accounts in the TARGET2 system and the Bank of Finland.

#### *4.3.1.5 Risk management*

Euroclear Sweden does not act as a lender and does not grant credit to its participants in any form. Euroclear Sweden's settlement system is designed so that any implicit credit is avoided through the requirement that the securities and the payment required for each individual transaction are blocked before the transaction is marked as ready to settle (on a DVP basis). Following the control and blocking of securities and payment, the settlement of the transaction can be guaranteed, even if one of the counterparties should fail. Euroclear Sweden does not permit overdrafts for either securities or cash.

---

<sup>39</sup> The settlement bank supplies services related to the settlement of payments and operates on behalf of one or more clearing members. Moreover, a settlement bank handles the disbursement or receipt of payments at settlement.



The participants still face a counterparty risk in the form of a replacement cost risk (although not credit risk), as the possibility exists that their transactions will not be marked as ready to settle if their counterparty fails to fulfil its commitments. This risk is bilateral and does not entail an interruption of the settlement process.

Euroclear Sweden has routines for the identification, monitoring and management of operational risk. These involve emergency plans and appropriate backup systems. Euroclear Sweden has an independent organisational unit monitoring operational risk. This function reports directly to the management, providing it with regular information on the system's operational status.

#### *4.3.1.6 Links to other systems*

Euroclear Sweden has a limited number of foreign participants from EU and EEA countries and handles a small number of cross-border transactions via its links. Euroclear Sweden has cross-border links, either directly with other central security depositories or indirectly via custodian banks, to facilitate the transfer of certain foreign securities and all Swedish equities traded on NASDAQ OMX Helsinki. The implementation of the EC Settlement Finality Directive in Sweden implies that all transactions in Euroclear Sweden's settlement system are covered by Swedish legislation. Consequently, no cases of conflicting legislation should arise for the settlement services provided to participants from EU or EEA countries. At present, there are no participants from countries outside the EU/EEA area.

#### *4.3.1.7 Pricing*

New members pay one-time affiliation fees to cover administrative costs. Euroclear Sweden also charges its customers a monthly fee, as well as a per transactions fee and a fee for other services. In accordance with the European Code of Conduct on Clearing and Settlement,<sup>40</sup> information on the costs of joining Euroclear Sweden and on running costs for the various services is available on the website, together with a price list, pricing examples for various types of participants and a conversion table allowing the prices of various CSDs to be compared.

#### *4.3.1.8 Major ongoing and future projects*

Euroclear Sweden plans to consolidate its system with Euroclear Finland. Euroclear Sweden is introducing a new order routing, settlement and asset servicing solution for the domestic funds industry. The aim is to reduce settlement periods, operational risk levels and expenses.

### **4.4 Use of securities infrastructure by the central bank**

The Riksbank is a direct participant in Euroclear Sweden and uses the service for taking collateral and for other business activities.

When it comes to collateral management the Riksbank uses Euroclear Sweden to receive securities as collateral. This collateral is used to support the intraday operations of the RIX, including the funds transfer system and other collateralised lending such as credits under the standing facilities.

To maintain price stability, the Riksbank's monetary policy operational framework is constructed so as to steer the overnight market interest rate. In the event of a borrowing requirement in the banking system, the Riksbank provides monetary policy repos (the

---

<sup>40</sup> [https://secure.ncsd.eu/files/code\\_of\\_conduct.pdf](https://secure.ncsd.eu/files/code_of_conduct.pdf).

Riksbank purchases securities and simultaneously agrees to sell them back on a specified later date) or credit (against collateral). If, instead, the banking system needs to deposit money in the Riksbank, the Riksbank responds by issuing Riksbank Debt Certificates. These securities transactions are all settled in Euroclear Sweden.



**Payment, clearing and  
settlement systems in  
Switzerland**



## Contents

List of abbreviations.....	391
Introduction.....	393
1. Institutional aspects.....	394
1.1 The general institutional framework .....	394
1.1.1 Institutions.....	394
1.1.2 Legal framework .....	394
1.2 The roles of the Swiss National Bank .....	395
1.2.1 Oversight.....	395
1.2.2 Cooperation with other institutions.....	396
1.2.3 Operational role .....	397
1.2.4 Provision of payment and settlement services.....	397
1.3 The role of other private and public institutions.....	399
1.3.1 PostFinance .....	399
1.3.2 Banks .....	400
1.3.3 SIX Group .....	400
1.3.4 Non-bank institutions .....	400
1.3.5 Swiss Payments Council.....	401
1.3.6 Swiss Bankers Association .....	401
1.3.7 Federal Competition Commission.....	401
1.3.8 Foundation for Consumer Protection.....	402
2. Payment media used by non-banks .....	402
2.1 Cash payments .....	402
2.2 Non-cash payments .....	402
2.2.1 Transaction accounts.....	402
2.2.2 Credit transfers .....	403
2.2.3 Direct debits.....	404
2.2.4 Cheques.....	405
2.2.5 Card payments.....	405
2.2.6 Automated teller machines .....	407
2.2.7 EFTPOS infrastructure.....	408
2.3 Recent developments .....	409
2.3.1 Mobile payments.....	409
2.3.2 Payments in e-commerce .....	410
2.3.3 Contactless and prepaid cards .....	410

3.	Payment systems (funds transfer systems).....	411
3.1	General overview .....	411
3.2	Large-value payment system: Swiss Interbank Clearing.....	411
3.2.1	Institutional framework .....	411
3.2.2	Participation .....	412
3.2.3	Types of transaction.....	413
3.2.4	Operation .....	414
3.2.5	Settlement.....	414
3.2.6	Credit, liquidity and operational risk management .....	415
3.2.7	Sources of liquidity .....	417
3.2.8	Links to other payment and securities settlement systems.....	418
3.2.9	Pricing policy .....	418
3.3	Large-value payment system in euros: euroSIC .....	419
3.4	Continuous Linked Settlement .....	419
3.5	Retail payment systems .....	420
4.	Systems for post-trade processing, clearing and securities settlement.....	420
4.1	General overview .....	420
4.2	Central counterparties and clearing systems .....	421
4.2.1	SIX x-clear.....	421
4.2.2	Eurex Clearing.....	424
4.2.3	LCH.Clearnet Ltd.....	424
4.3	Securities settlement systems.....	425
4.3.1	SIX SIS Ltd.....	425
4.4	The use of the securities infrastructure by the Swiss National Bank.....	428

## List of abbreviations

AHV/AVS	Swiss Old Age and Survivors' Insurance Fund
ATM	automated teller machine
BaFin	Bundesanstalt für Finanzdienstleistungsaufsicht (Federal Financial Supervisory Authority (Germany))
BIC	Bank Identifier Code
CCP	central counterparty
CLS	Continuous Linked Settlement
Comco	Swiss Federal Competition Commission
CSD	central securities depository
DMIF	domestic multilateral interchange fee
DVP	delivery versus payment
e-bills	electronic bills
EFTPOS	electronic funds transfer at the point of sale
ETF	exchange-traded fund
euroSIC	Swiss RTGS system in euros
FINMA	Swiss Financial Market Supervisory Authority
FISA	Swiss Federal Intermediated Securities Act
FX	foreign exchange
GCM	General Clearing Member
GDP	gross domestic product
GTCB	General Terms and Conditions of Business
IBAN	International Bank Account Number
ICM	Individual Clearing Members
ICSD	international central securities depository
ISIN	International Securities Identification Number
LSE	London Stock Exchange
MTF	multilateral trading facility
NBA	National Bank Act
NBO	National Bank Ordinance
NCM	Non-Clearing Member
PIN	personal identification number
POS	point of sale
ROCH	Recognised Overseas Clearing House
RTGS	real-time gross settlement
SARON	Swiss Average Rate Overnight



*Switzerland*

SECB	Swiss Euro Clearing Bank
SECOM	Settlement Communication System
SEPA	Single Euro Payments Area
SIC	Swiss Interbank Clearing
SNB	Swiss National Bank
SPC	Swiss Payments Council
SSS	securities settlement system

## Introduction

At the beginning of 2008 three of the major Swiss collaborative financial market infrastructure providers<sup>1</sup> merged into SIX Group Ltd. It is owned by approximately 160 domestic and foreign banks, which are also the main users of the infrastructures. Consequently, SIX Group Ltd is the predominant player in offering financial market infrastructure services in Switzerland. Through various subsidiary companies it operates the SIX Swiss Exchange (the exchange for Swiss equities, bonds and exchange-traded funds) and the following payment, clearing and settlement systems: Swiss Interbank Clearing (real-time gross settlement (RTGS) system), SIX x-clear Ltd (the central counterparty) and SECOM<sup>2</sup> (the securities settlement system). Other companies belonging to SIX Group Ltd are dominant players in the card issuing, acquiring and processing business.

Swiss Interbank Clearing (SIC),<sup>3</sup> the RTGS system for Swiss francs, is operated by SIX Interbank Clearing Ltd on behalf of the Swiss National Bank (SNB). The SNB acts as a system manager and settlement agent, providing participants with accounts in central bank money and with liquidity facilities. SIC settles large-value payments including those related to the SNB's monetary policy operations. It is also the main retail payment system.

SIX x-clear Ltd (x-clear) is the only central counterparty domiciled in Switzerland. It is licensed as a bank and currently provides clearing for securities traded on SIX Swiss Exchange, on the London Stock Exchange and on multilateral trading facilities (MTFs) such as UBS MTF and Equiduct.

SECOM, the securities settlement system, is operated by SIX SIS Ltd (SIS), which is also the central securities depository (CSD). SIS is licensed as a bank. It provides for the custody and settlement of tradable financial instruments in Switzerland and as global custodian offers its participants access to over fifty foreign financial markets.

Besides x-clear there are two non-domestic central counterparties (CCPs) that are relevant for Switzerland: the UK-based London Clearing House, which clears financial instruments traded on SIX Swiss Exchange, and the German-based Eurex Clearing, which provides CCP clearing services for derivatives based on Swiss underlying assets.

Moreover, an important component for the Swiss payment infrastructure is Continuous Linked Settlement (CLS), the international foreign exchange (FX) settlement system managed by the New York-based CLS Bank International. CLS settles FX trades in 17 currencies including the Swiss franc.

The SNB and the Swiss Financial Market Supervisory Authority (FINMA) are the authorities endowed with regulatory functions related to the payment, clearing and settlement infrastructure in Switzerland. FINMA, as the prudential regulatory authority, supervises those entities that are licensed as banks.<sup>4</sup> The SNB oversees all payment, clearing and settlement systems. Those systems that are important to the stability of the Swiss financial system are subject to minimum requirements. In its oversight function the SNB cooperates with FINMA and also with the relevant foreign regulatory authorities. The SNB has designated the following systems as important for the stability of the Swiss financial system: SIC, x-clear, LCH.Clearnet Ltd, Eurex Clearing, SECOM and CLS.

---

<sup>1</sup> SWX Stock Exchange, Telekurs Group and SIS Group.

<sup>2</sup> SECOM stands for Settlement Communication System.

<sup>3</sup> Although the SIC system carries the word "clearing" in its name, it is in fact a payment system providing final settlement for payments in real time and on a gross basis.

<sup>4</sup> In the case of payment, clearing and settlement systems this applies to SIX x-clear Ltd and SIX SIS Ltd, which are both registered as banks with a tailor-made banking licence.

In the field of retail payments, in addition to the services provided by commercial banks, PostFinance has for historical reasons also been a major provider and processor. It offers the entire range of payment services and instruments and settles most transactions through its own network and payment system. PostFinance does not hold a banking licence.

The overwhelming majority of cashless payments in Switzerland take the form of credit transfers. Direct debit schemes exist but have been considerably less important. Cheques and e-money, which have both never been significant payment instruments, have declined in use over recent years. In contrast, payment cards, both credit and debit cards, have substantially gained in popularity in the last decade. While there have been some launches of innovative payment instruments in Switzerland in recent years, including contactless and prepaid payment cards, mobile phone payment instruments and solutions for payments in e-commerce, they have all remained on the fringes of popularity.

## 1. Institutional aspects

### 1.1 The general institutional framework

#### 1.1.1 Institutions

The **Swiss National Bank** is Switzerland's central bank. The constitutional basis for its activity is contained in Article 99 of the Federal Constitution, which empowers the SNB, as an independent central bank, to pursue a monetary policy that serves the country as a whole. The National Bank Act (NBA) of 3 October 2003 (in force since 1 May 2004) serves as the statutory basis for the SNB and its activities. The NBA sets out in detail the SNB's mandate, its tasks and its sovereign instruments. Besides ensuring price stability, the SNB shall – among other tasks – facilitate and secure the operation of cashless payment systems and shall contribute to the stability of the financial system. Oversight of payment and securities settlement systems is one of the instruments to contribute to financial stability and is outlined in Articles 19–21 NBA (for details see Section 1.2.1).

The **Swiss Financial Market Supervisory Authority** has sovereign authority over banks, insurance companies, stock exchanges, securities firms and collective investment schemes. It operates based on the principles of the Federal Act on the Swiss Financial Market Supervisory Authority. FINMA grants operating licences for companies and organisations subject to its supervision. Moreover, it is responsible for combating money laundering and, where necessary, conducts financial restructuring and bankruptcy proceedings. Through its supervisory activities, FINMA also ensures that the supervised institutions comply with the requisite laws, ordinances, directives and regulations and continue at all times to fulfil licensing conditions. Consequently, operators of payment, clearing and securities settlement systems that are licensed as banks are subject to FINMA's prudential supervision.

#### 1.1.2 Legal framework

Under Swiss law, no comprehensive and uniform set of rules governing payment systems or securities clearing and settlement systems has been enacted. The legal framework in Switzerland for the operation of payment, securities clearing and settlement systems consists of contractual arrangements under private law among the various participants involved, supplemented by the systems' technical regulations. These contracts are based on the general principles of the Civil Code and the Code of Obligations. Furthermore, finality issues

are governed by the Banking Act, the Code of Obligations and the Federal Intermediated Securities Act (FISA).<sup>5</sup> Finally, conflict of laws issues are governed by the Swiss Private International Law Act and the respective international treaties.<sup>6</sup>

Moreover, payment and securities settlement systems are overseen by the SNB. Systems that are designated as systemically important have to meet minimum requirements as stipulated in the NBA and the National Bank Ordinance (NBO).<sup>7</sup> The CCP x-clear and the SSS operator SIS – both subsidiary companies of SIX Group – are registered as banks (with a tailor-made banking licence<sup>8</sup>) and are therefore subject to prudential supervision by FINMA based on the Banking Act<sup>9</sup> and related decrees (for details on x-clear and SIS see Sections 4.3 and 4.4).

SIX Interbank Clearing Ltd, the operator of the Swiss RTGS system SIC, is a private corporation<sup>10</sup> established in Switzerland and governed by Swiss company law.<sup>11</sup> It is a subsidiary company of SIX Group and does not have banking status (for details see Section 3.2).

Besides SIX Group, PostFinance – the financial branch of Swiss Post – is another dominant player in the area of payment infrastructure, particularly in retail payments and retail payment instruments. PostFinance is not licensed as a bank and is governed by the regulations in the Postal Act.<sup>12</sup>

## 1.2 The roles of the Swiss National Bank

### 1.2.1 Oversight

The NBA serves as the statutory basis for the SNB and its activity and sets out in detail the SNB's constitutional mandate. In particular, with the revision of the NBA in 2004 the SNB has been given the explicit statutory mandate to oversee payment and securities clearing and settlement systems as outlined in Articles 19–21 NBA. These articles govern the purpose and scope, features and processes of oversight as well as the cooperation with other authorities. The NBA specifies that the oversight function is designed to protect the stability

---

<sup>5</sup> Details on finality of payments and securities transactions are provided in the respective sections below (3.2.1 and 4.3.1.1).

<sup>6</sup> European Union/European Economic Area law and directives (including those related to payment, clearing and settlement systems) are not applicable in Switzerland as Switzerland is a member neither of the EU nor of the EEA.

<sup>7</sup> The NBA and NBO are available at [http://www.snb.ch/en/i/about/snb/legal/id/snb\\_legalLaw](http://www.snb.ch/en/i/about/snb/legal/id/snb_legalLaw). According to the Swiss Constitution, the Federal Assembly of the Swiss Confederation is empowered to pass and amend the NBA. In the drafting process, the SNB is invited to provide its opinion. Reviews and amendments occur when deemed necessary. Based on Article 15 para 3, Article 17 para 2, Article 18 para 5 and Article 20 para 3 NBA the SNB is empowered to issue, to review and to amend the NBO. There are no formal provisions as to the periodicity for reviews.

<sup>8</sup> FINMA has stipulated some additional provisions to the Banking Act and some exceptions from provisions in the Banking Act to align licensing requirements with the special purpose activities of these financial market infrastructures.

<sup>9</sup> Swiss Federal Act on Banks and Savings Banks:  
[www.swiss-banking-law.com/en/files/KPMG\\_Swiss\\_Federal\\_Act\\_on\\_Banks\\_and\\_Savings\\_Banks.pdf](http://www.swiss-banking-law.com/en/files/KPMG_Swiss_Federal_Act_on_Banks_and_Savings_Banks.pdf).

<sup>10</sup> Joint-stock company (“Aktiengesellschaft” / “société anonyme”).

<sup>11</sup> See Articles 620 et seq of the Swiss Code of Obligations.

<sup>12</sup> As a non-bank, PostFinance is currently not supervised by FINMA. However, there are endeavours to subject PostFinance to FINMA's supervision, which would simplify PostFinance's current complex regulatory supervision arrangements.

of the financial system. The sole objective of system oversight by the SNB is to ensure financial stability, which in turn is a precondition for the effectiveness of monetary policy. Consequently, individual creditor and consumer protection or the protection of payment and securities settlement systems from criminal abuse are not objectives of the SNB's oversight. The detailed stipulations governing oversight are laid down in the NBO.

As stipulated in the NBA and NBO, the SNB follows a three-level regulatory approach in implementing oversight. Firstly, all system operators are required to provide statistical information. Secondly, all securities settlement systems and those payment systems settling more than CHF<sup>13</sup> 25 billion annually become subject to the disclosure obligation. Based on the acquired information the SNB evaluates if a system qualifies as systemically important pursuant to the criteria identified in Article 20 NBO, which are: types of transactions, value and number of transactions, group of participants, currencies cleared or settled, links between systems and available alternatives. By definition, systemically important systems have the potential to either trigger or transmit systemic risks across the financial system, hence compromising financial stability. Thirdly, operators of systems that pose a risk to the stability of the financial system become subject to minimum requirements.

The SNB has classified the following systems as important for the stability of the Swiss financial system: Swiss Interbank Clearing (RTGS), SECOM (SSS), x-clear (CCP), LCH.Clearnet Ltd (central counterparty), CLS (foreign exchange settlement system) and Eurex Clearing (central counterparty). Systemically important non-domestic systems are exempt from meeting minimum requirements if they are subject to equivalent oversight by a foreign authority which cooperates with the SNB (see Section 1.2.2).

The SNB's mandate to oversee payment systems also extends to retail payment systems. However, as the SNB's oversight aims at protecting the stability of the financial system, the focus of the SNB's oversight activities is primarily on systemically important systems. None of the systems in Switzerland established for transacting, processing or settling retail payments have been designated as systemically important. Thus, minimum requirements do not apply. Nevertheless, the SNB monitors retail payment systems as well as trends and developments in retail payments more generally, relying on the statistical reporting duty along with publicly available information of all kinds.

### **1.2.2 Cooperation with other institutions**

#### *As overseer*

Article 21 NBA governs the provisions for the cooperation between the SNB and other domestic and foreign authorities. Domestically the SNB cooperates closely with FINMA. Coordination between the two authorities is especially necessary when a system operator is also licensed as a bank and is thus subject to prudential supervision. Moreover, the NBO requires the SNB to consult with FINMA before determining that a payment or securities settlement system is systemically important.

In the light of the increasing internationalisation of financial market infrastructures, the SNB – in its role as overseer – depends on strong cooperation with foreign authorities. The willingness of a foreign authority to cooperate with the SNB is a precondition for systemically important non-domestic systems to be exempt from complying with the SNB's minimum requirements. The SNB can share non-public information and documents regarding system operators with foreign supervisory or oversight authorities provided that these authorities use such information

---

<sup>13</sup> At year-end 2009, CHF 1.00 was worth USD 0.97.

exclusively for directly supervising or overseeing such systems or participants in such systems and are bound by official or professional secrecy.

Regarding CLS, the SNB is part of a cooperative oversight group with other central banks under the lead of the Federal Reserve Bank of New York.<sup>14</sup> In the case of the two non-domestic CCPs LCH.Clearnet Ltd (LCH.Clearnet) and Eurex Clearing, the SNB cooperates with the relevant UK and German authorities. In addition, due to increasing cross-border activities and interoperability of the systemically important domestic CCP, x-clear, the SNB also cooperates with other relevant foreign authorities such as those in the United Kingdom, Denmark, Finland, Sweden and the Netherlands. Typically oversight cooperation is governed by Memoranda of Understanding.

#### *As catalyst*

The cooperation of private and public institutions in the area of payments, clearing and settlement has a long tradition in Switzerland. Various standing committees examine relevant issues of the Swiss financial market infrastructure involving the major players: banks, PostFinance, SIX Group and the SNB.<sup>15</sup> The cooperative approach allows for developing and implementing common standards that facilitate competition on payment services while not compromising industry-wide efficiency and interoperability. In these committees, the SNB takes part mostly as a member on a par with the others. The SNB rarely takes the lead, yet it reserves the right to provide clear guidance when any development in the area of financial market infrastructure could jeopardise its mandate.

### **1.2.3 Operational role**

Since 1987 SIC, Switzerland's RTGS system, has been operated by SIX Interbank Clearing Ltd on behalf of the SNB, while the SNB acts both as the system's manager and the settlement agent. SIX Interbank Clearing Ltd is owned by its users: SIX Group (ie the Swiss banks, 75% ownership of SIC) and PostFinance (25% ownership). The SNB has one representative on the board of directors of SIX Interbank Clearing Ltd. The stipulations governing the responsibilities and duties of the relationship between the SNB and SIX Interbank Clearing Ltd are laid down in a contract. SIX Interbank Clearing Ltd operates and maintains the processing centres, develops and maintains the software and manages the data files, and defines the organisational and administrative rules of conduct in SIC and maintains the communication and security installations. As the system's manager the SNB lays down the conditions for access and exclusion from the SIC system, initiates beginning and end-of-day procedures and is in charge of crisis management (see Section 3.2 for details on SIC).

### **1.2.4 Provision of payment and settlement services**

#### *Provision of sight deposit accounts*

Article 9 of the NBA empowers the SNB to keep sight deposit accounts for banks and other financial market participants as part of its mandate to pursue its monetary tasks. These sight deposit accounts are used for transactions with the SNB as well as for cash deposits and cash withdrawals and are a precondition for participation in the SIC system. Account

---

<sup>14</sup> The *Protocol for the Cooperative Oversight Arrangement of CLS* is downloadable from the website of the US Federal Reserve.

<sup>15</sup> A number of relevant committees are also hosted by the Swiss Bankers Association (see Section 1.3.6).

maintenance is free of charge and the balances are non-interest bearing. At the end of 2010, there were 491 sight deposit accounts with the SNB.

The SNB defines the criteria for opening a sight deposit account and for accessing the SIC system.<sup>16</sup> Admitted participants are, in principle, professional financial market participants and are subject to regulatory supervision with regard to the combating of money laundering and of terrorism financing. Also, participants have to have an adequate technological infrastructure to exchange payment information with the SNB. Foreign institutions are also admitted provided that they are domiciled in a politically and economically stable country based on the rule of law and are subject to equivalent regulatory and supervisory standards. The SNB opens sight deposit accounts for domestic and foreign banks, Swiss Post, insurance companies, domestic cash processing operators, clearing and settlement organisations, public entities, foreign central banks and international organisations.

#### *Provision of credit facilities*

The SNB provides liquidity to market participants via open market operations, intraday credits and the liquidity-shortage financing facility. All domestic banks with sight deposits at the SNB are in principle admitted as counterparties for the SNB's monetary policy operations. Other domestic and foreign financial market participants may be admitted as counterparties for monetary policy operations provided that their admission serves monetary policy interests, the participants contribute to the liquidity of the secured Swiss franc money market, and they meet the requirements for opening a sight deposit account (see paragraph above).

All credit facilities offered by the SNB are based on repurchase agreement (repo) transactions. To obtain access to the repo market in Swiss francs candidates must be admitted to the SIC system and to SECOM, and meet the conditions for participation in the Swiss franc repo market.<sup>17</sup> Only high-quality securities are accepted by the SNB as collateral for repo transactions. The SNB defines the specificities.<sup>18</sup>

#### *Standing facilities*

While the SNB takes the initiative in open market operations, intraday liquidity and the liquidity-shortage financing facility are standing facilities at the disposal of the counterparties. With standing facilities, the SNB only specifies the conditions on which liquidity can be obtained.

Market participants can draw interest-free **intraday liquidity** from the SNB to alleviate their possible liquidity challenges in the SIC system, for instance in case of time-critical pay-ins into CLS. All the liquidity obtained through the intraday liquidity facility has to be repaid in full by the closing of the settlement day. Intraday liquidity is provided on the basis of repo transactions. At all times the collateral provided by the counterparties has to cover at least 110% of the liquidity drawn. To qualify for intraday liquidity, counterparties have to meet the conditions for participation in the Swiss franc repo market.

The SNB provides a **liquidity-shortage financing facility** to bridge unexpected, short-term liquidity bottlenecks. Liquidity-shortage financing is commonly drawn when required funding

---

<sup>16</sup> For details on access criteria to the SIC system, see "Instruction sheet on cashless payment transactions", available at [www.snb.ch](http://www.snb.ch).

<sup>17</sup> Conditions for participation in the repo market include meeting both the access criteria to Eurex Zurich Ltd as well as the general terms and conditions of the SNB on repo transactions.

<sup>18</sup> For details on eligible collateral, see "Instruction sheet on collateral eligible for SNB repos" and for a regularly updated list see "List of collateral eligible for SNB repos", both available at [www.snb.ch](http://www.snb.ch).

cannot be obtained quickly enough in the interbank market or minimum reserve requirements cannot be ensured at the end of the reporting period. The facility is made available through repo transactions at a special rate (currently 50 basis points above the call money rate<sup>19</sup>). All counterparties wishing to draw on the liquidity-shortage financing facility have to fulfil the conditions for participation in the repo market in Swiss francs. Moreover, a prerequisite for using the facility is the granting of a limit by the SNB of the maximum amount of liquidity that can be drawn. At all times, counterparties have to pre-pledge SNB-eligible collateral at 110% of the defined limit in a separate custody account. During the day, these pre-pledged securities may also be used for obtaining intraday liquidity.

#### *Banker to the Confederation*

As stipulated in the NBA<sup>20</sup> the SNB may provide banking services to the Swiss Confederation.<sup>21</sup> Bilateral agreements between the SNB and the individual federal and associated enterprises govern the details of these business relationships. The SNB conducts a part of the Confederation's payment transactions (mainly cross-border and large-value payments), performs its liquidity management, holds its securities in safe custody, invests federal funds, issues money market debt register claims and Confederation bonds, and conducts foreign exchange transactions.<sup>22</sup>

The NBA prohibits the SNB from granting the Confederation loans or overdraft facilities and buying government bonds from new issues. However, the SNB may grant the Confederation intraday account overdrafts against sufficient collateral.

### **1.3 The role of other private and public institutions**

#### **1.3.1 PostFinance**

Historically, the Swiss Postal Administration has been the dominant institution in payment services. As early as 1906 Swiss Post received authorisation to open accounts for any firm or private individual. Various payment transactions such as cashless transfers, cash deposits and payouts could be carried out on these postal accounts. The Postal Administration's network of post offices throughout Switzerland provided the necessary infrastructure. The tight network of post offices in Switzerland and Swiss citizens' widespread account ownership with Swiss Post contributed to the development of a payment culture based on credit transfer instruments rather than debit transfer instruments. As almost every citizen had access to a post office within walking distance for bill payment and almost every company had an account with Swiss Post (now PostFinance), there was little necessity for debit instruments such as cheques to be promoted in Switzerland. As a consequence, cheques have always been of marginal significance.

---

<sup>19</sup> The reference rate for the call money rate is the SARON (Swiss Average Rate Overnight) 12:00 noon fixing of the current bank working day.

<sup>20</sup> Article 5, para 4 and Article 11 NBA.

<sup>21</sup> Background information regarding the SNB's role as banker to the Confederation over time along with the reasoning behind the changes in the remuneration policy for providing its services can be found in: SNB commemorative publication 2007 *The Swiss National Bank, 1907–2007*. Zurich: Verlag Neue Zürcher Zeitung, pp 544–6.

<sup>22</sup> The SNB's banking services to the Confederation were offered free of charge prior to the revision of the NBA in 2004. With the new NBA the SNB was no longer compelled to provide services to the Confederation unconditionally but could negotiate terms as an equal partner. Accordingly, the new NBA stipulates that banking services to the Confederation are provided for adequate compensation. However, services rendered to facilitate the implementation of monetary policy remain free of charge.



Nowadays PostFinance (Swiss Post's financial services branch) remains a prominent provider in the area of retail payments and of retail instruments. The Swiss Post continues to have a legal mandate to provide sufficient coverage for payment services in all parts of the country. In 2009 it had a network of 2,348 post offices and PostFinance maintained over 3.8 million accounts, settling 865 million transactions.

### **1.3.2 Banks**

While PostFinance has been present in the retail area for more than a century now, in 1949 the big Swiss banks founded their own giro organisation, the "Bank Clearing". Most other banks joined this clearing arrangement in the subsequent years. In 1981 responsibility for the administrative and technical operation of this clearing system was assigned to Telekurs Ltd (today's SIX Interbank Clearing Ltd), a joint venture of the Swiss banks. Out of "Bank Clearing" emerged the Swiss RTGS system Swiss Interbank Clearing in 1987. In 2001 PostFinance also joined SIC. As a result of the foundation of SIX Group in 2008, SIX Interbank Clearing Ltd was put under the roof of SIX Group.

At the end of 2009 there were in total 325 banks in Switzerland with 2,639 branches or offices. Most banks offer the full range of banking services including payment services and a wide variety of payment instruments. Typically payment services are not charged on a per transaction basis but are bundled and priced together with other bank account related services.

### **1.3.3 SIX Group**

At the beginning of 2008 the three leading financial market infrastructure providers in Switzerland SWX Stock Exchange, Telekurs Group and SIS Group merged into one single holding structure named SIX Group Ltd. It is owned by approximately 160 domestic and foreign banks that are also the users of its infrastructures.<sup>23</sup> SIX Group now unites all components of the Swiss Value Chain<sup>24</sup> under the same roof. In addition to combining trading, clearing, payment and securities settlement, SIX Group offers many related services. These include the operation, regulation and monitoring of electronic exchange trading, the calculation of indices, the custody processes of securities, the distribution of reference and market data, and the operational processes related to issuing and accepting payment cards (credit, debit and prepaid cards). Additional services are the settlement of electronic bills as well as interbank payment transactions in euros. Moreover, the systemically important Swiss payment, clearing and securities settlement systems SIC (RTGS), x-clear (CCP) and SECOM (SSS) are operated by subsidiary companies of SIX Group Ltd.

### **1.3.4 Non-bank institutions**

Besides the dominant players in the area of Swiss payment services – SIX Group, PostFinance and the banks – there is a presence of non-bank institutions providing services

---

<sup>23</sup> At the end of 2009 the shareholders in SIX Group were the major Swiss banks (30.12%), foreign banks in Switzerland (22.68%), commercial and asset management banks (14.96%), cantonal banks (13.64%), private bankers (10.17%) and regional and Raiffeisen banks (4.09%). Other banks accounted for 1.23%. SIX Group and its companies held the remaining 3.11%.

<sup>24</sup> The Swiss Value Chain is the term used to describe the fully electronic integration of trading, clearing and settlement of shares, bonds, derivatives and structured products in Switzerland.

in the processing of retail transactions, in issuing and acquiring payment cards or in offering innovative payment products.<sup>25</sup>

### **1.3.5 Swiss Payments Council**

SIX Interbank Clearing Ltd, the operator of SIC and provider of various other payment services, manages a number of committees established to coordinate interbank issues in the area of payments and settlements. These committees and related working groups aim at establishing or adopting national and international standards and provide concerted solutions for national and cross-border developments in the field of payments. The Swiss Payments Council (SPC) is the leading committee, consisting of the SIX Interbank Clearing Ltd's Board of directors, which itself is composed of representatives of all major Swiss players in the payments, clearing and settlement area, including the SNB. The SPC identifies and prioritises topics of significance for the Swiss financial centre related to payments on a national and cross-border level. It is authorised to decree guidelines in standardisation (development, introduction, adjustment or abolition of standards). Additionally, the SPC governs other Swiss payments sub-committees<sup>26</sup> and working groups, their structure, scope of work and guidelines.

### **1.3.6 Swiss Bankers Association**

The Swiss Bankers Association is the leading professional organisation of the Swiss financial centre. Its main purpose is to maintain and promote the best possible business environment for the Swiss financial centre both domestically and abroad. It has close to 360 institutional members. Various committees and associated working groups deal with key issues affecting the industry, including matters related to the financial market infrastructure<sup>27</sup> as well as to business continuity. Representatives from various banking groups take part in these committees. The SNB is also represented in some committees.

### **1.3.7 Federal Competition Commission**

The Swiss Federal Competition Commission (Comco) is an independent federal authority. Comco's objective is to protect competition by ensuring that private sector arrangements comply with the Act on Cartels.<sup>28</sup> In this capacity Comco monitors dominant companies for signs of anticompetitive behaviour, enforces merger control legislation, prevents the imposition of competition restraints by the state and above all combats harmful cartels. Contrary to the custom in other countries, in Switzerland it is the sole responsibility of Comco to address anticompetitive developments in the area of payments and instruments.<sup>29</sup>

---

<sup>25</sup> For example; there are some firms in the card business – Arccarda, Aduno, Viseca, B&S Card Services, Concardis and others – without a banking licence. Also, [sofortueberweisung.de](http://sofortueberweisung.de) offers an e-payments solution and [vanilla.ch](http://vanilla.ch) provides m-payments, while other organisations are active in the field of cross-border money transfer (eg Western Union, Moneygram).

<sup>26</sup> Such as Payments Committee Switzerland (PaCoS), Project and IT-Process Steering Committee (PAP), Rules and Regulations Committee (RAR). Background information on these committees can be found at [www.sic.ch](http://www.sic.ch).

<sup>27</sup> Such as the Swiss Commission for Financial Standardisation.

<sup>28</sup> Bundesgesetz über Kartelle und andere Wettbewerbsbeschränkungen (Federal Act on Cartels and Other Restraints of Competition).

<sup>29</sup> In the payment cards market, for example, Comco opened an investigation concerning domestic multilateral interchange fees (DMIF) of Visa and MasterCard in the Swiss credit card market. The assessment led to an amicable settlement in 2005 between the parties involved which sets a maximum DMIF. Comco deemed the

### **1.3.8 Foundation for Consumer Protection**

The protection of consumer rights is not mandated to any federal agency in Switzerland. An independent foundation<sup>30</sup> supported by individual donors – primarily consumers – protects the interests of consumers vis-à-vis providers of goods and services and lobbies in the legislative process.

## **2. Payment media used by non-banks**

### **2.1 Cash payments**

As stipulated in the NBA, the SNB has the exclusive right to issue banknotes in Switzerland. Banknotes are printed by a private company.<sup>31</sup> The distribution of banknotes is carried out by the SNB via its offices in Zurich, Berne and Geneva along with 16 agencies (cash distribution services operated by cantonal banks). In this, the SNB fulfils the role of wholesaler. The capillary distribution and redemption of cash is effected by commercial banks, the Swiss Post and private cash handlers.

While the monopoly of coinage is with the Confederation, the SNB defines the coin minting programme and handles the coin distribution. On behalf of the Confederation, the SNB places coins in circulation and is required to take back coins against the reimbursement of their nominal value without any restriction.

Notes are issued in six denominations (CHF 10, 20, 50, 100, 200 and 1,000) and coins in seven denominations (CHF 0.05, 0.10, 0.20, 0.50, 1, 2 and 5).

Cash is a widely used retail payment instrument in Switzerland; however, there are no firm statistics available to determine the precise figure. Withdrawals are mainly made at ATMs, but also over the counter at post offices or at banks. For its customers, PostFinance offers *cash-back*<sup>32</sup> with PostFinance's debit card at the counters of various big retailers and Swiss Federal Railways. At the end of 2009 banknotes and coins in circulation inside and outside banks amounted to CHF 52.7 billion, compared to CHF 37.79 billion in 2000.

### **2.2 Non-cash payments**

#### **2.2.1 Transaction accounts**

Given the large number of banks and the strong presence of Swiss Post with its payment services offered by PostFinance, the Swiss population has easy access to bank accounts. The great majority of firms and individuals own at least one private account with a bank or with PostFinance – typically serving also as a salary account. Cashless payment transactions are generally made by using the balances on these accounts.

---

fixing of the DMIF in Switzerland to be a price agreement violating the principle of competition (for more details on the DMIF regulation, see Section 2.2.5).

<sup>30</sup> Called "Stiftung für Konsumentenschutz", which translates into "Foundation for Consumer Protection".

<sup>31</sup> Orell Füssli Security Printing Ltd ([www.ofs.ch](http://www.ofs.ch)). The company is based in Zurich and belongs to the Orell Füssli Group. The SNB holds a third of the shares of Orell Füssli Group.

<sup>32</sup> "Cash-back" is a term used for the withdrawal of cash at the point of sale. This function is currently not offered to Maestro cardholders in Switzerland.

### 2.2.2 Credit transfers

The overwhelming majority of cashless payments in Switzerland take the form of credit transfers, not least because of historical developments as described in 1.3.1 above. In 2009 a total of more than 702 million credit transfers with a value of CHF 3,970 billion (contrasting with 521 million card payments totalling CHF 81 billion and 0.71 million payments with cheques amounting to CHF 2 billion in 2009) were initiated by non-banks and settled in SIC and PostFinance.

It is worthwhile to note that the billing culture in Switzerland is primarily based on credit transfers. Generally, each consumer bill (eg insurance, utilities, telecommunication or obligations from distance sales) and also tax bills have a standardised payment slip attached, including details on the amount due, the beneficiary's bank, its account number and address.

Consumers have different ways for paying their bills by means of a credit transfer (the most common are listed below). While banks/PostFinance generally charge a per transaction fee for those options that include manual manipulations, bill payment using online banking is typically free of charge.

- In the most traditional way, the customer takes the payment slip to the nearest post office and effects the payment by passing the payment slip along with the cash over the counter. This procedure is possible for two reasons: firstly, all Swiss payment slips are standardised and acceptable for payment at Swiss Post Offices, even if the beneficiary's account is with a bank. Secondly, Swiss Post allows non-account holders to effect payments in cash at the counter.
- Customers can send payment slips by mail to their home bank/PostFinance, where they will be processed in processing centres.
- Most banks that offer transaction accounts also provide online banking facilities for their customers. In order to initiate a payment online, a customer has to manually enter the payment information provided on the physical payment slip into the online banking application.<sup>33</sup>
- Another form of paying bills online are e-bills schemes.<sup>34</sup> At least three conditions have to be met to initiate electronic bill (e-bills) payments: Firstly, the payer (customer) has to use internet banking with his/her home bank and register for e-bills services. Secondly, the customer's and the biller's financial institution have to be a participant in the e-bills platform (SIX Paynet or PostFinance E-bill). Thirdly, also the biller needs to register with the e-bill platform and needs to have an account with PostFinance and with a bank participating in the SIX Paynet. If these conditions are met the customer can choose to receive bills electronically from the biller instead of on paper. As of that moment all the bills of the corresponding billers will show as e-bills on the customer's internet banking interface. Payment of e-bills can be executed by means of one click. However, unlike the direct debit procedure the initiative for paying an e-bill stays with the customer, as does the control for changing the due date or the amount of the bill.

Moreover, credit transfers can be delivered in the form of standing orders. These are typically implemented with repeating payments of the same amount such as rent, insurance premiums or certain utility payments. Standing orders can be initiated online or on paper forms.

---

<sup>33</sup> There are also sophisticated devices available that reduce the necessary manual interventions.

<sup>34</sup> Also known as e-invoicing or electronic bill presentment and payment.

Swiss banks and PostFinance have been participating in the SEPA (Single Euro Payments Area) credit transfer scheme since the end of January 2008,<sup>35</sup> enabling customers to initiate credit transfers for domestic and cross-border payments in euros using the SEPA credit transfer procedure. Traditional payment procedures can be used concurrently. As a result of the use of the IBAN and BIC<sup>36</sup> for SEPA payments, more and more credit transfers in Swiss francs use IBAN instead of the traditional bank account number and bank address. The IBAN is now printed on each account statement and on most Maestro debit cards.

### **2.2.3 Direct debits**

Both the banking sector and PostFinance offer separate direct debit procedures. The banking sector's interoperable direct debit services are offered in Swiss francs and euros by SIX SIC Ltd and settled in SIC/euroSIC.<sup>37</sup> PostFinance's proprietary direct debits are also available in Swiss francs and euros and settled internally. In 2009, the number of direct debit transactions initiated at accounts with banks and PostFinance was 46 million with a total value of CHF 62.2 billion (compared to 52.2 million transactions with a value of CHF 80.5 billion in 2005).

Typically the direct debit procedure is used for recurring payments of variable amounts, for instance credit card bills, insurance premiums, telecommunication or utilities bills. One-time consent of the debtor (payer) is needed to authorise a specific biller to initiate the direct debit procedure. The beneficiary is responsible for obtaining the authorisation of the debtor.

Technically, direct debits offered by SIX SIC Ltd are processed as credit transfers. At least two days before the due date of the payment, the beneficiary sends the details of the upcoming payment to the payer's bank, where all the necessary checks are conducted (eg check of account holder, of sufficient account coverage, of correctness of authorisation). If all the checks pass successfully, the payer's bank releases the payment in the form of a credit transfer on the due date and charges the payer's account accordingly. Payments are settled individually in SIC.

Since November 2009 Swiss financial institutions have provided SEPA direct debit transactions in euros through euroSIC. By means of the SEPA direct debit procedure, consumers are given an instrument to execute direct debits in euros across borders reaching all SEPA countries. In mid-2010, however, only six Swiss banks were participants in the SEPA direct debit scheme. The value and volume of SEPA direct debit payments involving Swiss financial institutions have remained marginal, in line with the trend in most SEPA countries.

Overall, direct debits have decreased in both value and volume in the last five years, while credit transfers have increased in value and in volume. E-bills are evidently becoming a serious competitor for direct debits, as the number of consumers and companies using and offering e-bills increases. Both payment processes are similarly convenient, but from the perspective of a consumer e-bills have a small but important advantage over direct debits: while the control to initiate an e-bill payment remains with the payer, in a direct debit transaction the consumer cedes control to charge his/her account to the biller. Despite adequate power for consumers to revoke unjustified direct debits, surrendering control over one's account to a third party may seem questionable, especially since e-bills offer a valid alternative without this drawback.

---

<sup>35</sup> As of July 2010, 150 Swiss financial institutions were participants in the SEPA Credit Transfer scheme.

<sup>36</sup> The IBAN (International Bank Account Number) and the BIC (Bank Identifier Code) identify an account and a bank respectively and are both ISO standards.

<sup>37</sup> euroSIC is an interbank payment system settling transactions in euros. For details, see Section 3.3 below.

### 2.2.4 Cheques

As mentioned in Section 1.3.1, cheques have never been widely used in Switzerland for historical reasons. Since around 2000 the already slim significance of cheques has continued to decline, not least due to higher fees charged by financial institutions for issuing cheques and for cashing them in. An increasing density of ATMs and EFTPOS<sup>38</sup> terminals may also have contributed to this decline. As a consequence of the decreasing use of cheques, the Swiss cheque clearing centre was closed down in 2004 and banks had henceforth to collect the funds from the drawn bank directly. Settlement takes place individually in SIC. In 2009 a total of merely 0.71 million cheques were processed, amounting to CHF 2.02 billion (compared to 11.2 million cheques with a value of CHF 27.7 billion in 2000).

Equally, traveller's cheques in Swiss francs have declined strongly in significance over recent years. While they amounted to CHF 1 billion in 1989, less than CHF 50 million worth were used around the world in 2009. Consequently, at the end of 2009, Swiss Bankers<sup>39</sup> ceased to issue traveller's cheques in Swiss francs. Alternatively, they offer a prepaid card (travel cash) which can be used for cash withdrawal at most ATMs around the world and for payment at EFTPOS terminals wherever Maestro is accepted. Like traveller's cheques, travel cash cards are promptly replaced worldwide if stolen or lost.

### 2.2.5 Card payments

#### *Credit cards*

Swiss consumers have traditionally relied less on credit cards than consumers in other countries. Only in recent years have major retailers started to offer credit cards without an annual fee and have linked these cards to their existing bonus programmes. Accordingly, the number of credit cards, along with the number of transactions, has begun to increase. At the end of 2009 around 4.7 million cards were in circulation in Switzerland (compared to 3.1 million cards in 2000). Accordingly, the number and value of credit card transactions in Switzerland increased over the same period from 90.9 million transactions to 149.2 million, and from CHF 18 billion to CHF 26.4 billion, respectively. Consumers in Switzerland can choose between a range of different credit card brands; besides the dominant players MasterCard and Visa, American Express or Diners Club cards are issued. Other international credit card brands such as Discover, JCB or China Union Pay are not issued in Switzerland, but are accepted by many retailers at their POS (point of sale) or at ATMs for cash withdrawal.

Credit card issuers in Switzerland grant card owners a grace period of typically 20 days after issuing the invoice to meet their obligations. Owners are generally billed in Swiss francs; in some cases they can also opt for credit cards in euros or US dollars. Interest on outstanding credit card balances after the grace period is limited to 15% by the consumer credit law.<sup>40</sup> Thus, credit card issuers demand between 9.5% and 14.75% interest. However, in Switzerland only an estimated 10–20% of consumers make use of their credit cards' credit option by becoming credit revolvers, while the others tend to pay their bills on time. Payment of credit card bills is typically done using one of the above-mentioned credit transfer methods or by means of direct debit.

---

<sup>38</sup> Electronic funds transfer at the point of sale.

<sup>39</sup> Swiss Bankers Prepaid Services Ltd is a joint stock company owned by the Swiss banks founded in 1975 for the issuance of traveller's cheques; nowadays, however, the company is primarily active in the prepaid cards market. See Section 2.3.3.

<sup>40</sup> Bundesgesetz vom 23. März 2001 über den Konsumkredit (federal law on consumer credit). In force as of 1 January 2003.

### *Debit cards*

The debit card market in Switzerland is dominated by two main schemes. Banks issue debit cards of the international Maestro scheme, while PostFinance issues its own debit card named PostFinance Card. POS terminals as well as ATMs generally process both debit card schemes along with a selection of additional cards, depending on the acquiring contract of the retailer. Besides the two dominant players, a leading retailer in Switzerland, Migros, issues its own debit card named M-Card through its affiliated bank, Migros Bank. M-Card owners have a bank account with Migros Bank and can use the card for POS debit transactions with all merchants affiliated to Migros. Some of the M-Cards are dual branded with Maestro and can be used outside the Migros world. All debit cards in Switzerland are equipped with EMV chip technology.<sup>41</sup>

The foreign-issued Visa debit cards, V-Pay and Visa Electron, are widely accepted by retailers in Switzerland but are not issued by financial institutions in Switzerland. There is, however, some indication that Visa may issue its first V-Pay cards in Switzerland in 2011.

Starting in the late 1990s Maestro cards<sup>42</sup> were equipped with the e-money chip CASH. However, in 2009 most Swiss banks issuing Maestro ceased to provide CASH on their debit cards (see the discussion of electronic money below).

Overall there has been a substantial increase in the number of debit cards in circulation. From 5.2 million cards in 2000 (172 million transactions, for CHF 26.1 billion) the number of cards in circulation rose to more than 7.9 million in 2009 (371 million transactions, for CHF 55.2 billion). Consequently, there is slightly more than one debit card per capita in Switzerland.

### *Retailer cards*

Various petrol companies, large retailers and retailers' associations issue their own payment cards, which are typically only valid at their particular outlets. Customers generally receive a monthly statement of their purchases. Typically no subscription fee is charged.

### *Electronic money*

Since January 1997, the e-money solution CASH has been in operation in Switzerland. CASH is a chip-based card that can be loaded and unloaded at bank ATMs<sup>43</sup> and was meant to substitute for small-value cash payments. For over a decade the CASH e-money function was part of most Maestro cards. PostFinance offered a neutral CASH card. All customers with the CASH function on their card could load funds onto their chip at any ATM up to a maximum of CHF 300, technically transferring the amount from their transaction account onto the chip. CASH has a comparable characteristic to that of currency in cash: in case of card loss, the amount on the chip is irrevocably lost.

Accepting CASH at their POS requires retailers to install a separate e-money terminal.<sup>44</sup> Consequently, while more than 5 million cards with a CASH chip were in circulation in 2009, only around 13,000 terminals accepted CASH in Switzerland – a considerably smaller number than the 143,000 EFTPOS terminals that accept most debit and credit card brands.

---

<sup>41</sup> EMV is a standard that was devised jointly by Europay, MasterCard and Visa to facilitate compatibility for chip-based payment cards (EMV stands for the three initial letters of the three card systems).

<sup>42</sup> Or its predecessor ec-Card.

<sup>43</sup> PostFinance ceased to offer this option at its ATMs in September 2009.

<sup>44</sup> A terminal that can process CASH payments along with debit and credit card transactions was launched only in mid-2010.

While some canteens and a few kiosks offered CASH terminals, most payment points where e-money could have had a considerable convenience advantage over coins remained without the CASH option (eg parking meters, ticketing or vending machines). This may have contributed to the general low popularity of CASH and the steady decline of its usage over the last decade. After a peak in 2002 of 20 million transactions, the number of CASH transactions decreased to 15 million in 2009 while values remained roughly unchanged at CHF 70 million.

In 2009 PostFinance decided to no longer issue its neutral CASH card. Likewise, in 2010 the majority of Swiss banks gave up issuing their Maestro cards with a CASH function. This will naturally lead to a substantial decrease of CASH-capable cards in circulation. Consumers still wishing to pay with CASH will have to put up with carrying an additional neutral CASH card.

#### *Payment card interchange fee regulation in Switzerland*

In 2004 Comco started an investigation of the domestic multilateral interchange fee (DMIF) charged by MasterCard and Visa in the Swiss credit card market (to date there has been no DMIF in the debit card market). Since most credit card issuers in Switzerland engage in dual branding,<sup>45</sup> the same representatives sit on both committees where the DMIF for each card system is set. Comco came to the conclusion that the fixing of the DMIF was, in principle, a price agreement and that the non-discrimination rule was anti-competitive. It did concede, however, that a multilateral procedure for setting the interchange fee in a complex four-party system actually has efficiency advantages in that it facilitates market entry for newcomers and contributes significantly to lower transaction costs.<sup>46</sup> In Comco's opinion, nonetheless, the collective setting of the interchange fee would be an advantage only if the fee were limited to actual cost components that were indispensable for the functioning of the network. These cost components did not include the costs arising from the interest-free period, losses in connection with the payment guarantee, marketing among merchants or reward schemes.

On the basis of this cost approach, the parties involved together with Comco came to an amicable settlement which sets a maximum DMIF of 1.3–1.35% per transaction. For reasons of transparency, the parties involved are obliged to disclose the exact DMIF to merchants. In addition, the non-discrimination rule was declared unlawful in order, firstly, to strengthen the negotiating position of merchants and, secondly, to increase the competitive pressure on credit card systems from other payment instruments. This amicable settlement of 2005 was set to run for four years, which would allow Comco to reassess the effects of the measures taken on competition in the credit card market at the end of this period. Accordingly, a new investigation by Comco was opened in June 2009. In early 2010 Comco issued provisional measures with the aim of renewing the approach of 2005 in a modified manner. As a consequence, the new DMIF has been set at 1.058%. As in 2005, these new measures are based on an amicable settlement with the most important market players and will stay in force until Comco has come to its final decision.

#### **2.2.6 Automated teller machines**

Switzerland has two ATM networks in operation: the bank network (Bancomat) operated by SIX Card Solutions and the PostFinance network (Postomat). The two networks are

---

<sup>45</sup> Ie they issue both Visa and MasterCard cards.

<sup>46</sup> Without a multilateral approach an acquirer, for instance, that tries to gain access in the Swiss market would have to fix an interchange fee with every Swiss issuer bilaterally.



interoperable; however, typically cash withdrawals other than at branches of a customer's home bank's ATM or in the other network are subject to a fee.<sup>47</sup>

The number of ATMs operated by the two networks has increased substantially, from 4,866 in 2000 to 6,228 in 2009. While the number of withdrawals at ATMs in the country increased from 98.9 million in 2000 to 120.3 million in 2009, the total amount withdrawn remained almost constant, at CHF 26.3 billion in 2009 versus CHF 26.8 billion in 2000.

Both Bancomat and Postomat networks support cash withdrawals using a wide range of domestic and international debit and credit cards. Besides cash withdrawals, Bancomat and Postomat offer some basic additional functionalities, such as changing the PIN code, loading/unloading of the chip-based e-money CASH,<sup>48</sup> or requests for bank account statements. All Postomats and a majority of the Bancomats offer cash withdrawals in both Swiss francs and euros. A few banks offer terminals on their premises with a cash deposit or credit transfer function for their own customers.

Cash withdrawals at a card owner's home financial institution are processed internally and are typically free of charge as part of the account holder's package, while cash withdrawals at other banks are processed by third-party card processors and are mostly charged a per transaction fee. Some of the subsequent interbank obligations arising from such cash withdrawals are settled in SIC in bulk payments depending on the arrangements by the processor.

PostFinance gives its cardholders the option to withdraw cash not only at every post office and at every ATM of both national schemes, but it also offers cash-back at the POS of various retailers and Swiss Federal Railways. Cash-back would technically also be possible for Maestro cards: however, this functionality is currently not offered.

### **2.2.7 EFTPOS infrastructure**

The current EFTPOS infrastructure in Switzerland has been conjointly operated and developed over the last one and a half decades by a consortium consisting of PostFinance and what used to be Telekurs Group<sup>49</sup> together with large merchants, acquirers and EFTPOS terminal producers. Based on the objective to standardise all card payments including all related processes, functionalities and interfaces independent of card brand and card type, these market groups concertedly engineered the ep2 standard. This standard allows for an open and modern system based on international standards (eg EMV chip technology) and international recommendations. It provides that all payment card brands and card types can be processed at the same terminal and that the act of payment is identical for all consumers across all card brands and card types. For merchants, ep2 standardises operational processes with all acquirers and terminal providers. An ep2-capable terminal can be connected to multiple acquirers, thus allowing for competition between acquiring services. Consequently a merchant can choose the most lucrative offer for each accepted card and is not bound by the terminal infrastructure to one specific acquirer for all accepted card brands. Moreover, the ep2 standard is also compatible with the requirements of the SEPA cards framework.

---

<sup>47</sup> Fees vary between banks as well as between card types. Withdrawals with credit cards tend to carry higher fees than those with debit cards.

<sup>48</sup> This functionality was phased out at PostFinance's ATMs in September 2009.

<sup>49</sup> Now SIX Multipay and SIX Card Solutions, both subsidiary companies of SIX Group Ltd.

The cooperative approach in the area of EFTPOS infrastructure allowed the development and implementation of a common standard (ep2) that facilitates competition on card payment services while not compromising industry-wide efficiency and interoperability.

Hence, most Swiss EFTPOS terminals are compatible with the ep2 standard. At the end of 2009 there were a total of more than 261,000 EFTPOS terminals at retail outlets and filling stations accepting Maestro and/or PostFinance cards (compared to 141,000 terminals in 2000)<sup>50</sup> and 321,000 EFTPOS terminals accepting credit cards at end-2009 (2000: 275,000).<sup>51</sup>

## 2.3 Recent developments

### 2.3.1 Mobile payments

Several m-payment solutions have been promoted in Switzerland over the last few years. Some of them charge the payment amount to mobile phone bills, while other m-payment solutions are linked to bank accounts or credit cards.

PostFinance, for example, offers an m-payment solution for its customers – a system that is not interoperable with account holders of other banks. After having registered for the service, a PostFinance customer can initiate a payment via SMS, or at certain sale points the customer is prompted to call a specific phone number. In the latter case after a successful connection a caller is asked to initiate a payment by typing a sequence of digits on the mobile phone keypad. The payment amount is charged to the customer's PostFinance account and in-house settlement and notification of sender and beneficiary takes place instantaneously. For security reasons there is a default transaction cap of CHF 100 per day and CHF 250 a month.<sup>52</sup> Consequently, PostFinance's m-payments are typically used for small-value customer-to-customer transfers or customer-to-business payments.

A further m-payments solution for smartphones, called "Vanilla", was launched in mid-2010 by a leading Swiss media company in collaboration with a bank specialised in consumer credit and credit card issuance.<sup>53</sup> To initiate a payment, registered users have to activate an applet on their smartphone using a PIN. The applet generates a one-time-useable bar code on the phone's screen which can be presented to the bar-code scanner at the POS of a registered merchant. The scanner recognises the bar code as a Vanilla payment and passes the payment details on for processing. As with a credit card, Vanilla users can pay their full monthly credit balance or opt for monthly instalments (the outstanding amounts are charged interest comparable to that of credit cards). Credit limits apply depending on the creditworthiness of a customer.

M-payments have been slow to take off in Switzerland – a fact that may not be overly surprising given the well established payment infrastructure in the country. Almost all Swiss consumers are banked, have easy access to initiate payment transfers (via post offices or through their home bank by mail or online banking) and have at least one payment card that is linked to their bank account with almost ubiquitous acceptance by merchants. Thus, in any payment situation a customer typically has one or more alternative instruments available

---

<sup>50</sup> An EFTPOS terminal that processes debit card payments by PostFinance and Maestro is counted as representing two processing possibilities.

<sup>51</sup> Data including MasterCard, Visa, American Express and Diners. A POS can accept multiple credit card brands. Accordingly, the figures can include multiple counting.

<sup>52</sup> Both caps can be adjusted by the user at any time and to any amount between CHF 0 and CHF 3,000.

<sup>53</sup> Details on the functioning as well as on the service range and products can be found at [www.vanilla.ch](http://www.vanilla.ch).

besides cash. Consequently, the niche for the present m-payment solutions offered in Switzerland appears to be somewhat slim. Places where m-payments are currently used include parking meters, vending machines, unattended shops at the roadside offering produce and flowers, or mountain cabins without EFTPOS but with mobile phone reception.

### **2.3.2 Payments in e-commerce**

Moreover, in reaction to the increasing share of online purchases in recent years, a variety of services have come to the market that provide secure online card payment terminals. A consumer can typically pay at these online terminals with a similar range of cards as at physical POS terminals.

Overall, the area of online payments for e-commerce has undergone some innovations in recent years. The objective of these developments typically is to increase the (perceived) payment security for the consumer. Credit cards still account for the dominant share of payments executed online. Nevertheless, some studies show that concerns about passing on credit card credentials are among the main reasons why consumers cancel online purchases before the payment stage.<sup>54</sup> To improve this situation, credit card companies on the one hand are endeavouring to improve security standards for online payments by applying additional security features such as MasterCard SecureCode or Verified by Visa. On the other hand, e-payment solutions are being promoted that enable consumers to use their familiar online banking environment to initiate a payment to an online shop.<sup>55</sup> PostFinance is the only Swiss financial institution which currently offers an online-banking-based e-payment solution. Additionally, a German non-bank payment service provider<sup>56</sup> offers e-payments and has its platform linked to a range of Swiss banks' online banking websites. The Swiss banks and PostFinance are currently in the process of evaluating the establishment of their own e-payments platform within the SEPA framework.

### **2.3.3 Contactless and prepaid cards**

Contactless credit card technology along with contactless cards has been introduced in Switzerland in the past few years. However, these innovations have neither been widely used nor widely accepted so far.

Recent years have, however, seen an increase in the variety of prepaid cards offered in Switzerland. They tend to replace physical vouchers of various sorts. Big retailers in particular are phasing out traditional gift vouchers by replacing them with prepaid gift cards. Increasingly, the merit of prepaid cards is also being perceived in the light of the almost ubiquitous acceptance of debit and credit card schemes at POS or ATMs. Prepaid cards are issued for a range of purposes such as travelling, for people without access to real credit cards or without bank accounts, or for customers with low creditworthiness.

As mentioned in Section 2.2.4, a traditional issuer of traveller's cheques has started to produce prepaid Maestro-based travel cards. In addition, Maestro-based prepaid cards have

---

<sup>54</sup> See for example M Breitschaft et al, "Erfolgsfaktor Payment – Der Einfluss der Zahlungsverfahren auf Ihren Umsatz", ibi research, Universität Regensburg, June 2008, [www.ecommerce-leitfaden.de](http://www.ecommerce-leitfaden.de).

<sup>55</sup> When reaching the checkout in the online shop, consumers are given the option to pay via e-payment besides credit cards, Pay Pal or other means. They can click on the icon of their home bank and get connected to their home bank's familiar online banking environment. After having gone through the regular authentication procedure (eg username, password, token), the amount due to the online shop shows up in the online banking-interface. After a few clicks the payment is initiated and the online shop is informed instantly about the payer's bank's payment guarantee.

<sup>56</sup> [www.sofortueberweisung.de](http://www.sofortueberweisung.de).

been developed for organisations to replace cash payments to their beneficiaries. For instance, such cards are used by migration authorities to provide support to migrants without bank accounts, by consumer credit companies to disburse instant loans, or by airlines to make compensation payments to international passengers. Moreover, recently a prepaid card based on the MasterCard scheme has been launched that can only be used for payments via the internet, targeting people without access to real credit cards but in need of a payment instrument for online purchases.

### **3. Payment systems (funds transfer systems)**

#### **3.1 General overview**

While the settlement of payments among customers of the same bank typically takes place in-house, interbank cashless payments in Swiss francs are executed in SIC. SIC is the central electronic Swiss payment system where participating financial institutions settle their payment obligations. Interbank payments in euros are for the most part settled in euroSIC, technically a clone of the SIC system with differences in the governance structure, regulation and oversight requirements. SIC and euroSIC settle both large-value and retail payments (for euroSIC, see Section 3.3).

There is no specific retail payment clearing house in Switzerland. Previous interbank retail payment clearing arrangements, eg for data carrier applications or cheques, have been closed down in recent years due to the decreasing demand for such services and technological advances that made them obsolete. Payments that used to be cleared in previous retail systems are now settled individually in SIC/euroSIC. Moreover, the former direct debit clearing arrangement was superseded by a different technical direct debit procedure in 2006, in which direct debits are individually settled in SIC/euroSIC.

#### **3.2 Large-value payment system: Swiss Interbank Clearing**

##### **3.2.1 Institutional framework**

The SIC system – Switzerland’s RTGS system – has been in operation since June 1987. It is operated on behalf of the SNB by SIX Interbank Clearing Ltd, a subsidiary company of SIX Group Ltd. Currently, SIX Interbank Clearing Ltd is 75% owned by SIX Group Ltd, while PostFinance holds a share of 25%.

The SNB is the system manager and settlement agent. In this function, it lays down the conditions for admission to and exclusion from the SIC system. The SNB maintains the accounts of the participating institutions, provides the liquidity necessary for settlement in SIC and sets times when operations begin and end. In addition, the SNB monitors daily operations and is responsible for crisis management in the event of disruptions or incidents. SIX SIC Ltd operates and maintains the processing centres as well as the communications and security installations. It also develops and maintains the software and manages the data files as well as the organisational and administrative rules of conduct.

There is no comprehensive single law that covers all aspects of relevance for a payment system in Switzerland. The enforceability of contracts under private law as well as payment instructions executed under the SIC system are governed by the Swiss Code of Obligations. The Code of Obligations supports in particular the electronic processing of payments and underpins the SIC rules and regulations in relation to the irrevocability of payment instructions. In this respect, a provision in the Code of Obligations which came into effect on

1 October 2009 states that payment instructions are irrevocable with the debiting of the transferor's account unless the rules and regulations of a payment system state otherwise.

Where one of the participants concerned becomes the subject of insolvency proceedings, its rights and obligations are addressed under insolvency laws. In order to protect the system against systemic risks, Article 27 (2) of the Swiss Banking Act limits the effects of insolvency measures on instructions given to payment systems and protects the finality of a payment in the event of a system participant's insolvency. Under Swiss law there is no "zero hour rule" which could affect the validity of the transaction order.

The rights and obligations of the SNB, SIX Interbank Clearing Ltd and the system participants are set out in three contracts governed by Swiss private law:<sup>57</sup>

- SIC participants' relationship with the SNB, as provider of settlement accounts, is governed by the SIC giro agreement (SIC-Girovertrag). The SIC rules and regulations, consisting of technical rules and regulations and a user manual, are part of this contract and therefore binding for all SIC participants. Among other things, they govern the sequence of the settlement day (including hours of operation and the different phases during an RTGS business day), different types of participation in the system, security issues, contingency arrangements, message standards, settlement of the transaction (including definition of the moment when the settlement of a payment becomes irrevocable) and various aspects related to system administration.
- SIC participants are also obliged to sign the SIC supplementary agreement with SIX Interbank Clearing Ltd (SIC-Ergänzungsvertrag). This agreement governs the code of conduct in SIC and in particular the allocation of potential losses.
- The relationship between the SNB and SIX Interbank Clearing Ltd is governed by a contract which defines the obligations and duties of each party.

Committees including representatives of the SNB and the participating institutions submit proposals for changes and additions to the manuals and take decisions on technical modifications to the application. All changes and additions require the SNB's approval.

The SIC system is a key element in the Swiss Value Chain<sup>58</sup> and plays a crucial role for the implementation of the SNB's monetary policy. The SNB has designated SIC as important for the stability of the Swiss financial system. As a consequence, the SIC system needs to comply with the minimum requirements set out in Articles 22–34 of the NBO. These minimum requirements are largely based on international standards (ie the Core Principles for Systemically Important Systems).<sup>59</sup>

### **3.2.2 Participation**

Originally, participation in SIC was limited to banks domiciled in Switzerland and subject to banking supervision by FINMA. The only exceptions to this rule were domestic clearing and settlement organisations. Over the years, this policy has been increasingly challenged by developments in domestic and international financial markets. On the one hand, non-bank intermediaries have gained ground in financial markets and thus questioned the dominant

---

<sup>57</sup> Providers of service payments (see Section 3.2.3) and indirect SIC participants need to sign additional contracts. Participants with a SWIFT connection need to sign a contract pertaining to participation in the SWIFT closed user group with SIX Interbank Clearing Ltd.

<sup>58</sup> See footnote 24.

<sup>59</sup> Committee on Payment and Settlement Systems, *Core principles for systemically important payment systems*, Bank for International Settlements, Basel, January 2001.

role of banks in this area. On the other hand, globalisation of markets has brought about not only ever-growing payment volumes, but also stronger competition among financial centres and associated cooperation and mergers between providers of financial market infrastructure. These trends have led to an increased need for remote payment system access. In the wake of these developments, the SNB's access policy has been substantially revised. The first major revision took place in 1998, when access to SIC was granted to supervised securities dealers (non-banks), international joint ventures, clearing and settlement organisations, as well as the associated banks as long as all these were subject to the same standards in regard to supervision, anti-money laundering and telecommunication infrastructure as Swiss participants.

In the second revision of the SIC access policy<sup>60</sup> that was put in force on 1 January 2010, access was broadened to include FINMA-regulated insurance companies and funds managers that are highly active in the money market. The new policy extends the group of participants to include foreign clearing and settlement companies without a banking licence provided they contribute to the stability of the financial system or to the smooth flow of payments transactions. Such companies must not bring with them additional risks and must prove that they are regulated adequately. Moreover, all participants are required to: have an appropriate internal organisation; conduct business in a professional manner; be knowledgeable about the functioning of the SIC system; ensure professional liquidity management; and meet technical and administrative obligations.

At the end of 2010, SIC had a total of 377 participants: 119 banks domiciled in Switzerland; 121 foreign banks registered in Switzerland; 118 foreign banks registered abroad; and 19 non-banks (private cash handling companies, government related institutions, PostFinance, insurance companies as well as clearing and settlement institutions).

### **3.2.3 Types of transaction**

SIC is both a large-value payment system and a retail payment system. The majority of interbank cashless payment transactions in Switzerland are settled through SIC.

The types of payment handled in SIC can be divided into three categories: (i) customer-related payments (sender and receiver are non-banks); (ii) bank-to-bank payments (both parties are banks and SIC participants); and (iii) service payments (where a third party (eg SSS, card processor, SNB) is allowed to debit the account of an SIC participant and credit the amount to another SIC participant's account).

In 2009 SIC settled a daily average of 1.5 million transactions with a value of CHF 225.5 billion. The bulk of payments (88% in 2009) were smaller than CHF 5,000. In terms of total value, however, these small-value payments are negligible (0.005% in 2009).

On peak days SIC settled more than 4.8 million payments with a value of CHF 411.5 billion, which corresponded to 76% of 2009 Swiss GDP. Compared with other large-value payment systems internationally, SIC is among the top in terms of number of transactions settled, a fact that is predominantly due to the large number of retail payments being individually settled in SIC.

---

<sup>60</sup> For details on access criteria, see "Instruction sheet on cashless payment transactions", available at [www.snb.ch](http://www.snb.ch).

### **3.2.4 Operation**

#### *Real-time gross settlement*

SIC is an RTGS system. In contrast to deferred net payment systems, where incoming and outgoing payments are accumulated and the net amount is settled irrevocably and with finality at a later, predetermined time, SIC settles each payment individually, irrevocably and with finality.

#### *Account management*

The balances held by SIC participants in their sight deposit accounts at the SNB serve as the settlement asset. Payments are thus settled in central bank money. The sight deposit account is used for cash withdrawals and transactions with the SNB which are routed through the SNB's accounting system. Interbank transactions in SIC are routed via the SIC settlement account. The reason for having a separate sight deposit account and settlement account is merely of a technical nature; from a legal point of view, both accounts are considered as one. An additional SIC sub-account is available to those SIC participants that are linked to the international foreign exchange settlement system CLS. In this sub-account, banks can reserve liquidity to be used exclusively for time-critical payments to CLS Bank.

#### *Connectivity*

There are three ways for participants to connect to SIC:

- Via a proprietary network: Participants can connect to SIC via the SIX Group's proprietary communication network FinancIP Net. The connection can either be direct or via a third-party service bureau. For direct connection, the requirements include a dedicated telecommunications line, defined hardware and software, a high-security module and a front-end application. The technical requirements in the case of connection via a third-party service bureau vary according to provider.
- Via SWIFT: Participants can connect via SWIFT using the remoteGATE connection. With this variant, payments are entered via a SWIFT application. The settlement account can be viewed through an internet connection.
- Via the SNB: In exceptional cases, the SNB itself manages a participant's settlement accounts (eg Eurex and SECOM transactions or interbank payments for liquidity management are admissible via these accounts). Communication between the participant and the SNB is based on SWIFT.

### **3.2.5 Settlement**

#### *Process sequence of a settlement day*

Participants can enter their payment orders in SIC around the clock. Payments are processed for approximately 23 hours. A settlement day starts at 5.00 pm on the previous calendar day and ends on the value date at 4.15 pm. All payments entered by 3.00 pm (cutoff 1) are settled as of the same value date.

Customer payments entered after cutoff 1 will be settled as of the following value date. Cover payments, however, may also be submitted for same-day settlement between 3.00 pm and 4.00 pm (cutoff 2). Cover payments are bank-to-bank payments that are made in the name and on account of the bank issuing the transfer order. The reason for such payments may, for instance, be money market transactions. Consequently, the interval between cutoff 1 and cutoff 2 allows those participants whose payments could not be settled to procure the necessary liquidity on the money market. In addition, between 4.00 pm and 4.15 pm (cutoff 3), participants may also obtain liquidity from the SNB under the liquidity-shortage financing facility via special-rate repo transactions. The SIC day closes with end-of-day processing

where pending payments are cancelled and balances are transferred from the SIC settlement account to the sight deposit account. The next value date begins at approximately 5.00 pm, and the balances of the individual sight deposit accounts are transferred to the SIC settlement accounts.

Payments are only settled in SIC if the remitting party has sufficient funds in its SIC settlement account. Any time the participant enters a new payment, it is first queued. If there is sufficient cover in the SIC settlement account, the payment order will be settled immediately. If funds are insufficient, the payment remains in the queuing system until there are sufficient funds. SIC participants can manage the settlement sequence of their payments by assigning priority classes to payments. The exact settlement sequence of the payments in the queuing system is then determined by an algorithm, the functioning of which is described below. Payments in the queuing system can be revoked by the remitter at any time up to cutoff 1 (3.00 pm) without the consent of the recipient. Payments remaining in the queuing system at the end of the settlement day due to insufficient cover will be cancelled and must be resubmitted. In such a case, the recipient of the payment that was not settled is entitled to charge the remitter default interest amounting to the prevailing money market rate plus 50 basis points.

#### *Settlement algorithm*

If SIC cannot settle a participant's payments immediately following their submission due to insufficient funds, payments are transferred to a waiting queue and organised according to priority and time of submission. As soon as the necessary funds are available, the oldest payment in the queue with the highest priority is settled first. If the system is unable to settle a participant's first payment in the queue for 15 seconds, circle processing is initiated. This mechanism checks whether a counterpayment of the receiving participant to the sending participant is pending in the queue. If enough funds are available for the settlement of the net amount, the two payments are processed simultaneously, thus resolving the gridlock in the system. Subsequently, the regular settlement resumes.

### **3.2.6 Credit, liquidity and operational risk management**

#### *Credit risk*

Credit risk is the risk that a party will not be able to meet its financial obligations either when they fall due or at any time thereafter. In connection with payment systems, a distinction is made between two types of credit risk:

Firstly, there is credit risk between direct participants. In the case of netting systems, incoming and outgoing payments are accumulated, with the settlement taking place at a later, predetermined time. Up to the time of the final settlement, credit relationships can be established between participants, and this gives rise to credit risk. In the case of SIC, no such credit relationships are established because, owing to the use of real-time gross settlement, all payments are settled individually, irrevocably and with finality.

Secondly, settlement bank risk refers to the risk that the institution holding the accounts will default, causing the participants to lose their deposits. Thus, financial institutions that are not able or do not wish to participate in SIC directly incur the risk that their settlement bank will default. The SNB counters this risk by providing access to the payment system for as wide a range of participants as possible. Those financial institutions without access to SIC can minimise this risk by choosing an account-holding institution that is as financially sound as possible.

#### *Liquidity risk*

Liquidity risk is the risk that a system participant does not have enough liquidity to meet its financial obligations when they fall due but can do so at a later date. Different measures help



to keep the liquidity risk for SIC participants and the danger of a system gridlock as low as possible:

- First, participants can access different sources of liquidity, particularly the SNB's intraday and liquidity-shortage financing facilities (for details see Section 3.2.7). This allows them to react to fluctuating liquidity situations quickly and flexibly.
- Second, SIC supports the efficient use and active management of liquidity. Besides checking their account balances and the pending incoming and outgoing payments in the queue at any time, participants can manage the queue by prioritising and cancelling payments, thus optimising the payment stream. The option of entering payments in the system up to five days prior to their due date also facilitates liquidity planning.
- Finally, the following measures help to reduce system-wide liquidity requirements:
  - According to SIC rules and regulations payments in excess of CHF 100 million should be split up into smaller tranches, to prevent any gridlocks in the queuing system.
  - In case of a system-wide gridlock, SIC automatically activates an optimisation routine to unblock it. The system searches for any pending cross-payments from sending and receiving banks. If this is the case, and if sufficient cover is available, the payments are offset simultaneously on a bilateral basis.
  - The remitter of a payment pays a dual-component fee (see details on pricing policy in Section 3.2.9 below). One component depends on the time of entering the payment, the other on the time of settlement. Both fees increase in the course of the day. This creates an incentive for the participants to enter payment orders early, while at the same time providing sufficient liquidity so that settlement can occur equally early. The aim is to prevent participants from delaying their payments and waiting for incoming payments to finance their own outgoing payments.

### *Operational risk*

Operational risk is the risk of losses or disturbances as a result of the inadequacy or failure of internal procedures, employees and systems, or due to external events. Payment systems must satisfy high security standards with regard to availability, integrity, confidentiality and traceability of data throughout the processing of transactions. An operational disruption or indeed a temporary failure of the SIC system would greatly impair cashless payment transactions in Swiss francs.

A broad range of organisational and technical measures help to reduce the likelihood or, if the case arises, the impact of an operational disruption of the SIC system and ensure that normal processing operations can be resumed quickly. SIC applications and data are synchronously mirrored on two data centres. In the unlikely event of a disaster affecting both primary centres, SIC can be operated on a third out-of-region data centre which would take less than 10 hours to come into operation following a disruption. In the event of technical disruptions affecting individual participants, the SNB has the ability to execute payments on behalf of SIC participants.

SIC and SNB's operational unit have established processes to monitor, review and follow up on operational incidents that affect the RTGS operations.

As a critical financial market infrastructure, the SIC system must be able to restore critical business processes within two hours, even after a major disruption. In order to meet this requirement, SIX Group Ltd has implemented business continuity plans to handle failures of all relevant sources, including premises, IT infrastructure and staff. In recent years, efforts in the area of business continuity management have focused on strengthening the resilience of

the system in the event of a major incident affecting a wide geographical area and on the potential non-availability of critical staff (by implementing appropriate organisational measures).

The aforementioned measures notwithstanding, should the SIC system be unavailable for an extended period, either for technical reasons or due to connectivity issues, there is a regularly tested solution based on physical data exchange that allows settlement of payments with end-of-day finality.

### **3.2.7 Sources of liquidity**

In order to make payments in SIC, participants must have sufficient liquidity in the form of sight deposit balances at the SNB. From the viewpoint of a participant, there are essentially two sources of liquidity: other system participants and the SNB.

The first source of liquidity is other system participants. In making payments, they supply a participant with liquidity in the course of the day. The incoming liquidity can be used immediately for settling one's own payments. In addition, participants can temporarily borrow liquidity from other system participants on the interbank money market (or lend excess liquidity). Both incoming and outgoing payments and money market transactions result in a redistribution of liquidity in the system.

The SNB is the second source of liquidity for system participants. Unlike payments and money market transactions between banks, each transaction between the SNB and a system participant results in a change in the liquidity available in the system. With its monetary policy instruments, the SNB is therefore able to steer the aggregate level of liquidity in the SIC system.

For the SNB's monetary policy instruments, a distinction is made between open market operations and standing facilities, which include the intraday liquidity facility and the liquidity-shortage financing facility:

#### *Intraday facility*

In order to facilitate the processing of payment transactions in SIC, the SNB provides SIC participants with interest-free liquidity during the day via repo transactions. Participants may notify the SNB of their intraday liquidity requirements on the preceding calendar day (at approximately 4.00 pm). The corresponding repo transactions will then be carried out at approximately 6.00 pm. Between 8.00 am and 2.45 pm SIC participants have another opportunity to obtain additional intraday liquidity. The funds obtained must be repaid to the SNB by the end of the same value date at the latest. In this way, the sight deposit balances at the end of the day are not affected. In the event of late repayment, penalty interest is payable to the SNB until the day when the payment is made.<sup>61</sup>

#### *Liquidity-shortage financing facility*

The SNB provides SIC participants with overnight credit in the form of a liquidity-shortage financing facility, to enable them to bridge short-term liquidity bottlenecks. The interest rate for liquidity provided through this facility is half a percentage point above the call money rate.

---

<sup>61</sup> The penalty rate is calculated as follows: the call money rate (SARON – Swiss Average Rate Overnight) 12.00 noon fixing plus twice the special-rate surcharge, but not less than 1 percentage point (at end-2010 the special rate was 50 basis points). For more details see the "Instruction sheet on the intraday facility" available at [www.snb.ch](http://www.snb.ch).

The prerequisite for using the liquidity-shortage financing facility is that a limit is granted by the SNB and that this limit is covered by collateral eligible for SNB repos.<sup>62</sup>

### **3.2.8 Links to other payment and securities settlement systems**

SIC is linked to the SECOM securities settlement system, which allows the simultaneous settlement of obligations arising from the purchase or sale of securities on a delivery versus payment principle. The transfer of securities takes place in SECOM and the corresponding payment is settled in SIC (for details see Section 4.3.1). For the cash settlement of derivatives based on Swiss underlying assets, there is a link between SIC and the CCP Eurex Clearing. In addition, SIC is linked to the foreign exchange settlement system CLS. CLS Bank is a participant in the SIC system. CLS participants can settle foreign exchange transactions in 17 currencies via CLS. CLS participants can, thus, use SIC to transfer funds to their Swiss franc accounts at CLS Bank, where this liquidity is needed to settle foreign exchange transactions.

### **3.2.9 Pricing policy**

Apart from a one-time connection fee of CHF 3,000, there are no recurring annual or monthly usage fees.<sup>63</sup> Transaction fees in SIC are set at a level that allows SIX SIC Ltd to fully cover expected operating costs and to earn an adequate return on capital. If there are substantial discrepancies between expected and actual revenue, fees can be adjusted by the board of directors of SIX SIC Ltd in the course of the year. Fees are set per transaction and charged to SIC participants. It is left up to each bank to decide whether and to what extent to pass on charges to its customers.

As of 2010, the receiving bank pays a flat-rate fee of CHF 0.02 per transaction. The sending bank pays a fee based on the sum of two components, one of which depends on the time of entering a transaction and the other on the time of settlement. In addition, the fee differentiates between small- and large-value payments, with the threshold being CHF 100,000. The table on the following page shows the prices valid as of 2010.

The fee structure is designed with two mechanisms (progressive fees and threshold) to incentivise the input and settlement of payments at an early point in time. As the fee structure differentiates between small and large amounts – the threshold being CHF 100,000 – it is particularly attractive to enter small payments early. Early input is beneficial from a system perspective for several reasons: firstly, the earlier a payment is entered into SIC, the more settlement options are available to the settlement algorithm in case of a queue; and secondly, it prevents the demand for settlement capacity from peaking towards the end of a settlement day, ie at times when the occurrence of a gridlock or an operational incident would pose a major concern. However, due to the progressive fee structure and the fact that payments larger than CHF 100 million are generally split into a number of tranches, gridlocks have never been a major issue in SIC.

---

<sup>62</sup> For more details see the “Instruction sheet on the liquidity-shortage financing facility” available at [www.snb.ch](http://www.snb.ch).

<sup>63</sup> However, participants connecting to SIC through the SWIFT/remoteGATE service (see Section 3.2.4) are charged a monthly fee.

---

**Fee structure for the sending bank as of January 2010<sup>1</sup>**

In CHF

	Less than CHF 100,000		More than CHF 100,000	
	Input	Settlement	Input	Settlement
Before 8:00 am	0.007	0	0.007	0
8:00 am to 11:00 am	0.01	0.02	0.10	0.15
11:00 am to 2:00 pm	0.10	0.20	0.30	0.70
2:00 pm to 4:15 pm	0.40	0.60	1.00	2.00

<sup>1</sup> The receiving bank pays a flat fee of CHF 0.02 per payment (example: for a payment of less than CHF 100,000 entered before 8:00 am and settled after 2:00 pm, the sending bank pays CHF 0.607, consisting of CHF 0.007 for input before 8.00 am and CHF 0.60 for settlement after 2.00 pm).

---

### 3.3 Large-value payment system in euros: euroSIC

In light of the introduction of the euro the Swiss financial centre developed a central interbank payment system at the end of the 1990s to settle transactions in euros for Swiss financial institutions. In order to participate in TARGET, the RTGS system for the euro at that time, it was necessary to be located in the European Union. For that reason the Swiss financial community founded the SECB (Swiss Euro Clearing Bank) in Frankfurt to gain access to the euro market. The euroSIC system was launched in 1998. SIX SIC Ltd operates euroSIC on behalf of the SECB. Technically euroSIC is a clone of the SIC system, using the same technical platform and working according to the same rules.

The system manager of euroSIC is the SECB. In that function the SECB provides sight deposit accounts for participants, steers the euro liquidity in the system and performs beginning- and end-of-day operations.

Because of its legal residence in Frankfurt, the SECB is subject to supervision by BaFin, the German Federal Financial Supervisory Authority, and is overseen by the Deutsche Bundesbank. However, since euroSIC is a system of the Swiss financial centre and with a majority of Swiss participants, it also falls under the scope of the SNB's oversight. However, as euroSIC is not qualified as important for the Swiss financial system it is not subject to meeting the minimum requirements as stipulated in the National Bank Ordinance.

### 3.4 Continuous Linked Settlement

CLS is an international payment system which was launched in September 2002 for the settlement of foreign exchange transactions. It was designed to eliminate the settlement risk inherent in the conventional settlement mechanism for foreign exchange transactions. CLS is managed by the New-York based CLS Bank<sup>64</sup> and has access to all large-value payment systems of the 17 settlement currencies and has an account with the respective central banks, including a settlement account with SIC.<sup>65</sup>

---

<sup>64</sup> A bank authorised under the Edge Act as an "Edge Act corporation".

<sup>65</sup> As of 2010 the following 17 currencies are settled in CLS: Swiss franc, US dollar, pound sterling, Japanese yen, Canadian dollar, Australian dollar, euro, Danish krone, Norwegian krone, Singapore dollar, Swedish

CLS is able to settle foreign exchange transactions on the basis of a payment-versus-payment mechanism and, therefore, to eliminate settlement risk. Consequently, it makes a significant contribution to the stability of the global financial system. The Swiss franc was one of the currencies settled in CLS from the very start. Together with the other central banks of issue the SNB participates in a cooperative oversight group under the lead of the Federal Reserve Bank of New York.<sup>66</sup>

### **3.5 Retail payment systems**

Three former interbank systems for clearing or netting of retail payments have been closed down in the last decade due to a decrease in demand and concurrent technological improvement that made these services obsolete. Previously individual systems used to exist for the clearing of data carrier applications and for the clearing of direct debits across accounts at different banks. Nowadays these payments settle individually in SIC. As a result SIC has experienced an increase in the volume of transactions and, from that perspective, proves to be more than ever a settlement system for retail payments. Similarly, the former cheque clearing system closed at the end of 2004 as a consequence of decreasing use of cheques in Switzerland. Banks now settle interbank obligations from cheque use bilaterally.

However, there are two dominant firms in providing services in the retail payments arena. As mentioned in Section 1.3.1 above, for historical reasons PostFinance has always played an important role in the Swiss retail payments area, offering a wide range of retail payment instruments. SIX Card Solutions, a company belonging to SIX Group, is dominant in the processing of card payments. Interbank claims arising from processed card payments are debited by SIX Card Solutions from the SIC account of the respective issuing bank and credited to the respective retailer.

## **4. Systems for post-trade processing, clearing and securities settlement**

### **4.1 General overview**

Securities traded on SIX Swiss Exchange include Swiss-issued and foreign equities, various bonds as well as investment funds, exchange-traded funds (ETFs) and exchange-traded structured funds. Off-order-book trades that are not concluded via the order book of SIX Swiss Exchange are reported to the Exchange ex ante. Increasingly, Swiss-issued shares are also traded on alternative platforms abroad, for instance Chi-X, Turquoise, NYSE Euronext and BATS Europe. The BX Berne eXchange has established itself as a niche exchange for trading shares of small regional companies. A wide variety of derivatives can be traded on the Eurex Exchanges and Scoach platforms. Eurex Exchanges is used for trading the exchange's own-issued derivatives on shares, share indices, interest rates, loans and volatility. Among others, the product range covers derivatives based on Swiss underlying assets. Scoach specialises in structured products issued by banks and other financial intermediaries. Repo transactions in Swiss francs can be conducted on the Eurex Repo trading platform.

---

krona, Hong Kong dollar, Korean won, New Zealand dollar, South African rand, Israeli shekel and Mexican peso.

<sup>66</sup> For more detailed information on CLS, see the corresponding chapter in the second volume of this publication.

SIX x-clear Ltd is the only Swiss-domiciled central counterparty. It currently offers clearing services for equities and ETFs traded on SIX Swiss Exchange, on the London Stock Exchange and on multilateral trading facilities such as UBS MTF and Equiduct. Under certain circumstances, x-clear also acts as CCP for off-order-book trades that are concluded outside the central order book of SIX Swiss Exchange. The financial instruments traded on SIX Swiss Exchange can also be cleared through the UK-domiciled LCH.Clearnet Ltd. Eurex Clearing Ltd, which is incorporated in Germany, acts among other things as a CCP for derivatives based on Swiss underlying assets traded on Eurex Exchanges.

Many financial instruments, including most of the equities, bonds and ETFs issued under Swiss law as well as the derivatives traded in Scoach's Swiss market segment, are held in custody by the CSD SIX SIS Ltd. Transfer of these instruments takes place in SECOM, the securities settlement system operated by SIX SIS Ltd.

There are no systems in Switzerland that provide only trade confirmation services, nor are there any trade repositories as of the end of 2010.

## 4.2 Central counterparties and clearing systems

### 4.2.1 SIX x-clear Ltd

#### *Legal and Institutional framework*

The most important Swiss legal provisions that are relevant for the CCP clearing services of SIX x-clear Ltd (x-clear) are the Federal Intermediated Securities Act (FISA), the Code of Obligations, the Banking Act and the Swiss Private International Law Act. The custody of certified and uncertified securities by custodians and the settlement of securities transactions is governed by the FISA, which came into force in January 2010. In particular, this Act governs the transfer of, or creation of, a security interest in intermediated securities and realisation of the collateral, and protects the rights of account holders in general, as well as in the case of the custodian's winding-up. Where x-clear's domestic participant becomes the subject of insolvency proceedings, its rights and obligations are primarily addressed under a special insolvency regime (Banking Act and related ordinances). Finality issues are governed by the Banking Act and the FISA by limiting the effects of insolvency measures on transfer instructions given to payment and securities settlement systems and thus protecting the finality of a transfer in the event of a system participant's insolvency.

Due to the cross-border nature of x-clear's services, legislation in other countries is also relevant. Conflict of laws issues are governed by the Swiss Private International Law Act and the respective international treaties (eg the Hague Securities Convention, the Lugano Convention).<sup>67</sup>

x-clear is a wholly owned subsidiary of SIX Group Ltd (for a description of SIX Group's governance, see Section 1.3.3). x-clear's Board of Directors is responsible for x-clear's overall management and consists of three members that are currently drawn from the members of SIX Group Board. The members of the Board of Directors of x-clear are appointed for a term of three years.

x-clear is licensed as a bank and supervised by FINMA. The SNB designated x-clear as important for the stability of the Swiss financial system. Therefore, x-clear is subject to the

---

<sup>67</sup> The Convention on the Law Applicable to Certain Rights in Respect of Securities Held with an Intermediary, signed by Switzerland and the United States on 5 July 2006, and the Convention of 16 September 1988 on Jurisdiction and the Enforcement of Judgments in Civil and Commercial Matters, respectively.

SNB's minimum requirements for systemically important payment and securities settlement systems. Further, x-clear has been granted the status of Recognised Overseas Clearing House (ROCH) by the UK Financial Services Authority. The Swiss and UK authorities coordinate their supervisory and oversight activities based on a Memorandum of Understanding.

x-clear's rules and regulations consist of the General Terms and Conditions of Business (GTCB) as well as exchange-specific GTCB. They define among other things membership and suspension criteria, default procedures, settlement procedures, and margin and default fund requirements. The rules and regulations are governed by the law that is applicable to the corresponding exchange: Swiss law in the case of SIX Swiss Exchange and English law for the London Stock Exchange (LSE). In the case of an MTF, independent of the country where it is based, its rules and regulations are governed by English law. In addition, each member signs contracts for pledging collateral to x-clear to cover margin and default fund requirements. All pledge contracts are governed by Swiss law irrespective of the location of the exchange.

In 2006, x-clear signed the European Code of Conduct for Clearing and Settlement. In this self-regulatory agreement, European trading platforms, CCPs, CSDs and settlement institutions agree to grant reciprocal access to their services and create transparency with regard to their terms and conditions. The objective is to facilitate effective competition with regard to the trading, clearing and settlement of equities.

### *Participation*

Banks and securities dealers from Switzerland and abroad that are subject to adequate regulation and supervision may become members of x-clear. In addition, they must fulfil certain technical and operational requirements. There are two types of membership in x-clear. Members are either Individual Clearing Members (ICMs) or General Clearing Members (GCMs). An ICM may only settle its own transactions via x-clear, whereas a GCM can also settle transactions for other stock exchange participants which are not members of x-clear (Non-Clearing Members, NCMs). At the end of 2009, x-clear had 74 members (of which 19 were foreign clearing members): out of these 74 members, 13 were GCMs (providing access to 45 NCMs) and 61 were ICMs.

### *Types of transactions*

x-clear acts as a CCP for transactions in Swiss, UK and other foreign equities, ETFs and Swiss bonds traded on the SIX Swiss Exchange, LSE and MTFs such as UBS MTF and Equiduct. Under certain circumstances, x-clear also provides CCP clearing for transactions on SIX Swiss Exchange which are concluded outside the central order book (off-order-book trades).

### *Operation of the system*

x-clear provides CCP clearing through an open offer for all its clearing members that execute a buy or sell order with clearing-eligible securities. In so doing, x-clear becomes the buyer to every seller and the seller to every buyer. Thus, the two trading partners do not have any obligations towards each other but both enter into a contract with x-clear.

Between the execution of buy and sell orders and the settlement of all obligations (which is typically three days later), x-clear is exposed to counterparty risk. Members can optionally reduce settlement instructions by netting their trades per ISIN. x-clear initiates settlement of cleared transactions on the settlement day through its account relationships with SIX SIS Ltd, which is also a subsidiary of SIX Group Ltd. If a member fails to deliver the securities on the day of settlement, x-clear may initiate a buy-in or securities borrowing process. A late settlement fee is applied for trades conducted at the SIX Swiss Exchange. In any case, the selling x-clear member will be liable for any third-party cost.

For the purpose of transferring margins, x-clear opens collateral accounts (cash and securities) for each of its members at SIX SIS Ltd in the name of x-clear. Cash transfers resulting from margin calls of x-clear are executed through different settlement channels: Swiss franc cash transfers to fulfil margin calls can be executed in SIC (in central bank money) or via cash accounts at SIX SIS Ltd. Cash transfers in pounds sterling and euros to fulfil margin calls can be executed via accounts at SIX SIS Ltd or x-clear's authorised UK payment bank.

### *Risk management*

The participation requirements are described in x-clear's GTCB. The following trading members may be admitted as members of x-clear: Swiss and foreign banks, and Swiss and foreign securities dealers. Foreign participants must be subject to regulation and supervision similar to that in Switzerland. x-clear further requires both types of participants to have appropriate risk management procedures and an effective internal control system. Every participant must have an internal audit department that is independent of management.

Margins to be posted with x-clear are calculated on the basis of participants' trading positions of clearing-eligible securities. x-clear aims at setting margins high enough to be able to cover the expected loss incurred in the event of a member default in 99% of cases. Compliance with this requirement is verified by backtesting. Members must cover their margin requirements by depositing collateral (cash or securities). In the event of a shortfall, x-clear automatically triggers a margin call, which must be met in the form of money within 60 minutes.

The margins consist of initial margins and variation margins:

- Initial margins are calculated on the basis of the net position per security and its volatility (using a historical value-at-risk model). Opposing positions between different securities are partially netted and lead to a reduction in the initial margins. Initial margins are multiplied using a risk coefficient which takes into account the member's credit rating and large one-sided net positions. Initial margins are recalculated immediately after each purchase or sale made by the respective member.
- Variation margins cover the price movements of securities after completion of the trade and are usually calculated on an hourly basis.

In addition, x-clear has established a default fund, which – in combination with the margins – is sufficient to cover the loss that would occur under extreme but plausible market conditions if the largest and/or second largest member were to default. Compliance with this requirement is also tested on a regular basis using stress tests. Separate default funds have been established for SIX Swiss Exchange and LSE. For UBS MTF and Equiduct a common default fund is established. The contribution calculated for each member depends on the average sum of open positions over the past three months as well as the membership category (ICM or GCM).

If x-clear suffers a loss due to the default of a member, the following defence lines are applied in order of listing:

- x-clear draws on margins posted by the defaulting member based on its trading position in the affected stock exchange;
- the defaulting member's contributions to the default fund are deployed;
- after that, x-clear uses part of its available provisions, followed by the default fund (ie the contributions of other members);
- in a further step, the surviving members are obliged to replenish the default fund;



- the last financial resources to be used to cover a loss from a default are the remaining provisions, the capital stock and the reserves of x-clear.

#### *Links to other systems*

x-clear provides clearing services for all clearing-eligible securities that are traded on the SIX Swiss Exchange or LSE. It has close links with SIX SIS Ltd, which operates all collateral accounts and manages the settlement process on behalf of x-clear.

x-clear and LCH.Clearnet Ltd have an inter-CCP link in place to serve SIX Swiss Exchange and LSE, for which both act as a CCP (competitive clearing). Their relationship is governed by a Master Clearing Link agreement that establishes a peer-to-peer structure in which both act as “Cooperating Clearing Houses” in relation to the clearing of transactions where one clearing member uses x-clear and the other clearing member uses LCH.Clearnet Ltd as its CCP. The Master Clearing Link agreement states that both parties mutually recognise their risk management models. Both CCPs provide margins to each other to cover their mutual exposures based on the inter-CCP trade flow.

#### *Pricing*

x-clear’s fee schedule is based on the credit rating of the member and the monthly transaction volume of the participant’s transactions cleared by x-clear.

#### *Major ongoing future projects*

x-clear plans an expansion of its clearing services to foreign cash equity markets as well as other financial instruments (eg markets in securities borrowing and lending as well as carbon emission permits). In accordance with these plans, x-clear is in talks with various CCPs for setting up interoperability arrangements.

### **4.2.2 Eurex Clearing Ltd**

Eurex is owned in equal parts by Deutsche Börse Ltd and SIX Swiss Exchange. It operates Eurex Clearing Ltd (Eurex Clearing), Eurex Exchanges and the trading platforms Eurex Bonds and Eurex Repo.

Eurex Clearing is incorporated in Germany and licensed as a credit institution under the supervision of BaFin pursuant to the German Banking Act. The Deutsche Bundesbank cooperates and coordinates with BaFin in the supervision and oversight of Eurex Clearing. The UK Financial Services Authority has granted Eurex Clearing the status of Recognised Overseas Clearing House in the United Kingdom. The SNB designates certain functions of Eurex Clearing as important for the stability of the Swiss financial system. This relates to the clearing of derivatives denominated in Swiss francs or based on Swiss underlying assets that are traded on Eurex Exchanges. To this end the Swiss and German authorities are currently establishing a Memorandum of Understanding for the coordination of and cooperation in the supervision and oversight of Eurex Clearing.

For a detailed description of Eurex Clearing, see the chapter on Germany in the second volume of this publication.

### **4.2.3 LCH.Clearnet Ltd**

LCH.Clearnet Ltd (LCH) is a wholly owned subsidiary of LCH.Clearnet Group Ltd. The majority shareholder of the group are its users followed by minority holdings of diverse exchanges.

It is regulated by the UK Financial Services Authority as a ROCH under the Financial Services and Markets Act 2000. It is also licensed as a Derivatives Clearing Organization in the USA and subject to Commodity Futures Trading Commission rules and the US

Commodity Exchange Act. It holds temporary exemptive relief from the U.S. Securities and Exchange Commission to clear Credit Default Swap Indices in the U.S. The SNB designates certain functions of LCH to be important for the stability of the Swiss financial system. This entails the clearing of equities at the SIX Swiss Exchange. To this end the Swiss and UK authorities have established a Memorandum of Understanding for the coordination and cooperation in the supervision and oversight of LCH.

For a detailed description of LCH, see the UK chapter in the second volume of this publication.

### **4.3 Securities settlement systems**

#### **4.3.1 SIX SIS Ltd**

##### *Legal and Institutional framework*

The most important Swiss legal provisions that are relevant for the custody and settlement services of SIX SIS Ltd (SIS) are the FISA, the Debt Enforcement and Bankruptcy Act, the Code of Obligations, the Banking Act and the Private International Law Act. The custody of certified and uncertified securities by custodians and the settlement of securities transactions is governed by the FISA, which came into force in January 2010. In particular, this Act governs the transfer of, or creation of, a security interest in intermediated securities and realisation of the collateral, and protects the rights of account holders in general, as well as in the case of the custodian's winding-up. Where SIS's participant becomes the subject of insolvency proceedings, its rights and obligations are addressed under insolvency laws, ie the Swiss Debt Enforcement and Bankruptcy Act; where a participant operates under a bank (or securities dealer) licence, a special insolvency regime applies (Banking Act and related ordinances). Finality issues are governed by the Banking Act and the FISA by limiting the effects of insolvency measures on transfer instructions given to payment and securities settlement systems and thus protecting the finality of a transfer in the event of a system participant's insolvency.

Due to the cross-border nature of SIS's services, legislation in other countries is also relevant. Conflict of laws issues are governed by the Swiss Private International Law Act and the respective international treaties (eg the Hague Securities Convention, the Lugano Convention).<sup>68</sup>

SIS is a wholly owned subsidiary of SIX Group Ltd (for a description of SIX Group's governance, see Section 1.3.3). SIS's Board of Directors is responsible for SIS's overall management and consists of three members who are currently drawn from the members of SIX Group Board of Directors. The members of the Board of Directors of SIS are appointed for a term of three years.

SIS is a bank supervised by FINMA. The SNB considers SIS to be important for the stability of the Swiss financial system. Therefore, SIS is subject to the SNB's minimum requirements for systemically important payment and securities settlement systems.

SIS's basic rules and regulations consist of the General Terms and Conditions, the Service Contract and the Market Guide. They define among other things membership and suspension criteria, settlement procedures, management of custody and money accounts, and finality of settlement. Additional agreements cover products and services that are not

---

<sup>68</sup> See footnote 68.

covered by the basic rules and regulations (eg repo trading, securities lending and borrowing).

In 2006, SIS signed the European Code of Conduct for Clearing and Settlement. In this self-regulatory agreement, European trading platforms, CCPs, CSDs and settlement institutions agree to grant reciprocal access to their services and create transparency with regard to their terms and conditions. The objective is to facilitate effective competition with regard to the trading, clearing and settlement of equities.

### *Participation*

Banks and securities dealers from Switzerland and abroad that are subject to adequate regulation and supervision may become members of SIS. In addition, some stock exchanges and trading platforms, clearing houses, PostFinance, the Swiss Old Age and Survivors' Insurance Fund (AHV/AVS), the SNB and some insurance companies participate in SIS. In total, SIS has around 400 members. A participant must fulfil a number of requirements, including the demonstration of adequate regulation as well as adherence to the contractual framework setting out the rights and obligations of participation.

### *Types of transactions*

SIS acts as the CSD and settlement institution for the following Swiss securities: equities, government and private sector bonds, money market instruments, ETFs, conventional investment funds, structured products, warrants and other derivatives. Apart from providing custody and settlement for Swiss securities, SIS acts as global custodian and offers its participants access to custody and settlement in over 50 foreign financial markets. At the end of 2009, the value of securities held at SIS was CHF 2.8 trillion. In addition, SIS provides ancillary services such as securities lending and borrowing, tri-party repo or payment and cash management services.

### *Operation of the system*

SIS operates the securities settlement system SECOM, which operates nearly 24 hours on bank working days. It provides custody and settlement of tradable financial instruments. Depending on the instrument, the transactions are transmitted to SECOM either from a trading platform, from CCPs or from the trading parties themselves (or their settlement banks). Under certain circumstances, these settlement orders may already have been matched; other instruments (such as, for example, over-the-counter instruments) are matched in SECOM. All SIS participants are linked to SECOM via an online interface, which can be set up either via a computer-to-computer connection or by using SIS's own webMAX User Device. Access is also possible via SIS Web Services, a browser-based user interface.

On the settlement date, the transactions are settled by means of a delivery-versus-payment (DVP) mechanism. **Swiss financial instruments** are transferred in SECOM, while the related payment is made simultaneously, either through the SIC system or through the SIS money accounts in SECOM. The latter route is taken if neither trading party is a SIC participant. If only one of the trading parties is a SIC participant, SIS will act as correspondent for the other trading party and provide the connection to SIC through its own SIC account. The DVP mechanism ensures that the payment takes place if – and only if – the financial instruments are transferred. To this end, SECOM begins by reserving the appropriate financial instruments in the seller's custody account and generates a payment instruction to SIC, or to the internal payment system in SECOM. SIC (or SECOM) checks whether the purchaser has sufficient funds on account. If not, the payment instruction is held pending in a queue. As soon as sufficient funds are available, the payment is released and a message to SECOM ensures that the financial instruments that had been reserved are irrevocably and unconditionally transferred from the seller to the purchaser.

For settlement of **foreign financial instruments** SECOM uses the link to the foreign ultimate depository that may be direct, or indirect via a local custodian. In the case of a direct link, SIS is able to offer its customers custody and settlement of the foreign financial instruments by holding an omnibus account with the foreign ultimate depository. However, in some cases, a direct link is not possible, either for regulatory reasons, or because it is excessively costly, or because it is inopportune in view of the restricted array of services provided by the ultimate depository. In such cases, SIS uses a custodian located in the foreign market – typically a local bank – in order to secure access to the foreign ultimate depository. Depending on the set up, either the local custodian will be responsible for the settlement of both the funds leg and the securities leg of a trade, or SIS will use two different institutions. Situations where the funds leg of a trade is to be settled in euros constitute a special case. Such transactions can be settled through euro accounts held in SECOM, via SIS correspondents in the euro area, or through the link between SECOM and euroSIC. If both counterparties hold the foreign financial instrument in custody with SECOM, settlement can be internalised. In practice, this means that the securities leg and the funds leg of a trade can be settled respectively in the counterparties' own custody accounts and the foreign currency accounts held in SECOM. In the last few years, SECOM's internalisation rate in international business has been almost 30%.

### *Risk management*

SIS has taken various measures to reduce and, where possible, eliminate the risks in connection with custody and settlement – both for its participants and for itself. In the settlement and custody of **Swiss financial instruments** SIS acts as agent only and facilitates settlement but is not itself a counterparty and therefore does not bear any credit risks. The irrevocable settlement of transactions according to the DVP principle eliminates principal risks for its participants. Custody risks are reduced for the participants due to legal protection of the rights of account holders in case SIS becomes subject to insolvency proceedings. Participants' liquidity risks are reduced owing to facilities available for obtaining securities (securities lending and borrowing) and funds (SIS current account advance facilities).

For the custody and settlement of **foreign financial instruments** SIS bears settlement bank risks in case of a default of the foreign currency correspondent.<sup>69</sup> SIS manages this risk by requiring correspondent banks to fulfil specific requirements set by SIS and by limiting the size of overnight cash positions. The principal risks for its participants are managed through settlement according to the DVP principle. SIS holds foreign securities in custody with custodians in the name and at the risk of its participants. SIS participants' custody risks are reduced through requirements that foreign custodians are obliged to meet and through daily reconciliation of SIS's own records with its holdings of securities in custody with foreign CSDs. Participants' liquidity risks are reduced owing to facilities available for obtaining funds (such as SIS current account advance facilities in foreign currencies). Credit risks related to short-term exposures of SIS towards its participants are managed via limits and collateral requirements.

---

<sup>69</sup> The financial institution that settles the funds leg of a foreign financial instrument transaction for SIS and its participants is described as a foreign currency correspondent. Depending on the country and currency in question, this institution may be a central depository or a bank.

### *Links to other systems*

SIS offers direct links to other international central securities depositories (ICSDs) and CSDs. These currently comprise the following institutions:

- Clearstream Banking, Luxembourg and Frankfurt
- Euroclear, Brussels
- Euroclear Netherlands
- Euroclear France
- Euroclear UK & Ireland Limited, London
- Monte Titoli, Milan
- Oesterreichische Kontrollbank AG, Vienna (OeKB)
- DTCC, New York (not automated, only in use for 2 ISINs)
- Keler, Budapest

SIS is a founding member of Link Up Markets, which facilitates the interoperability between (I)CSDs for cross-border securities custody and settlement. Apart from SIS, seven other CSDs are active in this network: Clearstream Banking Frankfurt, Cyprus Stock Exchange, Hellenic Exchanges S.A., IBERCLEAR, Oesterreichische Kontrollbank AG, VP SECURITIES (Denmark) and VP LUX.

Furthermore, SIS has a network of correspondents in all major markets around the globe, allowing it to provide access to over 40 foreign markets through indirect links.

### *Pricing*

SIS publishes the prices of its services on its website displaying fee schedules for settlement (in-house and cross-border) and custody (Switzerland and cross-border) as well as pricing models for compensations and new issues.

### *Major ongoing and future projects*

Based on the recent developments in the clearing and settlement landscape in the European Union (eg Target2-Securities), SIS is evaluating the implications for its services and potential need for action.

## **4.4 The use of the securities infrastructure by the Swiss National Bank**

The SNB makes intense use of the securities infrastructure described above. The Eurex Repo platform, which was introduced in 1998, is used by the SNB for its monetary policy operations. Auctions are typically conducted on a daily basis. The custody and settlement of the securities are performed by SIS while the related payment is made simultaneously through SIC. Since October 1999, the SNB has also offered intraday repos that are settled through these infrastructures. Furthermore, the issuance of SNB's interest-bearing debt certificates (SNB Bills) as well as the issuance of money market debt register claims and bonds on behalf of the Swiss Confederation take place through the Swiss securities infrastructure described above.

In addition, the SNB relies on the services provided by SIS for its other business activities (eg custody services for asset management).