

UNIVERSITY OF PADUA  
FACULTY OF ENGINEERING  
MASTER'S DEGREE IN ENERGETIC ENGINEERING

---



**HYDRAULIC BALANCING AND COMPARISON BETWEEN FAN  
COIL AND UNDERFLOOR HEATING SYSTEMS**

Supervisor: Prof. Michele De Carli

Author: Daniele Bonvicini

Co-Supervisor: Dr. Hámori Sandor

Mat. 1058665

A.Y. 2014/2015







## Table of Contents

1.	SUMMARY .....	10
2.	INTRODUCTION ABOUT FLUID MECHANICS .....	10
2.1.	Newtonian and Non-Newtonian Fluids .....	10
2.2.	Main properties of fluids .....	12
2.2.1.	Density .....	12
2.2.2.	Specific weight .....	12
2.2.3.	Specific gravity .....	13
2.2.4.	Vapor pressure .....	13
2.3.	Fluid's Flows.....	13
2.4.	The Bernoulli Equation .....	15
2.5.	Fluid's Losses .....	17
2.5.1.	Major Losses .....	18
2.5.2.	Minor Losses.....	19
3.	VALVES.....	25
3.1.	Valve's characteristic.....	26
3.1.1.	The globe valve .....	28
3.1.2.	The equal percentage valve.....	29
3.2.	Flow coefficient .....	33
3.3.	Authority of a valve .....	33
4.	PUMPS .....	37
4.1.	Pump curve.....	37
4.1.1.	Efficiency curve.....	40
4.1.2.	Net Positive Suction Head (NPSH) .....	41
4.2.	Cavitation.....	42
4.3.	Pumps in systems .....	42
4.3.1.	Pumps arranged in series or in parallel .....	44
4.3.2.	Resistance connected in series or parallel.....	44
4.3.3.	Open and closed systems .....	45
4.4.	Regulation of pumps.....	47
4.4.1.	Throttle regulation.....	47
4.4.2.	Regulation with bypass valve .....	48
4.4.3.	Regulation by speed variation .....	49
5.	HYDRAULIC BALANCING .....	50
5.1.	Fundamental concepts underlying balancing.....	50
5.1.1.	The effect of flow rate on heat output.....	50
5.1.2.	Each crossover affects other crossovers.....	53

5.1.3. Direct vs reverse return piping .....	53
5.2. Types of balancing devices .....	55
5.2.1. Balancing valves.....	55
5.2.1.1. Dynamic balancing valves: autoflow .....	56
5.2.1.2. Static balancing valve.....	57
5.2.1.3. Differential pressure control valves.....	59
5.2.2. Hydraulic separator .....	60
6. PRACTICAL EXAMPLE OF HYDRAULIC BALANCING .....	64
6.1. The system.....	64
6.2. Balancing the system.....	64
6.3. The unbalanced system .....	70
7. UNDERFLOOR HEATING SYSTEM .....	74
7.1. Design the underfloor heating system .....	74
8. COMPARISON BETWEEN FAN COIL SYSTEM AND UNDERFLOOR HEATING SYSTEM.....	78
9. CONCLUSION .....	79
Bibliography.....	80

### List of Pictures

Figure 1 Fluid between two plates with a force F applied on the top plate .....	10
Figure 2 Shearing stress versus rate of shearing strain for non-newtonian fluid .....	12
Figure 3 Velocity trend for an ideal fluid flowing in a pipe.....	13
Figure 4 Velocity trend for a real fluid flowing in a pipe.....	14
Figure 5 Representation of the reynolds dye experiment.....	14
Figure 6 Turbulent, transient and laminar flow in a pipe .....	15
Figure 7 EL and HGL in a pipe .....	17
Figure 8 Use of the HGL to define the pressure in the pipe .....	17
Figure 9 Moody's chart .....	19
Figure 10 Sudden enlargement in a pipe.....	20
Figure 11 Sudden constriction in a pipe .....	20
Figure 12 Different types of valves: a) plug and seat three-port mixing valve, .....	25
Figure 13 diverting and mixing valves.....	26
Figure 14 Three-port terminology, showing the name of the ports.....	26
Figure 15 Radiator heat output as function of flow rate, with temperature as parameter .....	27
Figure 16 Representation of valve's characteristics .....	27
Figure 17 the shape of the plug determines the valve characteristic.....	28

Figure 18 schematic representation of a globe valve .....	28
Figure 19 quick opening characteristic .....	29
Figure 20 Theoretical (dotted line) and practical (solid line) .....	30
Figure 21 equal percentage characteristic .....	31
Figure 22 heat output vs stem position relationship with an equal percentage valve.....	31
Figure 23 two different ways to obtain an equal percentage characteristic.....	32
Figure 24 sequence of stem lift in equal percentage valves.....	32
Figure 25 pressure drop-flow diagram with $k_v$ as parameter .....	33
Figure 26 flow through a control valve as function of spindle lift, showing the effect of valve authority .....	34
Figure 27 valve authority diagrams showing three-port valves and pressure drop in the circuit .....	34
Figure 28 A three-port valve with balancing valve in the bypass leg .....	35
Figure 29 curves for symmetrical three-port valve selected for linear power output .....	35
Figure 30 curves for asymmetrical three-port valve selected for linear power output .....	36
Figure 31 schematic representation of a centrifugal pump .....	37
Figure 32 Schematic view of the fluid path inside a centrifugal pump.....	37
Figure 33 velocity diagram at the inlet and exit of a centrifugal pump.....	38
Figure 34 head-flowrate curve for a centrifugal pump showing the effects of losses .....	39
Figure 35 characteristic curve for different rotating velocities ( $n_1 > n_2 > n_3$ ).....	40
Figure 36 typical performance characteristic for a centrifugal pump .....	41
Figure 37 diagram showing $NPSH_R$ , efficiency, power and head curve of a pump.....	42
Figure 38 typical flow system .....	43
Figure 39 pump and system curves used to obtain the operating point for the system.....	43
Figure 40 parallel-connected pumps .....	44
Figure 41 series-connected pumps.....	44
Figure 42 resistances connected in series .....	45
Figure 43 resistances connected in parallel.....	45
Figure 44 system curve for a closed system .....	46
Figure 45 open system with positive geodetic lift .....	46
Figure 46 open system with negative geodetic lift.....	47
Figure 47 Pump regulation by throttle configuration .....	48
Figure 48 power saving with throttle regulation .....	48
Figure 49 pump regulation by bypass valve .....	48
Figure 50 the bypass valve does not provide a power saving .....	49
Figure 51 variable speed regulation .....	49
Figure 52 a typical system with a heat source, some crossovers and heating loads.....	51
Figure 53 effect of the flowrate on the heat output of a heat emitter .....	52

Figure 54 heat output vs flowrate through a heat emitter .....	52
Figure 55 Desirable systems should have differential pressure control.....	53
Figure 56 Undesirable systems do not have differential pressure control.....	53
Figure 57 Direct return system .....	54
Figure 58 Direct return system with balancing valves .....	54
Figure 59 Reverse return system .....	54
Figure 60 Reverse return piping for multiple panel radiators .....	55
Figure 61 autoflow balancing valve .....	56
Figure 62 mode of operation of an autoflow .....	57
Figure 63 mode of operation of a manual balancing valve .....	58
Figure 64 working principle of a flowmeter valve: setting the reference flowrate, let the spring lift to its maximum value and finally adjust the spring position the desired position .....	59
Figure 65 Working principle of a Dpcv.....	60
Figure 66 differential pressure control valve.....	60
Figure 67 system with a boiler and three circulating pumps.....	61
Figure 68 system with hydraulic separator.....	62
Figure 69 three possible working conditions of a hydraulic separator.....	62
Figure 70 model of the shopping center with his own heating system .....	64
Figure 71 technical diagram of pressure drop-flow rate .....	65
Figure 72 Flow rate modification.....	72
Figure 73 Heat output modification .....	73
Figure 74 pressure loss in PEX tube .....	75
Figure 75 Manifold pressure drops.....	76
Figure 76 sketch of the underfloor heating circuit piping system .....	77
Figure 77 manifold total pressure drops .....	77

#### **List of tables**

Table 1 Some typical value of minor losses .....	20
Table 2 Minor losses for different type of valves .....	21
Table 3 minor losses coefficients for pipe components .....	22
Table 4 minor losses coefficients for pipe fittings .....	23
Table 5 minor losses calculation .....	24
Table 6 flow rate calculation.....	65
Table 7 Major losses calculation, linear major pressure drop .....	66
Table 8 Major losses calculation, actual major pressure drop .....	67
Table 9 Minor losses calculation.....	68
Table 10 Total pressure drops calculation .....	69



Table 11 pressure drop between emitters and boiler .....	69
Table 12 balancing valves type and position .....	70
Table 13 pump characteristics with fan coil system .....	70
Table 14 results of unbalanced system on the flow rate .....	71
Table 15 results of unbalanced system on return temperature .....	72
Table 16 Underfloor heating system specific power .....	74
Table 17 supply and return temperature calculation .....	74
Table 18 manifold pressure drop calculation .....	76
Table 19 Pump characteristics with underfloor heating system .....	77
Table 20 load factor and working hours .....	78
Table 21 pumps electrical absorption .....	78



## 1. SUMMARY

The first goal of this thesis is to analyze the benefits obtained through a correct hydraulic balancing of a hydraulic heating system, and the problems caused by an incorrect balancing. This goal has been chosen because even today a large number of heating systems are installed and are operating without a correct balancing, especially in residential plants, therefore causing discomfort to the users.

The second part of the thesis is focused on the comparison between a fan coil heating system and an underfloor heating system. To do so have been taking into account parameters like the load factor and the electrical absorption of the pump used to circulate the heating fluid in the two systems.

Despite being a very simple procedure to pull off, the results show that the effects of an incorrect hydraulic balancing, like the modification in flow rate through the emitters and their heat output, highly affect the quality of the internal air and the health of the heating system.

## 2. INTRODUCTION ABOUT FLUID MECHANICS

Fluid mechanics is that discipline that is concerned with the behavior of fluids (gases and liquids) at rest or in movement. It covers a vast array of phenomena that occur in nature, in biology and also in engineering processes.

Fluids are widely used in all engineering fields: we can get energy from them, we can use them to transport energy from one place to another one and also we can use them to warm and cool down buildings.

Therefore it's extremely important to study the features and the behavior of the fluids, how they flow in a pipe, how they can transport energy e how they loss energy to the environment. Almost every engineering plant in the world use a fluid, thus we must know how to use them properly.

### 2.1. Newtonian and Non-Newtonian Fluids

All fluids can be divided in two main categories: Newtonian and non-Newtonian fluids. The difference between these two typologies of fluids stands on the behavior of their viscosity.

As we know the viscosity of a fluid is a parameter which evaluates a fluid's resistance to flow or, in other words, it is a measure of the fluid's internal resistance. To understand this let's consider a fluid placed between two wide parallel plates, as shown in figure 1. The bottom plate is rigidly fixed while the upper plate is free to move. If we apply a force  $F$  to the upper plate we will notice that it will move, after an initial transient motion, with velocity  $U$ .

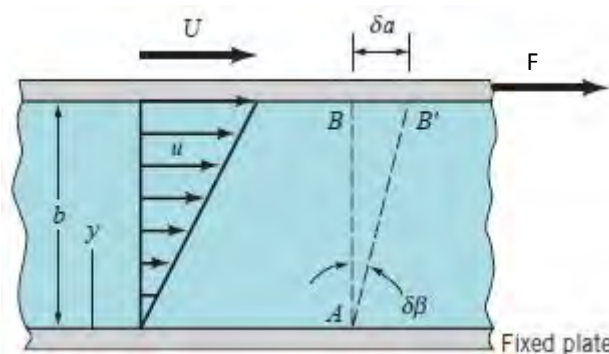

FIGURE 1 Fluid between two plates with a force  $F$  applied on the top plate

A closer look to the fluid between the plates would reveal that the fluid in contact with the upper plate is moving with velocity  $U$  while the fluid in contact with the bottom plate is motionless. Therefore we can say that there is a velocity gradient  $du/dy$  in the fluid between the plates.

Since we can write the velocity of the fluid in a certain point between the plates (considering a simple case) as

$$u(y) = U * \frac{y}{b}$$

we would find that the gradient is a constant

$$\frac{du}{dy} = \frac{U}{b}$$

In a small time increment  $dt$ , an imaginary vertical line AB in the fluid would rotate through an angle  $d\theta$  so that:

$$\tan d\theta \approx d\theta = \frac{da}{b}$$

and since

$$da = U * dt$$

it comes that

$$d\theta = \frac{U * dt}{b}$$

As we can see we can't relate  $d\theta$  only with  $U$  (and so  $F$ ) because it's a function of time too. Thus it's reasonable to consider not the shearing strain, but the rate of shearing strain (or rate of angular deformation)

$$\dot{\gamma} = \lim_{dt \rightarrow 0} \frac{d\theta}{dt}$$

which can be written as

$$\dot{\gamma} = \frac{U}{b} = \frac{du}{dy}$$

Experimental analysis proved that the rate of shearing strain is increased in direct proportion with the shearing stress  $\tau$  as

$$\tau \propto \dot{\gamma}$$

or

$$\tau \propto \frac{du}{dy}$$

For common fluids such as water, oil and air this relation can be written as

$$\tau = \mu \frac{du}{dy}$$

where the constant of proportionality is called absolute (or dynamic) viscosity. Fluids with a constant viscosity are called Newtonian fluids while fluids for which the shearing stress is not linearly related to the rate of shearing strain are called non-Newtonian fluids. A representation of both types of fluid is shown in figure 2.

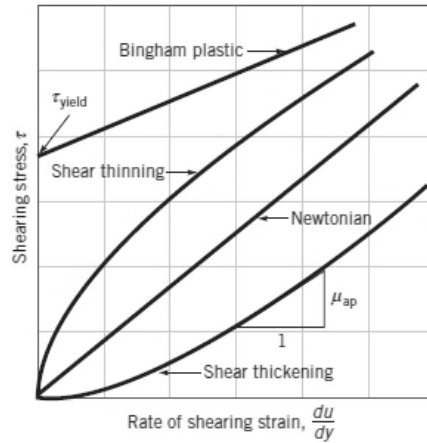

**FIGURE 2 Shearing stress versus rate of shearing strain for non-newtonian fluid**

In other words we can say that, in order to have  $U$  constant, for the second law of dynamics there must be a force  $F'$  between the fluid and the upper plate, that is

$$\bar{F} = -\bar{F}'$$

or, using scalar values

$$F = F'$$

Now, being  $A$  the surface of the moving plate, it can be experimentally proved that

$$F = F' \propto \frac{uA}{b}$$

The constant of proportionality is the dynamic viscosity of the fluid, so

$$F = F' = \mu \frac{uA}{b}$$

Using the International System (SI) the dynamic viscosity's unit of measure is  $\text{Kg/m}^2\text{s}$  but it can be used also the Poise ( $1 \text{ P} = 10^{-1}\text{Kg/ms}$ )

In this thesis, since the Newtonian fluids are easier to discuss and more common than the non-Newtonian, we will refer only to them.

## 2.2. Main properties of fluids

Apart from dynamic viscosity there are other properties of the fluids that are important to discuss about.

### 2.2.1. Density

The density of a fluid is defined as his mass per unit volume and its unit of measure is then  $\text{Kg/m}^3$

$$\rho = \frac{m}{V}$$

The value of density can vary between different types of fluids. For liquids its value varies very little with temperature and pressure variations while for gases it's the opposite.

The specific volume is the volume per unit mass and is therefore the reciprocal of the density

$$v = \frac{1}{\rho}$$

### 2.2.2. Specific weight

The specific weight of a fluid is defined as its weight per unit volume, so it can be written as

$$\gamma = \frac{mg}{v} = \rho g$$

and its unit of measure is  $\text{N/m}^3$ . As density is used to characterize the mass of a system, the specific weight is used to characterize the weight of the system.

### 2.2.3. Specific gravity

The specific gravity of a fluid is defined as the ratio of the density of the fluid and the density of the water at a fixed temperature (usually  $4^\circ\text{C}$ , so the density will be  $1000 \text{ Kg/m}^3$ )

$$SG = \frac{\rho}{\rho_{\text{H}_2\text{O}, 4^\circ\text{C}}}$$

### 2.2.4. Vapor pressure

The vapor pressure of a fluid is defined as the equilibrium pressure of a gas above its liquid (or solid). When in a container with fluid inside and a vacuum space above it the number of molecules evaporating is equal to the number entering the fluid the vapor is said to be saturated and the pressure exerts on the liquid surface is the vapor pressure.

Since the vapor pressure depends on the molecular activity, the vapor pressure of a specific fluid depends on temperature.

## 2.3. Fluid's Flows

It is possible, and useful, to categorize the type of flow that a fluid can have. If we look, for example, to a flowing river we will notice that the flow of the liquid is very complex to describe since the velocity varies from one point to another.

Under some circumstances the flow will not be as variable as this; in effect we can describe the flow of a liquid using these four categories:

- *Uniform flow*: if the velocity has the same magnitude and direction in every point in the fluid.
- *Non uniform flow*: if at a given instant the velocity is not the same in every point in the fluid.
- *Steady*: the steady flow is one in which the conditions (as velocity, pressure etc.) may change between two points but do not change in time.
- *Non steady*: if at any point in the fluid the conditions change in time the flow is called non-steady.

Speaking about real fluids we have to consider the viscosity's effects. In an ideal flow, as illustrated in figure 3, the velocity in a cross section of the pipe remain constant because there is no friction between the fluid and the wall of the pipe and between the particles of the fluid.

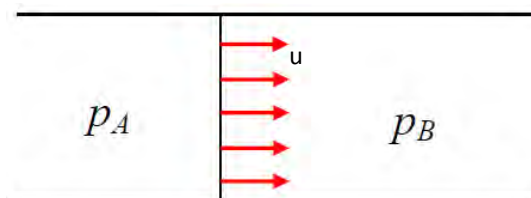

FIGURE 3 Velocity trend for an ideal fluid flowing in a pipe

The pressure before the considered cross section will be equal to the one after the same section, thus we can say that in an ideal case there is no need for a pressure difference to have flow.

On the other hand, in a real flow we know that the velocity of the fluid in proximity to the wall must be zero. Then we will have a non-linear velocity in the cross section, as we can see in figure 4.

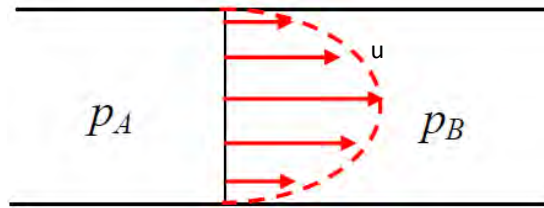

FIGURE 4 Velocity trend for a real fluid flowing in a pipe

In this case we have a difference of pressure between the liquid before and after the cross section, and we need this difference to have the flow. Due to the friction losses we will have that:

$$p_a > p_b$$

In a real situation we can distinguish three different kind of flow: turbulent, laminar and transitional.

To study these flows we can refer to the Reynolds' dye experiment, depicted in figure 5. Osborne Reynolds (1842-1912), a British scientist and mathematician, was the first to distinguish the differences between these flows injecting dye into a pipe in which water flowed due to gravity.

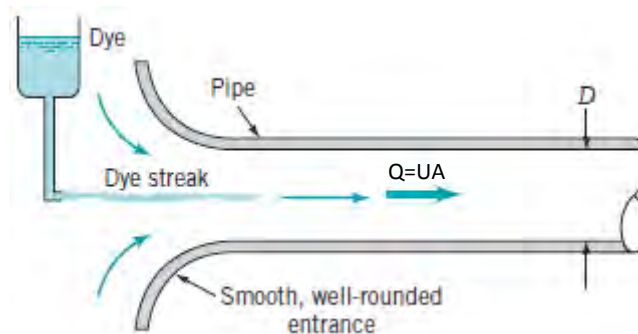

FIGURE 5 Representation of the Reynolds dye experiment

Reynolds observed that:

- For "small enough flow rates" the dye streak remained as well-defined as it flowed along.
- For "intermediate flow rates" the dye streak fluctuated in both time and space, and irregular burst of intermittent behavior appeared along the streak.
- For "large enough flow rates" the dye streak most immediately became blurred and spread across the whole pipe.

After many experiments Reynolds found that we can somehow predict the flow of a fluid using a dimensionless ratio, known as Reynolds number:

$$Re = \frac{\rho U D}{\mu}$$

where U is the average velocity in the pipe, and D is the diameter of the pipe. We can instantly notice that not only the velocity of the fluid influences the flow type, but also the shape of the pipe and the fluid's properties.

The distinction between the three different flows can be based on the value of the Reynolds number but we have to remember that the ranges for which laminar, turbulent and transient flow are obtained cannot be precisely given. For general engineering purpose we can assume that:

Turbulent flow:	Re>4000
Transient flow:	2100<Re<4000
Laminar flow:	Re<2100

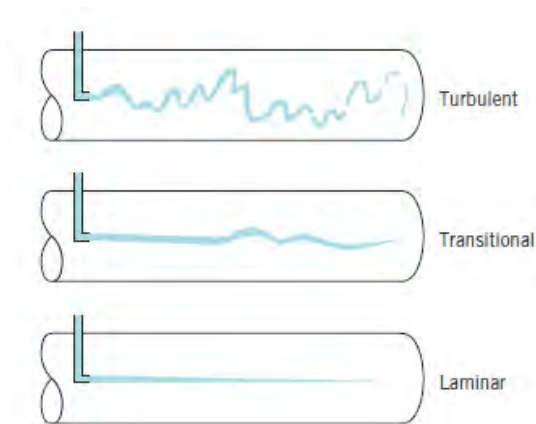

FIGURE 6 Turbulent, transient and laminar flow in a pipe

## 2.4. The Bernoulli Equation

One of the most important tools in fluid mechanics is definitely the Bernoulli equation.

Thanks to the energy conservation, when friction is negligible, we can affirm that the sum of kinetic and potential energy is constant.

$$\text{Kinetic energy: } \frac{1}{2}mu^2$$

$$\text{Potential energy: } mgy$$

Under some restrictions, such as:

- Flow is steady
- Density is constant (fluid is incompressible)
- Friction losses are negligible
- We refer to states at two points in the same streamline

we can write the Bernoulli equation, that is

$$p_1 + \frac{1}{2}\rho u_1^2 + \rho g y_1 = p_2 + \frac{1}{2}\rho u_2^2 + \rho g y_2$$

It's important to know that all the restrictions are impossible to satisfy at any instant in time but fortunately for many real situations where the conditions are approximately satisfied, the equation gives good results.

To explain this equation in a simple way we can imagine a pipe (which have different width and elevation between its beginning and its end) with a fluid inside which is flowing from a starting position to a final one. For the incompressibility of the fluid the volume of the entering fluid must be equal to the one of the outgoing fluid:

$$\Delta V = A_1 \Delta x_1 = A_2 \Delta x_2$$

Where A is the area of the entrance (and exit) of the pipe and  $\Delta x$  is the length cover by the fluid. The fluid mass is

$$\Delta m = \rho \Delta V$$

Due to the movement of the fluid the mass  $\Delta m$  of it in the period  $\Delta t$  has moved from the initial height  $y_1$  to  $y_2$  and its velocity has changed from  $u_1$  to  $u_2$ .

From point 1 to point 2 we have therefore a variation in kinetic and potential energy:



$$\Delta E_k = \frac{1}{2}(\Delta m)u_2^2 - \frac{1}{2}(\Delta m)u_1^2 = \frac{1}{2}\rho\Delta V(u_2^2 - u_1^2)$$

$$\Delta E_p = \Delta mgy_2 - \Delta mgy_1 = \rho\Delta Vg(y_2 - y_1)$$

The fluid before the section  $A_1$  executes a force  $F_1=p_1A_1$  (where  $p_1$  is the pressure on section  $A_1$ ) on the entering mass  $\Delta m$ . The result of this force is a work:

$$L_1 = F_1\Delta x_1 = p_1A_1\Delta x_1 = p_1\Delta V$$

Similarly, at the end of the pipe, there is a force  $F_2$  which produces a work as:

$$L_2 = -F_2\Delta x_2 = -p_2A_2\Delta x_2 = -p_2\Delta V$$

The total work produced by the two forces is then:

$$L_{tot} = L_1 + L_2 = p_1\Delta V - p_2\Delta V = (p_1 - p_2)\Delta V$$

From the kinetic energy theorem we can also say that:

$$L_{tot} = \Delta E_k + \Delta E_p$$

Merging the two expressions for  $L_{tot}$  the result we get is:

$$(p_1 - p_2)\Delta V = \frac{1}{2}\rho\Delta V(u_2^2 - u_1^2) + \rho\Delta Vg(y_2 - y_1)$$

Dividing all the terms per  $\Delta V$  and explicating all the terms with the subscript 1 we finally get the well-known expression of the Bernoulli equation:

$$p_1 + \frac{1}{2}\rho u_1^2 + \rho g y_1 = p_2 + \frac{1}{2}\rho u_2^2 + \rho g y_2$$

Or, in other words:

$$p + \frac{1}{2}\rho u^2 + \rho g y = \text{constant}$$

The terms  $p + \rho g y$ , since they're present even without flow, are called static pressure while the term  $\frac{1}{2}\rho u^2$  is called dynamic pressure.

A useful interpretation of the Bernoulli equation can be obtained through the use of the concepts of the *hydraulic grade line* (HGL) and the *energy line* (EL). Dividing all terms of the Bernoulli equation by the specific weight allows us to write the equation in a "height form":

$$\frac{p}{\gamma} + \frac{u^2}{2g} + y = \text{constant} = H$$

In this expression all the terms have the unit of a length and represent a certain head:  $\frac{p}{\gamma}$  is the pressure head,  $\frac{u^2}{2g}$  is the velocity head and  $y$  is the elevation head. The sum of these three terms is called total head  $H$ .

The energy line (EL) is a line that represents the total energy available to the fluid, which means that it's a geometrical representation of  $H$ .

The sum of the elevation and pressure head is often termed *piezometric head*. It allows us calculating the hydraulic grade line HGL as the difference between the energy line and the piezometric line.

Summarizing we have:

$$EL \equiv \frac{p}{\gamma} + \frac{u^2}{2g} + y = H$$

$$\text{Piezometric head} \equiv \frac{u^2}{2g} + y$$

$$HGL \equiv EL - \text{Piezometric head}$$

An illustration of these heads is shown in figure 7.

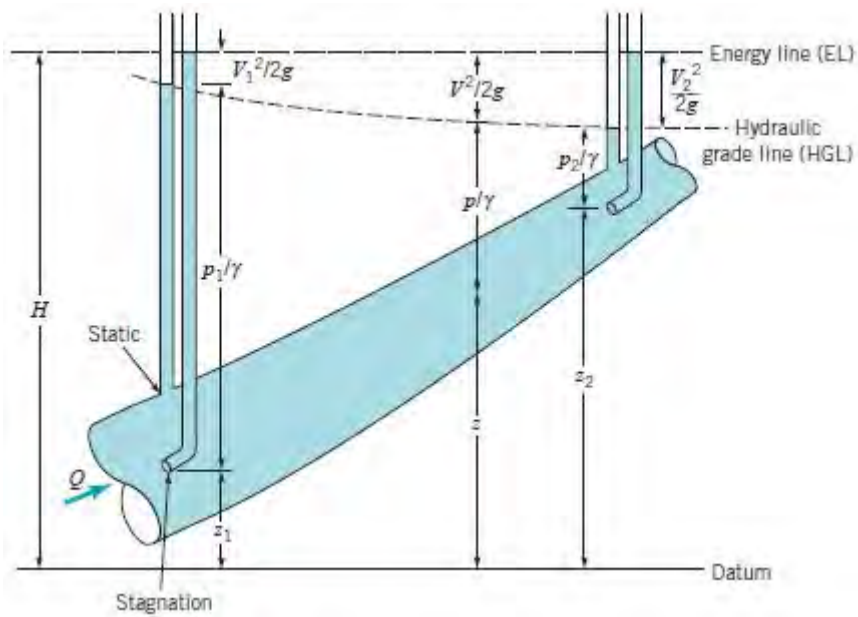

FIGURE 7 EL and HGL in a pipe

Using these heads is particularly useful when we have to analyze a pipe connected to a tank as the distance between the HGL and the pipe indicates the pressure inside the pipe. As we can see in figure 8 if the HGL is above the pipe the pressure inside the pipe will be positive (above atmospheric). If the HGL is under the pipe the pressure inside the pipe will be negative (under atmospheric).

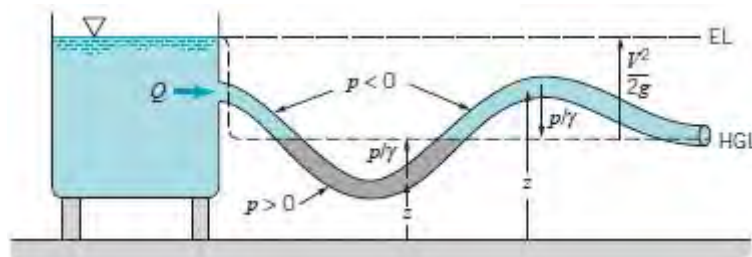

FIGURE 8 Use of the HGL to define the pressure in the pipe

## 2.5. Fluid's Losses

For an ideal fluid flowing in a pipe the energy line maintains constant through the pipe, but when we consider a real fluid this is not true due to the losses caused by the viscosity. This means that we have to calculate the so called head losses,  $h_L$ .

A typical pipe system usually consists in various lengths of straight pipes connected with other elements as valves and elbows. The overall head loss is the combination of the losses that occur in the straight pipes, the major losses  $h_{L,major}$ , and the head loss in the various elements, the minor losses  $h_{L,minor}$ :

$$h_L = h_{L,major} + h_{L,minor}$$

These losses have to be considered in the energy equation, which can be written as:

$$\frac{p_1}{\gamma} + \frac{u_1^2}{2g} + y_1 = \frac{p_2}{\gamma} + \frac{u_2^2}{2g} + y_2 + \sum h_s + \sum h_L$$

where  $h_s$  consist of all the addition and removal heads due to machines placed between section 1 and 2.

If the energy equation has to be written in terms of pressure, it will become:

$$p_1 + \rho \frac{u_1^2}{2} + \gamma y_1 = p_2 + \rho \frac{u_2^2}{2} + \gamma y_2 + \sum h_s + \sum h_L$$

Obviously the losses must now be written in terms of pressure, not in terms of high.

### 2.5.1. Major Losses

By means of a dimensional analysis<sup>1</sup> is possible to find a semi-empirical way to calculate the pressure drop in a pipe where a fluid is flowing as long as the flow is turbulent, fully developed and incompressible.

One of the most famous equations in this field is the *Darcy-Weisbach*, used for smooth pipes:

$$h_{L,major} = f \frac{L}{D} \frac{u^2}{2g}$$

where f is the Darcy friction factor and L and D are the length and diameter of the pipe. This loss is written in terms of height, so it must be used with the properly expression of the energy equation.

In a hydraulic balancing is however more useful to have the losses written in terms of pressure, that is:

$$h_{L,major} = f \frac{L}{D} \frac{\rho u^2}{2}$$

The dimensionless coefficient f is the Darcy friction coefficient. It can be proved that it's a function of the Reynolds number of the flow and the ratio between the pipe's diameter and the surface roughness:

$$f = F\left(Re, \frac{\varepsilon}{D}\right)$$

There are many equations we can use to solve the Darcy friction factor. Two of the most famous are the Colebrook and the Blasius.

The Colebrook equation is:

$$\frac{1}{\sqrt{f}} = -2 \log\left(\frac{\varepsilon/D}{3.7} + \frac{2.51}{Re\sqrt{f}}\right)$$

As we can see it's an implicit equation, thus to solve the friction factor f we will need to do some iterations.

A graphic representation of the Colebrook equation is the so called Moody chart, figure 9:

---

<sup>1</sup> Goodwill I.M., Sleigh P.A., *Fluid Flow in Pipes*, CIVE2400 Fluid Mechanics, January 2008, pp. 6-12

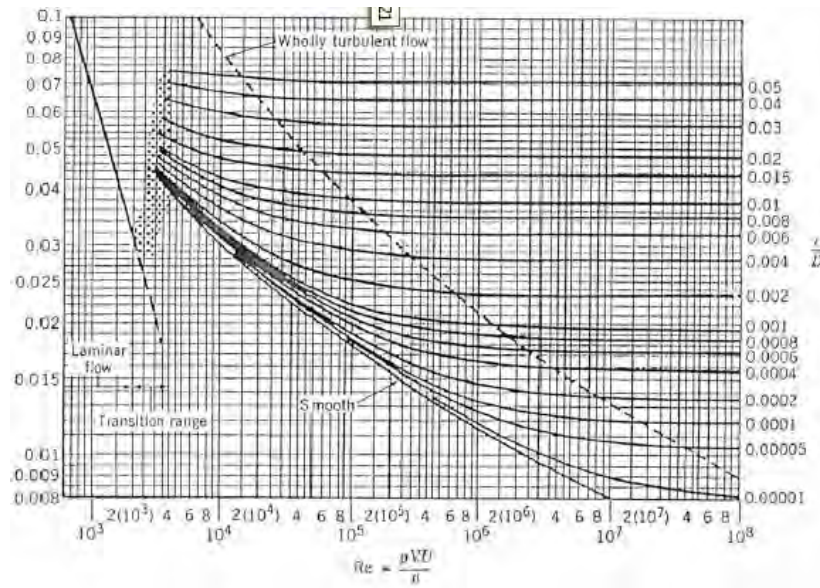

FIGURE 9 Moody's chart

The Blasius equation is simpler than the Colebrook's, since it does not have terms for relative roughness. Nevertheless this means that this equation can be used only on smooth pipes even if it's often used in rough pipes because of its simplicity:

$$f = \frac{0.316}{Re^{0.25}}$$

Under laminar flow it's been developed another equation to calculate  $h_{L,major}$ , called the Hagen-Poiseuille equation:

$$h_{L,major} = 32 \frac{\mu L u}{D^2 \gamma}$$

Comparing this equation with the Darcy's will let us find the equation for the friction factor in laminar flow:

$$f = \frac{64\mu}{\rho u D} = \frac{64}{Re}$$

In laminar flow there's no need for iterations since the friction factor is only a function of the Reynolds number.

### 2.5.2. Minor Losses

In addition to head losses due to friction there are always head losses in pipes due to bends, elbows, valves etc. If for long pipes their effect can be neglected, for short pipes they have to be taken in account.

A general formula for these kinds of losses is:

$$h_{L,minor} = k_L \frac{u^2}{2g}$$

where  $k_L$  is a constant which depends on the system's geometry.

Similarly to the major losses, it's useful to write the minor losses in terms of pressure:

$$h_{L,minor} = k_L \rho \frac{u^2}{2}$$

The value of  $k_L$  is, most of the time, obtained experimentally:

- Sudden Enlargement:

$$k_L = \left(1 - \frac{A_1}{A_2}\right)^2$$

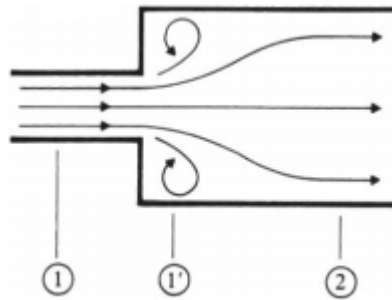

FIGURE 10 Sudden enlargement in a pipe

- Sudden contraction:

$$k_L = 0.44$$

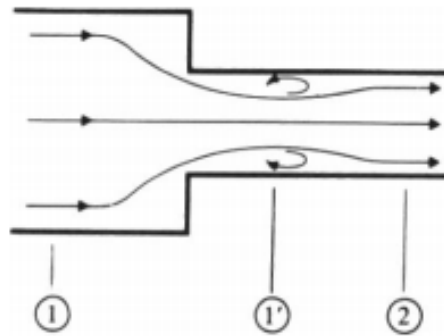

FIGURE 11 Sudden constriction in a pipe

- Other losses:

	$k_L$ value
	Practice
Bellmouth entry	0.10
Sharp entry	0.5
Sharp exit	0.5
90° bend	0.4
90° tees	
In-line flow	0.4
Branch to line	1.5
Gate valve	0.25
(open)	

TABLE 1 Some typical value of minor losses

In pipe systems one of the most important component are the valves. Losses through valves are written in a similar way to the other minor losses:

$$h_{L,minor} = k_L \rho \frac{u^2}{2}$$

Where  $k_L$  depends on the type and on the opening level of the valve, as it can be seen in the next picture:

Type	Equivalent Length in Pipe Diameters $L_{eq}/D$
Globe valve—fully open	340
Angle valve—fully open	150
Gate valve—fully open	8
— $\frac{3}{4}$ open	35
— $\frac{1}{2}$ open	160
— $\frac{1}{4}$ open	900
Check valve—swing type	100
Check valve—ball type	150
Butterfly valve—fully open, 50–200 mm (2–8 in.)	45
—250–350 mm (10–14 in.)	35
—400–600 mm (16–24 in.)	25
Foot valve—poppet disc type	420
Foot valve—hinged disc type	75
90° standard elbow	30
90° long radius elbow	20
90° street elbow	50
45° standard elbow	16
45° street elbow	26
Close return bend	50
Standard tee—with flow through run	20
—with flow through branch	60

TABLE 2 Minor losses for different type of valves

Minor losses through valves are often given as *equivalent length*. In this terminology the head losses through a valve is given as the length of a straight pipe that would produce the same losses as the component, that is (written in terms of pressure):

$$h_{L,minor} = k_L \rho \frac{u^2}{2} = f \frac{l_{eq}}{D} \rho \frac{u^2}{2}$$

$$l_{eq} = \frac{k_L}{f} D$$

A typical table will however report the value of the ratio  $l_{eq}/D$ , not the single value of the equivalent length.

This means that, in order to computing the minor losses caused by the presence of a valve in a pipe, the steps to follow are:

- Find the ratio  $l_{eq}/D$  for the valve in a table;
- Through the wall roughness and the diameter of the pipe, find the value of the friction factor in the Moody diagram;
- Compute  $k_L = f(l_{eq}, D)$ ;
- Compute  $h_{L,minor} = k_L \rho \frac{u^2}{2}$

Another way to evaluate the minor losses in a piping system is the one advised by Caleffi S.p.A.<sup>2</sup>. They offer two different tables to refer to (tables 3 and 4). In each table are shown coefficients relating to the flow resistance introduced by a fitting or particular pipe component basing on the pipe diameter (corners, tees, etc. ).

<sup>2</sup> <http://www.caleffi.com/italy/it/homepage>

















Diametro interno tubi in acciaio inox, rame e materiale plastico		8 ÷ 10 mm	18 ÷ 28 mm	30 ÷ 54 mm	> 54 mm	
Diametro tubi in acciaio		3/8" - 1/2"	3/4" - 1"	1 1/4" - 2"	> 2"	
Tipo di resistenza localizzata		Simbolo				
Curva stretta a 90°	$r/d = 1,5$		2,0	1,5	1,0	0,8
Curva normale a 90°	$r/d = 2,5$		1,5	1,0	0,5	0,4
Curva larga a 90°	$r/d > 3,5$		1,0	0,5	0,3	0,3
Curva stretta a U	$r/d = 1,5$		2,5	2,0	1,5	1,0
Curva normale a U	$r/d = 2,5$		2,0	1,5	0,8	0,5
Curva larga a U	$r/d > 3,5$		1,5	0,8	0,4	0,4
Allargamento			1,0			
Restringimento			0,5			
Diramazione semplice con T a squadra			1,0			
Confluenza semplice con T a squadra			1,0			
Diramazione doppia con T a squadra			3,0			
Confluenza doppia con T a squadra			3,0			
Diramazione semplice con angolo inclinato (45° - 60°)			0,5			
Confluenza semplice con angolo inclinato (45° - 60°)			0,5			
Diramazione con curve d'invito			2,0			
Confluenza con curve d'invito			2,0			

TABLE 3 Minor losses coefficients for pipe components

Diametro interno tubi in acciaio inox, rame e materiale plastico		8 - 16 mm	18 - 28 mm	30 - 54 mm	> 54 mm
Diametro esterno tubi in acciaio		3/8" - 1/2"	3/4" - 1"	1 1/4" - 2"	> 2"
Tipo di resistenza localizzata	Simbolo				
Valvola di intercettazione dritta		10,0	8,0	7,0	6,0
Valvola di intercettazione inclinata		5,0	4,0	3,0	3,0
Saracinesca a passaggio ridotto		1,2	1,0	0,8	0,6
Saracinesca a passaggio totale		0,2	0,2	0,1	0,1
Valvola a sfera a passaggio ridotto		1,6	1,0	0,8	0,6
Valvola a sfera a passaggio totale		0,2	0,2	0,1	0,1
Valvola a farfalla		3,5	2,0	1,5	1,0
Valvola a ritegno		3,0	2,0	1,0	1,0
Valvola per corpo scaldante tipo dritto		8,5	7,0	6,0	-
Valvola per corpo scaldante tipo a squadra		4,0	4,0	3,0	-
Detentore dritto		1,5	1,5	1,0	-
Detentore a squadra		1,0	1,0	0,5	-
Valvola a quattro vie		6,0		4,0	
Valvola a tre vie		10,0		8,0	
Passaggio attraverso radiatore		3,0			
Passaggio attraverso caldaia a terra		3,0			

TABLE 4 Minor losses coefficients for pipe fittings

With these tables we can calculate the sum of the minor losses coefficients per each section of the piping system, considering both fittings and pipe components. Once the sum and the fluid velocity in a section are known, by using another table shown as table 5, it is possible to calculate the total minor pressure drop of that section.



		v = velocità, m/s															Σξ = sommatoria coefficienti perdite di carico localizzate, adimensionale	z = perdite di carico localizzate, mm c.a.
v	Σξ	1	2	3	4	5	6	7	8	9	10	11	12	13	14	15	Σξ	v
0,10	z	0,5	1,0	1,5	2,0	2,5	3,0	3,5	4,0	4,5	5,0	5,4	5,9	6,4	6,9	7,4	z	0,10
0,12	z	0,7	1,4	2,1	2,9	3,6	4,3	5,0	5,7	6,4	7,1	7,8	8,6	9,3	10	11	z	0,12
0,14	z	1,0	1,9	2,9	3,9	4,9	5,8	6,8	7,8	8,7	9,7	11	12	13	14	15	z	0,14
0,16	z	1,3	2,5	3,8	5,1	6,3	7,6	8,9	10	11	13	14	15	16	18	19	z	0,16
0,18	z	1,6	3,2	4,8	6,4	8,0	9,6	11	13	14	16	18	19	21	22	24	z	0,18
0,20	z	2,0	4,0	5,9	7,9	9,9	12	14	16	18	20	22	24	26	28	30	z	0,20
0,22	z	2,4	4,8	7,2	9,6	12	14	17	19	22	24	26	29	31	34	36	z	0,22
0,24	z	2,9	5,7	8,6	11	14	17	20	23	26	29	31	34	37	40	43	z	0,24
0,26	z	3,3	6,7	10	13	17	20	23	27	30	33	37	40	44	47	50	z	0,26
0,28	z	3,9	7,8	12	16	19	23	27	31	35	39	43	47	50	54	58	z	0,28
0,30	z	4,5	8,9	13	18	22	27	31	36	40	45	49	53	58	62	67	z	0,30
0,32	z	5,1	10	15	20	25	30	35	41	46	51	56	61	66	71	76	z	0,32
0,34	z	5,7	11	17	23	29	34	40	46	52	57	63	69	74	80	86	z	0,34
0,36	z	6,4	13	19	26	32	39	45	51	58	64	71	77	83	90	96	z	0,36
0,38	z	7,2	14	21	29	36	43	50	57	64	72	79	86	93	100	107	z	0,38
0,40	z	7,9	16	24	32	40	48	55	63	71	79	87	95	103	111	119	z	0,40
0,42	z	8,7	17	26	35	44	52	61	70	79	87	96	105	114	122	131	z	0,42
0,44	z	9,6	19	29	38	48	58	67	77	86	96	105	115	125	134	144	z	0,44
0,46	z	10	21	31	42	52	63	73	84	94	105	115	126	136	147	157	z	0,46
0,48	z	11	23	34	46	57	68	80	91	103	114	126	137	148	160	171	z	0,48
0,50	z	12	25	37	50	62	74	87	99	111	124	136	149	161	173	186	z	0,50
0,52	z	13	27	40	54	67	80	94	107	121	134	147	161	174	187	201	z	0,52
0,54	z	14	29	43	58	72	87	101	116	130	144	159	173	188	202	217	z	0,54
0,56	z	16	31	47	62	78	93	109	124	140	155	171	186	202	217	233	z	0,56
0,58	z	17	33	50	67	83	100	117	133	150	167	183	200	217	233	250	z	0,58
0,60	z	18	36	53	71	89	107	125	143	160	178	196	214	232	250	267	z	0,60
0,62	z	19	38	57	76	95	114	133	152	171	190	209	228	247	267	286	z	0,62
0,64	z	20	41	61	81	101	122	142	162	183	203	223	243	264	284	304	z	0,64
0,66	z	22	43	65	86	108	129	151	173	194	216	237	259	280	302	324	z	0,66
0,68	z	23	46	69	92	115	137	160	183	206	229	252	275	298	321	344	z	0,68
0,70	z	24	49	73	97	121	146	170	194	218	243	267	291	315	340	364	z	0,70
0,72	z	26	51	77	103	128	154	180	205	231	257	282	308	334	359	385	z	0,72
0,74	z	27	54	81	108	136	163	190	217	244	271	298	325	353	380	407	z	0,74
0,76	z	29	57	86	114	143	172	200	229	257	286	315	343	372	400	429	z	0,76
0,78	z	30	60	90	121	151	181	211	241	271	301	331	362	392	422	452	z	0,78
0,80	z	32	63	95	127	158	190	222	254	285	317	349	380	412	444	475	z	0,80
0,82	z	33	67	100	133	167	200	233	266	300	333	366	400	433	466	500	z	0,82
0,84	z	35	70	105	140	175	210	245	280	315	349	384	419	454	489	524	z	0,84
0,86	z	37	73	110	147	183	220	256	293	330	366	403	440	476	513	549	z	0,86
0,88	z	38	77	115	153	192	230	268	307	345	384	422	460	499	537	575	z	0,88
0,90	z	40	80	120	160	201	241	281	321	361	401	441	481	521	562	602	z	0,90
0,92	z	42	84	126	168	210	252	293	335	377	419	461	503	545	587	629	z	0,92
0,94	z	44	88	131	175	219	263	306	350	394	438	481	525	569	613	656	z	0,94
0,96	z	46	91	137	183	228	274	319	365	411	456	502	548	593	639	685	z	0,96
0,98	z	48	95	143	190	238	285	333	381	428	476	523	571	618	666	713	z	0,98
1,00	z	50	99	149	198	248	297	347	396	446	495	545	594	644	693	743	z	1,00

TABLE 5 Minor losses calculation

### 3. VALVES

Valves are one of the most important components in a pipes system. They can be used to control the system pressure, the amount of flow and even the temperature of the fluid flowing in the system.

Valves may be classified by their function:

- *Regulating*: a valve which is adjusted during commissioning to provide a fixed resistance in a fluid circuit to give the design flow rate and ensure the correct balance. The adjustment is normally manual.
- *Flow limiting*: known as automatic or dynamic balancing valves, they're utilized to maintain a constant flow in the circuit regardless the pressure difference across them.
- *Differential pressure control*: a valve which automatically adjusts to maintain a certain pressure difference across part of the circuit.
- *Modulating*: a valve which is adjusted by the control system in order to regulate the hydraulic flow.
- *Safety shut-off*: a valve which is designed to close under spring pressure in critical condition or out-of-range process variable.

Modulating valves will be the main subject of this section since they're the most common type of valves used in hydraulic circuits.

Several types of valves are used, and the most common are shown figure 12:

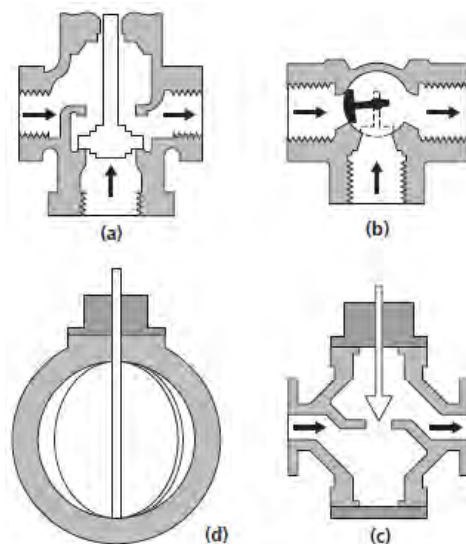

**FIGURE 12** Different types of valves: a) plug and seat three-port mixing valve, b) rotary shoe valve, c) two part plug and seat valve, d) butterfly valve

Valves are available in two, three or four-port configuration.

Two-port valves are used to throttle fluid in a circuit. Although using a two-ports valve in a complex circuit can lead to pressure variation and balancing problems throughout the system if the valve is used with variable speed pump and with proper attention to system design it can assure low first cost and low pumping cost.

Three-port valves have found widespread application especially in HVAC systems, where they're used with constant speed pump in order to offer a wide range of well-stablished and trouble-free control system. A three-port valve is provided with two inlet ports and one outlet port when described as a mixing valve or with one inlet port and two outlet ports if it's a diverting valve. An example of mixing and diverting valve is shown in the next figure.

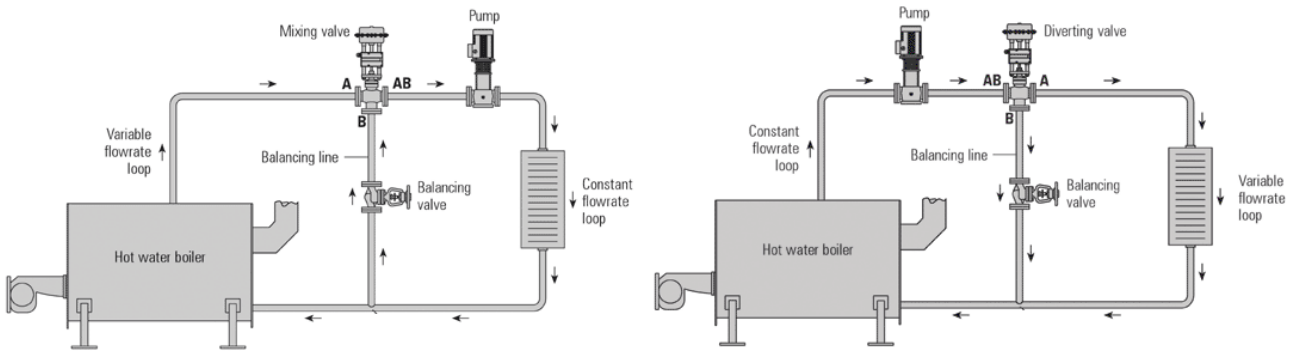
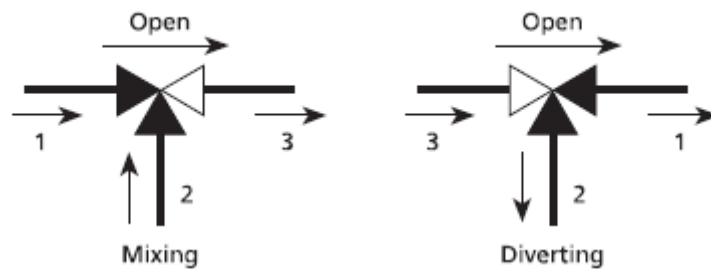

FIGURE 13 Diverting and mixing valves

Unfortunately there is not a consistent terminology to describe the ports of a three-port valve. In the next figure the more common conventions are illustrated.



Port	Name	Alternative	USA	Europe
1	Control	Load	A	E
2	Bypass	Bypass	B	L
3	Common	Common	AB	C

FIGURE 14 Three-port terminology, showing the name of the ports

### 3.1. Valve's characteristic

A control valve is one link in a chain of control, running from an error signal which is the input for the controller in order to change the output of the emitter. Although not necessary, a linear relation between the change in output from the controller and the output of the emitter are well-recommended in a well-balanced and stable circuit.

However, for most of heat emitters, there is a strongly non-linear relation between the flow rate of the heat fluid and the heat output of the emitter, with output increasing rapidly from low flow rates and then flattening out for higher flow rates (i.e. for radiators<sup>3</sup>) as shown in figure 15.

<sup>3</sup> Warburton P., *Building Control System*, CIBSE Guide, February 2009, p. 3-10

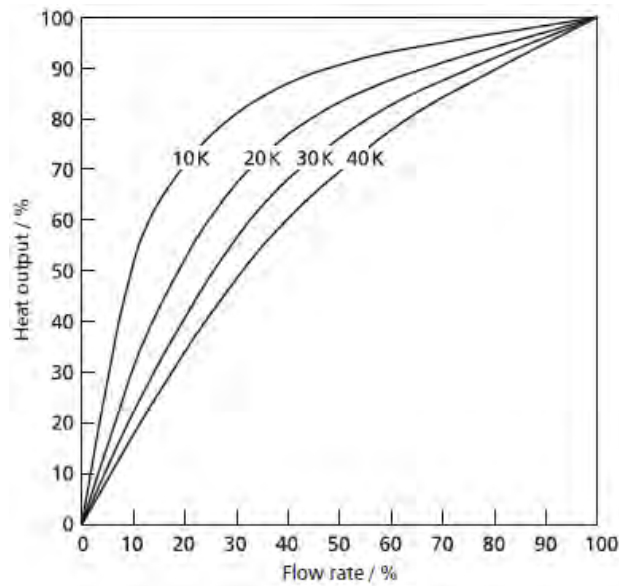

FIGURE 15 Radiator heat output as function of flow rate, with temperature as parameter

A valve which produces a flow rate proportional to spindle lift would therefore result in a non-linear system, operating in a narrow range of spindle movement with possibly resulting in unstable operations.

For this reason valves are design in order to guarantee that the heat output from the emitter is approximately proportional to the spindle lift. To do so the plug of the valve is shaped in various way to ensure that the free area (so the flow rate) is a function of the spindle lift. This defines the characteristic of the valve, and the most common encountered are:

- *Linear*: where the orifice area is directly linear with the spindle movement and the flow varies linearly with the spindle lift.
- *Equal percentage*: when a percentage variation of valve spindle lift provides an equal percentage change in orifice area.
- *Characterized V-port*: characteristic which fall between linear and equal percentage.
- *Quick opening*: where the flow increase rapidly from zero to a small spindle lift. These valves are used primarily for on-off service.

All previous characteristics are pictured in figure 16.

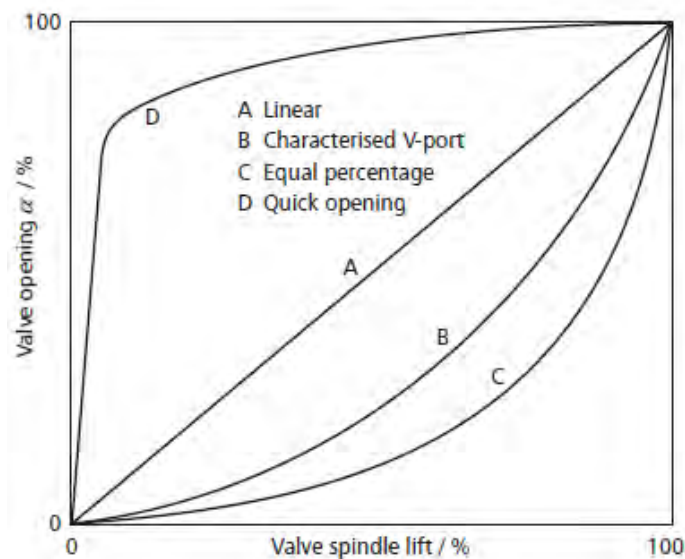

FIGURE 16 Representation of valve's characteristics

In order to have those different characteristic curves the plug of the valve must be shaped in different ways, as shown in picture 17:

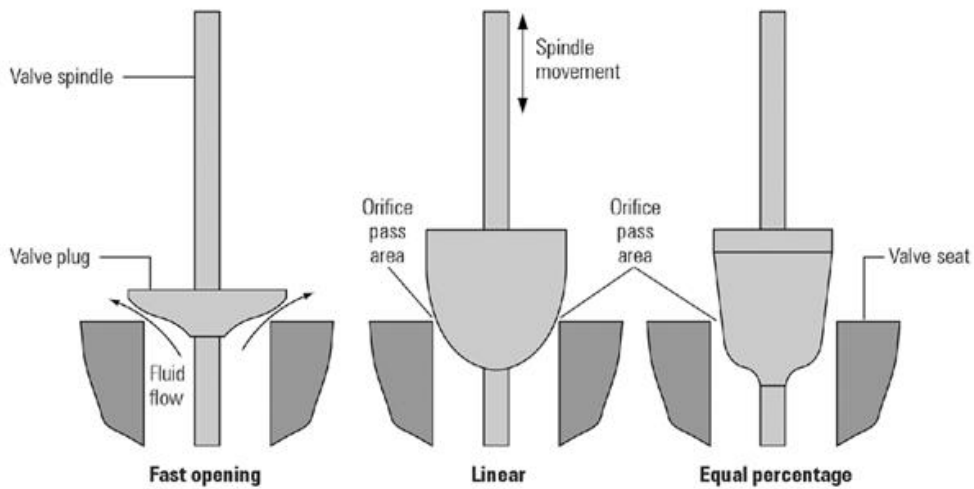

FIGURE 17 The shape of the plug determines the valve characteristic

### 3.1.1. The globe valve

A globe valve consists in a body that suddenly changes the direction of flow, as seen in picture 18. Flow enters the bottom chamber, flows upwards through the gap between the seat and the flat disc and finally exits sideways from the upper chamber. The gap between the seat and the disc determines the flow resistance created by the valve.

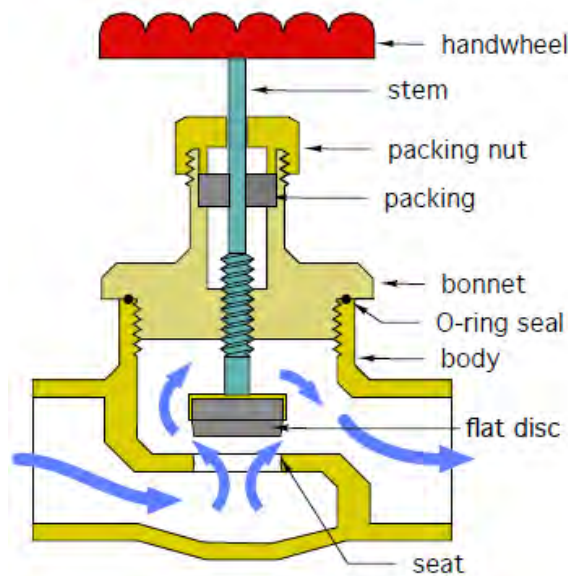

FIGURE 18 Schematic representation of a globe valve

Globe valves should always be installed such that flow enters from the bottom chamber. This allows the disc to close against the higher pressure chamber. Reverse flow in this type of valve may cause unstable flow regulation, cavitation and noise.

The movement of the flat disc when the stem is rotated creates the so-called “quick opening” characteristic. This implies that the flow rate will rapidly increase as the flat disc first lift up from the since, then continues to rise at progressively slow rates. The characteristic is illustrated in figure 19.

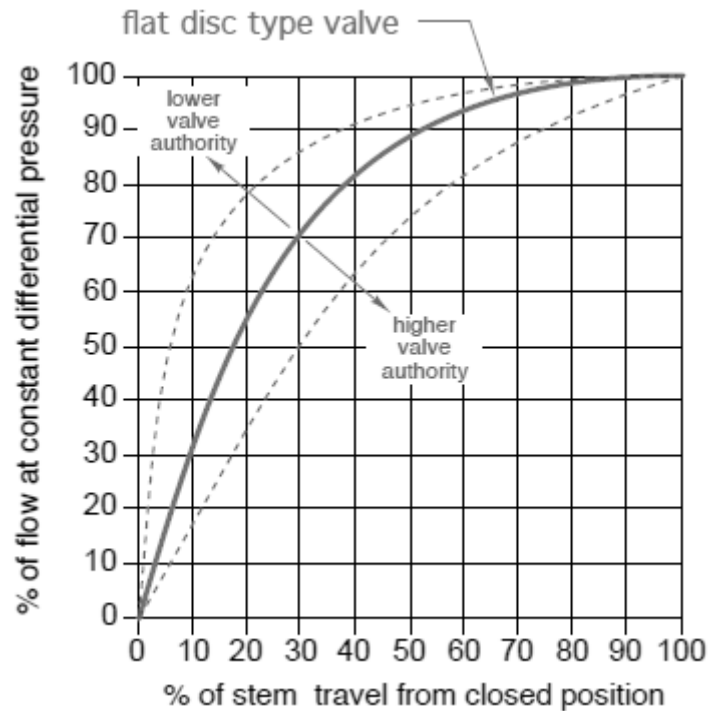

FIGURE 19 Quick opening characteristic

The combination of quick-opening characteristic with the rapid rise in heat transfer rate at low flowrates makes the overall relationship between heat output and flowrate very non-linear, and hence very difficult to control, especially at low flowrates.

### 3.1.2. The equal percentage valve

The equal percentage valve has a theoretical characteristic which can be mathematically expressed as an equation relating the flow with the spindle movement for a constant pressure drop across the valve:

$$Q = Q_0 e^{(S \cdot n)}$$

where  $Q$  is the flow through the valve,  $Q_0$  is the theoretical flow through the valve (at  $S = 0$ ),  $n$  is the valve sensitivity and  $S$  is the spindle lift level (1 = fully open, 0 = fully closed).

The sensitivity  $n$  is the percentage change in flow through the valve for a 1% change in stem position. The theoretical flow  $Q_0$  is a mathematical convenience and it doesn't represent the real flow when the valve is closed.

An equal percentage valve is made to follow the theoretical characteristic shown in figure 16 but departs from it at low flow rates. A practical equal percentage valve has a characteristic curve as shown in figure 20.

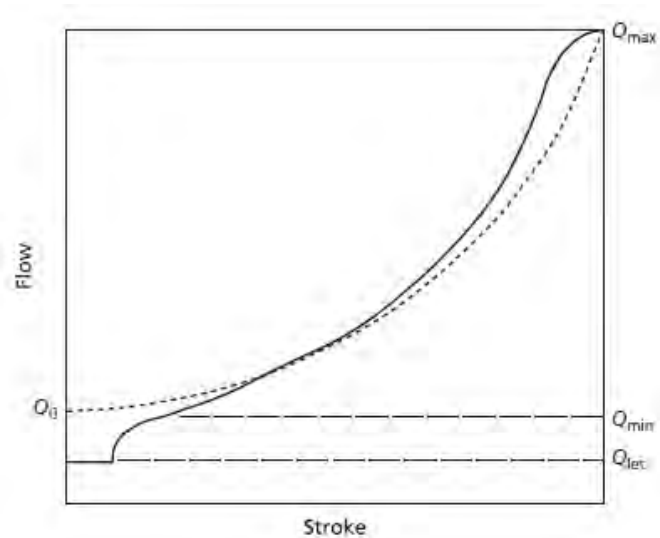

**FIGURE 20** Theoretical (dotted line) and practical (solid line) characteristic curve for an equal percentage valve

$Q_{\min}$  is the minimum flow at which the valve provides reasonable control, under it the flow rate rapidly fall off and cannot be controlled reliably. For this reason valves are designed to shut off quickly for flows below  $Q_{\min}$ . if it's not true, the residual flow is called "let-by".

The ratio of the maximum controllable flow to the maximum flow is called *rangeability*  $R$ . A rangeability of 25 means that the valve is able to reduce the flow through it down till 4% of its maximum. By this definition it's obvious how a good rangeability level is essential when the valve is required to control at low flow rates.

The equal percentage valve has been created to provide a more proportional relationship between heat output and stem position. Flow through this type of valves increases exponentially with upward movement of the stem. Assuming that the differential pressure across the valve is held constant, equal increments of stem movement result in an equal percentage change in current flow through the valve. For example, moving the stem from 40% open to 50% open (a 10% change) will increase the flowrate by 10% from its value at 40% open. This relationship is illustrated in picture 21.

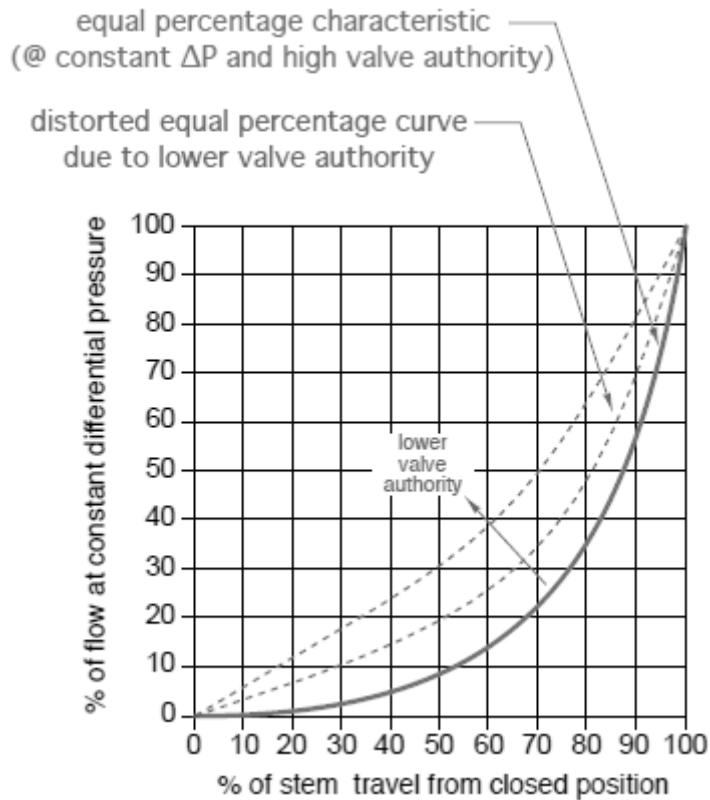

FIGURE 21 Equal percentage characteristic

When a valve with equal percentage characteristic control flow through an heat emitter, the relationship between heat output from the emitter and stem position becomes nearly linear. As shown in figure 22, the rapid increase in heat output from the emitter at low flowrates is counterbalanced by the slow increase of the flowrate through the valve. As valve approaches fully close position, the small increase in heat output is compensated for by the rapid increase in flowrate though the valve.

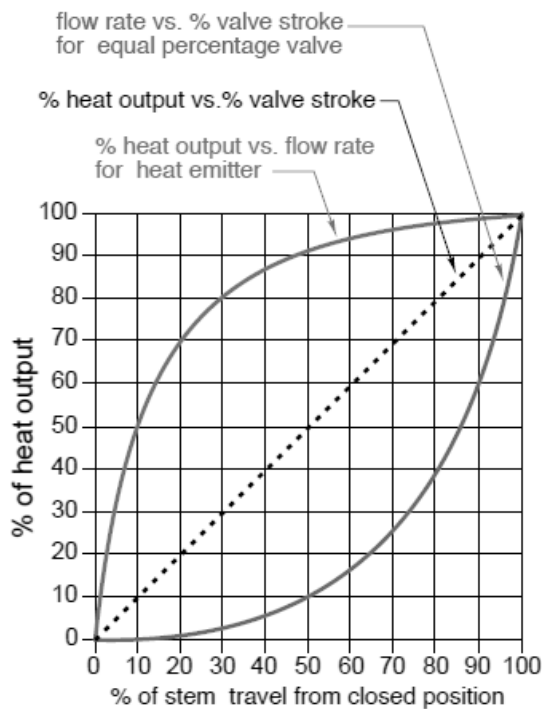

FIGURE 22 Heat output vs stem position relationship with an equal percentage valve



To accomplish an equal percentage characteristic the disc of the valve has to be properly shaped. Two of the most common designs are a logarithmic-shape plug and a tapered slot as flow control element. Both of them are shown in figure 23.

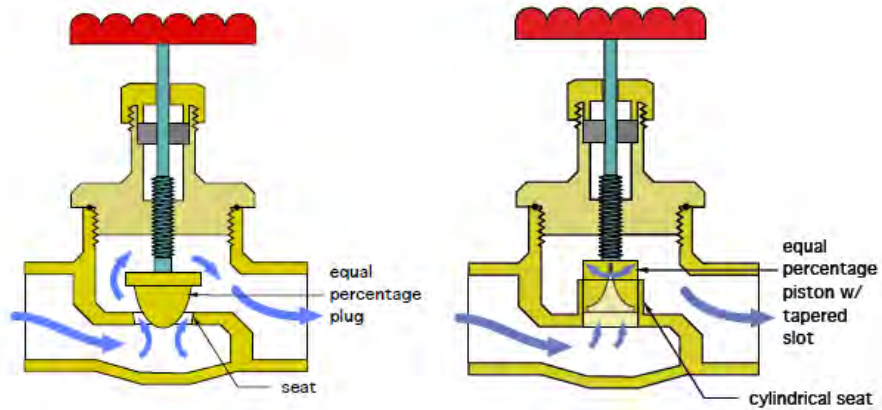

FIGURE 23 Two different ways to obtain an equal percentage characteristic

Independently of which configuration is applied, the flow through the valve will increase exponentially as the plug lift up from the seat.

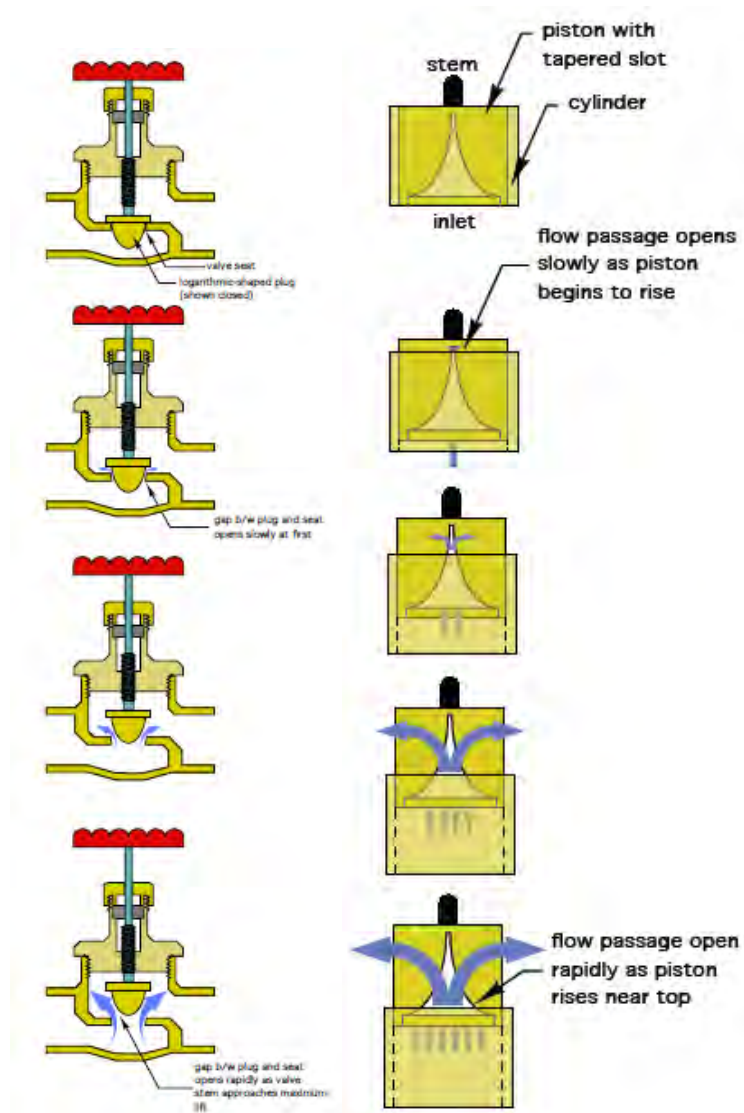

FIGURE 24 Sequence of stem lift in equal percentage valves

### 3.2. Flow coefficient

The concept of flow coefficient is based on the hydrodynamic law saying that the pressure drop across a valve is proportional to the square of the flow volume:

$$\Delta p \sim Q^2$$

Considering two different points inside a pipe we can write that:

$$\frac{\Delta p_1}{Q_1^2} = \frac{\Delta p_2}{Q_2^2}$$

or:

$$Q_1 = Q_2 \sqrt{\frac{\Delta p_1}{\Delta p_2}}$$

Since the definition of  $k_v$  says that  $k_v$  stands for the water flow rate through the valve when there is a pressure drop of 1 bar across the valve, if we put  $Q_2=k_v$  and  $\Delta p_2=1$  we will get the original equation for the flow coefficient, measured in  $m^3/h$ :

$$k_v = \frac{Q}{\sqrt{\Delta p}}$$

where  $Q$  is the flow rate through the valve and  $\Delta p$  is the pressure drop across the valve. The flow coefficient specified the water flow in  $m^3$  through the valve in one hour with a pressure drop of 1 bar across the valve.

The flow over a valve in fully open position is called  $k_{vs}$ .

The flow coefficient, provided by the valve-maker, is used to choose a valve knowing the pressure drop across it or the flow rate through it. To do this a diagram like the one pictured in figure 25 is required.

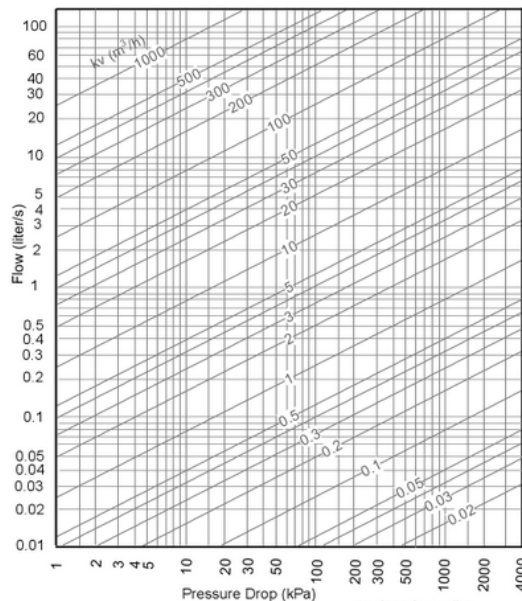

FIGURE 25 Pressure drop-flow diagram with  $k_v$  as parameter

### 3.3. Authority of a valve

To provide a good control a valve must be sized taking in account the circuit it has to control. In particular the pressure drop across the valve has to be of the same order as that of the rest of the circuit. If the valve is too large when open, the resistance to flow in the circuit will be dominated by the resistance of rest of the circuit making the valve useless. The valve will start to work properly only in a small range of the spindle lift when the valve is nearly closed. On the other hand, if the valve is too small, there would be an excessive pressure drop and additional pump work would be required to maintain the flow.

The *authority of a valve* is defined as the ratio between pressure drop across a fully open valve and the pressure drop across the whole circuit:

$$N = \frac{\Delta p_1}{\Delta p_1 + \Delta p_2}$$

where  $\Delta p_1$  is the pressure drop across the valve in fully open position and  $\Delta p_2$  is the pressure drop across the remainder of the circuit. The sum  $\Delta p_1 + \Delta p_2$  is obviously the pressure drop across the whole circuit.

A minimum authority of 0.5 is acceptable. Below this value, as shown in figure 26, the characteristic of the valve would be increasingly distorted from the required shape resulting in a more difficult control at low flow rates.

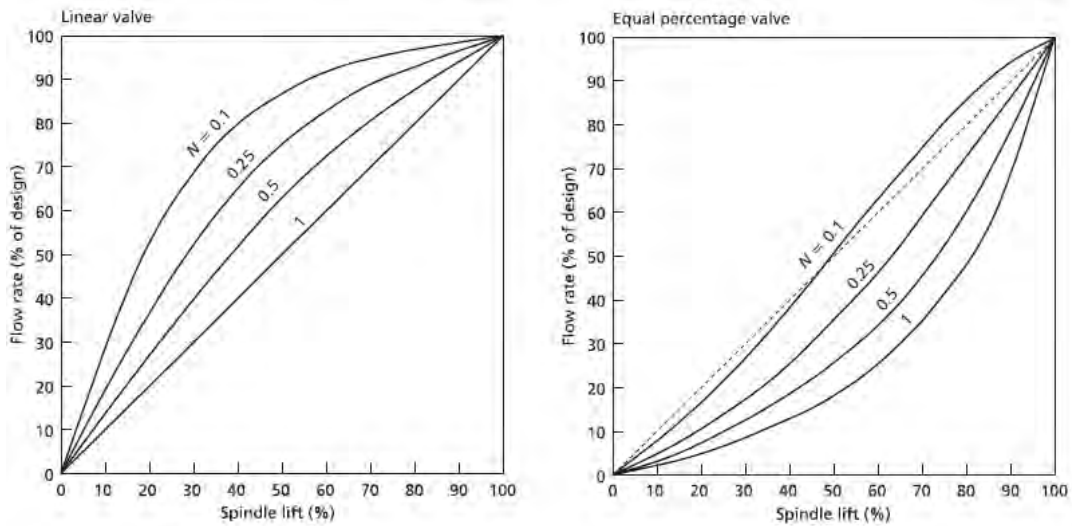

FIGURE 26 Flow through a control valve as function of spindle lift, showing the effect of valve authority

For three-port valve the pressure drop across the whole circuit is calculated in relation to the part of the circuit with variable flow rate, as pictured in figure 27.

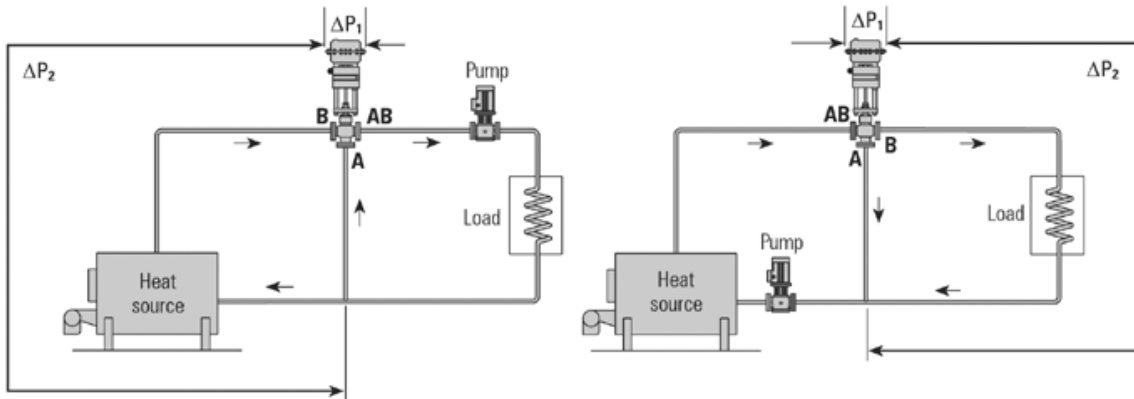

FIGURE 27 valve authority diagrams showing three-port valves and pressure drop in the circuit

Where a three-port valve is used in a circuit to ensure a constant flow through the emitter, as in figure 28, the incorporation of a balancing valve in the bypass leg allowed the resistance of the bypass leg to be set equal to the resistance of the heat generator circuit.

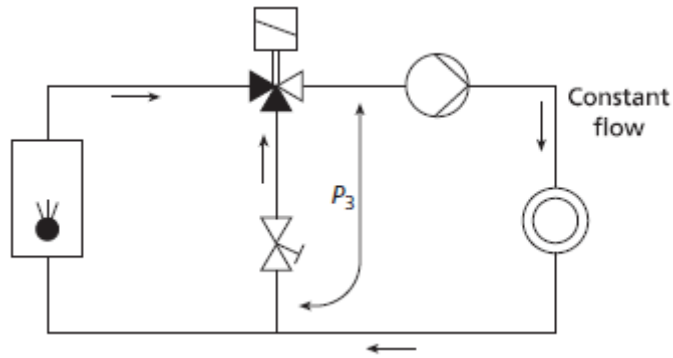

FIGURE 28 A three-port valve with balancing valve in the bypass leg

In this way the resistance seen by the pump is equal whether the valve is fully open or fully closed with the same flow in both positions.

However, to ensure the same flow at all positions of the valve another design parameter has to be taken into account: the symmetry of the internal ports. Symmetrical design means that control and bypass port in a three-port valve are built in the same way, so that their characteristics are the same. This means that they can be switched without affecting the control behavior of the valve. However, when both the ports have equal percentage characteristic, the total flow through the valve is not the same in all valve positions, as pictured in figure 29.

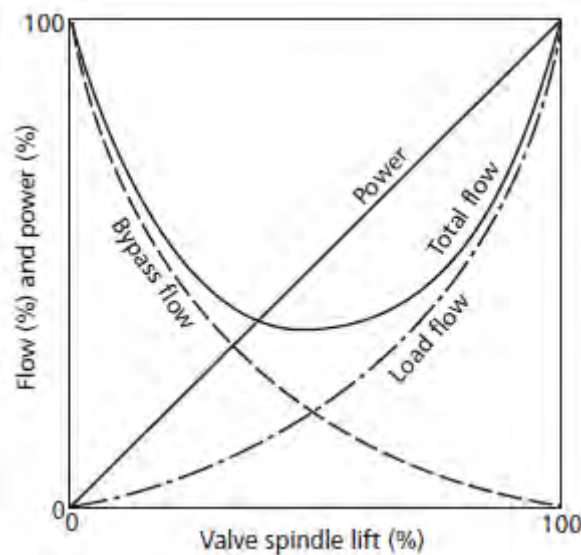

FIGURE 29 Curves for symmetrical three-port valve selected for linear power output

To avoid this asymmetrical valve can be used. Asymmetrical design means that the control port ensures the desired operating characteristic while the bypass port is designed to compensate to ensure constant total flow through the valve regardless valve's position. The diagram for an asymmetric valve is shown in picture 30. Obviously the ports of an asymmetrical valve can't be switched.

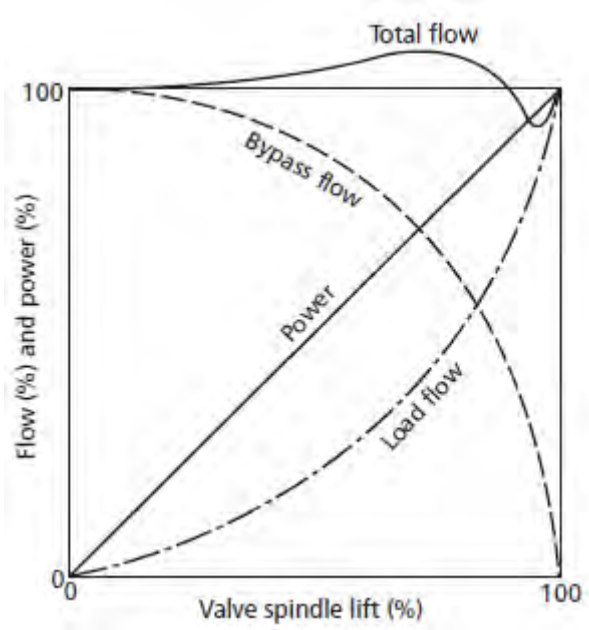

FIGURE 30 Curves for asymmetrical three-port valve selected for linear power output

## 4. PUMPS

Pumps are used in a circuit or plant to increase the pressure of a fluid by transferring mechanical energy from the motor to the fluid through the rotating impeller. There are many types of pumps, but in this thesis only the centrifugal pumps will be discussed since they are the most common.

The two main components of a pump are the impeller attached on a rotating shaft and a stator casing (or volute) enclosing the impeller. A simple scheme of a centrifugal pump is shown in figure 31.

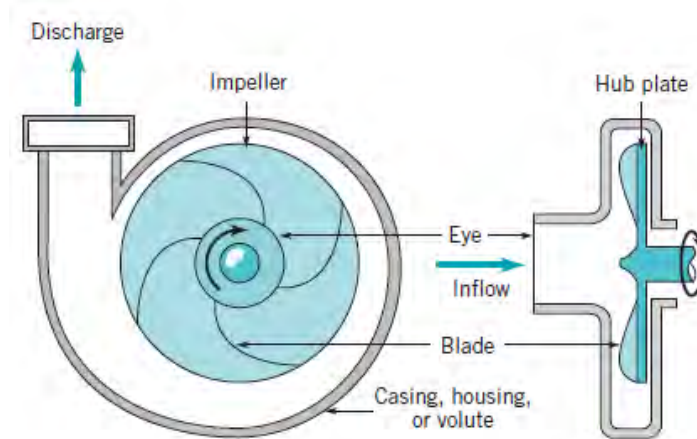

FIGURE 31 Schematic representation of a centrifugal pump

As the impeller rotates the fluid is sucked into the eye of the impeller and flows radially outward. The energy is added to the fluid by the impeller blades, and both pressure and absolute velocity is increased as the fluid moves from the eye to the blade's periphery. Figure 32 shows the flow of the fluid inside a centrifugal pump.

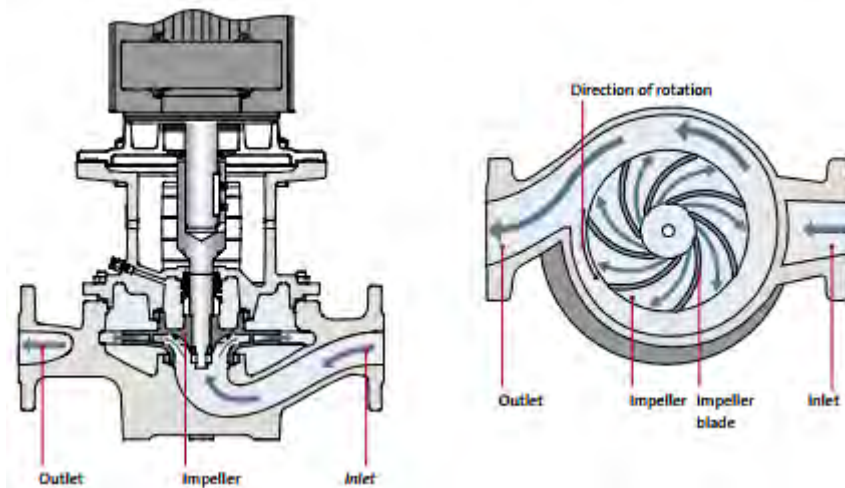

FIGURE 32 Schematic view of the fluid path inside a centrifugal pump

For the simplest centrifugal pumps the fluid discharges directly into a volute-shaped casing. The casing shaped is designed to reduce the velocity as the fluid leaves the impeller (by an increasing casing area in flow direction), and this decrease in kinetic energy is transformed into an increase in pressure. For bigger pumps a different design is adopted in which the fluid passes through diffuser guide vanes which surround the impeller. The diffuser vanes decelerate the fluid as it is directed into the pump casing.

### 4.1. Pump curve

One of the most important aspects of pumps is their performance curve. To fully understand how a pump works and to select the right pump to associate with a plant or circuit is indispensable to know how to read a pump curve.

To understand how a pump curve is obtained a bit of theoretical considerations about pumps are required. To do so it will be considered the average one-dimensional flow of the fluid as it passes between the inlet and outlet sections of the impeller as the blades rotate. As shown in figure 33, for a typical blade passage we can write that:

$$V_1 = U_1 + W_1$$

where  $V_1$  is the absolute velocity of the fluid entering the blade,  $U_1$  is the velocity of the blade rotating with angular speed  $\omega_1$  and  $W_1$  is the relative velocity of the fluid within the blade passage. The previous equation has to be considered as a vector sum and the fluid velocity are taken as average velocities over the inlet and exit sections of the impeller. An analog equation can be written for the exit passage:

$$V_2 = U_2 + W_2$$

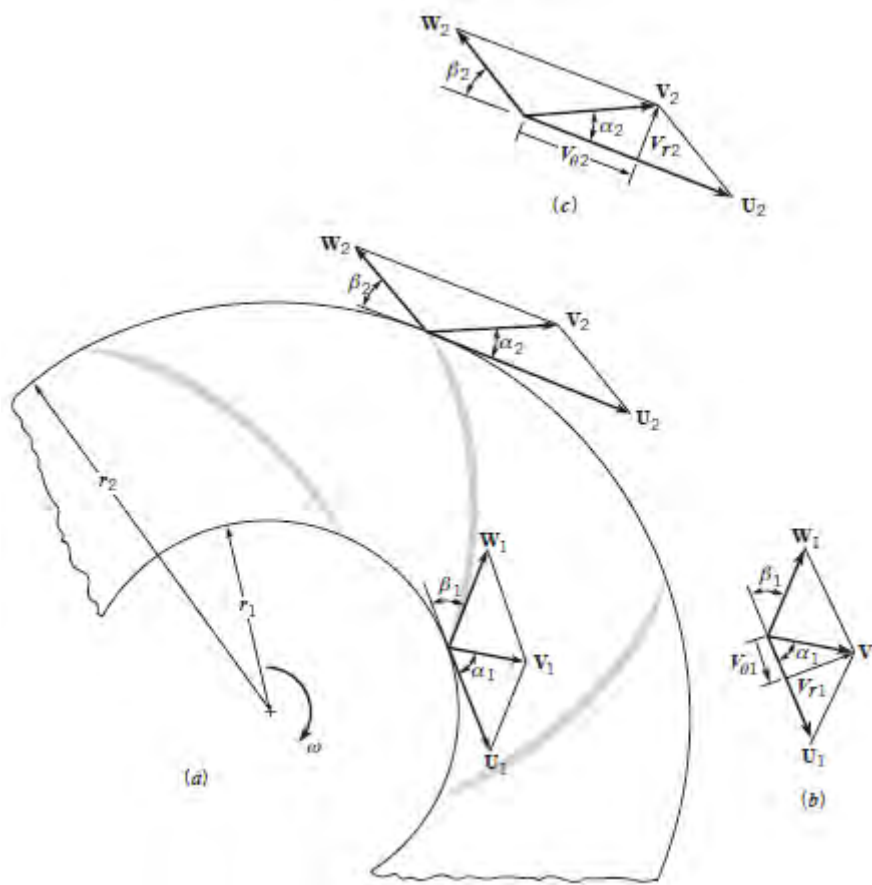

FIGURE 33 Velocity diagram at the inlet and exit of a centrifugal pump

The moment-of-momentum equation<sup>4</sup> indicates that the shaft torque required to rotate the impeller is, with  $m_1=m_2$ :

$$T_{shaft} = \dot{m}(r_2 V_{\theta 2} - r_1 V_{\theta 1})$$

or:

$$T_{shaft} = \rho Q(r_2 V_{\theta 2} - r_1 V_{\theta 1})$$

where  $V_{\theta}$  is the tangential component of the absolute velocity  $V$ .

For a rotating shaft the power transferred is given by:

$$W_{shaft} = \omega T_{shaft} = \omega \rho Q(r_2 V_{\theta 2} - r_1 V_{\theta 1})$$

Since  $U_1=\omega r_1$  and  $U_2=\omega r_2$  we obtain:

<sup>4</sup> Huebsch W., Munson R., Okiishi H., Young F., *Fundamentals of Fluid Mechanics* Sixth edition, United State of America, Wiley, 2009, p.655

$$W_{shaft} = \rho Q (U_2 V_{g2} - U_1 V_{g1})$$

which shows how the power supplied to the shaft of the pump is transferred to the flowing fluid. It follows that the power per unit mass of flowing fluid is:

$$w_{shaft} = \frac{W_{shaft}}{\rho Q} = (U_2 V_{g2} - U_1 V_{g1}) \quad ^5$$

For incompressible flow the energy equation can be written as:

$$w_{shaft} = \left( \frac{p_{out}}{\rho} + \frac{V_{out}^2}{2} + gy_{out} \right) - \left( \frac{p_{in}}{\rho} + \frac{V_{in}^2}{2} + gy_{in} \right) + loss$$

Combining the two equations for  $w_{shaft}$  leads to:

$$(U_2 V_{g2} - U_1 V_{g1}) = \left( \frac{p_{out}}{\rho} + \frac{V_{out}^2}{2} + gy_{out} \right) - \left( \frac{p_{in}}{\rho} + \frac{V_{in}^2}{2} + gy_{in} \right) + loss$$

Dividing both sides by the gravity acceleration we obtain:

$$\left( \frac{U_2 V_{g2} - U_1 V_{g1}}{g} \right) - h_L = H_{out} - H_{in} = h_a$$

where  $H$  is the total head,  $h_L$  is head loss and  $h_a$  is the actual head rise achievable by the fluid.

From these equations we can see that the ideal head rise is obtained when the head loss  $h_L$  is zero:

$$h_i = \frac{U_2 V_{g2} - U_1 V_{g1}}{g}$$

This ideal head rise is the sum of the actual head rise,  $H_{out} + H_{in}$ , and the head loss which reduces the head rise achieved by the fluid.

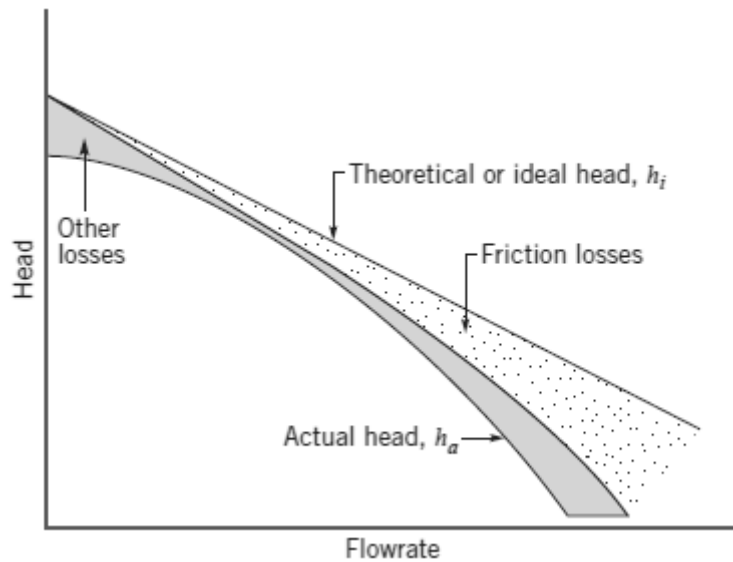

FIGURE 34 Head-flowrate curve for a centrifugal pump showing the effects of losses

Figure 34 shows the ideal and actual head rise for a centrifugal pump. As already discussed the  $h_a$  curve lies below the ideal head rise and shows a non-linear variation with flow rate. That curve is obtained for a constant rotating velocity of the impeller, measured in rpm. In the next figure the effect of a variable velocity of the impeller is illustrated.

<sup>5</sup> Since normally the fluid enters the pump axially it can be written that  $U_1 V_{g1} = U_1 V_1 \cos \alpha_1 = 0$



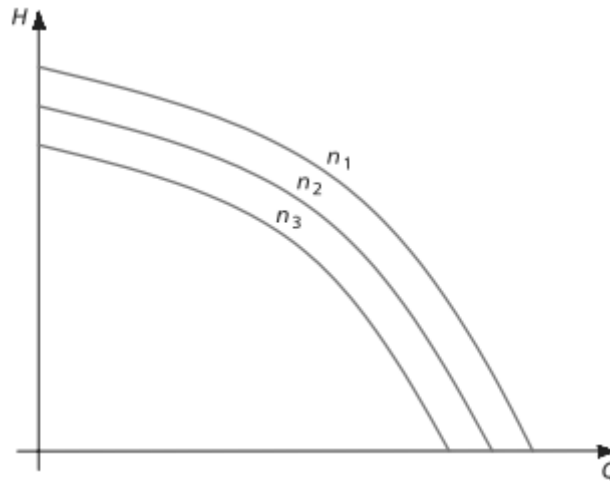

FIGURE 35 Characteristic curve for different rotating velocities ( $n_1 > n_2 > n_3$ )

However, to study a pump in a proper way, only the H-Q curve is not enough. There are also other curves that have to be considered to fully understand how a pump works.

#### 4.1.1. Efficiency curve

The overall efficiency of a pump can be defined as:

$$\eta = \frac{\text{power gained by the fluid}}{\text{shaft power driving the pump}}$$

where the power gained by the fluid, termed as water horsepower  $P_f$ , is given by:

$$P_f = \rho Q g h_a$$

The shaft power driving the pump is obviously  $w_{\text{shaft}}$  and it represents the total power applied to the shaft of the pump. It is often referred as *brake horsepower* (bhp).

The efficiency of a pump is a combination of three different efficiencies: the hydraulic efficiency  $\eta_h$ , the mechanical efficiency  $\eta_m$  and the volumetric efficiency  $\eta_v$ , so that:

$$\eta = \eta_h \eta_m \eta_v$$

The hydraulic efficiency consist of all kind of hydraulic losses that occur in the pump such as fluid friction in the blade passage, flow separation and other three-dimensional flow effects. The volumetric efficiency is affected by all the volumetric losses such as fluid leakage in various components of the pump.

A typical efficiency curve for a centrifugal pump is given in figure 36:

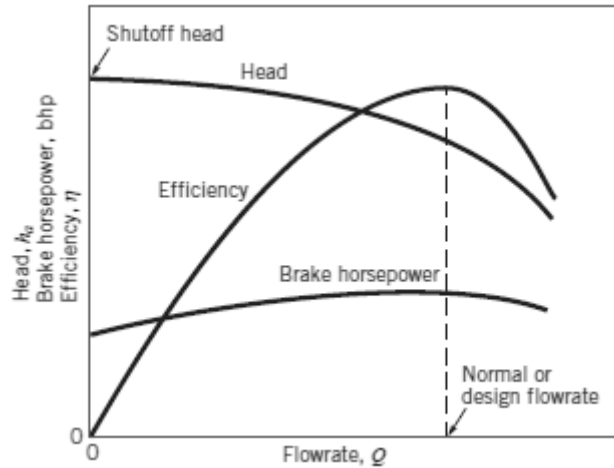

FIGURE 36 Typical performance characteristic for a centrifugal pump

As shown in figure 30 the efficiency of a pump is a function of the flowrate, and reaches its maximum value for a particular flowrate often referred as normal or *design flowrate*. The points on the curve corresponding to the maximum efficiency are denoted as *best efficiency point* (BEP) and must be the aim for all pump designers.

#### 4.1.2. Net Positive Suction Head (NPSH)

On the suction side of a pump low pressures are commonly encountered with resulting prospect of cavitation within the pump. Cavitation, described in detail in chapter 3.2., occurs when the pressure of the fluid decrease till the vapor pressure. In this condition the fluid begin to “boil” and vapor bubbles start to create within the pump. This phenomenon can lead to loss in pump’s efficiency as well as structural damage to the pump.

To characterize the potential of cavitation in a pump is used the *Net Positive Suction Head*:

$$NPSH = \frac{p_s}{\gamma} + \frac{V_s^2}{2g} - \frac{p_v}{\gamma}$$

where  $\frac{p_s}{\gamma} + \frac{V_s^2}{2g}$  is the total head on the suction side and  $\frac{p_v}{\gamma}$  is the liquid vapor pressure head. NPSH is positive and stated in meter as the head.

There are actually two values of NPSH of interest. The first one is the  $NPSH_A$  which stands for NPSH Available. It is an expression of how close the fluid in the suction line is to vaporization. This value is typically obtained experimentally but it can be also calculated if the system parameters are known.

The second value for NPSH is the  $NPSH_R$  which stands for NPSH Required. It represents the lowest NPSH value required for acceptable operation. This value must obviously be maintained or exceeded during normal operation with the pump.

By these definitions it is clear that the relation between  $NPSH_A$  and  $NPSH_R$  is:

$$NPSH_A \geq NPSH_R$$

Usually a safety range of 0.5 meters is taken. A representation of  $NPSH_R$  curve is provided in figure 37.

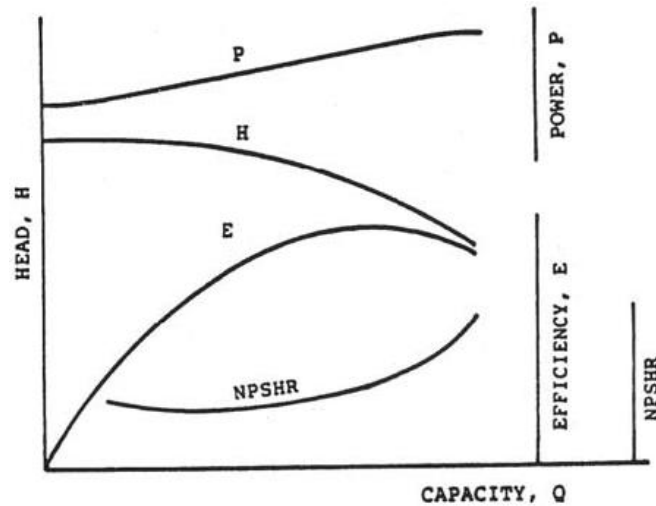

FIGURE 37 Diagram showing NPSH<sub>r</sub>, efficiency, power and head curve of a pump

## 4.2. Cavitation

Cavitation is defined as the process of formation of vapor phase in a flowing liquid when it is subjected to reduced pressure at constant ambient temperature. Thus, it is the process of boiling due to pressure reduction rather than heat addition.

In general, as we can see from Bernoulli equation, an increase in velocity is accompanied by a decrease in pressure. If the increase in velocity is considerable the decrease in pressure will also be considerable, therefore the pressure of the liquid may go under the vapor pressure and the liquid will start to “boil”.

The bubbles formed will then collapse as the fluid moves into a region of higher pressure (lower velocity). This process can produce dynamic effects (as imploding) that cause very large pressure transient near the bubbles. If this phenomenon occurs near a physical boundary it can, over a period of time, damage it. Moreover the burst of the bubbles is accompanied by a very loud noise. This noise is the result of shock waves generated upon bubble collapse.

It is useful to characterize how close the liquid pressure to the vapor pressure is by means of the *cavitation number*, that is:

$$\sigma = \frac{p - p_v}{\frac{1}{2} \rho_l u^2}$$

where  $p$  and  $u$  are the pressure and velocity of the liquid flow,  $p_v$  is the saturated vapor pressure and  $\rho_l$  is the liquid density. Above the cavitation number no cavitation will occur, while it will occur under it.

In a pipe system cavitation may occur for vary reasons: it can happen either as a result of an increase in fluid velocity, which can be obtained throughout a constriction in the pipe section, or an increase in the pipe elevation.

## 4.3. Pumps in systems

A pump is always connected to a system where it has to circulate or lift the fluid. The energy added to the fluid is partly lost as heat and as friction in the pipe system.

A typical system in which a pump is used is shown in figure 38.

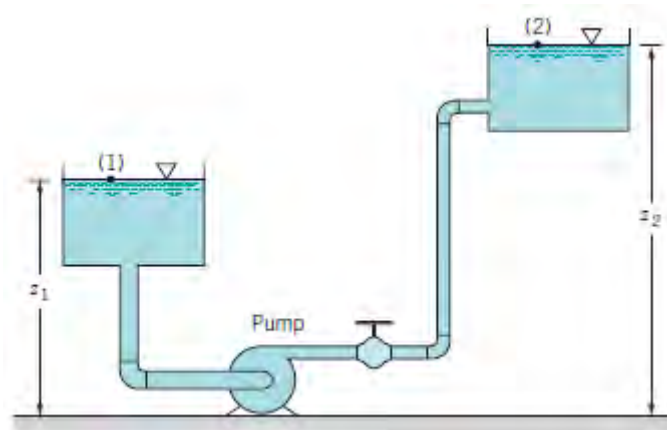

FIGURE 38 Typical flow system

The energy equation applied between point (1) and point (2) leads to:

$$h_a = z_2 - z_1 + \sum h_L$$

with obvious meaning of the terms.

Since it's known that  $h_L$  varies approximately with the square of the flowrate the previous equation can be rewritten as:

$$h_a = z_2 - z_1 + KQ^2$$

where K depends on friction factor, pipe sizes and lengths and minor losses coefficients. This equation is the *system equation* and shows how the actual head gained by the fluid is related to the system parameters. Each flow system has its own system equation.

As we know there is also a unique relation between the actual pump head gained by the fluid and the flowrate, which is governed by the pump design. To select a pump for a particular application, it is necessary to use both the system curve and the pump performance curve, as illustrated in figure 39.

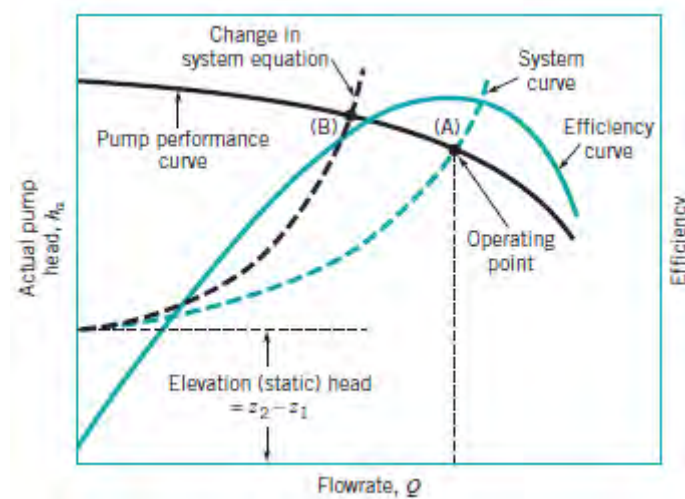

FIGURE 39 Pump and system curves used to obtain the operating point for the system

If both curves are plotted on the same graph, their interception (point A) represents the operation point of the system. In other words, this point provides us the head and the flowrate that solve both the pump equation and system equation. In figure 33 is also plotted the efficiency curve. Ideally we would like the operating point to be near the best efficiency point (BEP) for the pump.

For a given pump, if the system changes its parameters, it is clear that the operating point will also shift (in this case from point A to point B).

### 4.3.1. Pumps arranged in series or in parallel

Pumps can be arranged in series or parallel to provide additional head or flow capacity.

In system with large variation in flow and a request for constant pressure it is wise to connect the pumps in parallel. For two identical pumps in parallel, the combined performance curve is obtained by adding flowrate at the same head, as shown in figure 40.

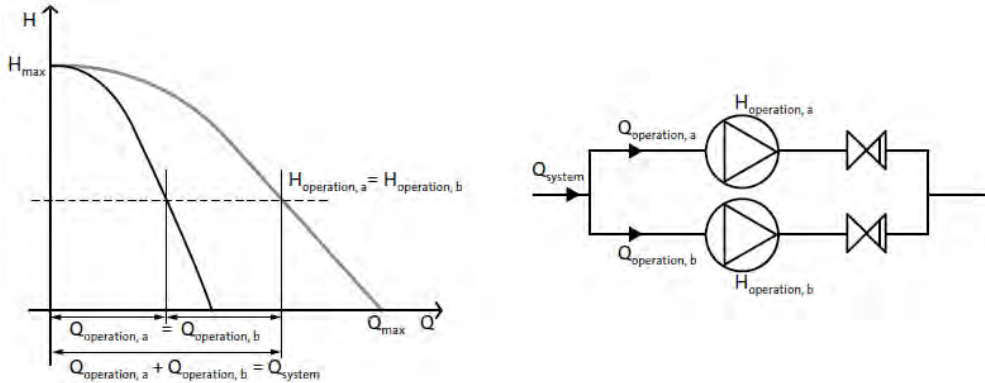

FIGURE 40 Parallel-connected pumps

Since it is possible to operate with one pump only, a non-return valve is always mounted on the discharge line to prevent backflow through the non-operating pump.

When two identical pumps are connected in series, the combined performance curve is obtained by adding head at the same flowrate.

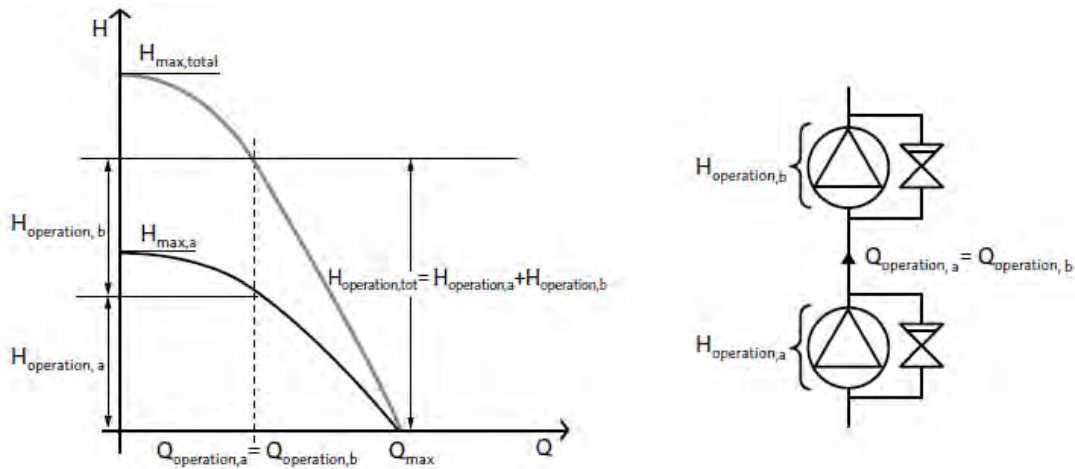

FIGURE 41 Series-connected pumps

### 4.3.2. Resistance connected in series or parallel

In a typical system not only the pumps can be connected in series or parallel. The components of the system (valves, loads etc.) can also be connected in those two different ways and this will affect the shape of the system curve.

When two resistances are connected in series, like in figure 42, the same flowrate will flow through them. Thereby the resulting system curve is obtained by adding the head loss of the two resistances per each value of the flow rate.

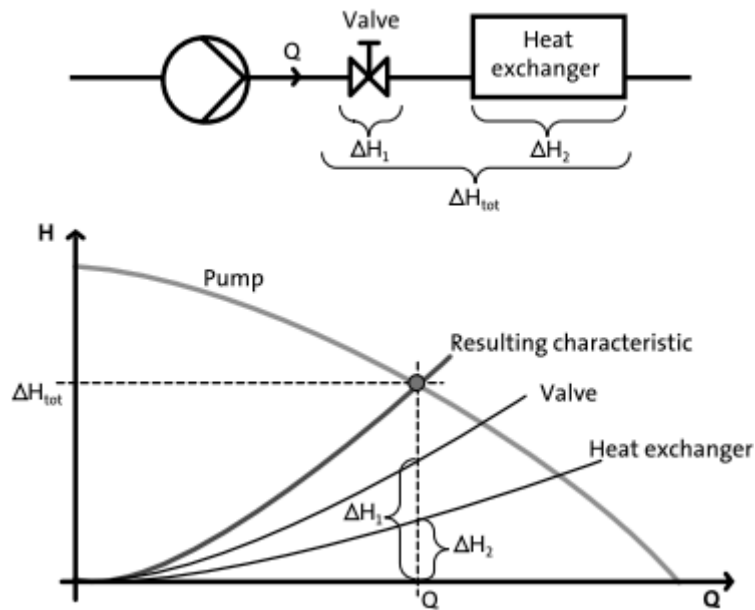

FIGURE 42 Resistances connected in series

This means that when two resistances are connected in series the system curve will be steeper.

On the other hand, when two resistances are connected in parallel, there will be the same differential pressure across each one. Contrary to connecting components in series, connecting components in parallel will result in a more flat system curve. As we can see in figure 43, the resulting system curve, since the differential pressure across the components is always the same, is defined by adding the specific flow rate through the components for a specific differential pressure.

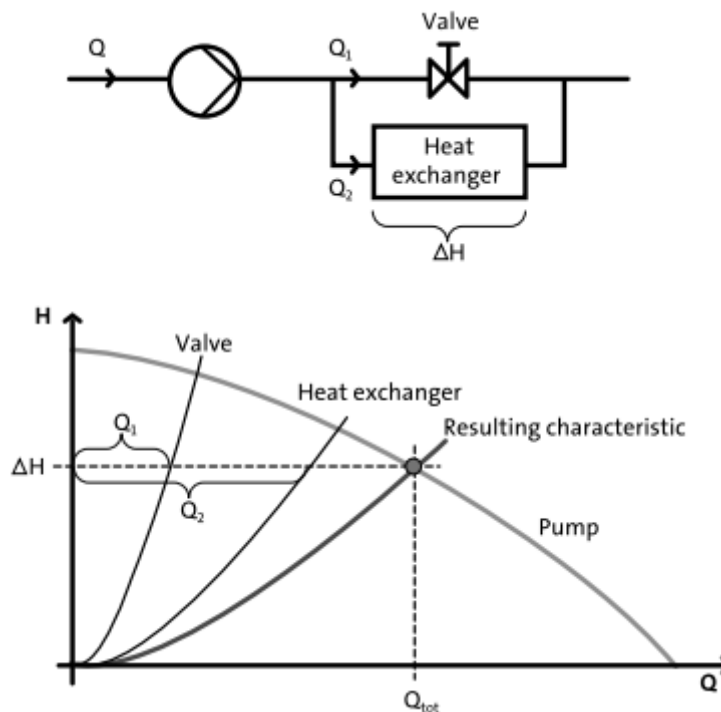

FIGURE 43 Resistances connected in parallel

### 4.3.3. Open and closed systems

The systems where the pumps are installed can be divided into two different groups: open and closed system.

Closed systems are those systems where the fluid is circulated and is the carrier of the heat, e.g. heating and cooling systems and air conditioning systems. Heat energy is in fact what the system has to transport. In these systems the pumps has only to overcome the sum of all head loss through the components and through the pipes. The resulting system curve is like the one shown in figure 44, which shows also a simple example of a closed system.

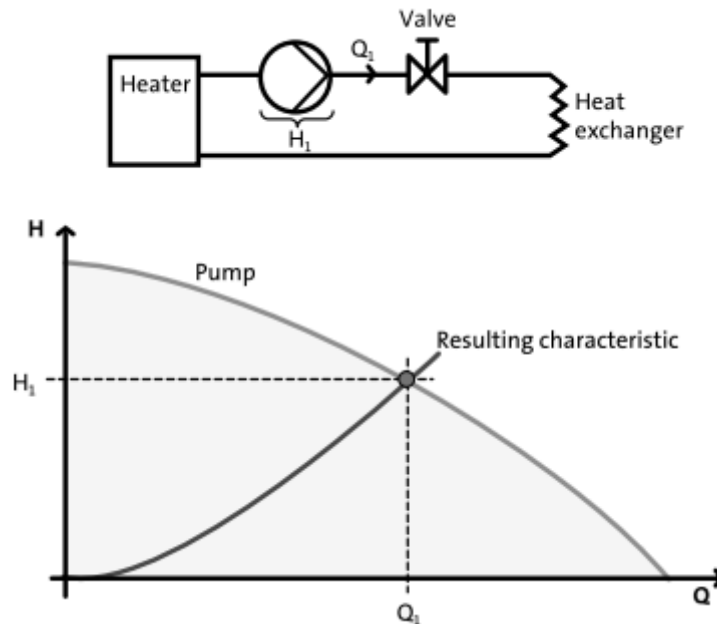

FIGURE 44 System curve for a closed system

As the curve indicates the head loss is approaching zero when the flowrate drops.

Open systems are those systems where the fluid is transferred from one place to another one, e.g. water supply systems, irrigation systems and industrial process systems. In these systems the pump has to overcome both the geodetic head of the fluid and the friction losses through all components.

We distinguish between two different types of open system.

*Open systems where the total geodetic lift is positive.* In these systems usually the pumps has to transfer a liquid from a bottom tank to an upper tanks. As already said it has to win the geodetic lift and the losses through all components. A typical system curve is like the one pictured in figure 45.

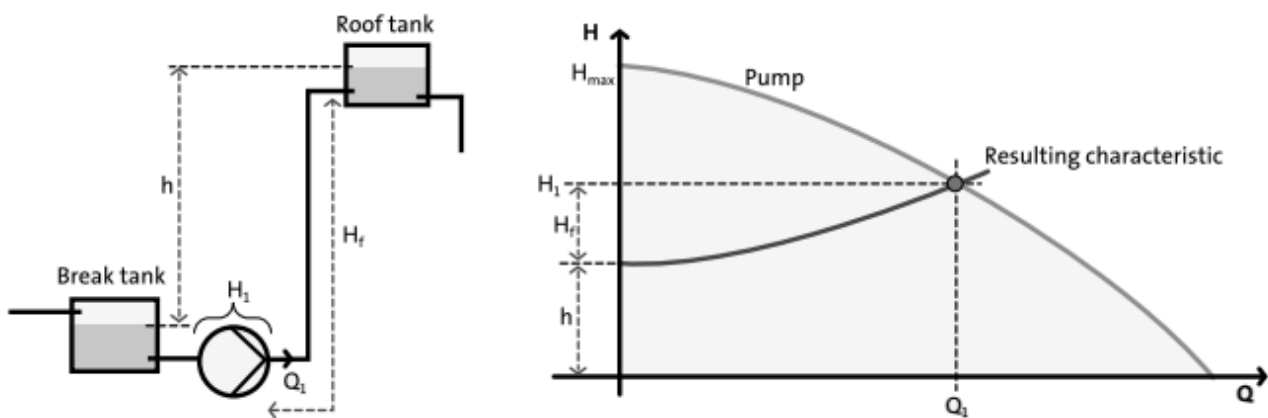

FIGURE 45 Open system with positive geodetic lift

The curve says that there will be no flow if the maximum pump head ( $H_{max}$ ) is lower than the minimum geodetic high ( $h$ ). The figure also shows that the lower the flow rate, the lower the head loss and thus the lower the consumption of the pump.

Open systems where the total geodetic lift is negative. These systems are typically used to boost the liquid flow. The geodetic head of the water tank brings the water to the consumer. This means that there is flow ( $Q_0$ ) even with pump shut off. However this flow may be not enough to match the consumer required flow ( $Q_1$ ) thus the pumps has to boost the head in order to compensate the friction losses in the system ( $H_f$ ). The system and the system curve are shown in figure 46.

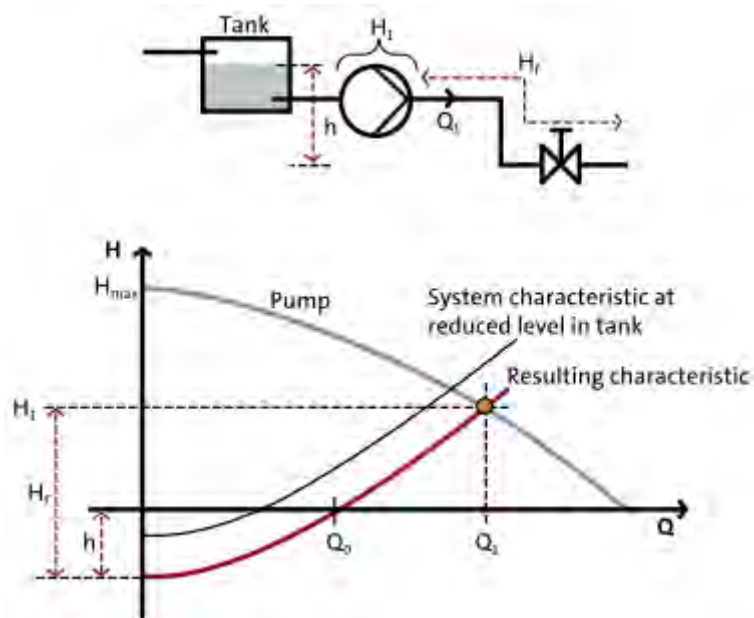

FIGURE 46 Open system with negative geodetic lift

Figure 40 also shows that if we reduce the water level in the tank ( $h$ ) the flow in the system will be reduced while the head of the pumps have to increase.

#### 4.4. Regulation of pumps

It is not always possible to match the exact system requirements with a pump. A number of methods make it possible by means of pumps' regulation which allows achieving the requested performance. The most common methods are:

##### 4.4.1. Throttle regulation

This method is based on adding a throttle valve in serial with the pump. The resistance of the entire system can be modified by changing the valve setting and thereby the flow in the system. Regulation by means of a throttle valve is best suited for pumps with a relative high head compared to flow. The purpose of this regulation is to make the system characteristic curve steeper. At constant speed, using a throttle regulation, the operating point of the pump is moved to a lower flow rate. This means that the pump will generate higher pressure head than is necessary for the system.

Throttle regulation is shown in figures 47.



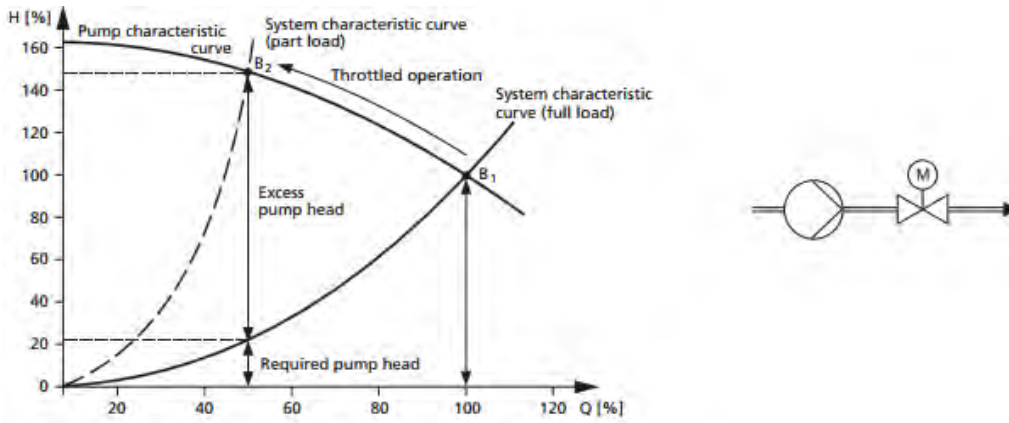

FIGURE 47 Pump regulation by throttle configuration

Since during the throttle regulation the flowrate will lower, the power absorbed by the pump will also lower, as pictured in figure 48.

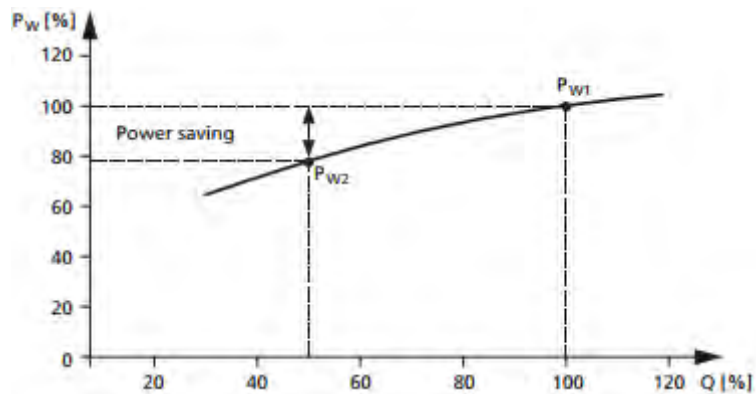

FIGURE 48 Power saving with throttle regulation

#### 4.4.2. Regulation with bypass valve

The bypass line is arranged in parallel to the pump, as shown in figure 49. The pump flow is thus divided into the useful flow, which will circulate normally into the system, and in the bypass flow, which will return to the inlet line of the pump.

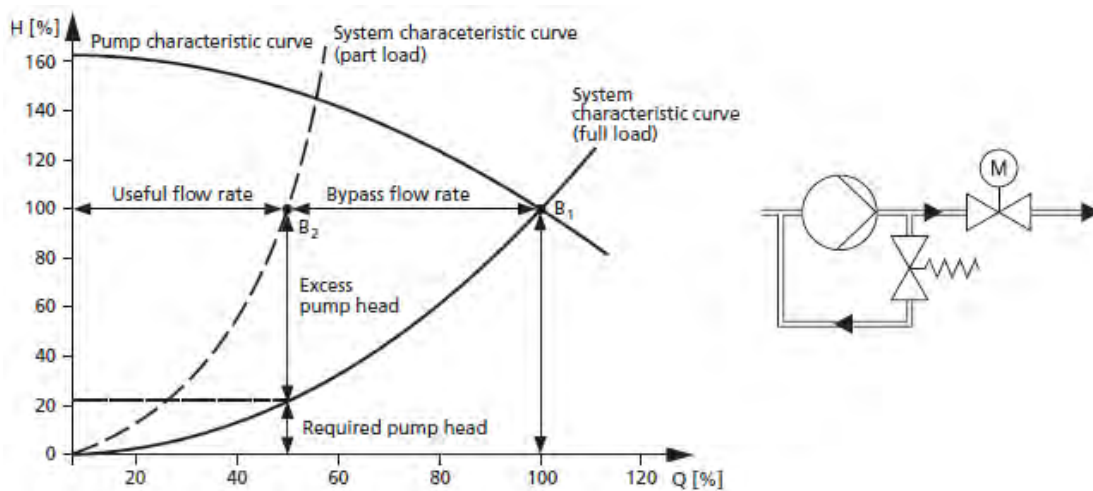

FIGURE 49 Pump regulation by bypass valve

Changing the bypass flowrate or the bypass line characteristic by means of a control valve thus allows changing the useful flow. With this method it is possible to let the pump works at almost the same operating point in fully load operation.

This method, unlike the previous one, can't provide a power saving since the pump is used with constant shaft power all the time. The effect of this method on the power saving is shown in the next figure.

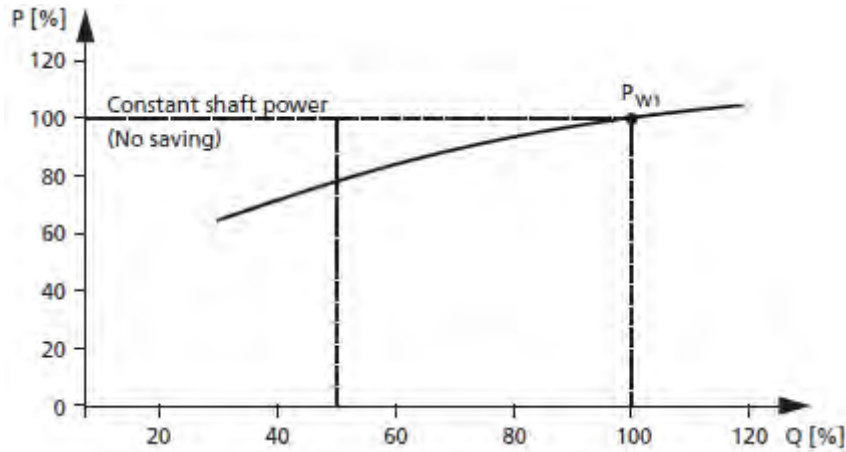

FIGURE 50 The bypass valve does not provide a power saving

#### 4.4.3. Regulation by speed variation

Unlike the previous methods regulation, controlling the speed of a pump allows a continuous modification of the pump output by changing the pump characteristic.

According to the similarity law<sup>6</sup> the following relations can be written for a centrifugal pump:

$$Q_2 = Q_1 \left( \frac{n_2}{n_1} \right)$$

$$H_2 = H_1 \left( \frac{n_2}{n_1} \right)^2$$

$$P_2 = P_1 \left( \frac{n_2}{n_1} \right)^3$$

where n is the speed of the pump, measured in rpm. These equations prove that changing the speed of a pump will affect not only the total head of the pump, but even the power gained by the fluid as well as the flowrate.

The effects of variable speed on pump head and power saving are shown in figure 51.

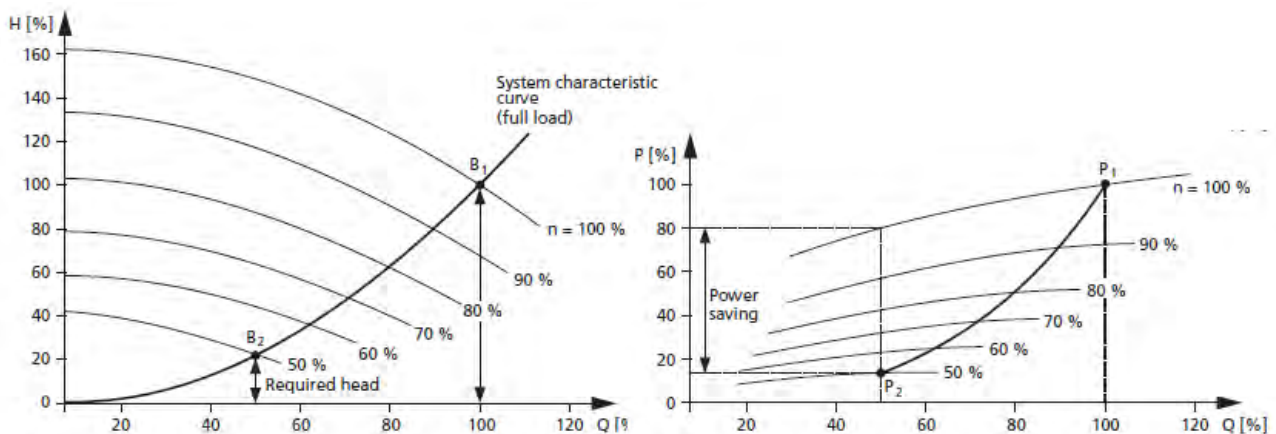

FIGURE 51 Variable speed regulation

<sup>6</sup> KSB Know-how Volume 4, *Pump Control/System Automation*, August 2006, pp. 60-69

## 5. HYDRAULIC BALANCING

The aim of a hydronic circuit is to deliver a precise rate of heat when and where it is needed. However this can be hardly achieved if the circuit is not properly balanced. In the context of hydronic applications, balancing refers to adjustments made with balancing valves so that desired interior comfort levels are achieved and maintained in all area served by the heating or cooling system.

Designing a balanced system helps avoiding lack of comfort. When a circuit is not properly balanced the heat emitter won't provide the correct rate of heat. Thus, the air temperatures inside the room served by the system will be too high, too low or both.

In the context of indoor air quality, when an area of a building cannot be warmed with the correct air temperature, the following problems can be developed:

- Frozen piping in the building's hydronic system;
- Shrinkage cracks in wood or drywall surfaces;
- Condensation on windows;
- Growth of mold and mildew;
- Increased potential for respiratory illness.

The heat output of a heat emitter is function of the flowrate through that emitter and thus, is function of the pressure drop along the piping and through the fittings. This means that, if a circuit is not properly balanced, these following problems may occur:

- The pumps will work in non-design condition, that is with low efficiency;
- High flow velocities in pipe components causing noises and possible damages;
- High pressure drop across valves and other fittings, which will be unable to carry out their functions properly;
- Excessive energy use by pumps that operate in overflow condition.

It is now clear why a balanced circuit is desirable. There are many definitions of a balanced system, but in the issues of hydronic, a well-balanced system is *"one that consistently delivers the correct rate of heat transfer to the areas served by the system"*<sup>7</sup>.

### 5.1. Fundamental concepts underlying balancing

Balancing hydronic system requires simultaneous changes in hydraulic operating conditions (e.g. flowrate, pressure drop etc.) as well as in thermal operating condition (e.g. fluid and room air temperatures) of the system. These conditions will always interact as the system continually seeks for both thermal and hydraulic equilibrium.

The fundamentals on which hydronic balancing grounds on can be very difficult to face with a mathematical approach. However, in most case it is enough a clear understanding of how and why these conditions show up in a system to guide the designer avoiding mistakes or incorrect adjustments. This is the reason why in these following chapters we will discuss only on a quality level about these problems.

#### 5.1.1. The effect of flow rate on heat output

Figure 52 shows a system with a common heat source and three crossovers. Each crossover contains a heat emitter, lengths of pipes as well as fittings and valves and serves a defined heating load. The heat transfer of the heat emitters depends on their size, their inlet fluid temperature and the flowrate through them.

---

<sup>7</sup> A Technical Journal from Caleffi Hydronic Solution, *Hydronic Balancing*, 2011, p. 6

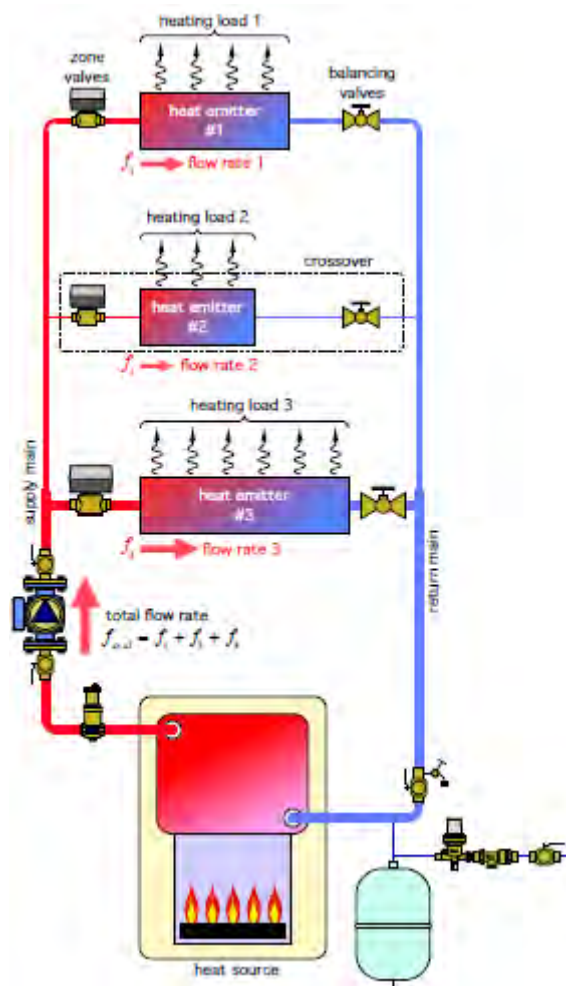

FIGURE 52 A typical system with a heat source, some crossovers and heating loads

Since the heat emitters in figure 46 are supplied from a common heat source, making the reasonable assumption that the heat loss in the main pipe can be neglected in comparison of the heat output of the heat emitters, it follows that each heat emitter is supplied with fluid at approximately the same temperatures. This, however, doesn't mean that the heat output will be the same in each heat emitter, even if they're all identical.

In effect, the flow rate through each heat emitters also affects their outputs. It can be said that *"the faster a heated fluid passes through a heat emitter, the greater the rate of heat transfer, when all other conditions are equal"*<sup>8</sup>. This principle is always valid.

An objection to this principle may be that as the fluid increases his velocity through the heat emitter, it has less time in which to release its heat. However, the time that a given fluid molecule stays inside the heat emitter is meaningless in a circuit with circulating fluid.

The increased heat output is a result of the improved convection between the heat fluid and the surface of the heat emitter. The faster the fluid moves, the thinner the fluid boundary layer between the heat emitter's surface and the bulk of the fluid stream. The thickness of this layer determines the resistance to heat flow: the thinner the boundary layer, the greater the heat exchange.

Another way to justify this principle is to consider the average fluid temperature inside the heat emitter. Consider the example in figure 53 where a heat fluid enters three heat terminals with the same inlet temperature but at three different flowrates.

<sup>8</sup> A Technical Journal from Caleffi Hydronic Solution, *Hydronic Balancing*, 2011, p. 7

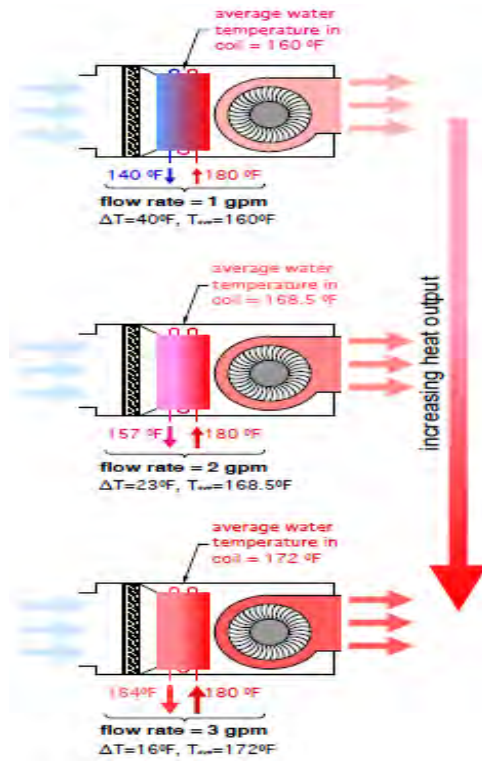

FIGURE 53 Effect of the flowrate on the heat output of a heat emitter

As we can see from the picture, the higher the flowrate through the terminal, the higher will be the average fluid temperature inside the heat exchanger. This means that at higher flow rate the temperature difference between the inlet and the exit of the heat emitter decreases, provoking an increased heat output.

It might be easy to assume that the heat output from an emitter increases in proportion with the flowrate through it. However this is not true. As pictured in figure 54 the heat output always increase if the flowrate increases but the boost in the heat output tends to decrease as the flowrate rises.

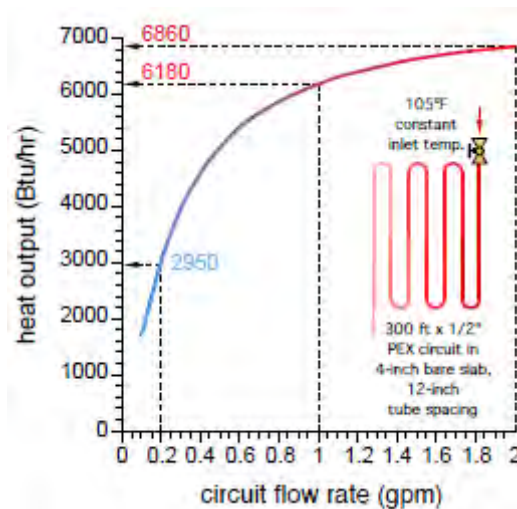

FIGURE 54 Heat output vs flowrate through a heat emitter

This non-linear relationship is typical for all kind of emitters, and it makes balancing more difficult than what one might think. When a technician starts closing a balancing valve, there is only a relatively little change on the heat output of the circuit. However, when the balancing valve is nearly closed, a little further movement of the valve will lead to large changes in the heat output.

### 5.1.2. Each crossover affects other crossovers

When the flow rate through a crossover changes the flowrate across the other crossovers will change consequently. If a flowrate in any crossover is reduced then the flowrate in the other crossovers will increase and vice versa.

The extent of the change in other crossover flowrates could be very negligible or significant depending on the means of differential pressure control used in the system.

Systems in which differential pressure between the supply manifold and the return manifold is held relatively constant (e.g. by a differential pressure bypass valve or a pressure-regulated pump) will create minimal change in crossover flowrates when the flowrate in one crossover is changed. This situation is depicted in figure 55.

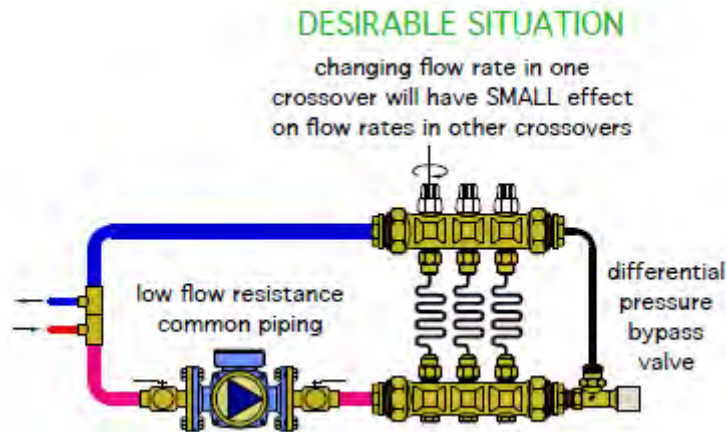

FIGURE 55 Desirable systems should have differential pressure control

On the other hand, if the system is not provided with differential pressure control, or it has a relatively high hydraulic resistance in the main piping, it will create high changes in flowrates when the flowrate through a crossover is changed. This kind of systems is shown in picture 56.

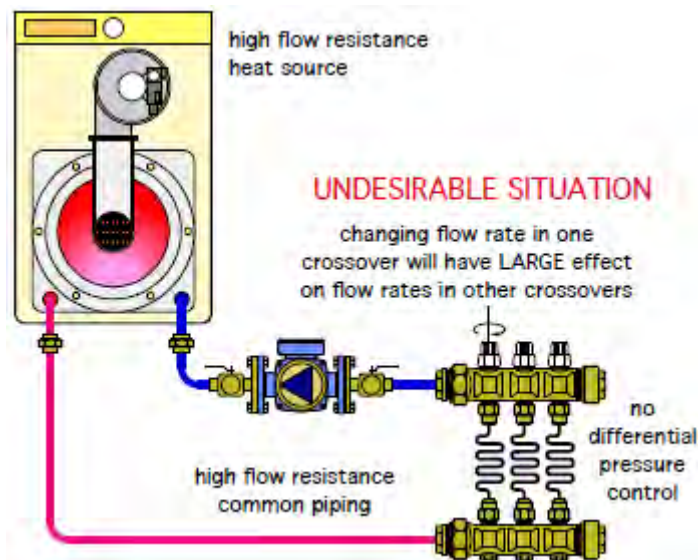

FIGURE 56 Undesirable systems do not have differential pressure control

The "ideal" hydronic system is one in which even wide adjustments in the flowrate through any crossover does not affect at all the flowrates in the other crossovers. This condition could only occur if the differential pressure across all crossovers is kept constant at any times.

### 5.1.3. Direct vs reverse return piping

In many hydraulic systems, there is a need to divide the system flow into identical streams that will pass through identical components. If the flow resistance of each parallel path is the same, the total flow will divide equally.

Taking as example the system shown in figure 57, it is apparent that even if the emitter #1 and #2 are identical, the flow resistance in the path CE and DF may be different. It is also obvious that the flow path ACDB is lower than the path ACEFDB. Thus, the flow resistance of the first path will be lower than the second one.

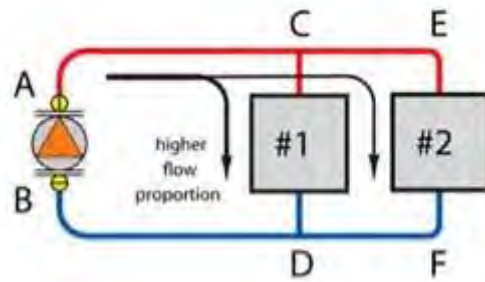

FIGURE 57 Direct return system

The above-mentioned system is called direct return system. If equal flows are required through each branch, it is necessary to adjust the hydraulic resistance of the lower resistance branch by means of a balancing valve, as shown in picture 58.

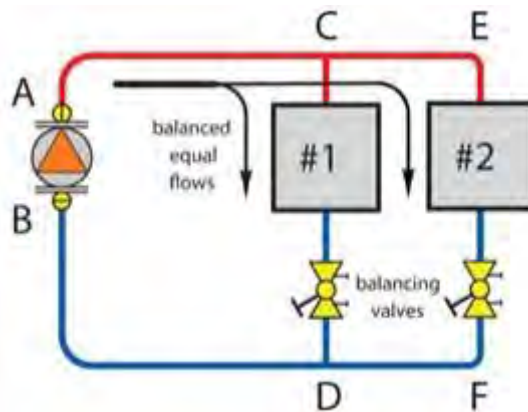

FIGURE 58 Direct return system with balancing valves

An alternative piping approach is the reverse return system shown in figure 59. In this case the flow pass through emitter #1, ACDFB, is equal to the flow path through emitter #2, ACEFB. This system has the potential to create equal flow resistance through each crossover, and hence, accomplish equal flowrate without need of balancing valves.

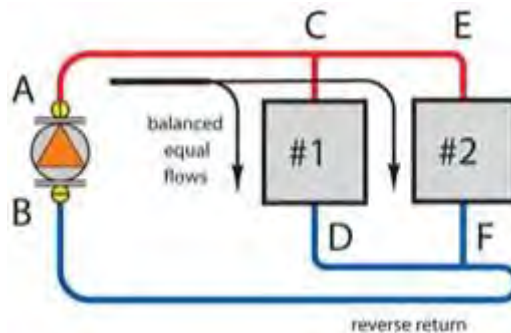

FIGURE 59 Reverse return system

However, it is not wise to assume that every reverse return system will have equal flow through any emitter. Anything that creates a difference in the flow resistance of the supply or return piping will affect flow proportions. For this reason balancing valves are usually still installed in reverse return system, especially in wide system with many crossovers that have the potential to be modified over time.

In most of reverse return piping system the size of supply and return pipes aren't kept constant. Supply pipe size decreases moving away from the circulator, while return pipe size increases. These pipe size changes are used to keep

flow velocity almost constant along the conduits. They should be made more or less symmetrically to guarantee the same pressure drop in the supply and return mains.

A reverse return system is advisable if:

- Two or more identical emitters require the same flowrate ;
- The loads served require the same supply temperature;
- The loads are being served from a main source and a common circulator;
- The loads served are widely dispersed around the building and can be linked by a complete loop around the inside of the building.

Examples of reverse return systems would be multiple solar collectors, or multiple panel radiators controlled by a common pump, as in figure 60.

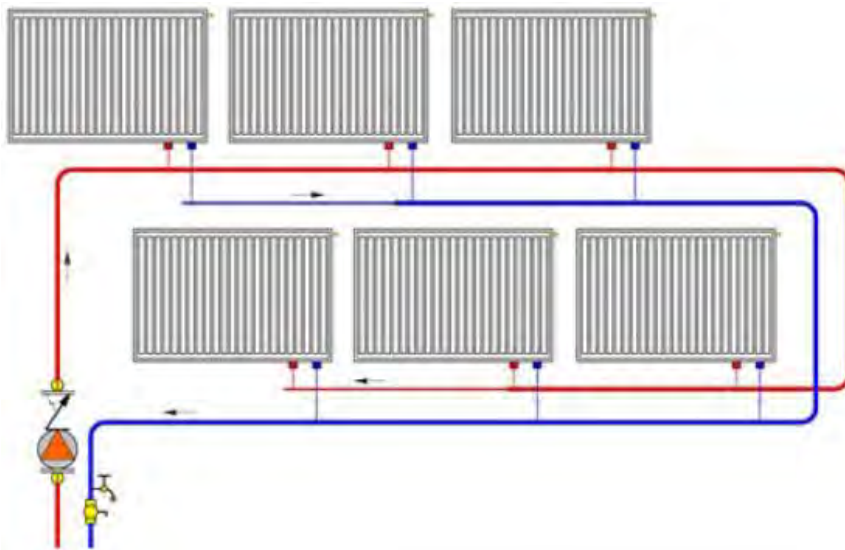

FIGURE 60 Reverse return piping for multiple panel radiators

A simple rule to remember is that the higher the ratio of the head losses along the crossovers divided by the head losses along the mains, the closer the reverse return piping system will be to “self-balancing”.

There are also some situations where a reverse return piping system can be used but it’s not necessary to obtain a proper hydraulic balancing. A typical example is a manifold station for floor heating circuits. Since the pressure drop along the manifold is extremely lower than the pressure drop along the floor circuits, the use of a reverse return piping system will have virtually no effect on individual circuit flow. The lower the pressure drop along the manifolds, the lower the effect of reverse return piping will be.

## 5.2. Types of balancing devices

There are several devices that can be used to control the flowrate through a crossover, whether manual or dynamic. This section will describe the commonly used devices in hydraulic circuit.

Even though manual balancing requires more complex installation and more junctions of the piping system, it offers a time-tested and less costly method of keeping a water system in balance. That is why it is often recommended, for small house water cooling or heating system, to choose a manual balancing system instead of a more expensive automatic balancing system.

### 5.2.1. Balancing valves

Balancing valve can be used to different purposes. They can be divided in three main categories:

- Dynamic balancing valves
- Static balancing valves
- Differential pressure control valves



### 5.2.1.1. Dynamic balancing valves: autoflow

The autoflow is a dynamic balancing valve, this means that it provides constant flowrate despite large variation in differential pressure across the valve. The regulating element is a piston with variable side orifices and an additional end port for the fluid passage. The piston moves in response of changes in differential pressure across the valve and it is counterbalanced by a helical spring usually made in stainless steel calibrated for the service. The lateral orifices are made to maintain constant the flowrate through the valve as the differential pressure across the valve changes and thus the piston moves.

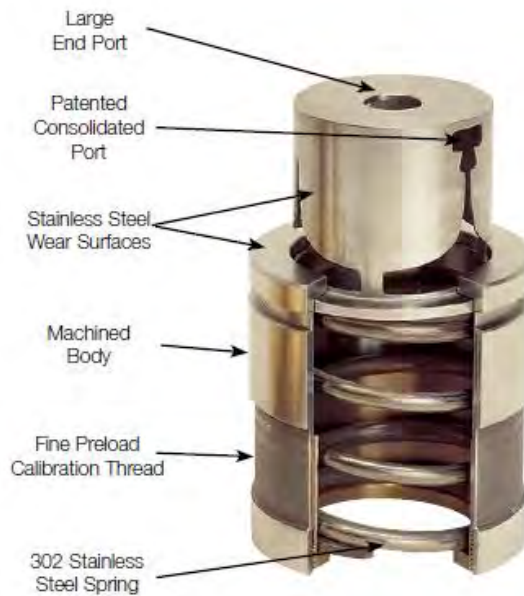
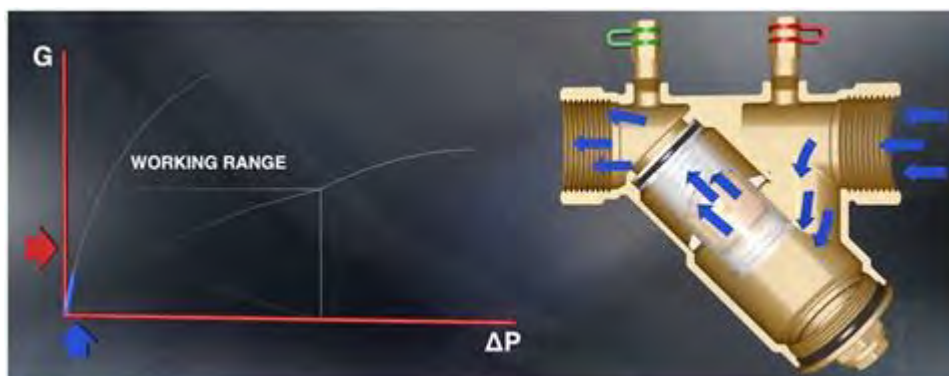

FIGURE 61 Autoflow balancing valve

The mode of operation of the autoflow is illustrated in picture 62 together with the characteristic curve. When the differential pressure across the autoflow increases while remaining below the one needed to move the piston the flowrate will increase. When the value of the differential pressure is inside the working range of the autoflow the piston will contract the spring to maintain a constant flow through the valve. When the differential pressure is above the limit value the spring is fully compressed and any further increase in differential pressure will lead to an increase in flowrate through the valve.



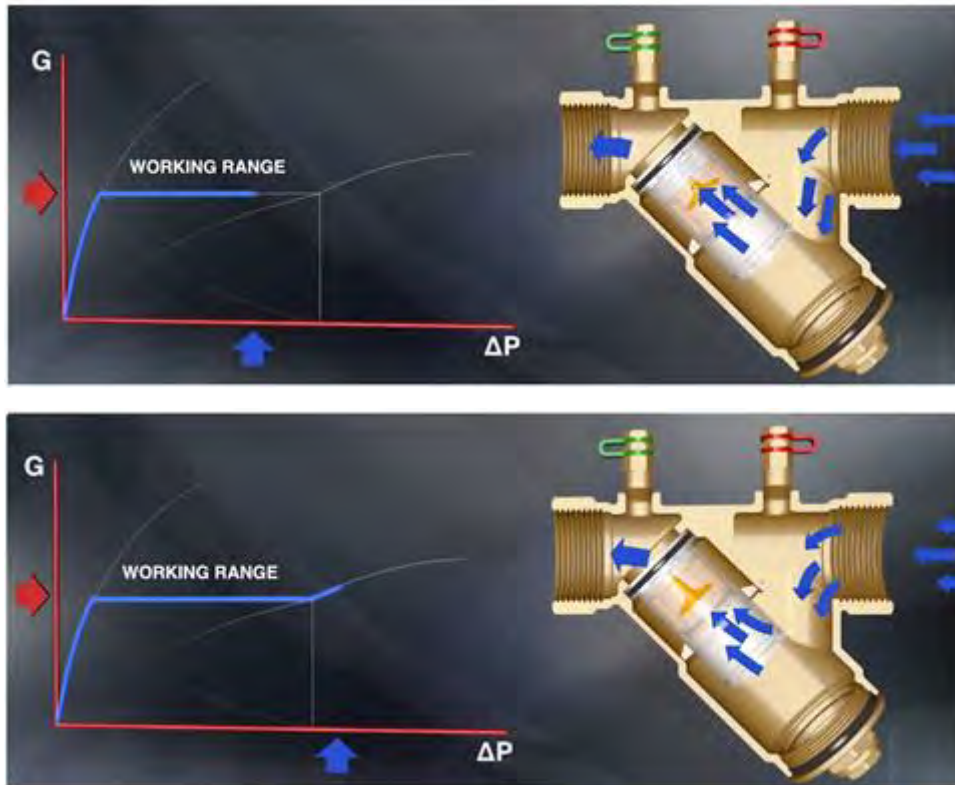

FIGURE 62 Mode of operation of an autoflow

Specific attention should be paid when the designer has to decide where to install the autoflow. In effect, if the autoflow is installed in the proximity of a 2-port valve some issues may occur. When the 2-port valve is closing in order to lower the flowrate the autoflow will move its piston to restore the previous flowrate. The autoflow is therefore working in conflict with the 2-port valve.

One possible solution to this issue is to measure the differential pressure across the 2-port valve and the autoflow as they were one. In this way they would operate in the same way and not against each other.

#### 5.2.1.2. Static balancing valve

These valves are similar to the globe valves but with a defined flowrate vs pressure drop characteristic. The flowrate through the valve varies in direct proportion to the orifice-pass-area. These valves are utilized for the manual balancing of a circuit.

Nowadays the tendency is to prefer the automatic balancing valves, especially for big systems. However, given that many of the old circuit are provided with manual valves is important to understand their working principle and when they have to be used.

The first type of manual balancing valves is the balancing valve with venture device. Circuit balancing is achieved by adding flow resistance, that is reducing the orifice-pass-area with a regulating knob provided with a graduated scale. The flowrate through the valve is measured using the venture flow meter. The working principle of a static balancing valve is illustrated in picture 63.

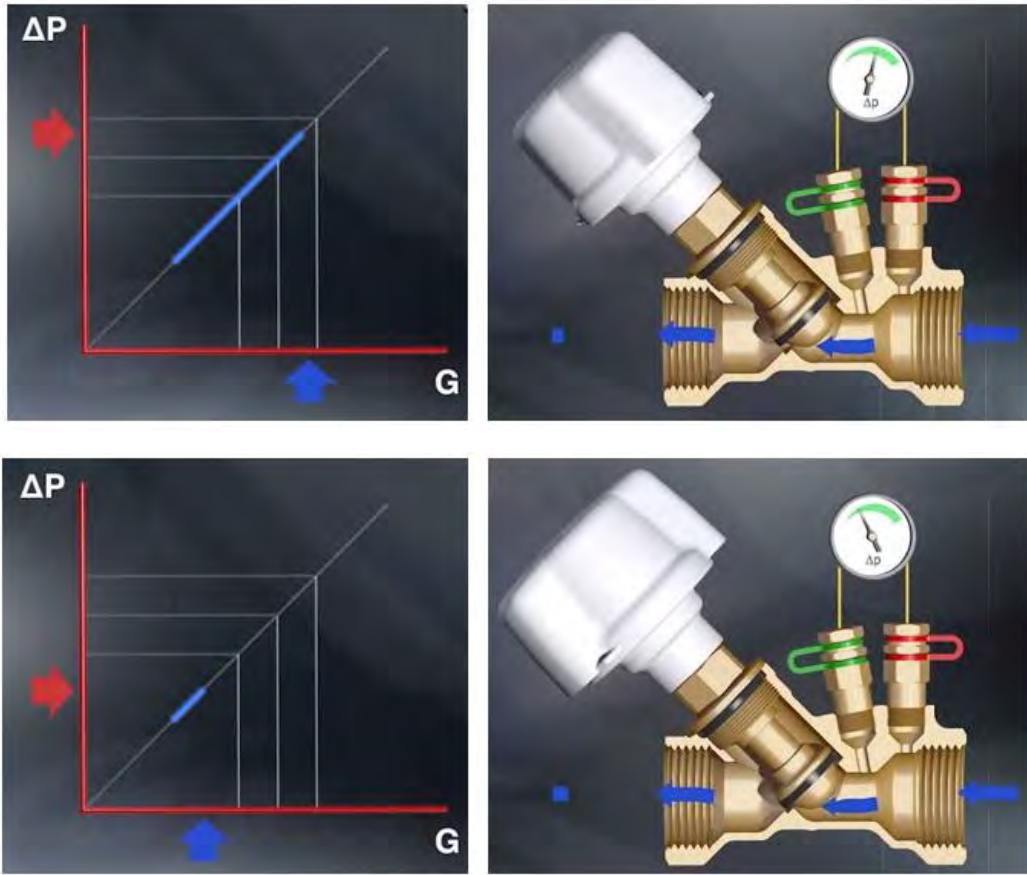

FIGURE 63 Mode of operation of a manual balancing valve

As we can see, when the flowrate needs to be raised, the knob will be manually rotated in order to extend the orifice-pass-area, and thus reduce the flow resistance. Conversely, when the flowrate needs to be lowered, the knob will be manually rotated in the opposite direction, causing the orifice-pass-area to reduce and thus increasing the flowrate.

Usually these valves are mounted on the return branch of the circuit, right after the emitter they have to control.

Another type of static balancing valve is the built-in flowmeter manual valve. The flow meter with magnetic movement indicator is initially used to set up the reference flowrate. To adjust the flowrate the flow meter control stem has to be rotated. This will allow the fluid to flow inside the flowmeter and thus to compress the spring. After the spring has lifted to its maximum value, the ball valve has to be manually rotated to stretch the spring till the value equivalent to the reference flowrate.

The flowmeter balancing valve and it's working principle are depicted in figure 64.

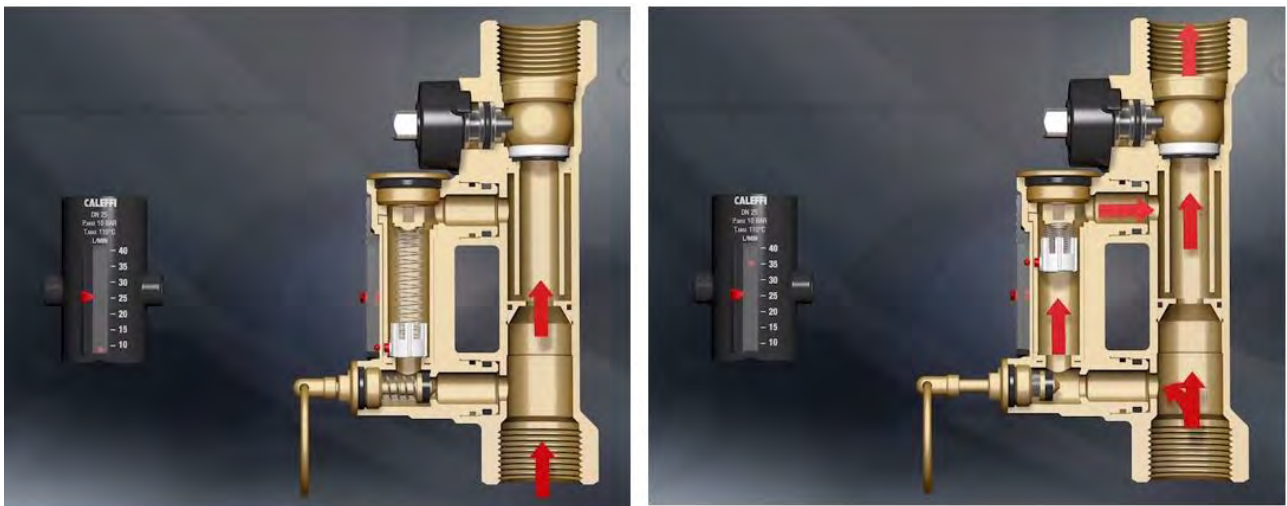

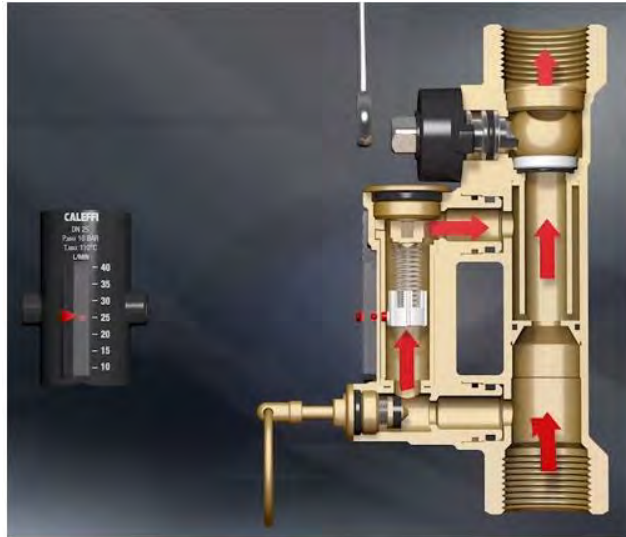

**FIGURE 64** Working principle of a flowmeter valve: setting the reference flowrate, let the spring lift to its maximum value and finally adjust the spring position the desired position

This kind of valve is usually applied in the supply branch.

### 5.2.1.3. Differential pressure control valves

Differential pressure control can solve several operating problems in hydronic system, especially in variable flow systems. The two most common problems are:

- When a control valve is subjected to a too high differential pressure, it cannot shut and may also produce noise. The differential pressure control can limit the differential pressure to a suitable level;
- When a balancing valve is subjected to large variations in differential pressure, the valve authority may drop so much that the control became unstable. Differential pressure control can assure that the authority will remain in an acceptable range.

The differential pressure control valves are used to maintain a constant differential pressure across the valve regardless the flow rate through it.

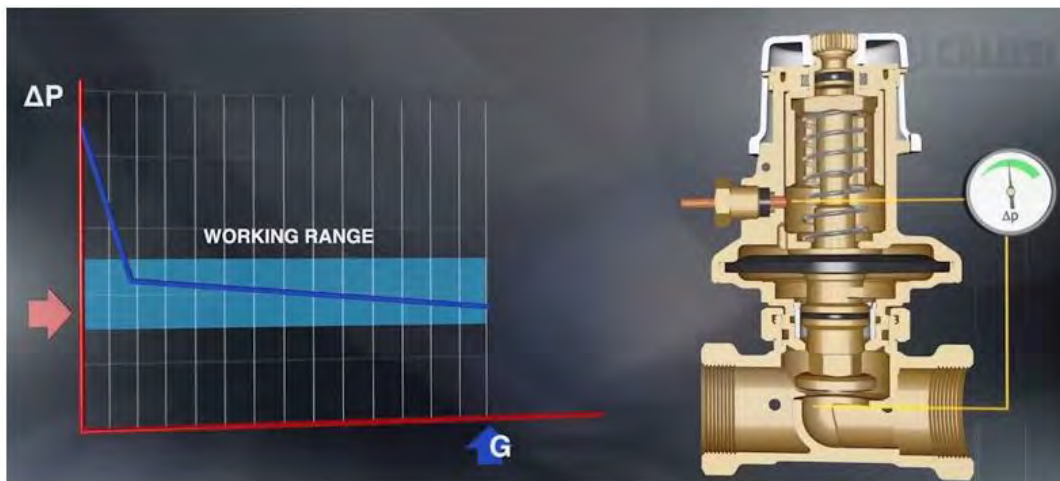

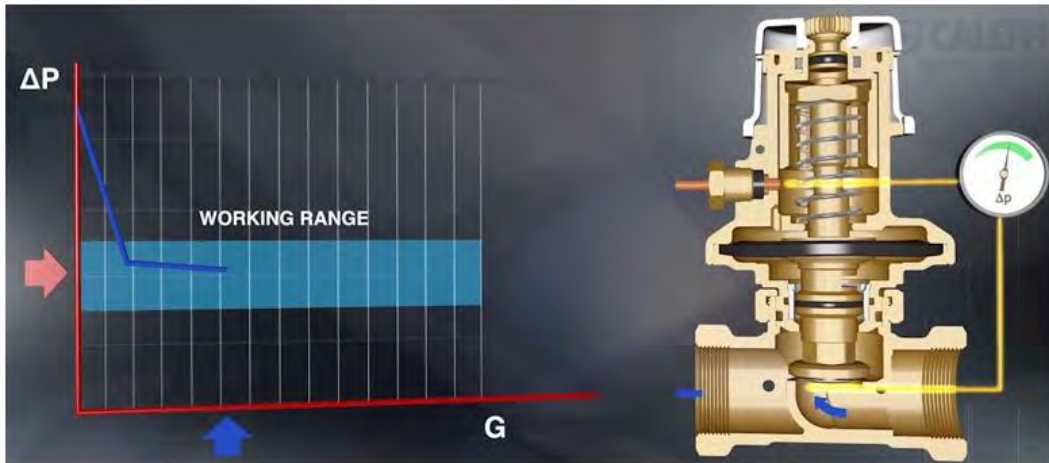

FIGURE 65 Working principle of a DPCV

To be able to read the pressure in both supply and return pipe a typical dpcv consists of two different bodies, each one with a regulating knob with a graduated scale, hooked up by an impulse cable. Each body is provided with an arrow to assure a correct set up. Figure 66 report an illustration of a dpcv.

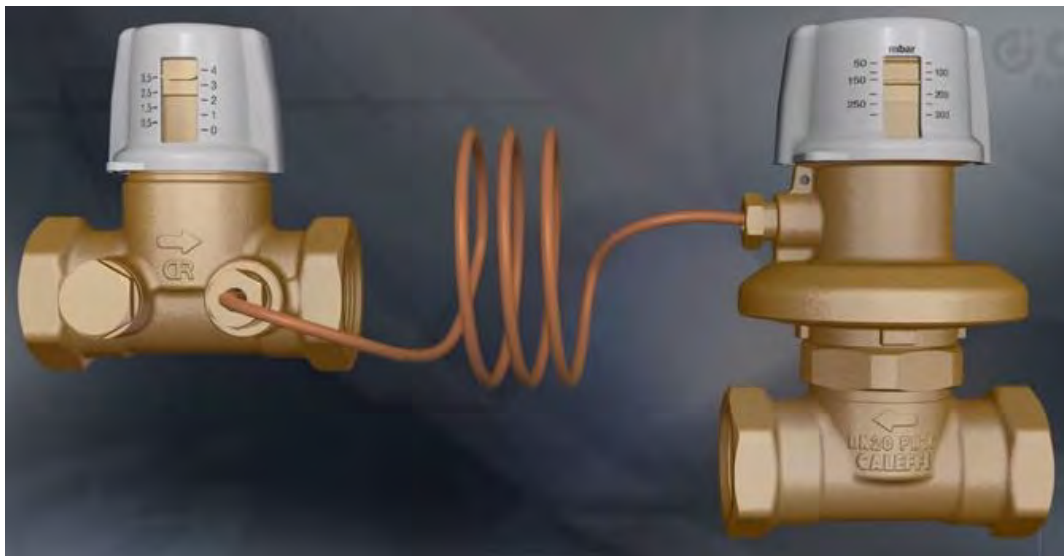

FIGURE 66 Differential pressure control valve

### 5.2.2. Hydraulic separator

A hydraulic separator is a device that allows separating a circuit in two hydraulically independent sections: the primary circuit, usually the one with the heat source, and the secondary circuit, usually the one with the loads.

Having two independent circuits will help solving problems regarding variation in circuit pressure and flowrates. To understand why there might be such issues in a circuit let's consider the system in figure 67.

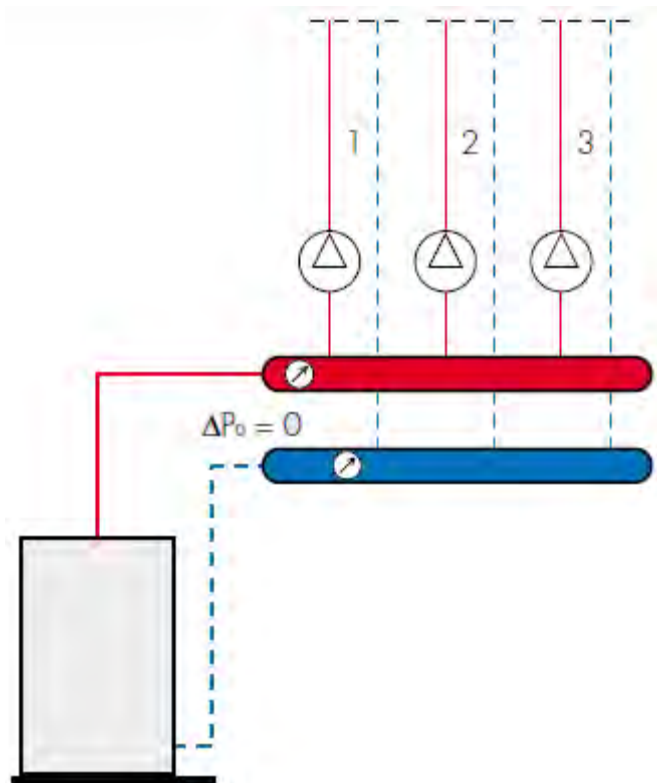

FIGURE 67 System with a boiler and three circulating pumps

When the pumps are all turned off there is no pressure difference between the two manifolds.

If the first pump is turned on the pressure difference between the two manifolds will increase. This increase is equal to the pressure that the pump has to win in order to let the fluid circulate through the boiler. The same increase also subsists in the crossovers with the pumps turned off, and thus, in the branches number 1 and 2, the fluid might flow in reverse direction: from the return to the supply manifold.

When the second pump is powered up, to allow the fluid circulate in the right direction, it has first to win the reverse pressure difference caused by the first pump. Moreover, since it increase the flow rate through the boiler, turning on the second pump will also increase the pressure difference between the two collectors.

When the last pump is turned on it has to win the reverse pressure created by the other two pumps.

Having high pressure difference between the two manifolds may lead to various issues:

- If there are both little and big pumps installed in the circuit, the little pumps may not be able to overcome the pressure difference caused by the big pumps. The fluid in their branches will therefore flow in reverse direction.
- Interferences between non-hydraulically independent circuits may force the pumps to work in non-design condition, that is with low efficiency and with the possibility to burn the pump.
- If the reverse pressure difference caused by the active pumps is not overcome there may be reverse flow in the heat emitter. They will be irregularly warmed, causing discomfort in the conditioned environment.

Hydraulic separators can solve all this issues. A system with an installed hydraulic separator is shown in picture 68.

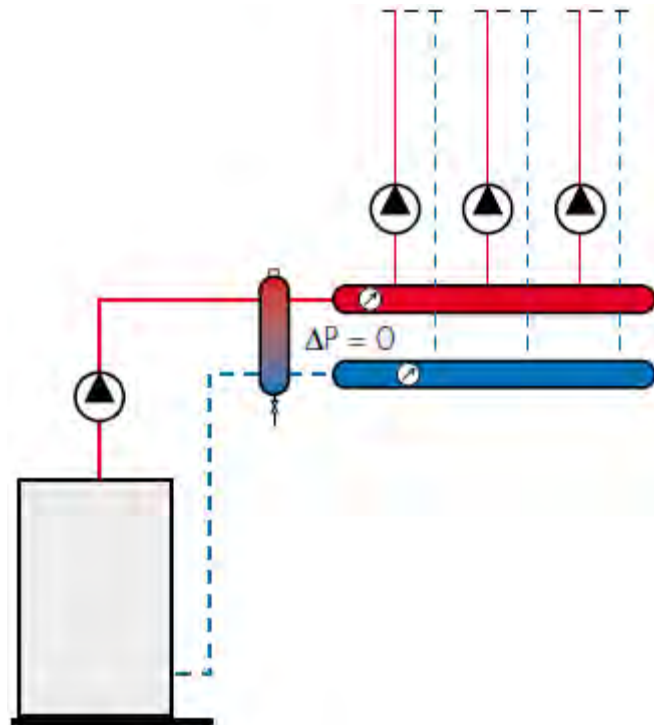

FIGURE 68 System with hydraulic separator

In this system the pressure difference between the two manifolds will always be around zero. The explanation is really simple: the pressure difference between the manifolds is the pressure that the pumps have to overcome to allow the fluid flowing from the return to the supply manifold. To do that the fluid has to pass through the hydraulic separator, which is no more than a wide pipe with very low pressure drop. This means that the pumps have to overcome the pressure drop across the hydraulic separator, which is nearly zero.

In other words, the hydraulic separator creates a zone with a low pressure loss, which enables the primary and secondary circuit to be hydraulically independent of each other; the flow in one circuit will not create a flow in the other one.

This means that there will be flow in the secondary circuit only if the pumps are on, permitting the system to meet the specific requirements at that time. When the pumps are off the whole flowrate will bypass the secondary circuit through the hydraulic separator. The working principle of a hydraulic separator is shown in figure 69.

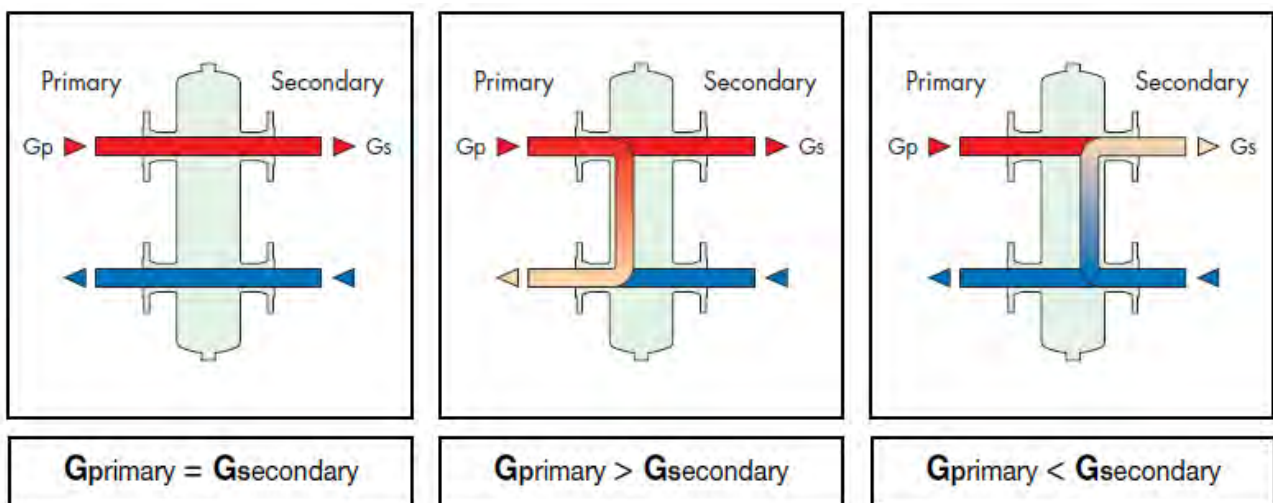

FIGURE 69 Three possible working conditions of a hydraulic separator

With a hydraulic separator it is thus possible to have a constant flowrate primary circuit and a variable flowrate secondary circuit. These operating conditions are nowadays common in both heating and air-conditioning systems.



## 6. PRACTICAL EXAMPLE OF HYDRAULIC BALANCING

### 6.1. The system

In this chapter it will be presented a practical example of hydraulic balancing concerning an existing system. The plant under consideration is the heating system of a shopping center, provided with 8 fan coil units with a heating power of 6 kW each and 4 door curtain units of 17 kW each. The supply temperature is 70°C and the return temperature is 55°C. The pipes are made of steel, and each emitter involves a pressure drop of 5 kPa. For the pipes a maximum linear pressure drop of 150 Pa/m has been set. The available balancing valves are STAD, for diameters smaller than 65 cm, and STAF, for diameters bigger than 65 cm. The model of the shopping center with its heating system is illustrated in picture 70.

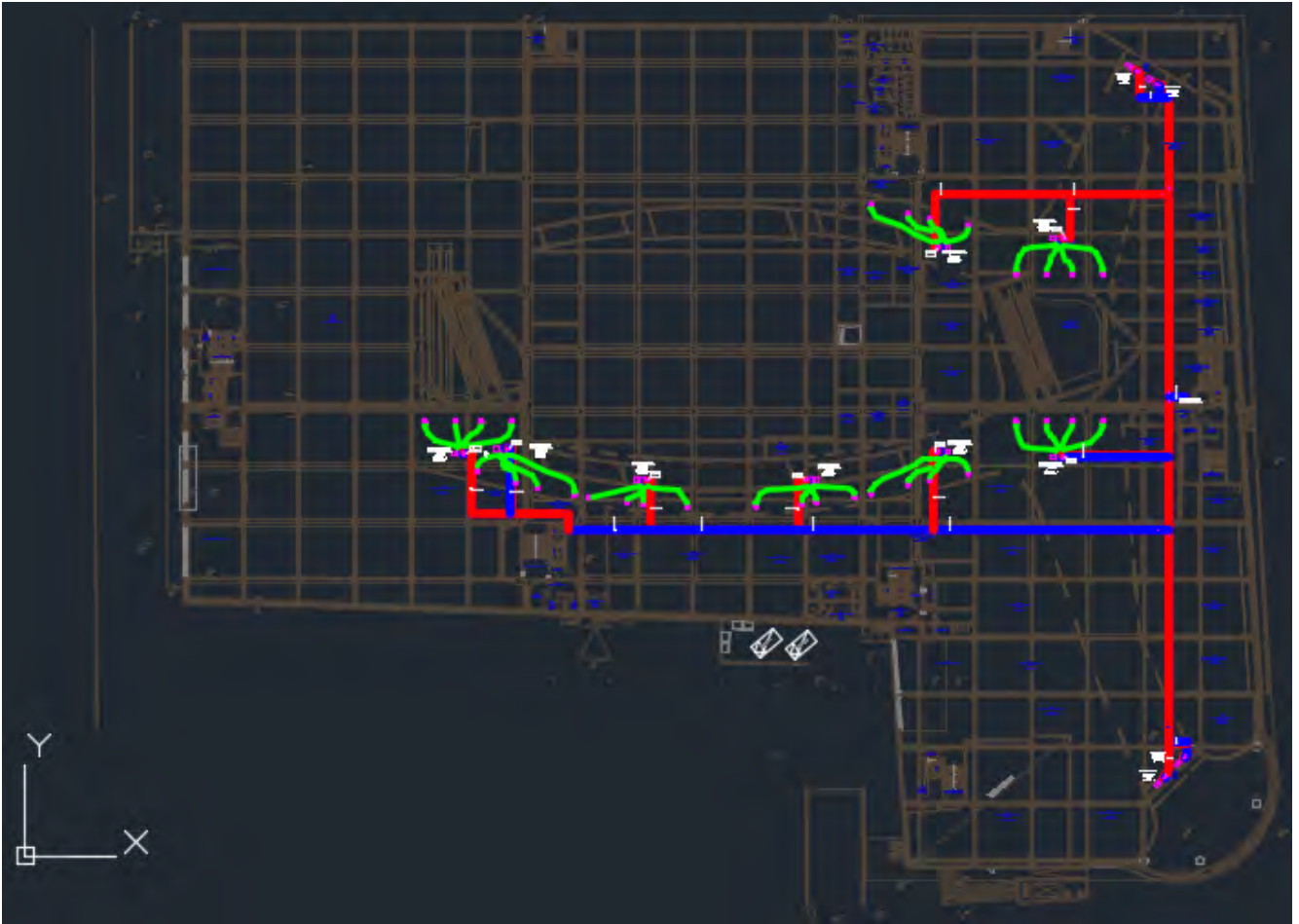

FIGURE 70 Model of the shopping center with his own heating system

### 6.2. Balancing the system

The first step to do is to evaluate the flow rate through the emitters. This can be done with this simple equation:

$$\dot{Q} = \dot{m}c_p(T_{in} - T_{out})$$

Where  $c_p$  is the specific heat of the water (4186,8 J/kg\*K),  $T_{in}$  is the supply temperature and  $T_{out}$  is the return temperature.

Emitter	Q <sub>heat</sub> [W]	ΔT [k]	m [kg/s]	m [l/h]
Fan Coil	6000	15	0,0955384	343,9
Door Curtain	17000	15	0,270692	974,4

TABLE 6 Flow rate calculation

Knowing the flow rate in the pipes is pretty easy: the pipe directly linked with the emitter will obviously have the same flow rate as the emitter. When two pipes connect together the flow rate of the main pipe will be the sum of the flow rates of the two branch pipes. With this procedure is easy to calculate the flow rate in all the piping system, from the boiler till the farthest emitter.

The second step is to calculate the diameter of the pipes, which will allow determining the linear pressure drop in the piping system.

Since we know only the maximum allowable pressure drop an assumption has to be made. We have decided to assume the diameter of the pipe referring to diagrams provided by Caleffi S.p.A.. In these diagrams on the x-axis are reported the pressure drops, on the y-axis the flow rates, and there are also diagonal lines reporting the diameters of the pipes (red lines) and the velocity of the fluid (blue lines). The diagram that has been used, which is specific for steel pipes, is pictured in figure 71.

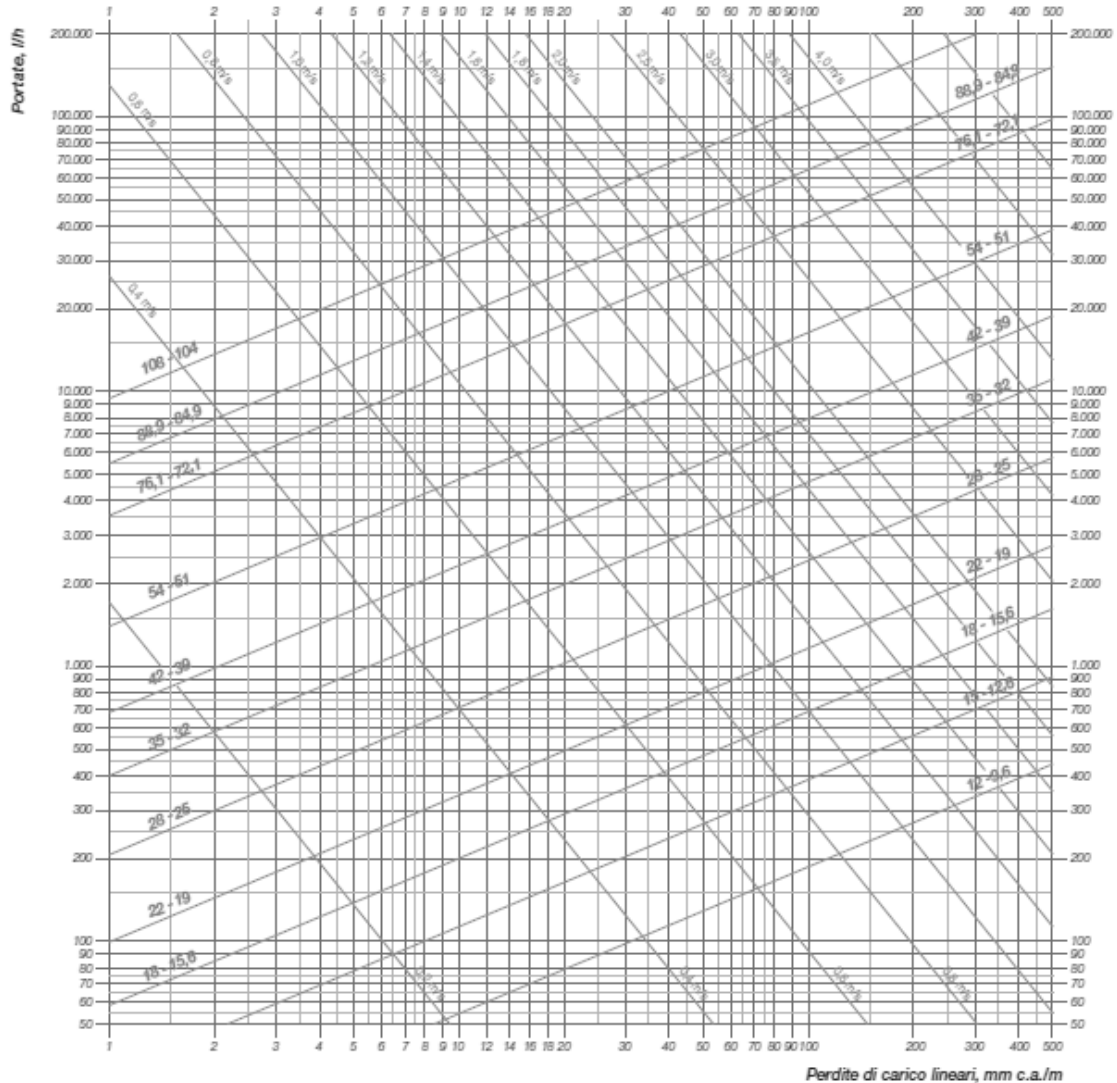

FIGURE 71 Technical diagram of pressure drop-flow rate

The pipeline has been divided in several sections, each of them with his own flow rate. This was necessary since having different flow rates, even with equal diameters, means having different fluid velocities and thus different linear pressure drops.

Once the diameter has been set, the fluid velocity can be evaluated knowing that the flow rate can be written as:

$$\dot{m} = \rho * u * A$$

where u is the fluid velocity and A is the pipe section. That equation can also be rewritten making the pipe diameter explicit:

$$\dot{m} = \rho * u * \frac{\pi D^2}{4}$$

With the fluid velocity the Reynolds number can be estimated. Using the Blasius equation for low surface roughness will let us calculate the linear pressure drop as:

$$\Delta P_{lin} = \rho * \frac{u^2}{2} * f * \frac{L}{D}$$

To calculate the linear pressure drop, the length of the pipe L has been set as 1 m. With these equation the linear pressure drop (major losses) in Pa/m have been evaluated for all the sections forming the piping system.

Unit	m [m3/h]	D [m]	v [m/s]	Re	f	ΔPma [Pa/m]
Fan Coil	0,34	0,019	0,337			
Door Curtain	0,97	0,025	0,552			
O-Boiler	6,65	0,051	0,905	111982	0,017296157	138,77
OP	4,01	0,051	0,546	67575	0,019624093	57,33
PA	3,67	0,051	0,499	61783	0,020068694	49,01
P-FC1	0,34	0,019	0,337	15547	0,02833493	84,75
AB	1,72	0,032	0,594	46156	0,021586327	119,11
BC	1,38	0,032	0,475	36925	0,022824761	80,61
CD	1,03	0,032	0,357	27694	0,024526802	48,72
DE	0,69	0,025	0,389	23632	0,025518859	77,41
B-FC2	0,34	0,019	0,337	15547	0,02833493	84,75
C-FC3	0,34	0,019	0,337	15547	0,02833493	84,75
D-FC4	0,34	0,019	0,337	15547	0,02833493	84,75
E-FC5	0,34	0,019	0,337	15547	0,02833493	84,75
E-FC6	0,34	0,019	0,337	15547	0,02833493	84,75
AX	1,95	0,032	0,673	52310	0,020921332	148,28
X-DC1	0,97	0,025	0,552	33479	0,02339076	142,41
X-DC2	0,97	0,025	0,552	33479	0,02339076	142,41
OQ	2,64	0,039	0,613	58070	0,020382068	98,34
QR	0,69	0,025	0,389	23632	0,025518859	77,41
R-FC7	0,34	0,019	0,337	15547	0,02833493	84,75
R-FC8	0,34	0,019	0,337	15547	0,02833493	84,75
QS	1,95	0,032	0,673	52310	0,020921332	148,28
S-DC3	0,97	0,025	0,552	33479	0,02339076	142,41
S-DC4	0,97	0,025	0,552	33479	0,02339076	142,41

TABLE 7 Major losses calculation, linear major pressure drop

Once the linear pressure drops have been estimated, knowing the length of the pipe from the system sketch, it is possible to calculate the actual pressure drop per each section of the piping system.

Unit	$\Delta P_{ma}$ [Pa/m]	Lenght [m]	$\Delta P_{maj}$ [kPa]
Fan Coil	84,75		
Door Curtain	142,41		
O-Boiler	138,77	2,39	0,66
OP	57,33	8,37	0,96
PA	49,01	10,46	1,03
P-FC1	84,75	15,21	2,58
AB	119,11	33,31	7,94
BC	80,61	19,29	3,11
CD	48,72	21,05	2,05
DE	77,41	22,04	3,41
B-FC2	84,75	11,88	2,01
C-FC3	84,75	8,43	1,43
D-FC4	84,75	7,73	1,31
E-FC5	84,75	10,13	1,72
E-FC6	84,75	15,63	2,65
AX	148,28	30,17	8,95
X-DC1	142,41	5,44	1,55
X-DC2	142,41	5,14	1,46
OQ	98,34	28,9	5,68
QR	77,41	13,99	2,17
R-FC7	84,75	7,64	1,29
R-FC8	84,75	27,6	4,68
QS	148,28	26,15	7,76
S-DC3	142,41	2,24	0,64
S-DC4	142,41	6,87	1,96

TABLE 8 Major losses calculation, actual major pressure drop

To evaluate the minor losses the method described by Caleffi has been used. To each emitter has been assigned a local pressure drop of 5 kPa.

Unit	v [m/s]		$\Delta P_{min}$ [mm c.a.]	$\Delta P_{min}$ [kPa]
Fan Coil	0,337			
Door Curtain	0,552			
O-Boiler	0,905	6	241	2,36
OP	0,546	1	16	0,16
PA	0,499	1	12	0,12
P-FC1	0,337	1	7,2	0,07
AB	0,594	2,5	53	0,52
BC	0,475	1	11	0,11
CD	0,357	1	6,4	0,06
DE	0,389	3,5	29	0,28
B-FC2	0,337	1,5	14	0,14
C-FC3	0,337	1,5	14	0,14
D-FC4	0,337	1,5	14	0,14
E-FC5	0,337	1,5	14	0,14
E-FC6	0,337	2,5	17	0,17
AX	0,673	1,5	0,9	0,01
X-DC1	0,552	1,5	31	0,30
X-DC2	0,552	2,5	47	0,46
OQ	0,613	0	0	0,00
QR	0,389	0,5	7,2	0,07
R-FC7	0,337	1	5,7	0,06
R-FC8	0,337	1,5	11	0,11
QS	0,673	1	23	0,23
S-DC3	0,552	1,5	31	0,30
S-DC4	0,552	2,5	47	0,46

TABLE 9 Minor losses calculation

Once both the minor and the major losses are known, the total pressure drops are simply the sum of them.

Unit	$\Delta P_{maj}$ [kPa]	$\Delta P_{min}$ [kPa]	$\Delta P_{tot}$ [kPa]
Fan Coil			
Door Curtain			
O-Boiler	0,66	2,36	3,03
OP	0,96	0,16	1,12
PA	1,03	0,12	1,14
P-FC1	2,58	0,07	7,65
AB	7,94	0,52	8,46
BC	3,11	0,11	3,22
CD	2,05	0,06	2,11
DE	3,41	0,28	3,70
B-FC2	2,01	0,14	7,15
C-FC3	1,43	0,14	6,57
D-FC4	1,31	0,14	6,45
E-FC5	1,72	0,14	6,85
E-FC6	2,65	0,17	7,82
AX	8,95	0,01	8,96
X-DC1	1,55	0,30	6,85
X-DC2	1,46	0,46	6,92
OQ	5,68	0,00	5,68
QR	2,17	0,07	2,24
R-FC7	1,29	0,06	6,35
R-FC8	4,68	0,11	9,79
QS	7,76	0,23	7,98
S-DC3	0,64	0,30	5,94
S-DC4	1,96	0,46	7,42

TABLE 10 Total pressure drops calculation

The goal of this procedure is to find the most unfortunate emitter. It will be that emitter that involves the greatest pressure drop between itself and the boiler. The head pump will be equal to this pressure drop. Therefore, for each emitter, we have to sum the total pressure drop of those sections that connect that emitter to the boiler.

Unit	$\Delta P$ [kPa]
Fan Coil 1	11,79
Fan Coil 2	20,89
Fan Coil 3	23,53
Fan Coil 4	25,52
Fan Coil 5	29,63
Fan Coil 6	35,99
Fan Coil 7	17,30
Fan Coil 8	20,73
Door Curtain 1	24,05
Door Curtain 2	21,17
Door Curtain 3	22,63
Door Curtain 4	24,11

TABLE 11 Pressure drop between emitters and boiler

As we can easily see the most unfortunate emitter is the fan coil number 6, which involves a pressure drop of 35,99 kPa. The balancing valve before this emitter will then be set in fully open position. The pumps features will then be:

- Flow rate:  $8 * \dot{m}_{FC} + 4 * \dot{m}_{DC} = 6,65 \frac{m^3}{h}$
- Head pump : 35,99 kPa

where  $m_{FC}$  is the flow rate through the fan coil and  $m_{DC}$  is the flow rate through the door curtain.

It must be remembered that even if the valve is in fully open position, it involves a local pressure drop, which depends of the type of valve that is being using.

To get the balancing position of the other balancing valves the HyTools<sup>9</sup> android software has been used. This program, once we insert the flow rate through the valve, will tell us the most suitable type of valve for our application. After that, if we insert in the software the pressure drop we need across the valve, it will reply to us with the position of the control knob we have to set in order to have a balanced system, where all the emitter have the proper flow rate. With this procedure we found that:

Unit	Missing $\Delta P$ [kPa]	m [m3/h]	Bal. Valve	Valve Position
Fan Coil 1	24,19	0,34	STAD 10/09	2,83
Fan Coil 2	15,09	0,34	STAD 10/09	3,07
Fan Coil 3	12,46	0,34	STAD 10/09	3,16
Fan Coil 4	10,47	0,34	STAD 10/09	3,26
Fan Coil 5	6,36	0,34	STAD 10/09	3,68
Fan Coil 6	0,00	0,34	STAD 10/09	4 (fully open)
Fan Coil 7	18,69	0,34	STAD 10/09	2,96
Fan Coil 8	15,25	0,34	STAD 10/09	3,06
Door Curtain 1	11,94	0,97	STAD 20	2,51
Door Curtain 2	14,82	0,97	STAD 20	2,36
Door Curtain 3	13,35	0,97	STAD 20	2,43
Door Curtain 4	11,88	0,97	STAD 20	2,51

TABLE 12 Balancing valves type and position

As we could easily predict all the valves are STAD, since the diameter of the pipes is always smaller than 65 cm, and the lower the pressure drop that the valve has to add, the closer will be the knob position to fully open position. As the software told us, the STAD 10/09 valve, when in fully open position, involves a pressure drop of 5,4 kPa, which has been added to the total pressure drop of the fan coil number 6 before computing all the other total pressure drop of the other emitters and thus to the pump head.

The pump features are then:

m [m3/h]	Head [kPa]	Power [W]
6,65	35,99	73,90

TABLE 13 Pump characteristics with fan coil system

### 6.3. The unbalanced system

It can be interesting to study what happen if the balancing system is disregarded, that is, when the balancing valves are all in open position.

The obvious consequence, having a wrong pressure drop between the boiler and the emitters, is the different flow rate that will pass through the emitters. Some emitters will have a too low flow rate, which will cause a too low inner

<sup>9</sup> <http://www.imi-hydronic.com/en/knowledge-tools/hydronic-tools-software/introducing-hytools/>

temperature. Conversely some other emitters will have a too high flow rate, which will cause a too high inner temperature.

It must always be remembered that the radiator characteristic is not linear, thus, the effect on the inner temperature of a too high and of a too low flow rate will not be of the same amount.

The correct procedure to follow would be an iterative calculation, since to know the new flow rate through the emitters we have to know the new pressure drop in the pipes, which depends on the velocity of the fluid, which in turn depends on the flow rate.

In order to make the calculation easier we will use some approximations. First of all we consider that the flow rate at the pumps remains constant, which is obviously not true since having all the balancing valves in fully open position means that there will be a different pressure drop among the pipes (lower) and thus a different system characteristic, so the duty point, and the flow rate with it, will change.

The second approximation is that the pressure drop among the pipes doesn't change with the flow rate: this allows us to compare the piping system before and after the valves opening, and lets us calculate the new flow rate through the pipes.

The starting point will be the pump, of which we know the flow rate thanks to previous calculations.

$$\dot{V}_{pump} = 6,65 \frac{m^3}{h}$$

The second step is to consider the first branch point after the pump where the flow rate splits up into two. We know that the sum of the two branches flow rate is equal to the pump flow rate.

$$\dot{V}_{branch1} + \dot{V}_{branch2} = \dot{V}_{pump}$$

Per each branch we also know the pressure drop, thanks to our second approximation, and the flow rate through it when the valves were in the working position. Knowing that the pressure drop is a square function of the flow rate and that the branch with the lower pressure drop will have the major flow rate we can also write that:

$$\frac{H_{branch1}}{H_{branch2}} = \left( \frac{\dot{V}_{branch2}}{\dot{V}_{branch1}} \right)^2$$

Repeating this simple procedure for all branch points in the piping system will be possible to calculate the flow rate through all the emitters. The final results are shown in table 13.

Unit	Prev. flow rate [m <sup>3</sup> /h]	New flow rate [m <sup>3</sup> /h]	Gain-Loss [m <sup>3</sup> /h]
FC1	0,34	1,864	1,524
FC2	0,34	0,295	-0,044
FC3	0,34	0,134	-0,206
FC4	0,34	0,060	-0,280
FC5	0,34	0,026	-0,314
FC6	0,34	0,025	-0,315
FC7	0,34	0,948	0,608
FC8	0,34	0,849	0,509
DC1	0,97	0,341	-0,628
DC2	0,97	0,341	-0,629
DC3	0,97	0,901	-0,069
DC4	0,97	0,864	-0,106

TABLE 14 Results of unbalanced system on the flow rate



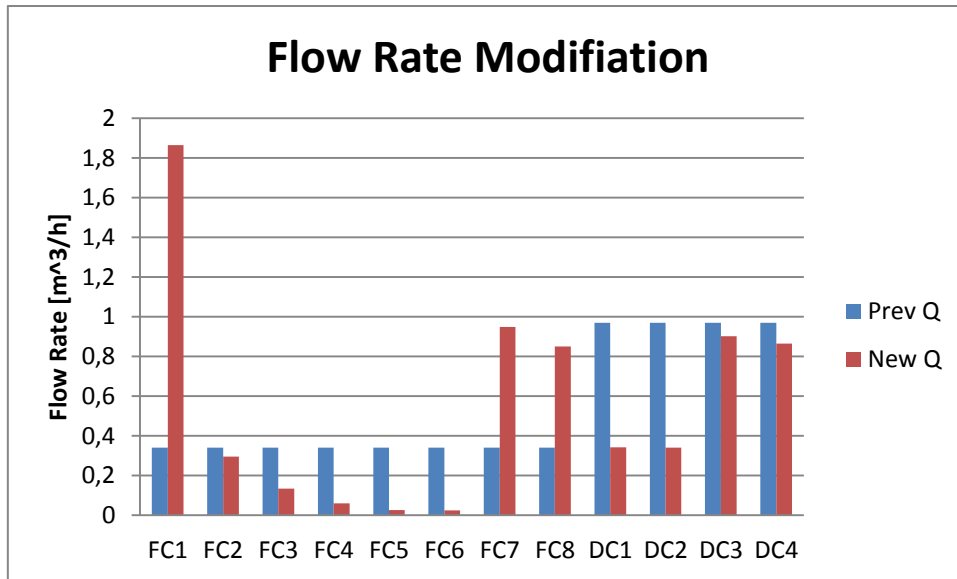

FIGURE 72 Flow rate modification

As we could expect the nearest emitter to the boiler (FC1) presents now the greatest flow rate, while the farthest emitter (FC6) has now the lowest flow rate.

Once we know the new flow rate, using software provided by Schako, the fan coil and door curtain manufacturer, we are able to calculate the new heat output and thus the new return temperature in each emitter.

Unit	New flow rate [m³/h]	New Heat Output [kW]	New Ret. T [°C]
FC1	1,864	7,21	66,7
FC2	0,295	5,84	53,2
FC3	0,134	4,51	41,5
FC4	0,060	2,74	30,8
FC5	0,026	1,37	24,7
FC6	0,025	1,32	24,6
FC7	0,948	6,92	63,8
FC8	0,849	6,96	63,1
DC1	0,341	12,07	39,7
DC2	0,341	12,07	39,7
DC3	0,901	16,8	54,1
DC4	0,864	16,66	53,5

TABLE 15 Results of unbalanced system on return temperature

In figure 72 we can see the enormous variation in the heat output.

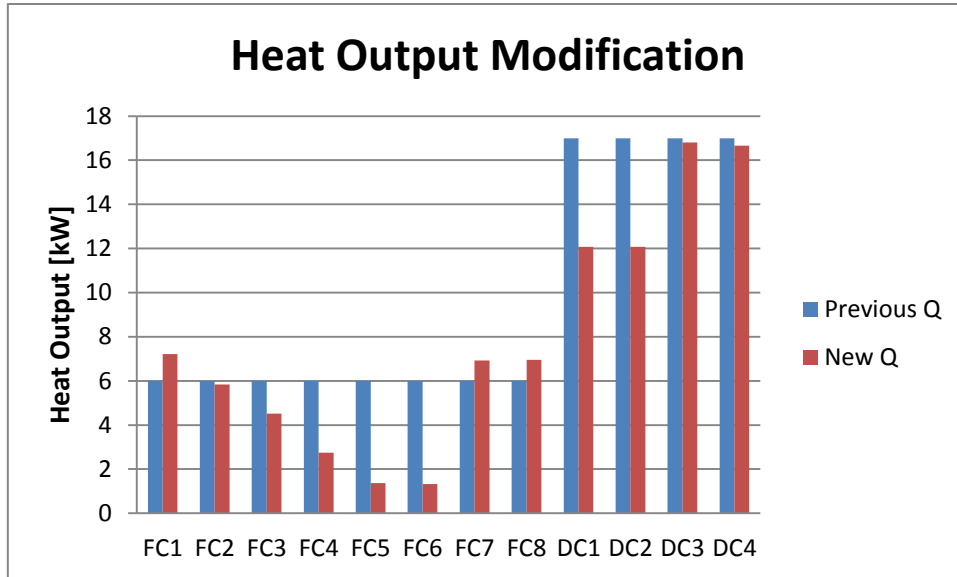

**FIGURE 73**Heat output modification

The software bases its calculation on three equations. The first one is the heat carrier cooling in the terminal:

$$Q = \dot{V}c_p(T_{in} - T_{out})$$

where  $T_{in}$  and  $T_{out}$  are respectively the inlet and exit fluid temperature in the emitter. The second equation is the heat transfer equation between the heat carrier and the room air:

$$Q = KA\Delta T_{ml}$$

where the mean logarithmical temperature difference  $\Delta T_{ml}$  is:

$$\Delta T_{ml} = \frac{T_{in} - T_{out}}{\ln\left(\frac{T_{in} - T_i}{T_{out} - T_i}\right)}$$

where  $T_i$  is the inner room temperature. The last equation is the heat loss equation for the room:

$$Q = \sum UA(T_i - T_e) + \sum l\Psi(T_i - T_e) + V * n * c_{p_{air}}\rho_{air}(T_i - T_e)$$

where  $T_e$  is the outside temperature. The first term is the heat exchange between the walls and the outside air, the second one is the heat transfer due to thermal bridges and the last one is the heat loss due to air currents coming into the room from the outside environment.

The system based on these three equations can be solved only by iterative methods. The equations are in effect influenced by these three parameters:

- The return temperature of central heating system, which affects the first and second equations;
- The indoor temperature, which affects the second and the third equations;
- The mass flow, which affects the second equation.

As we expected, both the heat output and the return temperature rise in those emitters where the flow rate have had a boost. While the boost in the heat output can be explained with the increasing heat exchange factor, the boost in the return temperature is due to the less time that the single water particles spend inside the emitter.

## 7. UNDERFLOOR HEATING SYSTEM

In this last chapter the entire heating system will be substituted by an underfloor heating system. Only the door curtains will not be modified. The goal is to compare the two different systems and to determine which one involves bigger electricity consumption and bigger boiler generation performance.

### 7.1. Design of the underfloor heating system

To make a fair comparison we will consider the same total heating power used for the fan coils, that is 48 kW. Since 48 kW are not enough to heat up all the surface of the mall we'll consider only a part of the floor, which will allow us to have a specific heating power around 40 kW/m<sup>2</sup>, which is the typical power range for this kind of heating systems.

The typical equation for an underfloor heating system specific power is:

$$q = K_h \Delta \vartheta_h$$

where the unit of measure of q is W/m<sup>2</sup>, K<sub>h</sub> is the heat exchange coefficient, usually provided by the system manufacturer, and Δϑ<sub>h</sub> is a logarithmic temperature difference. Since we were not in contact with a manufacturer the value of K<sub>h</sub> has been supposed.

Qtot [W]	Area [m <sup>2</sup> ]	Qspec [W/m <sup>2</sup> ]	Kh [W/K*m <sup>2</sup> ]	Δϑh [K]
48000,00	1152,90	41,63	3,90	10,68

TABLE 16 Underfloor heating system specific power

Knowing the K<sub>h</sub> allows us to calculate the average water temperature in the underfloor circuits:

$$\overline{\vartheta_w} = \vartheta_i + \Delta \vartheta_h$$

where ϑ<sub>i</sub> is the inner room temperature.

A typical underfloor heating system has a temperature difference between the supply and the return of 5 or 6 degrees, this value is known as σ. If we set this value we can calculate the supply (ϑ<sub>v</sub>) and return temperature (ϑ<sub>r</sub>) using the average water temperature ϑ<sub>w</sub>. The σ value has been set to 6.

$$\vartheta_v = \overline{\vartheta_w} + \frac{\sigma}{2}$$

$$\vartheta_r = \overline{\vartheta_w} - \frac{\sigma}{2}$$

Knowing the temperature difference is then easy to calculate the total mass flow rate in the system.

Δϑh [°C]	ϑw [°C]	ϑv [°C]	ϑr [°C]	m [kg/s]	m [l/h]
10,68	28,68	31,68	25,68	1,91	6878,76

TABLE 17 Supply and return temperature calculation

The next step is to calculate the portion of floor that will be occupied by each underfloor circuit. To do so we need the specs of the pipes that will be placed underfloor. We have considered a PEX tube with 20 mm of external diameter and 16 mm of internal diameter. The pitch between the tubes is 15 mm. These data can be used in a diagram, as the one showed in figure 72, to calculate the maximum allowable mass flow per circuit, once we have set the allowable pressure loss per meter. In this case we will assume a linear pressure loss of 10 mmH<sub>2</sub>O/m.

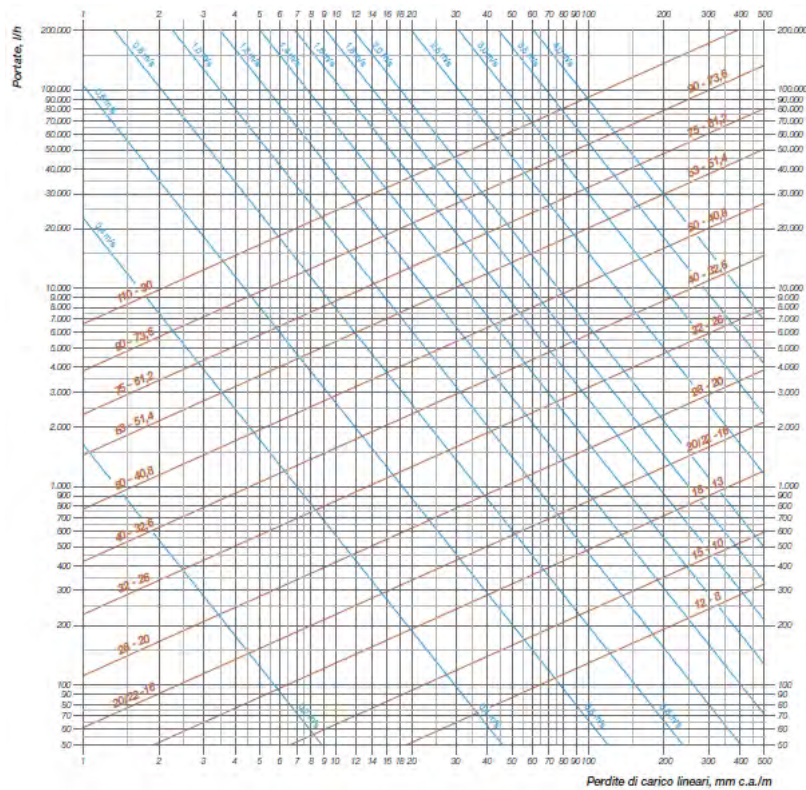

FIGURE 74 Pressure loss in PEX tube

As shown in the diagram, the maximum allowable mass flow rate per each circuit is around 230 l/h. To calculate the length of each circuit we have to set the maximum permissible pressure loss that each circuit must not overtake, which will be 1 mH<sub>2</sub>O.

The length of each circuit will then be:

$$L = \frac{1 \text{ mH}_2\text{O}}{10 \frac{\text{mmH}_2\text{O}}{\text{m}}} = 100 \text{ m}$$

The area occupied by each circuit can be calculated knowing the pitch between each tube:

$$A = \text{Length} * \text{pitch} = 100 * 0,015 = 15 \text{ m}^2$$

The number of circuits we will have to use is:

$$N_c = \frac{\text{Total floor area}}{\text{Circuit area}} = \frac{1152,9}{15} = 76,86$$

Since each manifold is connected to 6 circuits at the same time we will use 12 manifolds connected to 72 circuits in total.

We now have to calculate the pressure loss per each manifold. The pressure loss that involves a manifold, as shown in picture 73, is composed by different terms.

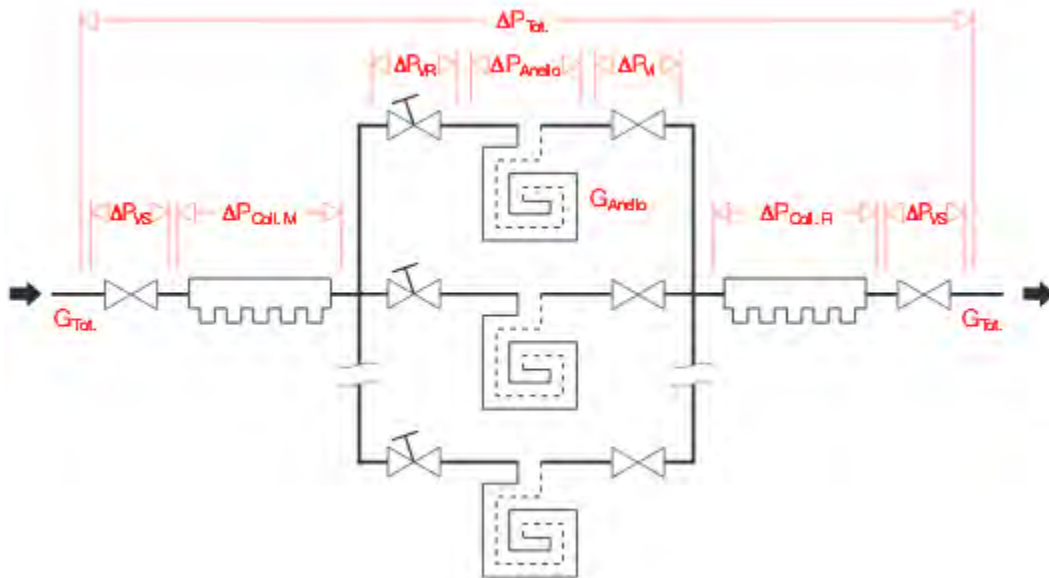

FIGURE 75 Manifold pressure drops

From the supply to the return side we have:

- $\Delta P_{vs}$ : pressure loss in the globe sphere valve;
- $\Delta P_{collM}$ : pressure loss in the supply manifold;
- $\Delta P_{vr}$ : pressure loss in the regulation valve;
- $\Delta P_{Anello}$ : pressure loss in the underfloor circuit;
- $\Delta P_{vi}$ : pressure loss in the interception valve;
- $\Delta P_{collR}$ : pressure loss in the return manifold.

The pressure drops have been evaluated with this equation:

$$\Delta P = \frac{\dot{m}^2}{K_v^2}$$

where  $K_v$  represents the mass flow rate through the device which causes a pressure drop of 1 kPa. This value is provided by the manufacturer of the manifold. Per each manifold we thus find that the pressure drop is 12,74 kPa.

$G_{tot}$ [l/h]	573,23
$\Delta P_{circ}$ [kPa]	10,00
$\Delta P_{vr}$ [kPa]	1,55
$\Delta P_{vi}$ [kPa]	0,85
$\Delta P_{collM}$ [kPa]	0,17
$\Delta P_{collR}$ [kPa]	0,17
$\Delta P_{vs}$ [kPa]	0,01

TABLE 18 Manifold pressure drop calculation

We now have to evaluate the pressure drop between the manifold and the boiler. This is necessary to calculate the head of the circuit pump. To do so a sketch of the system has been drawn, that is represented in picture 74. This is not the only way to design the plant, it has been chosen due to its simplicity.

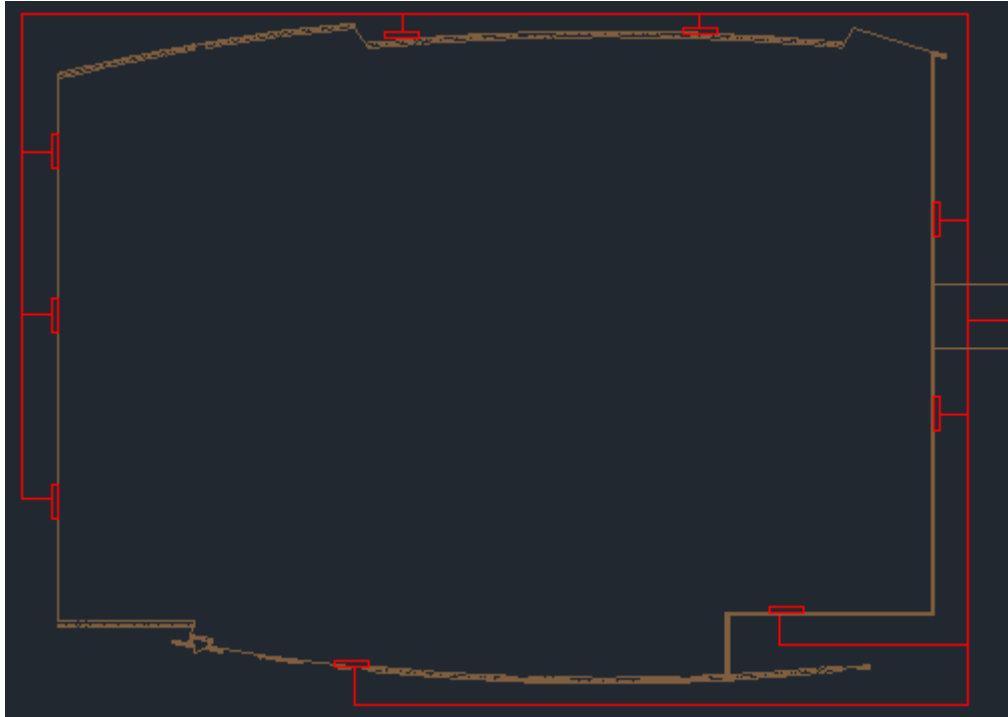

FIGURE 76 Sketch of the underfloor heating circuit piping system

With this scheme we can now calculate the pressure drop of the most unfortunate manifold in the same way we have previously calculated the pressure drop for the most unfortunate emitter. The final results are:

Unit	$\Delta P$ [kPa]
M1	16,46
M2	23,18
M3	30,58
M4	35,02
M5	35,76
M6	37,55
M7	16,36
M8	17,19
M9	23,83

FIGURE 77 Manifold total pressure drops

The most unfortunate manifold is the farthest manifold, the number 6, which is the one in the bottom left corner of the area.

In this case, the pump features are:

$\dot{V}$ [m <sup>3</sup> /h]	Head [kPa]	Power [W]
6,88	37,55	79,77

TABLE 19 Pump characteristics with underfloor heating system

## 8. COMPARISON BETWEEN FAN COIL SYSTEM AND UNDERFLOOR HEATING SYSTEM

In this last chapter we will compare the two heating system that have been discussed in the previous chapters. To do so we need a parameter we can use to compare the two systems. This parameter is the load factor  $F_c$ . The load factor is the ratio between the difference of the average internal and external temperature (which represents, when multiplied for the days in a month, the degrees day) and the difference of design internal and external temperature.

$$F_c = \frac{\bar{T}_{est} - T_{int}}{T_{des,est} - T_{int}}$$

Since we had no access to the Hungarian UNI EN standards we referred to the website [woitalia.it](http://woitalia.it) where daily average temperature can be found from 1980 till today. Using the data from this website we can calculate the daily monthly average temperature per each month as the mean between maximum and minimum daily temperature.

The design internal temperature has been set to 18 °C, while the design external temperature to -10°C. These two values have been chosen referring to personal experience and not to a standard because we had no access to it.

The calculation of the load factor is depicted in table 20.

Month	Tmax [°C]	Tmin [°C]	Tav [°C]	DD	Tdesign_est [°C]	FC	Working hours
Jen	2,10	-4,60	-1,25	578	-10	0,69	288,75
Feb	4,30	-2,80	0,75	518	-10	0,62	258,75
Mar	10,50	1,20	5,85	365	-10	0,43	182,25
Apr	17,30	6,30	11,80	186	-10	0,22	93,00
May	22,20	11,00	16,60	42	-10	0,05	21,00
Jun	25,40	14,40	19,90	-57	-10	-0,07	-28,50
Jul	27,50	16,20	21,85	-116	-10	-0,14	-57,75
Aug	27,40	15,60	21,50	-105	-10	-0,13	-52,50
Sep	22,00	11,20	16,60	42	-10	0,05	21,00
Oct	16,20	0,63	8,42	288	-10	0,34	143,78
Nov	9,30	1,70	5,50	375	-10	0,45	187,50
Dec	2,60	-3,20	-0,30	549	-10	0,65	274,50

TABLE 20 Load factor and working hours

The load factor is used to calculate the number of hour per month that the system, thus the pump, has to work. It's referred to a normal shift, which begins at 8 am and ends at 10 pm. This means that, to calculate the working hours of the pump we have to multiply the standard shift (14 hours) and the load factor.

The total working hour, considering a heating season, which start in October and ends in April, is 1429. We now can calculate the energy absorption of the pump in the two different systems, which will be the product between the pump power and the working hours.

System	P [kW]	H [h]	E [kWh]
FanCoil	0,07	1428,53	105,57
Uderfloor	0,06	1428,53	86,37

TABLE 21 Pumps electrical absorption

As we can see the electrical absorption in the two cases is not so different and in both cases is quite low. The reason is the little power of the plant, just 48 kW.

## 9. CONCLUSION

In this thesis we have tried to explain why and how a system should be properly balanced. As we have seen, an improper balancing would lead to uncomfortable environment conditions, such as wrong inner temperature, disturbing flow rates through valves and pipes and excessive power consumption due to incorrect flow rates.

A correct balancing procedure starts from the design of the heating/cooling plant and not when the system is already placed. This allows the designer to make the best choices in order to save money thanks to a correct piping and pump design, to get a performing plant and to respect the environment standard policy. Since the balancing procedure itself is not so complicate and all in all quite precise, although it is based on approximations, in my opinion it should be made compulsory for every new system.

Thanks to the practical example, even though is a simplified model on a very simple heating system, is clear how much the performance of our plant, therefore the quality of the environment, is greatly influenced by the correct or wrong balancing of the heating system: the heat output of the fan coil changes from +21% (FC1) to -340% (FC6).

If we really want to elevate the standards of quality living in our houses and inner environment, the hydraulic balancing of the heating/cooling plants cannot be neglected.

With regard to the two systems comparison, even though this is a very simplified case, the fan coil, as expected, shows a greater electrical assumption due to a bigger pump power. It can be also explained analyzing the piping system served by the pump. In the fan coil case the pump supplies both the fan coils and the door curtains, while in the underfloor heating system the door curtains have a separate circulating pump.



## Bibliography

- Alameddine F., Gunnarson A., *An Engineer's Guide for Sizing and Specifying Pressure Independent Control Valves for Building Services*, FlowLine Controls, 2008
- Autoflow Automatic Balancing, FDI Flow Design INC, 2007
- Boysen H., *k<sub>v</sub>: what, why, how, whence?*, Danfoss Technical Paper, 2011
- Eisenberg P., *Cavitation*, Hydronautics Incorporated
- Goodwill I.M., Sleigh P.A., *Fluid Flow in Pipes*, CIVE2400 Fluid Mechanics, January 2008
- Grundfos Handbook, *Pump Handbook*, Grundfos, 2004
- Huebsch W., Munson R., Okiishi H., Young F., *Fundamentals of Fluid Mechanics* Sixth edition, United State of America, Wiley, 2009
- Kiijarvi J., *Darcy friction factor formulae in turbulent pipe flow*, Lunowa Fluid Mechanics Paper, 2011
- KSB Know-how Volume 4, *Pump Control/System Automation*, August 2006
- Siegenthaler J., *Back to Basics: Reversing Course*, January 1, 2007
- Siemens, *Hydraulic in Building Systems*, Siemens Building Technologies
- Sleigh A., *An Introduction to Fluid Mechanics*, University of Leeds, 2001
- Warburton P., *Building Control System*, CIBSE Guide, February 2009
- <http://www.engineeringtoolbox.com/>
- <http://www.spiraxsarco.com/>
- <http://www.caleffi.com>
- <http://www.woitalia.it>