



UNIVERSITÀ
DEGLI STUDI
DI PADOVA

UNIVERSITA' DEGLI STUDI DI PADOVA

Dipartimento di Ingegneria Industriale DII

Corso di Laurea Magistrale in Ingegneria dell'Energia Elettrica

**Use of RTDS to investigate the role of digital substation data
for realising integrated network operator functions.**

Relatore: Prof. Roberto Turri

Correlatore: Dr. Federico Coffele

Laureanda: Laura Bolla 1147844

Anno Accademico 2018/2019

A chi crede in me, sempre.

1 INDEX

2	ACRONYMS.....	7
3	IDEX OF FIGURES.....	9
4	INDEX OF TABLES.....	11
5	ABSTRACT.....	13
6	ANTEFATTO.....	15
7	LITERATURE REVIEW.....	17
7.1	MODERN PROTECTION CONCEPTS.....	17
7.2	MODERN AUTOMATION CONCEPTS.....	19
7.3	DIGITAL SUBSTATION.....	21
7.4	REAL TIME DIGITAL SIMULATOR.....	23
8	RTDS SOFTWARE: RSCAD.....	27
	PROBLEMS.....	28
9	CASE STUDY.....	31
	SOURCES.....	32
	TRANSFORMERS.....	33
	CIRCUIT BREAKERS.....	34
	CABLES.....	35
	OVERHEAD LINES.....	38
	LOADS.....	38
	VALIDATION.....	39
10	DISTANCE TO FAULT.....	41
10.1	SIMPLE REACTANCE METHOD [9].....	45
	GENEAL RELATION.....	45
	APPLICATION.....	45
10.2	TAKAGI METHOD [9].....	49
	GENERAL RELATION.....	49
	APPLICATION.....	49
10.3	MODIFY TAKAGI METHOD [9].....	51
	GENERAL RELATION.....	51
	APPLICATION.....	51
11	POWER FLOW.....	53
	APPLICATION.....	53
	PROBLEM.....	56

12	SAMPLING RATE.....	61
	APPLICATION	62
13	HIL [11][12][13].....	67
	13.1 OVERCURRENT RELAY HIL TESTING.....	67
	TO SET THE RELAY VOLTAGE	69
	TO SET THE RELAY CURRENT	70
	TRIP SIGNAL	70
	SIMULATION	71
14	PROTECTIONS [4], [14].....	75
15	CONCLUSIONS.....	77
16	REFERENCES	79
17	ACKNOWLEDGEMENTS	81
18	RINGRAZIAMENTI.....	83

2 ACRONYMS

DS digital substation
DG distributed generation
IEC International Electrotechnical Commission
IED intelligent electronic devices
HMI human machine interface
RTU remote terminal units
CT current transformer
VT voltage transformer
HV high voltage
WAN wide area network
XML extensible markup language
EIA Electronic Industries Association
MV medium voltage
RTDS Real Time Digital Simulator
EMT electromagnetic transient
RSCAD
HIL Hardware In the Loop
AC alternating current
DC direct current
CSV comma separate values
DNOs distribution network operators
ACSR aluminum conductors steel reinforced
CHIL controller hardware in the loop
PHIL power hardware in the loop
POW point of wave
SR sampling rate

3 IDEX OF FIGURES

Fig. 7.1 Network sections	17
Fig. 7.2 Substation levels	19
Fig. 7.3 Network topology	21
Fig. 7.4 Input output in Rscad.....	23
Fig. 7.5 Example of input output	23
Fig. 7.6 Analysis with Rtds.....	24
Fig. 7.7 Time line.....	24
Fig. 7.8 [7] Model validation	24
Fig. 8.1 Rscad file manager	27
Fig. 8.2 Rscad file manager, draft and runtime.....	27
Fig. 8.3 Rscad library.....	28
Fig. 8.4 Rscad runtime surface.....	28
Fig. 9.1 Network model in draft.....	31
Fig. 9.2 Network representation.....	32
Fig. 9.3 Substation in draft.....	32
Fig. 9.4 Source	33
Fig. 9.5 Transformer	34
Fig. 9.6 Circuit breaker	35
Fig. 9.7 Cable.....	35
Fig. 9.8 [8] Single-phase cable circuit model	36
Fig. 9.9 Load.....	39
Fig. 9.10 Current and voltage for validation	40
Fig. 9.11 Power meters	40
Fig. 10.1 POW	41
Fig. 10.2 Network measures and fault representation.....	42
Fig. 10.3 Fault control logic.....	42
Fig. 10.4 Fault control.....	42
Fig. 10.5 Fault control.....	43
Fig. 10.6 Phase-ground fault current and voltage	46
Fig. 10.7 Phase-phase-ground fault current and voltage.....	47
Fig. 10.8 Phase-phase-phase ground fault current and voltage.....	47
Fig. 11.1 Logic control for power changes	54
Fig. 11.2 Loads power measure in Rscad	55
Fig. 11.3 Power at transformer 10 with Rscad and Simulink	56
Fig. 11.4 Power calculation block and message in Simulink.....	56
Fig. 11.5 Power at transformer scenario1	58
Fig. 11.6 Power at transformer scenario2	58
Fig. 11.7 Power at transformer scenario3	58
Fig. 11.8 Power at transformer scenario4	58
Fig. 11.9 Power at transformer scenario5	58
Fig. 12.1 2 sampling points.....	61
Fig. 12.2 Time step	62
Fig. 12.3 4 sampling points.....	63
Fig. 12.4 Power at transformer 10 SR=1	64
Fig. 12.5 Power at transformer 10 SR=2	64

Fig. 12.6 Power at transformer 10 SR=4	64
Fig. 12.7 Power at transformer 10 SR=8	64
Fig. 12.8 Power at transformer 10 SR=16	65
Fig. 12.9 Power at transformer 10 SR=32	65
Fig. 12.10 Power at transformer 10 SR=64	65
Fig. 13.1 Devices loop	67
Fig. 13.2 Overcurrent relay and amplifier.....	68
Fig. 13.3 All devices connection.....	68
Fig. 13.4 Amplifier logic	68
Fig. 13.5 Connections	69
Fig. 13.6 GTFPI	70
Fig. 13.7 GTFPI in Rscad	71
Fig. 13.8 Active and reactive power on load 10 in Rscad.....	71
Fig. 13.9 Active and reactive power on load 10 in Simulink.....	72
Fig. 13.10 RRL circuit	72
Fig. 13.11 RRL power measure	73
Fig. 13.12 RRL power, current and voltage on T10	74

4 INDEX OF TABLES

Tab. 9.1 Transformers value	34
Tab. 9.2 Network value.....	37
Tab. 9.3 Zero sequence network values	38
Tab. 10.1 Impedance, length and sections of the model	43
Tab. 10.2 Active and reactive power on the loads	44
Tab. 10.3 Fault scenarios	44
Tab. 10.4 Fault voltage and fault current	45
Tab. 10.5 Zero impedance, length and sections of the model.....	45
Tab. 10.6 Variation of fault current	49
Tab. 11.1 Power flow scenario 1.....	57
Tab. 11.2 Power flow scenario 2.....	57
Tab. 11.3 Power flow scenario 3.....	57
Tab. 11.4 Power flow scenario 4.....	57
Tab. 11.5 Power flow scenario 5.....	58
Tab. 12.1 Active and reactive power on the loads	63
Tab. 12.2 Mean value of active power with Rscad and Simulink with different SR.....	65

5 ABSTRACT

This thesis work was carried out, thanks to the Erasmus + for traineeship project, at the PNDC research center, Power Networks demonstration Center, of the University of Strathclyde, in Glasgow, United Kingdom.

This center is among the first in Europe for research on digital substations, systems sensors, network voltage management and ancillary services.

The project I took part in is that concerning digital substations, an innovative topic whose realization leads to numerous advantages.

It was very interesting to participate in the workshop on the topic realized at PNDC in January, many people in the sector were invited to reflect and discuss the issue, bringing their experience and reasoning together.

We tried to think of the positive and negative aspects, of a hypothetical time scale of realization, to which other potential could be exploited.

Among the advantages we can certainly count the realization of new functionalities, an economic saving both as capital and operational and a greater efficiency of the substation. These advantages can be translated into less space occupied by the measurement hardware because the data are digitized, exploited differently and exchanged via Ethernet and fiber optics, greater safety and durability of the substations, better use of resources both for greater ease of execution and for the use of time.

There are also some negative aspects to consider, certainly the initial investment, both of economic capital and of technical training for the staff working with a new system.

I therefore took part in this great project, in which more people worked according to the various areas required, focusing on the creation of a model, with the use of RTDS simulators, of a section of real network.

Once the model was created with the various blocks, I modified the various parameters with the data received from the DNOs and validated the model by evaluating the likelihood of the results obtained following the simulations.

The model then allowed me to do various studies on the network, such as calculating the distance of a fault using the data of the digital substation, evaluating the power flows, analyzing the sampling rate making considerations on the various waveforms.

The structure of this work therefore foresees a theoretical introductory part to understand the subject of the digital substation and RTDS simulators also considering aspects such as protection and automation.

Below is an overview of Rscad, the software used by the simulators, and the development of the model of the real network section that will be examined.

This model allows to make a series of measurements directly on the substation to understand the dynamics of the network: the distance of the faults from the substation will be calculated, the power flows will be analyzed and a sampling study will be carried out in order to avoid information loss with the use of Rscad and Simulink comparing the results obtained. The HIL test is then presented with the use of RTDS to test a relay.

Finally, a mention of protections because they require previous analyzes.

6 ANTEFATTO

Questo lavoro di tesi è stato svolto, grazie al progetto Erasmus+ for traineeship, presso il centro di ricerca PNDC, Power Networks demonstration Center, dell'University of Strathclyde, a Glasgow, nel Regno Unito.

Questo centro è tra i primi a livello europeo per quanto riguarda la ricerca sulle sottostazioni digitali, sensori per i sistemi, gestione della tensione di rete e servizi ancillari.

Il progetto a cui ho preso parte è quello riguardante le sottostazioni digitali, un argomento innovativo la cui realizzazione porta a numerosi vantaggi.

È stato molto interessante partecipare al workshop sull'argomento realizzato presso PNDC a Gennaio, molte persone del settore sono state invitate a riflettere e a confrontarsi sulla tematica portando quindi la propria esperienza e ragionando insieme.

Si è provato a pensare agli aspetti positivi e negativi, ad un'ipotetica scala temporale di realizzazione, a quali altre potenzialità potrebbe essere sfruttata.

Tra i vantaggi si possono annoverare sicuramente la realizzazione di nuove funzionalità, un risparmio economico sia come capitale che operativo e un'efficienza maggiore della sottostazione. Questi vantaggi si possono tradurre in meno spazio occupato dagli hardware di misura perché i dati vengono digitalizzati, sfruttati diversamente e scambiati via Ethernet e fibra ottica, una maggiore sicurezza e durata delle sottostazioni, un impiego migliore delle risorse sia per maggior facilità di esecuzione sia per l'impiego del tempo.

Ci sono anche degli aspetti negativi da considerare, sicuramente l'investimento iniziale, sia di capitale economico sia di formazione tecnica per il personale che si trova a lavorare con un sistema nuovo.

Ho preso quindi parte a questo grande progetto, nel quale lavoravano più persone in base ai vari ambiti richiesti, concentrandomi sulla realizzazione di un modello, con l'utilizzo dei simulatori RTDS, di un tratto di rete reale.

Una volta creato il modello con i vari blocchi, ho modificato i vari parametri con i dati ricevuti dai DNOs e ho validato il modello valutando la verosimiglianza dei risultati ottenuti a seguito delle simulazioni.

Il modello poi mi ha permesso di fare vari studi sulla rete, quali calcolare la distanza di un guasto utilizzando i dati della sottostazione digitale, valutare i flussi di potenza, analizzare il sampling rate facendo considerazioni sulle varie forme d'onda.

La struttura di questo lavoro dunque prevede una parte iniziale teorica per permettere di entrare meglio nell'argomento della sottostazione digitale e dei simulatori RTDS considerando anche aspetti come protezione e automazione.

Segue una panoramica di Rscad, software utilizzato dai simulatori, e lo sviluppo del modello del tratto di rete reale che verrà preso in esame.

Questo modello permetterà di fare una serie di misure direttamente sulla sottostazione per capire le dinamiche della rete: verrà calcolata la distanza dei guasti dalla sottostazione, verranno analizzati i flussi di potenza e verrà fatto uno studio sul campionamento per non avere perdite di informazioni con l'utilizzo di Rscad e Simulink confrontando i risultati ottenuti. Viene poi presentato il test HIL con l'uso degli RTDS per testare un relay.

Infine, un cenno sulle protezioni in quanto necessitano delle analisi precedenti.

7 LITERATURE REVIEW

7.1 MODERN PROTECTION CONCEPTS

The aim of an electrical power system is to generate and supply electrical energy to consumers. But how is the structure of the electricity network?

It consists of the whole devices which allow the generation, transmission, distribution and utilization of electric energy.

The generation is the process by the energy from various sources, such as fossil or renewable fuels, is converted into electricity in power plants where there are electric generators and alternators, normally they generate electrical power at 11KV.

Therefore, the energy is conveyed into the transmission network, but the generation voltage is increased to have a loss reduction because $I^2 \cdot R$ decreases with the rising of voltage.

If we focus in the past, the electricity network was very simple, the power flows are unidirectional, they go to the high level of voltage to the low level, it was a passive and radial system. The power flow direction needs to be measured now.

But for some years the presence of distributed generation (DG) has taken root, namely the presence of technologies consisting of modular generators, such as renewable wind, photovoltaic and in general renewable energy, but not only, which offer many advantages.

In the presence of DG, the faults are supplied from both sides and therefore when a switch intervenes it does not guarantee the insulation of the fault then all the DG must be disconnected to eliminate the fault, but also when there are abnormal levels of voltage and frequency or when one or more phases are not connected to the main power supply.

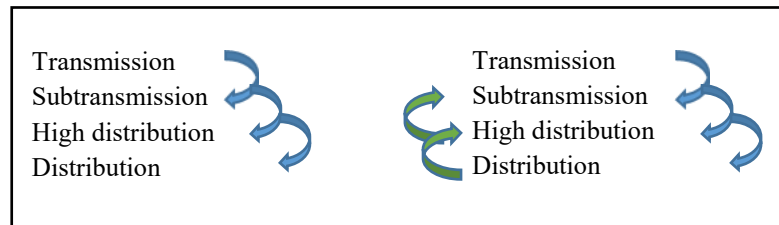

Fig. 7.1 Network sections

The traditional model, in which electrical energy is generated and distributed centrally, is changing due to the increase of DG in distribution level for the advantages it offers such as low cost of production, high flexibility and reliability, the ability to reduce losses along the lines, networks change the traditional power flows and their non unidirectionality could create problems to the traditional protection system, not designed to cope with these situations.

These problems are substantially:

- unwanted increase or decrease, in case of inverter interfaced generation, in short-circuit currents
- unknown power flow
- isolation of some areas (island)
- problems with re-feeding some lines after a failure
- problems with automatic reclosing after the switches have tripped

- problems with the voltage

As regards the short-circuit currents, their increase is due to the type of generators used (the rotating generators give a greater contribution than the static ones), the size of the devices and the distance from the transformation stations.

Regarding the voltage, we need to focus on the voltage dips that cause a loss of DG, an imbalance between reactive power generation and load disturbs the voltage both on load side both along the line. It is also specified as a sudden short duration reduction of the voltage at the point of supply, nominal system voltage, to a value between 10% to 90% of nominal voltage magnitude and with duration from 10ms up to one minute. [1] This is due to the protection system is calibrated for too low voltage levels, so it must be adjusted to higher voltage drops and higher intervention times.

The voltage control and the reactive power compensation is done in the digital substation but if the distribution generation connected into the distribution network is too much, the voltage regulation efficiency may be loss. [2]

The power system always must operate in a safe manner not only because the equipment is very expensive but also for the safety of people and the surrounding environment so adequate protection to detect and disconnect elements of the power system in the event of fault is therefore an integral part of the power system design, for this reason the protection is arranged in zones.

The protection system must be reliable, so it has to take action correctly and at the appropriate time, and secure so it doesn't take action when it is not necessary. An optimum protection system has a fair trade-off between these two features.

The challenge is to design and make stable operation of these power systems. The idea therefore is to have an active electric network to connect consumers without distinction as such, but also as generators and traditional generators, so you get a better management of the network making it easier to connect and exercise, the reliability and security increase. Thus, information is exploited in a useful way.

7.2 MODERN AUTOMATION CONCEPTS

What does it mean the word automation?

It's interesting the definition given by Drucker, "the use of machines to conduct machines". Specifically, it is the set of methodologies and technologies that makes automatic production processes. If we focus on the different level of the automation, we can see that sensors, which evaluate the performance through measures of interest, computer-implemented which decide the actions to be carried out and actuators which execute the actions, these three are the main devices used.

IEC-61850 is a standard for electrical substation automation. It is made by IEC (International Electrotechnical Commission) and it coordinates and manages protocols and existing technologies while ensuring the fundamental specification of interoperability. IED, intelligent electronic devices, HMI, human machine interface, RTU, remote terminal units, managed Ethernet switches are examples of IEC-61850 compliant devices. This standard structure coordinates all the independent units, it uses existent standards, it is scalable and facilitates the integration of different devices, it is based on data objects, it complements the system already installed, it allows high performances in multicast and it adapts quickly to the system configuration.

This standard uses the logical node concept, the information models are made in a specific way and they can share the data using engineering methods.

Every substation is splitted into three levels: the first is the "Station level", the second is the "Bay Level" and the third one is the "Process Level". The connection between the first and the second level is where the control and protection data are exchanged, but also there is communication between the bay and the remote protection. The link between the bay level and the process level is due to CT and VT of process. The process level finally works with the HV equipment.

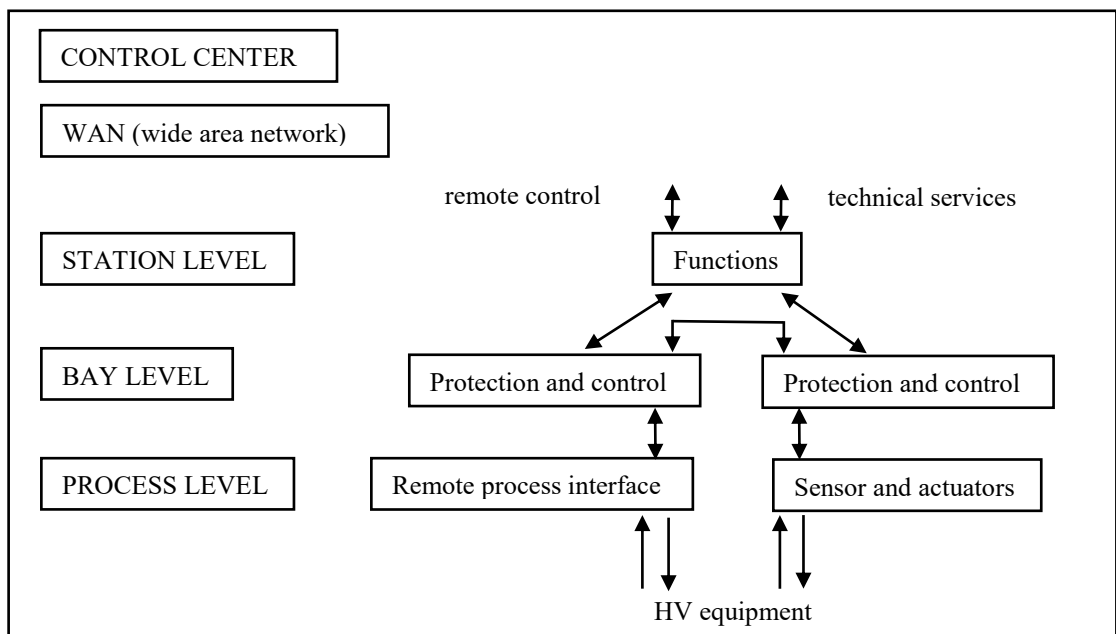

Fig. 7.2 Substation levels

It is widely used because the costs of design, installation, configuration and maintenance of the communication infrastructure are reduced the strength is the division between data models and communication services from protocols. In large substations there are more rings, one for each voltage level, connected to each other as a tree. This standard has set up an engineering process that uses the XML-based SCL language, Extensible Markup Language. It is a hierarchical and object data model structure, a high level of semantic standardization and the use of Ethernet It was designed because there was a need for a communication standard in substations in order to solve interoperability problems; the further goal was to create a standard that would sustain the continuous and rapid technological development in this field. The widespread implementation of the substation protection based on IEC 61850 and the growing interest in digital substations (based on the interface of sampled values with the substation process) offer the opportunity to develop and implement protection, automation and control systems which can be tested remotely. [3]

7.3 DIGITAL SUBSTATION

It is needed to sort out the words “digital substation” and the initial step could be starting from the definitions.

DIGITIZATION: taking analogue information and encoding it into zeroes and ones so that computers can store, process and transmit such information. It is the process of changing from analogue to digital form. The information is digitized, not the processes.

DIGITALIZATION: the use of digital technologies to change a business model and provide new revenue and value-producing opportunities. It is the process of moving to a digital business. Automation is a major part of the digitalization. Digitalization project ranging from automating processes to retraining workers to use computers.

Information is digitized, processes and roles that make up the operations of a business are digitalized and the business and its strategy are digitally transformed, digital transformation isn't about technology.

SUBSTATION: the part of a power system in which the voltage is transformed from high to low or low to high for transmission, distribution, transformation and switching, in addition they are the link between generating plants, transmission and distribution networks and end consumers. They are also the points in the network where circuits or feeders are connected together through circuit breakers and isolators.

In the past substations have used circuit breakers, current transformers CT, voltage transformers VT and protection relays all wired together using copper cables.

Now they become **DIGITAL SUBSTATIONS** with the advance in digital technology, communications and standards, the elements are connected by optical fibre or Ethernet and implemented as intelligent electronic devices IED. Moreover, the digital substation owns advanced computing, database in real time or historian, advanced analytics and visualization, information management and condition monitoring system and smart applications.

Network topology, many products linked together to make a computer network, must be studied. It could be a star topology or rings topology or other, but these two are the simplest. In the past it was allowed only star topology for Ethernet because there was the problem of the rising of an endless loop around the ring but now this the technology improvement both the topology is allowed.

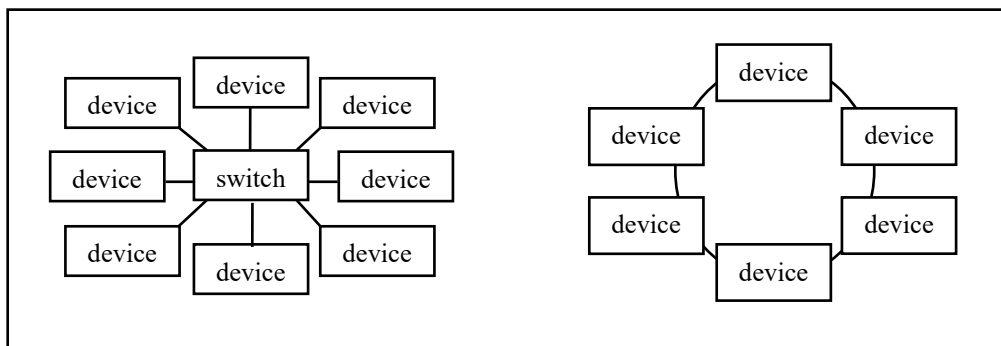

Fig. 7.3 Network topology

The problem of ring topology can be solved with the advancement of technology but another important structure is redundancy. It consists in all resources which help the system to be

reliable and react in a fast way to a perturbation. Redundancy is made by providing alternative path when nodes are connected to the switch in the event that there is a fault, the information could go in another direction. [4]

So digital substation is the integration of electrical substation and information facilities, therefore they do in real time protection, control, monitor and maximize the substation availability, efficiency, reliability, safety, information flow, function performance and data integration.

Digital substation is a milestone in Smart Grid domain, here the information is taken and used for different type of functions. This is a huge difference, in the past one information was used only for one command and so it was needed to have a big number of devices to measure and control the network. Now with digital devices, specific software and other smart structure, the automation and the control are very different. The substation automation and the protection system are the most important components of digital substations. Interoperability is another key system, it is the ability to exchange information, there are protocols and model standards for information management because if the power industry utilizes an open communication standard, interoperability between devices ensures.

Optical current and voltage transducers, which operate by measuring changes in the optical performance of fibres in the presence of electric and magnetic fields, are a growing trend.

Digital substations reduce cabling, need less space and increase safety.

In addition to the measurement samples, the connection also transmits the position of the switching devices, the controls and protection interventions. This leads to defining a true and own process bus between the primary equipment and the secondary one. Less transport, less CO₂, less heavy lifting equipment are used. High function integration in relay room and switchyard enable space reduction. Shorter outage times increase utility revenues and operational costs are lower.

In the substations there is the part in high voltage and the part in medium voltage, downstream of the transformer is the section of the medium voltage primary cabin in which there are a ground switch of the MV side transformer, a switch of the side transformer MT and the busbar system in MT from which the feeders of the distribution network depart. In a digital substation based on IEC 61850, physical isolation is not possible. Maintenance tests in cases such as malfunction of the relay require the IED test before restarting it. In typical cases, this requires sending a test team to the substation to perform the tests, a long and costly process. Therefore, some utilities are actively implementing the concept of digital substations and are seriously considering remote testing in installations based on IEC 61850.

7.4 REAL TIME DIGITAL SIMULATOR

The RTDS is a real time power system simulation tool, it works fully digital and wide-band, it is also used for the closed-loop testing of protection and control equipment. It is made by a custom hardware and all-in-one software able to perform real time electromagnetic transient (EMT) simulations. [5]

It is one of the most powerful devices available to power system environment, but more accurate and more sophisticated models of power system circuits are required, the computation power of digital processors has dramatically increased, which makes possible the development of more powerful hardware to achieve better modelling of power system components.

RTDS allows to improve and verify analytical studies much faster than with other devices with a most detailed, stable and brisk approach. [6]

The hardware enables to simulate complex electrical networks and how they behave in real time. So, people can do a real model of the network, they can understand the strengths and weaknesses, and then they get to the best model for that specific application by varying some values and doing other simulation.

Matlab and Simulink are used to model and simulate in many engineering fields, users can develop their models and it is possible using variable-step integration techniques but the simulation process using RTDS is in real time, faster and more accurate; though after RTDS simulations, data can be put in other software, i.e. Simulink or other, and it is possible to analyse offline the waveforms and the measures collected, this aspect is shown in Fig. 7.6.

RSCAD is the software used to interface the RTDS simulator hardware, it solves mostly differential equations and matrix.

The analogue data are substantially currents and voltages, they can be input or output, it depends on the applications as it is possible to see in Fig. 7.4.

For example, in Fig. 7.5, the digital data are circuit breakers states and the control open/closed (O/C) command of the protections is fed with the analogue value of the current provided by Rscad.

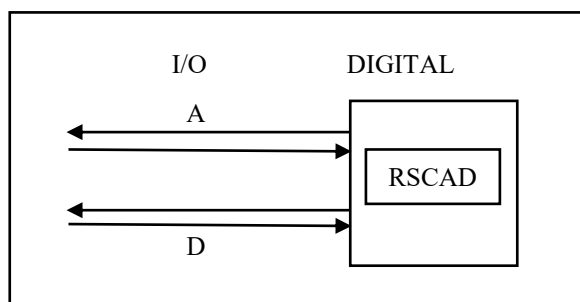

Fig. 7.4 Input output in Rscad

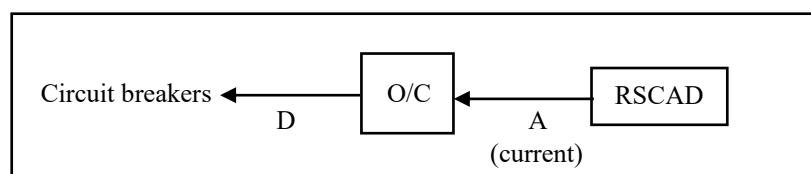

Fig. 7.5 Example of input output

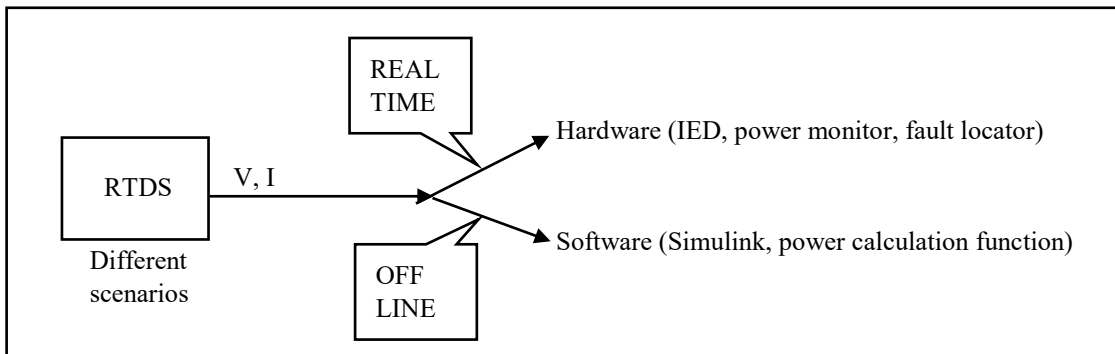

Fig. 7.6 Analysis with Rtds

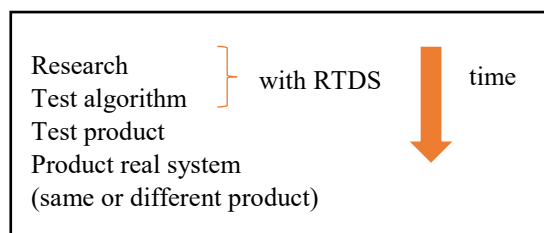

Fig. 7.7 Time line

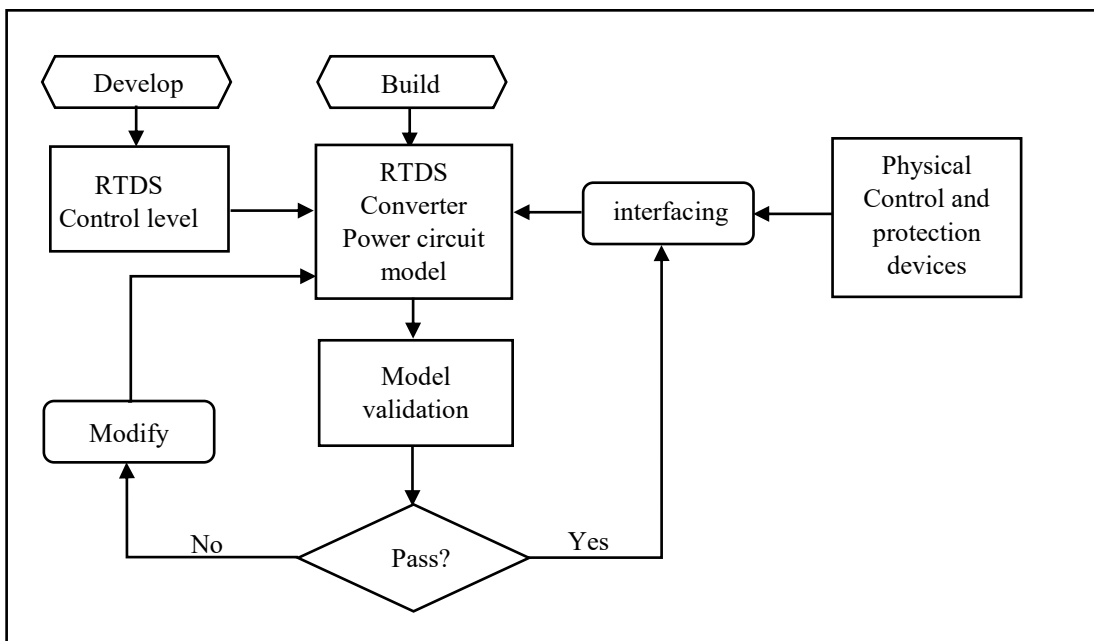

Fig. 7.8 [7] Model validation

Rtds can be used for testing, the Fig. 7.7 shows the steps of the time line devices testing. The validation of the model, Fig. 7.8, is very important to have a realistic behaviour in the specific situation you are in.

One type of RTDS configuration is the HIL, hardware in the loop, which consists in a digital simulation which runs in real time and the physical protection equipment can be connected in closed loop with the power system model so protection equipment can be subjected to virtually

all possible faults and operating conditions. This method will be treated in more detail in chapter 13.

The advantages of using RTDS simulators are many, among these we can mention:

- Better accuracy
- High automation
- Ease of use
- Provisions for more comprehensive statistical analysis
- Cheaper to maintain and operate

Operating in real time, the RTDS can solve the power system equations fast enough to continuously produce output conditions that realistically represent conditions in the real world network. These types of simulation can be used for:

- AC system breaker sequences
- DC transmission systems with various short circuit
- DC system control studies
- AC & DC system interactions
- control studies
- faults

The tests increased with these simulators are carried out in real time, so they are realistic tests, RTDS provide the response that the system would give if it was stimulated by the perturbations that are acted. High-precision analogue and digital interface cards are the connection between real-time control and protection devices with voltages and currents (simulated power system quantities) and with the switch and switch positions (status signals and control commands). Once the simulation is complete and the system responds with the related devices, then the relay opening signals or control signals for the power electronics part are sent as feedback to the simulator.

At this point the topology of the power system is perfected and in case there is the need to arrange some details the system workers or dispatching centres provide for these variations, this is because the feedback signals and the control commands were analysed.

These simulators are high-performing because the case studies that can be recreated are unlimited and, in any condition,, the less positive things are the investment in terms of money that must be done at the beginning and the training of people dedicated to the RTDS use.

8 RTDS SOFTWARE: RSCAD

The software that interfaces with the Rtds is Rscad, if you open it you find a window, called the RSCAD file manager, where you can see on the left different folders: the personal folder where you save the files, a folder with different tutorials and a folder with the user components as you can see in the figure 8.1.

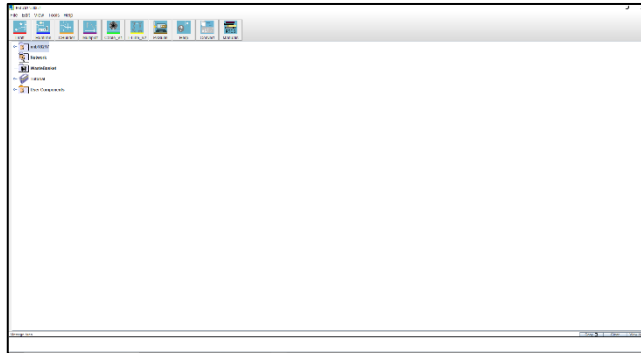

Fig. 8.1 Rscad file manager

Modelling a network in Rscad and simulated it through Rtds basically takes part in two actions: the first consists in create a draft of the network clicking on the draft button of the dialog box and, once the draft will be completed and drawn up, you can go to the runtime, clicking on runtime button as it is highlighted in figure 8.2.

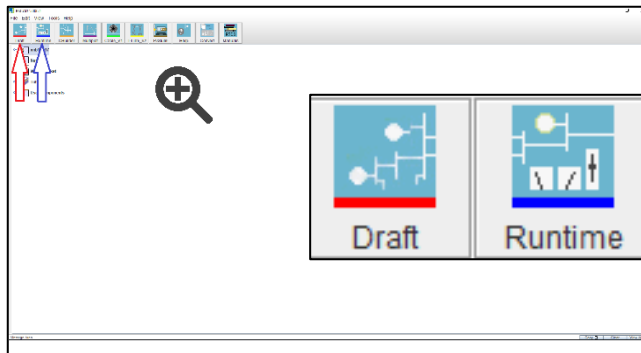

Fig. 8.2 Rscad file manager, draft and runtime

Clicking thus on draft button opens a window like in figure 8.3 where on the left there is the work surface, on the right a library where it is possible to copy and paste the elements useful for building the network that we need to model. In the library there are different sections, the most commonly used in that work are “Power System”, “Controls”, “Protection & Automation”.

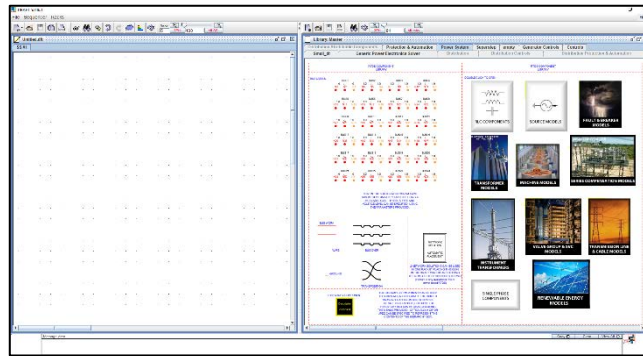



Fig. 8.3 Rscad library

Created and saved the model, shall be carried out with the processing clicking on , the compile model, present on the control bar paying attention to indicate under “Rack” the Rtds number that it will be used. With this operation is verified the correctness of the system, also the various input and output of the components and the uniqueness of the blocks are controlled. If there was something wrong, a window would appear with the reference of the errors, and also on the bar “Message Area” at the bottom of the page comes on “Informational: Compile completed with errors.”; if all is good, on the bar “Message Area” comes on “Informational: Compile completed successfully”.

Now the runtime can take place, here the data acquired are shown, by creating graphs selected by the user. The simulation can be run from the top bar with the button “Run Case”, it can be stopped with “Stop Case”, the graph can be updated with “Update plots”. The parameters useful to be monitored can be plotted by “Create plot” but also is possible to create switch and button, for example to recreate a network disturbance as a fault.

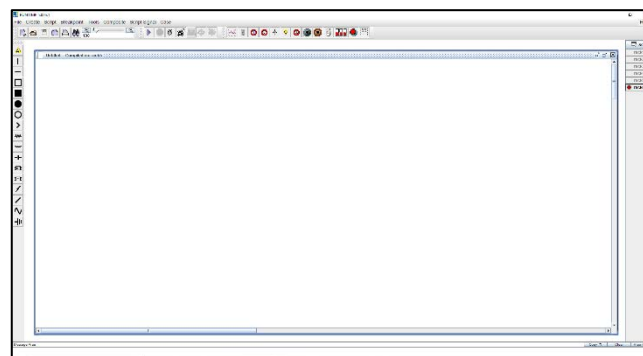

Fig. 8.4 Rscad runtime surface

When we are satisfied with the graph obtained it is possible to save them in various formats, you can also have the option to save them in CSV, coma separate values, so Rscad creates an excel file with all the sampled values.

PROBLEMS

We must pay attention to the absorption of reactive power it hasn't to be so large to preclude the simulation.

The main problem of this hardware, and the method of calculating a solution for the model, is that networks with more 72 nodes are not allowed (or 90 with the usage of the optical fibre), where the meaning of node is a point of the network in which a different voltage can be measured.

The Rtds simulators contain four cards with two processors: ABAB.

The options to fill this gap are several, the solutions we can employ for our network are:

- the box "Risk network solution" in "Power system" put in the model allows to split the process in two separate processors
- decreasing the pi section number, which represent different cable segments, in one summing $r[\text{ohm}]$ and $x[\text{ohm}]$ because they are in series, where the cable with bigger section usually is nearest the source and the cable with smallest section is put near the loads
- using the pattern "Distribution case" instead of "Circuit" for the creation of the draft, in this way more nodes are available, but the library is abridged.

9 CASE STUDY

The use case is a 11kV network, there are two sources at 33kV with two 33kV/11kV transformers, eight 11kV/0.433kV transformers entirely linked by cables except for only one overhead segment. Among the cables, nine are made up of segment with different section and impedance so in the model the PI section with the specific characteristic are put in series. The model of the network done in draft is shown in figure 9.1 and a simplified pattern is provided to have a general view in figure 9.2, but now every strand will be explained in more specific terms.

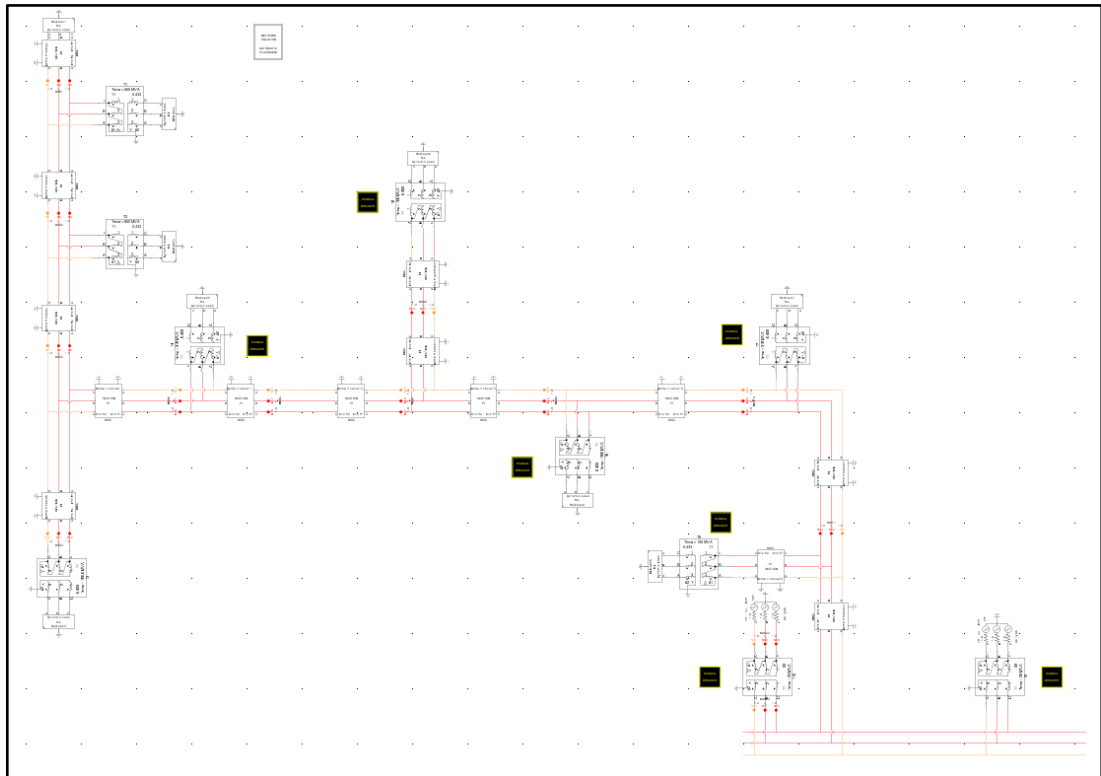

Fig. 9.1 Network model in draft

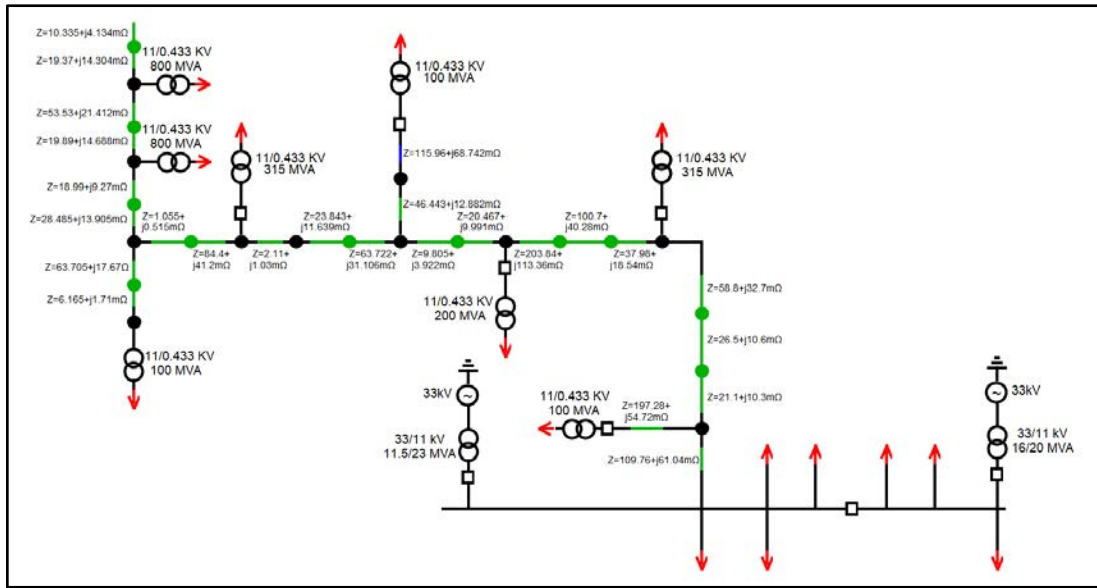

Fig. 9.2 Network representation

This is the network, but attention is all focus in the digital substation, the network section where the two sources are linked.

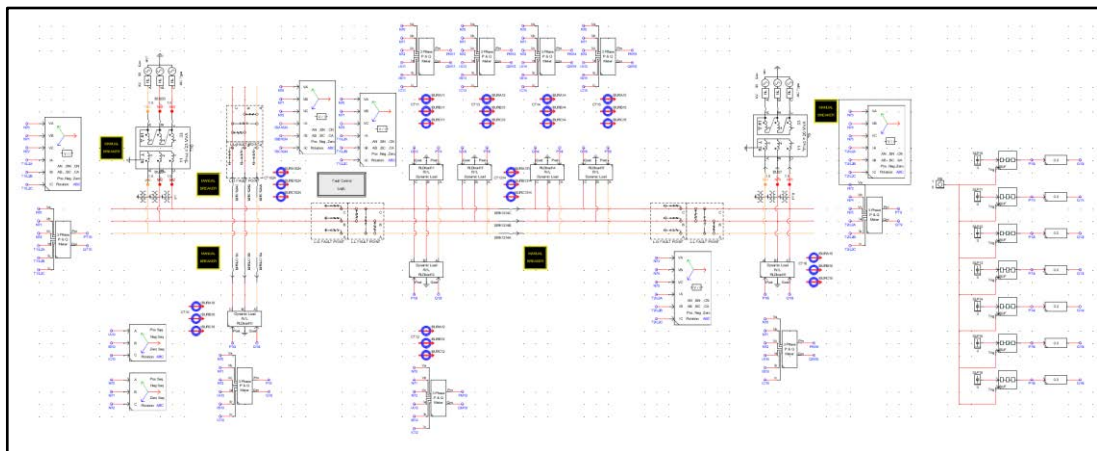

Fig. 9.3 Substation in draft

SOURCES

You can choose four different positive sequence source impedance circuit configurations:

- R+R//L, resistance in series with the parallel of R and L
- R, only the resistance
- R//L, the parallel of R and L
- L, only the reactance

In this application we use the resistive and inductive source impedance.

We calculated the value of R as the subtraction of R using the “existing system fault currents, rms break” given by the network owner, the 33kV voltage and the X/R ratio of 1.5 and the R of the transformer.

$$\frac{X}{R} = 1.5 = \tan\varphi \rightarrow \varphi = 56.31^\circ$$

$$Z_{tot} = \frac{V}{I} = \frac{\frac{33}{\sqrt{3}}[kV]}{7.39[kA]} = 2.58\Omega$$

$$R_{tot} = Z_{tot} * \cos\varphi = 1.42\Omega$$

$$R_{source} = R_{tot} - R_{transformer} = 1.06\Omega$$

The picture of the source is shown on the left of figure 9.4 and on the right, there is the command window regards the source.

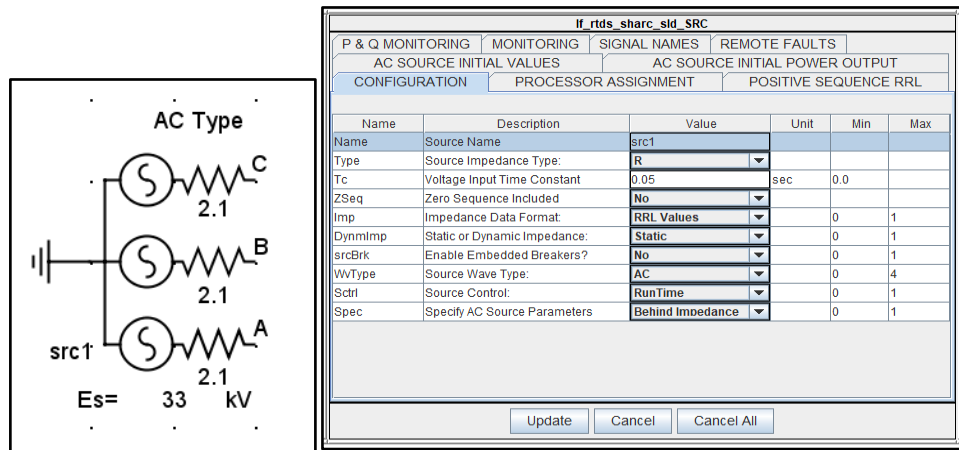

Fig. 9.4 Source

TRANSFORMERS

We draw on the transformers from the library and we need two windings delta-wye transformers.

The data concerning the windings as voltage, transformer rating, number of coupled windings, base frequency is given in the database of the PNDC members. Other parameters as leakage inductance and copper losses must to be refined because we have the value in ohm and we need the value in pu.

$$X_L pu = X_L * \frac{rating[MVA]}{V^2[kV]}$$

$$Copper losses pu = R pu = R * \frac{rating[MVA]}{V^2[kV]}$$

The transformer shown in Fig. 2.9 has these technical specifications:

$$X_L pu = 0.23 pu = 10.8916 * \frac{23}{33^2}$$

$$Copper losses pu = 0.008 pu = 0.363726 * \frac{23}{33^2}$$

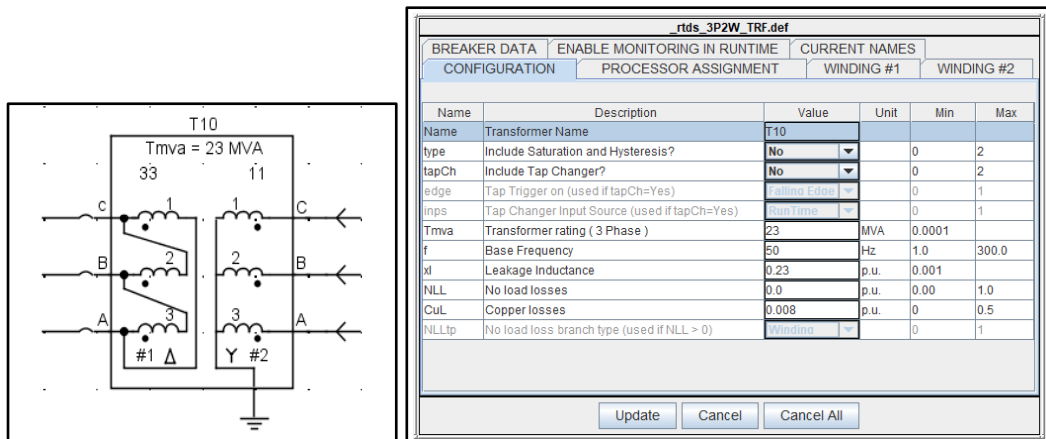

Fig. 9.5 Transformer

This analysis is done for all the ten transformers and the data are shown in the Tab. 9.1.

	TRANSFORMER	x	r	ratedS	ratedU	x_pu
Vertical left	1	7.26	0	0.8	11	0.048
	2	7.26	0	0.8	11	0.048
	3	58.08	0	0.1	11	0.048
Horizontal	4	18.4381	0	0.315	11	0.048
	5	58.08	0	0.1	11	0.048
	6	29.04	0	0.2	11	0.048
	7	58.08	0	0.1	11	0.048
Vertical right	8	18.4381	0	0.315	11	0.048
	DS left	10.8916	0.363726	23	33	0.23
	DS right	10.5923	0.352836	20	33	0.19

Tab. 9.1 Transformers value

The command bar presents also the button “breaker data” because the user can decide to have a circuit breaker in one winding, in both the windings or in neither. In this case there is a circuit breaker in first winding.

In the outline given by the customers, near the transformers 33kV/11kV there are two values of rating, the left transformer has a rating of 11.5/23MVA and the right transformer has a rating of 16/20MVA; the values are two because the cooling could be but also couldn't be so the rating change with the differing of the cooling.

CIRCUIT BREAKERS

As regards the circuit breakers, the most important thing is the control logic, they must have the box “manual breaker” or a numerical relay, which needs a flip flop SR because the fault signal is an impulse but also a signal inverter is required in output because it has an opposite logic compared to the breaker.

The manual breaker monitors a precise parameter, in the figure 9.6 the parameter is BRK1, and this quantity is put in the breaker under the name of “signal name to control breaker”.

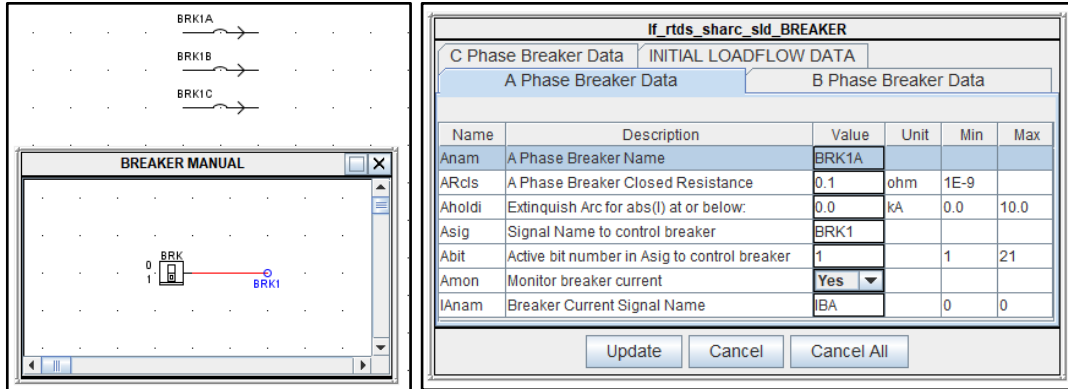

Fig. 9.6 Circuit breaker

CABLES

There are different types of cable in this network, they link transformers, loads and circuit breakers.

The representation of cables in the draft is through the PI section, as it is shown in figure 9.7. The DNOs members has given us many data and to put in Rscad the value of positive and zero sequence resistance, reactance and capacity, we had to organize the information. Collecting together some values and references, we could identify the cross-section of the cables and, consulting the data sheet and multiplying by the length of the cable, we obtain the positive and zero impedance to supply Rscad.

For example

Some cables present the cross-section in inch^2 so we do the equivalence in mm^2 ($0.2\text{inch}^2=129\text{mm}^2$) and the closer cross-section (120mm^2) is chosen in the data sheet.

A problem has arisen when some cables are composed of multiple cross-section segments. Thus, we've found the impedance magnitude and put this value in different pi section how are the segments which compose that cable section.

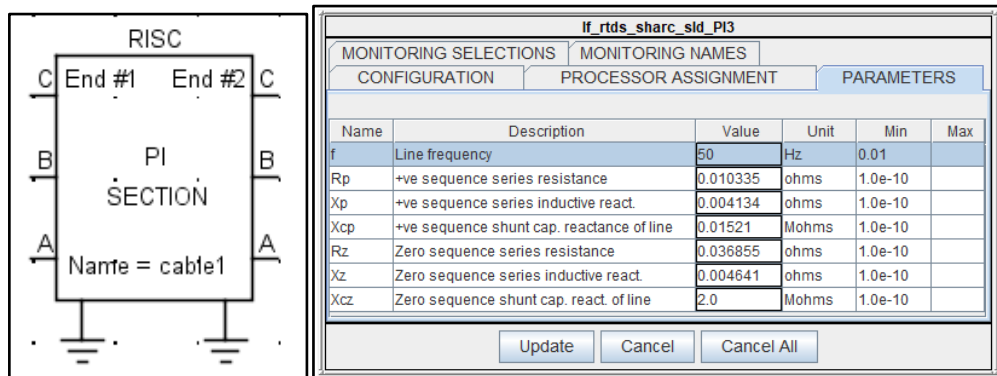

Fig. 9.7 Cable

Why was it preferred to use cables?

Cable lines are mainly used in underground urban distribution, take up less space and are subject to a lower probability of not service compared to a greater cost. Inside they consist of one conductor that is used for transferring energy, an insulating layer and a protective sheath. With the hypothesis of perfect structural symmetry of an electric line affected by a set of perfectly balanced currents, each phase of the three-phase system behaves exactly like the other two by an electric point of view. It is therefore possible to make the single-phase model. The constants introduced in the model are referred to the unit of length of the line and take into account the physical phenomena that occur in permanent operation. To satisfy these conditions the laying must be trefoil or in any case on plan but with transposition of the phases to have structural symmetry, moreover the technique of transposition of the screens or cross bonding must be used.

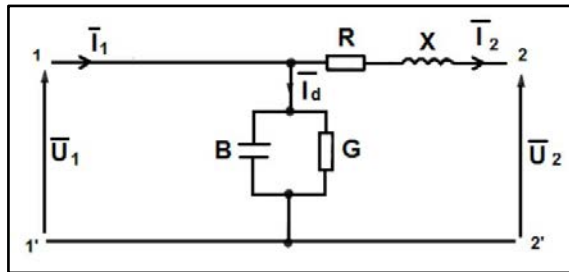

Fig. 9.8 [8] Single-phase cable circuit model

Where there are:

- X that is the reactance ($=\omega L$) and L, the inductance, can be calculated in this way,

$$L = 0.46 \log_{10} \left(\frac{d}{r} \right) \left[\frac{mH}{km} \right]$$

d is the geometric mean distance and r geometric mean radius. Generally, this value is between 0.296 and 0.47mH/km.

- R is the resistance, the value results from these relations

$$r_{20^\circ} = \rho \frac{l}{S} \left[\frac{\Omega}{km} \right]$$

$$r_T = r_{20^\circ} [1 + \alpha(\theta^\circ - 20^\circ)] \left[\frac{\Omega}{km} \right]$$

ρ is the electric resistivity at 20° and depends on the material and θ° is the temperature for different insulators.

- C is the capacitance,

$$C = \frac{\epsilon_r}{18 \ln \frac{d_0}{d_1}} \left[\frac{\mu F}{km} \right]$$

ϵ_r , dielectric constant of the insulating material, d_0 is the external diameter of insulating without semiconductor layer and d_1 conductor phase diameter including the semiconductor layer. Generally, this value is between 170 and 490nF/km.

- The last is G, the conductance, it is a quantity that takes into account the losses over the isolators, the losses for corona discharge and the voltage.

This is the theoretical analysis of the line, as regards the components of the network taken into consideration, the values are the following

	SECTION	LENGTH	r [Ω /km]	x [Ω /km]	c [μ /km]	R [Ω]	X [Ω]	C [Ω]
14	150A	0,039	0,265	0,106	0,39	0,010335	0,00413	0,01521
	300A	0,149	0,13	0,096	0,52	0,01937	0,01430	0,07748
13	150A	0,202	0,265	0,106	0,39	0,05353	0,02141	0,07878
	300A	0,153	0,13	0,096	0,52	0,01989	0,01469	0,07956
7	185A	0,09	0,211	0,103	0,43	0,01899	0,00927	0,0387
	185A	0,135	0,211	0,103	0,43	0,028485	0,01390	0,05805
15	95A	0,155	0,411	0,114	0,33	0,063705	0,01767	0,05115
	95A	0,015	0,411	0,114	0,33	0,006165	0,00171	0,00495
8	185A	0,005	0,211	0,103	0,43	0,001055	0,00051	0,00215
	185A	0,4	0,211	0,103	0,43	0,0844	0,0412	0,172
10	185A	0,302	0,211	0,103	0,43	0,063722	0,03111	0,12986
	185A	0,113	0,211	0,103	0,43	0,023843	0,01164	0,04859
9	150A	0,037	0,265	0,106	0,39	0,009805	0,00392	0,01443
	185A	0,097	0,211	0,103	0,43	0,020467	0,00999	0,04171
11	120C (0.2 INCH)	1,04	0,196	0,109	0,36	0,20384	0,11336	0,3744
	150A	0,38	0,265	0,106	0,39	0,1007	0,04028	0,1482
	185A	0,18	0,211	0,103	0,43	0,03798	0,01854	0,0774
12	120C (0.2 INCH)	0,3	0,196	0,109	0,36	0,0588	0,0327	0,108
	150A	0,1	0,265	0,106	0,39	0,0265	0,0106	0,039
	185A	0,1	0,211	0,103	0,43	0,0211	0,0103	0,043
4	185A	0,01	0,211	0,103	0,43	0,00211	0,00103	0,0043
5	95A	0,113	0,411	0,114	0,33	0,046443	0,01288	0,03729
6	50ACSR	0,171	0,676	0,402	0	0,115596	0,06874	0
3	95A	0,48	0,411	0,114	0,33	0,19728	0,05472	0,1584
2	120C (0.2 INCH)	0,56	0,196	0,109	0,36	0,10976	0,06104	0,2016

Tab. 9.2 Network value

The first column indicates the sections on the network, the numbers are a fast way to identify them. The second column presents the cross section of the cable in mm² with A for aluminum, C for copper, ACSR (aluminum conductors steel reinforced) for the overhead line. The third the length of the section, forth fifth and sixth columns are respectively the value of resistance, reactance and capacity per length, instead the next are the overall value.

The same analysis is done for the zero sequence in Tab. 9.3.

	SECTION	LENGTH	r_0 [Ω/km]	x_0 [Ω/km]	R_0	X_0
14	150A	0,039	0,945	0,119	0,036855	0,004641
	300A	0,149	0,687	0,108	0,102363	0,016092
13	150A	0,202	0,945	0,119	0,19089	0,024038
	300A	0,153	0,687	0,108	0,105111	0,016524
7	185A	0,09	0,848	0,115	0,07632	0,01035
	185A	0,135	0,848	0,115	0,11448	0,015525
15	95A	0,155	1,307	0,124	0,202585	0,01922
	95A	0,015	1,307	0,124	0,019605	0,00186
8	185A	0,005	0,848	0,115	0,00424	0,000575
	185A	0,4	0,848	0,115	0,3392	0,046
10	185A	0,302	0,848	0,115	0,256096	0,03473
	185A	0,113	0,848	0,115	0,095824	0,012995
9	150A	0,037	0,945	0,119	0,034965	0,004403
	185A	0,097	0,848	0,115	0,082256	0,011155
11	120C (0.2INCH)	1,04	1,16	0,12	1,2064	0,1248
	150A	0,38	0,945	0,119	0,3591	0,04522
	185A	0,18	0,848	0,115	0,15264	0,0207
12	120C (0.2INCH)	0,3	1,16	0,12	0,348	0,036
	150A	0,1	0,945	0,119	0,0945	0,0119
	185A	0,1	0,848	0,115	0,0848	0,0115
4	185A	0,01	0,848	0,115	0,00848	0,00115
5	95A	0,113	1,307	0,124	0,147691	0,014012
6	50ACSR	0,171	2,028	1,206	0,346788	0,206226
3	95A	0,48	1,307	0,124	0,62736	0,05952
2	120C (0.2INCH)	0,56	1,16	0,12	0,6496	0,0672

Tab. 9.3 Zero sequence network values

OVERHEAD LINES

We use the pi section also for the one overhead line, ACSR, aluminium conductors steel reinforced, are used in this segment.

LOADS

The loads are represented by “dynamic load” block, they are adjusted dynamically during the simulations to maintain P and Q set points.

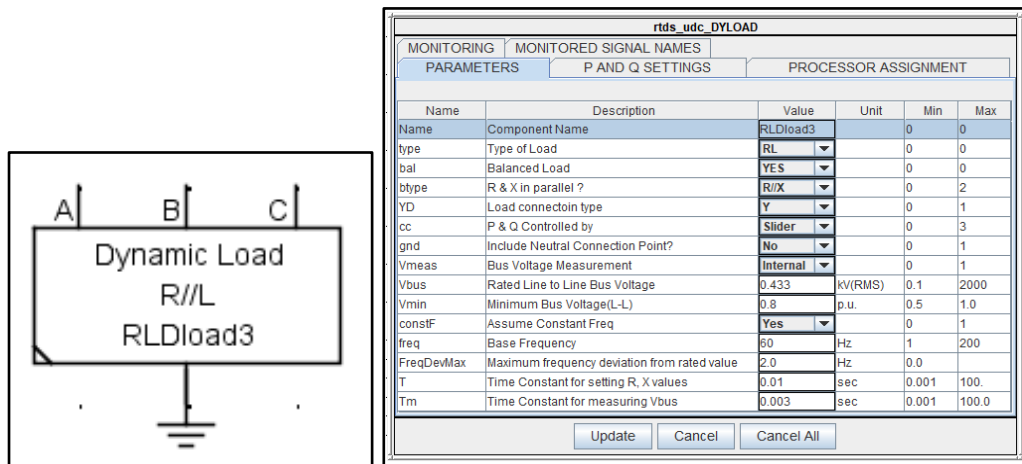

Fig. 9.9 Load

Having verified that everything is correct, the model can be used to simulate, in this specific case, the localization of different types of faults and power flows.

VALIDATION

Why do we have to check the plausibility of the model? The data entered are those referring to the line in question and the structure of the elements of the line has been maintained.

The problem is that Rscad is a software that allows you to change a large number of elements to create many configurations, this is very good, but it is a factor to be taken into account, even a small detail can change the results.

There are many ways to find out if the model actually reflects the performance of the network:

- Changing load, voltage drop transformer changes but in all the network so for this analysis is not so suitable because we are interested in this section.
- Plotting the values of the current that the DNOs members gave us and check with the values of the current from Rscad.
- Calculating the power and compare it this the value of Rscad block; this method is shown.

The calculation of the apparent power is done using the values of current and voltage from primary current (IBA, IBB, IBC) and the bus nodes voltage (N16, N17, N18).

$$I_{rms} = \frac{\hat{I}}{\sqrt{2}} = \frac{488A}{\sqrt{2}} = 345.07A$$

$$V_{rms} = \frac{\hat{V}}{\sqrt{2}} = \frac{7460V}{\sqrt{2}} = 5275.02V$$

$$S = 3 * I_{rms} * V_{rms} = 3 * 345.07 * 5275.02 = 5.46MVA$$

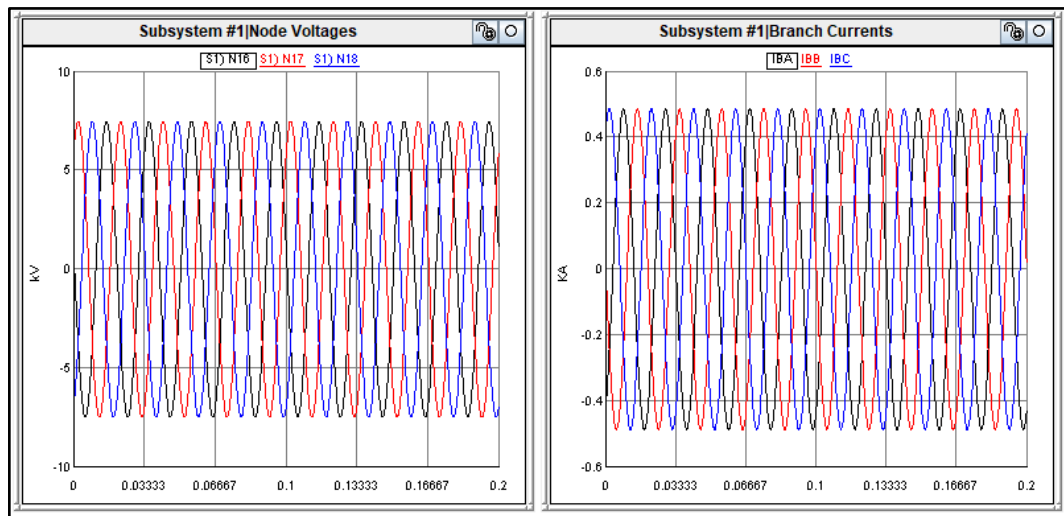

Fig. 9.10 Current and voltage for validation

We put also a “3 Phase P & Q Meter” to verify the correct value of the apparent power from the before calculation, this box gives us the value of active and reactive power, so we find easily the apparent power with the following equation.

$$S = \sqrt{P_m^2 + Q_m^2} = \sqrt{3.459^2 + 4.228^2} = \sqrt{29.841} = 5.46MVA$$

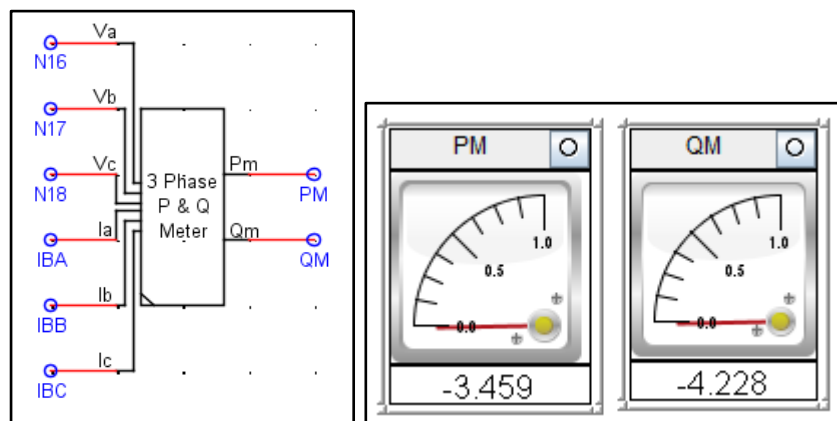

Fig. 9.11 Power meters

10 DISTANCE TO FAULT

In nature here are many reasons why a fault may occur on the line, for example bad weather so lightning strikes, trees or animals contact, conductor clashing or the insulation failure in power system equipment.

Faults are classified in:

- Type;
- Fault impedance;
- Duration;
- POW (point of wave).

As regards the type can be identify:

- line-ground fault, it is a monophasic fault, the voltage of the fault phase is equal to zero, short-circuit current on the phase with the fault flowing to ground, the short-circuit current on the phases without fault are zero. In nature they are the 65-70%.
- line-line fault and line-line-ground, they are biphasic faults, the voltages of the fault phases are equal, the short-circuit currents on the phases with the fault are equal and opposite, the short-circuit current on the phase without fault is zero. In nature line-line faults are the 5-10%, double line-ground are the 15-20%.
- line-line-line fault and line-line-line-ground, they are triphasic faults, the voltage is zero and the currents have the same magnitude. These faults are the only symmetric or balanced, but if they take place, there could be severe damage to the equipment. In nature they are the 5%

In the event of a flashover, the fault impedance consists of the arc resistance and the earthing impedance of the object to which the flashover occurs and it is calculated by

$$R_{arc} = 1.81 \frac{l}{I_{rms}^{1.4}}$$

with l is the length of the arc [m] in still air and I_{rms} is the short-circuit current [kA]. [10]

The duration of the fault depends on the circuit breaker time of action, in this work are analysed faults with duration between 0.5 and 1.5s.

The POW, point of wave, represents the specific point of the wave where the fault takes action. For example, if POW is 90° , the fault occurs when the wave is 90° after the 0 as it is shown in Fig. 10.1.

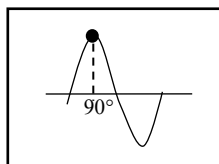

Fig. 10.1 POW

The idea of this type of configuration is to measure at the digital substation voltage and current, calculating the impedance, and try to understand how far the fault is through different approach.

The fault location is useful because we want to repair the fault quickly and we want to have the minimum length off working.

In the following scheme (figure 10.2), it is possible to identify the analysed faults (red bolts), the voltage measure (green boxes), the power measure (orange boxes), the current measure (pink boxes) and the impedance measure (blue lines) made by RSCAD.

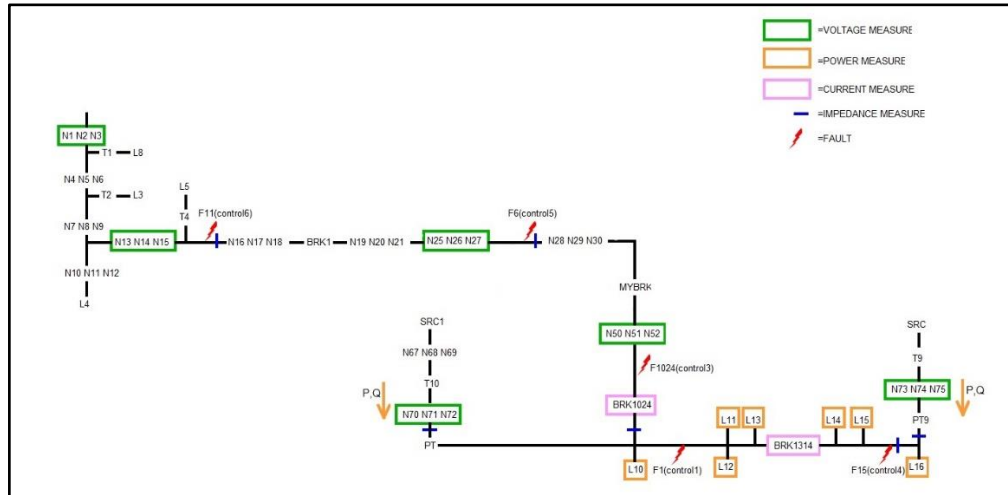

Fig. 10.2 Network measures and fault representation

To simulate the different faults and varying the parameters, a control system, Fig. 10.3, has been set up: fault duration with the first slider, POW with the second slider, fault type with the six switches, fault impedance with the brown draft variable dial, fault location with the dial and the red button to start with the simulation after the specific fault configuration. The scheme of the fault control logic in draft is represented in Fig. 10.4 and Fig. 10.5.

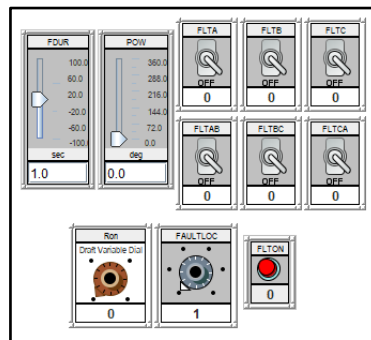

Fig. 10.3 Fault control logic

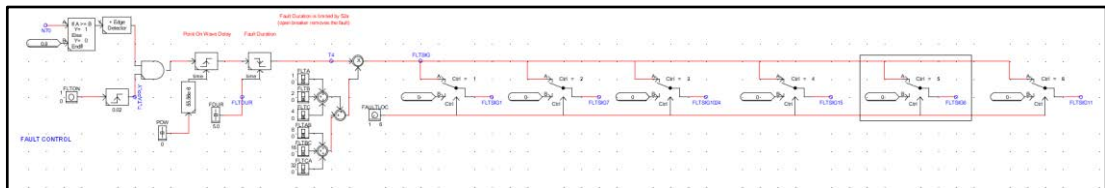

Fig. 10.4 Fault control

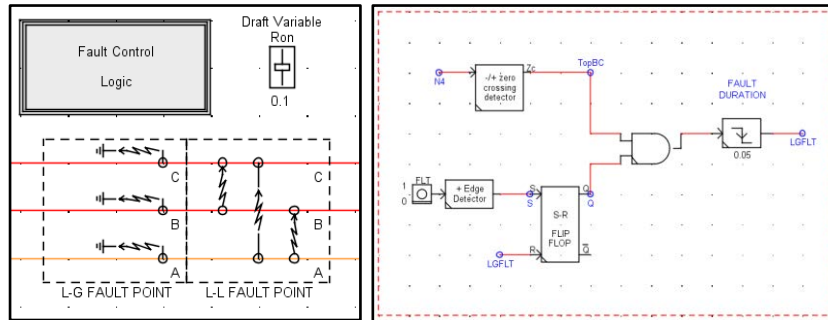

Fig. 10.5 Fault control

The length of the network and every line impedance are known and shown in table 10.1.

SECTION	R [Ω]	L [H]	$X_L=2\pi fL$ [Ω]	LENGTH [km]
"10" from F11 to N19 20 21	0.023843	3.7E-05	1.16E-02	0.415
	0.063722	9.90E-05	3.11E-02	
"9" from N19 20 21 to N25 26 27	0.009805	1.25E-05	3.93E-03	0.134
	0.020467	3.18E-05	9.99E-03	
"11" from N25 26 27 to N28 29 30	0.20384	3.61E-04	1.13E-01	1.6
	0.1007	1.28E-04	4.02E-02	
	0.03798	5.90E-05	1.85E-02	
"12" from N28 29 30 to "mybrk"	0.0588	1.04E-04	3.27E-02	0.5
	0.0265	3.37E-05	1.06E-02	
	0.0211	3.28E-05	1.03E-02	
"2" from mybrk to DS	0.10976	1.94E-04	6.09E-02	0.56
TOTAL	0.676517	1.09E-03	3.43E-01	3.209
Z[Ω]	0.758643			

Tab. 10.1 Impedance, length and sections of the model

But resistance, inductance and impedance per length are requested for the analysis so

$$R_L = \frac{R_{tot}}{length} = \frac{0.676517}{3.209} = 0.211\Omega/km$$

$$X_L = \frac{X_{tot}}{length} = \frac{0.343}{3.209} = 0.107\Omega/km$$

$$Z_L = \frac{Z_{tot}}{length} = \frac{0.758643}{3.209} = 0.236\Omega/km$$

The active and the reactive power on the loads are indicated in the next table.

	ACTIVE POWER [MW]	REACTIVE POWER [MVAR]
L10	1.1	0.22
L11	1.0	0.2
L12	1.4	0.28
L13	1.2	0.24
L14	1.5	0.30

L15	2.7	0.54
L16	0.5	0.10
L8	0.8	0.16
L3	1.0	0.20
L4	0.9	0.18
L5	1.1	0.22
L6	0.9	0.18
L9	0.8	0.16
L7	0.7	0.14
L2	0.8	0.16
Ptot	16.4	3.3

Tab. 10.2 Active and reactive power on the loads

There are several ways to calculate the distance of fault, we are interested in one-ended impedance-based fault location algorithms because the basic idea is to take advantages to the measure from the DS, so for this analysis are used:

- Simple reactance method;
- Takagi method;
- Modified Takagi method.

Before starting with the calculation, the characteristics of the different scenarios are described in the next table.

	POSITION	TYPE	IMPEDANCE [Ω]	DURATION [sec]	POW [deg]
SCEN 9	F1	A-ground	1E-9	1sec	0.0
SCEN 10	F15	A-ground	1E-9	1sec	0.0
SCEN 11	F6	A-ground	1E-9	1sec	0.0
SCEN 13	F11	A-B B-C C-ground	100	0.5	50
SCEN 14	F1024	C-A	1000	1.5	20
SCEN 15	F1024	C-A	1E-9	1	20
SCEN 16	F1	B-C	10	1.1	90
SCEN 17	F11	A-B B-C C-A A-ground	1E-9	1	0.0
SCEN 18	F11	A-B B-C C-A A-ground B-ground C-ground	1E-9	1	0.0

Tab. 10.3 Fault scenarios

10.1 SIMPLE REACTANCE METHOD [9]

GENERAL RELATION

This method is based on the idea that fault resistance R_F is resistive in nature so the fault current and the line current are considered in phase.

Thus, with this simplification, is easy to estimate the distance to the fault given by:

$$m = \frac{\text{imag}\left(\frac{V_G}{I_G}\right)}{\text{imag}(Z_L)} \text{ [km]}$$

APPLICATION

If this relation is applied to the network considered, Z_L is known because it is the X_L ; about V_G and I_G , they change with the type of fault with these relations,

FAULT TYPE	V_G	I_G
A-G	V_{AF}	$I_{AF} + kI_{GO}$
B-G	V_{BF}	$I_{BF} + kI_{GO}$
C-G	V_{CF}	$I_{CF} + kI_{GO}$
AB, AB-G	$V_{AF} - V_{BF}$	$I_{AF} - I_{BF}$
BC, BC-G	$V_{BF} - V_{CF}$	$I_{BF} - I_{CF}$
CA, CA-G	$V_{CF} - V_{AF}$	$I_{CF} - I_{AF}$

Tab. 10.4 Fault voltage and fault current

where

$$k = \frac{Z_0}{Z} - 1 = \frac{119.6173}{0.758643} - 1 = 156.67$$

And Z_0 is from

SECTION	R_0 [Ω]	L_0 [H]	$X_{L0} = 2\pi f L_0$ [Ω]	LENGTH [km]
"10" from F11 to N19 20 21	0.0958	0.0130	4.0825	0.415
	0.2561	0.0347	10.9107	
"9" from N19 20 21 to N25 26 27	0.03496	0.0044	1.3832	0.134
	0.0823	0.0112	3.5044	
"11" from N25 26 27 to N28 29 30	1.2064	0.1248	39.2071	1.6
	0.3591	0.0452	14.2063	
	0.1526	0.0207	6.5031	
"12" from N28 29 30 to "mybrk"	0.348	0.036	11.3097	0.5
	0.0945	0.0119	3.7385	
	0.0848	0.0115	3.6128	
"2" from mybrk to DS	0.6496	0.0672	21.1115	0.56
TOTAL	3.3642	0.3806	119.57	3.209
Z_0 [Ω]	119.6173			

Tab. 10.5 Zero impedance, length and sections of the model

The model made with RTDS and RSCAD allowed to know the circuit breaker "1024" fault impedance so it will be used that impedance instead of the ratio V_G/I_G .

Scenario 9: $V_G=0\text{kV}$
 $I_G=0+0.01*156.6727=1.57\text{kA}$
 $m=0$

Scenario 10: $V_G=0\text{kV}$
 $I_G=0.2+0.03*156.6727=4.9\text{kA}$
 $m=0$

Scenario 11: $V_G=7.23\text{kV}$
 $I_G=2.67+0.681*156.6727=109.36\text{kA}$
 $m=0.62\text{km}$

Scenario 13: $Z_{1024}=3.95\Omega$
 $m=36.91\text{km}$

Scenario 14: $Z_{1024}=6.17\Omega$
 $m=57.66\text{km}$

Scenario 15: $V_G=5.32-3.16=2.16\text{kV}$
 $I_G=6.5-(-5.83)=12.33\text{kA}$
 $m=1.64\text{km}$

Scenario 16: $V_G=0\text{kV}$
 $I_G=0.42-0.20=0.22\text{kA}$
 $m=0$

Scenario 17: $Z_{1024}=0.39\Omega$
 $m=3.64\text{km}$

Scenario 18: $Z_{1024}=0.39\Omega$
 $m=3.64\text{km}$

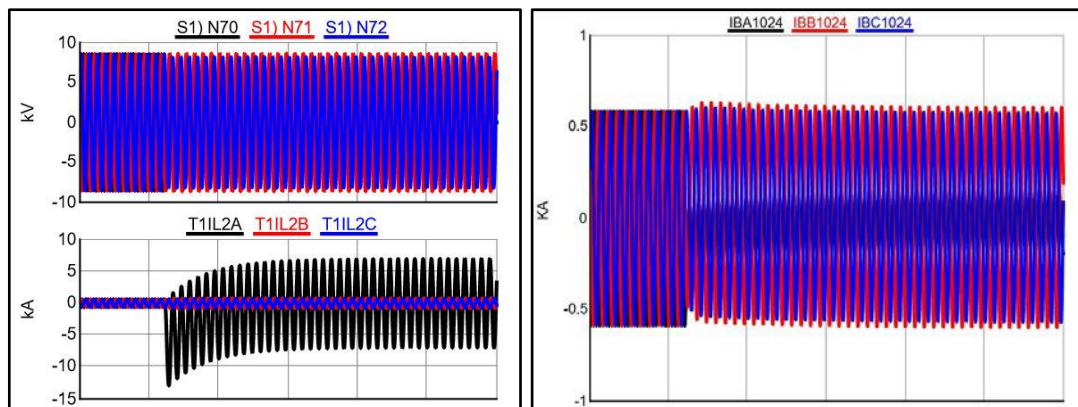

Fig. 10.6 Phase-ground fault current and voltage

The Fig. 10.6a shows the variations of the voltage and the current at the DS, the Fig. 10.6b the current at the circuit breaker near the DS when the scenario 9 is simulated so with A-ground fault at the DS.

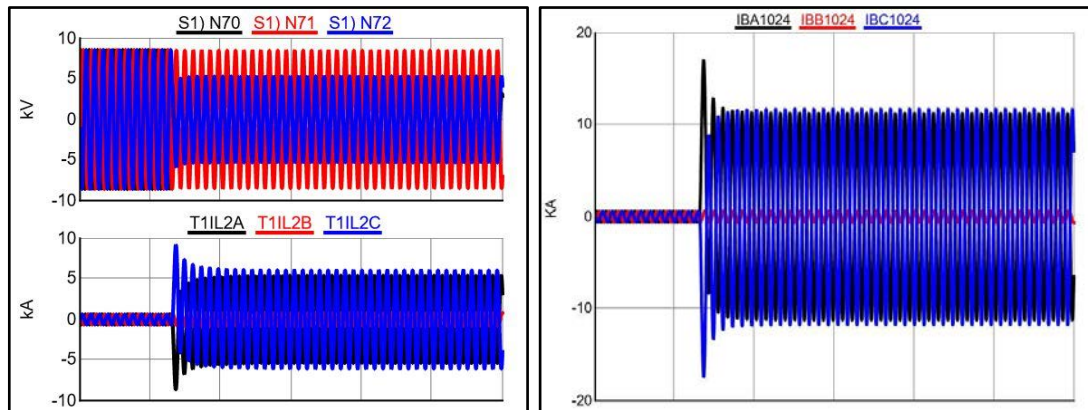

Fig. 10.7 Phase-phase-ground fault current and voltage

The Fig. 10.7a shows the DS current and voltage, the Fig. 10.7b the circuit breaker current during the simulation 15, line-line fault C-A.

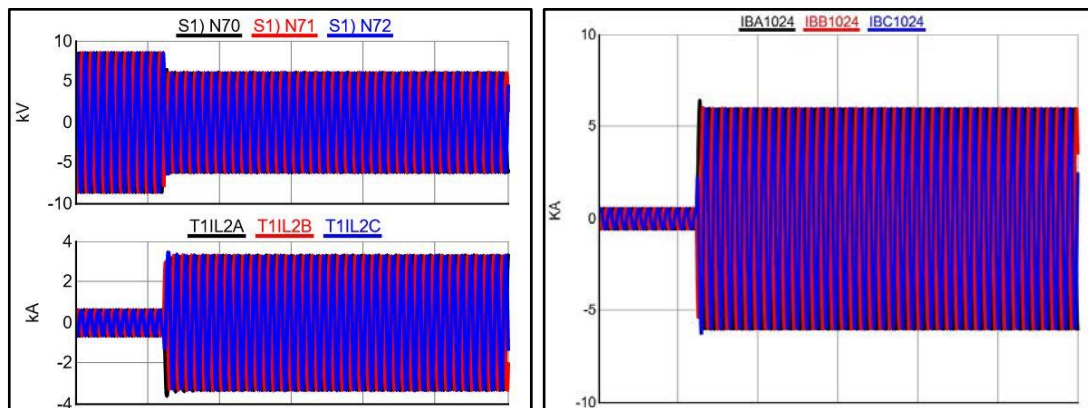

Fig. 10.8 Phase-phase-phase ground fault current and voltage

In Fig. 10.8a there are the graphs of DS current and voltage and in Fig. 10.8b the circuit breaker current when the simulation of scenario 17 is running, it is triphase-ground, A-B, B-C, C-A, A-ground, fault.

The obtained results are almost good, $m=0$ for the first, second and seventh scenarios are right because these faults are at the digital substation, so the distance must be equal to zero.

The third distance is 0.62km and from the diagram we know that the faults is between 1.06 ($=0.5+0.56$) and 2.66 ($=0.5+0.56+1.6$), but this method presents some assumptions, so we can consider it not so wrong.

About the scenario 13 and 14 the big distances carried out are because there is the presence of fault impedance, 100Ω fault impedance for the first, 1000Ω fault impedance for the second. These fault impedances are not considered and for this reason the faults are estimated very far. As concern the scenario 15 the problem consists in the measure of the impedance in the same position of the fault and are used current and voltage measured at the digital substation.

The scenario 17 and 18 are good results.

10.2 TAKAGI METHOD [9]

GENERAL RELATION

This method is more precise instead of the previous one because the load current is subtracted from the total fault current. The distance is carried out as following

$$m = \frac{\text{imag}(V_G \times \Delta I_G^*)}{\text{imag}(Z_L \times I_G \times \Delta I_G^*)} [km]$$

ΔI_G is the pure fault current and is used to have less reactance errors due to the system load. The strength of this algorithm is the transmission network is homogeneous in nature, on the other hand if the network wasn't homogeneous, there would be a proportional error to the degree of non-homogeneity.

APPLICATION

To know how far a fault with the Takagi method on the studied network is, the angle between voltage and current is required because is useful the complex current to do the conjugate. It is easy to calculate with the delay and the period of the waveform with the relation

$$\varphi = \frac{2\pi\Delta t}{T} [grad]$$

Let's start with a fast analysis of the variables: Z_L is always equal to $0.211+j0.107\Omega/km$, V_G and I_G follow the same rules of table 10.6, and ΔI_G^* can be known is this way

FAULT TYPE	ΔI_G
A-G	$I_{AF}-I_{Apre}$
B-G	$I_{BF}-I_{Bpre}$
C-G	$I_{CF}-I_{Cpre}$
AB, AB-G	$(I_{AF}-I_{Apre})-(I_{BF}-I_{Bpre})$
BC, BC-G	$(I_{BF}-I_{Bpre})-(I_{CF}-I_{Cpre})$
CA, CA-G	$(I_{CF}-I_{Cpre})-(I_{AF}-I_{Apre})$

Tab. 10.6 Variation of fault current

Scenario 9:

$V_G=0kV$

$m=0$

Scenario 10:

$V_G=0kV$

$m=0$

Scenario 11:

$\varphi_{pre}=0.47^\circ$ $\varphi_{post}=0.13^\circ$

$V_G=8.6+0.02i$ KV

$I_{G0}=0.12-2.72i$ KA

$I_G=23.77-0.05i$ KA

$\Delta I_G=4.38-6.44i$ KA

$$m = \frac{55.47}{43.43} = 1.28km$$

Scenario 13:

$$\varphi_{pre}=0.47^\circ \quad \varphi_{post}=0.42^\circ$$

$$V_G=-8.6+0.06i \text{ KV}$$

$$I_G=-0.93-0.02i \text{ KA}$$

$$\Delta IG=-0.33+0.02i \text{ KA}$$

$$m = \frac{0.18}{0.05} = 3.6km$$

Scenario 14:

$$\varphi_{pre}=0.42^\circ \quad \varphi_{post}=0.41^\circ$$

$$V_G=0.001+7.15i \text{ KV}$$

$$I_G=1.2-8.59i \text{ KA}$$

$$\Delta IG=0.01-3.86i \text{ KA}$$

$$m = \frac{0.075}{4.5} = 0.02km$$

Scenario 15:

$$\varphi_{pre}=0.47^\circ \quad \varphi_{post}=0.05^\circ$$

$$V_G=1E-3+8.7E-7 \text{ KV}$$

$$I_G=0.33-2.8E-4 \text{ KA}$$

$$\Delta IG=0.33-2.9E-4i \text{ KA}$$

$$m = \frac{2.910^{-7}}{0.001} = 2.9 \cdot 10^{-5}km$$

Scenario 16:

$$V_G=0kV$$

$$m=0$$

Scenario 17:

$$\varphi_{pre}=0.39^\circ \quad \varphi_{post}=0.38^\circ$$

$$V_G= 2.033+0.13i \text{ KV}$$

$$I_G=-0.426+2.83E-3i \text{ KA}$$

$$\Delta IG=0.42+3E-3i \text{ KA}$$

$$m = \frac{0.06}{0.02} = 3km$$

Scenario 18:

$$\varphi_{pre}=0.47^\circ \quad \varphi_{post}=0.38^\circ$$

$$V_G= 12.34+0.08i \text{ KV}$$

$$I_G= 1.41E-3-9.37i \text{ KA}$$

$$\Delta IG= 16.79-0.108i \text{ KA}$$

$$m = \frac{2.676}{2.54} = 1.05km$$

The results obtained are in line with expectations, only the last fault is closer to the real distance. It could be a problem with the calculation of the current and the voltage.

10.3 MODIFY TAKAGI METHOD [9]

GENERAL RELATION

This method takes into account the problem that the prefault current is not always available in the specific location. So is used the zero-sequence current I_{G0} instead of ΔI_G for single line-ground fault. This assumption is possible because the I_{G0} is not zero during a ground fault. The distance can be known with

$$m = \frac{\text{imag}(V_G \times 3I_{G0}^*)}{\text{imag}(Z_L \times I_G \times 3I_{G0}^*)} [km]$$

APPLICATION

We can apply the modify Takagi method for the first three scenarios because the others are not single line-ground fault.

Scenario 9: $V_G=0kV$

$m=0$

Scenario 10: $V_G=0kV$

$m=0$

Scenario 11: $\varphi_{pre}=0.47^\circ$ $\varphi_{post}=0.13^\circ$

$V_G=8.6+0.02i$ KV

$I_{G0}=(4.97-2.0-2.6)/3=0.12-2.72i$ KA

$I_G=4.97+k*0.12=23.77-0.05i$ KA

$$m = \frac{70.18}{41.88} = 1.68km$$

The result obtained matches the expectation.

11 POWER FLOW

The instantaneous value of power load varies, in general, with continuity depending on the characteristics of the user appliances and their use, so during the day there are always variations of power. Also the generation contributes to the change in power flow level and direction, but this is not modelled.

It is therefore possible to represent load diagrams that identify the instantaneous power in a specific time. These are diagrams with a random trend, they are not referred to the single user but to groups of users that however lead to similar trends between them.

If the diagram is daily for a single user there will be three peaks that correspond to the morning, the lunch break and the evening.

A way to represent the chronological diagrams of the load is the duration curve. The x-value gives how long the corresponding y-power value is exceeded or equaled.

For this reason, it is interesting to see how the quantities vary when the power on the loads is modified.

By increasing the power that absorbs the load, at the transformers the current increases and the voltage decreases because more current is required to supply, there is the impedance of the transformer and therefore the voltage decreases.

APPLICATION

With the model of the network in Rscad, the idea is to change the power setting of the loads linked to the digital substation and see what happen.

Rscad allow to change one power setting because the simulation is in real time.

To do more than one change, we need to make a logic control, there are many possible configurations, for this work the configuration in Fig. 11.1 is the one adapted.

There are 7 sliders, one for each load, which allow to change the active power value, these values of active power are multiply by 0.2 to obtain the value of reactive power.

We use the constant 0.2 because is done the hypothesis of $\cos\varphi=0.985$ so the reactive power is the 20% of the active power.

So, after the decision of active power, a synbuf for each load collects it and, with a button, the change is done. The blue nodes in the Fig. 11.1 represent the active and reactive power and they can be plotted as we can see soon.

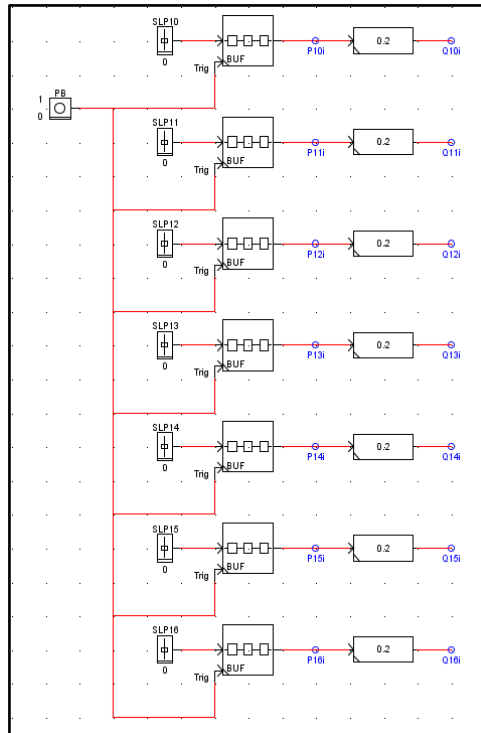

Fig. 11.1 Logic control for power changes

For example, to see the behaviour of the system, these values of active power are fed (the starting value is 1MW for every load):

- Active power on load 10 from 1MW to 1.3MW (and so from 0.2MVAR to 0.26 MVAR)
- P11 from 1MW to 1.2MW (Q=0.24MVAR)
- P12 from 1MW to 0.8MW (Q=0.16 MVAR)
- P13 from 1MW to 1.1MW (Q=0.22 MVAR)
- P14 from 1MW to 1.1MW (Q=0.22 MVAR)
- P15 from 1MW to 1.0MW (Q=0.2 MVAR)
- P16 from 1MW to 0.9MW (Q=0.18 MVAR)

The Rscad reaction is Fig. 11.2.

The results obtained reflect the changes made, both active and reactive power have the same values put in the sliders, the button goes into action at 0.20s.

This is for the loads, but how does the power on the transformer change at the digital substation when the loads require more, or less, power?

The setting of the loads is the same just used and in Rscad the power on the transformer 10, the one on the left side of the digital substation, is shown in Fig. 11.3.

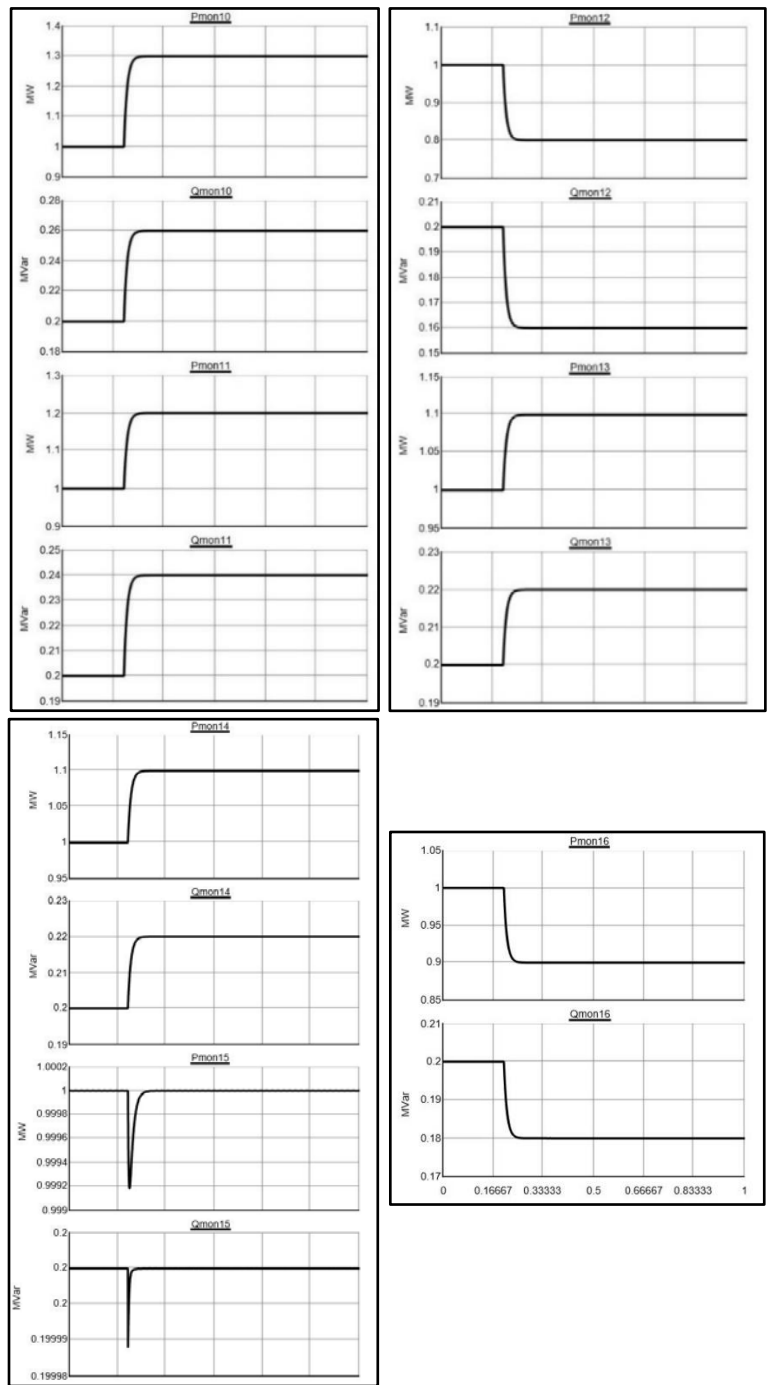

Fig. 11.2 Loads power measure in Rscad

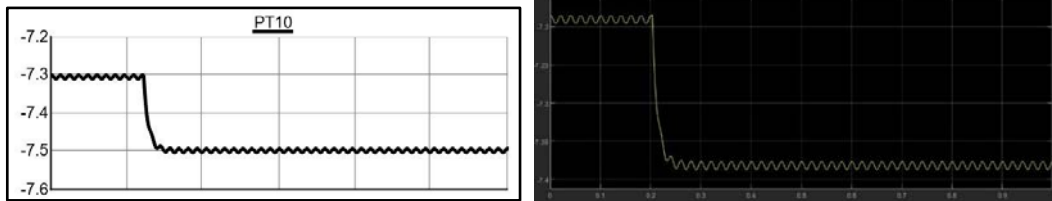

Fig. 11.3 Power at transformer 10 with Rscad and Simulink

The Fig. 11.3a is the output of Rscad instead the Fig. 11.3b is the output of Simulink. In Simulink the same value of current and voltage, generated by Rscad, are be considered due to the data saving function CSV, coma separate value.

$$P_{min} = 3 * \frac{\hat{V}}{\sqrt{2}} * \frac{\hat{I}}{\sqrt{2}} = 3 * 6.11 * 0.4 = 7.33MW$$

$$P_{max} = 3 * \frac{\hat{V}}{\sqrt{2}} * \frac{\hat{I}}{\sqrt{2}} = 3 * 5.93 * 0.42 = 7.47MW$$

The power calculation with the same values of current and voltage validates the Fig. 11.3a. The wave form is equal, but the magnitude is different.

PROBLEM

The set point in Simulink for the active and reactive power calculation block, under the mask, is in Fig. 11.4a and in the Fig. 11.4b there is the message written on it for the reactive power accuracy.

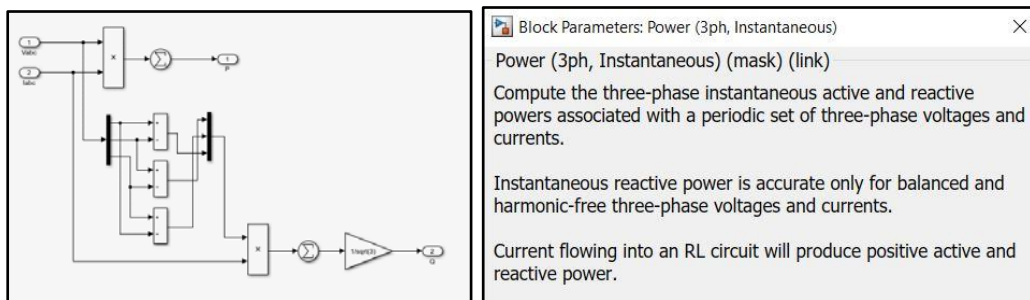

Fig. 11.4 Power calculation block and message in Simulink

The values of the reactive power are very different between Rscad and Simulink, the problem is probably the frequency. Plotting the frequency results in being less than 50Hz and therefore causes a problem with the phase shift angle

For this reason, will be analyze only the active power.

Five scenarios are recreated to see the power behavior in Rscad and Simulink. All the loads not direct connected to the DS have P=1MW and Q=0.01MVAR.

	LOAD	P _{OLD} [MW]	P _{NEW} [MW]	SUM [MW]
SCENARIO 1	10	1.3	0.9	15.4
	11	1.2	1.2	
	12	0.8	0.8	
	13	1.1	1.1	
	14	1.1	1.1	
	15	1.0	1.0	
	16	0.9	1.3	

Tab. 11.1 Power flow scenario 1

	LOAD	P _{OLD} [MW]	P _{NEW} [MW]	SUM [MW]
SCENARIO 2	10	0.9	1.4	18.6
	11	1.2	1.7	
	12	0.8	1.3	
	13	1.1	1.6	
	14	1.1	1.7	
	15	1.0	1.5	
	16	1.3	1.4	

Tab. 11.2 Power flow scenario 2

	LOAD	P _{OLD} [MW]	P _{NEW} [MW]	SUM [MW]
SCENARIO 3	10	1.4	1.9	22.5
	11	1.7	2.4	
	12	1.3	1.8	
	13	1.6	2.1	
	14	1.7	2.2	
	15	1.5	2.2	
	16	1.4	1.9	

Tab. 11.3 Power flow scenario 3

	LOAD	P _{OLD} [MW]	P _{NEW} [MW]	SUM [MW]
SCENARIO 4	10	1.9	2.3	24.2
	11	2.4	2.3	
	12	1.8	1.2	
	13	2.1	2.7	
	14	2.2	2.1	
	15	2.2	3.0	
	16	1.9	2.6	

Tab. 11.4 Power flow scenario 4

	LOAD	P _{OLD} [MW]	P _{NEW} [MW]	SUM [MW]
SCENARIO 5	10	2.3	2.2	24.4
	11	2.3	2.2	
	12	1.2	1.4	
	13	2.7	2.5	
	14	2.1	3.5	
	15	3.0	2.7	
	16	2.6	1.9	

Tab. 11.5 Power flow scenario 5

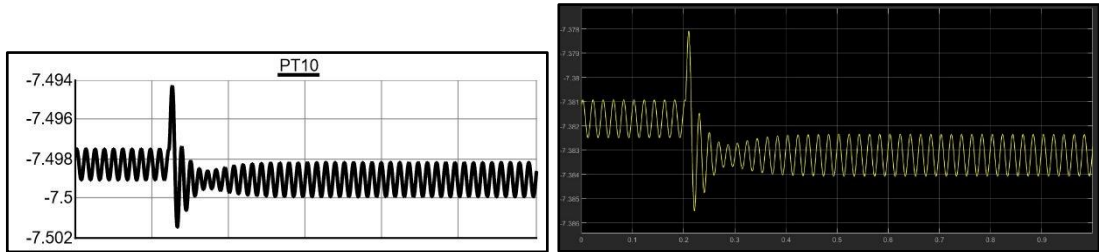

Fig. 11.5 Power at transformer scenario1

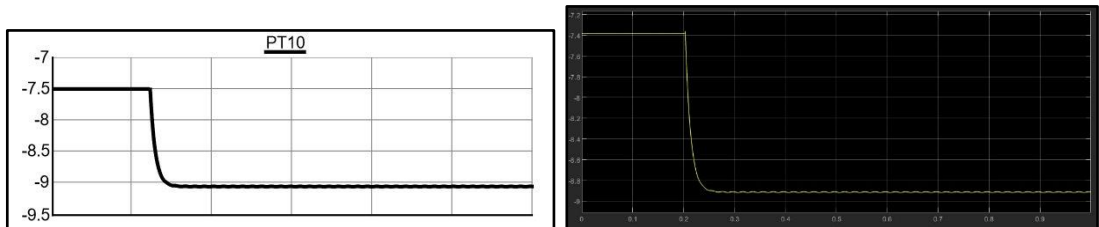

Fig. 11.6 Power at transformer scenario2

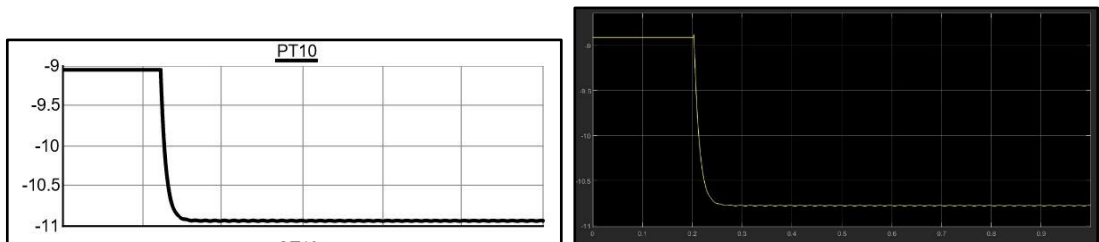

Fig. 11.7 Power at transformer scenario3

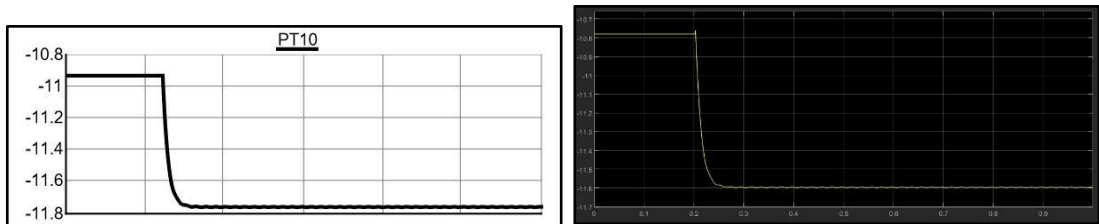

Fig. 11.8 Power at transformer scenario4

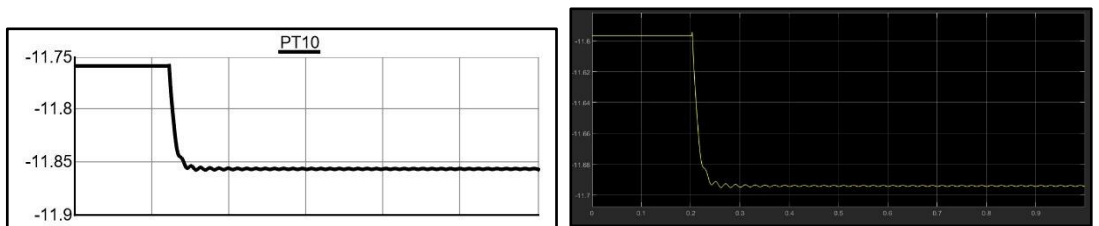

Fig. 11.9 Power at transformer scenario5

It is interesting to observe how small variations of power on the loads cause considerable variations in the transformer power.

For example, scenario 1, shown in figure 11.5, requires that all loads keep the active power constant, only load 10 goes from 1.3 to 0.9 while load 16 from 0.9 to 1.3 therefore the total power absorbed by the loads does not change, but there is a disruption on the wave form.

The scenario 2 presents a variation of 1.5MW when the loads power increases of 3.2MW.

Scenario 3: the power transformer increases of 2MW and the loads power is bigger of 3.9MW.

Scenario 4: the variation of power transformer of 0.8MW dues to a load variation of 1.7MW.

Scenario 5: power transformer increases of 0.1MW after a bigger loads power of 0.2MW.

The values in Simulink are bigger than the Rscad ones.

For the first scenario the gap between the magnitude is 0.116MW.

For the second scenario it is 0.12MW.

For the third scenario it is 0.1MW.

For the fourth the gap is 0.17MW.

For the fifth scenario it is 0.16MW.

12 SAMPLING RATE

A common topic that implicitly returns in all the previous chapters is the sampling rate, it consists in the process that allows to convert continuous time signal into discrete time signal.

What is the minimum sampling required to have good quality of measure about active power, reactive power and impedance?

There isn't a unique answer, from the literature there is the guidelines of Nyquist theorem. This theorem suggests having a sampling frequency of at least 2 times the maximum signal frequency

$$f_s = 2f_{max} \text{ [Hz]}$$

According with Nyquist, for a network with $f=50\text{Hz}$, the sampling frequency is

$$f_s = 2 * 50 = 100\text{Hz}$$

and the sampling period is

$$T_s = \frac{1}{f_s} = 0.01\text{ms}$$

With this assumption, in a period of 20ms, there are two samplings, one for the maximum value and one for the minimum. The number of the sampling comes from

$$\text{sampling points} = \frac{\text{wave period}}{\text{sampling period}} = \frac{20\text{ms}}{0.01\text{ms}} = 2$$

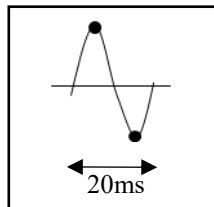

Fig. 12.1 2 sampling points

Usually the sampling frequency is higher than 2 times the max frequency, this is because we want to avoid subharmonics and expensive filters allowing to move the various replicas of the signal in the frequency domain between them.

The protection relay works with a frequency between 1kHz and 4kHz, it depends on the applications.

For the 7th harmonic (350Hz), according to Nyquist, the f_s would be 700Hz, but generally the sampling frequency is much higher, 10kHz to measure harmonics.

The sampling period of the overcurrent tested relay in HIL is

$$T_s = \frac{20\text{ms}}{24} = 8.3 \cdot 10^{-4} \text{ s}$$

where 24 is the number of sampling given by the constructor and so the sampling frequency is

$$f_s = \frac{1}{8.310^{-4}} = 1200\text{Hz}$$

APPLICATION

In Rscad draft, it is possible to know the time step, in this work the time step is $150\mu\text{s}$, so between 2 points passes $150\mu\text{s}$. In Fig. 12.2 is possible to identify this time step, on the left the value of time is 0.05655s and the one on the right is 0.0567 , step is $0.0567 - 0.05655 = 150\mu\text{s}$.

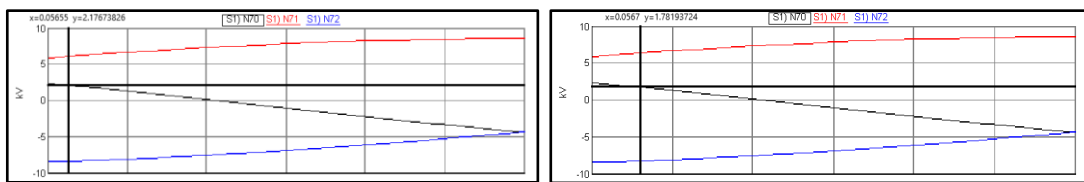

Fig. 12.2 Time step

The time step can be varied, we can change the sampling rate in “2 points” and the meaning is one point is sampled and one is skipped, so the time between two samples is $300\mu\text{s}$.

With $\text{SR}=4$ the time between two points is $600\mu\text{s}$.

With $\text{SR}=8$ the time between two points is $1200\mu\text{s}$.

With $\text{SR}=16$ the time between two points is $2400\mu\text{s}$.

With $\text{SR}=32$ the time between two points is $4800\mu\text{s}$.

With $\text{SR}=64$ the time between two points is $9600\mu\text{s}$.

The frequency is 50Hz , the number of sampling in each period is:

$$\text{number of sampling}_4 = \frac{20\text{ms}}{0.6\text{ms}} = 33$$

$$\text{number of sampling}_8 = \frac{20\text{ms}}{1.2\text{ms}} = 17$$

$$\text{number of sampling}_{16} = \frac{20\text{ms}}{2.4\text{ms}} = 8$$

$$\text{number of sampling}_{32} = \frac{20\text{ms}}{4.8\text{ms}} = 4$$

$$\text{number of sampling}_{64} = \frac{20\text{ms}}{9.6\text{ms}} = 2$$

The Fig. 12.3 is the example of $\text{SR}=32$, with the sampling period of 4.8ms , 50Hz of frequency and 20ms of period.

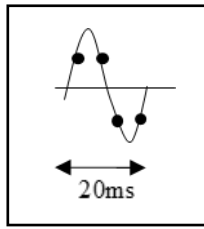

Fig. 12.3 4 sampling points

To know the difference between the sampling rates, in the network model, active and the reactive power of the loads are set as follow

LOAD	ACTIVE POWER [MW]	REACTIVE POWER [MVA]
L2	1	0.01
L3	1	0.01
L4	1	0.01
L5	1	0.01
L6	1	0.01
L7	1	0.01
L8	1	0.01
L9	1	0.01
L10	1.1	0.22
L11	1.0	0.2
L12	1.4	0.28
L13	1.2	0.24
L14	1.5	0.3
L15	2.7	0.54
L16	0.5	0.1

Tab. 12.1 Active and reactive power on the loads

The same seven different scenarios will be analysed, they are:

- SR=every point, Fig. 6.4
- SR=2 points, Fig. 6.5
- SR=4 points, Fig. 6.6
- SR=8 points, Fig. 6.7
- SR=16 points, Fig. 6.8
- SR=32 points, Fig. 6.9
- SR=64 points, Fig. 6.10

The idea is to compare the active power on the transformer 10, output of Rscad and Simulink, changing the sampling rate and find out the gap between the two calculators. Does it vary according the SR?

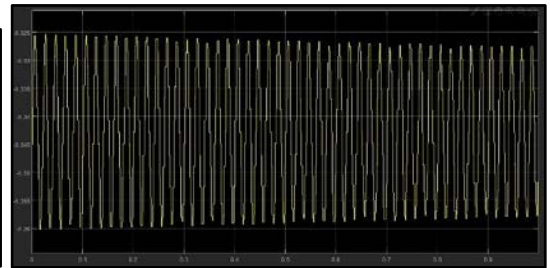
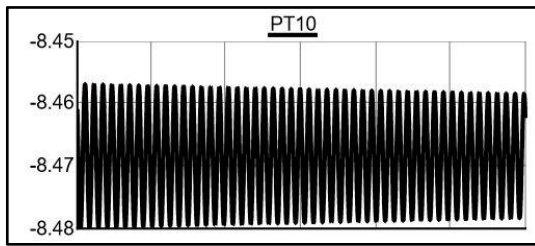

Fig. 12.4 Power at transformer 10 SR=1

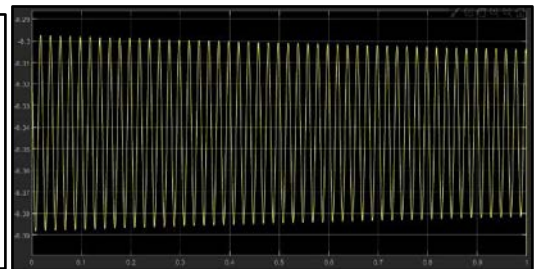
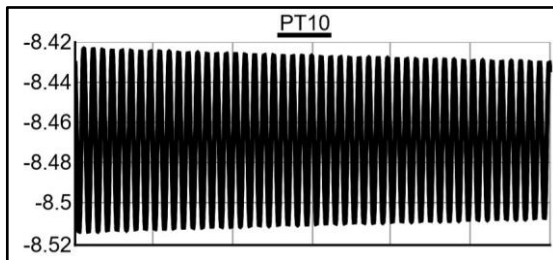

Fig. 12.5 Power at transformer 10 SR=2

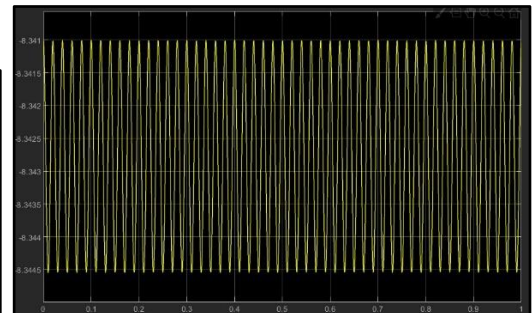
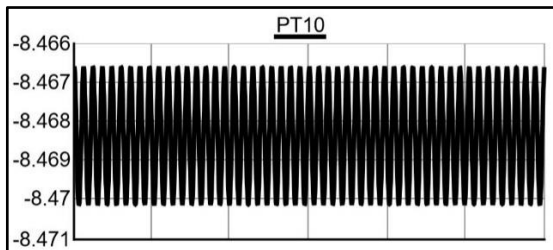

Fig. 12.6 Power at transformer 10 SR=4

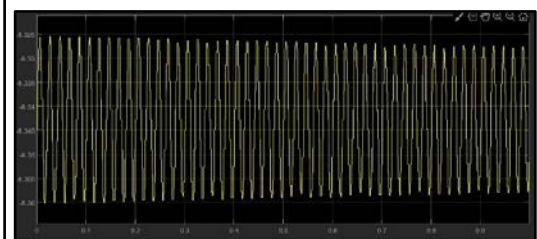
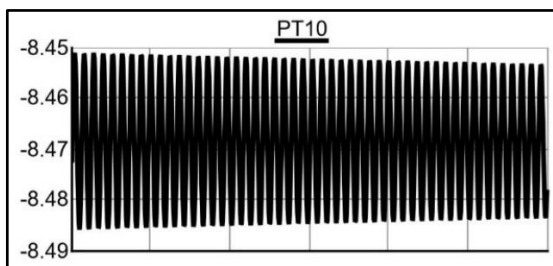

Fig. 12.7 Power at transformer 10 SR=8

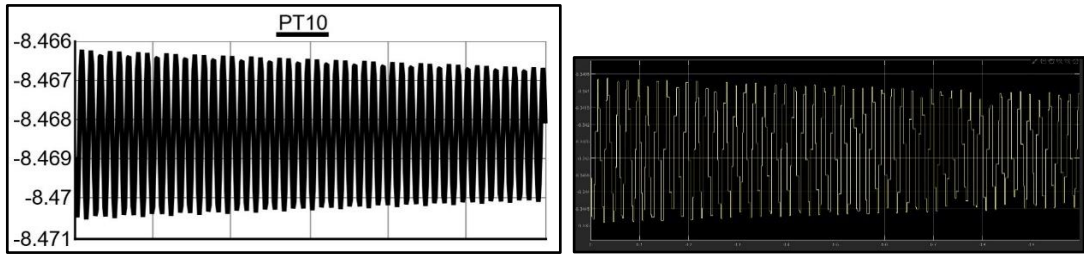

Fig. 12.8 Power at transformer 10 SR=16

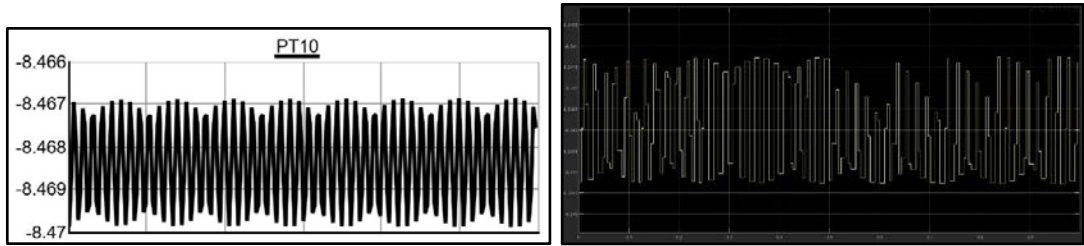

Fig. 12.9 Power at transformer 10 SR=32

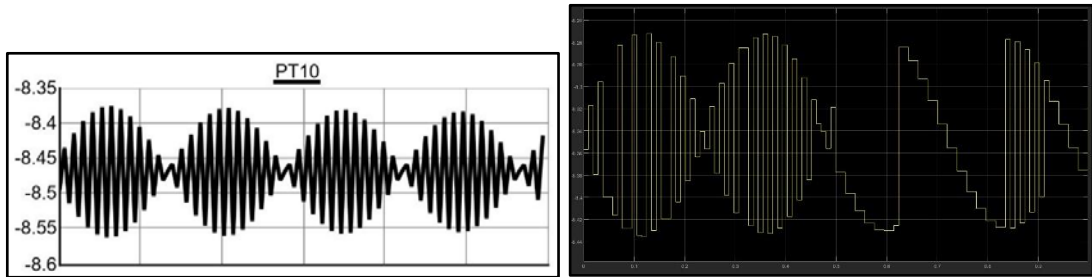

Fig. 12.10 Power at transformer 10 SR=64

The choice to analyze only the active power is due to the fact that in Simulink the block underlines the instantaneous reactive is accurate only for balanced and harmonic-free three phase voltage and current. So, we have seen that there is a discrepancy between the reactive power values, only the active power is analyzed in this chapter because we are interested in the sampling.

The mean active power for each scenario is presented in Tab.12.2, there is a shift of the waves, 0.1MW, but the wave form is similar. Probably when the data are moved there are some variations.

SR	P MEAN [MW] in RSCAD	P MEAN [MW] in SIMULINK	DELTA P MEAN [MW]
1	8.468	8.343	0.125
2	8.468	8.343	0.125
4	8.468	8.343	0.125
8	8.468	8.346	0.122
16	8.468	8.343	0.125
32	8.468	8.492	0.024

Tab. 12.2 Mean value of active power with Rscad and Simulink with different SR

If we analyze the mean active power with Rscad, we can see that the magnitude is always 8.468MW, but if we check the graphs, it is clear the quality of the wave form is not the same. With $SR=1$ is not possible to see the sampling points, it is nearly a continuous wave. Decreasing the sampling points, the waves are more serrated, in Fig. 12.10 every drop can be identify.

The mean active power with Simulink is a little less constant, in the last three scenarios there is a variation, we can say that the decreasing of the sampling points leads to a reduction of quality and information may be loss.

Nyquist theorem, as we said before, in this situation at $f=50\text{Hz}$ and $T=20\text{ms}$ of period, suggests having $f_s=100\text{Hz}$ and so 2 sampling points. This is the case of the last scenario, $SR=64$. We need to find the right compromise between the number of points to be sampled, thus increasing the resources to do so, and the amount of useful and necessary information based on the application.

13 HIL [11][12][13]

RTDS are also used to Hardware In the Loop (HIL) Simulations which consist in a device connected to the RTDS that models the rest of the system and the device does not detect the difference between the real-time simulator and the actual power-system environment.

HIL is an interesting stage between a mere computer-based simulation (harmonic distortions and frequency deviations are included), with the problems concerned as noise or problematic software that can't be modelled in a good way, and real device deployment.

The aim of this simulation is testing devices in more realistic circumstances, in a cheaper way, and connecting this equipment in a safer situation.

There are two types of HIL testing: CHIL (controller hardware in the loop) and PHIL (power hardware in the loop). With CHIL, current-carrying devices are simulated and only control and instrumentation devices are implemented as physical hardware; with PHIL also a current-carrying device is implemented in hardware.

13.1 OVERCURRENT RELAY HIL TESTING

The HIL testing of the overcurrent relay is done to validate the RSCAD and Simulink results. This type of testing is a CHIL (=controller HIL simulation) and low-level transmitting signals ($\pm 15V$, mA) are involved. In Fig. 13.1 is provided a simple scheme to explain the link between the equipment.

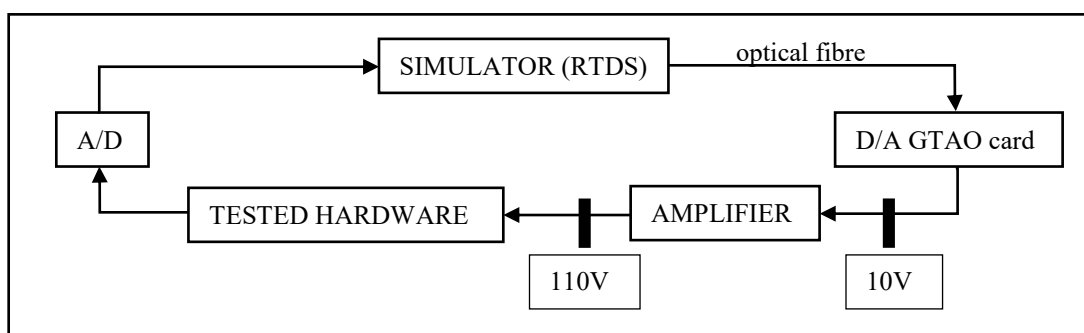

Fig. 13.1 Devices loop

In the Fig. 13.2a is shown the overcurrent relay, in the Fig. 13.2b there is the amplifier (the analog output of the Rtds is small, up to 10V so an amplifier to amplify the signal is needed) and in the Fig. 13.3 is presented the connection of all devices used in this simulation, where the red cable connects the Rtds to the amplifier, and the optical fibre passes over for safety reason so it can't be seen in the picture.



Fig. 13.2 Overcurrent relay and amplifier



Fig. 13.3 All devices connection

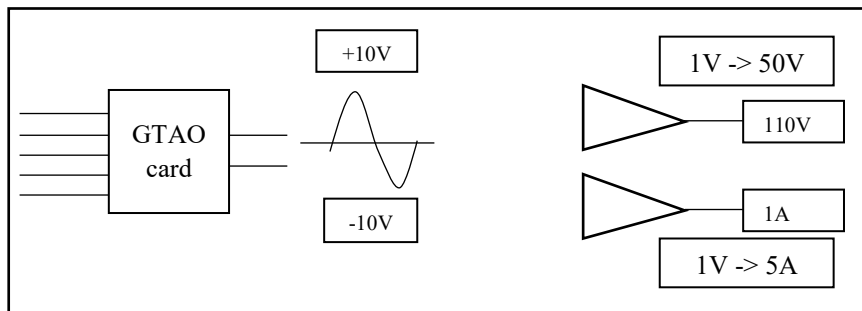

Fig. 13.4 Amplifier logic

The relay is linked to VT (110V line to line) and CT (1A nominal load current, at input I have 1A or 5A).

The output of Rscad is a voltage (called voltage output), the amplifier gives us voltage and current, but it has a fix gain, every 1V we have 50V, every 1V we have 5A. If the amplifier has a fix gain, values through the GTAO (green small devices in the Fig. 3.5c) can be modified.

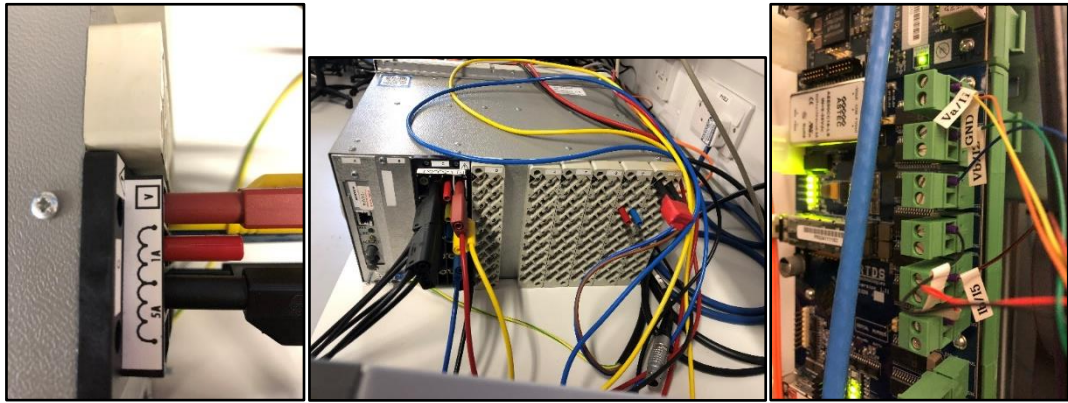

Fig. 13.5 Connections

The power supply is in DS.

The two small red and blue connections, in the picture b, are the trip output, the command of circuit breaker to open.

VT has the star connection, the neutral is linked to the last connection.

3 common points to connect together (VT)

We need a GTAO (in I/O components), we imagine putting the relay near the circuit breaker 1024, it is fed it with 3 currents and 3 voltages.

If we go to the main window of Rscad and we open Tools, Config File Editor, we can choose the rack, the card, and which port to use.

TO SET THE RELAY VOLTAGE

We use the T10 voltage (the nodes voltage N70, N71, N72) as input of GTAO, it is too high, and if we look to the scaling, we can see that 187,79V as input give us 5V as output (D/A output scaling). We change 187.79V in 5V so the scaling is 1:1.

$$\text{Relay voltage(peak phase value)} = \frac{110}{\sqrt{3}} * \sqrt{2} = 89.08146239V$$

$$\text{Amplifier input} = \frac{\text{relay voltage}}{50} = 1.796292478V$$

$$\text{Network} = \frac{11000}{\sqrt{3}} * \sqrt{2} = 8981.462V$$

$$\text{IO scaling} = \frac{\text{network}}{\text{amplifier input}} = 5000$$

$$\text{Value to put} = \frac{1}{\text{IO scaling}} = 0.002$$

but we use 0.2 because in Rscad there aren't KV.

A meter is used to check the gain, so we don't damage the equipment.

If the values aren't the ones we expected, we take a look to the input relay configuration and also to the set of the CT and VT ratio.

In the amplifier the voltage would be 110V line line and we read 103V, 89.9V line neutral and we read 59.9V.

TO SET THE RELAY CURRENT

I need the max fault current, so I apply the phase phase phase ground fault. The peak value of the current of the circuit breaker 1024 is 20kA.

$$\begin{aligned} \text{Relay current} &= 1A \\ \text{Amplifier input} &= \frac{\text{relay current}}{5} = 0.2A \\ \text{Network} &= 20000A \text{ (fault current peak value)} \end{aligned}$$

$$\begin{aligned} \text{IO scaling} &= \frac{\text{network}}{\text{amplifier input}} = 100000 \\ \text{Value to put} &= \frac{1}{\text{IO scaling}} = 0.00001 \end{aligned}$$

but we write 0.1 for the same voltage reason.

We know that for 1V as input we have 5A as output.

If we take a look to the output of the GTAO=0.058V (input) and the value of the relay=0.29 (output) we can see that the ratio is the same.

TRIP SIGNAL

We use the GTFPI (card which control the front of Rtds).

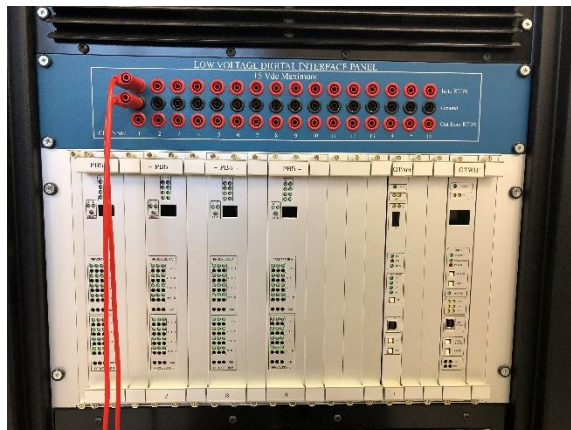

Fig. 13.6 GTFPI

In the block there is the “include Hv panel signals”, if I enable this one I enable the bottom part, not three rows but six.

We need to monitor the system so after the GTFPI I put a work/bit converter and as output a node called “trip”.

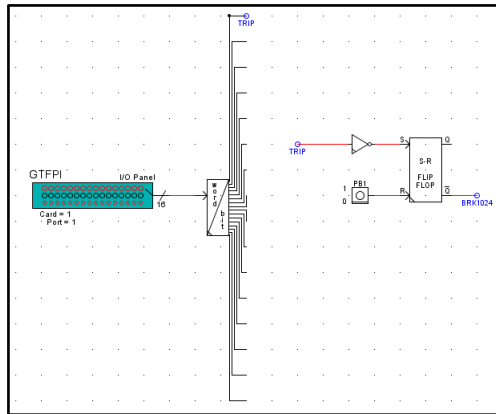

Fig. 13.7 GTFPI in Rscad

Overcurrent relay (protection relay) is an open-closed device, we need a flip flop to remain open and a button to reclose the breaker.

SIMULATION

Now the configuration is:

The relay connected to Rscad with an amplifier between them, Rscad is considered the real network and the relay can be tested.

We decide to do HIL test because there was a different behaviour of Rscad value of power and Simulink value of power.

The problem is constant in all the simulation, but it will be analysed the scenario where the active power on load 10 changes from 1MW to 20MW instead the reactive power is always 0.01MVAR.

The simulation with Rscad shows the following situation: active power and reactive power are suited with the input.

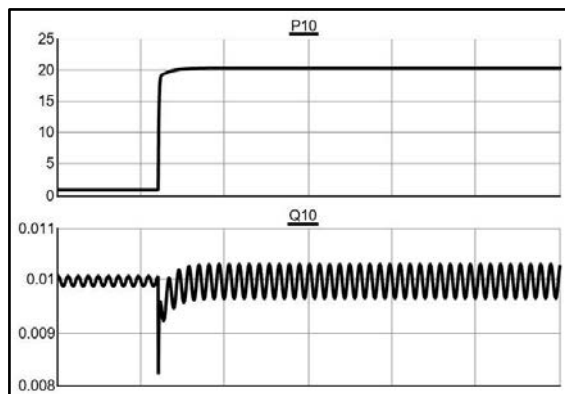

Fig. 13.8 Active and reactive power on load 10 in Rscad

The simulation with Simulink is almost good for the active power, there is a problem with the reactive power because the value is very different. The trend is in Fig. 13.9.

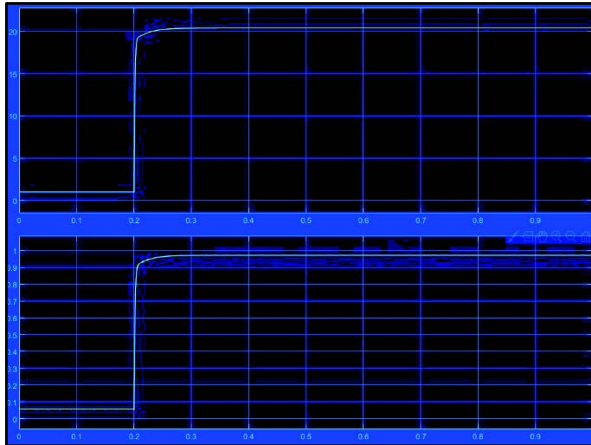

Fig. 13.9 Active and reactive power on load 10 in Simulink

What is the right output? Rscad or Simulink?

I try to do the reverse case, changing the load 10 with an impedance R_1 , X_L and R_2 . I calculate the value of resistance and inductance to have 1MW and 0.01MVAR so I try to understand the problem. I have a peak voltage value of 8.55kV with rms value of 6.05kV. For the current 0.077kA with rms value of 0.054kA.

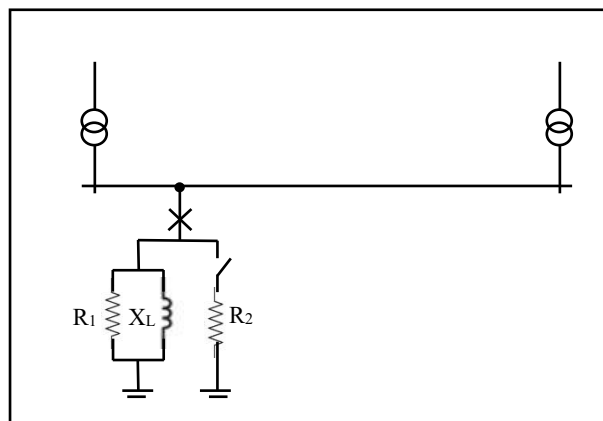

Fig. 13.10 RRL circuit

For resistance per phase and inductance per phase, I use the phase voltage.

$$P = 3 * R * I^2 = 3 \frac{V^2}{R} = 1MW$$

$$R1 = 3 \frac{V^2}{P} = 109.81\Omega$$

I calculate the value of R2 doing the parallel between R1 and R2:

$$R1 \text{ parallel } R2 = \frac{R1 * R2}{R1 + R2} = 3 \frac{V^2}{P} = 5.49\Omega$$

so $R_2=5.78\Omega$

$$Q = 3 * X_L * I^2 = 3 \frac{V^2}{X_L} = 0.01 \text{MVAR}$$

$$\text{so, } X_L = 3 \frac{V^2}{Q} = 10980.75\Omega$$

$$X_L = \omega * L = 2\pi * f * L$$

$$\text{and to have the inductance } L = \frac{X_L}{2\pi * f} = \frac{10980.75}{2\pi * 50} = 34.95 \text{H}$$

So, I put on Rscad:

$R_1=109.81\Omega$

$R_2=5.78\Omega$

$L=34.95\text{H}$

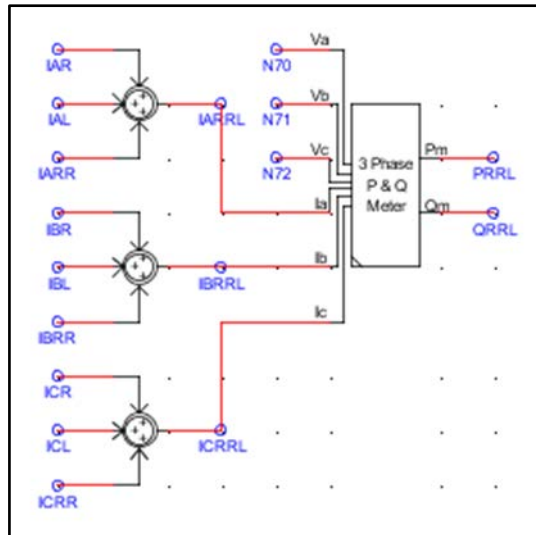

Fig. 13.11 RRL power measure

There are R_1 and R_2 because, the variation that we are interested in, is on the active power, so when the switch closes, there is the power variation. There is only X_L because the reactive power is the same.

In Fig. 13.11 the logic to calculate the P_{RRL} , active power on the impedance RRL, and Q_{RRL} , reactive power on the impedance RRL is shown.

In the Fig. 13.12a there are the Rscad representation of the power in RRL, the expectations have been fulfilled: active power from 1MW to 20MW, reactive power from 0.01MVAR to 0.01MVAR.

The Fig. 13.12b shows the current and the voltage at the left transformer at the substation. When the RRL passes from 1MW to 20MVAR the current increases and the voltage decreases.

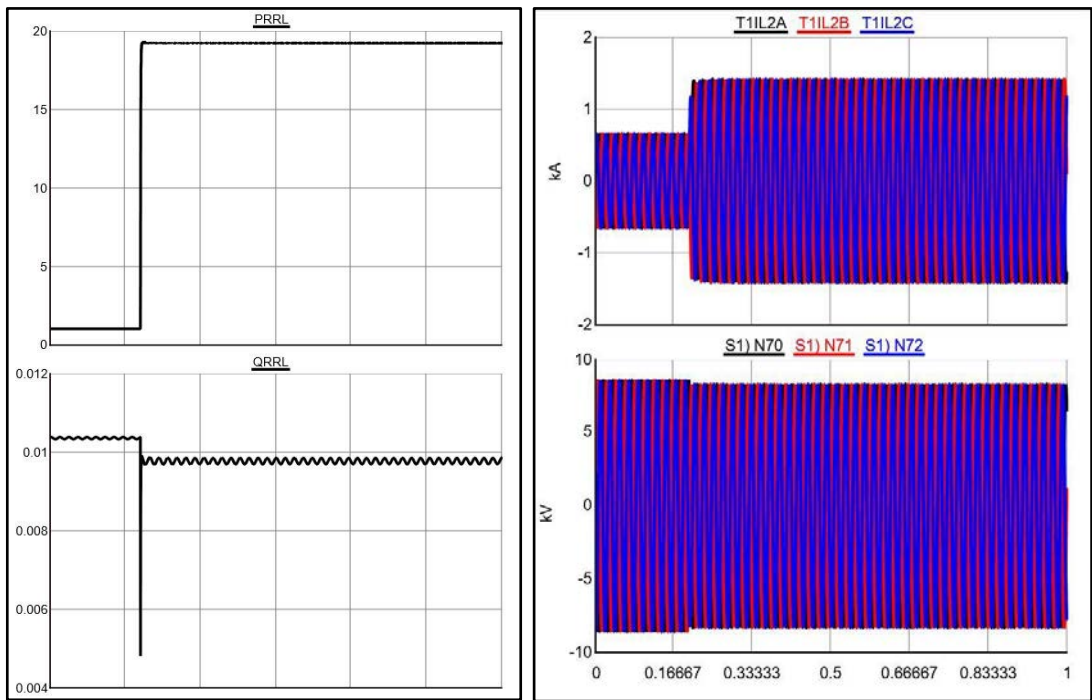

Fig. 13.12 RRL power, current and voltage on T10

It has been shown that the power on the load 10 and also with RRL changes from 1MW to 20MW and the reactive power stays constant to 0.01MVAR.

14 PROTECTIONS [4], [14]

The interest in evaluating the distance to the fault certainly derives from the desire to put out of service the shortest possible stretch of line and solve the problem in quick times.

The devices that are used to monitor electrical and non-electrical quantities by comparing the characteristics with preset reference values are called protections and are those that allow the disconnection of sections of the network when a fault occurs.

The protections can be classified according to different characteristics:

- what they controlled (voltage, current, frequency, power, temperature, speed, pressure, impedance, luminous intensity)
- how they controlled (minimum, maximum, differential, directional).
- control actions (direct, indirect)
- how they operate (time dependent, time independent, time steps, dependent and independent combined, out of the domain)
- operation mode (direct, indirect, matching)
- operating principle (electromagnetic, electrodynamic, induction, thermic, mechanical, oil-pressure protections)

It is important to design the protection scheme, this operation must take into account the faults that can occur on the network, the frequency, the duration and the power flows involved, but also control the setting of the devices because on the network there are continuous changes of power flows and loads but also for generation.

Another important aspect is to test the devices with realistic simulation because in this way you have the possibility to understand if the tested element is the right one for that specific function.

15 CONCLUSIONS

This work is a small example of how a digital substation can be actively exploited for the automation and control of functions on the network.

The modeling of the network with the Rtds has led to good results.

The challenge of digitizing substation data is not only an intelligent way to exploit the knowledge acquired on several fields, to make better use of time and space, but it allows the electricity grid to move with the times, to adopt the internet of things.

The digital interconnection, the exchange of data and the redundancy of the systems will allow an improvement in the service that can make an entire nation safer or, why not, a group of nations, in a future in which the competitiveness of the economy will depend heavily on the electrical infrastructure and its reliability.

The hope is that the potential of the Rtds combined with the innovative concept of the digital substation can be widely known and applied.

16 REFERENCES

- [1] K.J.P.Macken, H.J.Bollen and R.J.M.Belmans, “Mitigation of voltage dips through distributed generation systems”, IEEE Transactions on Industrial Applications, Vol. 40, Nov/Dec 2004
- [2] S.Repo, H.Laaksonen, P.Järventausta, O.Huthtala, M.Mickelsson – “A case study of voltage rise problem due to a large amount of distributed generation on a weak distribution network”, IEEE Bologna PowerTech Conference, Bologna, Italy, June 2003
- [3] Dr.Stephen Clifford, ABB Grid Automation Systems – “Digitalization. What it means, and impact on utilities” 2016-09-22
- [4] Alstom, Network protection & automation guide
- [5] <https://www.rtds.com/real-time-power-system-simulation/>
- [6] https://digital.ijre.org/index.php/int_j_res_eng/article/view/318
- [7] <https://ieeexplore.ieee.org/document/4771454>
- [8] http://www.diee.unica.it/~musai/Elettrotecnica/Modellazione_%20delle_linee_elettriche.pdf
- [9] S. Das, S. Santoso, A. Gaikwad, M. Patel – “Impedance-Based Fault Location in Transmission Networks: Theory and Application”, IEEE, May 2014
- [10] Nasser Tleis, Power system modelling and fault analysis
- [11] Physical Hardware-in-the-Loop Modeling and Simulation, Andrew Roscoe, Efren Guillo-Sansano, and Graeme Burt University of Strathclyde, Glasgow, UK
- [12] https://www.rtds.com/wp-content/uploads/2015/12/RTDS_PHIL_Report-1.pdf
- [13] <https://pdfs.semanticscholar.org/d8db/504b00c865f3a8cfb46eed8fdadca01f3add.pdf>
- [14] Benato, Fellin, Wolters Kluwer Italia, Impianti elettrici - cap10

17 ACKNOWLEDGEMENTS

A special thanks goes to Professor Roberto Turri for giving me the opportunity to do this thesis work at the PNDC center, in this period I have learned a lot from a technical point of view but also I've grown as a person.

I also want to thank Dr. Federico Coffele for welcoming me, for bringing me on this journey and for allowing me to put into practice theoretical knowledge learned over the years.

I certainly can't forget all the people who work at the PNDC center to help me in any way, to allow me to live peacefully these months and to have given me the opportunity to learn about customs and traditions all over the world.

I want to mention in particular: Ibrahim, for the patience he has had in answering my countless questions, for the trust he has placed in my work and for all the help he has given me; Kinan for treating me like a daughter, believing in me and encourage me to always give my best and Kathleen for cheering me up with healthy Hispanic-Scottish madness.

Fundamental and irreplaceable, in this long and troubled journey, it was my family to whom an immense thank you goes. Thank you for having praised me in the victories and helped me in the defeats, for having supported my every choice and for always being by my side. This goal is yours too.

Last but not least all my friends, old and new, near and far, for having understood and encouraged me, for having been close to me in moments of despair and for always being present despite everything.

18 RINGRAZIAMENTI

Un ringraziamento speciale va al professor Roberto Turri per avermi dato la possibilità di svolgere questo lavoro di tesi presso il centro PNDC, in questo periodo ho avuto la fortuna di imparare molto dal punto di vista tecnico ma anche di crescere e maturare come persona.

Voglio ringraziare anche il dottor Federico Coffele per avermi accolta, accompagnata in questo percorso e per avermi permesso di mettere in pratica conoscenze teoriche apprese durante il corso degli anni.

Non posso certo dimenticare tutte le persone che lavorano al centro PNDC per avermi aiutata in qualsiasi modo, per avermi permesso di vivere in serenità questi mesi e per avermi dato la possibilità di conoscere usi e costumi di tutto il mondo.

Voglio citare in particolare: Ibrahim, per la pazienza che ha avuto nel rispondere alle mie innumerevoli domande, per la fiducia che ha riversato nel mio lavoro e per tutto l'aiuto che mi ha dato; Kinan per avermi trattato come una figlia, credendo in me e spronandomi a dare sempre il massimo e Kathleen per avermi rallegrato le giornate con una sana ispanico-scozzese pazzia.

Essenziale e insostituibile, in questo percorso lungo e travagliato, è stata la mia famiglia a cui va un immenso grazie. Grazie per avermi elogiata nelle vittorie e sostenuta nelle sconfitte, per aver appoggiato ogni mia scelta e per essere sempre al mio fianco. Questo traguardo è anche vostro.

Ultimi ma non per importanza tutti i miei amici, vecchi e nuovi, vicini e lontani, per avermi capita e incoraggiata, per essermi stati vicini nei momenti di sconforto e per essere sempre presenti nonostante tutto.