



Publication Year	2016
Acceptance in OA @INAF	2023-02-15T16:17:12Z
Title	INAF/JPL LNAs: VNA WARM TEST. As Run Procedure and Results.
Authors	CUTTAIA, FRANCESCO; MARIOTTI, SERGIO; NESTI, Renzo; PANELLA, Dario; VILLA, Fabrizio
Handle	http://hdl.handle.net/20.500.12386/33503
Number	iALMA-TEC-TRP-IAB-001



Science and Technology in Italy
For the upgraded ALMA Observatory
- TECHNOLOGY DEVELOPMENT -

INAF/JPL LNAs: VNA WARM TEST. As Run Procedure and Results.

Document code: iALMA-TEC-TRP-IAB-001-A

Version: A

Status: Issued

Date: 14/01/2016

Prepared by		
Name	Organization	Date
		14-01-2016
F. Cuttaia	INAF/IASF	
S. Mariotti	INAF/ORA	
R. Nesti	INAF/OAA	
D. Panella	INAF/OAA	
F. Villa	INAF/IASF	
Approved by		
Name	Organization	Date
		14-01-2016
Fabrizio Villa	INAF/IASF-Bologna	
Francesco Cuttaia	INAF / IASF-Bologna	



1 Change Record

Version	Date	Affected sections	Reason
0.1 DRAFT	27/09/2015	All	First issue
ISSUE A	14/01/2016	All	General revision

2 Distribution List

Francesco Cuttaia	INAF/IASF-Bologna	cuttaia@iasfbo.inaf.it
Pavel Yagoubov	ESO	pyagoubo@eso.org
Alvaro Gonzalez	NAO Japan	Alvaro.Gonzalez@nao.ac.jp
Gary Fuller	UNI-MAN	G.Fuller@manchester.ac.uk
Renzo Nesti	INAF-Arcetri	nesti@arcetri.astro.it
Brian Ellison	STFC-RAL	Brian.ellison@stfc.ac.uk
Patricio Mena	UNI-CHILE	pmena@ing.uchile.cl
Valeria Tapia	UNI-CHILE	vale.tapia.l@gmail.com
Nicolas Andres Reyes Guzman	UNI-CHILE	nireyes@u.uchile.cl
Danielle George	UNI-MAN	Danielle.George@manchester.ac.uk
Leonardo Testi	ESO	ltesti@eso.org
Robert Laing	ESO	rlaing@eso.org
Fabrizio Villa	INAF/IASF-Bologna	villa@iasfbo.inaf.it
Adriano De Rosa	INAF/IASF-Bologna	derosa@iasfbo.inaf.it
Luca Terenzi	E-Campus/INAF	terenzi@iasfbo.inaf.it
Maura Sandri	INAF/IASF-Bologna	Sandri@iasfbo.inaf.it
Sara Ricciardi	INAF/IASF-Bologna	ricciardi@iasfbo.inaf.it

3 Applicable and reference Documents

AD-1.	Front-End Sub-System for the 12 m-Antenna Array Technical Specifications	ALMA-40.00.00.00-001-A-SPE	2007-04-17
AD-2.	Front End Budgets	FEND-40.00.00.00-134-A-GEN	2008-08-13
AD-3.	ALMA Scientific Specifications and Requirements	ALMA-90.00.00.00-001-A- SPE V.A	2006-July-28
AD-4.	ALMA System Technical Requirements	ALMA-80.04.00.00-005-C-SPE V.C	2012-12-10
AD-5.	System Design Description	80.04.00.00-002-D	2004-02-20
AD-6.	B2+4 Warm Test Baseplate ICD	iALMA-TEC-ICD-IAB-001-H	2016-01-14



4 Acronyms

LNA	Low Noise Amplifier
WTB	Warm Test Baseplate
VNA	Vector Network Analyzer
OMT	Ortho Mode Transducer



5 Table of content

1	Change Record	1
2	Distribution List	1
3	Applicable and reference Documents	1
4	Acronyms	2
5	Table of content	3
6	Introduction and Scope	6
7	Logistic	7
8	Devices Under Test	7
8.1	LNAs	7
8.1.1	Electrical Specifications:	8
8.2	Detector diode	9
9	Equipment	9
9.1	VNA	10
9.1.1	VNA Calibration Kit	11
9.2	Power supplier Unit (PSU)	12
9.3	Power Meter (PM)	13
9.3.1	Power Meter head	13
9.4	Spectrum Analyser (SA)	13
9.5	Portable Oscilloscope	13
9.6	Portable Amperometer	13
9.7	Mixer	13
9.8	Attenuator	14
9.9	Notebook	14
9.10	Miscellanea	14
9.10.1	Cables	14
9.10.2	WR10 connectors	14
9.10.3	Antistatic bracelet	14
10	As Run Procedure	15
10.1	Calibration	15
10.2	VNA characterization	15



10.3	Test 1: LNA "S217" GAIN	16
10.3.1	OPTIONS	17
10.4	Test 2: LNA "S217" Compression Point	19
10.4.1	Option 1:	19
10.4.2	Option 2:	19
10.4.3	Record data	22
10.5	Test 3: LNA "S220" GAIN	23
10.5.1	OPTION	24
10.6	Test 4: LNA "S220" Compression Point	26
10.6.1	Option 1:	26
10.6.2	Option 2:	26
10.6.3	Record data	28
10.7	Comparison between S217 and S220	29
10.8	Cascaded LNAs: VNA TRL Calibration	30
10.9	Test 5: Cascaded LNAs "S217" + "S220"	31
10.9.1	Nominal Id Bias setup:	31
10.9.2	Reduced Id Bias setup on LNA S220:	34
10.9.3	Comparison between nominal and reduced bias setup	37
10.10	Test 5: Cascaded LNAs "S220" + "S217"	43
10.10.1	Nominal Id Bias setup:	43
10.10.2	Reduced Id Bias setup on LNA S220:	46
10.10.3	Comparison between nominal and reduced bias setup	50
10.11	Comparison between the two configurations: S217+S220 against S220+S217. VNA Input level @ -45 dBm	56
10.11.1	Total Return Loss	56
10.11.2	Total Insertion Gain	57
10.12	Comparison between the two configurations: S217+S220 against S220+S217. VNA Input level @ -40 dBm	58
10.12.1	Total Return Loss	58
10.12.2	Total Insertion Gain	59
10.13	Cascaded configurations: general comments.....	60
10.14	Check Oscillations (TBC).....	61
10.15	Test 6: Cascaded LNAs Compression Point (TBC).....	62
10.16	Test 10: Cascaded "S217" + "S220" LNAs + WR 10 Diode.....	63



10.16.1	Record data	66
10.16.2	OPTION 1	67
10.16.3	OPTION 2:	67
10.17	Test 10: Cascaded "S220" + "S217" LNAs + WR 10 Diode.....	68
10.17.1	Record data	69
10.17.2	OPTION 1	69
10.17.3	OPTION 2:	69
11	Comparison with results from previous test campaign.....	70
12	Conclusions.....	72



6 Introduction and Scope

INAF/JPL LNAs will be implemented as a part of the B2+3 WTB (Warm Test Baseplate) to amplify the signal coming from the OMT: the signal is expected to be amplified by roughly 40 dB before being delivered to a downconverter. This is obtained using two cascaded LNAs.

LNAs have been designed to be used in the nominal W band [75 GHz: 110 GHz], originally furnished with a filter peaked around 94 GHz and a square law detector.

Nevertheless, we want to test the LNAs in the extended B2+3 band between 67 GHz and 116 GHz.

PHASE 0

The LNAs response to DC biasing was verified before the LNAs delivery to INAF-OAA. The test showed that LNAs respond to biasing and to bias change, in current (when Gate Voltage is changed) and in Gain (when Drain Current is changed).

PHASE 1

For the time being, we are just interested at characterizing the LNA's properties in warm (room temperature) conditions, with major respect to:

- Individual Gain
- Total Gain
- Individual Bandpass
- Total Bandpass
- Gain Compression effects

LNAs can be coupled to a diode detector converting RF signal into DC voltage. The conversion constant of the diode will be (TBC) measured.

PHASE 2

As a second step, noise temperature in warm conditions will be measured.

7 Logistic

PHASE 0: it was performed at the INAF-IRA Microwave Laboratory on September 24th 2015.

PHASE 1 tests will be performed at INAF/OAA (Arcetri), in the Microwave Lab.

PHASE 2 the baseline is to perform tests at INAF/IRA (Bologna) Microwave Laboratory or at INAF/IASF Microwave Laboratory.

8 Devices Under Test

8.1 LNAs

Two LNAs will be tested; they are respectively labelled as:

- "S220"
- "S217"

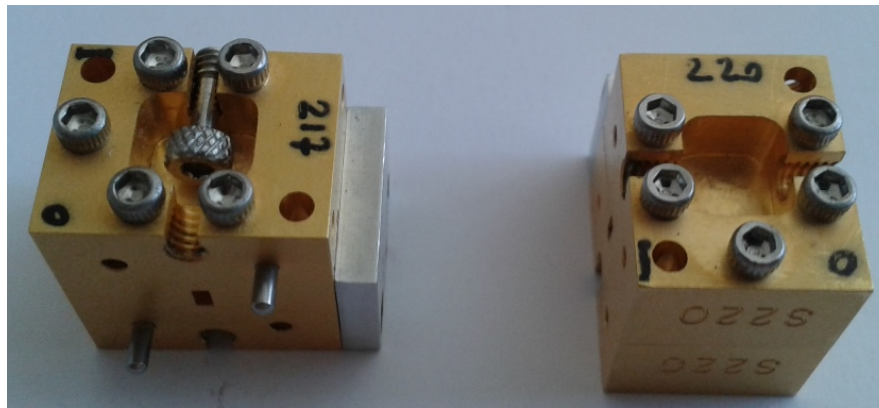

Figure 1 INAF/JPL LNAs S217 (left) and S220 (right)

Overall dimensions and interfaces are displayed in Figure 2. LNAs can be connected each other and to the following components of the RF chain, through standard UG-387 flanges.

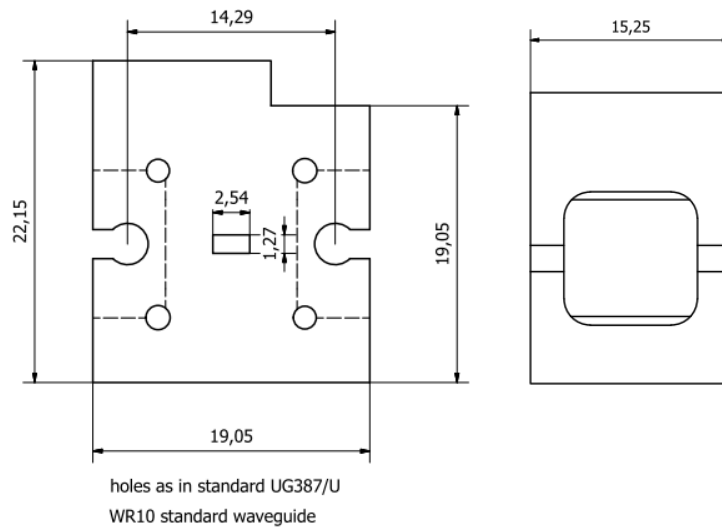

Figure 2 INAF LNA: the two threaded open holes allow the coupling to standard UG-387 flanges.

8.1.1 Electrical Specifications:

8.1.1.1 Power Connectors

Electrical Connections are based on the electrical colour scheme below

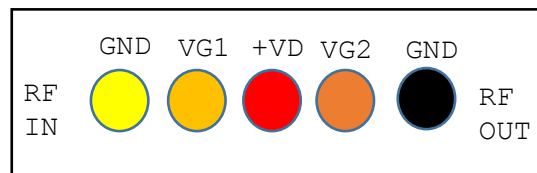

Figure 3 electric connection scheme

The connector, provided with LNA, is displayed in Figure 4.



Figure 4 connector

Orange is oriented towards input.



8.1.1.2 Voltage

Amplifiers are provided with internal transient protections in the form of resistive dividers on the gates and 1.8 V clamps on the gates and drains.

Recommendation:

the diode clamps failure soil is 2V (it fails for $V > 2V$ DC). **Take care to ensure the power supply is transient free**

LNA	VD	Vg1 (mV)	Vg2 (mV)	Ig1 (uA)	Ig2 (uA)	Id (mA)
S220	1.0	+340	+354	95	99	18.9
S217	1.0	+205	+205 ¹	110	110 ¹	20.0

Note 1: The value is not explicitly indicated in the specifications sheet form JPL; it was assumed that values are the same for Vg1 and Vg2.

Table 1 Recommended bias values

8.1.1.3 Voltage stability

There are not specific requirements.

8.1.1.4 Current stability

There are not specific requirements.

8.2 Detector diode

TBC

9 Equipment

9.1 VNA

The test bench is based on a Anritsu VNA MS4647B equipped with Broadband Test Set 3739C; mm module 3743A from 70 KHz to 110 GHz. It was a new equipment, delivered to OAA in July 2015 and certified in August 2015.

Its main performance are summarized in the following table.

Operational Range	Pout-min
67-117 GHz	-60 dBm

Table 2 VNA specifications

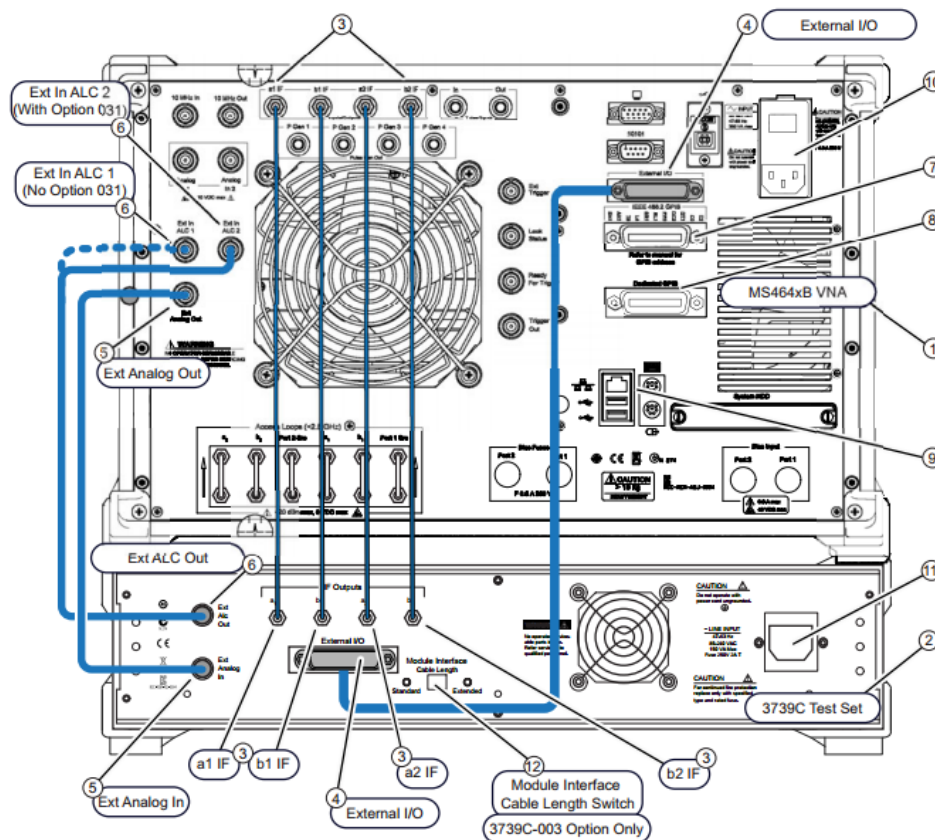
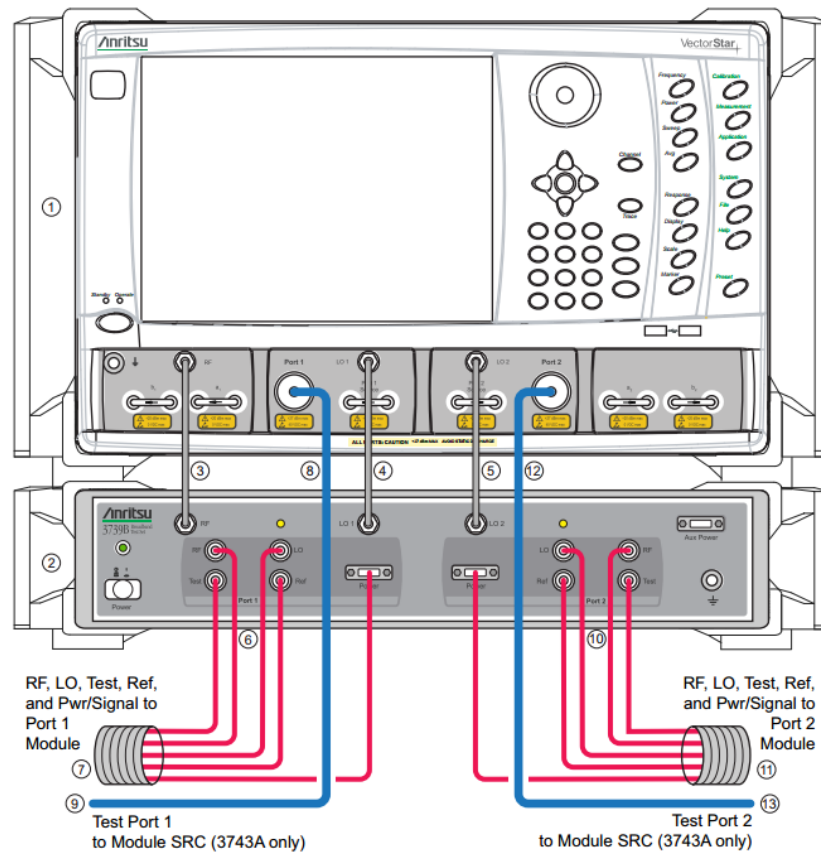

Figure 5 Install Rear Panel Cables between 3739B/C Test Set and MS4647B VNA



Example MS464xA/B VNA equipped with Option 051, 061, or 062 with included Front Panel Loops

Note: The cables for Test Port 1 to Module SRC (key 8 to 9) and Test Port 2 to Module SRC (key 12 to 13) are not used with mm-Wave modules 3744A-EE, 3744A-EW, or 3744A-Rx.

Figure 6 Front Panel Cables between 3739C Test Set, MS4647B VNA, and Modules

9.1.1 VNA Calibration Kit

TRL WR10 waveguide calibration Kit from NEXUS (TBC).

It includes a Short and a Line ($\lambda/2$).

It covers the complete operational range 67 GHz - 116 GHz.

9.2 Power supplier Unit (PSU)

The system used to supply amplifiers with power is based on a NRAO design (REF TBC). Basically it's a servo power supply working in a closed loop. The drain current is kept invariant by a dynamic regulation of gate voltage.

It is a custom made device provided by INAF-IRA. It has two channels (able to control each up to 5 amplification stages simultaneously).

Its design is based on NRAO scheme (TBC).

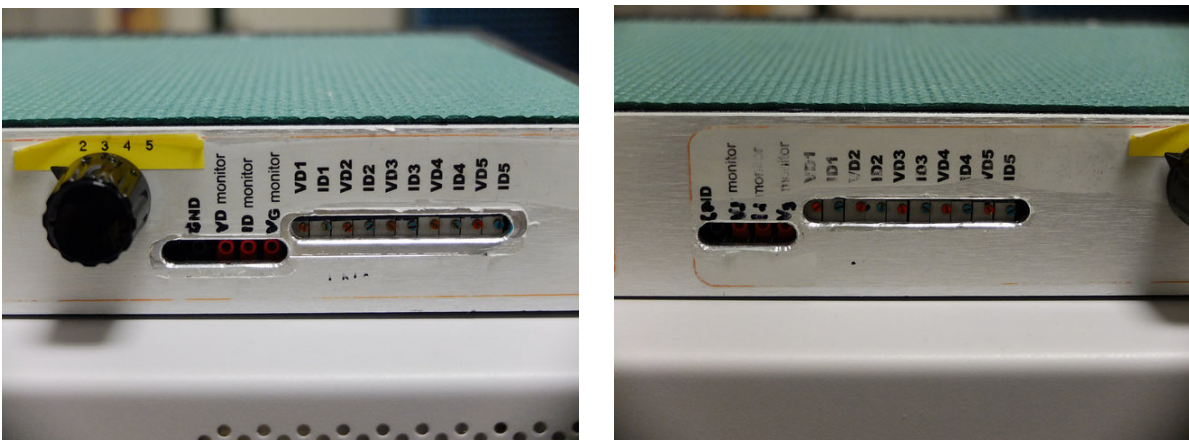

Figure 7

Values are read on a multimeter connected to the PSU through standard connectors.

LNAs are connected to the PSU through two dedicated cables shown in Figure 4 provided by JPL.

Each cable was slightly modified w.r.t its original configuration to comply with the PSU.

In the modified configuration, Vg1 and Vg2 wires are shorted.



9.3 Power Meter (PM)

Power Meter model is HP 438 TBC. From INAF IRA.

Its main performance are summarized in the following table.

Table 3

THE TEST WAS NOT PERFORMED

9.3.1 Power Meter head

Range 75 GHz : 110 GHz. (From Uni-MiB).

POWER METER WAS NOT USED (UNAVAILABLE)

9.4 Spectrum Analyser (SA)

SA Model HP8564 opt 008 from INAF-IRA. Needed to check the VNA spectral purity.

9.5 Portable Oscilloscope

NOT USED

9.6 Portable Amperometer

It is a clamp amperometer from INAF-IRA, useful to check possible oscillations in the LNAs. From INAF-IRA

9.7 Mixer

Hp 11970W external mixer for SA hp8564E allow a calibrated spectrum measurement over 75...110GHz and a non calibrated but useful spectrum visualization over the whole B2+3.



9.8 Attenuator

It is a WR10 variable attenuator. Attenuation is in the range 0 dB :20 dB.

9.9 Notebook

It was not needed.

9.10 Miscellanea

9.10.1 Cables

9.10.2 WR10 connectors

9.10.3 Antistatic bracelet



10As Run Procedure

10.1 Calibration

The VNA is calibrated by TRL method.

The VNA settings during TRL follow hereafter:

- Power Level: -30 dBm
- Bandwidth: 67-116 GHz
- IF: 10 KHz
- Points: 1961

The power level was lowered during tests to prevent saturation in the second cascaded amplifier down to a level enough high to provide a good S/N over the full bandwidth.

Environmental conditions:

- External Temperature:
Between 25.8 °C and 26.4°C
- Pressure; not measured
- Humidity: not measured

The minimum power level applicable to get a good calibration along the nominal B2+3 frequency range was verified:

for levels lower than -40 dBm we observed some features in the S11 in the low frequency region.

For this reason we decided to perform the TRL calibration with Power levels set between -30 dBm and -40 dBm , depending on the characteristics of the DUT, in sequence to prevent possible nonlinear response of the DUT.

As a check, power was changed from -45 dBm to -10 dBm.

The measured p2p change is < 0.5 dB.

10.2 VNA characterization

The VNA spectral purity shall be verified using by Spectrum Analyser.

Take a picture of the experimental setup.

The experimental setup is shown in the following picture

Data shall be recorded.



This test was not run and was postponed to a next test session.

10.3 Test 1: LNA "S217" GAIN

Wear the antistatic bracelet > DONE

The LNA shall be biased as specified in 8.1.1.

The PSU used allows to set Drain Current as independent variable.

The following table was filled:

Parameter	value
Id Set (mA)	18.9
VD Set (V)	1.0
Vg1 measured (mV)	226:228 *
Vg2 measured (mV)	226:228 *
Ig1 measured (uA)	N.A.
Ig2 measured (uA)	N.A.
Power in	-30 dBm

Table 4 LNA S217 settings: filled table

*) Due to RF power ON, Vg oscillates between 213 mV and 228 mV.

Power was reduced down to -45 dBm to minimize oscillations and to measure Vg in more stable conditions.

It was needed to refine the threading of one input hole by a dedicated tool.

The Average Gain is: COMPLETE THIS FIELD

The Gain Curve is recorded.

OK

File NAME: s217_1.s2p

Plot: shown in Figure 8

The external temperature is measured: 25.8 °C

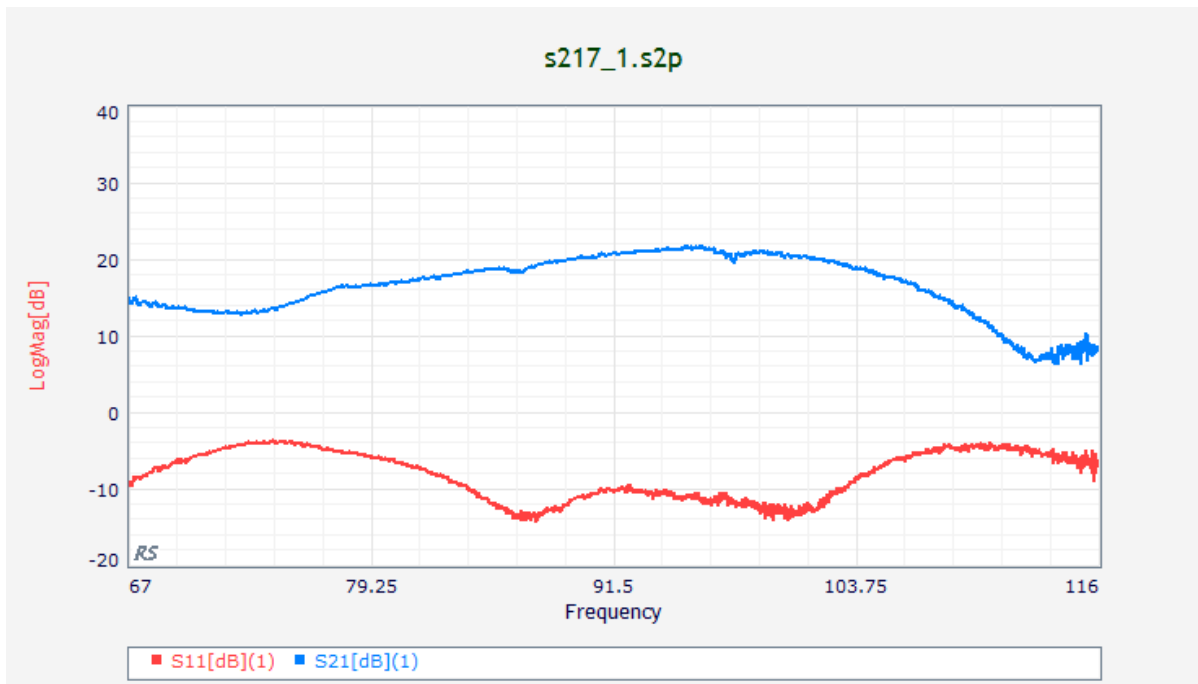

Figure 8

10.3.1 OPTIONS

Bias Set 2

A second bias set is applied: Id is lowered in the direction to have nominal values for Vg1 and Vg2. The Vg nominal setup was applied:

Id Set (mA)	18.49
VD Set (V)	1.0
Vg1 measured (mV)	205
Vg2 measured (mV)	205
Ig1 measured (uA)	N.A.
Ig2 measured (uA)	N.A.
Power in	-30 dBm

Table 5 LNA S217 modified settings

The Average Gain is: COMPLETE THIS FIELD

The Gain Curve is recorded.

OK

File NAME: s217_2.s2p

Plot: shown in Figure 8

The external temperature is measured: 26.0 °C

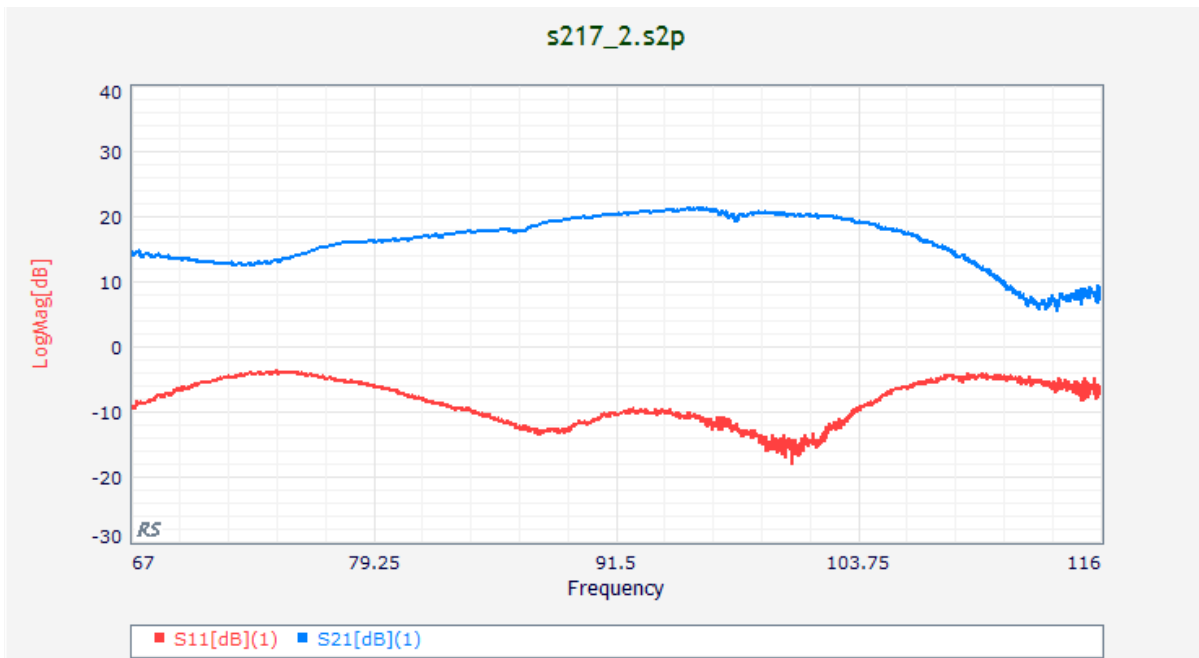

Figure 9

Bias Set 3

Case the gain was considered too low, VD or Id can be increased (within limits described in 8.1.1) to boost the gain.

The following bias are applied.

Id Set (mA)	25.0
VD Set (V)	1.0
Vg1 measured (mV)	504
Vg2 measured (mV)	504
Ig1 measured (uA)	N.A.
Ig2 measured (uA)	N.A.
Id Set (mA)	-30 dBm

Table 6

The Average Gain is: COMPLETE THIS FIELD

The Gain Curve is recorded.

OK
File NAME: s217_3.s2p
Plot: shown in Figure 10Figure 8

The external temperature is measured: 26.4 °C

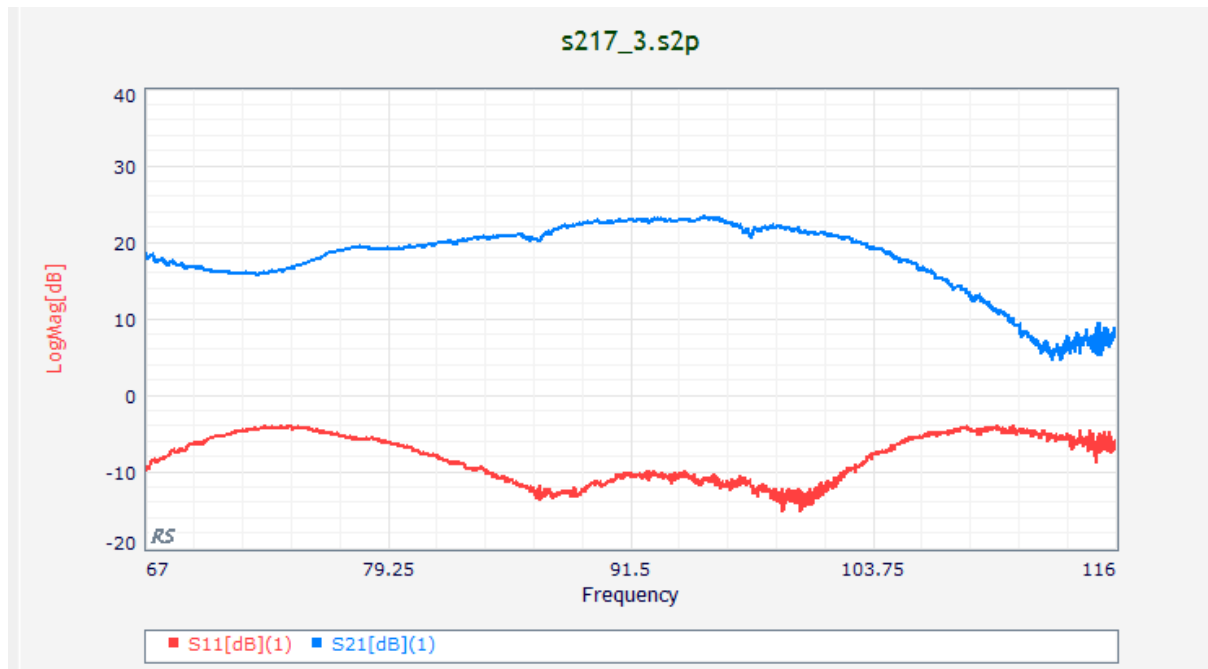

Figure 10

10.4 Test 2: LNA "S217" Compression Point

Wear the antistatic bracelet

10.4.1 Option 1:

Using the variable attenuator, the input power will be increased per 1 dB steps;

If this option is pursued, the variable attenuator curve shall be characterized and recorded for each of the applied attenuation points.

NOT PERFORMED

10.4.2 Option 2:

Acting on the VNA settings , the input level was increased per 1 dB steps (TBC): **Check if the output changes when input level is changed.**

The compression point test was not straightforward: the calibration stability seems to change with the power level applied.

We performed the calibration at -33 dBm, then measured RL and IL curves were taken changing the input level (without calibrating again, level kept fixed at -33dBm).

Input level was increased from -33 dBm to -25 dBm.

The test should have started from a much lower input level, to be sure that we are increasing input power starting from a linearity regime of the LNA. However, it was observed that calibrations performed at levels lower than -33 dBm show increasing noise at the boundary of the band.

Results are reported in the following plots from Figure 11 to Figure 14.

It is evident that RL changes by about 0.7 dB and that IL changes by 2.1 dB over 7 dB, depending on frequency.

Assuming that at -33 dBm the amplifier response is still linear, and that the calibration is optimal, since performed in the same conditions (calibration input level = measure input level), we see a 1 dB compression at -24 dBm input power at 94 GHz, corresponding to a 2 dB compression in the side band region. **At -33 dBm signal is very noisy.**

It seems that the best way to perform this test would have been that described in OPTION 1, using a variable attenuator firstly characterized over the full band at each input level.

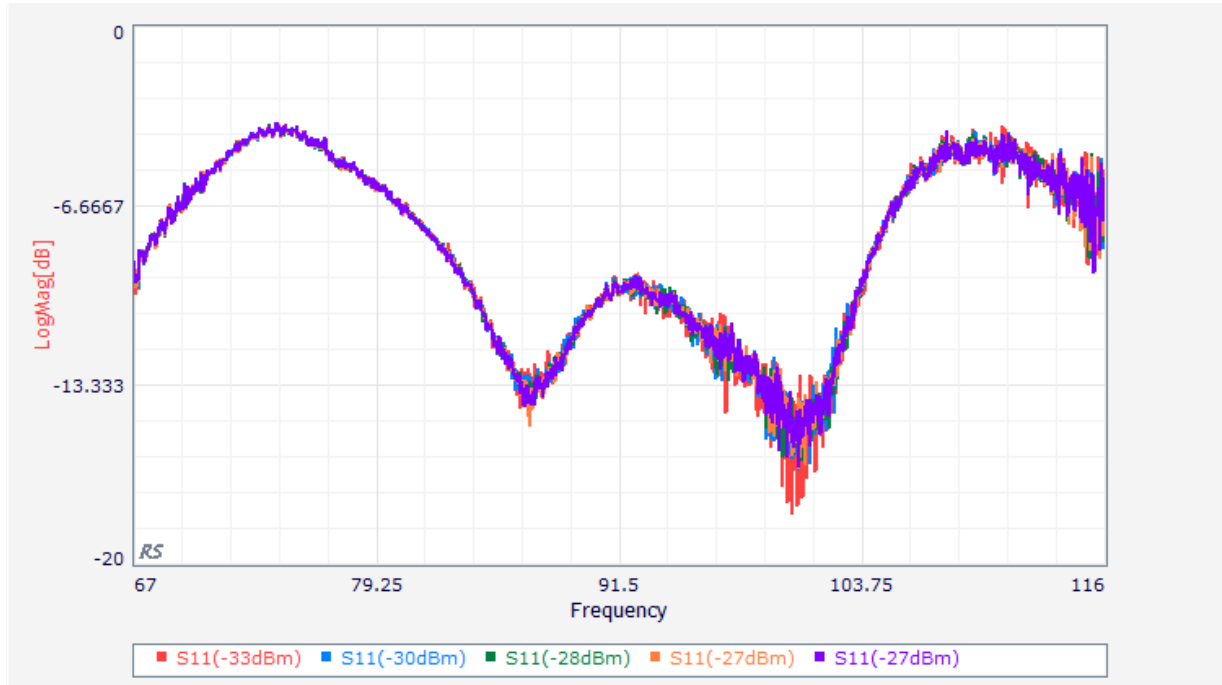

Figure 11 RL calculated when the input level is changed from -33 dBm to -26 dBm.

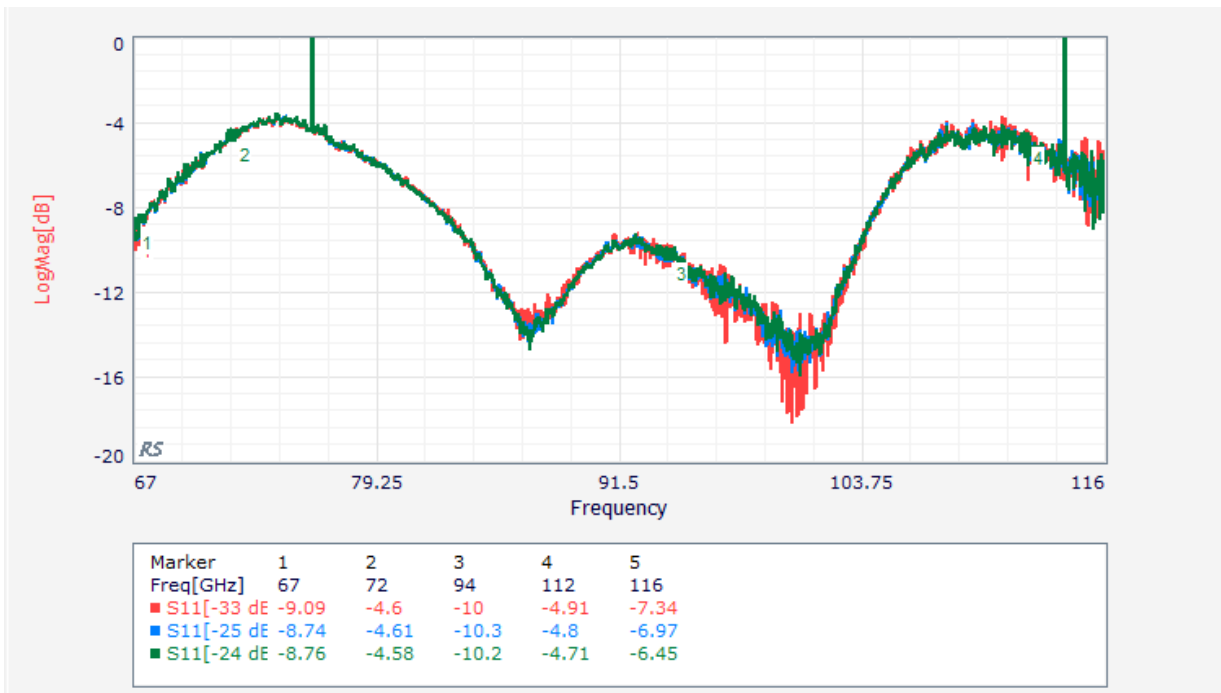

Figure 12 RL calculated when de input level is changed from -33 dBm to -24 dBm.

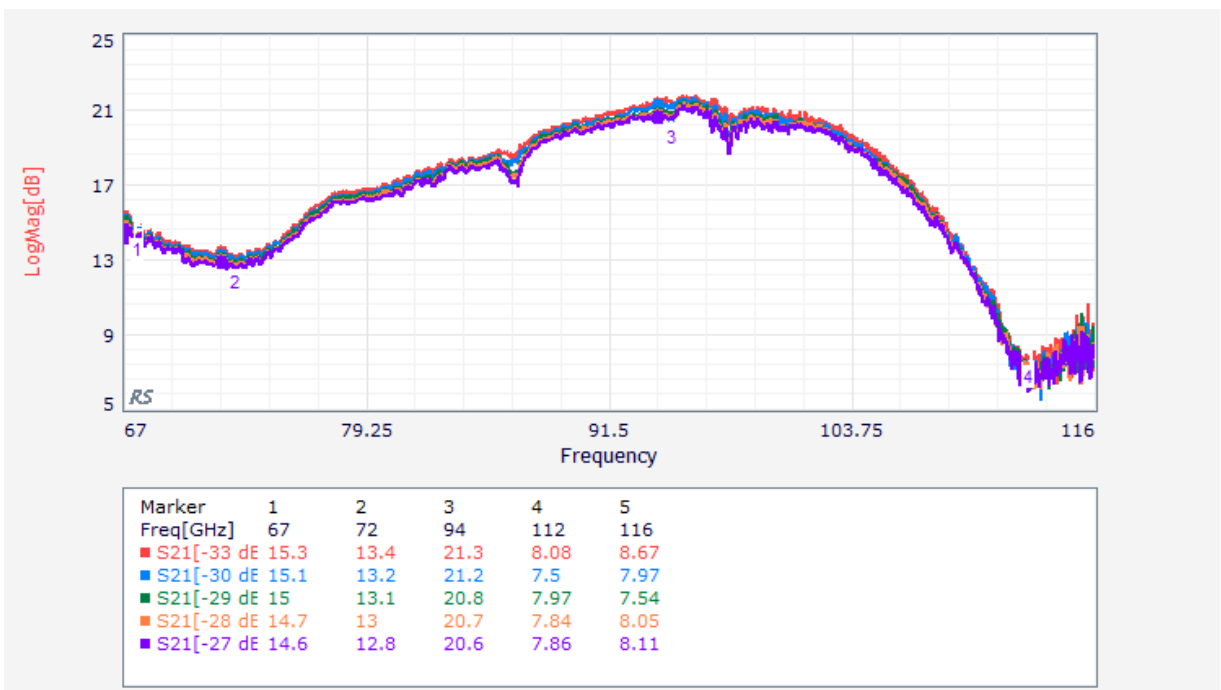

Figure 13 gain calculated when de input level is changed from -33 dBm to -27 dBm.

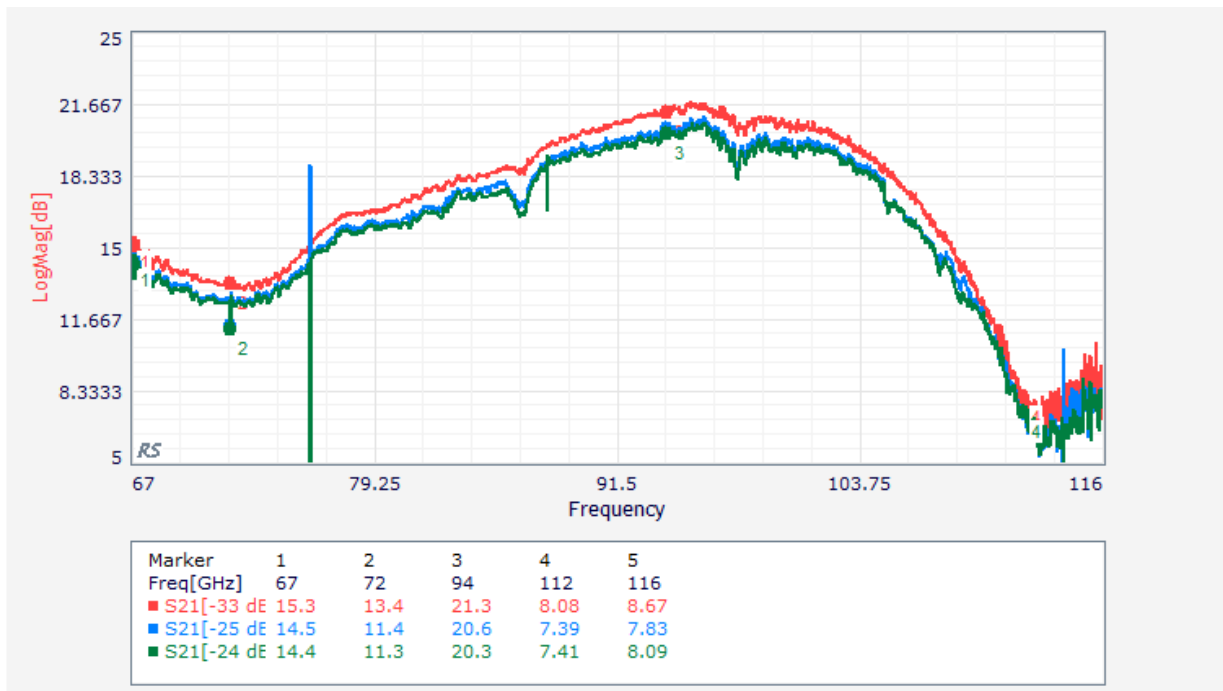

Figure 14 Gain calculated when de input level is changed from -33 dBm to -24 dBm

10.4.3 Record data

7 points input levels have been applied, from -33 dBm to -24 dBm.

Forward Gain Curves shall be recorded.

Results are recorded in the following files:

```
s217_com-33.s2p
s217_com-30.s2p
s217_com-28.s2p
s217_com-27.s2p
s217_com-26.s2p
s217_com-25.s2p
s217_com-24.s2p
```

Results are displayed in plots shown from Figure 11 to Figure 14.

The external temperature is measured: 26.3 °C

Take a picture of the experimental setup



10.5 Test 3: LNA "S220" GAIN

Wear the antistatic bracelet

The LNA shall be biased as specified in 8.1.1.

The PSU used allows to set Drain Current as independent variable.

The following table is filled:

Id Set (mA)	20.05
VD Set (V)	1.0
Vg1 measured (V)	0.565 instead of 340 mV
Vg2 measured (V)	0.565 instead of 354 mV
Ig1 measured (uA)	N.A.
Ig2 measured (uA)	N.A.

Table 7 LNA S220 settings

BIAS NON COMPLIANCE

The voltage drain read when the Id bias is set to nominal values is not compliant with what expected from LNA specifications. It could be maybe ascribed to:

- a) The scheme of wiring supplying power to Vg1 Vg2: actually , the two stages should have biased using separated wires providing bias slightly different from each other. However, this small difference seems not so large to justify the larger (by about 60%) Vg measured.
- b) Coupling with RF signal: however it to avoid this, the input signal was lowered down to -45 dBm. The Vg measured level did not change.

The Average Gain is: COMPLETE THIS FIELD

The Gain Curve is recorded.

OK

File NAME: s220_1.s2p

Plot: shown in Figure 10Figure 8

The external temperature is measured: 25.8 °C

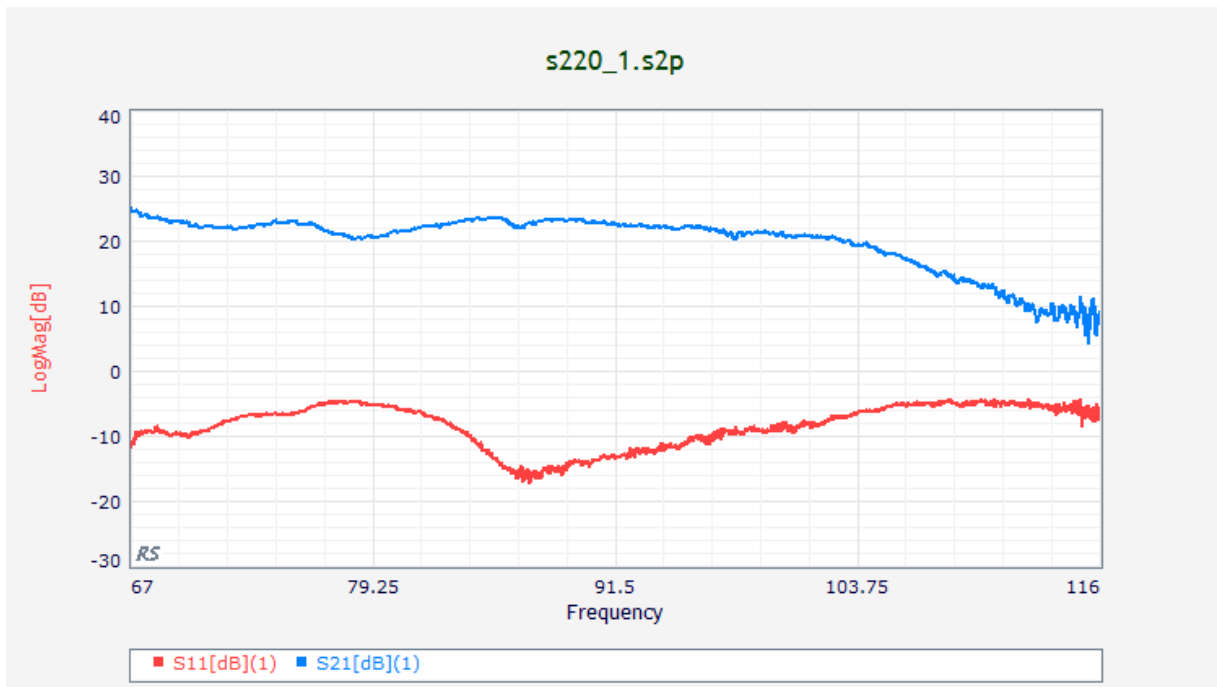

Figure 15

10.5.1 OPTION

The drain current is lowered until the nominal Vg values are measured.

A new table shall is filled with new settings:

Id Set (mA)	15.5
VD Set (V)	1.0
Vg1 measured (mV)	330-350 (the value is not stable)
Vg2 measured (mV)	330-350 (the value is not stable)
Ig1 measured (uA)	N.A.
Ig2 measured (uA)	N.A.

Table 8 LNA S220 modified settings

The Average Gain is: COMPLETE THIS FIELD

The Gain Curve is recorded.

OK

File NAME: s220_2.s2p

Plot: shown in Figure 10Figure 8

The external temperature is measured: 25.8 °C

Nominal Id and lowered Id curves are compared hereafter. The Forward Loss curve is flattened around -20 dB until 103.75 GHz when Id lower bias set

is applied. Gain keeps stable at frequency > 104 GHz and reduces by something between 3.7 dB and 2.5 dB in the frequency range < 104 GHz.

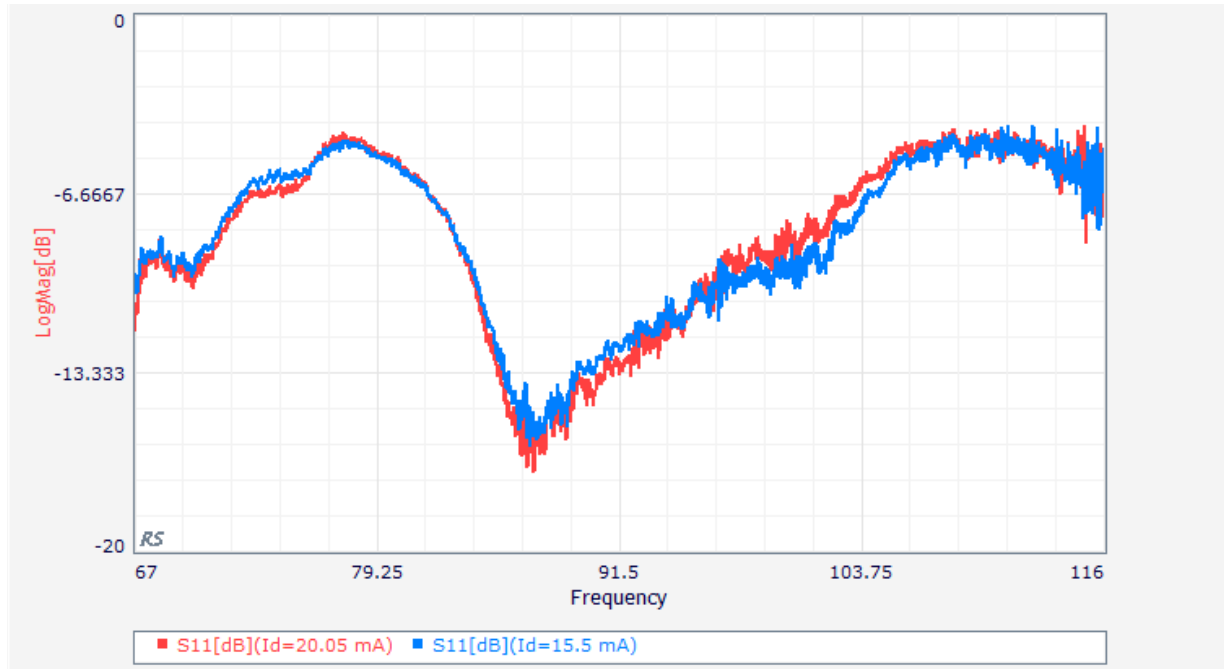

Figure 16 RL: comparison between nominal I_d and lower I_d bias setup.

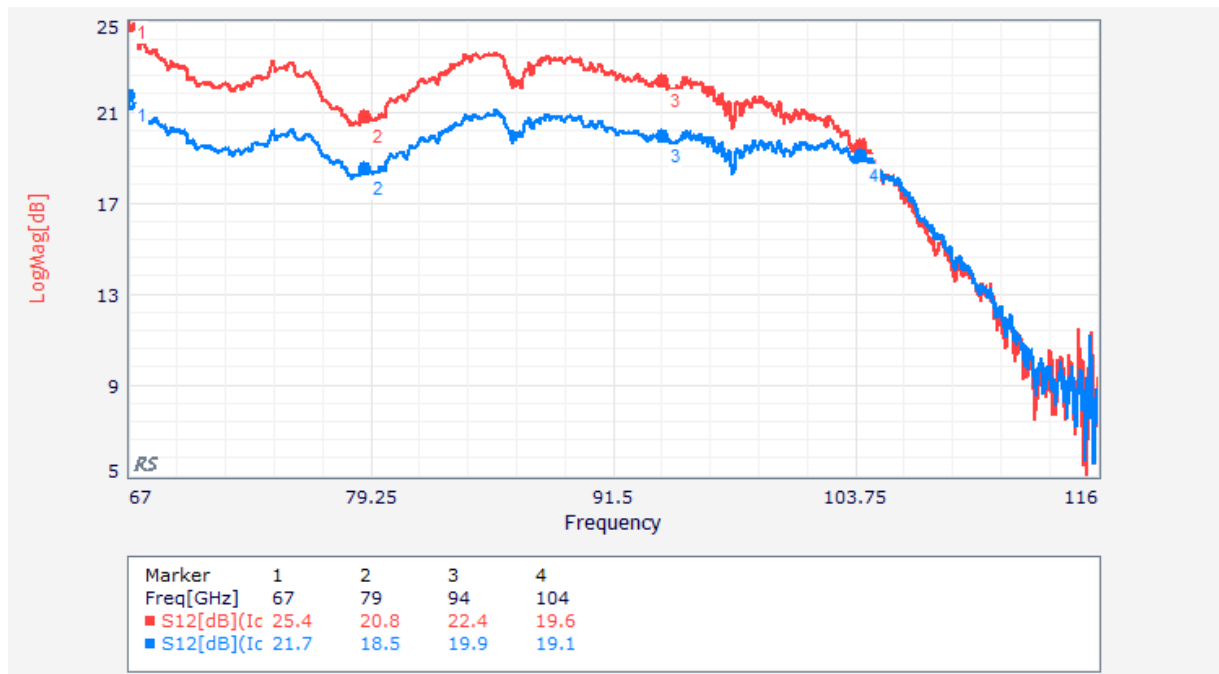

Figure 17 IL: comparison between nominal I_d (red curve) and lower I_d (blue curve) bias setup.



10.6 Test 4: LNA "S220" Compression Point

Wear the antistatic bracelet

10.6.1 Option 1:

Using the variable attenuator, the input power will be increased per 1 dB steps;

If this option is pursued, the variable attenuator curve shall be characterized and recorded for each of the applied attenuation points.

NOT PERFORMED

10.6.2 Option 2:

Acting on the VNA settings , the input level was increased per 1 dB steps (TBC): **Check if the output changes when input level is changed.**

As for the LNA S217 we performed the calibration at -33 dBm, then RL and IL curves were measured changing the input level (without calibrating again, level kept fixed at -33dBm).

The input levels applied are different from those used for LNA S217, due to the different dynamic range: level was increased from -33 dBm to -28 dBm.

The test should have started from a much lower input level, to be sure that we are increasing input power starting from a linearity regime of the LNA. However, it was observed that calibrations performed at levels lower than -33 dBm show increasing noise at the sideband.

Results are reported in the following plots (Figure 18, Figure 19)

RL changes by about 0.2 dB over almost the full range, and IL changes by 2.1 dB over an input level change of 7 dB, depending on frequency.

Assuming that at -33 dBm the amplifier response is still linear, and that the calibration keeps optimal when the input power is increased, we see a 1 dB compression for input power -28 dBm at 116 GHz , corresponding to a 0.6 dB compression in the central part of the band.

It seems that the best way to perform this test would have been that described in OPTION 1, using a variable attenuator firstly characterized over the full band at each input level.

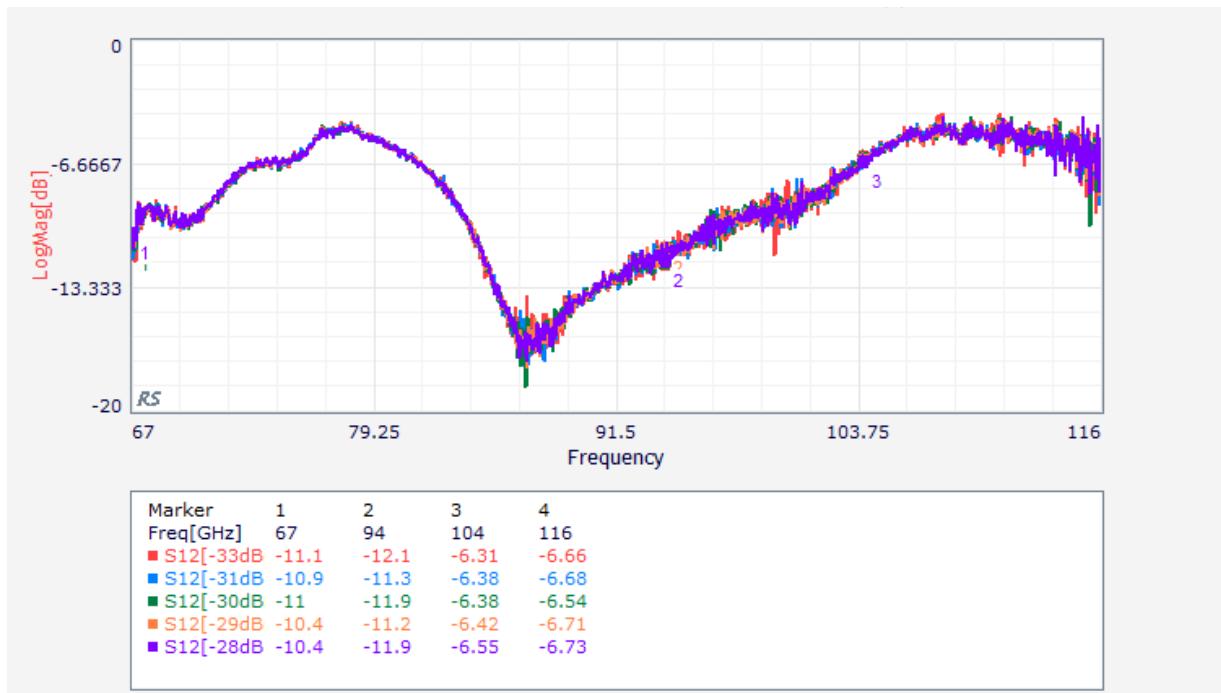

Figure 18 RL calculated when de input level is changed from -33 dBm to -28 dBm

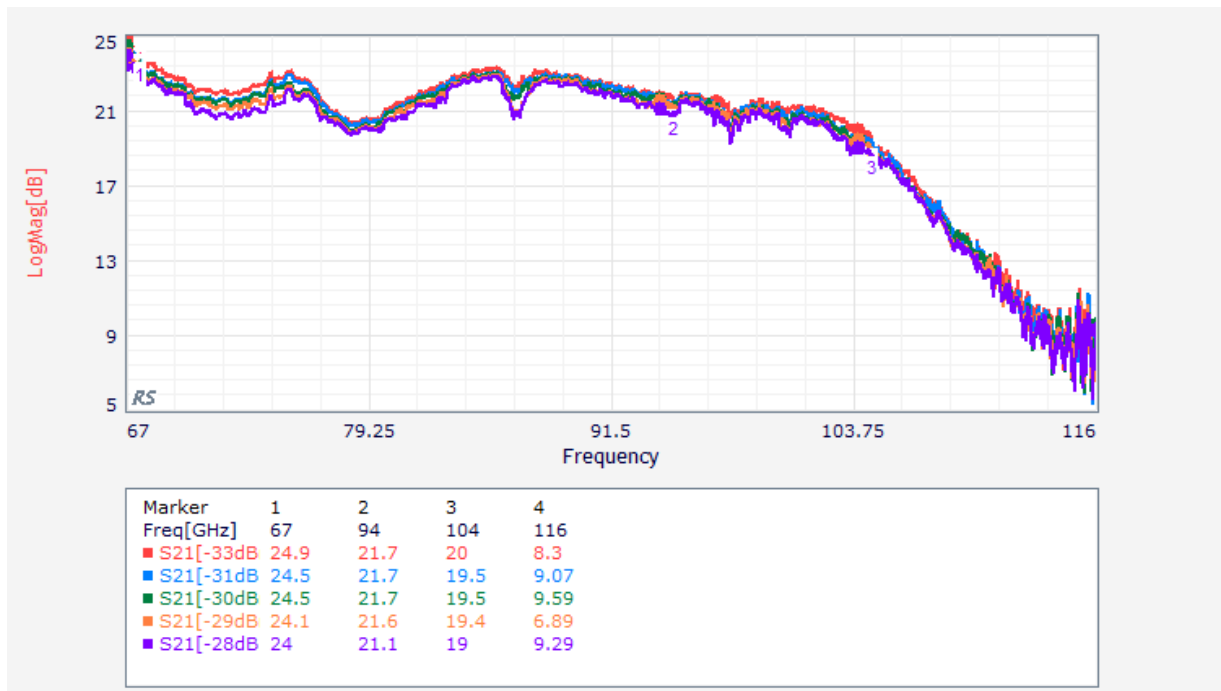

Figure 19 IL calculated when de input level is changed from -33 dBm to -28 dBm



10.6.3 Record data

For both options, at least 25 steps are applied, to take into account the setup with the two cascaded amplifiers.

5 points input levels have been applied, from -33 dBm to -28 dBm.

Forward Gain Curves shall be recorded.

Results are recorded in the following files:

s220_com-33.s2p

s220_com-31.s2p

s220_com-30.s2p

s220_com-29.s2p

s220_com-28.s2p

Results are displayed in plots of Figure 18 and Figure 19**Errore. L'origine riferimento non è stata trovata.Errore. L'origine riferimento non è stata trovata..**

The external temperature is measured: 26.4 °C

Take a picture of the experimental setup

10.7 Comparison between S217 and S220

The two LNAs are hereafter compared in Return Loss (S11) and Forward Gain (S21).

- They show a similar behaviour in S11.
- Forward Gain is quite similar at frequencies higher than 94 GHz.
- Forward gain is very different at frequencies lower than 94 GHz.
- Gain difference vary with a monotone like behaviour from 10 dB (at 67 GHz) through 4 dB (at 80 GHz) to 0 dB (at 94 GHz) .

The overall behaviours are compared in Figure 20.

Data sets used are:

- ✓ S217_1.S2P
- ✓ S220_1.S2P

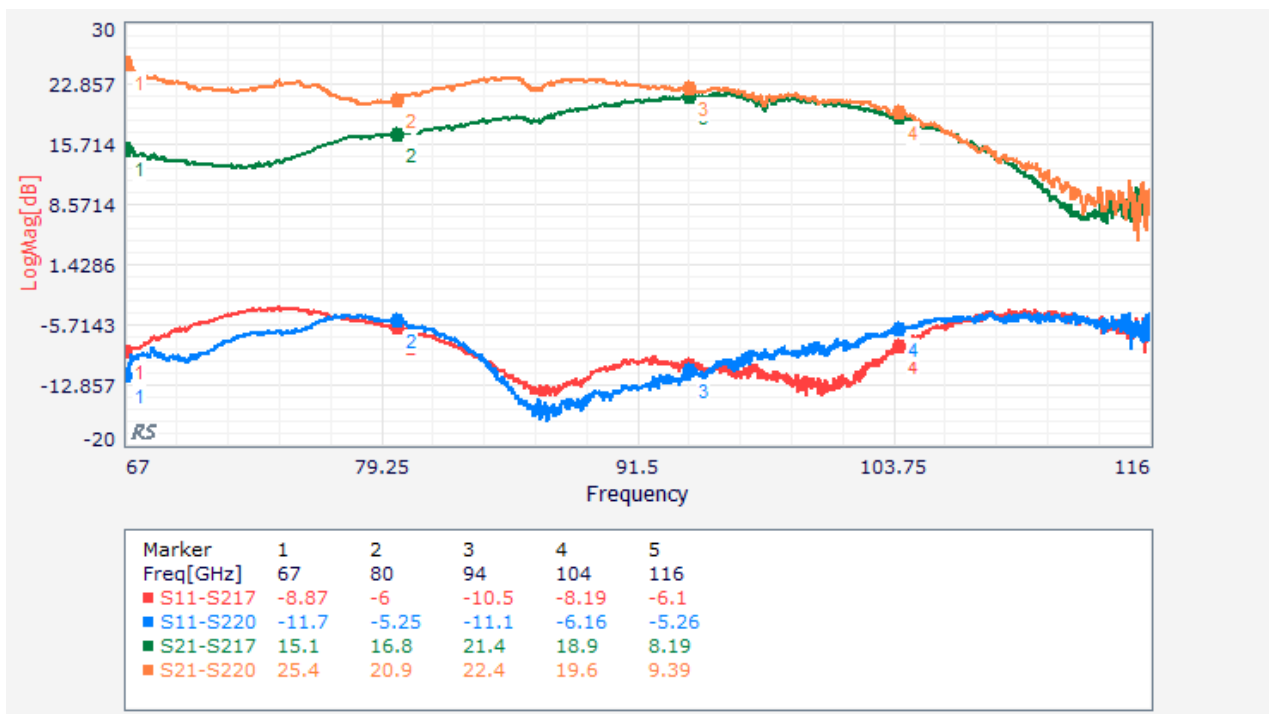

Figure 20 S11 and S21 comparison between LNAs S217 and S220.



10.8 Cascaded LNAs: VNA TRL Calibration

Basing on previous results, a low input level to the first of the cascaded LNAs is requested to prevent:

- a- Bias oscillations in the first and in the second LNA due to RF coupling to DC.
- b- Gain compression in the second LNA, due to the RF power level coming out the first LNA.

Several attempts are made to perform calibration decreasing input level down to the lowest level available without introducing spurious features.

In other words it has been looked for a trade-off between trace noise, fast refresh and signal weak enough.

VNA Input level is decreased down to -45 dBm. The following results are obtained.

Calibration @ -45 dBm:

We observe features at the low frequencies, especially trace noise.

- The IF is decreased from 10 KHz to 1KHz.
- AVE is set to 4 (4 sweep averaged in calibration).
- Temperature: 25.8 °C

After these changes, features are slightly mitigated but do not disappear.

Calibration @ -42 dBm:

- The IF is kept fixed to 1KHz.
- AVE is kept fixed to 4.
- Temperature: 25.8 °C

Features are further mitigated w.r.t. Cal@-45 dBm, but do not disappear.

Calibration @ -40 dBm:

- The IF is kept fixed to 1KHz.
- AVE is kept fixed to 4.
- Temperature: 25.8 °C

Features are almost disappeared. It seems to be the lowest input level acceptable to calibrate.



In the case that a lower input level was required to prevent the LNAs saturation, we will attenuate the input signal at LNAs keeping the calibration level fixed at -40 dBm.

10.9 Test 5: Cascaded LNAs "S217" + "S220"

The test is aimed at measuring RL and IL of the two cascaded amplifiers.

Bias LNAs to 0; wear the antistatic bracelet.

The two LNAs shall be connected respecting the following sequence:

- 1st Amplifier : S217
- 2nd Amplifier : S220

10.9.1 Nominal Id Bias setup:

The two LNAs shall be biased applying **nominal bias** defined in **Errore**. **L'origine riferimento non è stata trovata.** and 10.3

The following table is filled:

	LNA 217	LNA 220
Id Set (mA)	20	18.9
VD Set (V)	1	1
Vg1 measured (V)	0.296	0.515
Vg2 measured (V)		
Ig1 measured (uA)	N.A.	N.A.
Ig2 measured (uA)	N.A.	N.A.
Calibration input level	-40 dBm	
VNA input level (at LNA 217)	-45 dBm	
Temperature	26.0 °C	
Filename	s217s220_c40p45.s2p	

Table 9 LNA S217 + S220 settings

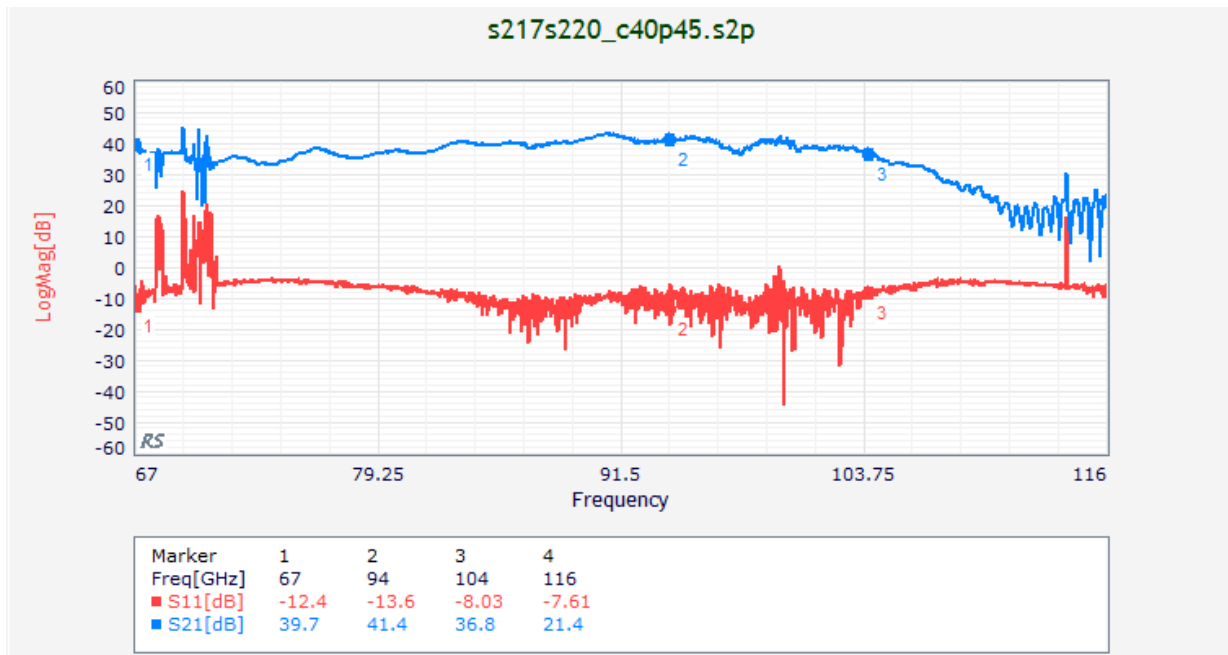

Figure 21 cascaded S217 and S220 LNAs: nominal bias setup.

Keeping the bias fixed, the VNA input level is increased to -40 dBm.

The following table is filled:

	LNA 217	LNA 220
Id Set (mA)	20	18.9
VD Set (V)	1	1
Vg1 measured (V)	0.296	0.515
Vg2 measured (V)		
Ig1 measured (uA)	N.A.	N.A.
Ig2 measured (uA)	N.A.	N.A.
Calibration input level	-40 dBm	
VNA input level (at LNA 217)	-40 dBm	
Temperature	26.0 °C	
Filename	s217s220_c40p40.s2p	

Table 10 LNA S217 + S220 settings; VNA input level is increased to -40 dBm.

Improvement is observed in the IL trace (Figure 22) : many features disappear.

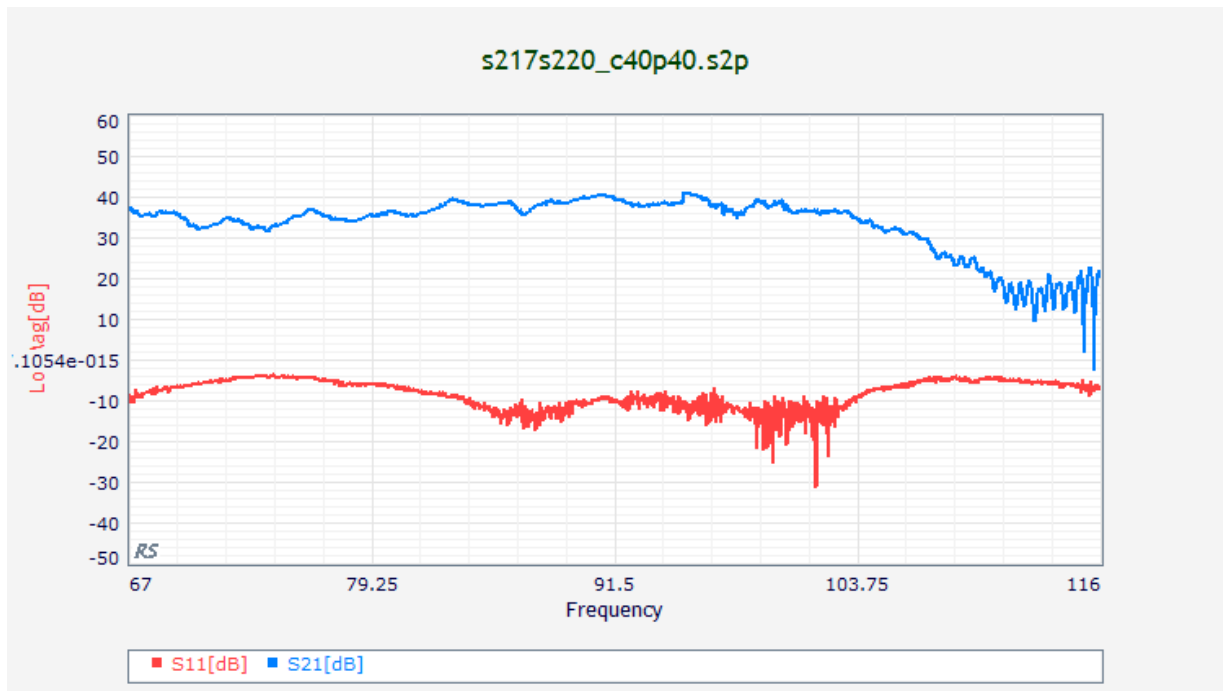

Figure 22 cascaded S217 and S220 LNAs: nominal bias setup with Input level increased from -45 dBm to -40 dBm.

However, from Figure 23 the signal compression is evident. Actually, Return loss level does not change between the two curves, but in the points where the signal is noisy. This would exclude spurious features due to the differences between the calibration input level (-40 dBm) and the VNA input levels at LNA 217.

Insertion gain instead decreases by about 2 dB when the input power is increased from -45 dBm to -40 dBm. In fact, in the -40 dBm configuration, the input power available at LNA S220 ranges between -31 dBm (at 116 GHz, where the compression is less evident) and -19 dBm (at 94 GHz where the compression is more evident).

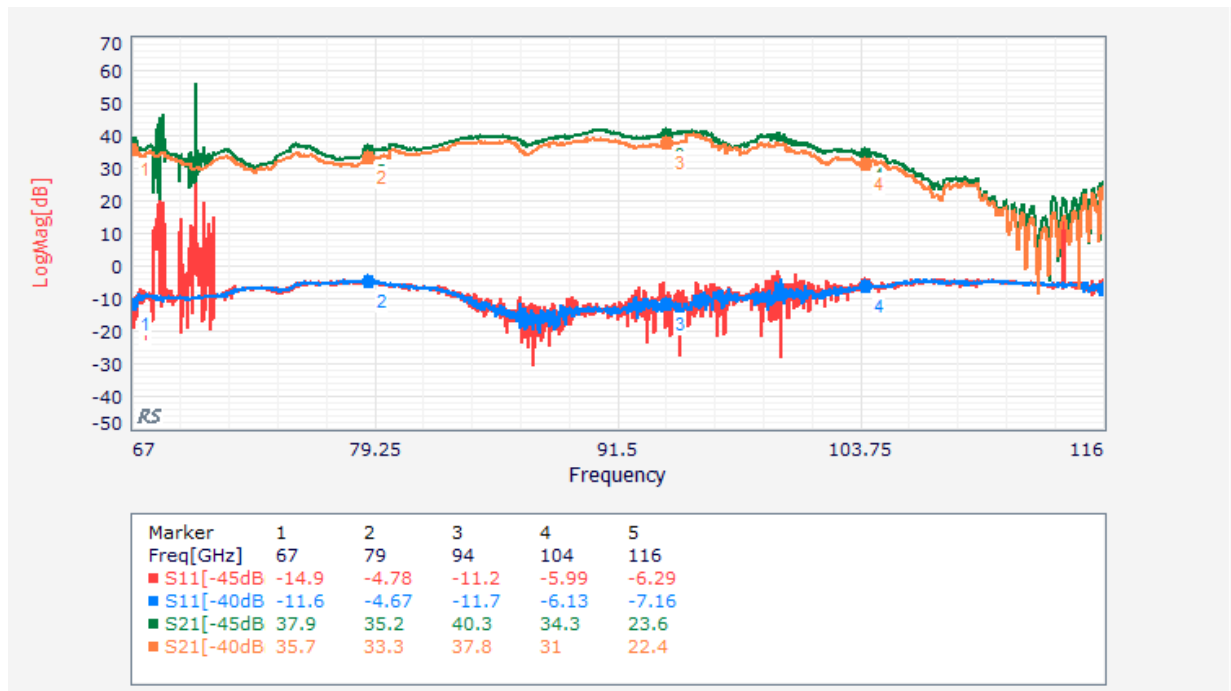

Figure 23 comparison between two setups with input levels set to -45 dBm and to -40 dBm.

10.9.2 Reduced Id Bias setup on LNA S220:

The bias setup described in §10.5.1 was applied to LNA S220. To comply with this, Drain Current was lowered down to 15 mA to get the Gate voltage value 350 mV.

VNA Input level was lowered again to -45 dBm.

The following table is filled:

	LNA 217	LNA 220
Id Set (mA)	20	15
VD Set (V)	1	1
Vg1 measured (V)	0.296	0.350
Vg2 measured (V)		
Ig1 measured (uA)	N.A.	N.A.
Ig2 measured (uA)	N.A.	N.A.
Calibration input level	-40 dBm	

VNA input level (at LNA 217)	-45 dBm
Temperature	26.0 °C
Filename	s217s220_c40p45vg350.s2p

Table 11 LNA S217 + S220 settings; LNA 220 bias settings are the same of §10.5.1.

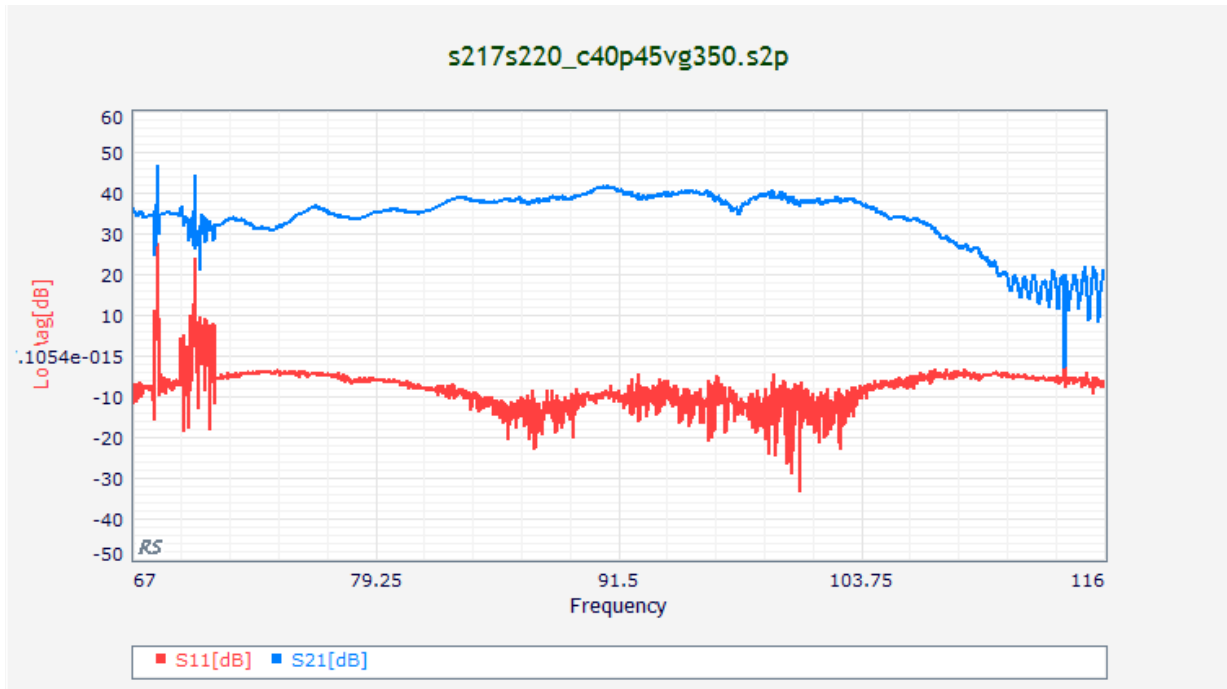

Figure 24 LNA S217 + S220 IL and RL under the bias settings of Table 9.

The measure keeps noisy as under the nominal bias setup conditions of Figure 21.

It means that noise is independent on the bias setup of LNA S220, depending instead on the VNA input level available at the first cascaded LNA (S217).

Keeping the bias fixed, the VNA input level is increased again from -45 dBm to -40 dBm.

The following table is filled:

	LNA 217	LNA 220
Id Set (mA)	20	15
VD Set (V)	1	1
Vg1 measured (V)	0.296	0.350

Vg2 measured (V)		
Ig1 measured (uA)	N.A.	N.A.
Ig2 measured (uA)	N.A.	N.A.
Calibration input level	-40 dBm	
VNA input level (at LNA 217)	-40 dBm	
Temperature	26.0 °C	
Filename	s217s220_c40p40vg350.s2p	

Table 12 LNA S217 + S220 settings; VNA input level is increased to -40 dBm.

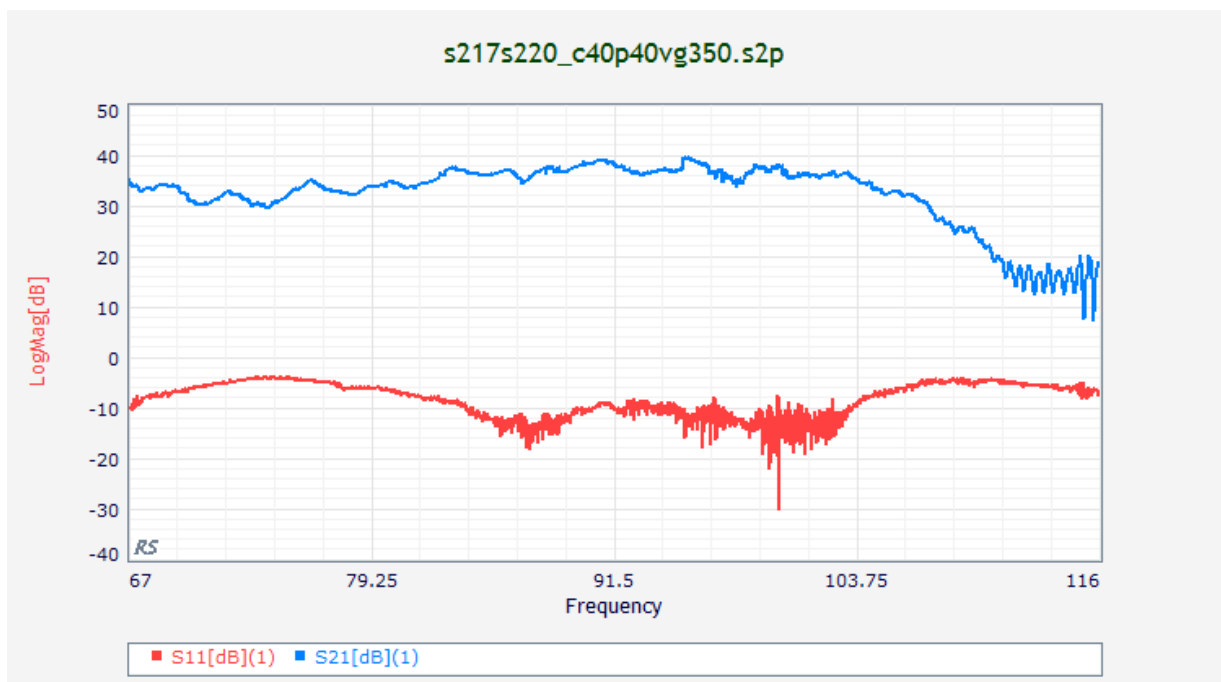

Figure 25 LNA S217 + S220 IL and RL under the reduced bias settings of Table 12 and with VNA input level increased to -40 dBm.

As in the previous case of §10.9.1 (Figure 23), improvement is observed in the IL trace shown in Figure 26: many undesired noisy features disappear.

As in the previous case of Figure 23, the signal compression is evident. Actually, Return loss level does not change between the two curves, but in the points where the signal is noisy.

Insertion gain again decreases by about 2 dB when the input power is increased from -45 dBm to -40 dBm.

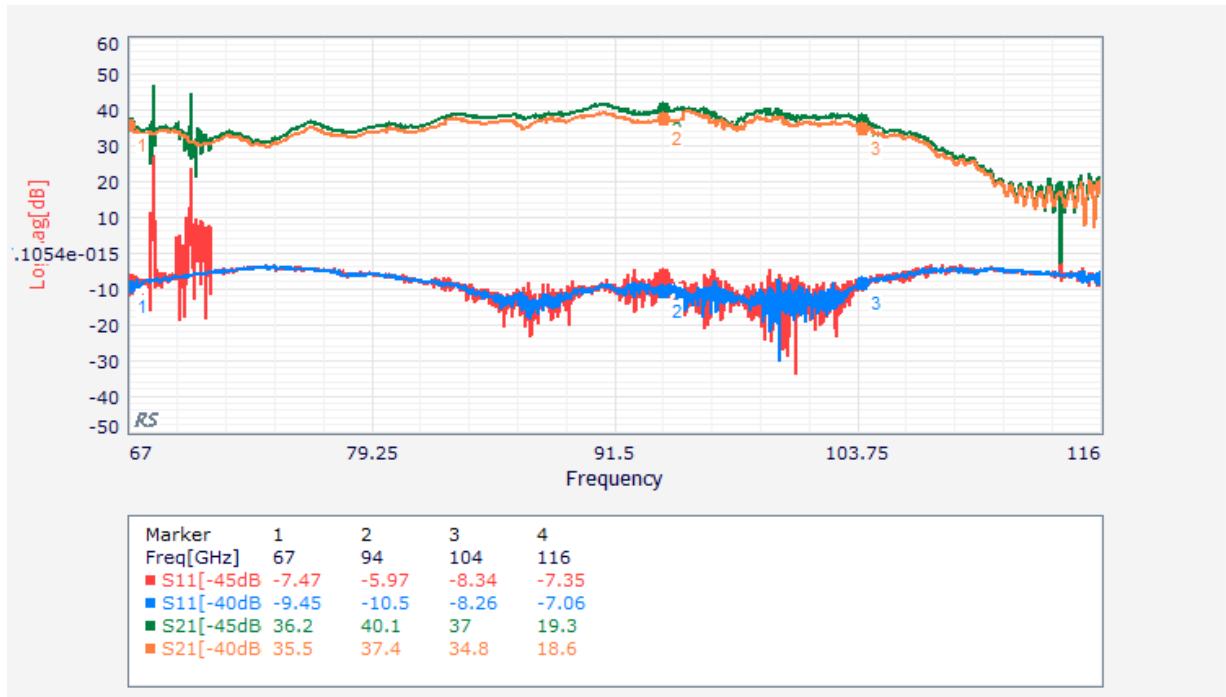

Figure 26 comparison between two reduced bias setup on LNA S220, with input levels set to -45 dBm and to -40 dBm.

10.9.3 Comparison between nominal and reduced bias setup

We compare hereafter the return Loss and Insertion Loss of the two cascaded amplifiers under the conditions analysed in § 10.9.1 and § 10.9.2.

Comparison shows that:

- **Return Loss level keeps about constant when:**

a) VNA input level available at LNA S217 is changed from -45 dBm to -40 dBm, without respect to the bias setup.

See Figure 23 and Figure 26 and more details in Figure 27 and Figure 28.

b) LNA S220 Id bias setup is reduced from nominal (20 mA) to 15 mA and the input power is kept fixed to either -40 dBm or - 45 dBm.

See Figure 29 and Figure 30.

- **Insertion gain changes (is compressed) by something between 1 dB and 2.5 dB when:**

VNA input level available at LNA S217 is changed from -45 dBm to -40 dBm (Figure 31, Figure 32).

Compression occurs without respect to the bias setup of LNA S220 (Figure 33). Actually, compression level is independent on the second amplifier (LNA S220) bias setup and depends only (as expected) on the VNA input level available at LNA S217

- **Gain changes by something between 1 dB (higher frequencies) and 3 dB (lower frequencies) when LNA S220 bias settings are changed from nominal to reduced.**

The behaviour is shown in Figure 34.

The gain difference between nominal and reduced bias is smaller when the VNA input power is increased from -45 dBm to -40 dBm: it is something expected since under the -40 dBm configuration compression is enhanced.

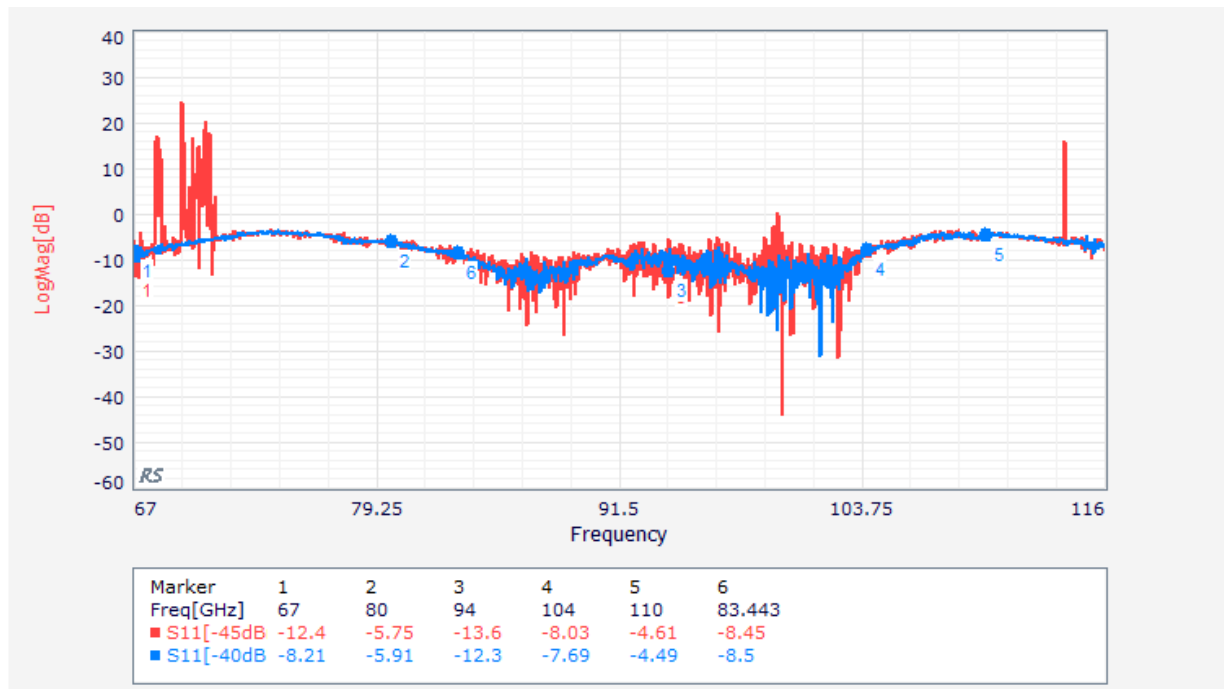

Figure 27 RL: S220 has nominal bias; VNA input level is decreased from -45 dBm to -40 dBm.

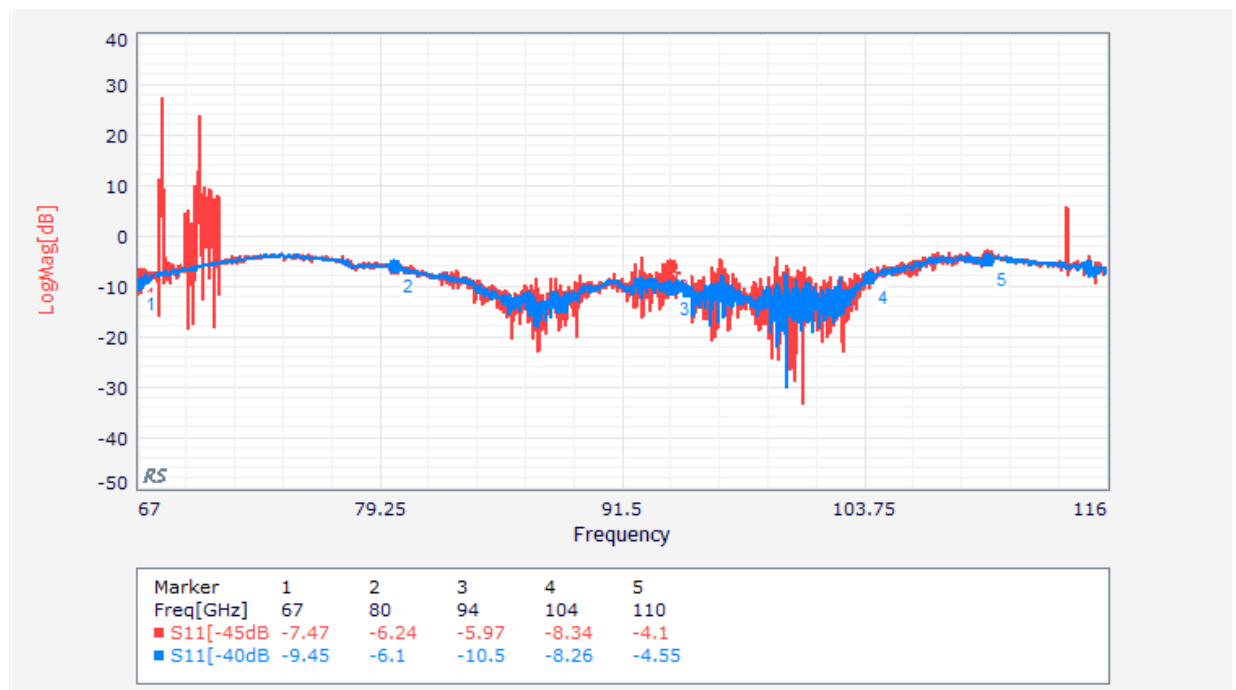

Figure 28 RL: S220 has reduced bias; VNA input level is decreased from -45 dBm to -40 dBm.

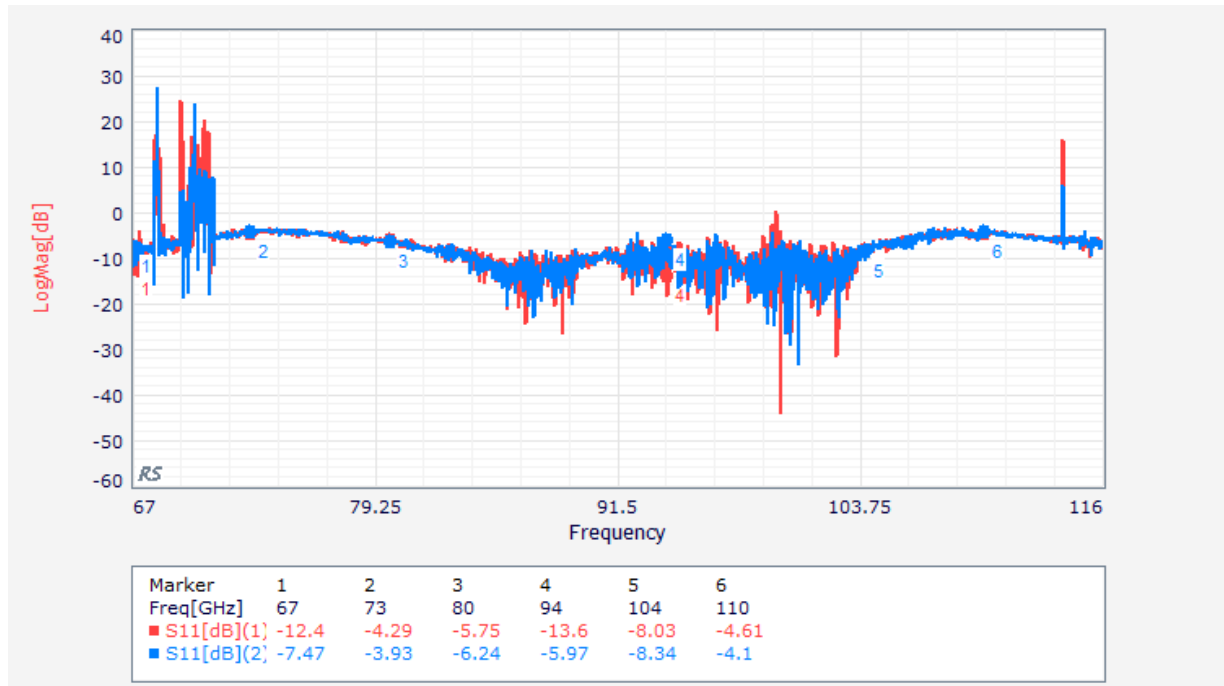

Figure 29 RL comparison @ VNA input = -45 dBm between the two bias setup conditions of LNA S220: $I_d = 20$ mA (red curve) and $I_d = 15$ mA (blue curve).

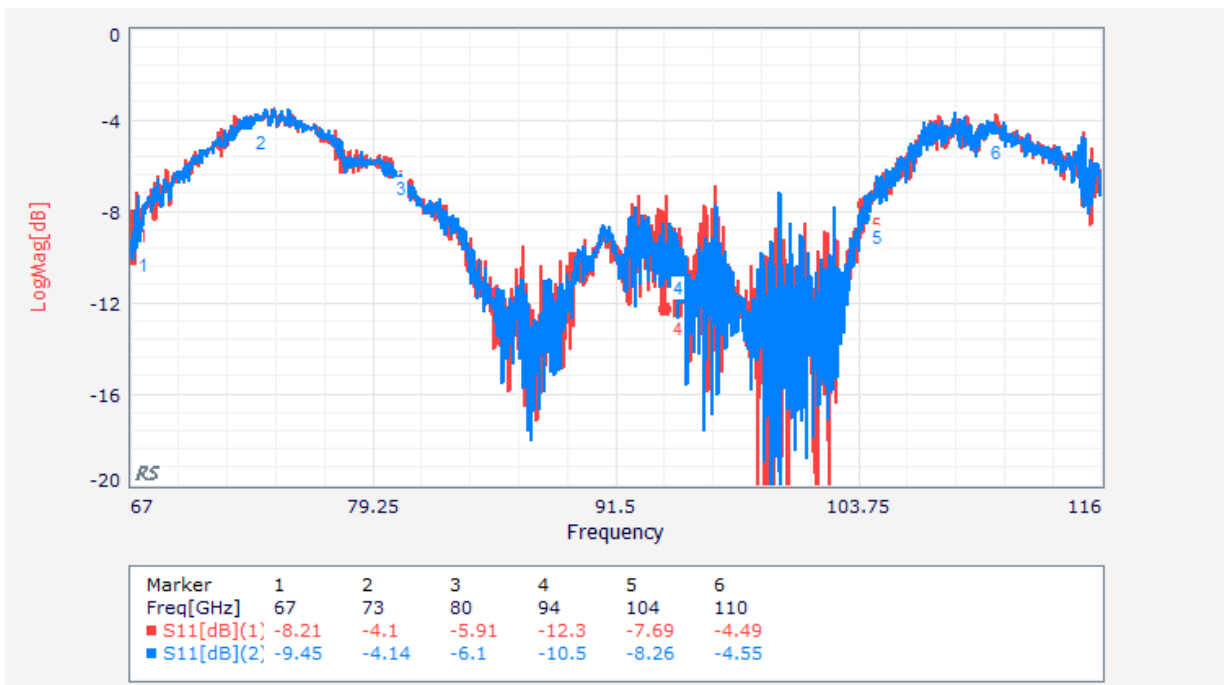

Figure 30 RL comparison @ VNA input = -40 dBm between the two bias setup conditions of LNA S220: $I_d = 20$ mA (red curve) and $I_d = 15$ mA (blue curve).

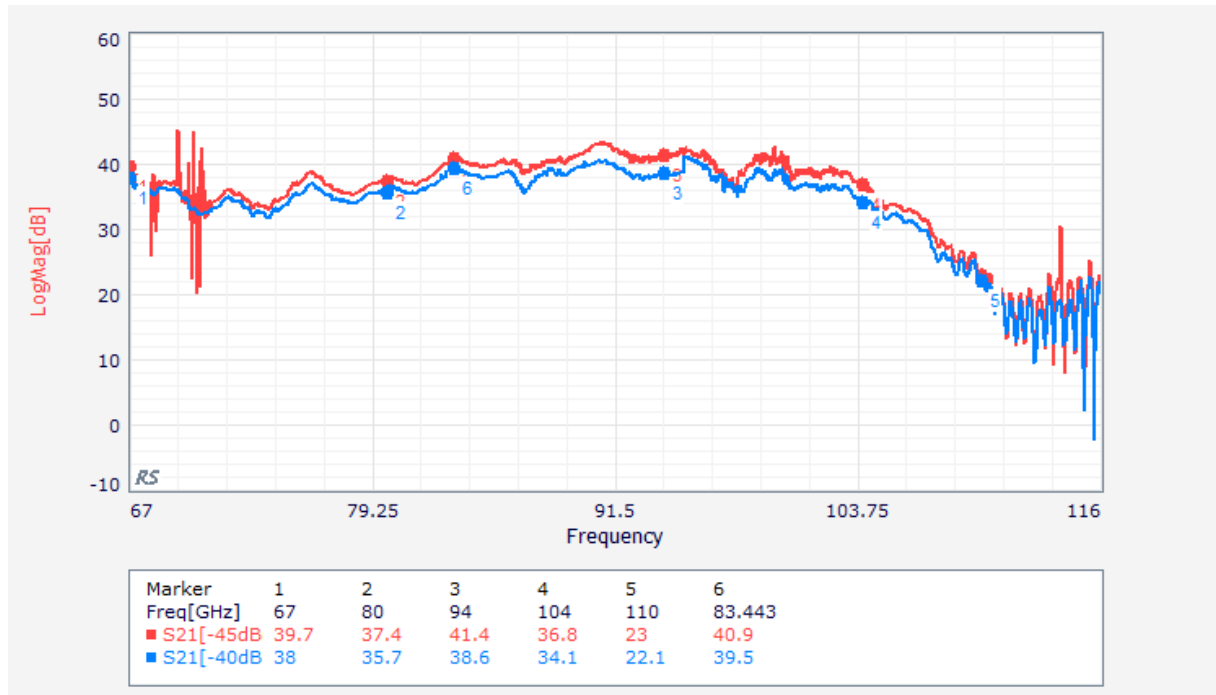

Figure 31 Insertion Gain. Compression effect with *S220 nominal* bias when input level is decreased from -45 dBm to -40 dBm.

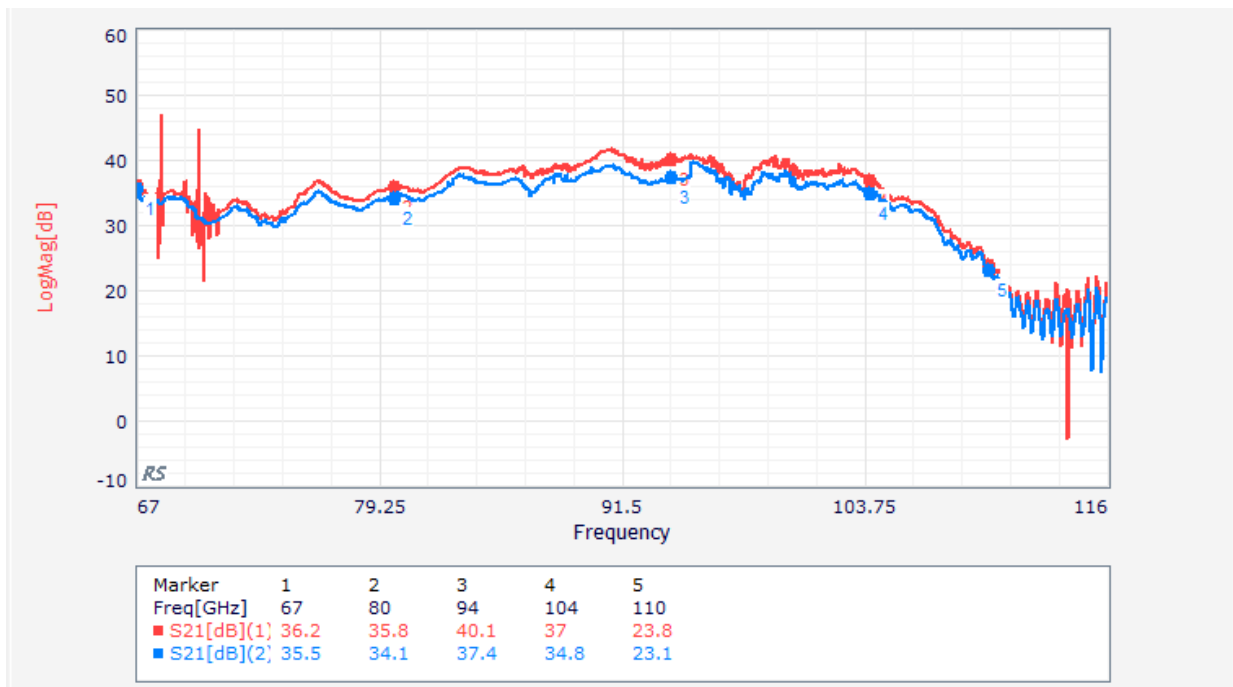

Figure 32 Insertion Gain. Compression effect with *S220 reduced* bias when input level is decreased from -45 dBm to -40 dBm.

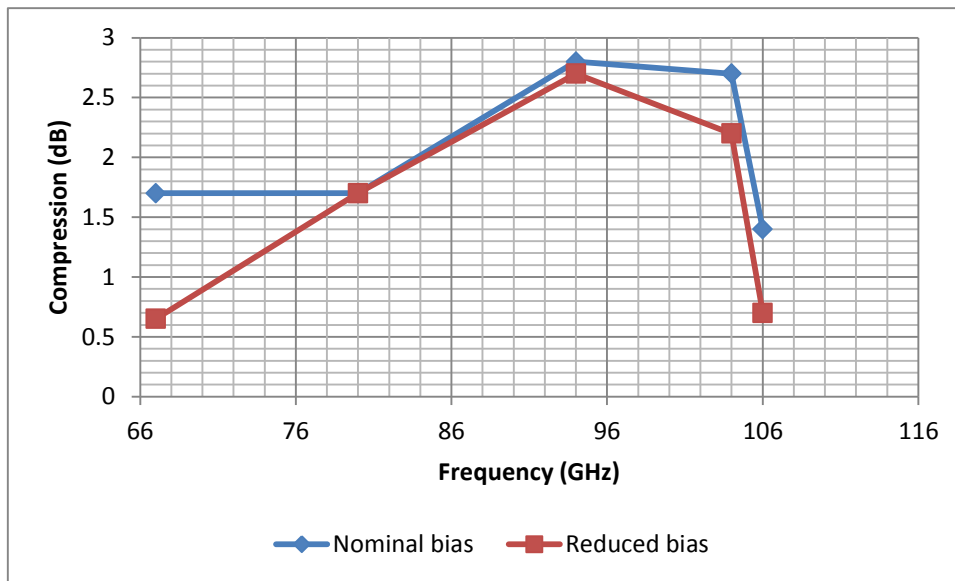

Figure 33 Insertion Gain Compression measured at five frequencies for S220 nominal and reduced bias.

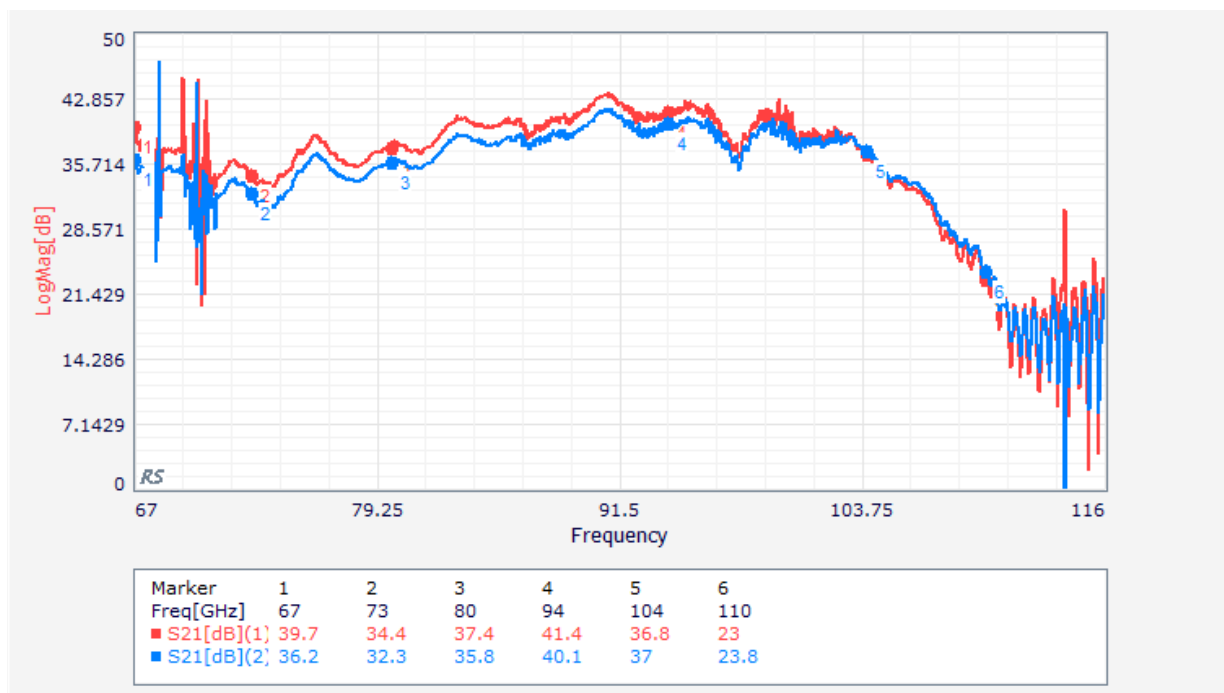

Figure 34 VNA input level set to -45 dBm. Insertion gain variation when S220 Id bias is lowered from 20 mA (nominal, red curve) to 15 mA (reduced, blue curve).

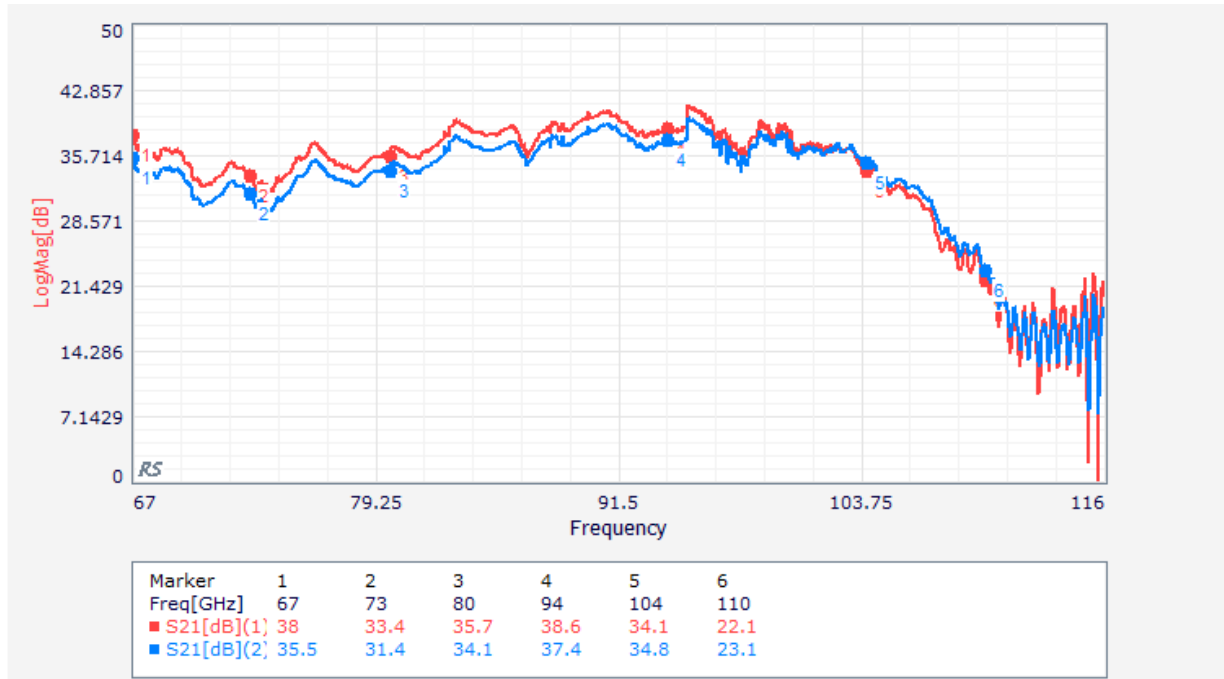

Figure 35 VNA input level set to -40 dBm. Insertion gain variation when S220 Id bias is lowered from 20 mA (nominal, red curve) to 15 mA (reduced, blue curve).

10.10 Test 5: Cascaded LNAs "S220" + "S217"

The test is aimed at measuring RL and IL of the two cascaded amplifiers.

Bias LNAs to 0; wear the antistatic bracelet.

The two LNAs shall be connected respecting the following sequence:

- 1st Amplifier : S220
- 2nd Amplifier : S217

10.10.1 Nominal Id Bias setup:

The two LNAs shall be biased applying **nominal bias** defined in **Errore**. **L'origine riferimento non è stata trovata.** and 10.3

The following table is filled:

	LNA 217	LNA 220
Id Set (mA)	20.03	18.92

VD Set (V)	1	1
Vg1 measured (V)	0.570	0.228
Vg2 measured (V)		
Ig1 measured (uA)	N.A.	N.A.
Ig2 measured (uA)	N.A.	N.A.
Calibration input level	-40 dBm	
VNA input level (at LNA 217)	-45 dBm	
Temperature	25.9 °C	
Filename	s220s217_c40p45.s2p	

Table 13 LNA S220 + S217 settings (Vg have been measured with RF off)

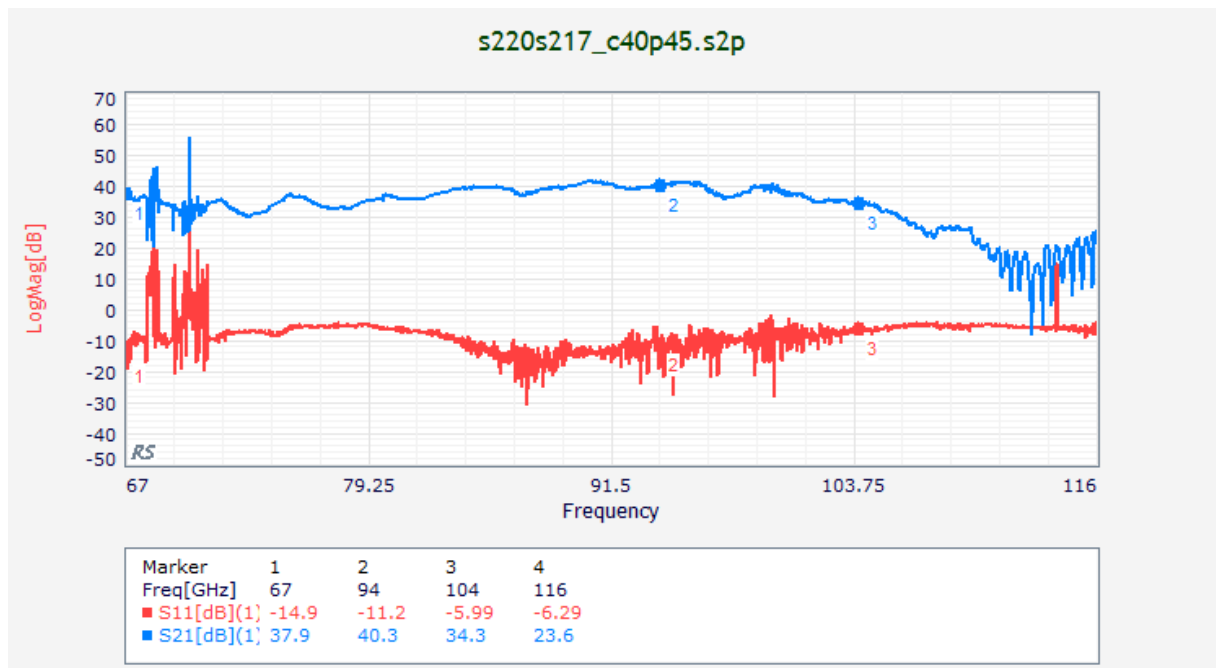

Figure 36 cascaded S220 and S217 LNAs: nominal bias setup.

Keeping the bias fixed, the VNA input level is increased to -40 dBm.

The following table is filled:

	LNA 217	LNA 220
Id Set (mA)	20.03	18.92
VD Set (V)	1	1
Vg1 measured (V)	0.570	0.228
Vg2 measured (V)		
Ig1 measured (uA)	N.A.	N.A.
Ig2 measured (uA)	N.A.	N.A.
Calibration input level	-40 dBm	
VNA input level (at LNA 217)	-40 dBm	
Temperature	25.9 °C	
Filename	s217s220_c40p40.s2p	

Table 14 LNA S217 + S220 settings; VNA input level is increased to -40 dBm.

Improvement is observed in the IL trace (Figure 22) : many features disappear or are reduced.

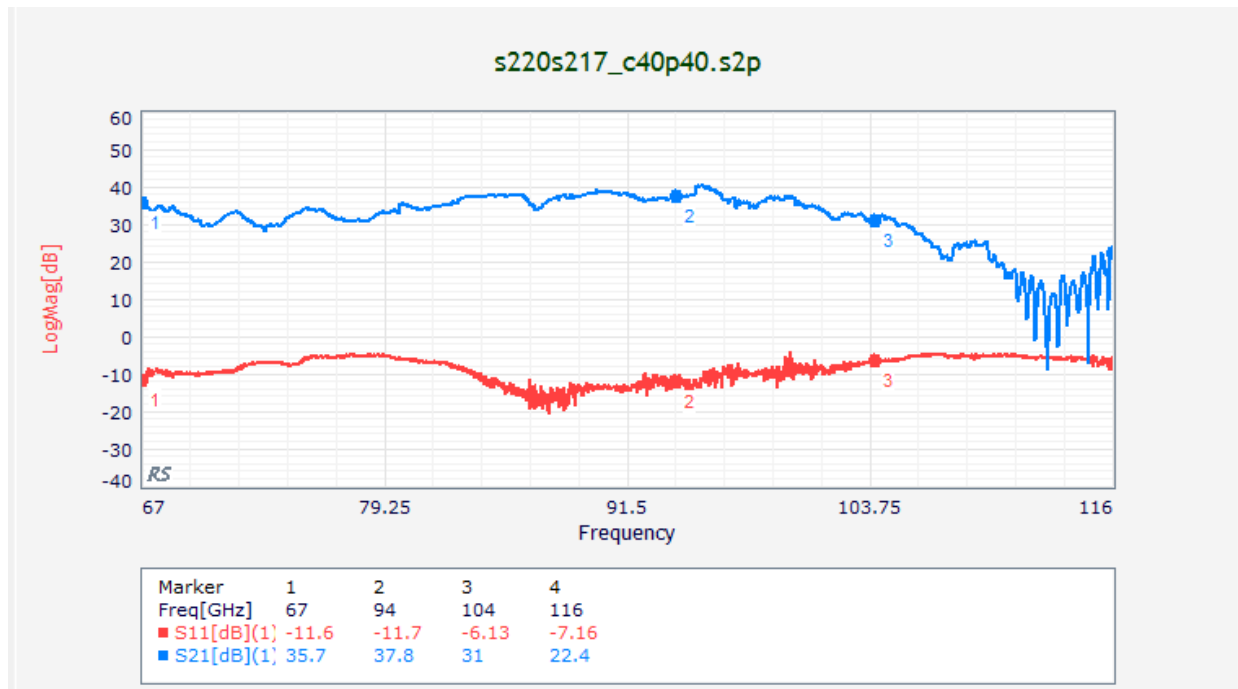

Figure 37 cascaded S220 and S217 LNAs: nominal bias setup with Input level increased from -45 dBm to -40 dBm.

the signal compression is evident. Return loss level changes only modestly between the two curves, typically due to noise level change, excluding, as in the case of the paired LNAs S217-S220, spurious features due to the differences between the calibration input level (-40 dBm) and changes in the VNA input levels at LNA 217 (from -45 dBm to -40 dBm).

Insertion gain instead decreases by something between 3.3 dB and 1.2 dB when the input power is increased from -45 dBm to -40 dBm. In the case of the -40 dBm configuration, the input power available at LNA S217 ranges between -31 dBm (at the highest frequencies, where the compression is less evident) and -15 dBm (at 67 GHz).

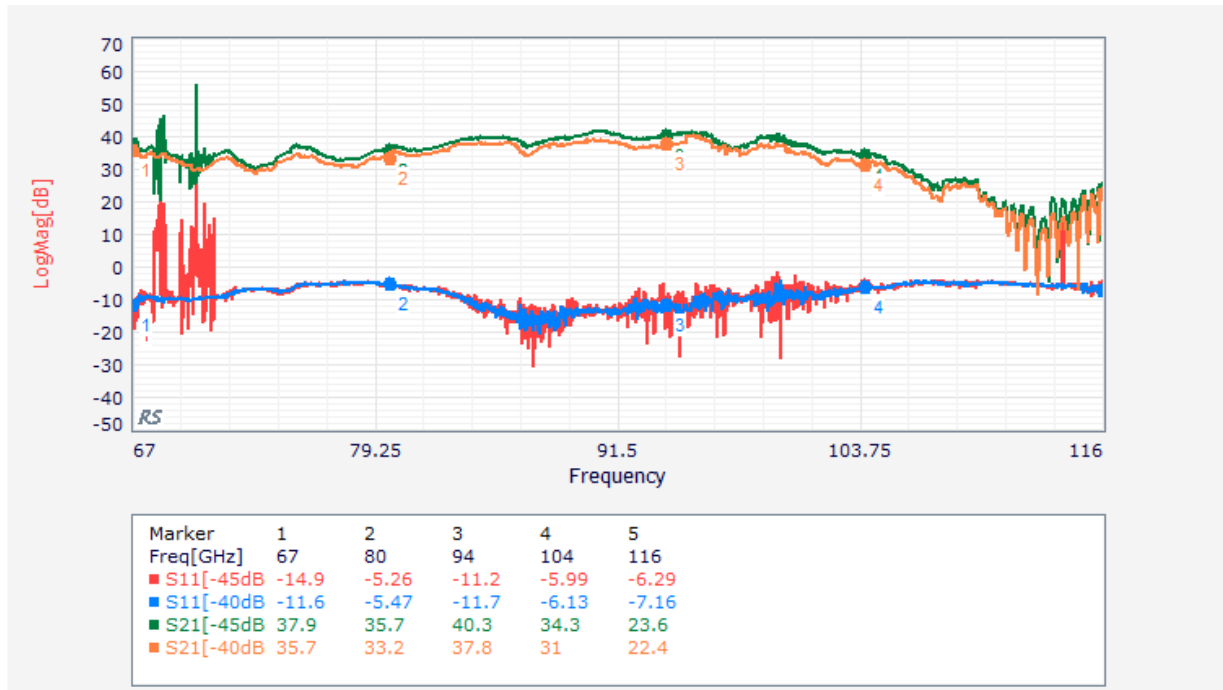

Figure 38 comparison between two setups with VNA input levels set to -45 dBm and to -40 dBm.

10.10.2 Reduced Id Bias setup on LNA S220:

The bias setup described in §10.5.1 was applied to LNA S220. To comply with this, Drain Current was lowered down to 15 mA to get the Gate voltage value 350 mV.

VNA Input level was lowered again to -45 dBm.

The following table is filled:

	LNA 217	LNA 220
Id Set (mA)	20	15

VD Set (V)	1	1
Vg1 measured (V)	0.296	0.350
Vg2 measured (V)		
Ig1 measured (uA)	N.A.	N.A.
Ig2 measured (uA)	N.A.	N.A.
Calibration input level	-40 dBm	
VNA input level (at LNA 217)	-45 dBm	
Temperature	25.9 °C	
Filename	s220s217_c40p45vg350.s2p	

Table 15 LNA S217 + S220 settings; LNA 220 bias settings are the same of §10.5.1.

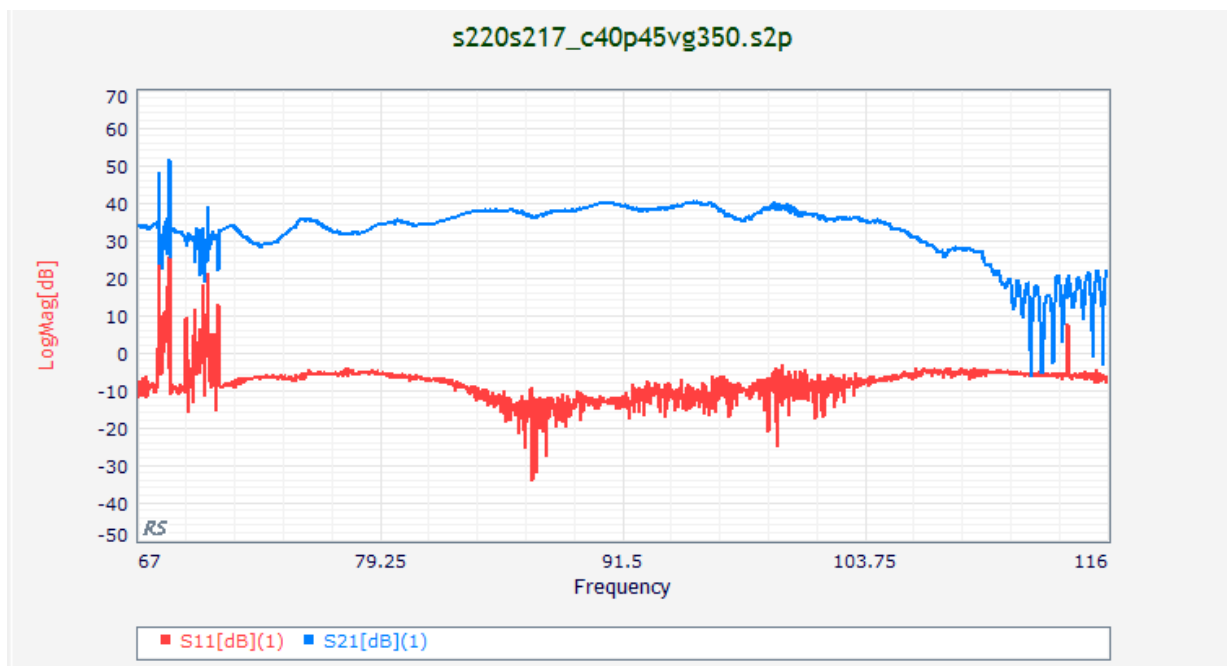

Figure 39 LNA S220 + S217 IL and RL under the bias settings of Table 9.

The measure shows the same noise of the nominal bias setup conditions of Figure 36.

It means that noise is independent on the bias setup of LNA S220, depending instead on the VNA input level available at the first cascaded LNA (S217).

Keeping the bias fixed, the VNA input level is increased again from -45 dBm to -40 dBm.

The following table is filled:

	LNA 217	LNA 220
Id Set (mA)	20	15

VD Set (V)	1	1
Vg1 measured (V)	0.296	0.350
Vg2 measured (V)		
Ig1 measured (uA)	N.A.	N.A.
Ig2 measured (uA)	N.A.	N.A.
Calibration input level	-40 dBm	
VNA input level (at LNA 217)	-40 dBm	
Temperature	26.0 °C	
Filename	s220s217_c40p40vg350.s2p	

Table 16 LNA S217 + S220 settings; VNA input level is increased to -40 dBm.

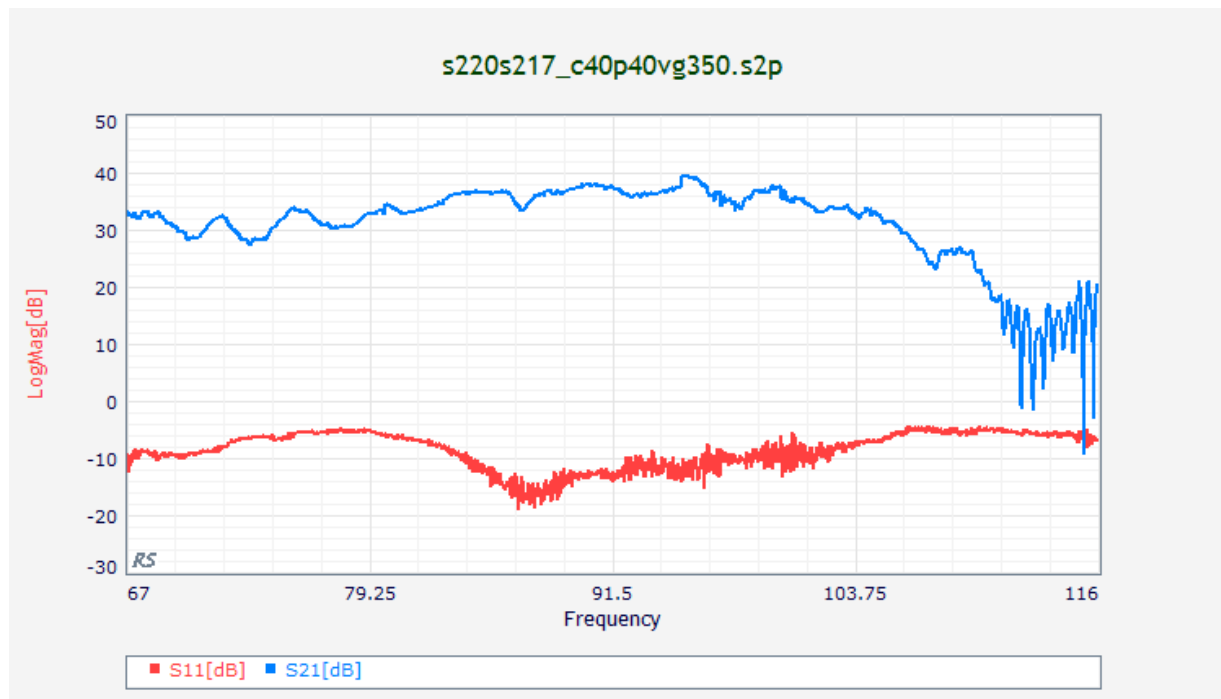

Figure 40 LNA S217 + S220 IL and RL under the reduced bias settings of Table 12 and with VNA input level increased to -40 dBm.

As in the previous case of Figure 26, improvement is observed in the IL trace shown in Figure 40: many undesired noisy features disappear.

As in the previous case of Figure 38, the signal compression is evident. Actually, Return loss level does not change between the two curves but in the points where the signal is noisy (differences are due to noise in the -45 dBm trace).

Insertion gain decreases by something between 1.1 and 2.2 dB when the input power is increased from -45 dBm to -40 dBm. The compression effect seems slightly lower under the 'reduced bias' setup respectively to the

'nominal bias' setup. This is in somewhat expected because of the higher total gain.

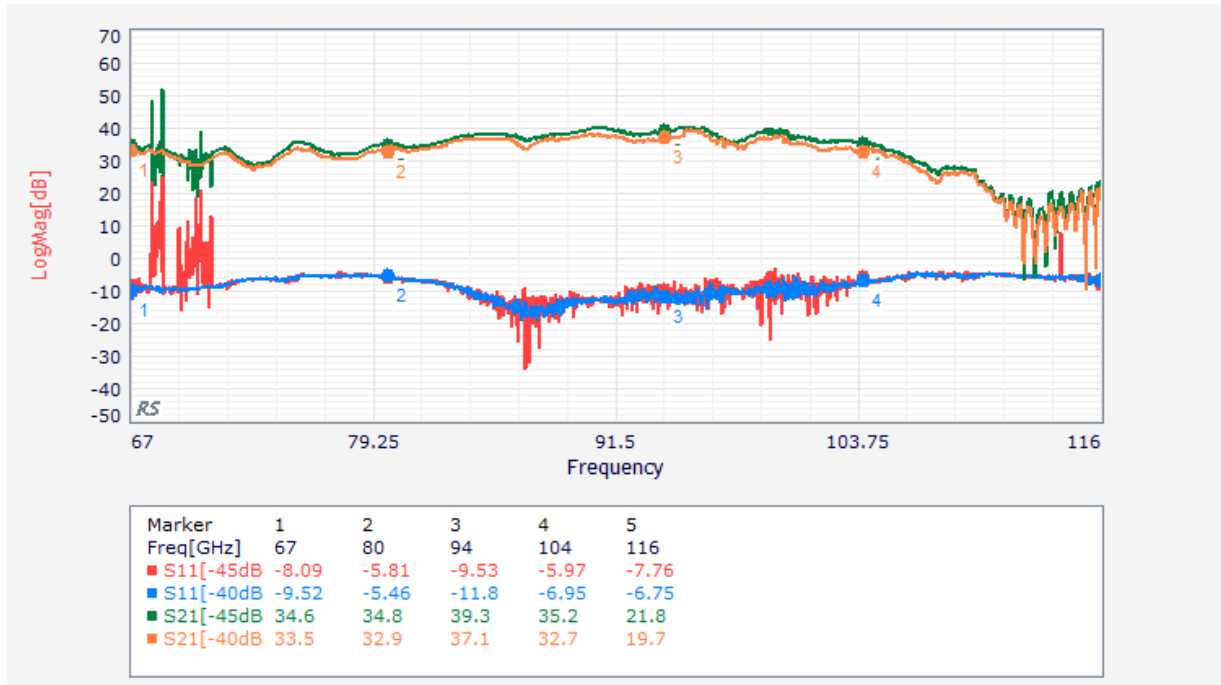

Figure 41 comparison between two reduced bias setup on LNA S220, with input levels set to -45 dBm and to -40 dBm.

10.10.3 Comparison between nominal and reduced bias setup

As already done in the previous case of the cascaded LNAs S217+S220, we compare hereafter the return Loss and Insertion Loss of the two cascaded amplifiers **S220+S217** under the conditions analysed in § 10.10.1 and § 10.10.2.

Comparison shows that:

- **Return Loss level keeps about constant when:**

- c) VNA input level available at LNA S220 is changed from -45 dBm to -40 dBm, without respect to the bias setup.

- See Figure 23 and Figure 26 and more details in Figure 27 and Figure 28.

- d) LNA S220 Id bias setup is reduced from nominal (20 mA) to 15 mA and the input power is kept fixed to either -40 dBm or -45 dBm.

- See Figure 29 and Figure 30.

- **Insertion gain changes (is compressed) by something between 1 dB and 2.5 dB when:**

VNA input level available at LNA S217 is changed from -45 dBm to -40 dBm (Figure 31, Figure 32).

Compression occurs without respect to the bias setup of LNA S220 (Figure 33). Actually, compression level is independent on the second amplifier (LNA S220) bias setup and depends only (as expected) on the VNA input level available at LNA S217

- **Gain changes by something between 1 dB (higher frequencies) and 5 dB (lower frequencies) when LNA S220 bias settings are changed from nominal to reduced.**

The behaviour is shown in Figure 34.

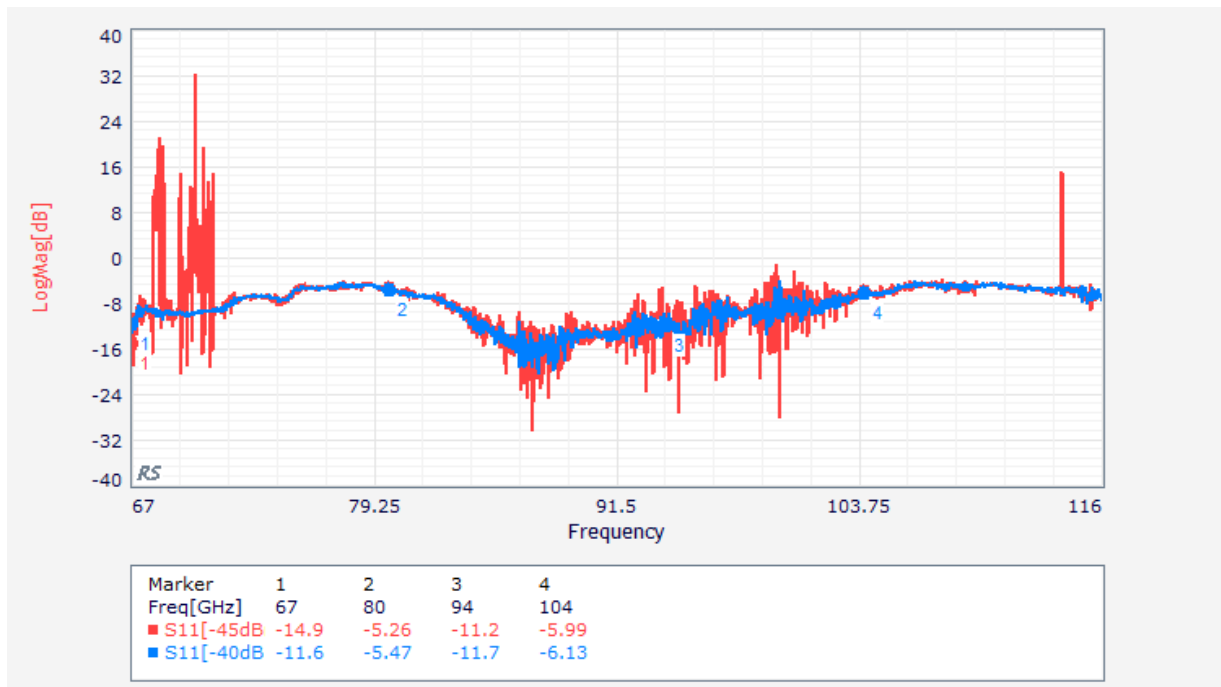

Figure 42 RL: S220 has nominal bias; VNA input level is decreased from -45 dBm to -40 dBm.

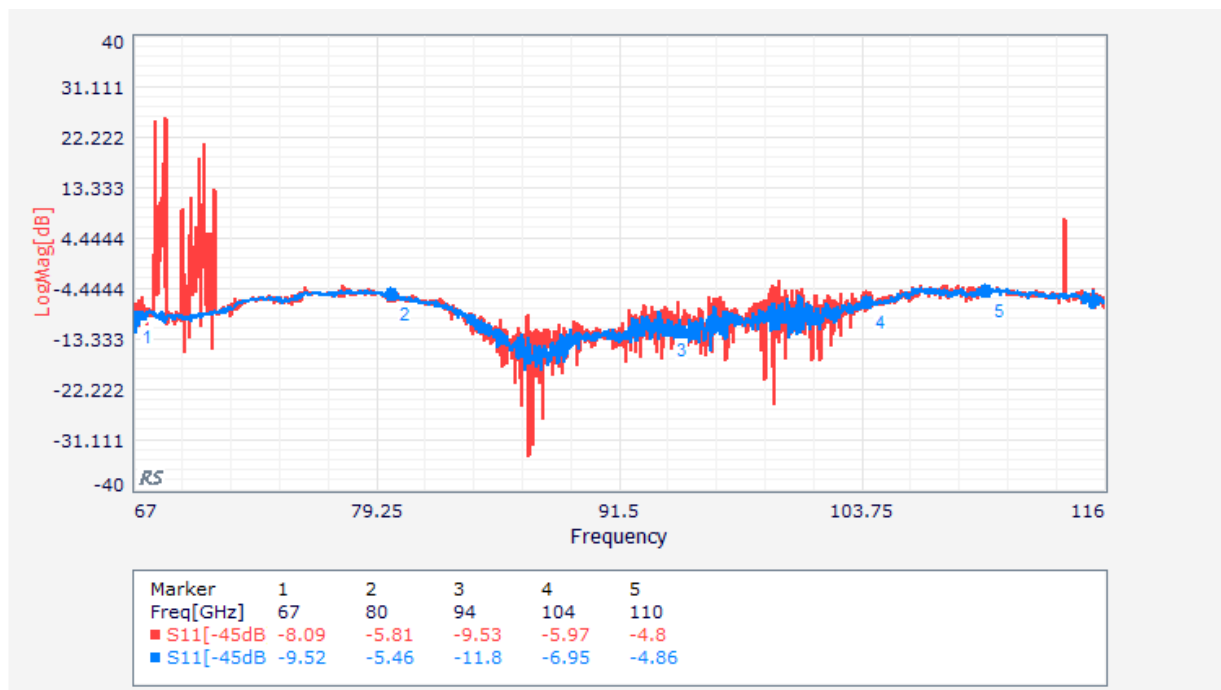

Figure 43 RL: S220 has reduced bias; VNA input level is decreased from -45 dBm to -40 dBm.

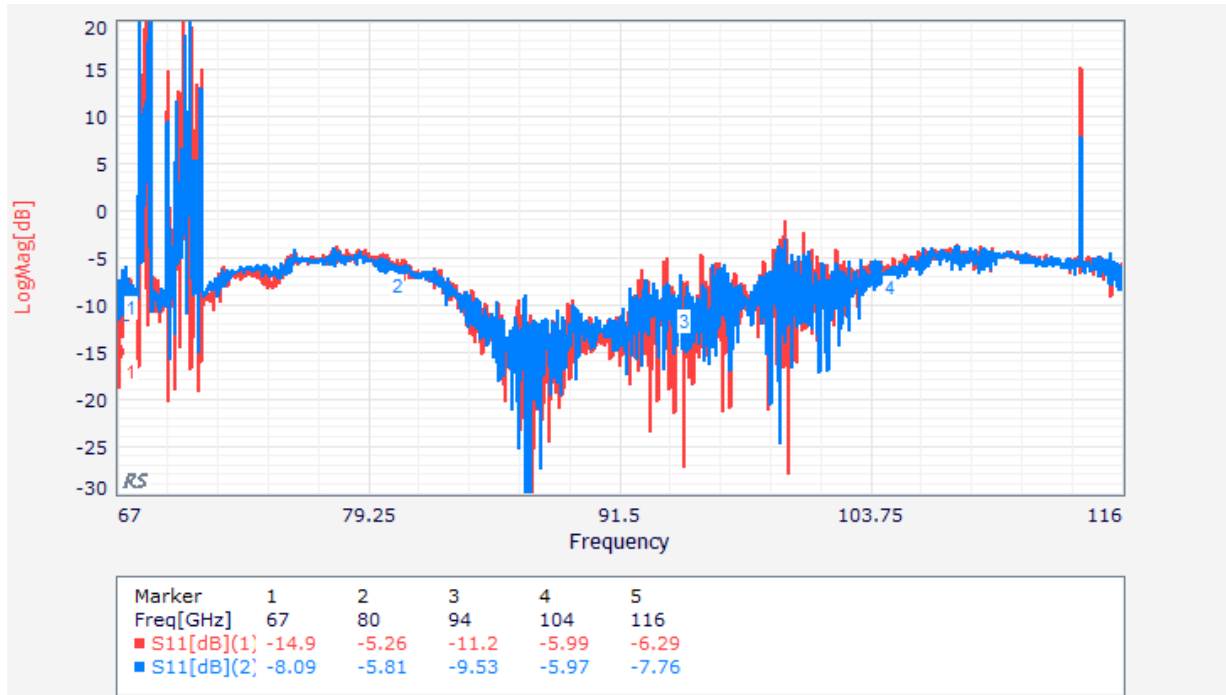

Figure 44 *RL comparison @ VNA input = -45 dBm* between the two bias setup conditions of LNA S220: $I_d = 20$ mA and $I_d = 15$ mA.

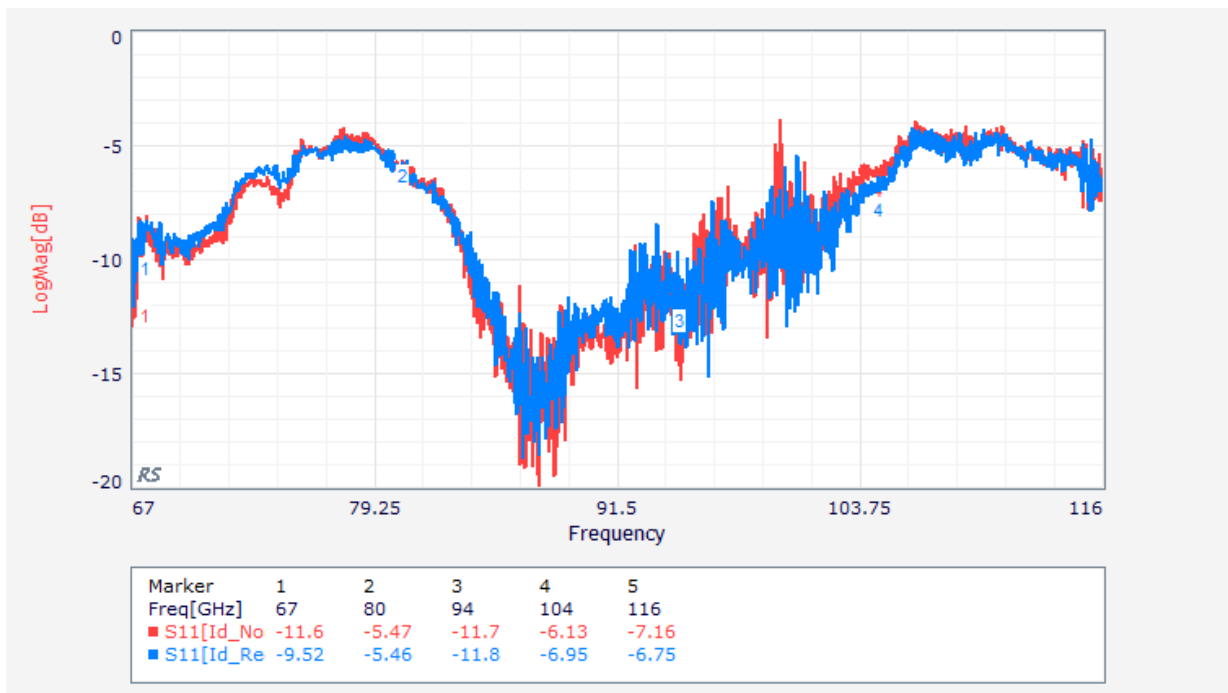

Figure 45 *RL comparison @ VNA input = -40 dBm* between the two bias setup conditions of LNA S220: $I_d = 20$ mA and $I_d = 15$ mA.

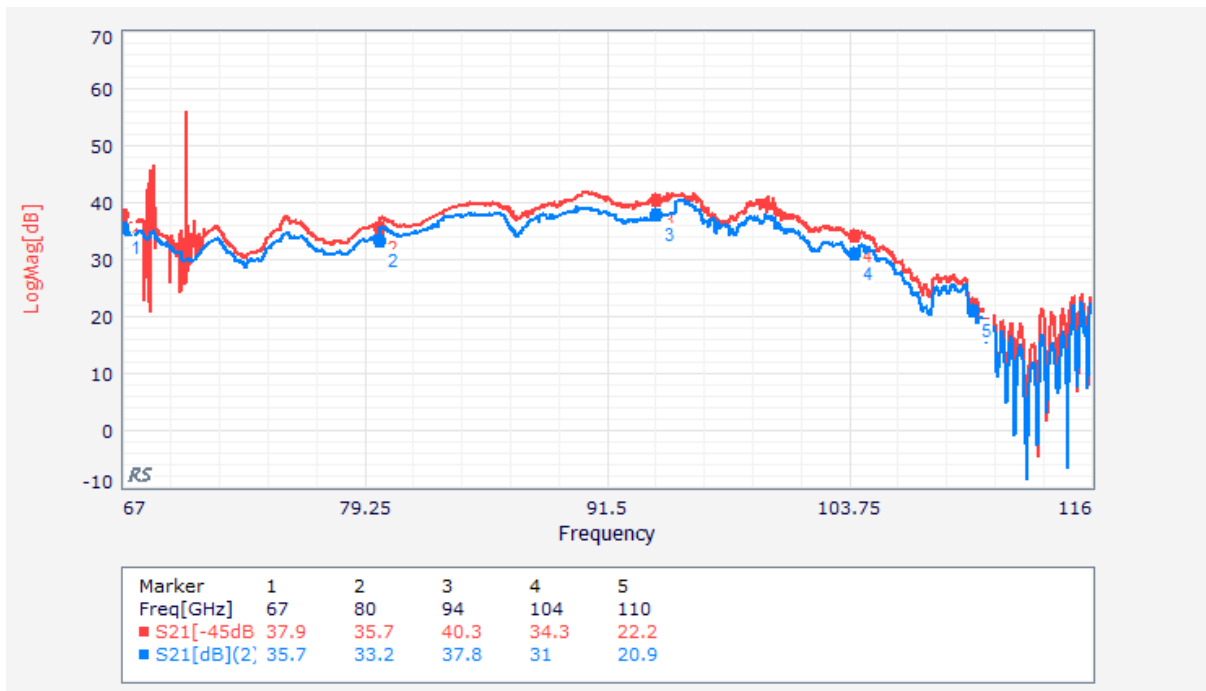

Figure 46 Insertion Gain. Compression effect with S_{220} nominal bias when input level is decreased from -45 dBm to -40 dBm.

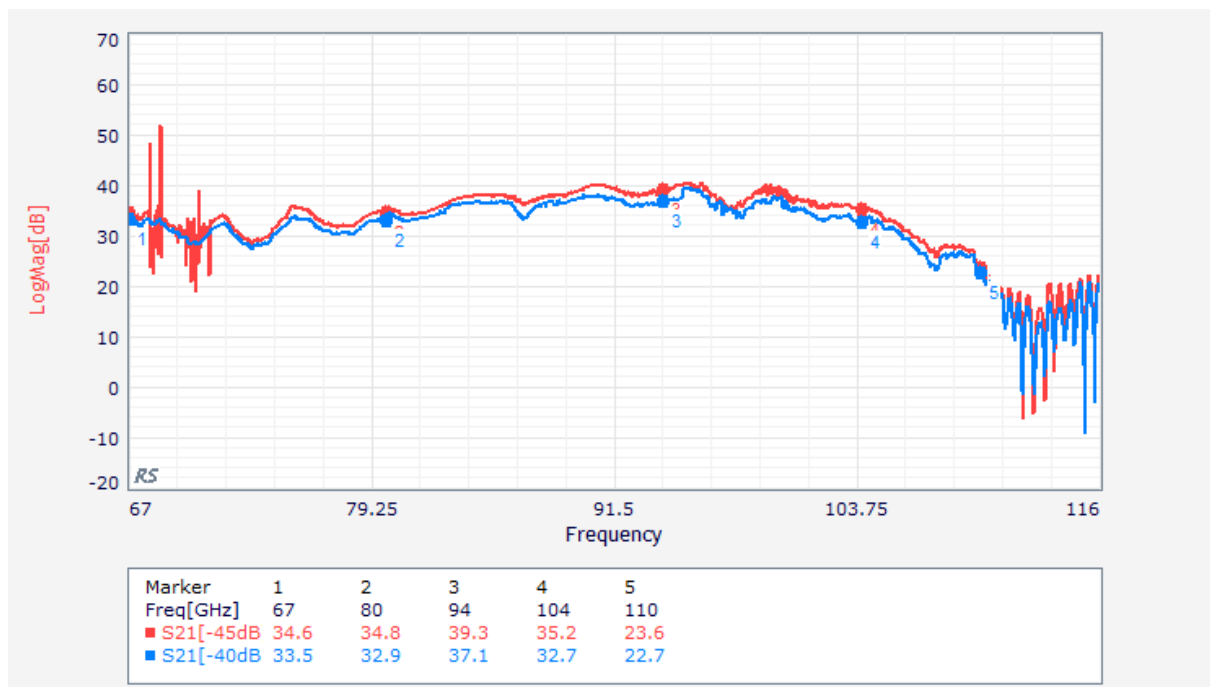

Figure 47 Insertion Gain. Compression effect with S_{220} reduced bias when input level is decreased from -45 dBm to -40 dBm.

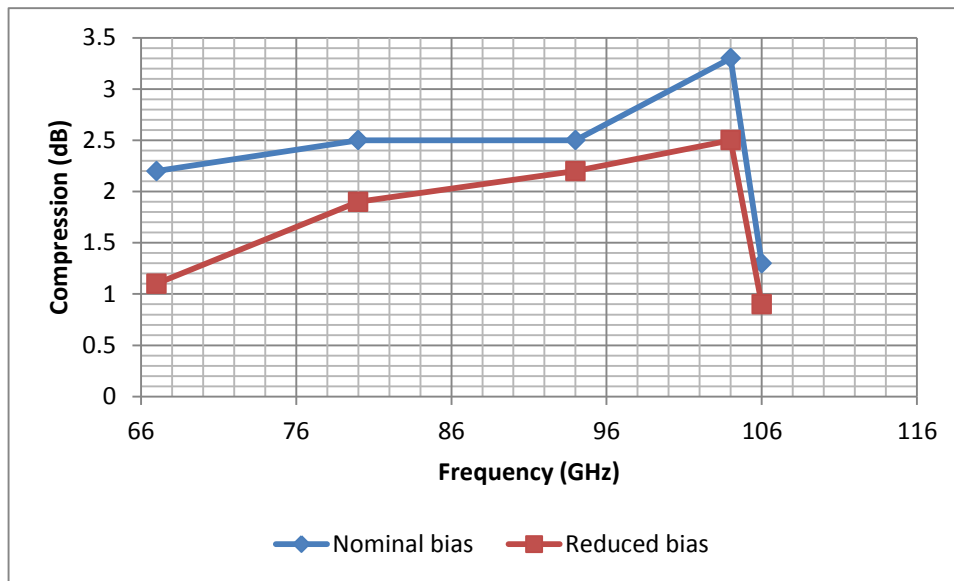

Figure 48 Insertion Gain Compression measured at five frequencies for S220 nominal and reduced bias. VNA input level is set @ -45 dBm.

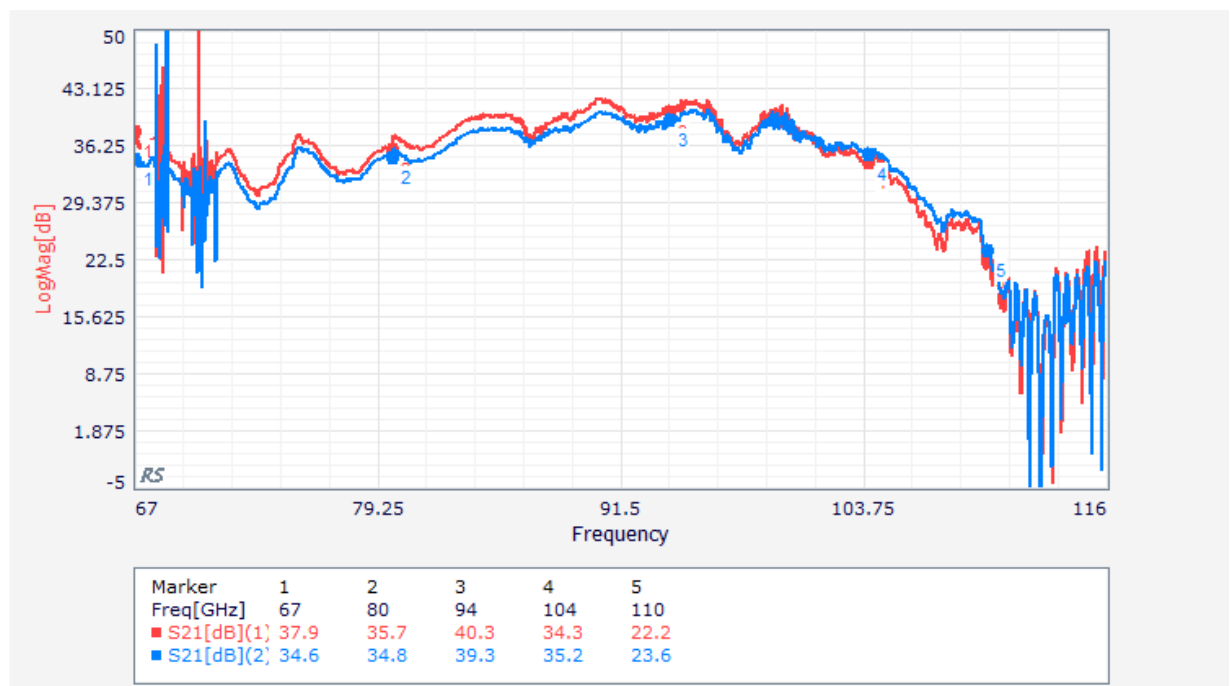

Figure 49 VNA input level @-45 dBm: Insertion gain variation when S220 Id bias is lowered from 20 mA (nominal) to 15 mA (reduced).

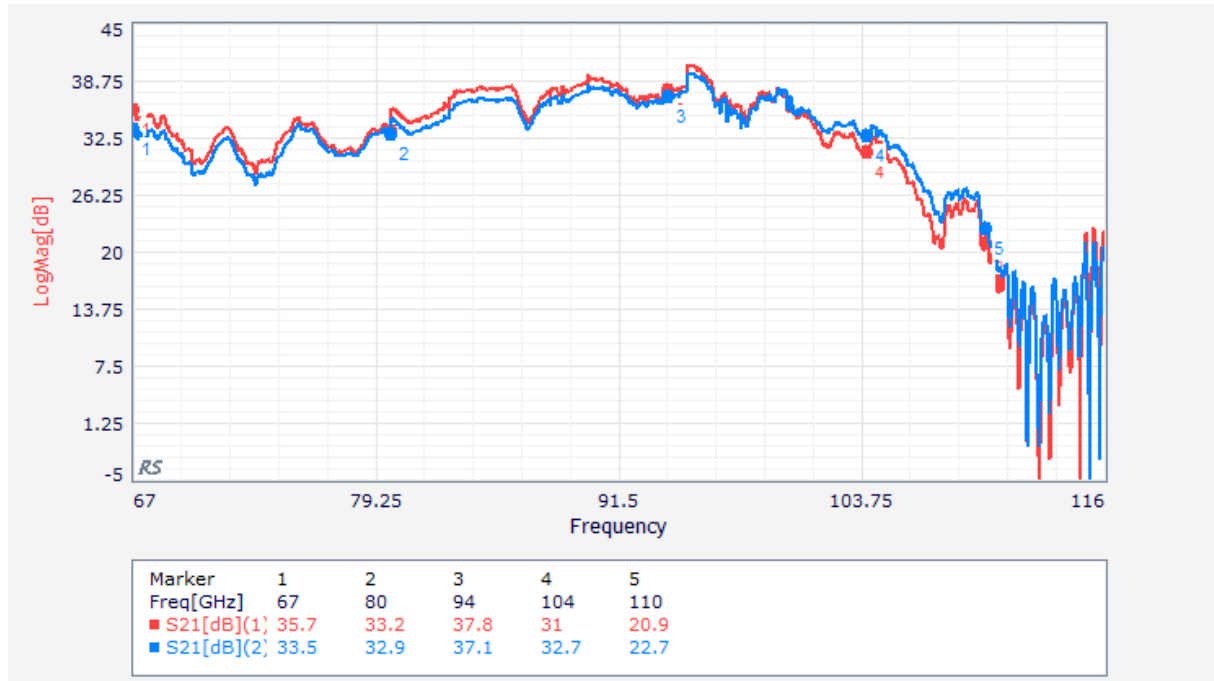

Figure 50 VNA input level @-40 dBm: Insertion gain variation when S220 Id bias is lowered from 20 mA (nominal) to 15 mA (reduced). OK

10.11 Comparison between the two configurations: S217+S220 against S220+S217. VNA Input level @ -45 dBm

10.11.1 Total Return Loss

10.11.1.1 Nominal Bias

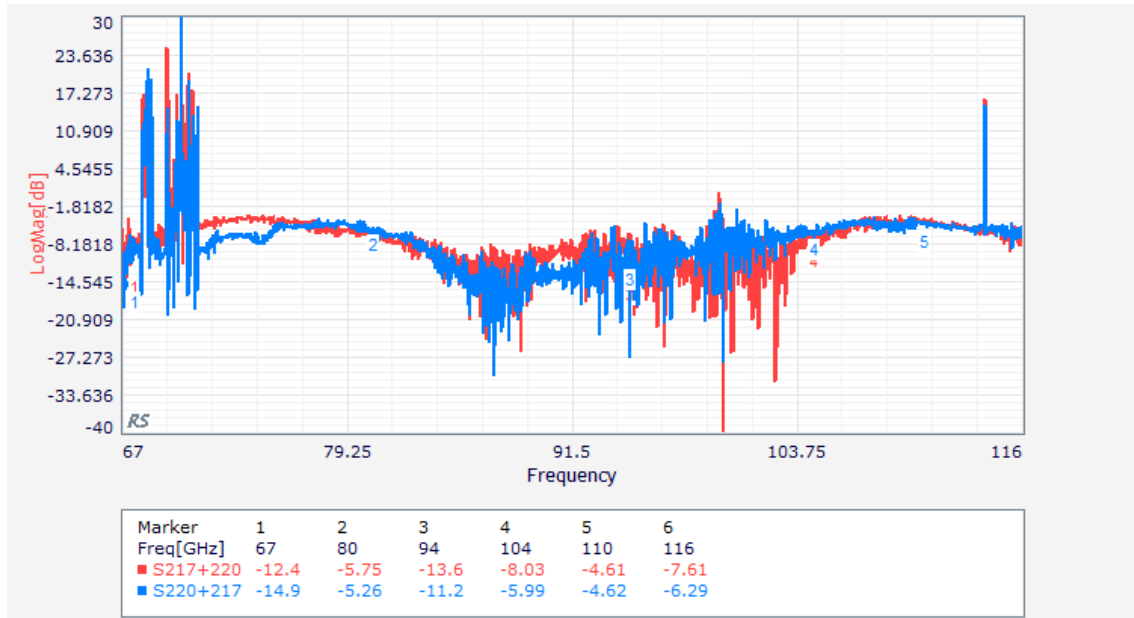

Figure 51

10.11.1.2 Reduced Bias

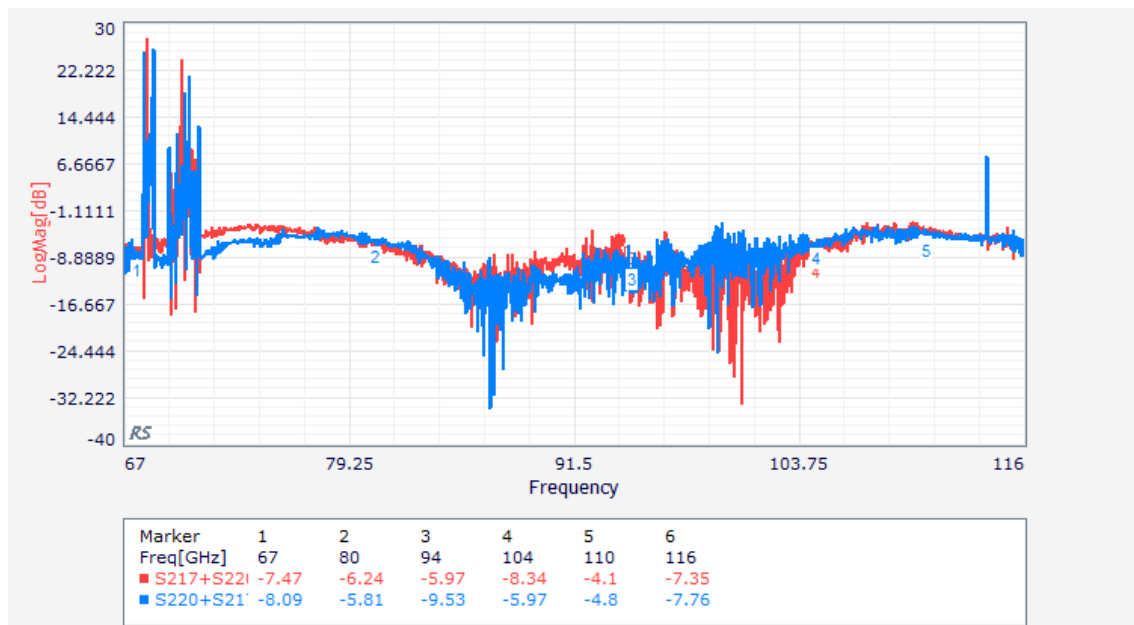

Figure 52

10.11.2 Total Insertion Gain

10.11.2.1 Nominal Bias

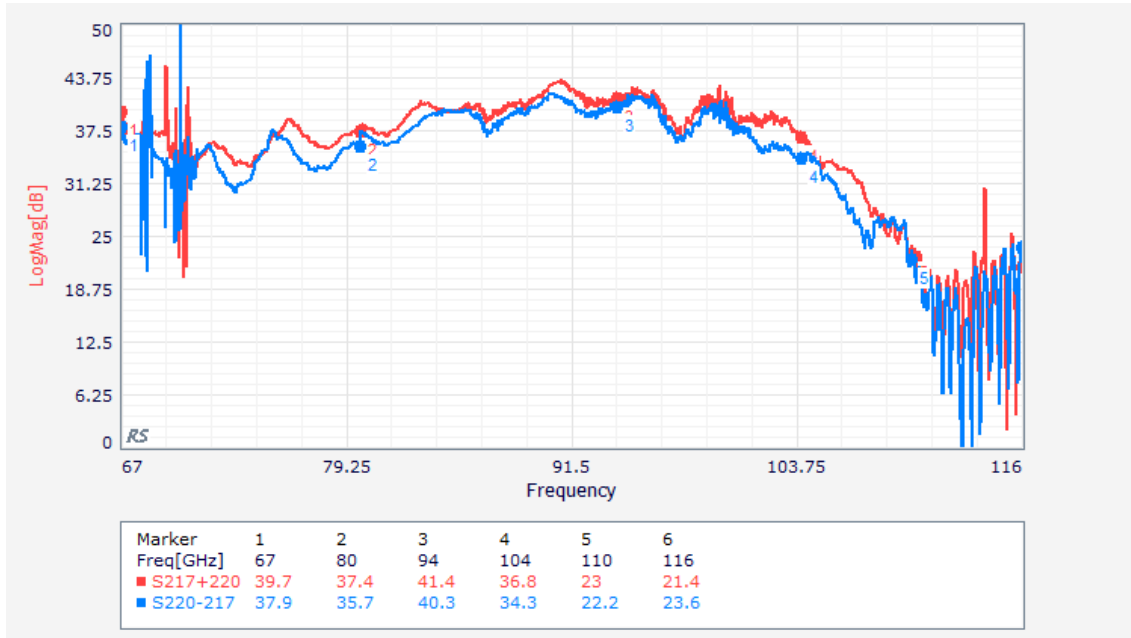

Figure 53

10.11.2.2 Reduced Bias

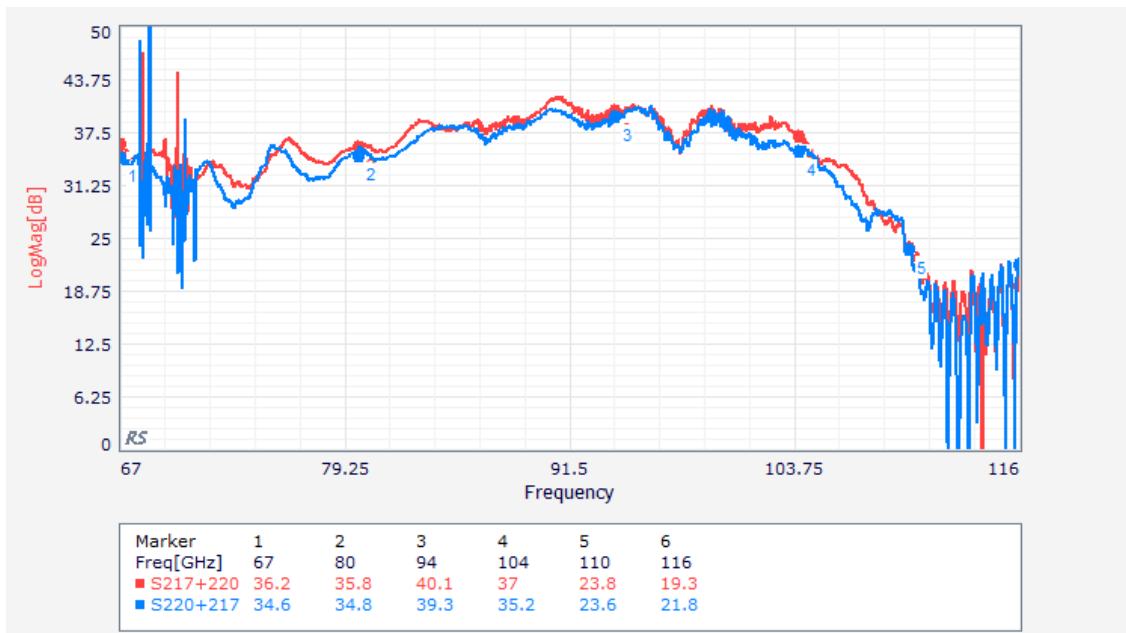

Figure 54

10.12 Comparison between the two configurations: S217+S220 against S220+S217. VNA Input level @ -40 dBm

10.12.1 Total Return Loss

10.12.1.1 Nominal Bias

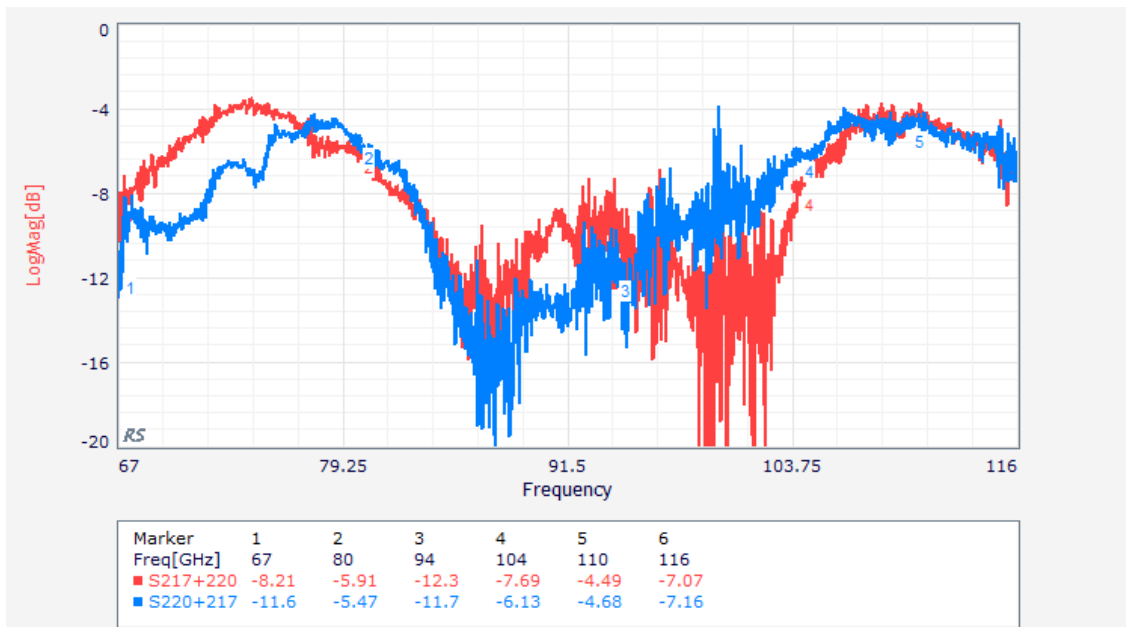

Figure 55

10.12.1.2 Reduced Bias

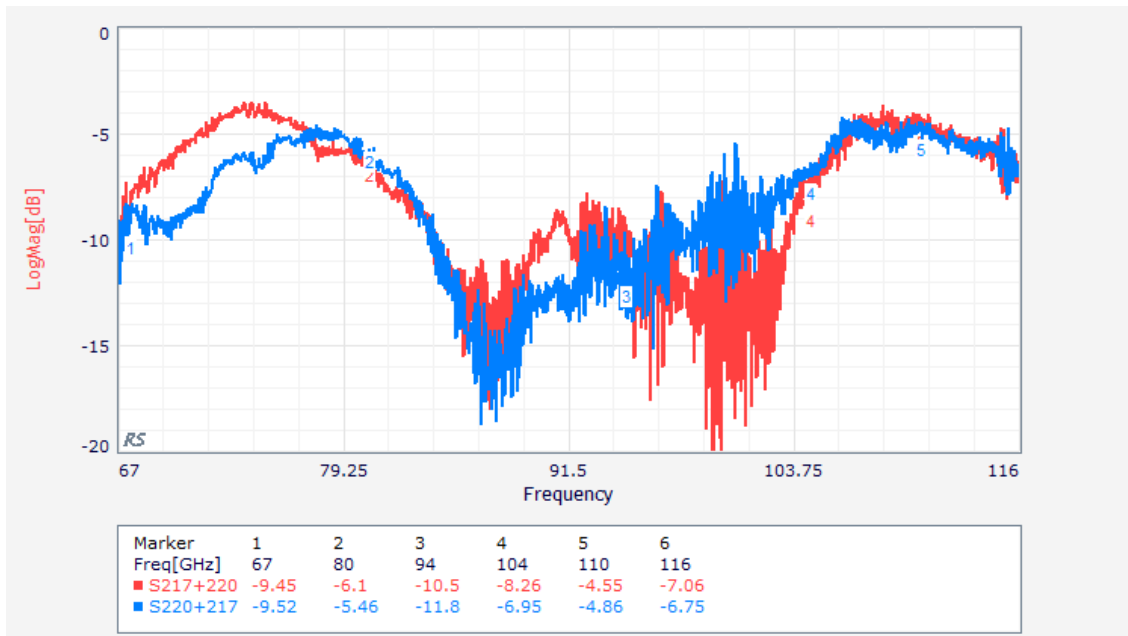

Figure 56

10.12.2 Total Insertion Gain

10.12.2.1 Nominal Bias

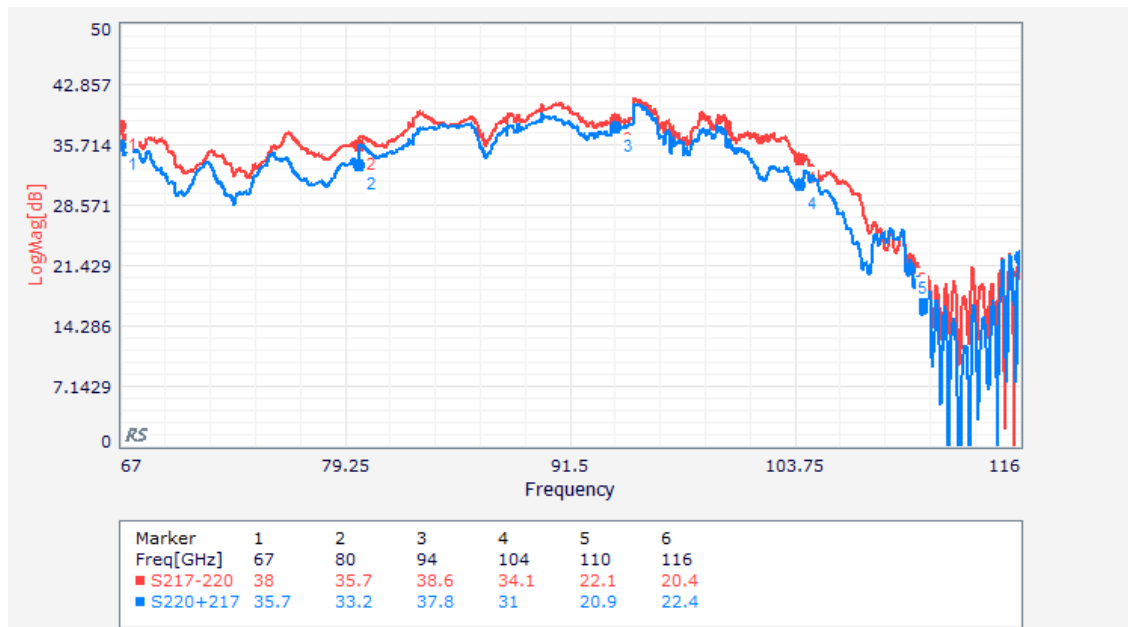

Figure 57

10.12.2.2 Reduced Bias

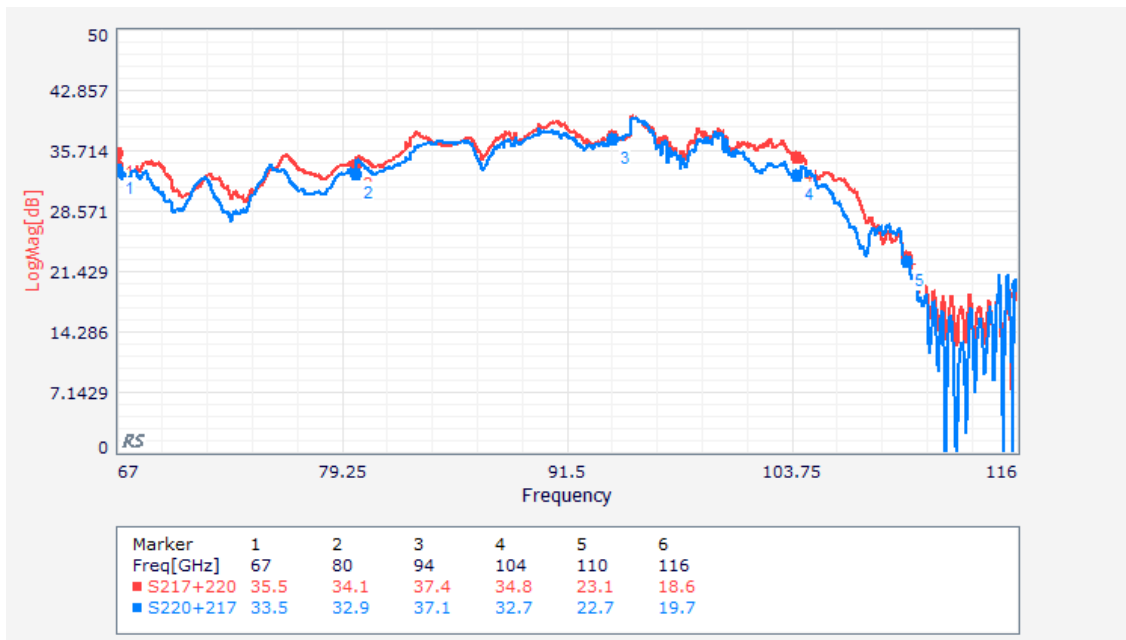

Figure 58

10.13 Cascaded configurations: general comments.

The above plots show that:

Return Loss shape changes with the sequence of the paired LNAs, without major respect to the bias applied and to the VNA input level (Figure 51 and Figure 52 ; Figure 55 and Figure 56).

As expected, the main contribution to RL level and shape is given by the first LNA; the paired LNA (second) contribution exhibit as increased noise (Figure 59).

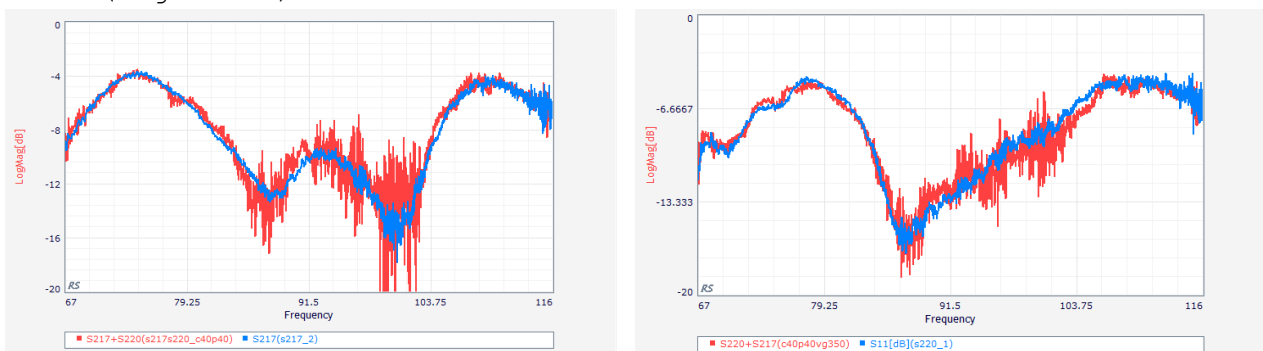

Figure 59 Left panel: Return Loss of the combination S217+S220 (red, reduced bias) vs S217 (blue, nominal bias); Right panel Return Loss of the combination S220+S217 (red, reduced bias) vs S220 (blue, nominal bias).

Forward Gain (Insertion Gain) shape does not change sensibly with the sequence of the paired LNAs whilst the total gain level does (Figure 53 Figure 54 Figure 57 Figure 58).

The Forward Gain level changes by something between 1 dB and 3 dB, depending on the sequence of the paired LNAs. S217+S220 combination shows always a gain higher than S220+S217; due to compression, in both cases the total gain is higher by about 2dB when the VNA input is set to -45 dBm. The lowest gain is measured for both bias setup when VNA Pin is set to -40 dBm. A Comparison of all combinations is shown in Figure 60.

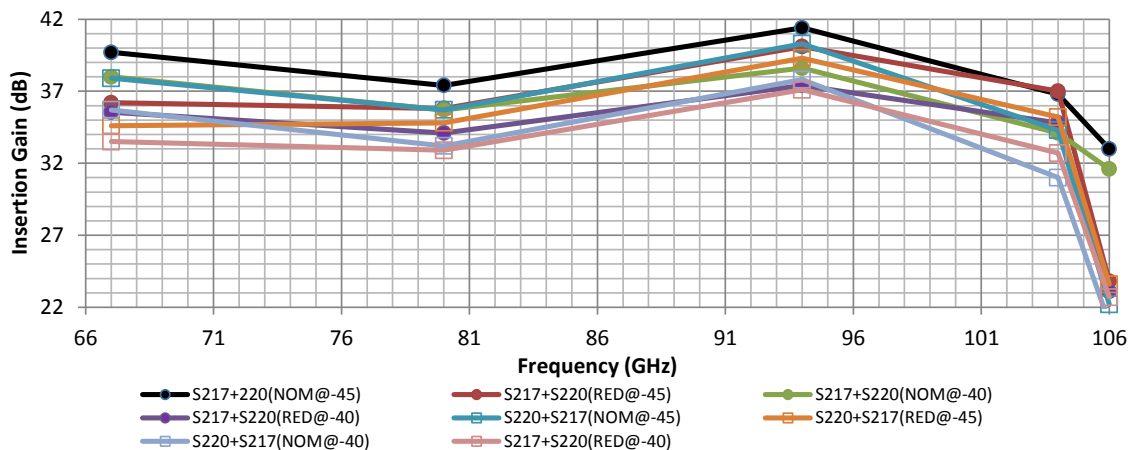

Figure 60

10.14 Check Oscillations (TBC)

Any possible oscillations will be verified (TBC)

A dedicated test was not performed.

As reported in the previous paragraphs, oscillations of Vg bias (the Id current is fixed by the power supply scheme) were observed caused by RF to DC coupling.

NOT PERFORMED

A dedicated (TBD) test will be performed to verify the maximum RF input level acceptable to avoid any instabilities.



10.15 Test 6: Cascaded LNAs Compression Point (TBC)

Wear the antistatic bracelet

Basing on indications from §10.4 and §10.6, perform the test following method described in Option 1 or in Option 2

A dedicated test was not performed.

Depending on the sequence of the two LNAs, a WR10 variable attenuator providing attenuation higher than 30 dB is requested.

In fact, basing on compression tests performed on the individual LNAs, to only an input power at the LNA in lower than -40 dBm can assure to operate the LNA in the uncompressed region.

However, we verified that if we calibrate at a VNA level lower than -40 dBm results are noisy.

A possible procedure (TBC) is:

- Calibrate the VNA at the lowest acceptable P_{in} that could be set during the test. To be safe we could state $P_{in} = -33$ dBm (the same



set in §10.3, 10.4, 10.5, 10.6). In this way, S/N can only increase when Pin is increased.

- The VNA attenuator will have the capability to increase power up to -13 dBm.
- Use a variable attenuator with the capability to be set to a fixed value <- X dB).
- The X dB value is chosen to provide the second LNA with an Input power < -40 dBm when the first LNA is powered with nominal bias (maximum gain 25 dB) and the VNA Pin is -33 dBm.

It means:

$$-33 + 25 - X) \text{ dBm} < -40 \text{ dBm}$$

That is:

$$X < -32 \text{ dB} ;$$

to be safe and to have a large dynamic range in the second LNA we can set:

$$X = -40 \text{ dB}$$

- Characterize the variable attenuator in the fixed position (X dB).
- Connect the two cascaded LNAs.
- Record S parameters varying the VNA Pin from -33 dBm up to - 10 dBm. This range corresponds to input power at:

$$\underline{1^{\text{st}} \text{ LNA}} = [- 73 \text{ dBm} : - 50 \text{ dBm}]$$

$$\underline{2^{\text{nd}} \text{ LNA}} = [- 48 \text{ dBm} : - 25 \text{ dBm}]$$

10.16 Test 10: Cascaded "S217" + "S220" LNAs + WR 10 Diode

Wear the antistatic bracelet

Assembly:

Bias LNAs to 0

Disconnect the VNA cable

Connect the WR 10 diode (without filter)

Bias the WR 10 diode; diode bias settings are reported **in TBC**

Connect the diode output to the Tester (TBC)

Biasing:

Bias LNAs to nominal values



The following table shall be filled:

Id Set (mA)
VD Set (V)
Vg1 measured (V)
Vg2 measured (V)
Ig1 measured (uA)
Ig2 measured (uA)

Table 17 LNA S217 + S220 settings

The test was performed only at 0 level, because of several setup problems encountered.

In fact, the power coming out from the coupled LNAs is too high and seems to saturate the diode.

The diode was expected to provide an output voltage of about < 3 mV when is operated in uncompressed condition (typically corresponding to Pin typically of the order of -20 dBm).

A variable attenuator fixed to $IL \sim -20$ dB (curve shown in Figure 61) is interposed between the VNA and the 1st LNA. We observed that numbers stamped on the attenuator do not correspond to the actual attenuation. We found the correct value by VNA measurement.

A Voltmeter is used to measure Voltage from the diode.

Recommendation: a voltmeter appreciating at least 0.01 mV is required to have the needed sensitivity.

VNA Pin is set to -40 dBm.

Under this conditions Power input at diode is lower than -20 dBm.

However, at a first glance it seems that diode is still compressed. The dynamic range of the attenuator does not allow to decrease further the power input.

In order to disentangle the contribution to total noise due to the true signal (RF) from that due to amplifiers (thermal noise amplified times 40 dB and LNAs noise temperature) the RF is switched OFF leaving LNAs ON.

The Voltage read is 2.2 mV; we check if this value is at least roughly consistent with what expected (1.6 mV in the S220+S217 configuration, supposing $400K$ Tnoise, as referred by JPL/NASA):

Using measured insertion gain measured (noise temperature was supposed 200 K) we make a simple calculation:

With RF OFF:



FREQUENCY	GAIN (dB)	dBm OUT	Conv (mV/mW)	Vout (mV)
67.0	40	-2.43E+01	300	1.85
80.0	37.4	-2.69E+01	300	1.67
94.0	41.4	-2.29E+01	300	1.97
104.0	37	-2.73E+01	300	1.65
106.0	23.6	-4.07E+01	300	1.11
AVE (mV)				1.65

Table 18 $T_{in} = 300\text{ K}$; $T_{noise} = 200\text{ K}$

In the case that RF is switched ON, supposing a 39 GHz bandwidth, -40 dBm input power corresponds to about 10.000 K of thermal input.

With RF ON:

FREQUENCY	GAIN (dB)	dBm OUT	Conv (mV/mW)	Vout (mV)
67.0	40	-1.26E+01	300	3.59
80.0	37.4	-1.52E+01	300	2.97
94.0	41.4	-1.12E+01	300	4.04
104.0	37	-1.56E+01	300	2.89
106.0	23.6	-2.90E+01	300	1.55
AVE (mV)				3.01

Table 19 $T_{in} = R_{Fin} (-40\text{ dBm})$; $T_{noise} = 200\text{ K}$; $T_{room} = 300\text{ K}$

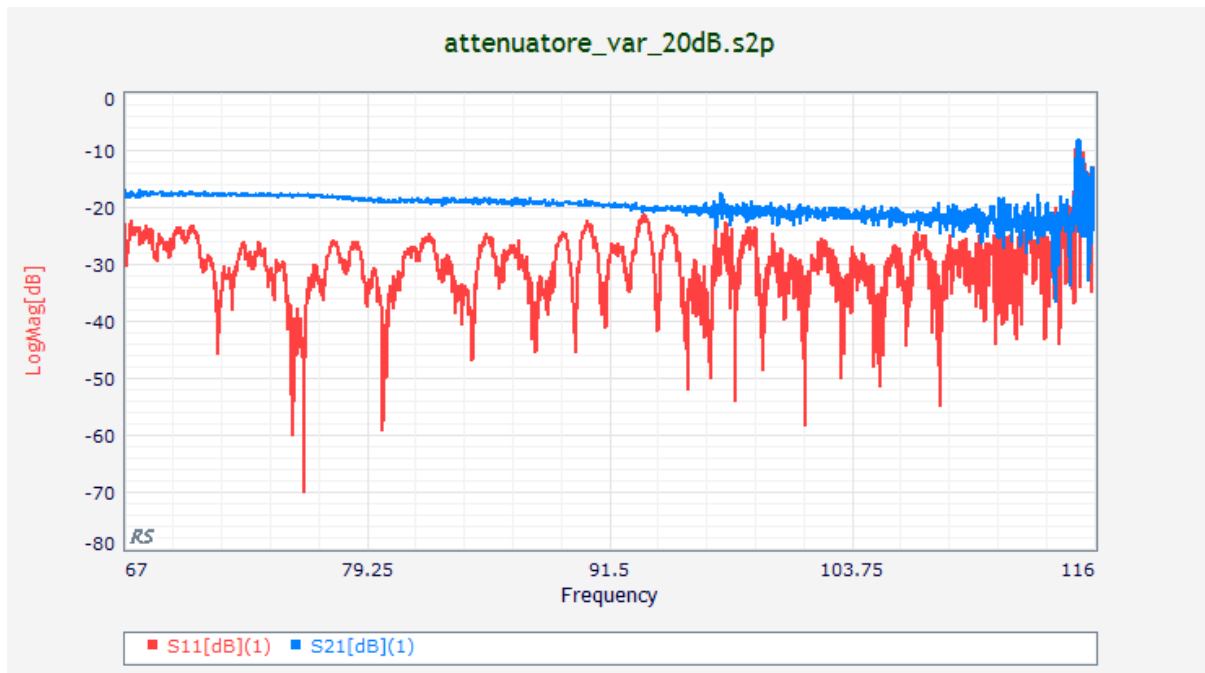

Figure 61 variable WR 10 attenuator (attenuation fixed to -20 dB)

FREQUENCY	GAIN (dB)	dBm OUT	Conv (mV/mW)	Vout (mV)
67.0	34.6	-2.97E+01	300	1.52
80.0	34.8	-2.95E+01	300	1.53
94.0	39.3	-2.50E+01	300	1.80
104.0	35.2	-2.91E+01	300	1.55
106.0	23.6	-4.07E+01	300	1.11
TOTAL				1.50

Table 20 simulated Voltage output for the configuration S220+S217 with 400 K noise temperature

The value read at Voltmeter is about 3mV when the RF (-40 dBm) is on (in CW mode).

The power reaching LNAs is roughly -60 dBm after the -20 dB attenuation, corresponding roughly to a broadband thermal noise of 10000 K.

10.16.1 Record data

Output Voltage shall be recorded.



The signal stability could be verified ?TBC

The external temperature shall be measured.

Take a picture of the experimental setup

10.16.2 OPTION 1

Scope: Measure the power entering detector diode from out of WR10 nominal bandwidth.

Wear the antistatic bracelet

Mount the filter between LNAs and diode.

Repeat the measurement with the filter mounted

In this case, the filter shall be characterized.

the filter was not tested;

its response was already known and has a bandwidth of about 10 GHz.

The diode output measured at voltmeter was 0.9 mV with RF OFF.

The expected (by calculation) response is higher (about 1.4 mV)

10.16.3 OPTION 2:

Scope: measure the total power by power meter

Wear the antistatic bracelet

Unplug detector filter + diode

measure power by Power Meter

Not performed



10.17 Test 10: Cascaded "S220" + "S217" LNAs + WR 10 Diode

Wear the antistatic bracelet

Assembly:

Bias LNAs to 0

Disconnect the VNA cable

Connect the WR 10 diode (without filter)

Bias the WR 10 diode; diode bias settings are reported **in TBC**

Connect the diode output to the Tester (TBC)

Biasing:

Bias LNAs to nominal values

The following table shall be filled:

Id Set (mA)
VD Set (V)
Vg1 measured (V)
Vg2 measured (V)
Ig1 measured (uA)
Ig2 measured (uA)

Table 21 LNA S220 + S217 settings

Not performed



10.17.1 Record data

Output Voltage shall be recorded.

The signal stability could be verified ?TBC

The external temperature shall be measured.

Take a picture of the experimental setup

10.17.2 OPTION 1

Scope: Measure the power entering detector diode from out of WR10 nominal bandwidth.

Wear the antistatic bracelet

Mount the filter between LNAs and diode.

Repeat the measurement with the filter mounted

In this case, the filter shall be characterized.

10.17.3 OPTION 2:

Scope: measure the total power by power meter

Wear the antistatic bracelet

Unplug detector filter + diode

measure power by Power Meter

11 Comparison with results from previous test campaign

S217 and S220 LNAs were already tested in 2013 using a Scalar Network Analyzer Agilent 8757D between 71 GHz and 111 GHz.

The power supply unit used was the same used in 2015 measurements.

Results are compared in the plots below, showing a general rough agreement between old and new data, also considering the different instrumental setup and techniques (Vector + gating correction against Scalar measurement)

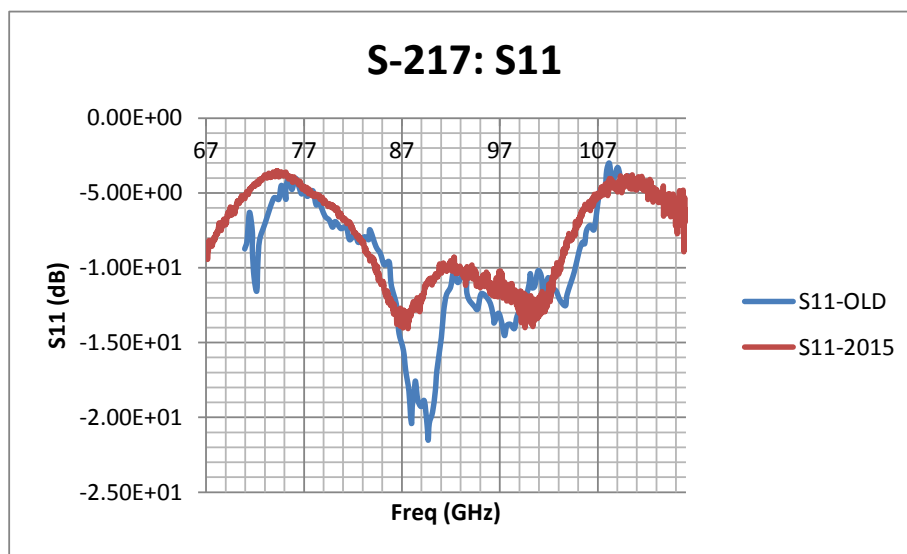

Figure 62 S217 LNA: S11 Comparison between 2013 (old) and 2015 data

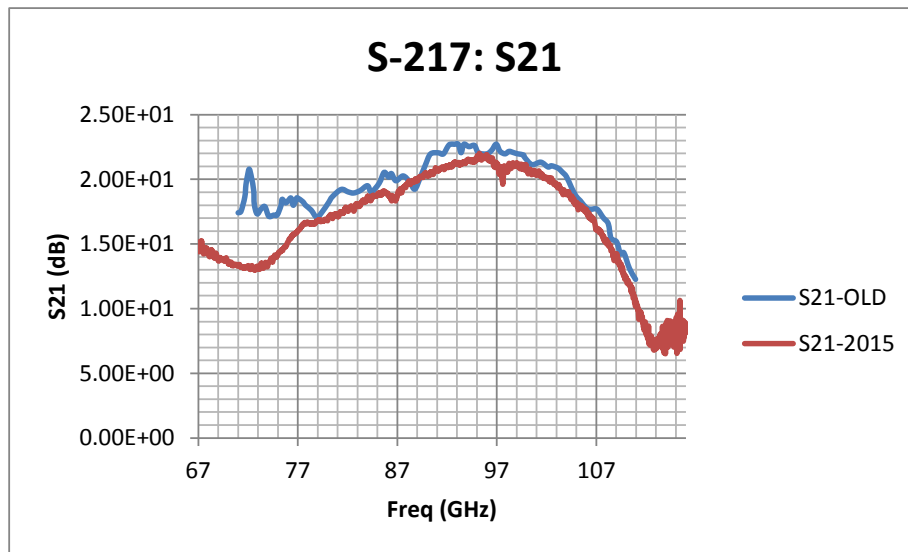

Figure 63 S217 LNA: S21 Comparison between 2013 (old) and 2015 data

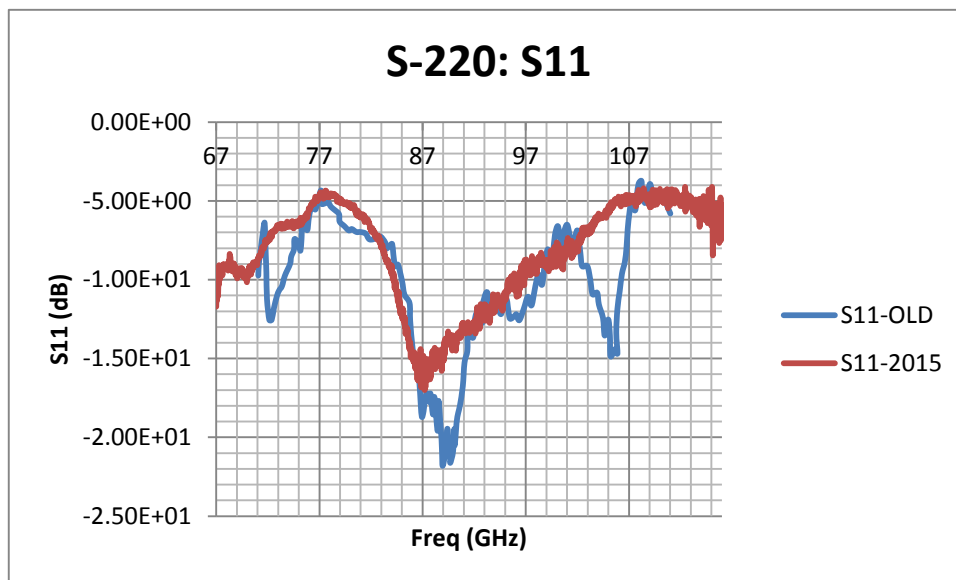

Figure 64 S220 LNA: S11 Comparison between 2013 (old) and 2015 data

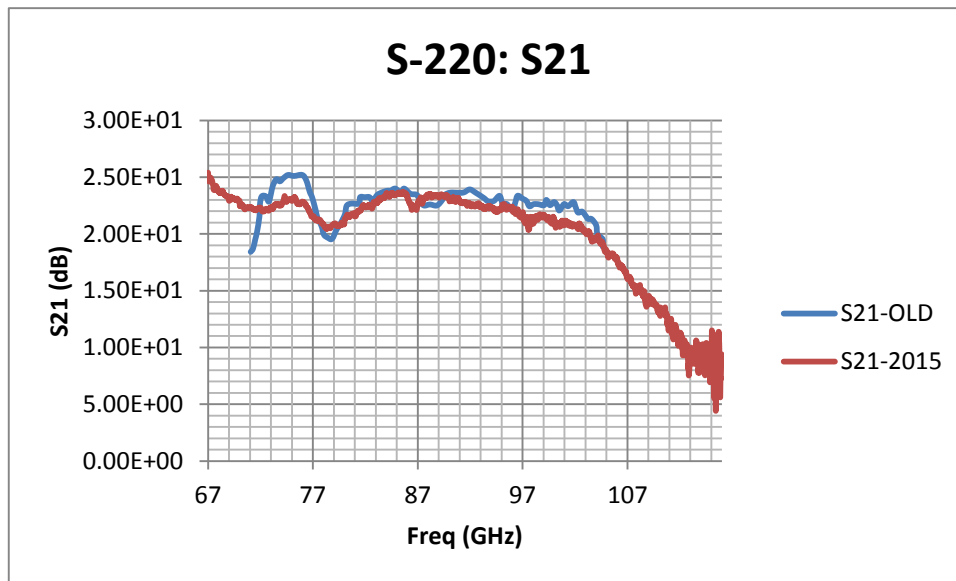

Figure 65 S220 LNA: S21 Comparison between 2013 (old) and 2015 data

12 Conclusions

The two LNAs named S-217 and S-220, in the INAF/IASF availability, were characterized (i) separately and (ii) cascaded.

A test bench based on a VNA covering the full B2+B3 range (67 GHz-116 GHz) was used to measure S parameters, with particular respect to Return Loss and Forward Gain .

Respectively to the individual characterization of each LNA:

- S220 Vg measured bias is sensibly higher than expected from specifications: 0.565 instead of about 350 mV. This is probably due to the power supply architecture (Vg is regulated to accordingly keep Id constant) and to the wiring scheme (Vg1 and Vg2 are shorted). Some tests have been made. Lowering Id to get the specified Vgs.
- Return Loss is almost independent from the VNA power available at input.
- Forward Gain depends on the VNA power available at input.

- Compression was verified in the input level range -33 dBm : -26 dBm. Both LNAs show compression over this range. It is possible that the fully uncompressed region lies below -33 dBm.
- - 33dBm is the lowest power considered to perform the TRL calibration with a good S/N and allowing to suppress unwanted features at the frequency range sides. For this reason, in the individual LNAs characterization , we avoided to push power below - 33 dBm.
- The two LNAs show RL curves different in shape but similar in the level (between - 4 dB and -16 dB).
- The two LNAs show different Gain curves over the full range.
- The two LNAs show different average Gain level over the lowest part (67 GHz : 94 GHz) of the frequency range, with a maximum difference of 10 dB at 67 GHz.
- Over the full range, the average gain is:
 - o S217 about 15 dB
 - o S220 about 20 dB

Respectively to the cascaded characterization of the two LNAs:

- Return Loss of the two cascaded configurations is always consistent with Return Loss of the first LNA.
- The total Gain shape is quite independent from the from the sequence of the two LNAs.
- The total Gain level changes by something between 1 dB and 3 dB, depending on the sequence of the paired LNAs.
- The two cascaded LNAs show compression due to the level of VNA RF signal available at input. Although a variable attenuator set to - 20 dB attenuation was interposed between the VNA output and the first LNA input, nevertheless attenuation was not enough to provide a signal having a level as low as to prevent compression. VNA RF output was lowered down to - 45 dBm, that was considered the lowest level feasible not inducing unacceptable features in the signal (especially at the band sides).
- A variable attenuator having the capability of at least -35 dB would be requested to perform a compression test, allowing to set the VNA RF input around -35 dB and to the enter the second LNA with a power lower than - 45 dB.
- The gain of the two cascaded configurations is:
 - o S217+S220: between 41.4 (94 GHz) and 23.6 (116 GHz)
 - o S220+S217: between 40.3 (94 GHz) and 22.2 (116 GHz)



Differences reduces when the RF power is increased from -45 dBm to -40 dBm, meaning that both configurations show compression.

Comparison with previous tests.

LNAs were already measured in 2013 using a Scalar Network Analyzer, over the reduced range 71 GHz : 111 GHz.

Comparison between individual LNAs measures is presented.

Both S11 and S21 measures are generally consistent between the two data sets, although they show non negligible punctual differences.