



Publication Year	2014
Acceptance in OA @INAF	2023-02-15T16:08:43Z
Title	iALMA Cryofacility dry-run specifications
Authors	VILLA, Fabrizio; TRENZI, LUCA
Handle	http://hdl.handle.net/20.500.12386/33500
Number	iALMA-TEC-SPE-IAB-001



Science and Technology in Italy
For the upgraded ALMA Observatory
- TECHNOLOGY DEVELOPMENT -

iALMA Cryofacility dry-run specifications

Document code: iALMA-TEC-SPE-IAB-001-A

Status: DRAFT

Date: 19/12/2014

Prepared by		
Name	Organization	Date
Luca Terenzi Fabrizio Villa	Uni E-campus INAF/IASF-Bologna INAF/IASF-Bologna	21/11/2014
Approved by		
Name	Organization	Date
Fabrizio Villa	INAF/IASF-Bologna	





1 Change Record

Version	Date	Affected sections	Reason
A	21/12/2014	All	First issue



3 Applicable and reference Documents



4 Table of content

1	Change Record	2
2	Distribution List	3
3	Applicable and reference Documents	4
4	Table of content	5
5	Introduction and Scope	6
6	Goal and Specification of the Dry-Run Test	7
7	Definition of the Cryofacility for the Dry-Run test.	7
7.1	Vacuum Vessel	8
7.2	Cryocoolers	10
7.2.1	4K cooler.....	10
7.2.2	20K cooler.....	11
7.3	Sensors and probes	11
7.4	Electrical Ground Support Equipment	13
7.4.1	Instrumentation to read sensors:.....	13
7.4.2	Computer Software and hardware.....	14
8	Connection of the coolers and pumps in the IASFBO crane room.....	17
8.1	Electrical connections	17
8.2	Water cooling connections	17

5 Introduction and Scope

The iALMA Cryofacility consist of a 2x1 meter Cryofacility that will permit to test the ALMA band 2+3 cartridge at operational conditions. The Cryofacility will be setup at INAF/IASF-Bologna.

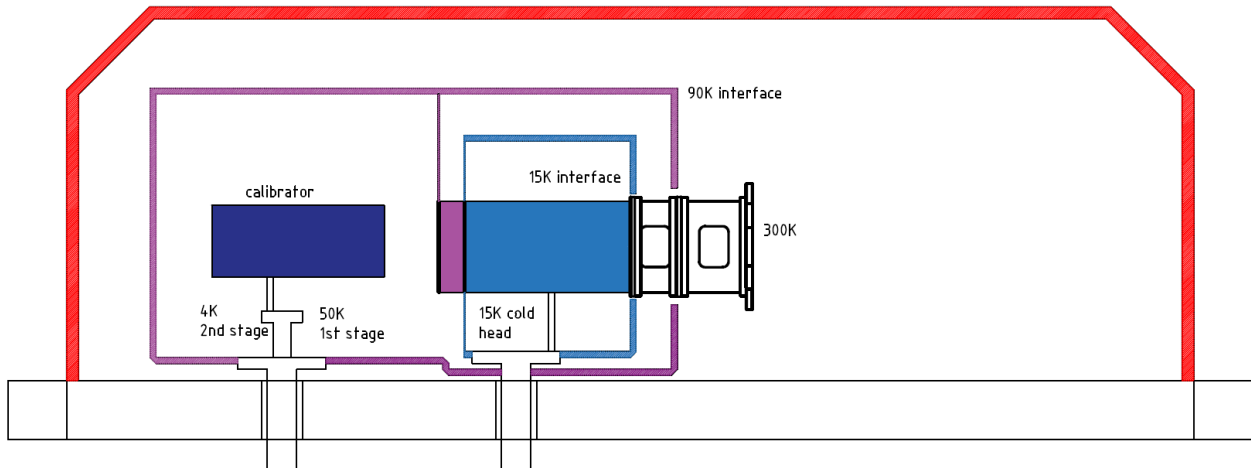

Figure 1: layout of the iALMA cryofacility @ IASFBO.

The Cryofacility is constituted by the following units:

- a Vacuum vessel
- Cryocoolers
- Vacuum pumps
- Sensors and probes
- Electrical Ground Support Equipment

A dry-run test is foreseen to check the vacuum/thermal and electrical functionalities of the Cryofacility.

Scope of this document is

- To define the specification and goal of the dry-run test of the Cryofacility
- To define the configuration of the Cryofacility for the dry-run test
- To define the interfaces between the various Cryofacility units specifically for the dry-run.

6 Goal and Specification of the Dry-Run Test

Scope of the dry-run is to check the functionality of the Cryofacility, the vacuum capabilities and the thermal interfaces.

The test configuration foresees two cooler, one at 4K and the other at 20K. Shields will be connected to intermediate stages of coolers if present. Hereafter the main thermal/vacuum specifications are listed.

The cryofacility shall reach an operative pressure of $< 10^{-4}$ mBar (TBC)

The cryofacility 4K flange will be operating at a temperature lower than 4.2 K with a maximum heat load of 1 W (parasitics included)

The cryofacility 20K flange will be operating at a temperature lower than 20.0 K with a maximum heat load of 3 W (parasitics included)

A heat load curve (Power vs Temperature) will be produced for the control stages at 4 K and 20 K. The procedure developed for the heat load curve measurement will be used periodically to check the facility performance stability.

7 Definition of the Cryofacility for the Dry-Run test.

The proposed configuration for the dry-run is reported in Figure 2. Three controlled temperature interfaces are located at 4K, 20K and 300K. Two shields are thermally connected to the intermediate temperature stages of the coolers providing a stable thermal environment surrounding the 4K and 20K interfaces. Temperature sensors will be connected to the shields to monitor the temperatures in different points. Description and specifications of the various components will be used are reported in the following subsections.

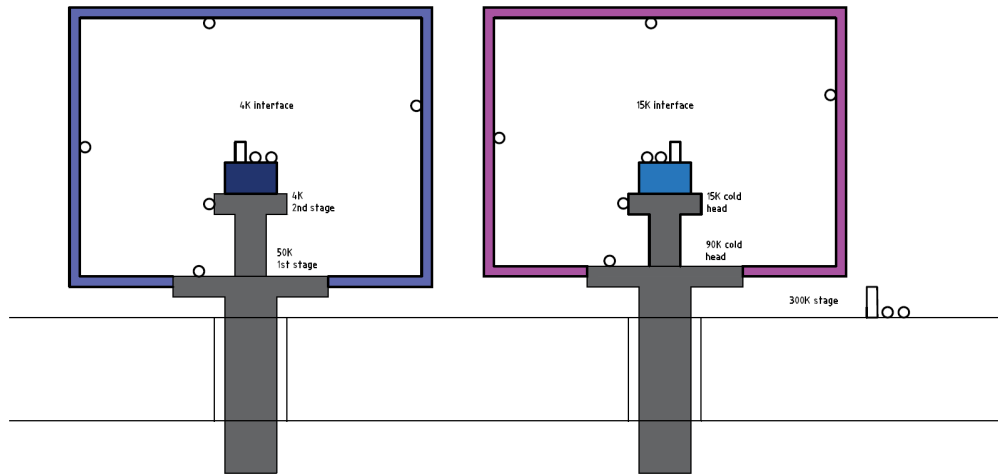

Figure 2: layout of the dry-run. A 90K shield and a 50K shield are foreseen.

7.1 Vacuum Vessel

The iALMA vacuum vessel is the same vessel as used for the Planck/LFI Radiometer Chain Assembly ground calibration (REFERENCE) as seen in Figure XX.

INSERT FIGURE HERE

Figure 3: picture of the vacuum vessel as used in Planck/LFI calibration campaign

In the main plate of the vessel, 16 holes are present to accommodate the coolers, the vacuum pumps and the feed-through for electrical connections. The holes map is reported in Figure 4.

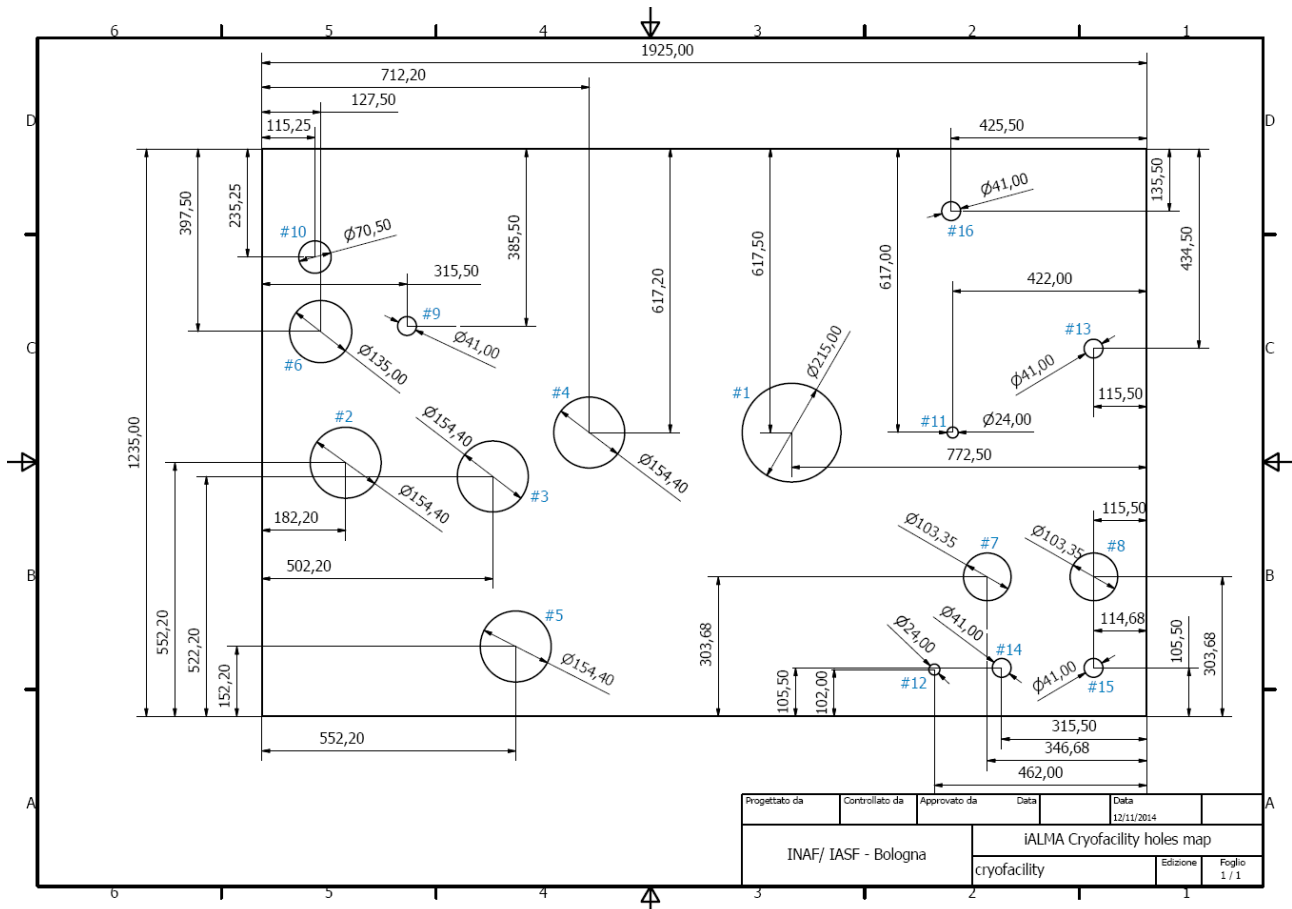

Figure 4: hole's map in the cryofacility main plate with dimensions and hole numbering.

7.2 Cryocoolers

The following cryocoolers will be used

7.2.1 4K cooler

The 4K cooler is the Sumitomo Heavy Industries Ltd, model SRDK-415D with the compressor unit F-50H. The main specifications are:

- Cooling Capacity 1st stage: 35 / 45 W at 50 K (50/60Hz)
- (Vertical Position) 2nd stage: 1.5 W at 4.2 K (50/60Hz)
- Lowest Temperature < 3.5 K -- for reference only
- Ambient Temperature Range 5 to 35 deg.C (28 to 35 deg.C with cooling capacity loss max. 5%)

The 4K cold head interface drawings are reported in Figure 5.

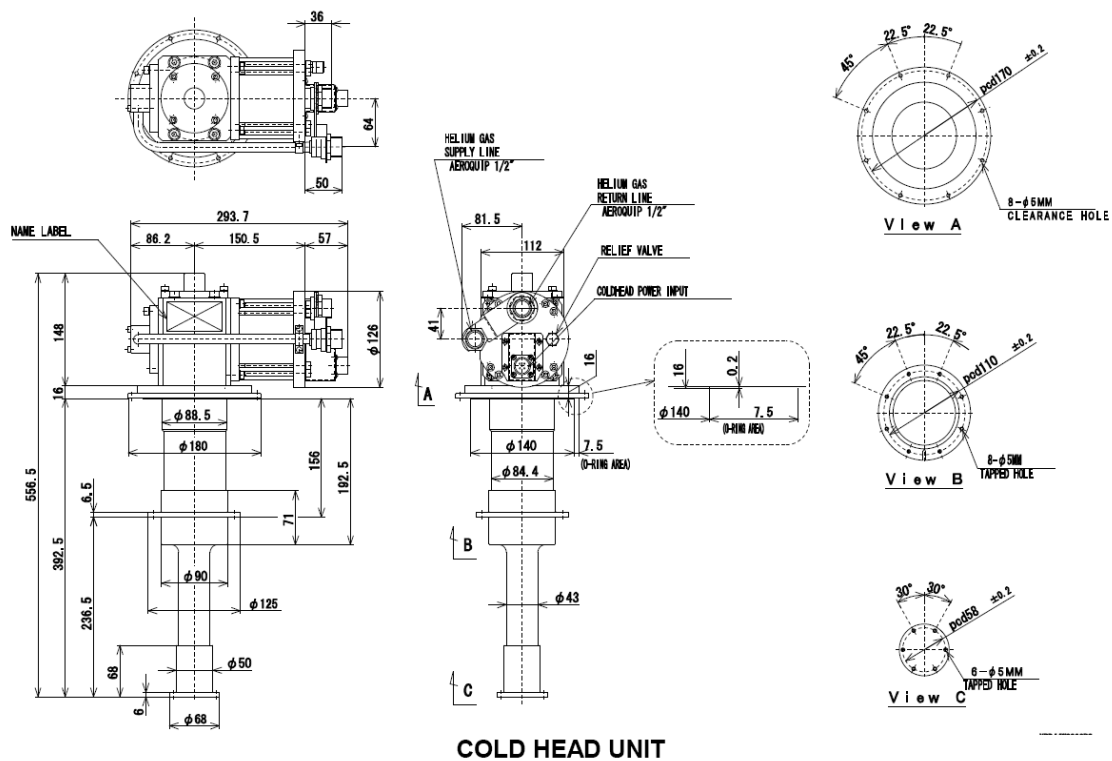

Figure 5: interface drawings of the 4K cold head unit

The custom adapter flange permits to connect the cooler to the Cryofacility. The drawing of the adapter is reported in **ANNEX (TBD)**

7.2.2 20K cooler

TBW

7.3 Sensors and probes

Temperature sensors are foreseen to regularly control the status of the cooler stages and interfaces. The Figure 6 reports a guideline of the location of the temperature sensors and heater that would be used during the dry-run.

The temperature sensors shall permit to monitor the temperature with the resolution of 1mK (TBC) and an accuracy better than 0.1 K in the whole operating temperature range

The temperature sensors shall permit to monitor the temperature with an accuracy better than 0.1 K in the whole operating temperature range

Heaters will be used to control the temperature of various stages with the following specifications:

The 4K control stage will be set at a temperature of 4.50 ± 0.01 K

The 20K control stage will be set at a temperature of 20.00 ± 0.01 K

The stability of both 4K and 20 K control stages will be better than 5 mK/hour (TBC).

The 300 K control stage stability will be better than 0.1 K / day

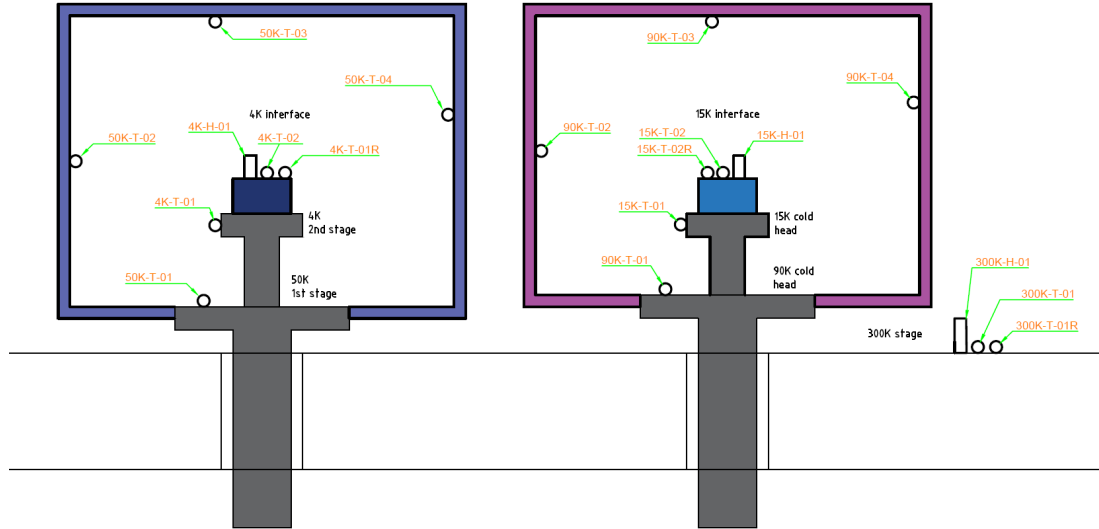

Figure 6: location of the sensors for the dry-run

The sensors type is specified in Table 1:

Table 1: Temperature Sensors

ID	Location	Type	Instrument	note
50K-T-01	50K flange	DT670 CU	Instr_5	
50K-T-02	50K shield	DT670 CU	Instr_5	
50K-T-03	50K shield	DT670 CU	Instr_5	
50K-T-04	50K shield	DT670 CU	Instr_5	
90K-T-01	90K flange	DT670 CU	Instr_5	
90K-T-02	90K shield	DT670 CU	Instr_5	
90K-T-03	90K shield	DT670 CU	Instr_5	
90K-T-04	90K shield	DT670 CU	Instr_5	
4K-T-01	4K flange	GR200 AA	Instr_2 - Ch. MON	
4K-T-02	4K control	GR200 AA	Instr_3 - Ch. CTRL	
4K-T-02R	4K control	GR200 CU	Instr_3 - Ch. CTRL	Redundancy
15K-T-01	15K flange	CX1050 AA	Instr_2 - Ch. MON	
15K-T-02	15K control	CX1050 CU	Instr_2 - Ch. CTRL	
15K-T-02R	15K control	CX1050 AA	Instr_2 - Ch. CTRL	Redundancy
300K-T-01	300K control	DT670 CU	Instr_4 - Ch. CTRL	

ID	Location	Type	Instrument	note
300K-T-01R	300K control	DT670 CU	Instr_4 - Ch. CTRL	

The heaters are specified in Table 2.

Table 2: heaters

ID	Location	Type	Instrument	note
4K-H-01	4K control	Minco heater	Instr_3 - CTRL A	
15K-H-01	15K control	Minco heater	Instr_2 - CTRL A	
300K-H-01	300K control	Minco heater	Instr_4 - CTRL A	

In addition, a pressure sensor will be located to control the pressure inside the chamber.

7.4 Electrical Ground Support Equipment

The EGSE permits to control and monitor the Cryofacility during operation. It will be constituted by

- Instrumentation to read the sensors and drive the heaters for control
- Computer
- Software
- Cables

7.4.1 Instrumentation to read sensors:

The instrumentation shall permit to monitor and control sensors and heaters with a time rate of 1 second or less

The instrumentation shall permit to monitor the temperatures with a synchronization time less or equal 1 sec.

The following instrumentation will be available at IASFBO:

Table 3: Instrumentation

ID	Model	Monitors/Controls
Instr_2	Lakeshore LS340	4/2
Instr_3	Lakeshore LS340	4/2
Instr_4	Lakeshore LS331	2/2
Instr_5	Lakeshore LS218	8/0

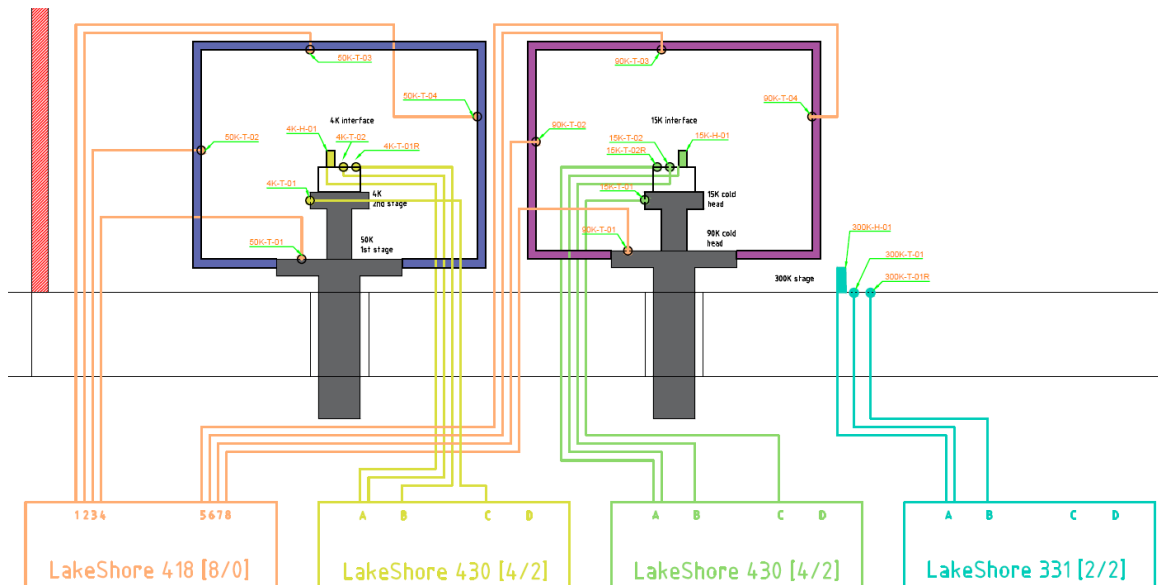

Figure 7: connections scheme between sensors, heaters and instrumentation. For each instrument, the total number of channels and controls is displayed (for instance [4/2] means 4 channels and 2 controls).

7.4.2 Computer Software and hardware

A dedicated computer shall permit to run the software to acquire, store and analyse the data read by the instrumentation as listed in Table 3.

It is warmly suggested to implement a modular architecture software for future instrumentation upgrades (number and models).

The software shall satisfy the following specifications:



The software shall permit to interface the computer with the instrumentation via IEEE488 interface

The software shall permit to interface the computer with the instrumentation via RS232 interface (1 port)

The suggested software is LABVIEW that permit to use dedicated drivers to read and commanding the Lakeshore instrumentation.

The software shall permit to read all the temperature sensors with a sampling rate less or equal to 1 sec

The software shall permit to read all the temperature sensors with a synchronization less or equal to 1 sec

It is not required that all the read temperatures are (perfectly) synchronized in time. However, the need is that, every second, all the temperature shall be read and associated with the right time.

The guideline is to acquire all the data at the maximum rate permitted by the available software and instrumentation.

The software shall provide the possibility of a quick look monitoring for all the sensors

The software shall provide a control panel to command the instrumentation both in real time and in a programmable way.

The proposed solution is to have the following layout on computer screen:

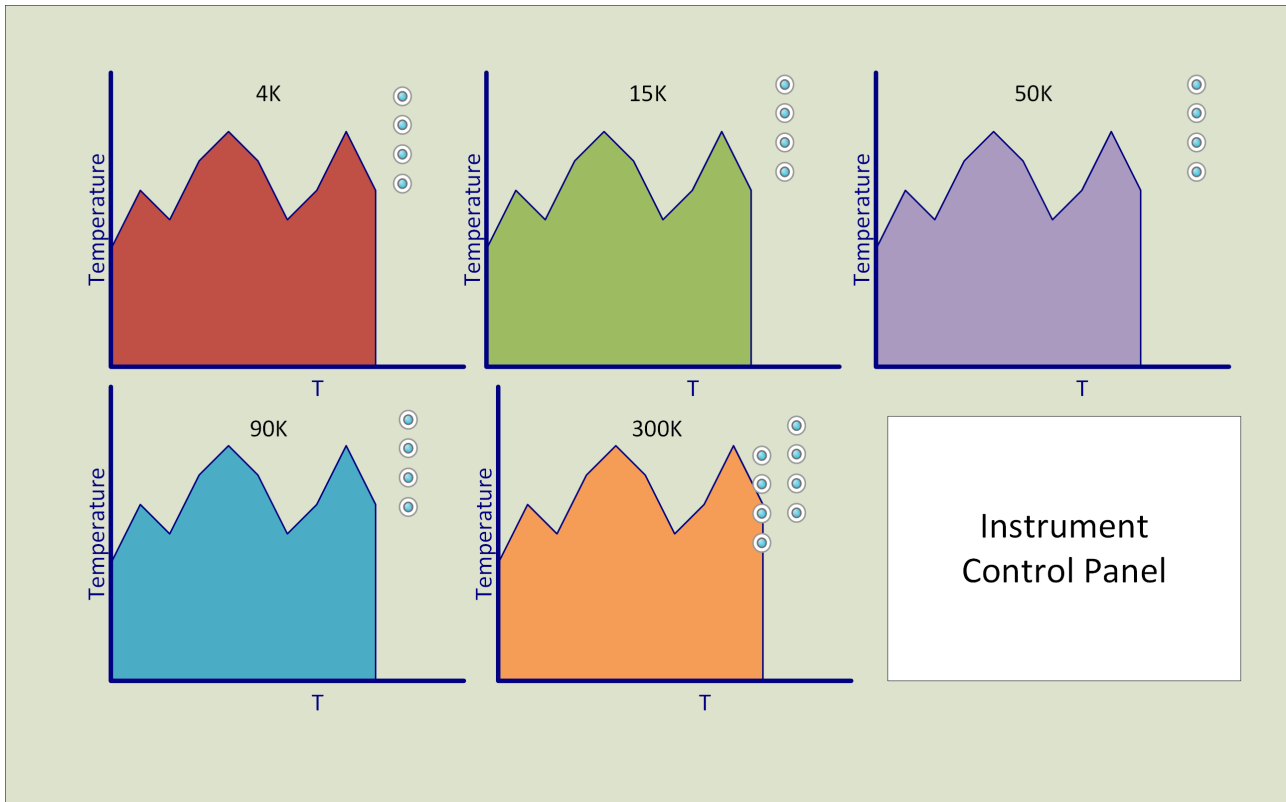

Figure 8: Example of the layout on the screen for quick look analysis and instrument commanding.

For each thermal interface (4K, 15K, 50K, 90K, and 300K), a real-time graphic representation will permit to see temperature trend. It should be possible to select the appropriate temperature sensor to display. A control panel box should permit to select the Lakeshore instrument and command it in real time or programming the control loop (i.e. select the control loop and its PID parameters, select the sampling rate to save data onto a file, filename, directories, etc...).

The software shall permit to read, store and backup all the data with a selectable sampling rate

The implementation should permit to select the acquisition rate and data storage rate among different values. For instance 1sec, 5sec, 10sec, 30sec, 60sec (TBC). This is useful in case of long acquisition times.

The computer and operating system shall satisfy the following requirements:

- Operating system: Windows 7 PRO (TBC) + Virtual machines



- Storage capability to store data for TBD days continuously
- Internet connection
- Backup unit (TBC)

8 Connection of the coolers and pumps in the IASFBO crane room

8.1 Electrical connections

TBD

8.2 Water cooling connections

TBD